

PRO-FORM

760 EKG

Model No. 831.291670

Serial No. _____

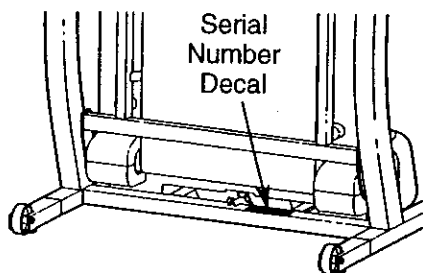

EXERCISE
EQUIPMENT

QUESTIONS

HELPLINE!

1-800-736-6879

SEARS, ROEBUCK AND CO.
HOFFMAN ESTATES, IL 60179

CAUTION

Read all precautions and instructions in this manual before using this equipment. Save this manual for future reference.

USER'S MANUAL

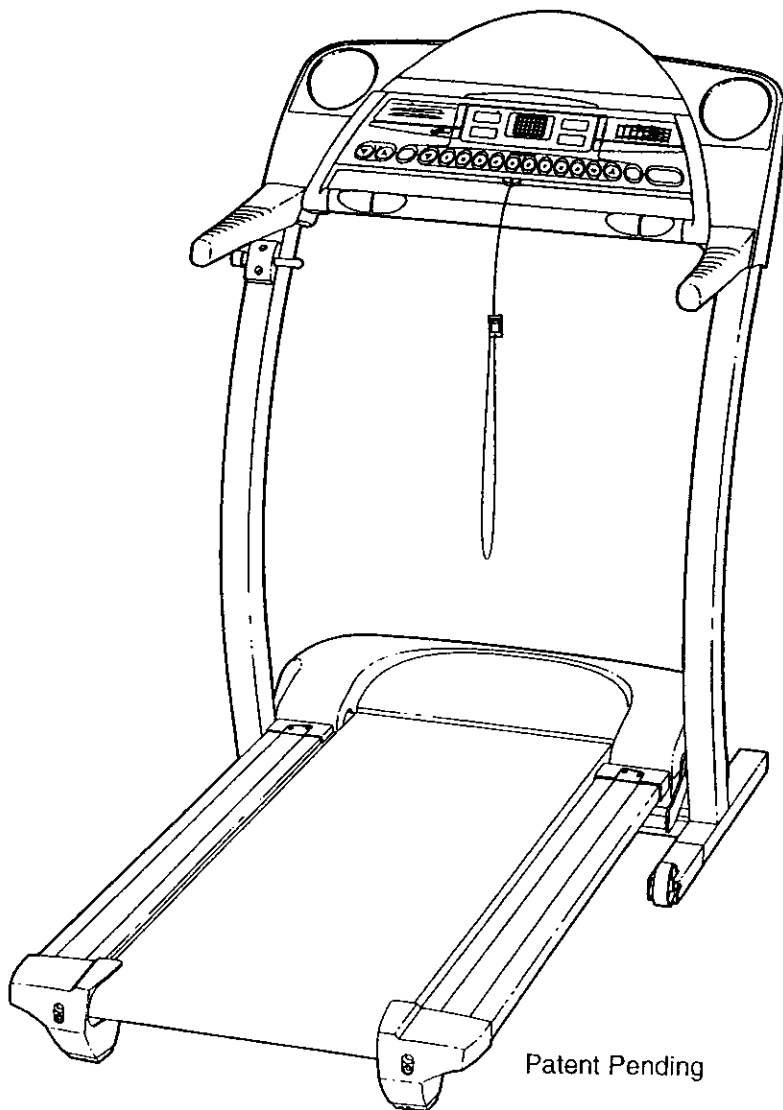

Visit our website at

www.proform.com

*new products, prizes,
fitness tips, and much more!*

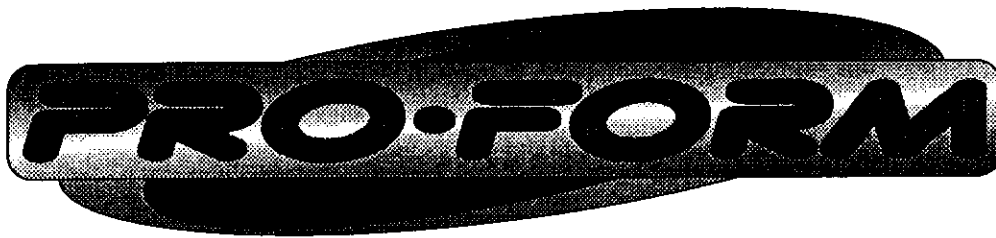

**760
EKG**

TABLE OF CONTENTS

IMPORTANT PRECAUTIONS	3
BEFORE YOU BEGIN	5
ASSEMBLY	6
OPERATION AND ADJUSTMENT	8
HOW TO FOLD AND MOVE THE TREADMILL	21
TROUBLE-SHOOTING	23
CONDITIONING GUIDELINES	25
ORDERING REPLACEMENT PARTS	Back Cover
FULL 90-DAY WARRANTY	Back Cover

Note: An EXPLODED DRAWING and a PART LIST are attached in the center of this manual.

IMPORTANT PRECAUTIONS

⚠ WARNING: To reduce the risk of burns, fire, electric shock, or injury to persons, read the following important precautions and information before operating the treadmill.

1. It is the responsibility of the owner to ensure that all users of this treadmill are adequately informed of all warnings and precautions.
2. Use the treadmill only as described.
3. Place the treadmill on a level surface, with at least eight feet of clearance behind it. Do not place the treadmill on any surface that blocks air openings. To protect the floor or carpet from damage, place a mat under the treadmill.
4. Keep the treadmill indoors, away from moisture and dust. Do not put the treadmill in a garage or covered patio, or near water.
5. Do not operate the treadmill where aerosol products are used or where oxygen is being administered.
6. Keep children under the age of 12 and pets away from the treadmill at all times.
7. The treadmill should not be used by persons weighing more than 250 pounds.
8. Never allow more than one person on the treadmill at a time.
9. Wear appropriate exercise clothing when using the treadmill. Do not wear loose clothing that could become caught in the treadmill. Athletic support clothes are recommended for both men and women. *Always wear athletic shoes. Never use the treadmill with bare feet, wearing only stockings, or in sandals.*
10. When connecting the power cord (see page 8), plug the power cord into a surge suppressor (not included) and plug the surge suppressor into a grounded circuit capable of carrying 15 or more amps. No other appliance should be on the same circuit. Do not use an extension cord.
11. Use only a single-outlet surge suppressor that is UL 1449 listed as a transient voltage surge suppressor (TVSS). The surge suppressor must have a UL suppressed voltage rating of 400 volts or less and a minimum surge dissipation of 450 joules. The surge suppressor must be electrically rated for 120 volts AC and 15 amps. To purchase a surge suppressor, see your local SEARS or call 1-800-366-7278 and order part number 146148.
12. Keep the power cord and the surge suppressor away from heated surfaces.
13. Never move the walking belt while the power is turned off. Do not operate the treadmill if the power cord or plug is damaged, or if the treadmill is not working properly. (See **BEFORE YOU BEGIN** on page 5 if the treadmill is not working properly.)
14. Never start the treadmill while you are standing on the walking belt. Always hold the handrails while using the treadmill.
15. The treadmill is capable of high speeds. Adjust the speed in small increments to avoid sudden jumps in speed.
16. The pulse sensor is not a medical device. Various factors, including the user's movement, may affect the accuracy of heart rate readings. The pulse sensor is intended only as an exercise aid in determining heart rate trends in general.
17. Never leave the treadmill unattended while it is running. Always remove the key, unplug the power cord, and move the on/off switch to the off position when the treadmill is not in use. (See the drawing on page 5 for the location of the on/off switch.)
18. Do not attempt to raise, lower, or move the treadmill until it is properly assembled. (See **ASSEMBLY** on page 6, and **HOW TO FOLD AND MOVE THE TREADMILL** on page 21.) You must be able to safely lift 45 pounds (20 kg) in order to raise, lower, or move the treadmill.
19. Do not change the incline of the treadmill by placing objects under the treadmill.
20. When folding or moving the treadmill, make sure that the storage latch is fully closed.

21. When using iFIT.com CDs and videos, an electronic "chirping" sound will alert you when the speed and/or incline of the treadmill is about to change. Always listen for the "chirp" and be prepared for speed and/or incline changes. In some instances, the speed and/or incline may change before the personal trainer describes the change.

22. When using iFIT.com CDs and videos, you can manually override the speed and incline settings at any time by pressing the speed and incline buttons. However, when the next "chirp" is heard, the speed and/or incline will change to the next settings of the CD or video program.

23. Always remove iFIT.com CDs and videos from your CD player or VCR when you are not using them.

24. Inspect and tighten all parts of the treadmill regularly.

25. Never insert or drop any object into any opening.

26. **DANGER:** Always unplug the power cord immediately after use, before cleaning the treadmill, and before performing the maintenance and adjustment procedures described in this manual. Never remove the motor hood unless instructed to do so by an authorized service representative. Servicing other than the procedures in this manual should be performed by an authorized service representative only.

27. This treadmill is intended for in-home use only. Do not use this treadmill in any commercial, rental, or institutional setting.

WARNING: Before beginning this or any exercise program, consult your physician. This is especially important for persons over the age of 35 or persons with pre-existing health problems. Read all instructions before using. SEARS assumes no responsibility for personal injury or property damage sustained by or through the use of this product.



SAVE THESE INSTRUCTIONS

The decals shown have been placed on your treadmill. If a decal is missing, or if it is not legible, please call our toll-free HELPLINE to order a free replacement decal (see the front cover of this manual). Apply the decal in the location shown.

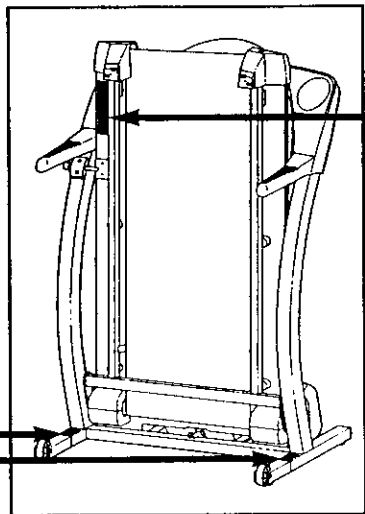
CAUTION
KEEP HANDS AND FEET AWAY FROM THIS AREA WHILE THE TREADMILL IS IN OPERATION.



WARNING:
Protect yourself and others from risk of serious injury. Read the user's manual and:

-  Stand only on the side rails when starting or stopping treadmill.
- Change speed in small increments.
- Hold handrails to prevent falling, and always wear the safety clip while operating treadmill.
- Stop if you feel faint, dizzy, or short of breath.
- Fully engage storage latch before treadmill is moved or stored.
- Reduce incline to its lowest level before folding treadmill into storage position.
-  Never allow children on or around treadmill.
- Remove key when not in use.
-  Keep clothing, fingers, and hair away from moving belt.
- Never try to adjust or fix the belt while it is moving.
- Always wear athletic shoes while operating treadmill.

BEFORE YOU BEGIN

Thank you for selecting the revolutionary PROFORM® 760 EKG treadmill. The 760 EKG treadmill combines advanced technology with innovative design to help you get the most from your exercise program in the convenience and privacy of your home. And when you're not exercising, the unique 760 EKG can be folded up, requiring less than half the floor space of other treadmills.

please call our toll-free HELPLINE at 1-800-736-6879, Monday through Saturday, 7 a.m. until 7 p.m. Central Time (excluding holidays). To help us assist you, please note the product model number and serial number before calling. The model number of the treadmill is 831.291670. The serial number can be found on a decal attached to the treadmill (see the front cover of this manual for the location).

For your benefit, read this manual carefully before using the treadmill. If you have additional questions,

Before reading further, please review the drawing below and familiarize yourself with the labeled parts.

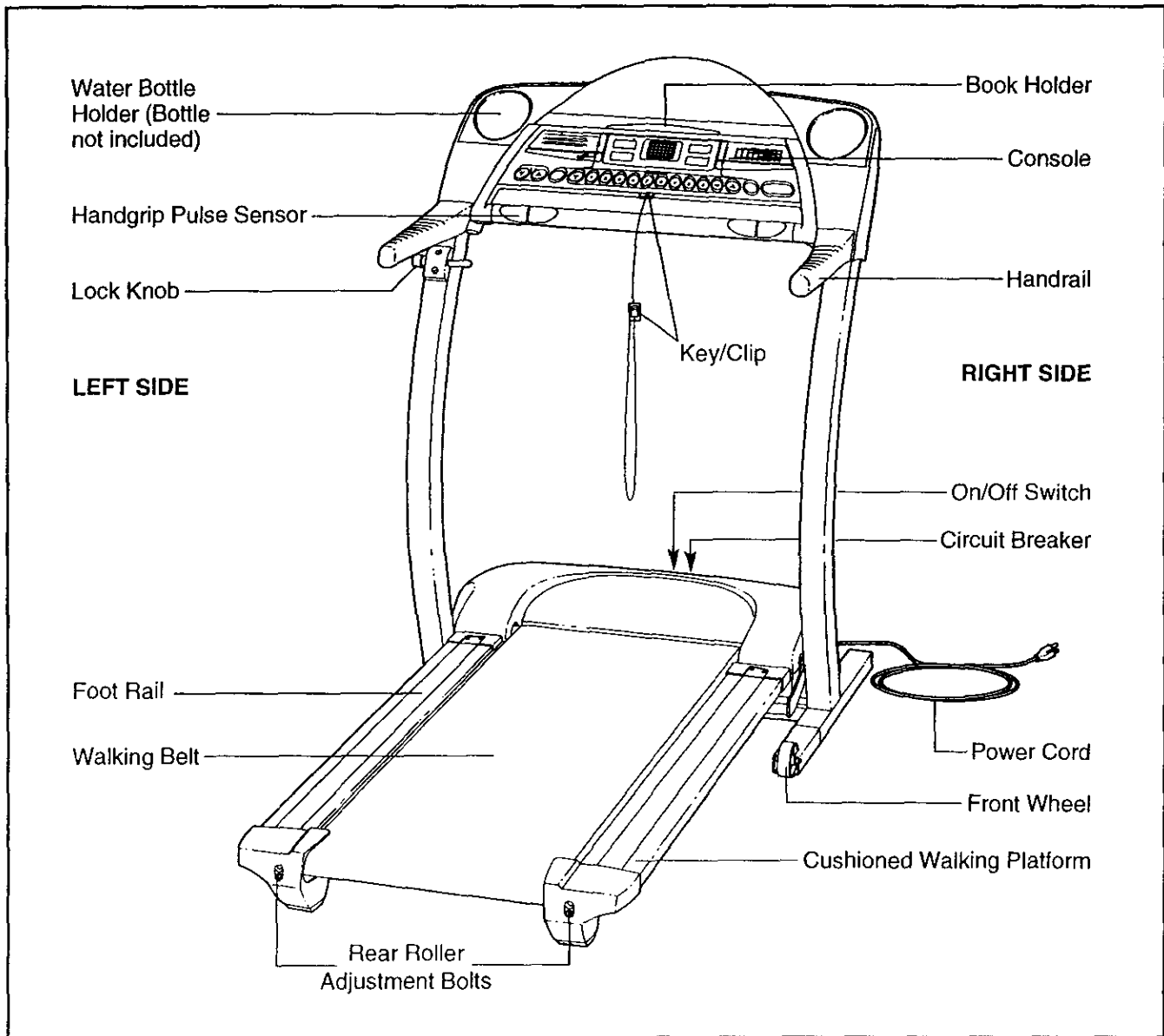

ASSEMBLY

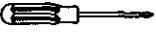
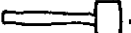
Assembly requires two people. Set the treadmill in a cleared area and remove all packing materials. Do not dispose of the packing materials until assembly is completed. **Assembly requires your own Phillips screwdriver**  **and rubber mallet** .

Note: The underside of the treadmill walking belt is coated with high-performance lubricant. During shipping, a small amount of lubricant may be transferred to the top of the walking belt or the shipping carton. This is a normal condition and does not affect treadmill performance. If there is lubricant on top of the walking belt, simply wipe off the lubricant with a soft cloth and a mild, non-abrasive cleaner.

1. With the help of a second person, carefully raise the treadmill to the upright position as shown.

Insert one of the Extension Legs (55) into the treadmill as shown. Make sure that the Extension Leg is turned so the Base Pad (44) is on the bottom. If necessary, tip the Uprights (64) forward as you insert the Extension Leg.

Insert the other Extension Leg (not shown) in the same way.

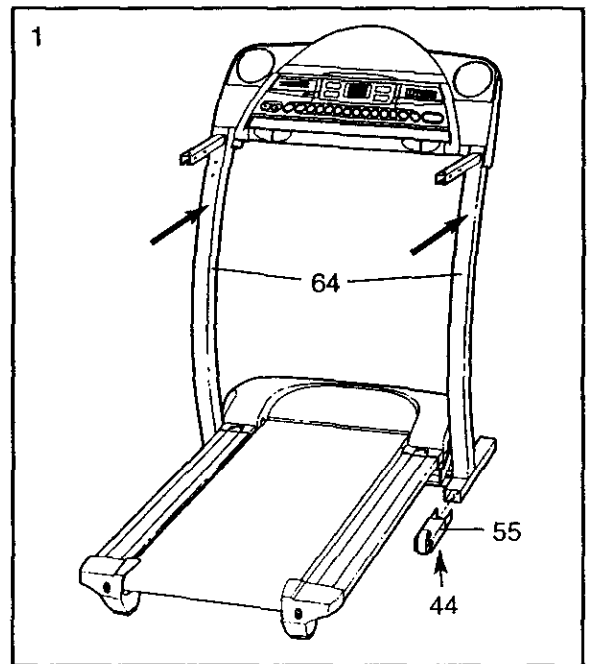

2. With the help of a second person, carefully lower the Uprights (64) as shown. Note: It may be helpful to place your foot on a Wheel (58) as you tip the Uprights. **Make sure that the Extension Legs (55) remain in the Uprights.**

Attach each Extension Leg (55) with two Extension Screws (35) as shown.

Note: One replacement Base Pad (44) may be included. If a Base Pad becomes worn and needs to be replaced, use the replacement Base Pad.

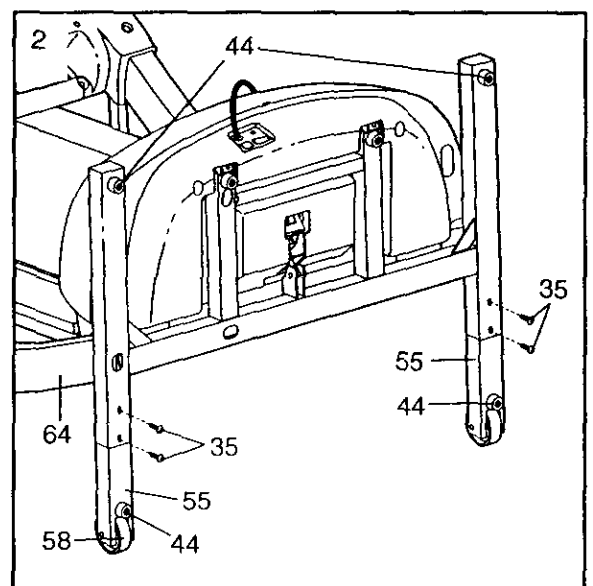

3. With the help of a second person, carefully tip the Uprights (64) back to the vertical position.

Attach the Latch Assembly (32) to the left Upright (64) with two Extension Screws (35).

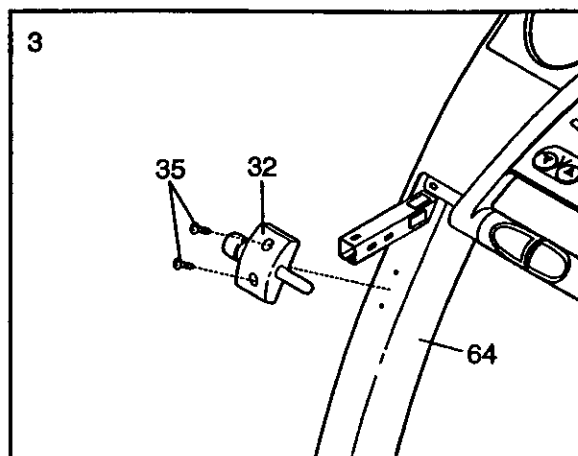

4. Turn the Handrail Extension (34) so that the two larger holes are on the bottom as shown. Insert the Handrail Extension as far as possible into the post on the left Upright (64). If necessary, tap the Handrail Extension with a rubber mallet to fully insert it. Next, attach the Handrail Extension by tightening three Extension Screws (35) into the indicated holes.

Identify the Left Foam Grip (31) (see the inset drawing). Remove the paper from the two indicated pieces of Foam Tape (82). Apply a small amount of water to the pieces of Foam Tape. Slide the Left Foam Grip as far as possible onto the post on the left Upright (64). **Note: It may be helpful to lubricate the Handrail Extension (34) with soapy water.** Press two Plastic Fasteners (9) into the Foam Grip and the Handrail Extension (34). If necessary, use a blunt object to press in the Fasteners.

Attach the other Handrail Extension (not shown) and the Right Foam Grip (43) as described above. Note: Make sure that the Extension Screws (35) are attached on the outside of the post as shown.

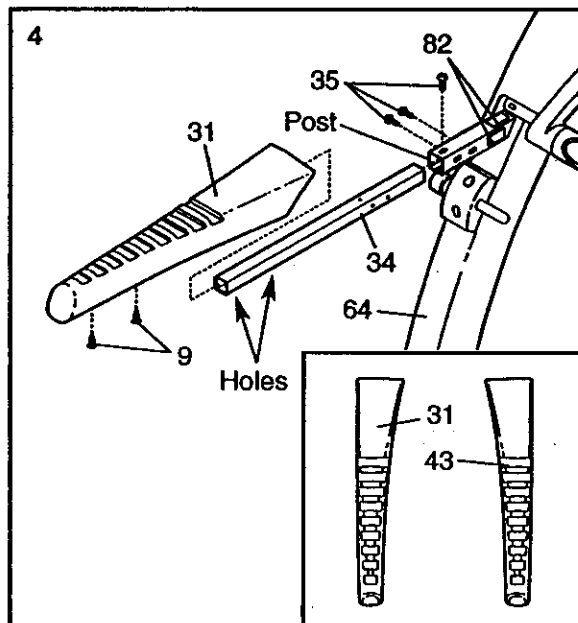

5. **Make sure that all parts are tightened before you use the treadmill.** Keep the included allen wrench in a secure place; the allen wrench is used to adjust the walking belt (see page 24). To protect the floor or carpet from damage, place a mat under the treadmill.

OPERATION AND ADJUSTMENT

THE PERFORMANT LUBE™ WALKING BELT

Your treadmill features a walking belt coated with PERFORMANT LUBE™, a high-performance lubricant. **IMPORTANT: Never apply silicone spray or other substances to the walking belt or the walking platform. Such substances will deteriorate the walking belt and cause excessive wear.**

HOW TO PLUG IN THE POWER CORD

⚠ DANGER: Improper connection of the equipment-grounding conductor can result in an increased risk of electric shock. Check with a qualified electrician or serviceman if you are in doubt as to whether the product is properly grounded. Do not modify the plug provided with the product—if it will not fit the outlet, have a proper outlet installed by a qualified electrician.

Your treadmill, like any other type of sophisticated electronic equipment, can be seriously damaged by sudden voltage changes in your home's power. Voltage surges, spikes, and noise interference can result from weather conditions or from other appliances being turned on or off. **To decrease the possibility of your treadmill being damaged, always use a surge suppressor with your treadmill (see drawing 1 at the right).**

To purchase a surge suppressor, see your local SEARS or call toll-free 1-800-366-7278 and order part number 146148. Use only a single-outlet surge suppressor that is UL 1449 listed as a transient voltage surge suppressor (TVSS). The surge suppressor must have a UL suppressed voltage rating of 400 volts or less and a minimum surge dissipation of 450 joules. The surge suppressor must be electrically rated for 120 volts AC and 15 amps.

This product must be grounded. If it should malfunction or break down, grounding provides a path of least resistance for electric current to reduce the risk of electric shock. This product is equipped with a cord having an equipment-grounding conductor and a grounding plug. **Plug the power cord into a surge suppressor, and plug the surge suppressor into an appropriate**

outlet that is properly installed and grounded in accordance with all local codes and ordinances. Important: The treadmill is not compatible with GFCI-equipped outlets.

This product is for use on a nominal 120-volt circuit, and has a grounding plug that looks like the plug illustrated in drawing 1 below. A temporary adapter that looks like the adapter illustrated in drawing 2 may be used to connect the surge suppressor to a 2-pole receptacle as shown in drawing 2 if a properly grounded outlet is not available.

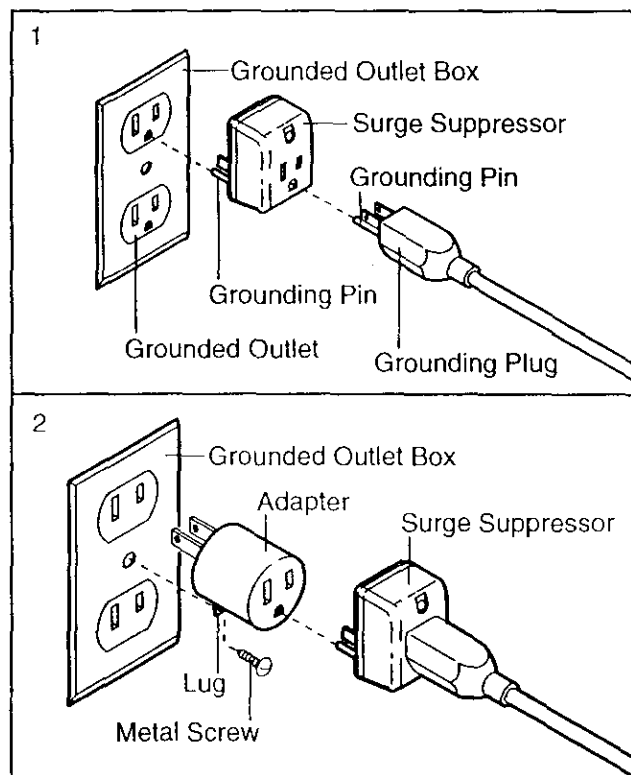

The temporary adapter should be used only until a properly grounded outlet (see drawing 1) can be installed by a qualified electrician.

The green-colored rigid ear, lug, or the like extending from the adapter must be connected to a permanent ground such as a properly grounded outlet box cover. Whenever the adapter is used it must be held in place by a metal screw. **Some 2-pole receptacle outlet box covers are not grounded. Contact a qualified electrician to determine if the outlet box cover is grounded before using an adapter.**

CONSOLE DIAGRAM

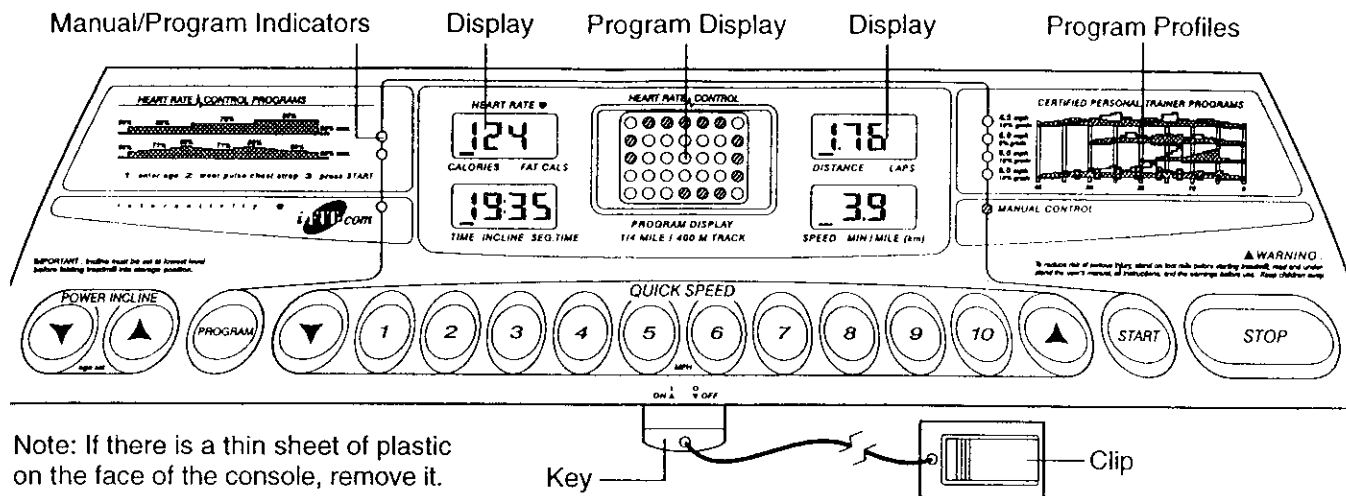

Note: If there is a thin sheet of plastic on the face of the console, remove it.

CAUTION: Before operating the console, read the following precautions.

- Do not stand on the walking belt when turning on the power.
- Always wear the clip (see the drawing above) while operating the treadmill.
- Adjust the speed in small increments to avoid sudden jumps in speed.
- To reduce the possibility of electric shock, keep the console dry. Avoid spilling liquids on the console and place only a sealed water bottle in the water bottle holder.

FEATURES OF THE CONSOLE

The advanced console offers an impressive array of features to help you get the most from your exercise. When the manual mode of the console is selected, the speed and incline of the treadmill can be changed with a touch of a button. As you exercise, the console will display continuous exercise feedback. You can even measure your heart rate using the built-in handgrip pulse sensor. Note: See page 20 for information about an optional chest pulse sensor.

Four certified personal trainer programs are also offered. Each program automatically controls the speed and incline of the treadmill to give you an effective workout. Two heart rate programs are also featured. Each program controls the speed and incline of the treadmill to keep your heart rate near a target level during your workouts.

The console also features new iFIT.com interactive technology. iFIT.com technology is like having a personal trainer right in your home. Using the included audio cable, you can connect the treadmill to your home stereo, portable stereo, or computer and play special iFIT.com CD programs (one free iFIT.com CD is included; others are available separately). iFIT.com CD programs automatically control the speed and incline of the treadmill as a personal trainer guides you through every step of your workout. High-energy music provides added motivation. Each CD features two programs designed by certified personal trainers.

In addition, you can connect the treadmill to your VCR and TV and play iFIT.com video programs (videocassettes are available separately). Video programs offer the same benefits as iFIT.com CD programs, but add the excitement of working out with a class and an instructor—the hottest new trend at health clubs.

With the treadmill connected to your computer, you can also go to our Web site at www.iFIT.com and access basic programs, audio programs, and video programs directly from the internet. Additional options, such as on-line competitions, personal training sessions via the internet, and online tracking of your workout history are soon to be available. See www.iFIT.com for details.

To purchase iFIT.com CDs or videocassettes, call toll-free 1-800-735-0768.

To use the manual mode of the console, follow the steps beginning on page 10. **To use a personal trainer program**, see page 12. **To use a heart rate program**, see page 13. **To use an iFIT.com CD or video program**, refer to page 17. **To use an iFIT.com program directly from our Web site**, see page 19.

HOW TO TURN ON THE POWER

1 Plug in the power cord (see page 8).

2 Locate the on/off switch near the power cord. Move the on/off switch to the on position.

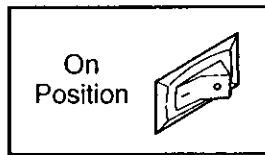

3 Stand on the foot rails of the treadmill. Find the clip attached to the key (see the drawing on page 9) and slide the clip onto the waistband of your clothes. Next, insert the key into the console. After a moment, the displays and various indicators will light. **Test the clip by carefully taking a few steps backward until the key is pulled from the console. If the key is not pulled from the console, adjust the position of the clip.**

HOW TO USE THE MANUAL MODE

1 Insert the key fully into the console.

See HOW TO TURN ON THE POWER above.

2 Select the manual mode.

When the key is inserted, the manual mode will be selected and the Manual Control indicator will light. If a program has been selected, press the Program button repeatedly to reselect the manual mode.

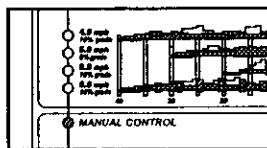

3 Press the Start button or the Speed Δ button to start the walking belt.

A moment after the button is pressed, the walking belt will begin to move at 1 mph. Hold the handrails and begin walking. As you exercise, change the speed of the walking belt as desired by pressing the Speed ∇ and Δ buttons.

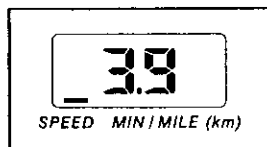

Each time a button is pressed, the speed setting will change by 0.1 mph; if a button is held down, the speed setting will change in increments of 0.5 mph. To change the speed setting quickly, press the Quick Speed buttons. **Note: The console can display speed and distance in either miles or kilometers. For simplicity, all instructions in this section refer to miles.**

During the first few minutes of using the treadmill, inspect the alignment of the walking belt, and align the walking belt if necessary (see page 24).

To stop the walking belt, press the Stop button. The Time/Incline/Segment Time display will begin to flash. To restart the walking belt, press the Start button or the Speed Δ button.

4 Change the incline of the treadmill as desired.

To change the incline of the treadmill, press the Incline buttons. Each time a button is pressed, the incline will change by 0.5%. Note: After the buttons are pressed, it may take a moment for the treadmill to reach the selected incline setting.

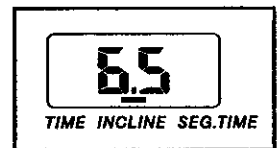

5 Follow your progress with the LED track and the displays.

The LED Track—When the manual mode or the iFIT.com mode is selected, the program display will show an LED track representing 1/4 mile. As you exercise, the indicators around the track will light in sequence until you have completed 1/4 mile. A new lap will then begin.

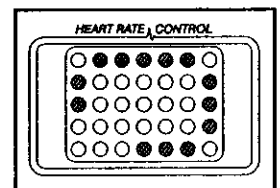

Calories/Fat Calories/Heart Rate display—

This display shows the approximate numbers of calories and fat calories you have burned (see FAT BURNING on page 25). The display will change from one number to the other every few seconds, as shown by the indicators in the display. The display will also show your heart rate when you use the handgrip pulse sensor (refer to step 6 on page 11) or the optional chest pulse sensor (refer to page 20).

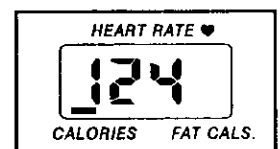

Time/Incline/Segment

Time display—When the manual mode or the iFIT.com mode is selected, this display will show the elapsed time and the incline level of the treadmill. The display will change from one number to the other every few seconds, as shown by the indicators in the display. When a personal trainer program or a heart rate program is selected, the display will show the *time remaining* in the program, the time remaining in the current segment of the program, and the incline level. Note: Each time the incline changes, the display will show the current incline setting for several seconds.

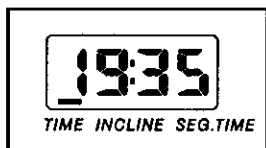

Distance/Laps

display—This display shows the distance that you have walked and the number of 1/4-mile laps you have completed. The display will change from one number to the other every few seconds, as shown by the indicators in the display.

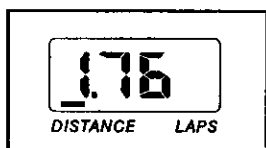

Speed/Min-Mile

display—This display shows the speed of the walking belt and your current pace (pace is measured in *minutes per mile*). The display will change from one number to the other every few seconds, as shown by the indicators in the display. Note: Each time the speed changes, the display will show the current speed setting for several seconds.

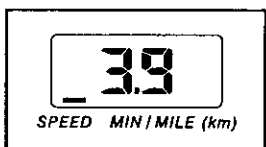

Note: The console can display speed and distance in either miles or kilometers. To find which unit of measurement is selected, hold down the Stop button while inserting the key into the console. An "E" for English miles or an "M" for metric kilometers will appear in the display. Press the Speed Δ button to change the unit of measurement. When the desired unit of measurement is selected, remove the key and then reinsert it.

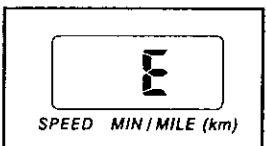

To reset the displays, press the Stop button, remove the key, and then reinsert the key.

6 Measure your heart rate, if desired.

Note: Before using the handgrip pulse sensor, make sure that your hands are clean.

To measure your heart rate, **stand on the foot rails** and place your hands on the metal contacts on the handrail. Your palms must be resting on the con-

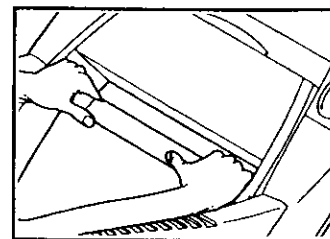

tacts—**avoid moving your hands**. When your pulse is detected, the heart-shaped indicator in the Calories/Fat Calories/Heart Rate display will flash, and then your heart rate will be shown. **For the most accurate heart rate reading, continue to hold the contacts for about 15 seconds.**

7 When you are finished exercising, remove the key.

Step onto the foot rails, press the Stop button, and **adjust the incline of the treadmill to the lowest setting. The incline must be at the lowest setting when the treadmill is folded to the storage position or the treadmill will be damaged.** Next, remove the key from the console and put it in a secure place. **Note: If the displays and various indicators on the console remain lit after the key is removed, the console is in the "demo" mode. See page 20 and turn off the demo mode.**

When you are finished using the treadmill, move the on/off switch near the power cord to the off position and unplug the power cord.

HOW TO USE PERSONAL TRAINER PROGRAMS

1 Insert the key fully into the console.

See HOW TO TURN ON THE POWER on page 10.

2 Select one of the personal trainer programs.

When the key is inserted, the manual mode will be selected. To select one of the personal trainer programs, press the Program button repeatedly until one of the four personal trainer program indicators lights. When a personal trainer program is selected, the Time/Incline/Segment Time display will flash the maximum incline setting for the program for six seconds, and the Speed/Min-mile display will flash the maximum speed setting.

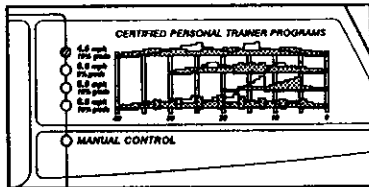

The four profiles on the right side of the console show how the speed and incline of the treadmill will change during the programs. The numbers beside the profiles show the maximum speed and incline settings for the programs.

The program display will show the first speed settings for the program. The Time/Incline/Segment Time display will show how long the program will last.

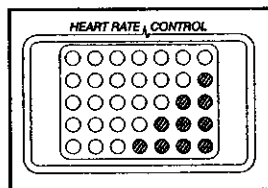

3 Press the Start button or the Speed Δ button to start the program.

A moment after the button is pressed, the treadmill will automatically adjust to the first speed and incline settings for the program. Hold the handrails and begin walking.

Each program is divided into several time segments of different lengths. The Time/Incline/Segment Time display will show both the time remaining in the program and the time remaining in the current segment. One speed setting and one incline setting are programmed for each segment. (The same speed setting and/or incline setting may be programmed for consecutive segments.) The

speed setting for the first segment will be shown in the flashing Current Segment column of the program display. (The incline settings are not shown in the program display.)

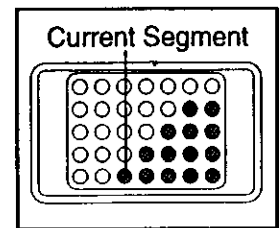

The speed settings for the next four segments will be shown in the four columns to the right.

When only three seconds remain in the first segment of the program, both the Current Segment column and the column to the right will flash and a tone will sound. In addition, if the speed and/or incline of the treadmill is about to change, the Speed/Min-mile display and/or the Time/Incline/Segment Time display will flash to alert you, and three tones will sound. When the first segment is completed, *all speed settings will move one column to the left*. The speed setting for the second segment will then be shown in the flashing Current Segment column and the treadmill will automatically adjust to the speed and incline settings for the second segment.

The program will continue in this way until the speed setting for the last segment is shown in the Current Segment column and no time remains in the Time/Incline/Segment Time display. The walking belt will then slow to a stop.

Note: Each time a segment ends and the speed settings move one column to the left, *if all of the indicators in the Current Segment column are lit, the speed settings will move downward so that only the highest indicators in the columns will appear in the program display*. When the speed settings move to the left again and not all of the indicators in the Current Segment column are lit, the speed settings will move back up.

If the speed or incline setting for the current segment is too high or too low, you can manually override the setting by pressing the Speed or Incline buttons. Every few times one of the Speed buttons is pressed, an additional indicator will light or darken in the Current Segment column. If any of the columns to the right of the Current Segment column have the same number of lit indicators as the Current Segment column, an additional indicator may light or darken in those columns as well. **Important: When the current segment of the program ends, the treadmill will automatically adjust to the speed and incline settings for the next segment.**

To stop the program temporarily, press the Stop button. The Time/Incline/Segment Time display will begin to flash. To restart the program, press the Start button or the Speed Δ button. To end the program, press the Stop button, remove the key, and then reinsert the key.

4 Follow your progress with the displays.

Refer to step 5 on page 10.

5 Measure your heart rate, if desired.

See step 6 on page 11.

6 When the program is completed, remove the key from the console.

When the program has ended, **make sure that the incline of the treadmill is at the lowest setting.** Next, remove the key from the console and put it in a safe place. **Note: If the displays and various indicators on the console remain lit after the key is removed, the console is in the "demo" mode. Refer to page 20 and turn off the demo mode.**

When you are finished using the treadmill, move the on/off switch near the power cord to the off position and unplug the power cord.

HOW TO USE HEART RATE PROGRAMS

CAUTION: If you have heart problems, or if you are over 60 years of age and have been inactive, do not use the heart rate programs. If you are taking medication regularly, consult your physician to find whether the medication will affect your exercise heart rate.

Follow the steps below to use the heart rate programs. **Note: You must wear the optional chest pulse sensor (see page 20) to use the heart rate programs.**

1 Put on the chest pulse sensor.

Refer to the instructions included with the optional chest pulse sensor.

2 Insert the key fully into the console.

See HOW TO TURN ON THE POWER on page 10.

3 Select a heart rate program.

When the key is inserted, the manual mode will be selected. To select one of the heart rate programs, press

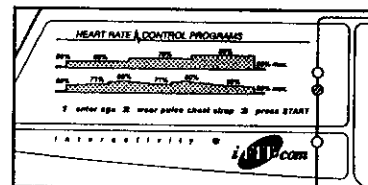

the Program button repeatedly until one of the two heart rate program indicators lights.

The two profiles on the left side of the console show how the target heart rate will change during the programs. The numbers above the profiles represent *percentages of your estimated maximum heart rate.* (Your estimated maximum heart rate is determined by subtracting your age from 220. For example, if you are 30 years old, your estimated maximum heart rate is 190 beats per minute [220 - 30 = 190]. If you are 30 years old, a target heart rate setting of 50% is equal to 95 beats per minute [50% of 190 is 95]).

During heart rate programs, the program display will show a graphic that represents your heart rate. Each time a heartbeat is detected, an additional peak will appear.

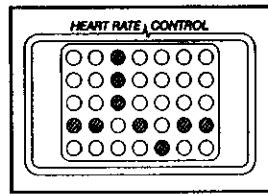

4 Enter your age.

When a heart rate program is selected, the letters AGE and the current age setting will begin to flash in the Calories/Fat Calories/Heart Rate display. You must enter your age to use a heart rate program. If you have already entered your age, go to step 5. If you have not entered your age, press the Incline (Age Set) buttons until your age is shown. Your age will then be saved in memory.

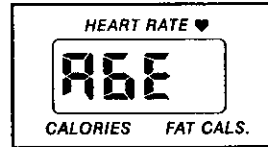

5 Press the Start button or the Speed Δ button to start the program.

A moment after the button is pressed, the treadmill will automatically adjust to the first speed and incline settings for the program. Hold the handrails and begin walking.

Each heart rate program is divided into one-minute segments. The Time/Incline/Segment Time display will show both the time remaining in the program and the time remaining in the current segment of the program. One target heart rate setting is programmed for each segment. (The same target heart rate setting may be programmed for consecutive segments.)

When only three seconds remain in the first one-minute segment of the program, a series of tones will sound and the Time/Incline/Segment Time display and the Speed/Min-Mile display will flash.

The speed and/or incline of the treadmill will then change, if needed, to bring your heart rate closer to the target heart rate setting for the next segment. The program will continue until no time remains in the program. The walking belt will then slow to a stop.

If the speed or incline setting for the current segment is too high or too low, you can adjust the setting with the Speed or Incline buttons. However, if you *decrease* the speed, the incline will automatically *increase*; if you *increase* the speed, the incline will *decrease*. If you *increase* the incline, the speed will *decrease*; if you *decrease* the incline, the speed will *increase*. *The treadmill will always attempt to keep your heart rate near the target heart rate setting for the current segment.* Note: When the incline reaches the lowest setting, the speed cannot be increased any further. When the incline reaches the highest setting, the speed cannot be decreased any further.

If your pulse is not detected during the program, the letters PLS will flash in the Calories/Fat Calories/Heart Rate display and the speed and incline of the treadmill may automatically decrease until your pulse is detected. If this occurs, refer to the instructions included with the chest pulse sensor.

To stop the program at any time, press the Stop button. Heart rate programs should not be stopped temporarily and then restarted. To use a heart rate program again, reselect the program and start it at the beginning.

6 Follow your progress with the displays.

Refer to step 5 on page 10.

7 When the program is completed, remove the key from the console.

Refer to step 6 on page 13.

HOW TO CONNECT THE TREADMILL TO YOUR CD PLAYER, VCR, OR COMPUTER

To use **iFIT.com** CDs, the treadmill must be connected to your portable CD player, portable stereo, home stereo, or computer with CD player. See pages 15 and 16 for connecting instructions. To use **iFIT.com** video-cassettes, the treadmill must be connected to your VCR. See page 17 for connecting instructions. To use **iFIT.com** programs directly from our internet site, the treadmill must be connected to your home computer. See page 16 for connecting instructions.

HOW TO CONNECT YOUR PORTABLE CD PLAYER

Note: If your CD player has separate **LINE OUT** and **PHONES** jacks, see instruction A below. If your CD player has only one jack, see instruction B.

- A. Plug one end of the audio cable into the jack on the front of the treadmill near the power cord. Plug the other end of the cable into the **LINE OUT** jack on your CD player. Plug your headphones into the **PHONES** jack.

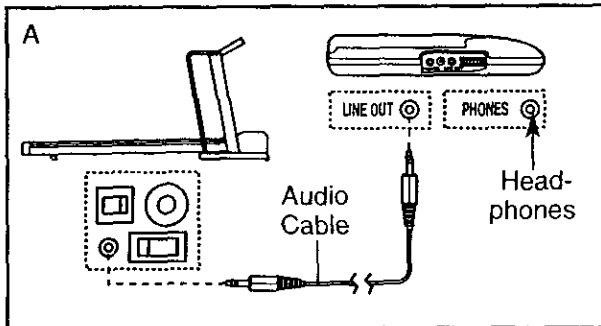

- B. Plug one end of the audio cable into the jack on the front of the treadmill near the power cord. Plug the other end of the cable into a 3.5mm Y-adaptor (available at electronics stores). Plug the Y-adaptor into the **PHONES** jack on your CD player. Plug your headphones into the other side of the Y-adaptor.

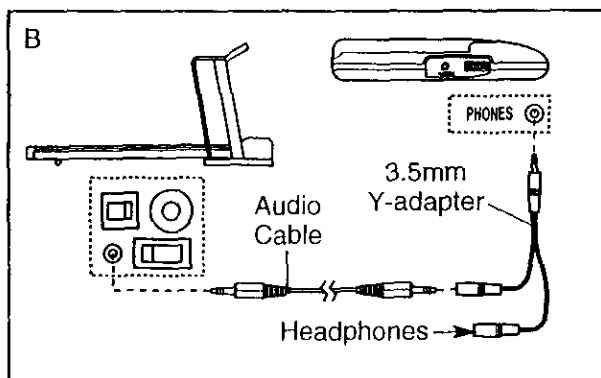

HOW TO CONNECT YOUR PORTABLE STEREO

Note: If your stereo has an **RCA-type AUDIO OUT** jack, see instruction A below. If your stereo has a **3.5mm LINE OUT** jack, see instruction B. If your stereo has only a **PHONES** jack, see instruction C.

- A. Plug one end of the audio cable into the jack on the front of the treadmill near the power cord. Plug the other end of the cable into the included adaptor. Plug the adaptor into an **AUDIO OUT** jack on your stereo.

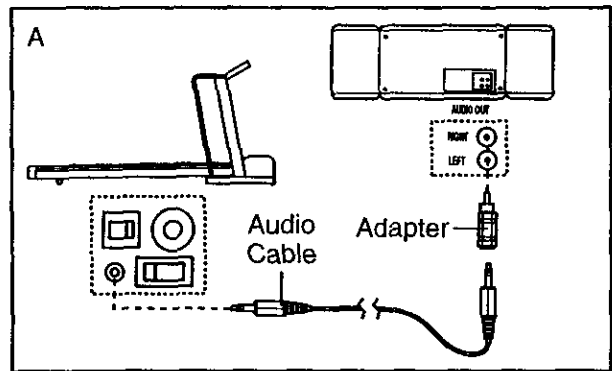

- B. Plug one end of the audio cable into the jack on the front of the treadmill near the power cord. Plug the other end of the cable into the **LINE OUT** jack on your stereo.

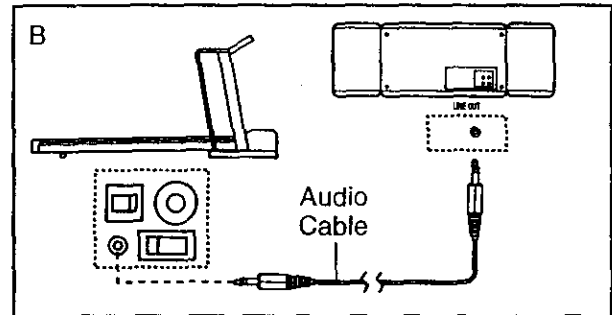

- C. Plug one end of the audio cable into the jack on the front of the treadmill near the power cord. Plug the other end of the cable into a 3.5mm Y-adaptor (available at electronics stores). Plug the Y-adaptor into the **PHONES** jack on your stereo. Plug your headphones into the other side of the Y-adaptor.

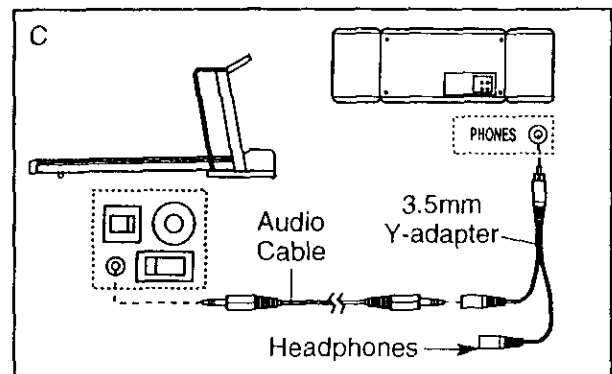

HOW TO CONNECT YOUR HOME STEREO

Note: If your stereo has an unused LINE OUT jack, see instruction A below. If the LINE OUT jack is being used, see instruction B.

- A. Plug one end of the audio cable into the jack on the front of the treadmill near the power cord. Plug the other end of the cable into the included adapter. Plug the adapter into the LINE OUT jack on your stereo.

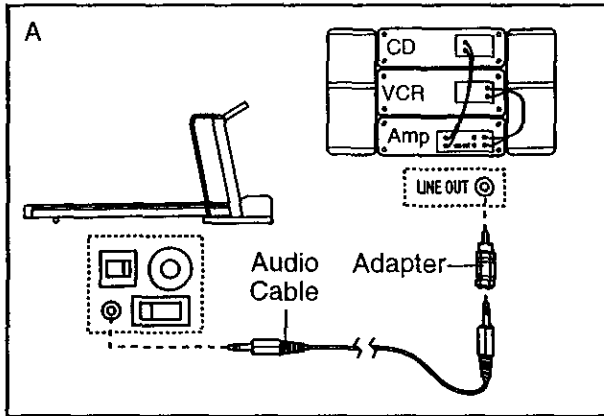

- B. Plug one end of the audio cable into the jack on the front of the treadmill near the power cord. Plug the other end of the cable into the included adapter. Plug the adapter into an RCA Y-adapter (available at electronics stores). Next, remove the wire that is currently plugged into the LINE OUT jack on your stereo and plug the wire into the unused side of the Y-adapter. Plug the Y-adapter into the LINE OUT jack on your stereo.

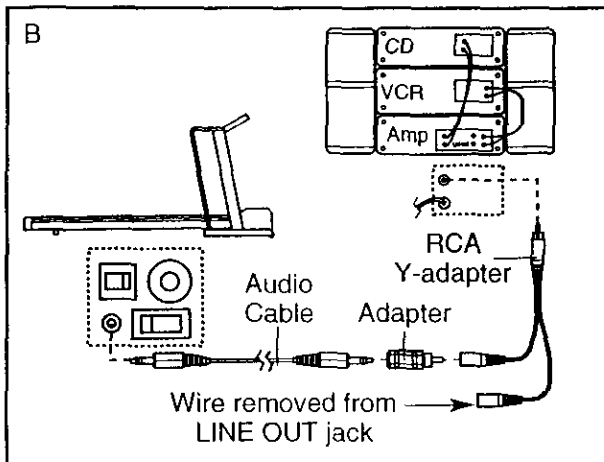

HOW TO CONNECT YOUR COMPUTER

Note: If your computer has a 3.5mm LINE OUT jack, see instruction A. If your computer has only a PHONES jack, see instruction B.

- A. Plug one end of the audio cable into the jack on the front of the treadmill near the power cord. Plug the other end of the cable into the LINE OUT jack on your computer.

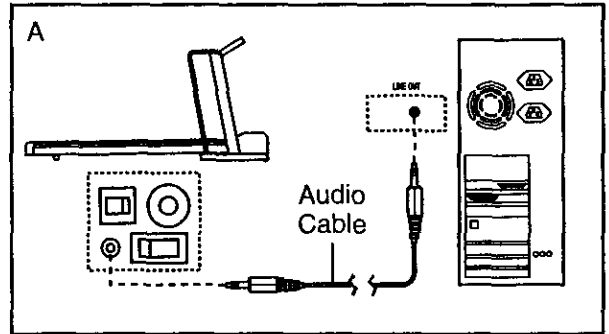

- B. Plug one end of the audio cable into the jack on the front of the treadmill near the power cord. Plug the other end of the cable into a 3.5mm Y-adapter (available at electronics stores). Plug the Y-adapter into the PHONES jack on your computer. Plug your headphones or speakers into the other side of the Y-adapter.

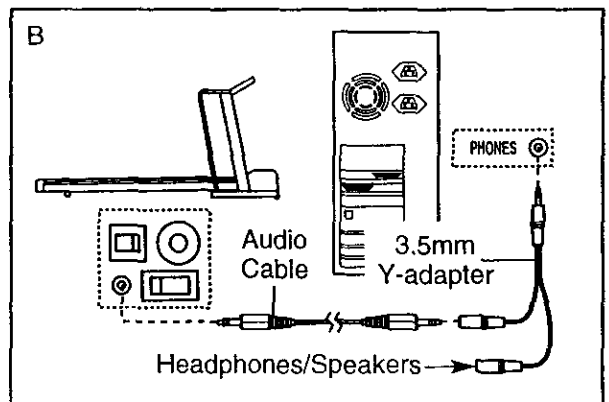

HOW TO CONNECT YOUR VCR

Note: If your VCR has an unused AUDIO OUT jack, see instruction A below. If the AUDIO OUT jack is being used, see instruction B. If you have a TV with a built-in VCR, see instruction B. If your VCR is connected to your home stereo, see HOW TO CONNECT YOUR HOME STEREO on page 16.

- A. Plug one end of the audio cable into the jack on the front of the treadmill near the power cord. Plug the other end of the cable into the included adapter. Plug the adapter into the AUDIO OUT jack on your VCR.

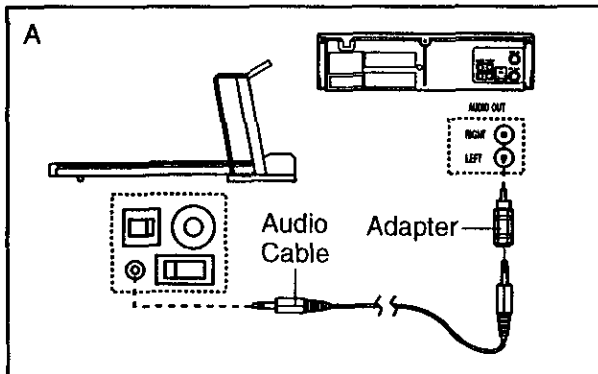

- B. Plug one end of the audio cable into the jack on the front of the treadmill near the power cord. Plug the other end of the cable into the included adapter. Plug the adapter into an RCA Y-adapter (available at electronics stores). Next, remove the wire that is currently plugged into the AUDIO OUT jack on your VCR and plug the wire into the unused side of the Y-adapter. Plug the Y-adapter into the AUDIO OUT jack on your VCR.

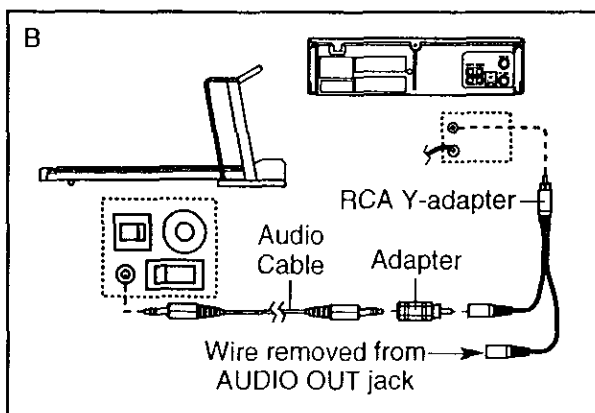

HOW TO USE iFIT.COM CD AND VIDEO PROGRAMS

To use iFIT.com CDs or videocassettes, the treadmill must be connected to your portable CD player, portable stereo, home stereo, computer with CD player, or VCR. See HOW TO CONNECT THE TREADMILL TO YOUR CD PLAYER, VCR, OR COMPUTER on page 15. **Note:** To purchase iFIT.com CDs or videocassettes, call toll-free 1-800-735-0768.

Follow the steps below to use an iFIT.com CD or video program.

1 Insert the key into the console.

See HOW TO TURN ON THE POWER on page 10.

2 Select the iFIT.com mode.

When the key is inserted, the manual mode will be selected. To use iFIT.com CDs or videocassettes, press the Program button repeatedly until the iFIT.com indicator lights.

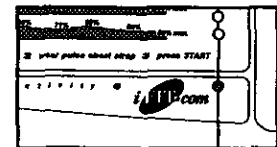

3 Insert the iFIT.com CD or videocassette.

If you are using an iFIT.com CD, insert the CD into your CD player. If you are using an iFIT.com videocassette, insert the videocassette into your VCR.

4 Press the PLAY button on your CD player or VCR.

A moment after the button is pressed, your personal trainer will begin guiding you through your workout. Simply follow your personal trainer's instructions. **Note:** If the Time/Incline/Segment Time display is flashing, press the Start button or the Speed Δ button on the console. The treadmill will not respond to a CD or video program when the Time/Incline/Segment Time display is flashing.

During the CD or video program, an electronic "chirping" sound will alert you when the speed and/or incline of the treadmill is about to change. **CAUTION: Always listen for the "chirp" and be prepared for speed and/or incline changes. In some instances, the speed and/or incline may change before the personal trainer describes the change.**

If the speed or incline settings are too high or too low, you can manually override the settings at any time by pressing the Speed or Incline buttons on the console. However, **when the next “chirp” is heard, the speed and/or incline will change to the next settings of the CD or video program.**

To stop the walking belt at any time, press the Stop button on the console. The Time/Incline/Segment Time display will begin to flash. To restart the program, press the Start button or the Speed Δ button. After a moment, the walking belt will begin to move at 1.0 mph. **When the next “chirp” is heard, the speed and incline will change to the next settings of the CD or video program.** The program can also be stopped by pressing the Stop button on your CD player or VCR.

When the CD or video program is completed, the walking belt will stop and the Time/Incline/Segment Time display will begin to flash. Note: To use another CD or video program, press the Stop button or remove the key and go to step 1 on page 17.

Note: If the speed or incline of the treadmill does not change when a “chirp” is heard:

- **make sure that the iFIT.com indicator is lit and that the Time/Incline/Segment Time display is not flashing. If the Time/Incline/Segment Time display is flashing, press the Start button or the Speed Δ button on the console**

- **adjust the volume of your CD player or VCR. If the volume is too high or too low, the console may not detect the program signals**
- **make sure that the audio cable is properly connected, that it is fully plugged in, and that it is not wrapped around a power cord**
- **if you are using your portable CD player and the CD skips, set the CD player on the floor or another flat surface instead of on the console.**

5 Follow your progress with the LED track and the displays.

See step 5 on page 10.

6 Measure your heart rate, if desired.

Refer to step 6 on page 11.

7 When the program is completed, remove the key.

See step 6 on page 13.

CAUTION: Always remove iFIT.com CDs and videocassettes from your CD player or VCR when you are finished using them.

HOW TO USE PROGRAMS DIRECTLY FROM OUR WEB SITE

Our Web site at www.iFIT.com allows you to access basic programs, audio programs, and video programs directly from the internet. Additional options, such as on-line competitions, personal training sessions via the internet, and online tracking of your workout history are soon to be available. See www.iFIT.com for details.

To use programs from our Web site, the treadmill must be connected to your home computer. See **HOW TO CONNECT YOUR COMPUTER** on page 16. In addition, you must have an internet connection and an internet service provider. A list of specific system requirements will be found on our Web site.

Follow the steps below to use a program from our Web site.

1 Insert the key into the console.

See **HOW TO TURN ON THE POWER** on page 10.

2 Select the iFIT.com mode.

When the key is inserted, the manual mode will be selected. To use a program from our Web site, press the Program button repeatedly until the iFIT.com indicator lights.

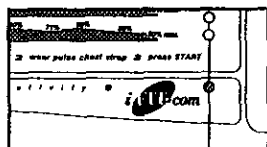

3 Go to your computer and start an internet connection.

4 Start your web browser, if necessary, and go to our Web site at www.iFIT.com.

5 Follow the desired links on our Web site to select a program.

Read and follow the on-line instructions for using a program.

6 Follow the on-line instructions to start the program.

When you start the program, an on-screen countdown will begin.

7 Return to the treadmill and stand on the foot rails. Find the clip attached to the key and slide the clip onto the waistband of your clothing.

When the on-screen countdown ends, the program will begin and the walking belt will begin to move. Hold the handrails, step onto the walking belt, and begin walking. During the program, an electronic "chirping" sound will alert you when the speed and/or incline of the treadmill is about to change. **CAUTION: Always listen for the "chirp" and be prepared for speed and/or incline changes.**

If the speed or incline settings are too high or too low, you can manually override the settings at any time by pressing the Speed or Incline buttons on the console. **However, when the next "chirp" is heard, the speed and/or incline will change to the next settings for the program.**

To stop the walking belt at any time, press the Stop button on the console. The Time/Incline/Segment Time display will begin to flash. To restart the program, press the Start button or the Speed Δ button. After a moment, the walking belt will begin to move at 1.0 mph. **When the next "chirp" is heard, the speed and incline will change to the next settings of the program.**

When the program is completed, the walking belt will stop and the Time/Incline/Segment Time display will begin to flash. Note: To use another program, press the Stop button and go to step 5.

Note: If the speed or incline of the treadmill does not change when a "chirp" is heard, make sure that the iFIT.com indicator is lit and that the Time/Incline/Segment Time display is not flashing. In addition, make sure that the audio cable is properly connected, that it is fully plugged in, and that it is not wrapped around a power cord.

8 Follow your progress with the LED track and the displays.

See step 5 on page 10.

9 When the program has ended, remove the key.

See step 6 on page 13.

THE INFORMATION MODE/DEMO MODE

The console features an information mode that keeps track of the total number of hours that the treadmill has been operated and the total number of miles that the walking belt has moved. The information mode also allows you to switch the console from miles per hour to kilometers per hour. In addition, the information mode allows you to turn on and turn off the demo mode.

To select the information mode, hold down the Stop button while inserting the key into the console. When the information mode is selected, the following information will be shown:

The Time/Incline/Segment Time display will show the total number of hours the treadmill has been used.

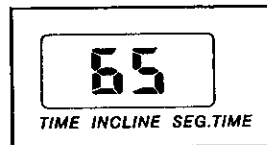

The Distance/Laps display will show the total number of miles (or kilometers) that the walking belt has moved.

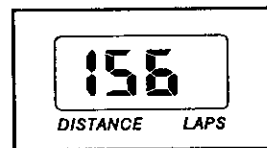

An "E" for english miles or an "M" for metric kilometers will appear in the Speed/Min-Mile display. Press the Speed Δ button to change the unit of measurement.

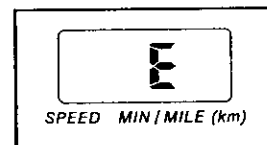

IMPORTANT: The Calories/Fat Calories/Heart Rate display should be blank. If a "d" appears in the display, the console is in the "demo" mode. This mode is intended to be used only when a treadmill is displayed in a store. When the console is in the demo mode, the power cord can be plugged in, the key can be removed from the console, and the displays and indicators on the console will automatically light in a preset sequence, although the buttons on the console will not operate. **If a "d" appears in the Calories/Fat Calories/Heart Rate display when the information mode is selected, press the Speed ∇ button so the Calories/Fat Calories/Heart Rate display is blank.**

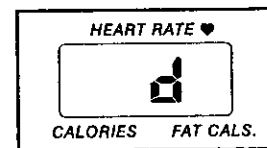

To exit the information mode, remove the key from the console.

THE OPTIONAL CHEST PULSE SENSOR

An optional chest pulse sensor adds even more features to the console. The chest pulse sensor offers hands-free operation, and enables you to use the console's two heart rate programs. **To purchase the chest pulse sensor, call the toll-free telephone number listed on the back cover of this manual.**

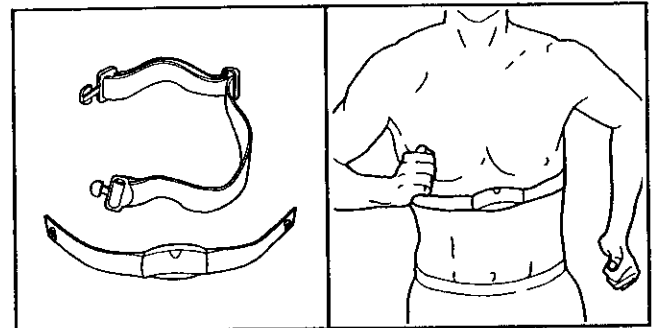

HOW TO FOLD AND MOVE THE TREADMILL

HOW TO FOLD THE TREADMILL FOR STORAGE

Before folding the treadmill, adjust the incline to the lowest position. If this is not done, the treadmill may be permanently damaged. Next, unplug the power cord. **CAUTION: You must be able to safely lift 45 pounds (20 kg) in order to raise, lower, or move the treadmill.**

1. Hold the treadmill with your hands in the locations shown at the right. **CAUTION: To decrease the possibility of injury, bend your legs and keep your back straight. As you raise the treadmill, make sure to lift with your legs rather than your back.** Raise the treadmill about halfway to the vertical position.

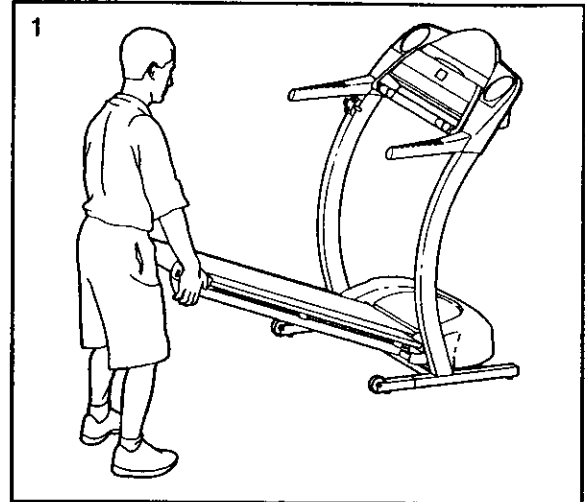

2. Move your right hand to the position shown and hold the treadmill firmly. Using your left hand, pull the latch knob to the left and hold it. Raise the treadmill until the catch is past the latch pin. Slowly release the latch knob. **Make sure that the catch is securely held by the latch pin.**

To protect the floor or carpet from damage, place a mat under the treadmill. Keep the treadmill out of direct sunlight. Do not leave the treadmill in the storage position in temperatures above 85° Fahrenheit.

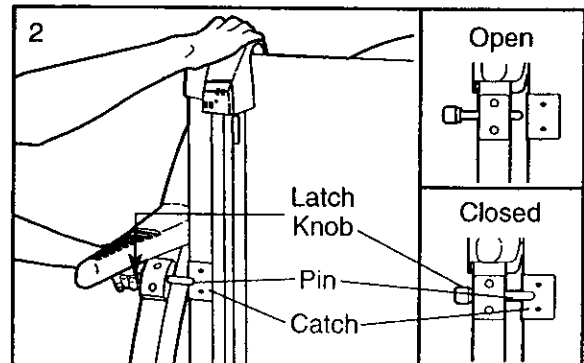

HOW TO MOVE THE TREADMILL

Before moving the treadmill, convert the treadmill to the storage position as described above. **Make sure that the catch is securely held by the latch pin.**

1. Hold the handrails as shown and place one foot against a wheel.
2. Tilt the treadmill back until it rolls freely on the wheels. Carefully move the treadmill to the desired location. **Never move the treadmill without tipping it back. To reduce the risk of injury, use extreme caution while moving the treadmill. Do not attempt to move the treadmill over an uneven surface.**
3. Place one foot on a wheel, and carefully lower the treadmill until it is resting in the storage position.

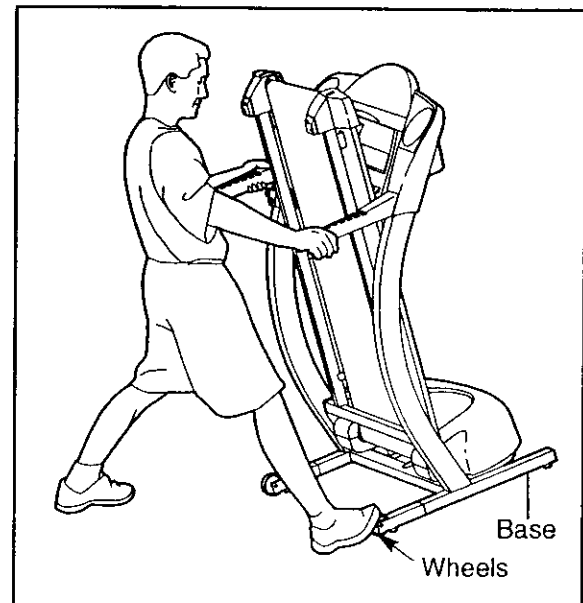

HOW TO LOWER THE TREADMILL FOR USE

1. Hold the upper end of the treadmill with your right hand as shown. Using your left hand, pull the latch knob to the left and hold it. Pivot the treadmill down until the frame is past the pin. Slowly release the latch knob.

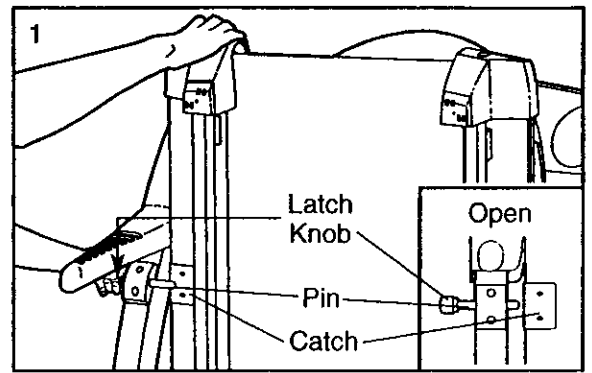

2. Hold the treadmill firmly with both hands, and lower the treadmill to the floor. **Do not drop the treadmill frame to the floor. CAUTION: To decrease the possibility of injury, bend your legs and keep your back straight.**

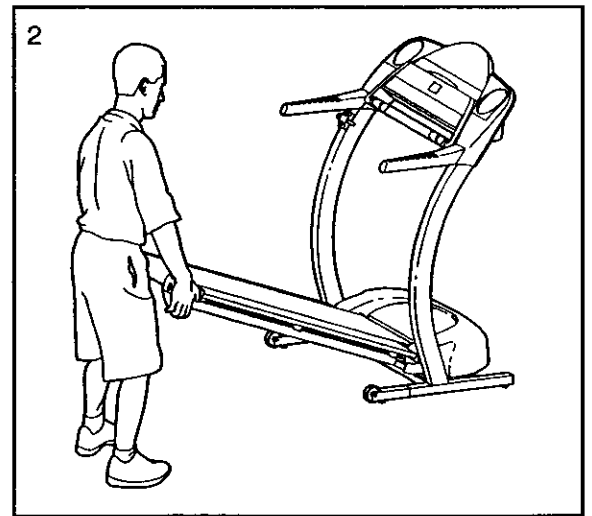

TROUBLE-SHOOTING

Most treadmill problems can be solved by following the simple steps below. Find the symptom that applies, and follow the steps listed. If further assistance is needed, call our toll-free HELPLINE at 1-800-736-6879, Monday through Saturday, 7 a.m. until 7 p.m. Central Time (excluding holidays).

PROBLEM: The power does not turn on

SOLUTION: a. Make sure that the power cord is plugged into a surge suppressor, and that the surge suppressor is plugged into a properly grounded outlet (see page 8). Use only a single-outlet surge suppressor that is UL 1449 listed as a transient voltage surge suppressor (TVSS). The surge suppressor must have a UL suppressed voltage rating of 400 volts or less and a minimum surge dissipation of 450 joules. The surge suppressor must be electrically rated for 120 volts AC and 15 amps. Important: The treadmill is not compatible with GFCI-equipped outlets.

b. After the power cord has been plugged in, make sure that the key is fully inserted into the console.

c. Check the circuit breaker located on the treadmill near the power cord. If the switch protrudes as shown, the circuit breaker has tripped. To reset the circuit breaker, wait for five minutes and then press the switch back in.

d. Check the on/off switch located on the treadmill near the power cord. The switch must be in the on position.

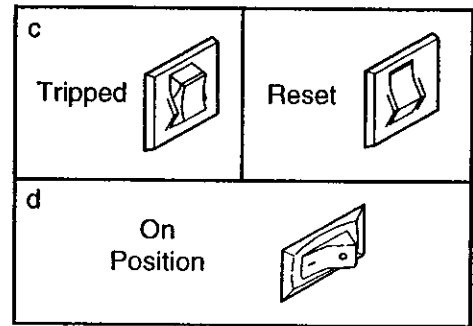

PROBLEM: The power turns off during use

SOLUTION: a. Check the circuit breaker located on the treadmill frame near the power cord (see c. above). If the circuit breaker has tripped, wait for five minutes and then press the switch back in.

b. Make sure that the power cord is plugged in.

c. Unplug the power cord, wait for five minutes, and then plug the power cord back in.

d. Remove the key from the console. Reinsert the key fully into the console.

e. Make sure that the on/off switch is in the on position.

f. If the treadmill still will not run, please call our toll-free HELPLINE.

PROBLEM: The speed display on the console does not function properly

SOLUTION: a. Remove the key and **UNPLUG THE POWER CORD.** Carefully lower the Uprights (64) to the floor. Remove the three indicated Small Screws (37).

Raise the Uprights (64) to the vertical position. Pivot the Hood (1) off.

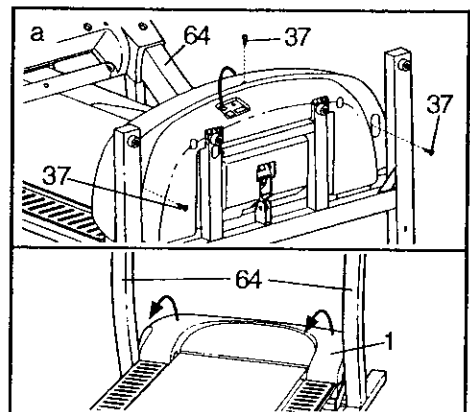

Locate the Reed Switch (18) and the Magnet (101) on the left side of the Pulley (78). Turn the Pulley until the Magnet is aligned with the Reed Switch. **Make sure that the gap between the Magnet and the Reed Switch is about 1/8"**. If necessary, loosen the 3/4" Screw (24) and move the Reed Switch slightly. Retighten the Screw. Re-attach the hood, and run the treadmill for a few minutes to check for a correct speed reading.

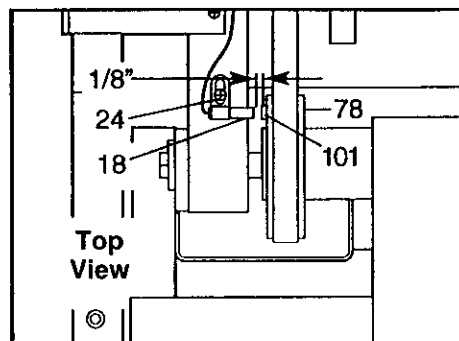

PROBLEM: The walking belt slows when walked on

SOLUTION: a. See (a) under **The power does not turn on** on page 23.

b. If the walking belt is overtightened, treadmill performance may decrease and the walking belt may become damaged. Remove the key and **UNPLUG THE POWER CORD**. Using the allen wrench, turn both rear roller adjustment bolts counterclockwise, 1/4 of a turn. When the walking belt is properly tightened, you should be able to lift each side of the walking belt 3 to 4 inches off the walking platform. Be careful to keep the walking belt centered. Plug in the power cord, insert the key and run the treadmill for a few minutes. Repeat until the walking belt is properly tightened.

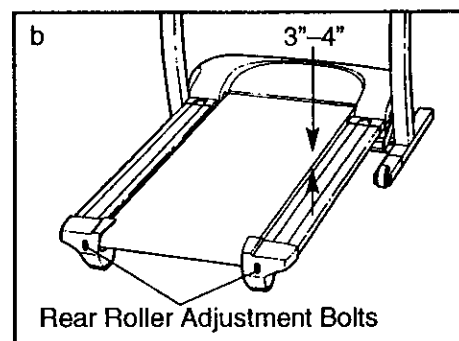

c. If the walking belt still slows when walked on, please call our toll-free HELPLINE.

PROBLEM: The walking belt is off-center or slips when walked on

SOLUTION: a. **If the walking belt has shifted to the left**, first remove the key and **UNPLUG THE POWER CORD**. Using the allen wrench, turn the left rear roller bolt clockwise 1/2 of a turn. Be careful not to overtighten the walking belt. **If the walking belt has shifted to the right**, turn the left rear roller bolt counterclockwise 1/2 of a turn. Plug in the power cord, insert the key and run the treadmill for a few minutes. Repeat until the walking belt is centered.

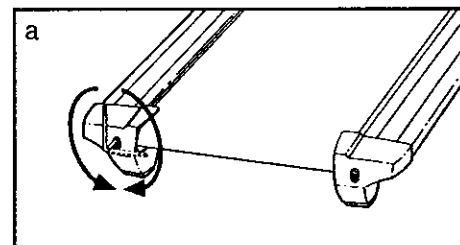

b. If the walking belt slips when walked on, first remove the key and **UNPLUG THE POWER CORD**. Using the allen wrench, turn both rear roller bolts clockwise, 1/4 of a turn. When the walking belt is correctly tightened, you should be able to lift each side of the walking belt 3 to 4 inches off the walking platform. Be careful to keep the walking belt centered. Plug in the power cord, insert the key and carefully walk on the treadmill for a few minutes. Repeat until the walking belt is properly tightened.

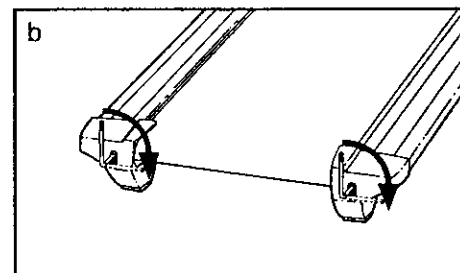

PROBLEM: The incline of the treadmill does not change correctly or does not change when iFIT.com CDs and videos are played

SOLUTION: a. With the key inserted in the console, press one of the Incline buttons. **While the incline is changing, remove the key.** After a few seconds, re-insert the key. The treadmill will automatically rise to the maximum incline level and then return to the minimum level. This will recalibrate the incline.

CONDITIONING GUIDELINES

⚠ WARNING: Before beginning this or any exercise program, consult your physician. This is especially important for individuals over the age of 35 or individuals with pre-existing health problems.

The pulse sensor is not a medical device. Various factors, including your movement, may affect the accuracy of heart rate readings. The sensor is intended only as an exercise aid in determining heart rate trends in general.

The following guidelines will help you to plan your exercise program. For more detailed exercise information, obtain a reputable book or consult your physician.

EXERCISE INTENSITY

Whether your goal is to burn fat or to strengthen your cardiovascular system, the key to achieving the desired results is to exercise with the proper intensity. The proper intensity level can be found by using your heart rate as a guide. The chart below shows recommended heart rates for fat burning and aerobic exercise.

AEROBIC	165	155	145	140	130	125	115
MAX FAT BURN	145	138	130	125	118	110	103
FAT BURN	125	120	115	110	105	95	90
Age	20	30	40	50	60	70	80

To find the proper heart rate for you, first find your age near the bottom of the chart (ages are rounded off to the nearest ten years). Next, find the three numbers above your age. The three numbers define your "training zone." The lower two numbers are recommended heart rates for fat burning; the higher number is the recommended heart rate for aerobic exercise.

To measure your heart rate during exercise, use the pulse sensor. If your heart rate is too high or too low, adjust the speed and incline of the treadmill.

Fat Burning

To burn fat effectively, you must exercise at a relatively low intensity level for a sustained period of time. During the first few minutes of exercise, your body uses easily accessible *carbohydrate calories* for en-

ergy. Only after the first few minutes does your body begin to use stored *fat calories* for energy. If your goal is to burn fat, adjust the speed and incline of the treadmill until your heart rate is near the lowest number in your training zone.

For maximum fat burning, adjust the speed and incline of the treadmill until your heart rate is near the middle number in your training zone.

Aerobic Exercise

If your goal is to strengthen your cardiovascular system, your exercise must be "aerobic." Aerobic exercise is activity that requires large amounts of oxygen for prolonged periods of time. This increases the demand on the heart to pump blood to the muscles, and on the lungs to oxygenate the blood. For aerobic exercise, adjust the speed and incline of the treadmill until your heart rate is near the highest number in your training zone.

WORKOUT GUIDELINES

Each workout should include the following three parts:

A Warm-up—Start each workout with 5 to 10 minutes of stretching and light exercise. A proper warm-up increases your body temperature, heart rate and circulation in preparation for exercise.

Training Zone Exercise—After warming up, increase the intensity of your exercise until your pulse is in your training zone for 20 to 60 minutes. (During the first few weeks of your exercise program, do not keep your pulse in your training zone for longer than 20 minutes.) Breathe regularly and deeply as you exercise—never hold your breath.

A Cool-down—Finish each workout with 5 to 10 minutes of stretching to cool down. This will increase the flexibility of your muscles and will help prevent post-exercise problems.

EXERCISE FREQUENCY

To maintain or improve your condition, complete three workouts each week, with at least one day of rest between workouts. After a few months, you may complete up to five workouts each week if desired.

The key to success is to make exercise a regular and enjoyable part of your everyday life.

SUGGESTED STRETCHES

The correct form for several basic stretches is shown at the right. Move slowly as you stretch—never bounce.

1. Toe Touch Stretch

Stand with your knees bent slightly and slowly bend forward from your hips. Allow your back and shoulders to relax as you reach down toward your toes as far as possible. Hold for 15 counts, then relax. Repeat 3 times. Stretches: Hamstrings, back of knees and back.

2. Hamstring Stretch

Sit with one leg extended. Bring the sole of the opposite foot toward you and rest it against the inner thigh of your extended leg. Reach toward your toes as far as possible. Hold for 15 counts, then relax. Repeat 3 times for each leg. Stretches: Hamstrings, lower back and groin.

3. Calf/Achilles Stretch

With one leg in front of the other, reach forward and place your hands against a wall. Keep your back leg straight and your back foot flat on the floor. Bend your front leg, lean forward and move your hips toward the wall. Hold for 15 counts, then relax. Repeat 3 times for each leg. To cause further stretching of the achilles tendons, bend your back leg as well. Stretches: Calves, achilles tendons and ankles.

4. Quadriceps Stretch

With one hand against a wall for balance, reach back and grasp one foot with your other hand. Bring your heel as close to your buttocks as possible. Hold for 15 counts, then relax. Repeat 3 times for each leg. Stretches: Quadriceps and hip muscles.

5. Inner Thigh Stretch

Sit with the soles of your feet together and your knees outward. Pull your feet toward your groin area as far as possible. Hold for 15 counts, then relax. Repeat 3 times. Stretches: Quadriceps and hip muscles.

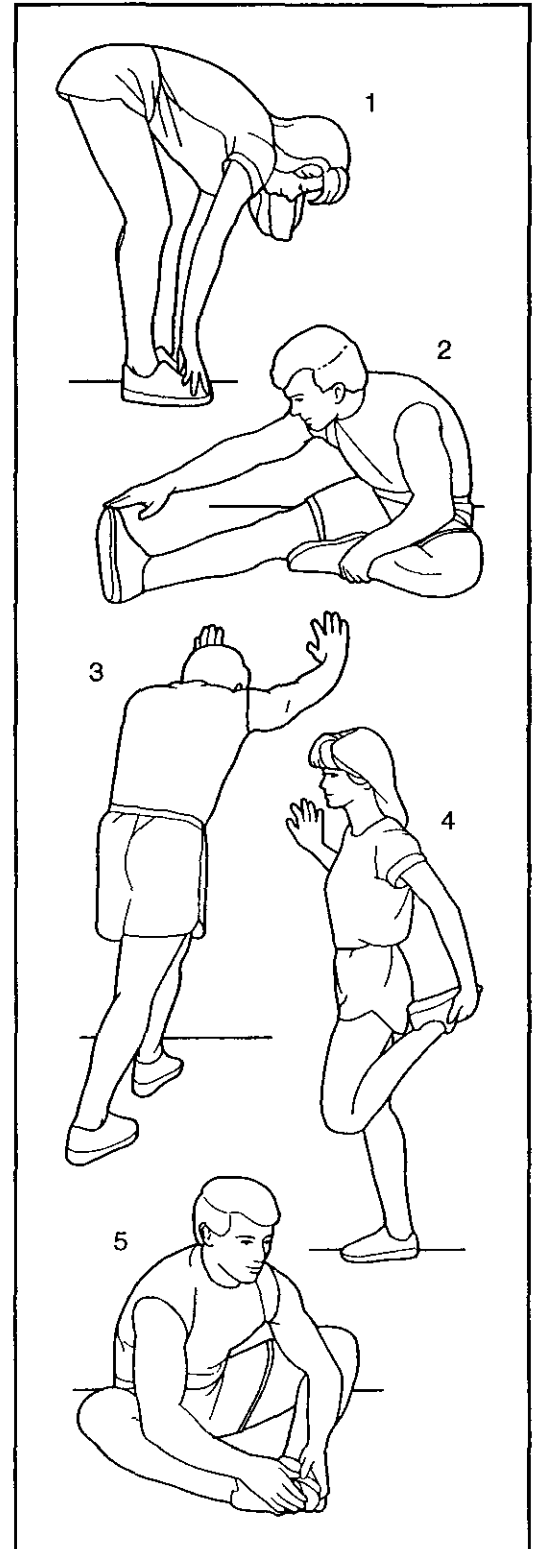

NOTES

EXPLODED DRAWING—Model No. 831.291670

R1101A

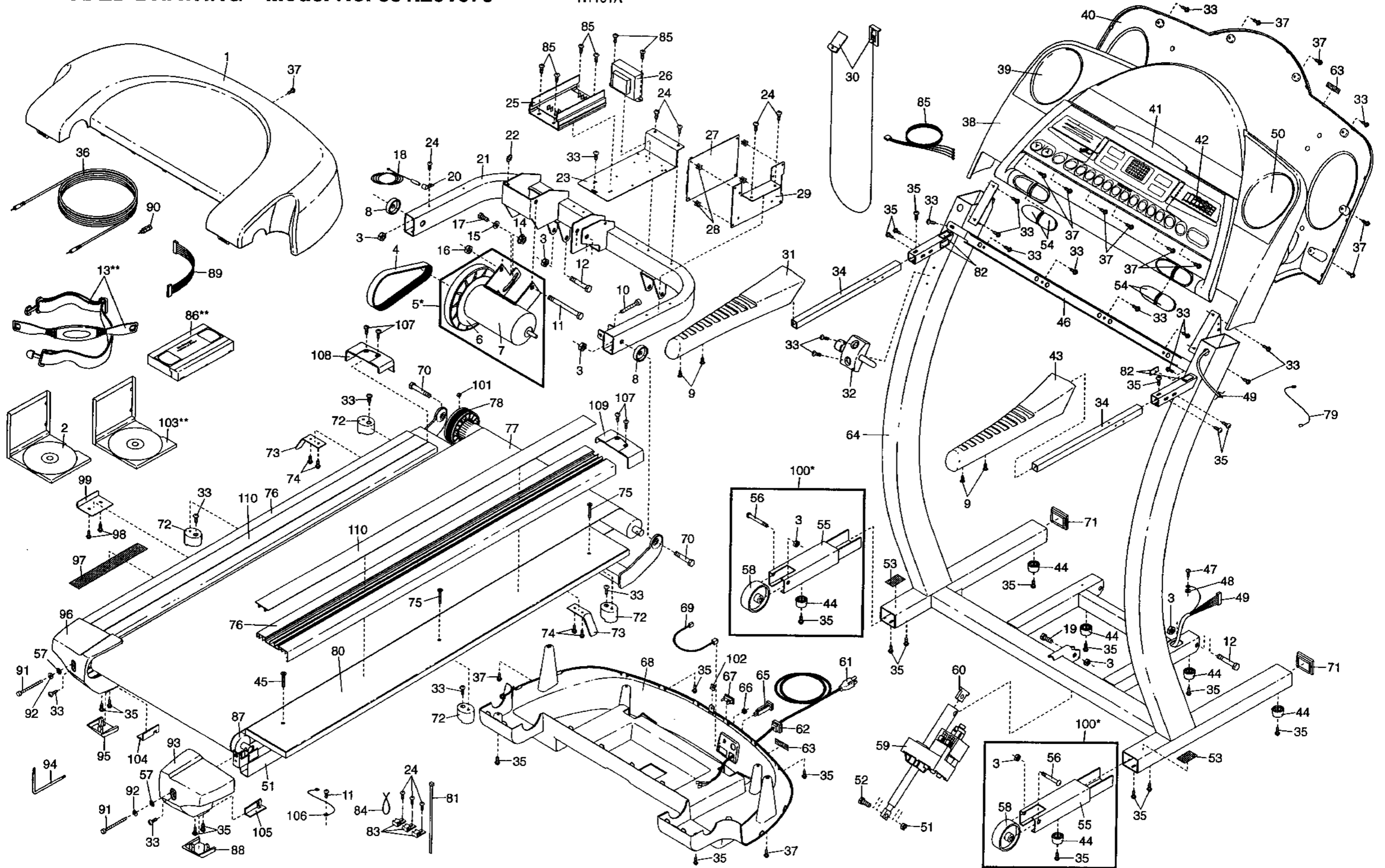

PART LIST—Model No. 831.291670

R1101A

Key No.	Qty.	Description	Key No.	Qty.	Description	Key No.	Qty.	Description
1	1	Motor Hood	46	1	Crossbar	91	2	Rear Roller Adj. Bolt
2	1	iFIT.com CD	47	1	Ground Screw	92	2	Roller Adj. Washer
3	8	Pivot Nut	48	1	Ground Washer	93	1	Rear Endcap (Right)
4	1	Motor Belt	49	1	Upright Wire	94	1	Allen Wrench
5*	1	Motor Assembly	50	1	Right Cup Holder	95	1	Rear Foot (Left)
6	1	Flywheel	51	1	Frame	96	1	Rear Endcap (Left)
7	1	Motor	52	1	Incline Motor Bolt	97	1	Warning Decal
8	2	Frame Spacer	53	2	Caution Decal	98	2	Latch Plate Screw
9	4	Plastic Fastener	54	4	Pulse Sensor	99	1	Latch Plate
10	1	Front Roller Adj. Bolt	55	2	Extension Leg	100*	2	Extension Leg Assembly
11	1	Motor Pivot Bolt	56	2	Wheel Bolt	101	1	Magnet
12	2	Lift Frame Pivot Bolt	57	2	Roller Star Washer	102	1	Belly Pan Clip
13**	1	Chest Pulse	58	2	Wheel	103**	2	iFIT.com CD
14	1	Motor Tension Nut	59	1	Incline Motor	104	1	Endcap Bracket (Left)
15	1	Motor Washer	60	1	Stop Bracket	105	1	Endcap Bracket (Right)
16	1	Motor Pivot Nut	61	1	Power Cord	106	1	Ground Wire
17	1	Motor Tension Bolt	62	1	Grommet	107	4	Endcap Screw
18	1	Reed Switch	63	2	Static Decal	108	1	Front Endcap (Right)
19	1	2" Incline Motor Bolt	64	1	Upright	109	1	Front Endcap (Left)
20	1	Reed Switch Clip	65	1	Circuit Breaker	110	2	Staple Cover
21	1	Lift Frame	66	1	Audio Wire Nut	#	1	8" White Wire, 2F
22	1	Motor Star Washer	67	1	On/Off Switch	#	1	8" White Wire, M/F
23	1	Controller Bracket	68	1	Belly Pan	#	1	14" Blue Wire, 2F
24	11	3/4" Screw	69	1	Audio Wire	#	1	4" Blue Wire, 2F
25	1	Controller	70	2	Frame Pivot Bolt	#	1	12" Green Wire, F/R
26	1	Choke	71	2	Base Endcap	#	1	8" Green Wire, M/R
27	1	Power Board	72	4	Isolator	#	1	4" Black Wire, 2F
28	1	Plastic Stand-Off	73	2	Belt Guide	#	1	4" Red Wire, M/F
29	1	Power Board Bracket	74	4	Belt Guide Screw	#	1	User's Manual
30	1	Key/Clip	75	4	Platform Screw			
31	1	Left Foam Grip	76	2	Foot Rail			
32	1	Latch Assembly	77	1	Walking Belt			
33	25	Screw	78	1	Front Roller/Pulley	#		# These parts are not illustrated
34	2	Handrail Extension	79	1	Console Ground Wire	*		* Includes all parts shown in the box
35	16	Extension Screw/ Handlebar Screw	80	1	Walking Platform			
36	1	iFIT.com Wire	81	9	8" Cable Tie			
37	33	Small Screw	82	4	Foam Pad	**		**These parts are optional. For information about iFIT.com CD's or videocassettes, see your local SEARS or call toll-free 1-800-884-0620. For information about the optional or chest pulse sensor, see page 20.
38	1	Console Base	83	3	Tie Holder Clamp			
39	1	Left Cup Holder	84	2	Releasable Tie			
40	1	Console Back	85	1	Pulse Wire			
41	1	Book Holder	86**	1	iFIT.com Videocassette			
42	1	Console	87	1	Rear Roller			
43	1	Right Foam Grip	88	1	Rear Foot (Right)			
44	6	Base Pad	89	1	Motor Controller Wire			
45	2	Platform Screw (Rear)	90	1	iFIT.com Jack			

SEARS

Model No. 831.291670

QUESTIONS?

If you find that:

- you need help assembling or operating the PROFORM 760 EKG treadmill
- a part is missing
- or you need to schedule repair service

call our toll-free HELPLINE

1-800-736-6879

Monday–Saturday, 7 am–7 pm
Central Time (excluding holidays)

REPLACEMENT PARTS

If parts become worn and need to be replaced, call the following toll-free number

1-800-FON-PART
(1-800-366-7278)

The model number and serial number of your PROFORM® 760 EKG treadmill are listed on a decal attached to the frame. See the front cover of this manual to find the location of the decal.

All replacement parts are available for immediate purchase or special order when you visit your nearest SEARS Service Center. To request service or to order parts by telephone, call the toll-free numbers listed at the left.

When requesting help or service, or ordering parts, please be prepared to provide the following information:

- The NAME OF THE PRODUCT (PROFORM® 760 EKG treadmill)
- The MODEL NUMBER OF THE PRODUCT (831.291670)
- The KEY NUMBER AND DESCRIPTION OF THE PART (see the EXPLODED DRAWING and PART LIST in the center of this manual).

FULL 90 DAY WARRANTY

For 90 days from the date of purchase, if failure occurs due to defect in material or workmanship in this SEARS TREADMILL EXERCISER, contact the nearest SEARS Service Center throughout the United States and SEARS will repair or replace the TREADMILL EXERCISER, free of charge.

This warranty does not apply when the TREADMILL EXERCISER is used commercially or for rental purposes.

This warranty gives you specific legal rights, and you may also have other rights which vary from state to state.

SEARS, ROEBUCK AND CO., DEPT. 817WA, HOFFMAN ESTATES, IL 60179