

---

# OWNER'S GUIDE

Ceramic Glass Cooktop  
Radiant Surface Elements  
Porcelain Enamel or  
Continuous Cleaning  
Oven Interior

---

READ AND SAVE THESE INSTRUCTIONS

## Contents

Product Registration .....	2
Versión en español .....	2
IMPORTANT SAFETY INSTRUCTIONS .....	3-4
Setting Surface Controls .....	5-6
Before Setting Oven Controls .....	7
Setting the Clock and Minute Timer .....	8
Oven Control - Bake and Broil .....	9
Oven Cleaning .....	10
General Cleaning .....	11-13
Changing Cooktop and/or Oven Lights .....	13
Avoid Service Checklist .....	14-15
Warranty.....	16

# ELECTRIC RANGE

This Owner's Guide contains general operating instructions for your range and feature information for several models. Your range **will not** have all the described features.

# Product Registration

## Register Your Product

The self-addressed **PRODUCT REGISTRATION CARD** should be filled in completely, signed and returned to Frigidaire Home Products.

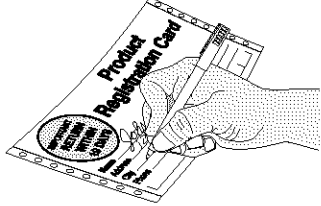

## Versión en español

Si desea obtener una copia en español de este Manual del Usuario, sírvase escribir a la dirección que se incluye a continuación. Solicite la P/N 316080290E.

Spanish Owner's Guides  
Frigidaire Home Products  
P. O. Box 360797  
Strongsville, OH 44136

Thank you for choosing this range. The information contained within this Owner's Guide will instruct you on how to properly operate and care for your range. Please read through the information contained in your literature pack to learn more about your new range.

## Record Your Model and Serial Numbers

Record in the space provided below the model and serial numbers. The serial number is found on the right side of the oven front frame for models equipped with a ceramic-glass cook top.

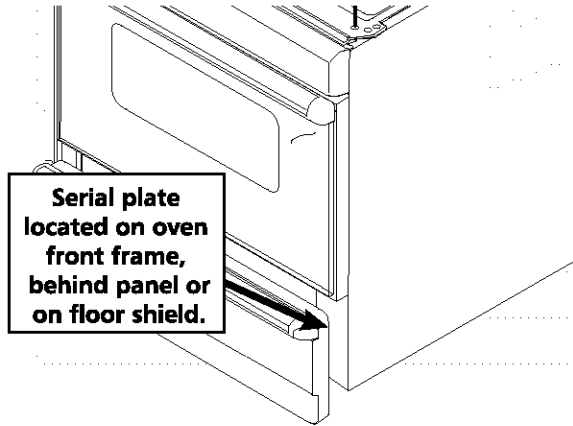

Model Number: \_\_\_\_\_

Serial Number: \_\_\_\_\_

Date of Purchase: \_\_\_\_\_

This Owner's Guide contains general operating instructions for your range and feature information for several models. Your range **may not** have all the described features. The graphics shown are representational. The graphics on your range may not look exactly like those shown.

**Note:** The instructions appearing in this Owner's Guide are not meant to cover every possible condition and situation that may occur. Common sense and caution must be practiced when installing, operating and maintaining any appliance.

# IMPORTANT SAFETY INSTRUCTIONS

Read all instructions before using this appliance.  
Save these instructions for future reference.

This guide contains important safety symbols and instructions. Please pay attention to these symbols and follow all instructions given. Here is a brief explanation of the use of these symbols.

**⚠ WARNING** This symbol will help alert you to situations that may cause serious bodily harm, death or property damage.

**⚠ CAUTION** This symbol will help alert you to situations that may cause bodily injury or property damage.

- Remove all tape and packaging before using the range. Destroy the carton and plastic bags after unpacking the range. Never allow children to play with packaging material.
- Proper Installation—Be sure your appliance is properly installed and grounded by a qualified technician in accordance with the National Electrical Code ANSI/NFPA No. 70 latest edition and local electrical code requirements. Install only per installation instructions provided in the literature package for this range. Ask your dealer to recommend a qualified technician and an authorized repair service. Know how to disconnect the power to the range at the circuit breaker or fuse box in case of an emergency.
- User servicing—Do not repair or replace any part of the appliance unless specifically recommended in the manuals. All other servicing should be done only by a qualified technician. This may reduce the risk of personal injury and damage to the range.
- Never modify or alter the construction of a range by removing leveling legs, panels, wire covers, anti-tip brackets/screws, or any other part of the product.

**⚠ CAUTION** Do not store items of interest to children in the cabinets above a range or on the backguard of a range. Children climbing on the range to reach items could be seriously injured.

**⚠ WARNING** Never Use Your Appliance for Warming or Heating the Room.

- Storage in or on Appliance—Flammable materials should not be stored in an oven, near surface units or in the storage drawer. This includes paper, plastic and cloth items, such as cookbooks, plasticware and towels, as well as flammable liquids. Do not store explosives, such as aerosol cans, on or near the range.
- Do Not Leave Children Alone—Children should not be left alone or unattended in the area where appliance is in use. They should never be allowed to sit or stand on any part of the appliance.
- DO NOT TOUCH SURFACE UNITS, AREAS NEAR THESE UNITS, HEATING ELEMENTS OR INTERIOR SURFACES OF THE OVEN. Both surface units and oven heating elements may be hot even though they are dark in color. Areas near surface units may become hot enough to cause burns. During and after use, do not touch, or let clothing or other flammable materials touch these areas until they have had sufficient time to cool. Among these areas are the cook top, surfaces facing the cook top, the oven vent openings and surfaces near these openings, oven door and window.
- Wear Proper Apparel—Loose-fitting or hanging garments should never be worn while using the appliance. Do not let clothing or other flammable materials contact hot surfaces.
- Do Not Use Water or Flour on Grease Fires—Smother the fire with a pan lid, or use baking soda, a dry chemical or foam-type extinguisher.
- When heating fat or grease, watch it closely. Fat or grease may catch fire if allowed to become too hot.
- Use Only Dry Potholders—Moist or damp potholders on hot surfaces may result in burns from steam. Do not let potholders touch hot heating elements. Do not use a towel or other bulky cloth instead of a potholder.
- Do Not Heat Unopened Food Containers—Buildup of pressure may cause container to burst and result in injury.
- Remove the oven door from any unused range if it is to be stored or discarded.

**IMPORTANT**—Do not attempt to operate the range during a power failure. If the power fails, always turn off the range. If the range is not turned off and the power resumes, the range will begin to operate again. Once the power resumes, reset the clock and oven function.

## ⚠ WARNING

- All ranges can tip.
- Injury to persons could result.
- Install anti-tip device packed with range.
- See Installation Instructions.



**⚠ WARNING** To reduce the risk of tipping, the range must be secured by properly installed anti-tip bracket provided with the range. To check if the bracket is installed properly, visually check that rear leveling leg is inserted into and fully secured by the anti-tip bracket by removing lower panel or storage drawer. Refer to the Installation Instructions for proper anti-tip bracket installation.



**⚠ WARNING** Stepping, leaning or sitting on the doors or drawers of this range can result in serious injuries and also cause damage to the range. Do not allow children to climb or play around the range. The weight of a child on an open door may cause the range to tip, resulting in serious burns or other injury.

**⚠ WARNING** Do not use the oven for storage.

# IMPORTANT SAFETY INSTRUCTIONS

## IMPORTANT INSTRUCTIONS FOR USING YOUR COOK TOP

- **Know which knob controls each surface heating unit.** Place a pan of food on the unit before turning it on, and turn the unit off before removing the pan.
- **Use Proper Pan Size**—This appliance is equipped with one or more surface units of different sizes. Select utensils having flat bottoms large enough to cover the surface unit heating element. The use of undersized utensils will expose a portion of the heating element to direct contact and may result in ignition of clothing. Proper relationship of utensil to element will also improve efficiency.
- **Utensil Handles Should Be Turned Inward and Not Extend Over Adjacent Surface Units**—To reduce the risk of burns, ignition of flammable materials, and spillage due to unintentional contact with the utensil, the handle of the utensil should be positioned so that it is turned inward, and does not extend over adjacent surface units.
- **Never Leave Surface Units Unattended at High Heat Settings**—Boilovers cause smoking and greasy spillovers that may ignite, or a pan that has boiled dry may melt.
- **Do Not Immerse or Soak Removable Heating Elements**—Heating elements should never be immersed in water. Heating elements clean themselves during normal operation.
- **Glazed Cooking Utensils**—Only certain types of glass, glass/ceramic, ceramic, earthenware, or other glazed utensils are suitable for cook top service without breaking due to the sudden change in temperature. Check the manufacturer's recommendations for cook top use.
- **When flaming foods under a ventilating hood, turn the fan on.**

## FOR CERAMIC-GLASS COOK TOP MODELS

- **Do Not Cook on Broken Cook Top**—If cook top should break, cleaning solutions and spillovers may penetrate the broken cook top and create a risk of electric shock. Contact a qualified technician immediately.
- **Clean Cook Top with Caution**—If a wet sponge or cloth is used to wipe spills on a hot cooking area, be careful to avoid a steam burn. Some cleaners can produce noxious fumes if applied to a hot surface.

## IMPORTANT INSTRUCTIONS FOR USING YOUR OVEN

- **Use Care When Opening Oven Door** —Stand to the side of the range when opening the door of a hot oven. Let hot air or steam escape before you remove or replace food in the oven.
- **Keep Oven Vent Ducts Unobstructed.** The oven vent is located under the left rear surface element if your model is equipped with coil elements. The oven vent is located below the backguard for models equipped with ceramic-glass cook tops. Touching the surfaces in this area when the oven is operating may cause severe burns. Also, do not place plastic or heat-sensitive items on or near the oven vent. These items could melt or ignite.
- **Placement of Oven Racks.** Always place oven racks in desired location while oven is cool. If rack must be moved while oven is hot use extreme caution. Use potholders and grasp the rack with both hands to reposition. Do not let potholders contact the hot heating elements in the oven. Remove all utensils from the rack before moving.
- **Do not use the broiler pan without its insert.** The broiler pan and its insert allow dripping fat to drain and be kept away from the high heat of the broiler.
- **Do not cover the broiler insert with aluminum foil. Exposed fat and grease could ignite.**
- **Protective Liners**—Do not use aluminum foil to line the oven bottom. Only use aluminum foil as recommended in this manual. Improper installation of these liners may result in risk of electric shock, or fire. Improper installation of these liners may result in risk of electric shock, or fire.

## IMPORTANT INSTRUCTIONS FOR CLEANING YOUR RANGE

- **Clean the range regularly to keep all parts free of grease that could catch fire.** Pay particular attention to the area underneath each surface element. Do not allow grease to accumulate.
- **Kitchen cleaners and aerosols**—Always follow the manufacturer's recommended directions for use. Be aware that excess residue from cleaners and aerosols may ignite causing damage and injury.
- **Clean Ventilating Hoods Frequently**—Grease should not be allowed to accumulate on the hood or filter. Follow manufacturer's instructions for cleaning.

## CONTINUOUS CLEANING OVENS

- **Do Not Use Oven Cleaners on the oven liner or any of the continuous cleaning surfaces.** Continuous cleaning surfaces can be identified by their rough surface finish.

---

## Surface Cooking for Models with a Ceramic-Glass Cook Top

**NOTE:** Please read detailed instructions for Ceramic-Glass Cooktop Cleaning in the **General Cleaning** and **Avoid Service Checklist** sections of this Use and Care Guide.

**NOTE:** Radiant elements have a limiter that allows the element to cycle on and off, even at the HI setting. This helps to prevent damage to the glass top. Cycling at the HI setting is normal and can occur if the pan is too small for the element or if the pan bottom is not flat.

### Ceramic-Glass Cooktop

The ceramic-glass cooktop has electric heating coils located below the surface of the glass. The design of the glass cooktop outlines the area of the surface unit below. Most importantly, make sure the diameter of the pan matches the diameter of the unit. Heat is transferred up through the surface of the cooktop to the cooking utensil. Only flat-bottomed pans should be used. The type and size of the cookware, number of surface units in use and the settings of the units are factors that will affect the amount of heat that will spread to areas surrounding the surface units. The areas surrounding the units may become hot enough to cause burns.

The cooktop should not be used as a cutting board or work surface in the kitchen. Dropping heavy or hard objects on the cooktop may crack it. Pans with rough bottoms may scratch the cooktop surface. Do not place foods directly on the smoothtop surface (without cooking utensils) damage to glass or difficulty in cleaning will result.

### Radiant Surface Units

The Radiant Surface Unit is a group of heating coils enclosed in a ceramic fixture below the glass cooktop. The unit temperature rises gradually and evenly. As the temperature rises, the unit will glow red. To maintain the selected setting, the unit will cycle on and off. The heating unit retains enough heat to provide a uniform and consistent heat during the off cycle. The ceramic fixture thermally insulates the heating unit, concentrating heat in the heating zone. For efficient cooking, turn off the unit several minutes before cooking is complete. This will allow residual heat to complete the cooking process. The amount of residual heat depends on the type and quality of cooking utensil, the quantity of food being cooked and the selected heat setting.

### Dual Radiant Surface Units (If equipped)

The dual radiant surface unit is made up of an inner and outer coil within the same surface unit. A control knob and rocker switch is used for operating the different coils. The smaller unit or inner coil has a lower wattage and can be used to prepare smaller quantities of food in smaller pans. The larger unit or both inner and outer coils has a higher wattage and can be used to prepare larger quantities of food in larger pans. When using the outer coil, both inner and outer coils operate.

### Indicator Light(s)

There are 2 different surface control lights that will glow on your range—a **surface indicator** and a **hot cooktop surface indicator**.

The **surface indicator**, located on the control panel, glows when any surface unit is turned on. A quick glance at the light after cooking is an easy check to be sure all surface controls are turned off.

The **hot cooktop surface indicator**, located under the glass cooktop or on the control panel, will come on as the surface cooking area heats up and will continue to glow until the glass cooktop has cooled down to a moderate level.

# Setting Surface Controls for Models with Radiant Elements

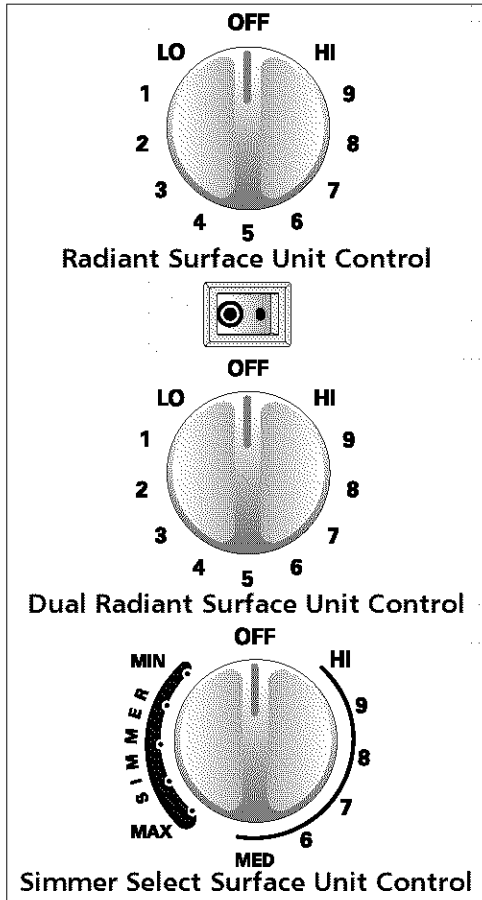

## To Operate Radiant Surface Unit

1. Place cooking utensil on the surface element.
2. Push in and turn the Surface Control knob in either direction to the desired setting. Start most cooking operations on a higher setting and then turn to a lower setting to finish cooking. The control knobs do not have to be set exactly on a particular mark. Use the marks as a guide and adjust the control knob as needed. Each surface unit provides a constant amount of heat at each setting. A glowing red surface unit extending beyond the bottom edge of the utensil indicates the utensil is too small for the unit.
3. When cooking is completed, turn the surface element off before removing the pan. Note: The surface signal light will glow when one or more elements are turned on. A quick glance at the signal light(s) when cooking is finished is an easy check to be sure all control knobs are turned off. The hot cooktop surface light will continue to glow after the control knob is turned to off and will glow until the element has cooled sufficiently.

## To Operate Dual Radiant Surface Unit (If equipped)

Set the rocker switch to the desired coil size. ● Indicates inner coil only.

⊙ Indicates both inner and outer coils operate. You may switch from either coil setting at any time during cooking. Push in and turn the Control Knob in either direction to the desired setting as instructed above.

## To Operate Simmer Select Surface Unit (If equipped)

The right side of the control knob allows you to use the Simmer Select unit as you would any normal surface unit on the medium to high settings.

The left side of the control knob is used to operate the Simmer Select feature. This feature allows the element to heat at a much lower temperature than when used as a normal surface unit. This allows you to precisely simmer delicate foods.

You may switch between normal cooking and Simmer Select at any time during the cooking process. Be sure to set the knob indicator between **MAX** and **MIN** for simmering or between **MED** and **HI** for normal cooking.

**NOTE:** The unit will not operate if the knob is positioned in the space between **MAX** and **MED**.

The suggested settings found in the chart below are based on cooking in medium-weight aluminum pans with lids. Settings may vary when using other types of pans.

### STANDARD AND DUAL RADIANT SURFACE UNITS

Setting	Type of Cooking
HIGH (HI - 9)	Start most foods, bring water to a boil, pan broiling
MEDIUM HIGH (7 - 8)	Continue a rapid boil, fry, deep fat fry
MEDIUM (5 - 6)	Maintain a slow boil, thicken sauces and gravies, steam vegetables
MEDIUM LOW (2 - 4)	Keep foods cooking, poach, stew
LOW (LO - 1)	Keep warm, melt, simmer

### SIMMER SELECT SURFACE UNIT

MAX	Larger quantities of food, stews and soups
MIN	Smaller quantities of food, delicate foods, melting chocolate or butter

**CAUTION** After turning a Radiant Surface Unit **OFF**, be careful not to touch either unit until it has had enough time to **COOL**. Surface Units will turn dark in color after they have been turned off and burns may occur if the units are touched at this time.

**CAUTION** Do not place plastic items such as salt and pepper shakers, spoon holders or plastic wrappings on top of the range when it is in use. These items could melt or ignite. Potholders, towels or wooden spoons could catch fire if placed too close to the unit.

**CAUTION** When using the Simmer Select feature the element will not glow red when it is hot.

**Note:** The size and type of utensil used, and the amount and type of food being cooked will influence the setting needed for best cooking results.

## Before Setting Oven Controls

### Oven Vent Location

For models equipped with coil surface elements, the oven vent is located **under the left rear surface element**. For models equipped with a ceramic-glass cook top the oven vent is located **below the backguard**. When the oven is on, warm air is released through the vents. This venting is necessary for proper air circulation in the oven and good baking results.

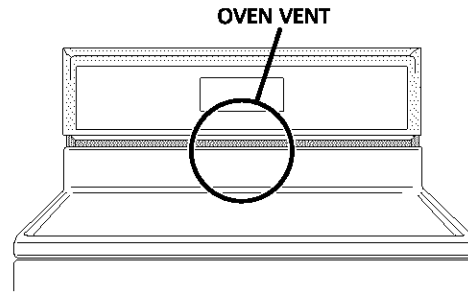

### Arranging Oven Racks

*ALWAYS ARRANGE OVEN RACKS WHEN THE OVEN IS COOL (PRIOR TO OPERATING THE OVEN).* Always use oven mitts when using the oven.

#### REMOVING & REPLACING OVEN RACKS

To **remove**, pull the rack forward until it stops. Lift up front of rack and slide out. To **replace**, fit the rack onto the guides on the oven walls. Tilt the front of the rack upward and slide the rack back into place.

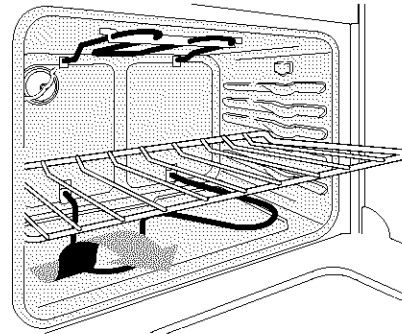

#### ARRANGING OVEN RACKS WITH 5 RACK POSITIONS

To **bake on 1 rack**, place the rack on position 3 or 4. To **bake on 2 racks**, place the racks on positions 2 and 4. Convection ranges are equipped with 3 racks and should be placed in positions 1, 3 and 4.

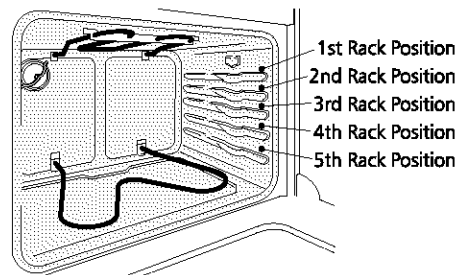

# Setting the Clock and Minute Timer



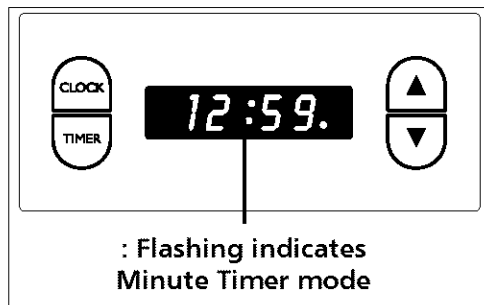

(some models)









Your model may be equipped with the clock shown below. Follow the instructions to set the clock and minute timer on your range. Not all manual clean ranges are equipped with a clock.

## To Set the Clock

When the range is first plugged in, or when the power supply to the range has been interrupted, "12:00" will flash in the display window.

1. Push .
2. Push in and hold  or  until the correct time appears in the display.  Advances time,  reverses time.

## To Set the Minute Timer

1. Push , "0:00" will appear in the display window. The timer can be set for any amount of time from 00:01 minute to 12:00 hours.
2. Push in and hold  until the correct amount of time appears in the display.  Advances time,  reverses time. The minute timer will automatically start when the button is released. The ":" will flash to indicate Minute Timer mode.
3. When the set time has passed, the control will display "0:00" and beep three times. The timer will continue to beep until  is pressed.
4. Push  to cancel the timer and return to the clock mode.



## Oven Control - Bake and Broil

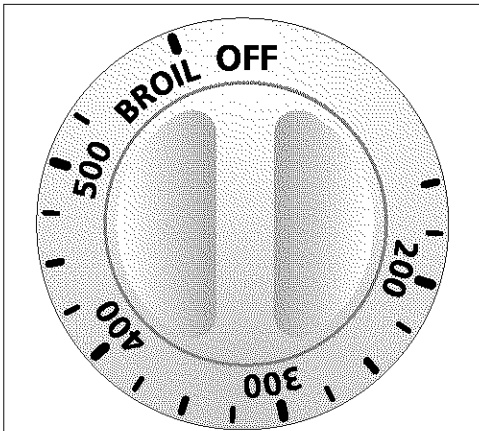

Temperature Control Knob



Selector Knob

The broiler pan and its grid allow dripping grease to drain and be kept away from the high heat of the broiler. **DO NOT** use the pan without its grid. **DO NOT** cover the grid with foil. The exposed grease could ignite.

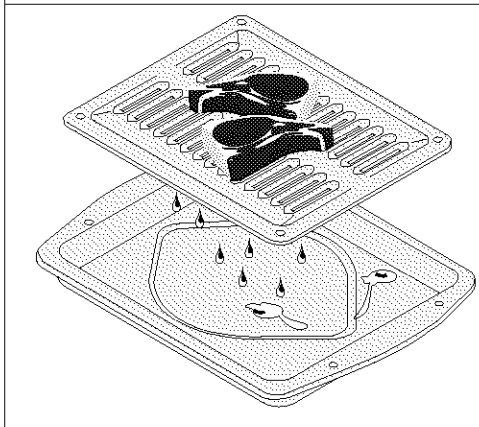

### To Bake

1. Arrange oven racks while the oven is still cool. See "Arranging Oven Racks" under **Before Setting Oven Controls**.
2. Turn the Temperature Control knob counter-clockwise to the desired temperature.
3. Turn the Selector knob (if equipped) to BAKE.
4. Preheat the oven for 10 to 12 minutes before baking. Preheating is not necessary when roasting, cooking casseroles or broiling most foods.
5. When cooking is finished, turn the Temperature Control knob to OFF.

### To Broil

1. Arrange oven rack while oven is still cool. For rare meats, position the broiler pan closer to the element (upper position). For well-done foods such as chicken, lobster tails or thick cuts of meat, position the pan further from the element (lower position).
2. Turn the Temperature Control knob counter-clockwise to Broil and the Selector Control knob to any position between HI Broil and LO Broil. Most foods can be broiled at the HI Broil Setting. Select a lower broil setting to avoid excess browning or drying of foods that should be cooked to the well-done stage. To sear rare steaks, allow the element to become red-hot—about 2 minutes—before placing food in the oven.
3. Place the grid on the broiler pan, then place the food on the grid. **DO NOT** use the broiler pan without the grid or cover the grid with aluminum foil. The exposed fat could ignite.
4. Place the pan on the oven rack. **Leave the door open at the broil stop position while broiling.** The door will stay in this position without closing.
5. Broil on one side until food is browned; turn and cook on the second side. Season and serve. **Note:** Always pull the rack out to the stop position before turning or removing food.
6. When broiling is finished, turn the Temperature Control and Selector Control knobs to OFF.

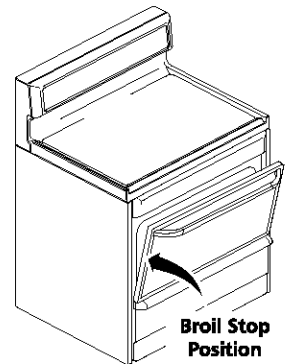

**CAUTION** Should an oven fire occur, close the oven door and turn off the oven. If the fire continues, throw baking soda on the fire or use a fire extinguisher. **DO NOT** put water or flour on the fire. Flour may be explosive.

# Oven Cleaning

## Follow these cleaning precautions:

- Allow the oven to cool before cleaning.
- Wear rubber gloves when cleaning the appliance manually.

**REMOVE SPILLOVERS AND HEAVY SOILING AS SOON AS POSSIBLE. REGULAR CLEANINGS WILL REDUCE THE NUMBER OF MAJOR CLEANINGS LATER.**

**⚠ CAUTION** Ammonia must be rinsed before operating the oven. Provide adequate ventilation.

**⚠ WARNING** DO NOT use oven cleaners, gritty cleansers, coarse abrasive pads or brushes, silicone sprays or metal scrapers on the interior walls, oven frame or ceiling of a continuous cleaning oven. Permanent damage to the oven may result.

**⚠ CAUTION** DO NOT line the oven walls, bottom, racks or any other part of the appliance with aluminum foil. Doing so will destroy heat distribution, produce poor baking results and cause permanent damage to the oven interior (aluminum foil will melt to the interior surface of the oven).

## Porcelain Enamel Oven

Porcelain has a smooth finish and is a type of glass fused to metal. Oven cleaners can be used on all interior oven surfaces.

### General Cleaning

Remove soils using hot, soapy water. Do not allow food spills with a high sugar or acid content (such as milk, tomatoes, sauerkraut, fruit juices or pie filling) to remain on the surface as they may cause a dull spot even after cleaning.

### To Remove Heavy Soil

1. Allow a dish of ammonia to sit in the oven overnight or for several hours with the oven door closed. Clean softened spots using hot, soapy water. Rinse well with water and a clean cloth.
2. If soil remains, use a soap-filled scouring pad or a nonabrasive cleaner. If necessary, use an oven cleaner following manufacturer's instructions. **DO NOT** mix ammonia with other cleaners.
3. Clean any soil from the oven frame, the door liner outside the oven door gasket and the small area at the front center of the oven bottom. Clean with hot, soapy water. Rinse well using clean water and a cloth.

### Adhere to the following precautions when using oven cleaners:

1. **DO NOT** spray on the electrical controls or switches because it could cause a short circuit and result in sparking or fire.
2. **DO NOT** allow a film from the cleaner to build up on the temperature sensing bulb; it could cause the oven to heat improperly. (The bulb is located in the rear of the oven.) Carefully wipe the bulb clean after each oven cleaning, being careful not to move the bulb. A change in its position could affect how the oven bakes. Avoid bending the bulb and capillary tube.
3. **DO NOT** spray any cleaner on the oven door trim or gasket, broiler drawer glides, handles or any exterior surfaces of the range, plastic or painted surfaces. The cleaner can damage these surfaces.

### Continuous Cleaning Oven (some models)

Continuous cleaning ovens have a special coating which is a porous ceramic material. This rough coating tends to prevent grease spatters from forming little beads which run down the side walls leaving streaks that require hand cleaning. Instead, when spatter hits the porous coating, it disperses and is partially absorbed. This spreading action increases the exposure of oven soil to heated air, making it less noticeable.

*Soil may not disappear completely. Remaining soil will gradually fade with continued oven use. The special coating works best on small amounts of spatter. Larger spills, or spills generating from sugar, egg and dairy mixtures, do not clean as well.*

### If difficult soils occur:

1. Remove the oven racks and cookware.
2. Remove soils by completing steps a or b below:
  - a) Use hot, soapy water and wash soils using a nylon-bristly brush or a nylon mesh scouring pad. **DO NOT** rub or scrub with paper towels, cloths or sponges. They will leave lint on the oven coating.
  - b) Apply ammonia with a sponge and dab it into the porous coating. Leave the ammonia on the soiled area for 30 minutes.
3. Rinse with clear water.
4. Close the oven door and push in and turn the Temperature Control knob to 450°F (230°C).
5. Operate oven for 15 minutes.
6. Remaining soil will fade with continued oven use.

## General Cleaning

### Cleaning Various Parts of Your Range

Before cleaning any part of the range, be sure all controls are turned OFF and the range is cool. Remove spillovers and heavy soiling as soon as possible. Regular cleanings will reduce the effort required for major cleanings later.

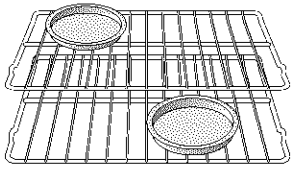
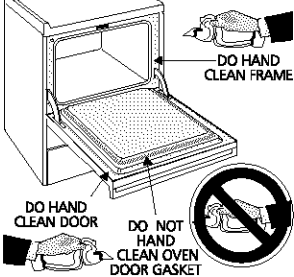
Surfaces	How to Clean
Aluminum (Trim Pieces) & Vinyl	Use hot, soapy water and a cloth. Dry with a clean cloth.
Glass, Painted and Plastic Control Knobs, Body Sides, and Decorative Trim	<i>For general cleaning</i> , use hot, soapy water and a cloth. <i>For more difficult soils and built-up grease</i> , apply a liquid detergent directly onto the soil. Leave on soil for 30 to 60 minutes. Rinse with a damp cloth and dry. <b>DO NOT</b> use abrasive cleaners on any of these materials; they can scratch. To remove control knobs, turn to the OFF position; grasp firmly and pull straight off the shaft. To replace knobs after cleaning, line up the flat sides of both the knob and the shaft; then push the knob into place.
Stainless Steel, Chrome Control Panel, Decorative Trim	<i>Before cleaning the control panel</i> , turn all controls to OFF and remove the control knobs. To remove, pull each knob straight off the shaft. Clean using hot, soapy water and a dishcloth. Rinse with a clean water and a dishcloth. Cover stubborn spots with an ammonia-soaked paper towel for 30 to 40 minutes. Rinse. Be sure to squeeze excess water from the cloth before wiping the panel; especially when wiping around the controls. Excess water in or around the controls may cause damage to the appliance. Cleaners made especially for stainless steel such as Stainless Steel Magic, trademark of Magic American Corp., or similar products are recommended. Always follow the manufacturer's instructions. Be sure to rinse the cleaners as bluish stains may occur during heating and cannot be removed. To replace knobs after cleaning, line up the flat sides of both the knob and the shaft; then push the knob into place.
Porcelain Enamel Broiler Pan and Insert, Door Liner	Gentle scouring with a soapy scouring pad will remove most spots. Rinse with a 1:1 solution of clear water and ammonia. <i>If necessary</i> , cover difficult spots with an ammonia-soaked paper towel for 30 to 40 minutes. Rinse with clean water and a damp cloth, and then scrub with a soap-filled scouring pad. Rinse and wipe dry with a clean cloth. Remove all cleaners or the porcelain may become damaged during future heating. <b>DO NOT</b> use spray oven cleaners on the cooktop.
Oven Racks 	Oven racks may be removed or left in the oven during the self-clean cycle for cleaning. If removed, clean by using a mild, abrasive cleaner following manufacturer's instructions. Rinse with clean water and dry.  If the racks are cleaned in the self-clean cycle, their color will turn slightly blue and the finish will be dull. After the self-clean cycle is complete, and the oven has cooled, rub the sides of the racks with wax paper or a cloth containing a small amount of baby oil or salad oil (this will make the racks glide easier into the rack positions).
Oven Door 	To clean oven door, wash with hot, soapy water and a clean cloth. <b>DO NOT</b> immerse the door in water.  <b>DO NOT</b> clean the oven door gasket. The oven door gasket is made of a silicone rubber material, on non self cleaning models, which is essential for a good seal. Care should be taken not to rub, damage or remove the gasket.

## General Cleaning - Ceramic Glass Cooktop

**⚠ WARNING** DO NOT use a cooktop cleaner on a hot cooktop. The fumes can be hazardous to your health, and can chemically damage the ceramic-glass surface.

**⚠ CAUTION** Before cleaning the cooktop, be sure the controls are turned to OFF and the cooktop is COOL.

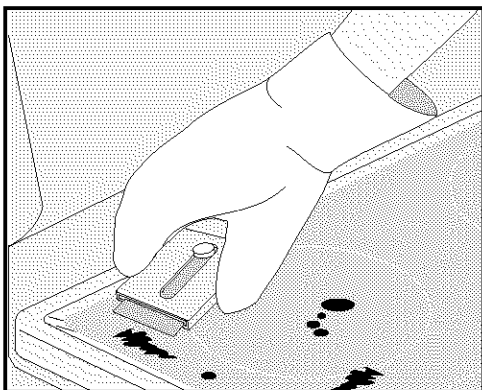

## Ceramic-Glass Cooktop Cleaning

Correct and consistent cleaning is essential to maintaining your ceramic-glass cooktop. If food spills, grease spatters and metal rub-off from aluminum cookware are not removed, they may be burned onto the surface of the cooktop and cause permanent discoloration.

### Daily Cleaning

For normal soil:

1. Allow cooktop surface to cool.
2. Wipe up spills and spatters using a clean paper towel. Always use a new, clean paper towel when cleaning the ceramic-glass cooktop.
3. Rub a few drops of a recommended ceramic-glass cooktop cleaning cream onto soiled area using a clean, damp paper towel. Buff with a dry paper towel until all soil and cream are removed. Frequent cleaning leaves a protective coating of silicone which helps in preventing scratches and abrasions. Clean surface with the cooktop cleaning cream after each use.
4. Rinse with another clean damp, paper towel. Buff dry with a dry paper towel.

For heavy, burned-on soil:

1. Allow cooktop surface to cool.
2. Carefully scrape soil with a metal razor blade scraper. Hold razor blade scraper at a 30° angle to the cooktop.
3. Remove loosened soil with a clean paper towel.
4. Apply cooktop cleaning cream as described for normal soil.
5. If any soil remains, repeat the steps listed above. After all soil has been removed, polish the entire surface with the cooktop cleaning cream.

For sugary spillovers:

Sugary spills can cause pitting of your cooktop surface. Therefore, you must begin cleaning the spills while the cooktop is still hot. Use caution when following the steps below.

1. Turn off all surface units and remove all pans immediately.
2. Wearing an oven mitt, use a razor blade scraper to scrape the hot spill out of the cooking zone to a cooler area on the cooktop.
3. Allow the cooktop to cool.
4. Follow the instructions above for heavy, burned-on soil.

DO NOT use the following on the ceramic-glass cooktop:

- Abrasive plastic, nylon, metal scouring or cloth pads. They may scratch the cooktop and make it more difficult to clean later.
- Sponges, cloths or dish towels. Lint or soil remaining on the cooktop from a cloth or sponge can burn and cause discoloration.
- Anything that may melt (plastics, aluminum foil).
- Cleansers other than a recommended ceramic-glass cooktop cleaning cream.
- Chlorine bleach, ammonia, hydrofluoric acid, chemical oven cleaners or any other kind of chemical cleaner. They may etch or discolor the cooktop.

## General Cleaning

**CAUTION** The door is heavy. For safe, temporary storage, lay the door flat with the inside of the door facing down.

### To Remove and Replace Oven Door

To Remove Oven Door:

1. Open the door.
2. Remove screws located on the inside of the oven door near the hinges **A** (one on each side.)
3. Close the door to the quarter-open position. Grasp the door firmly on both sides and lift up and off the hinges.
4. To clean oven door, follow the instructions provided in the cleaning chart under **General Cleaning**

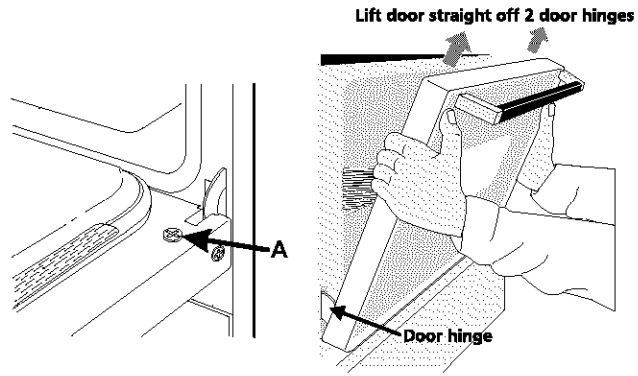

To Replace Oven Door:

1. Be sure the hinge arms are in the quarter-open position. Be careful if pulling the hinges open by hand. The hinges may snap back against the oven frame and could pinch fingers.
2. Hold the door at the sides near the top. Insert the hinge arms into slots at the bottom of the door.
3. Hinge arms must go into the range slots evenly. The hinge arms should be inserted into the bottom corners of the door as far as they can go.
4. If the door is not in line with the oven frame, remove it and repeat the above steps.

## Changing Cooktop and/or Oven Lights (if equipped)

**CAUTION** Be sure the range is unplugged and all parts are COOL before replacing the surface or oven lights. Wear a leather-faced glove for protection against possible broken glass.

### To Change the Oven Light (some manual clean models)

On some models, the oven light automatically turns on when the door is opened. Some models have a switch located on the control panel to turn on the light. The oven light is located at the rear of the oven.

To replace the oven light:

1. Turn electrical power off at the main source or unplug the range.
2. Replace bulb with a new 40 watt appliance bulb.
3. Turn power back on again at the main source (or plug the range back in).
4. The clock (if equipped) will then need to be reset. To reset, see **Setting the Clock and Minute Timer** in this Owner's Guide.

### To Change the Cooktop Light (some models)

1. Turn power off at the main source or unplug the range.
2. Remove Phillips® Head screws (2) that secure the light cover and then lift the light cover off.
3. Remove bulb by rolling back and up. Install the new bulb by sliding down and rolling forward into place.
4. Re-install light cover and secure with Phillips® Head screws (2).

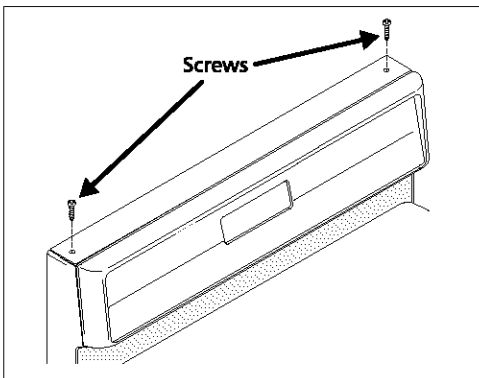

---

## Avoid Service Checklist

*Before you call for service, review this list. It may save you time and expense. The list includes common occurrences that are not the result of defective workmanship or materials in this appliance.*

### OCCURRENCE

### POSSIBLE CAUSE/SOLUTION

Range is not level.

Poor installation. Place oven rack in center of oven. Place a level on the oven rack. Adjust leveling legs at base of range until the oven rack is level.

Be sure floor is level and is strong and stable enough to adequately support range.

If floor is sagging or sloping, contact a carpenter to correct the situation.

Kitchen cabinet alignment may make range appear unlevel. Be sure cabinets are square and have sufficient room for range clearance.

Cannot move appliance easily. Appliance must be accessible for service.

Cabinets not square or are built in too tightly. Contact builder or installer to make appliance accessible.

Carpet interferes with range. Provide sufficient space so range can be lifted over carpet.

Surface element too hot or not hot enough.

Incorrect control setting. Make sure the correct control is on for the surface element to be used.

Lightweight or warped pans used. Use only flat, evenly balanced, medium or heavyweight cookware. Flat pans heat better than warped pans. Cookware materials and weight of the material affect heating. Heavy- and medium-weight pans heat evenly. Because lightweight pans heat unevenly, foods may burn easily.

Surface element does not heat.

No power to the appliance. Check steps under "Entire Appliance Does Not Operate" in this **Avoid Service Checklist**.

Incorrect control setting. Make sure the correct control is on for the surface element to be used.

Element not making contact in block. Follow instructions under "Surface Elements and Drip Bowls" in the **General Cleaning** section.

Entire appliance does not operate.

Make sure cord/plug is plugged tightly into outlet.

Service wiring is not complete. Contact your dealer, installing agent or authorized servicer.

Power outage. Check house lights to be sure. Call your local electric company for service.

Cooktop and/or oven light (some models) does not work.

Replace or tighten bulb. See **Changing Cooktop and/or Oven Lights (some models)** in this Owner's Guide for instructions.

Oven smokes excessively during broiling.

Control(s) not set properly. Follow instructions under **Setting Oven Controls**.

Make sure oven door is opened to **broil stop position**.

Meat too close to the element. Reposition the rack to provide proper clearance between the meat and the element. Preheat broil element for searing.

Meat not properly prepared. Remove excess fat from meat. Cut remaining fatty edges to prevent curling, but do not cut into lean.

Grid on broiler pan wrong side up and grease not draining. Always place grid on the broiler pan with ribs up and slots down to allow grease to drip into pan.

Grease has built up on oven surfaces. Regular cleaning is necessary when broiling frequently. Old grease or food spatters cause excessive smoking.

Poor baking results.	Many factors affect baking results. Make sure the proper rack position is used. Center food in the oven and space pans to allow air to circulate. Allow the oven to preheat to the set temperature before placing food in the oven. Try adjusting the recipe's recommended temperature or baking time.
Drip bowls are pitting or rusting. Coil Element Models	Foods with acids, such as tomatoes, if allowed to stand in/on bowls will cause corrosion. Remove and wash drip bowls as soon as possible after a spillover Normal environment. Houses along sea coast are exposed to salt air. Protect bowls as much as possible from direct exposure to salt air.
Drip bowls turning color or distorted. Coil Element Models	Bottom surface of cookware extends beyond surface elements and touches cooktop surface. This can cause high enough temperatures to discolor the drip bowls. <b>DO NOT</b> use cookware of this type. Pan sizes should be matched to the size of the element. Replacement drip bowls may be purchased from your dealer.
Scratches or abrasions on cooktop surface. Ceramic Glass Cooktop Models	Coarse particles such as salt or sand between cooktop and utensils can cause scratches. Be sure cooktop surface and bottoms of utensils are clean before usage. Small scratches do not affect cooking and will become less visible with time. Cleaning materials not recommended for ceramic-glass cooktop have been used. See "Ceramic-Glass Cooktop Cleaning" in the <b>General Cleaning</b> section. Cookware with rough bottom has been used. Use smooth, flat-bottomed cookware.
Metal marks. Ceramic Glass Cooktop Models	Sliding or scraping of metal utensils on cooktop surface. Do not slide metal utensils on cooktop surface. Use a ceramic-glass cooktop cleaning creme to remove the marks. See "Ceramic-Glass Cooktop Cleaning" in the <b>General Cleaning</b> section.
Brown streaks or specks. Ceramic Glass Cooktop Models	Boilovers are cooked onto surface. Use razor blade scraper to remove soil. See "Ceramic-Glass Cooktop Cleaning" in the <b>General Cleaning</b> section.
Areas of discoloration with metallic sheen. Ceramic Glass Cooktop Models	Mineral deposits from water and food. Remove using a ceramic-glass cooktop cleaning creme. Use cookware with clean, dry bottoms.

# RANGE WARRANTY

Your range is protected by this warranty

	WARRANTY PERIOD	THROUGH OUR AUTHORIZED SERVICERS, WE WILL:	THE CONSUMER WILL BE RESPONSIBLE FOR:
<b>FULL ONE-YEAR WARRANTY</b>	One year from original purchase date.	Pay all costs for repairing or replacing any parts of this appliance which prove to be defective in materials or workmanship.	Costs of service calls that are listed under <b>NORMAL RESPONSIBILITIES OF THE CONSUMER.*</b>
<b>LIMITED 2ND-5TH YEAR WARRANTY (Glass Smoothtop, Seal &amp; Elements)</b>	Second through fifth years from original purchase date.	Provide a replacement for any defective surface heating element, deteriorated rubberized-silicone seal (upswept models only), or glass smoothtop that cracks due to thermal breakage (not customer abuse).	Diagnostic costs and any transportation and labor costs which are required because of service.
<b>LIMITED WARRANTY (Applicable to the State of Alaska)</b>	Time periods listed above.	All of the provisions of the full and limited warranties above and the exclusions listed below apply.	Costs of the technician's travel to the home and any costs for pick up and delivery of the appliance required because of service.

In the U.S.A., your appliance is warranted by Electrolux Home Products North America, a division of White Consolidated Industries, Inc. We authorize no person to change or add to any of our obligations under this warranty. Our obligations for service and parts under this warranty must be performed by us or an authorized Electrolux Home Products North America servicer. In Canada, your appliance is warranted by WCI Canada, Inc.

## \*NORMAL RESPONSIBILITIES OF THE CONSUMER

This warranty applies only to products in ordinary household use, and the consumer is responsible for the items listed below:

1. Proper use of the appliance in accordance with instructions provided with the product.
2. Proper installation by an authorized servicer in accordance with instructions provided with the appliance and in accordance with all local plumbing, electrical and/or gas codes.
3. Proper connection to a grounded power supply of sufficient voltage, replacement of blown fuses, repair of loose connections or defects in house wiring.
4. Expenses for making the appliance accessible for servicing, such as removal of trim, cupboards, shelves, etc., which are not a part of the appliance when it was shipped from the factory.
5. Damages to finish after installation.
6. Replacement of light bulbs and/or fluorescent tubes (on models with these features).

## EXCLUSIONS

This warranty does not cover the following:

1. CONSEQUENTIAL OR INCIDENTAL DAMAGES SUCH AS PROPERTY DAMAGE AND INCIDENTAL EXPENSES RESULTING FROM ANY BREACH OF THIS WRITTEN OR ANY IMPLIED WARRANTY.  
**NOTE:** Some states do not allow the exclusion or limitation of incidental or consequential damages, so this limitation or exclusion may not apply to you.
2. Service calls which do not involve malfunction or defects in workmanship or material, or for appliances not in ordinary household use. The consumer shall pay for such service calls.
3. Damages caused by services performed by servicers other than Electrolux Home Products North America or its authorized servicers; use of parts other than genuine Electrolux Home Products parts; obtained from persons other than such servicers; or external causes such as abuse, misuse, inadequate power supply or acts of God.
4. Products with original serial numbers that have been removed or altered and cannot be readily determined.

## IF YOU NEED SERVICE

Keep your bill of sale, delivery slip, or some other appropriate payment record. The date on the bill establishes the warranty period should service be required. If service is performed, it is in your best interest to obtain and keep all receipts. This written warranty gives you specific legal rights. You may also have other rights that vary from state to state. Service under this warranty must be obtained by contacting Electrolux Home Products:

This warranty only applies in the 50 states of the U.S.A., Puerto Rico, and Canada. Product features or specifications as described or illustrated are subject to change without notice. All warranties are made by Electrolux Home Products North America, a division of White Consolidated Industries, Inc. In Canada, your appliance is warranted by WCI Canada, Inc.

03-U-RA-01 (rev. 01/2001)

## USA

800•944•9044

Electrolux Home Products North America  
P.O. Box 212378  
Augusta, GA 30917

## Canada

866•213•9397 (English)

866•294•9911 (French)

Electrolux Home Products North America  
6150 McLaughlin Road  
Mississauga, Ontario, Canada  
L5R 4C2