

# USER'S GUIDE

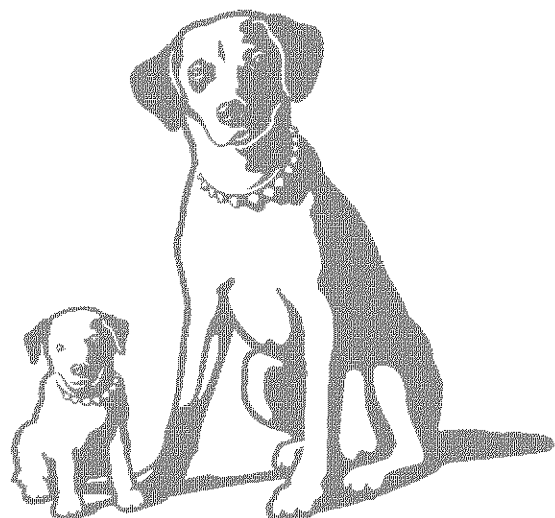

TV/VCR COMBINATION

**TRENT**

# Important Information

## WARNING

To reduce the risk of fire or shock hazard, do not expose this product to rain or moisture.

## WARNING

RISK OF ELECTRIC SHOCK  
DO NOT OPEN

TO REDUCE THE RISK OF ELECTRIC SHOCK, DO NOT REMOVE COVER (OR BACK). NO USER SERVICEABLE PARTS INSIDE. REFER SERVICING TO QUALIFIED SERVICE PERSONNEL.



This symbol indicates "dangerous voltage" inside the product that presents a risk of electric shock or personal injury.



This symbol indicates important instructions accompanying the product.

## Cautions

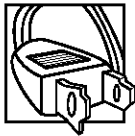

**CAUTION:** To prevent electric shock, match wide blade of plug to wide slot, fully insert.

**ATTENTION:** Pour éviter les chocs électriques, introduire la lame la plus large de la fiche dans la borne correspondante de la prise et pousser jusqu'au fond.

FCC regulations state that unauthorized changes or modifications to this equipment may void the user's authority to operate it.

Refer to the identification/rating label on the back of the product for the proper operating voltage.

If fixed(non-moving) images are left on the screen for long periods, they may be permanently imprinted on the screen. Such images include network logos, phone numbers, and video games. This damage is not covered by your warranty. Extended viewing of channels displaying these images should be avoided.

## Note to Cable TV Installer

This reminder is provided to call your attention to Article 820-40 of the National Electrical Code (Section 54 of the Canadian Electrical Code, Part 1) which provides guidelines for proper grounding and, in particular, specifies that the cable ground shall be connected to the grounding system of the building as close to the point of cable entry as practical.

## Product Registration

Please fill out the product registration card and return it immediately. Returning this card allows us to contact you if necessary.

Keep your sales receipt to obtain warranty parts and service and for proof of purchase. Attach it here and record the serial and model numbers in case you need them. The numbers are located on the back of the product.

Model No. \_\_\_\_\_

Serial No. \_\_\_\_\_

Purchase Date: \_\_\_\_\_

Dealer/Address/Phone: \_\_\_\_\_

\_\_\_\_\_  
\_\_\_\_\_

# Table of Contents

## Important Information

Warning .....	i
Cautions .....	i
Note to Cable TV Installer .....	i
Product Registration .....	i

## Setting Up the TV/VCR

Startup	
Check Accessories With TV/VCR .....	2
Insert Batteries in Remote .....	3
Place Your TV/VCR on a	
Stable Surface .....	3
Connect Antenna or Cable-TV	
System .....	3
(Optional) Connect DC/AC	
Power Invertor .....	3
Turn On the TV/VCR .....	3
Put Channels into Memory	
(Auto Channel Search) .....	3
Set the Signal Type (optional) .....	4
Add or Remove Channels from	
TV/VCR's Memory .....	4
Set the Time and Date (Clock) .....	4
Select the Language. (Escoge	
una Lengua.) .....	5
Select a Channel and Adjust	
the Volume .....	5

## Mobile TV/VCR Usage

DC/AC Power Invertor .....	6
----------------------------	---

## Using the Remote Control

Buttons .....	7-8
---------------	-----

## TV/VCR Features

Using the TV/VCR Features	
On-Screen Displays .....	9
Adjust the Picture .....	9
Closed Captioning .....	10
Commercial Skip .....	10
Wake-Up Timer .....	11
Sleep Timer .....	11

## Playing a Tape

Operating Instructions .....	12
Using the Playback Features	

Pause .....	13
Frame Advance .....	13
Picture Search .....	13
Automatic Tracking .....	14
Manual Tracking .....	14
Time Counter .....	14
Commercial Scan .....	14
Auto Play Feature .....	15
Auto Repeat Feature .....	15
Index Search .....	16
Zero Search .....	17
Blank Search .....	17

## Recording a Program

Recording Features	
Recording Speeds .....	18
Recording Pause .....	18
Automatic Head Cleaner .....	18
Child Lock .....	18
Types of Recordings	
Basic Recording .....	19
Express Recording .....	20
Timer Recording	
Setting a Timer Recording .....	21
Checking or Clearing Timer	
Recordings .....	22
Stopping a Timer Recording .....	23
Copying and Editing Tapes .....	23

## Location of Controls

Front Panel .....	24
Back Panel .....	25

## Hooking Up the TV/VCR

Choosing a Hookup .....	25
Connect Supplied Antenna, Antenna or	
Cable System Without a Cable Box .....	26
Connect a Cable System With Cable Box .....	27
Connect VCR or Camcorder	
for Copying Tapes .....	28

## References

Trouble Checks .....	29-30
Cleaning the TV/VCR .....	31
Specifications .....	31
Limited Warranty .....	32
Notes .....	33

# Startup

## 1. Check accessories with TV/VCR combination.

Contact your dealer if any items are missing.

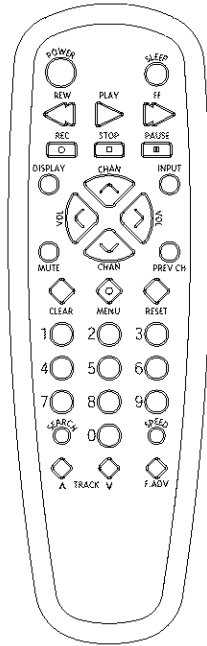

**Remote**  
(Stock No. 221371))

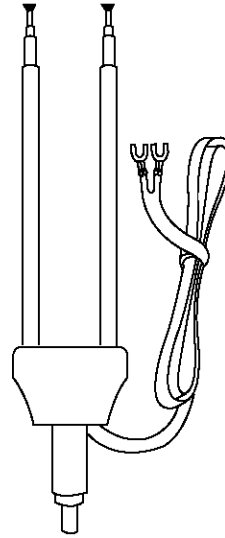

**VHF/UHF Dipole Antenna**  
(Stock No. 220689)

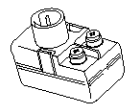

**Antenna Adapter**  
(300-75 Ohm)  
(Stock No. 193983)

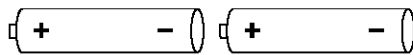

**2 "AAA" Batteries**

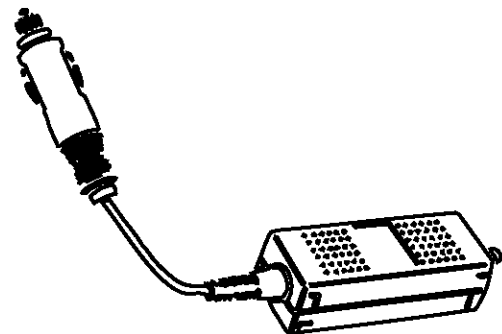

**DC/AC Power Invertor**

## Startup

### 2. Insert batteries in remote.

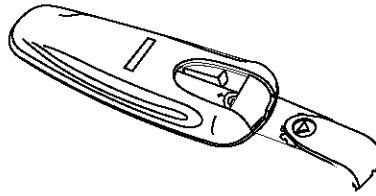

### 3. Place your TV/VCR on a stable surface.

CAUTION: To reduce the risk of personal injury or damage to the TV/VCR, take care in selecting a surface or stand on which to place your product and when moving or carrying it. Use a stable surface or a strong steady stand and a location where the TV/VCR cannot be tipped over or easily pulled off, particularly by children. Do not attempt to carry or move this product with one hand. If hand grips are located in the top, grasp the TV/VCR with both hands with the TV front against your body to prevent it from slipping out of your grasp.

### 4. (Optional) Connect DC/AC Power Invertor.

To power your TV/VCR from the cigarette lighter socket of a car, truck, RV or boat, connect the supplied DC/AC Power Invertor. *Details on page 6.*

### 5. Connect antenna or cable-TV system.

Connect the supplied dipole antenna, a different home antenna, or a cable-TV system. *Details on pages 24-26.*

### 6. Turn on the TV/VCR.

Press POWER on the TV/VCR or remote. The indicator in the POWER button on the front of the TV/VCR will light.

### 7. Put Channels into Memory (Auto Channel Search)

- A. Press MENU on the remote to display the TV/VCR MAIN MENU.
- B. Press 5 to display the SETUP menu.
- C. Press 1 to display the AUTO CHANNEL SEARCH menu.
- D. Allow the TV/VCR to search for all channels. Pressing any buttons during the Auto Channel Search will stop the search and only some channels will be in the TV/VCR's memory. When the search is finished the TV/VCR will automatically tune to the first channel in its list.

## Startup

### 8. Set the Signal Type (optional).

The TV/VCR automatically selects the signal type (cable or antenna) when you auto channel search in step 6. If you want to change the signal type, follow the directions below.

- Press MENU on the remote to display the TV/VCR MAIN MENU.
- Press 5 to display the SETUP menu.
- Press 5 to change the Signal Type.

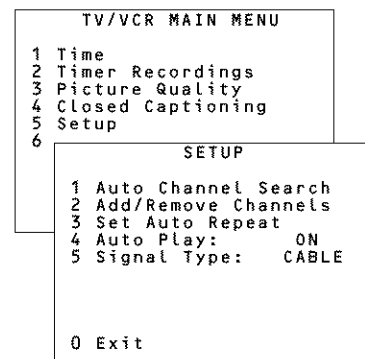

### 9. Add or remove channels from the TV/VCR's memory.

You may want to add or remove channels if some of them are not active, have weak signals, or you do not want them in your channel memory. A channel that has been removed can still be selected by pressing number buttons.

- Press MENU on the remote to display the TV/VCR MAIN MENU.
- Press 5 to display the SETUP menu.
- Press 2 to display the ADD/REMOVE CHANNELS screen.
- Follow the directions on the screen to add or remove a channel.
- Add or remove more channels by entering the channel number or pressing CHANNEL up or down.

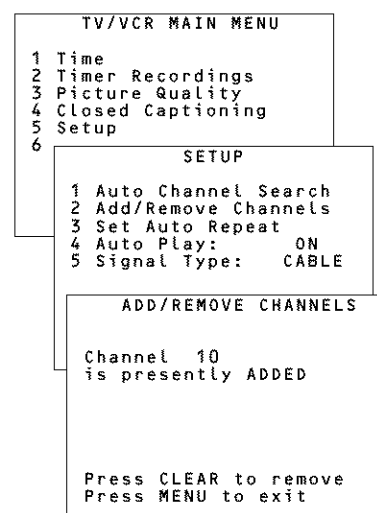

### 10. Set the Time and Date (Clock).

- Press MENU on the remote to display the TV/VCR MAIN MENU.
- Press 1 to display the TIME menu.
- Press 1 to display the SET TIME AND DATE screen.
- Use the number buttons on the remote to enter the time including AM or PM, month, day, and year. The day of the week will automatically appear after you enter the year.
  - Press 0 before single-digit numbers. Press 1 for AM or 2 for PM. Example: press 0, then 5, then 0, then 7, then 2 for a time of 5:07 PM.
  - Press CLEAR on the remote at any time to change incorrect entries.
- Press MENU on the remote to start the clock.
- Press MENU or 0 twice to exit and return to TV viewing. To display the time and date, press DISPLAY on the remote.

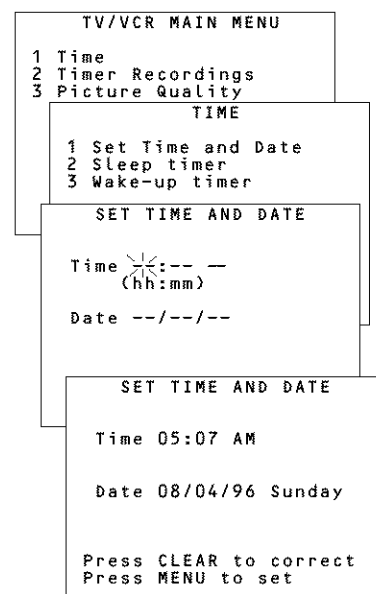

# Startup

## 11. Select the language. (Escoge una lengua.)

This feature lets you select English or Spanish as the language for the menu screens on the TV/VCR.

- A. Press MENU on remote to see the TV/VCR MAIN MENU.
- B. Press 6 to display the LANGUAGE/IDIOMA/LANGUE menu. The bullet (•) indicates the language selected.
- C. Press 1 to display the menu screens in English.  
Press 2 to display the menu screens in Spanish.  
Press 3 to display the menu screens in French.

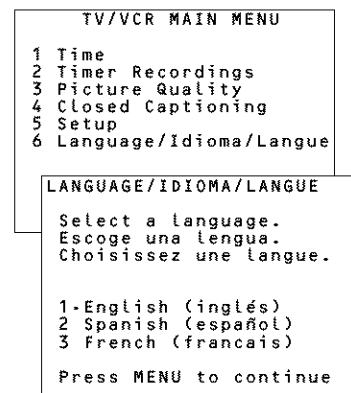

## 12. Select a channel and adjust the volume.

- A. Press CHANNEL up or down or two number buttons on the remote to select a channel.  
  
Example: Press 0 then 2 for channel 2. The channel number is displayed.  
  
For cable channels over 99, press and hold 1 until 1- appears. Then press two more numbers. Example: Press and hold 1, then press 0, then press 2, for channel 102.
- B. Press VOLUME up or down to adjust the volume. The volume display appears.

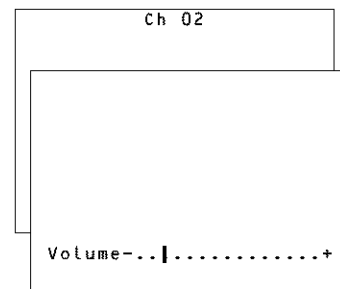

## **DC/AC Power Invertor**

### **Using the DC/AC Power Invertor**

To power you TV/VCR from the cigarette lighter socket of a car, truck, RV or boat, you use the provided DC/AC Power Invertor *shown on page 2*.

The DC/AC Power Invertor is especially designed to convert power from a 12-volt battery to the AC power cord of the TV/VCR.

**Caution:** The DC/AC Power Invertor is designed to be used only with vehicles having 12-volt negative ground electrical systems.

**Caution:** To avoid accidents keep TV/VCR out of driver's view when car is in motion.

**Warning:** To avoid possible damage to your TV/VCR, use only the DC/AC Power Invertor provided.

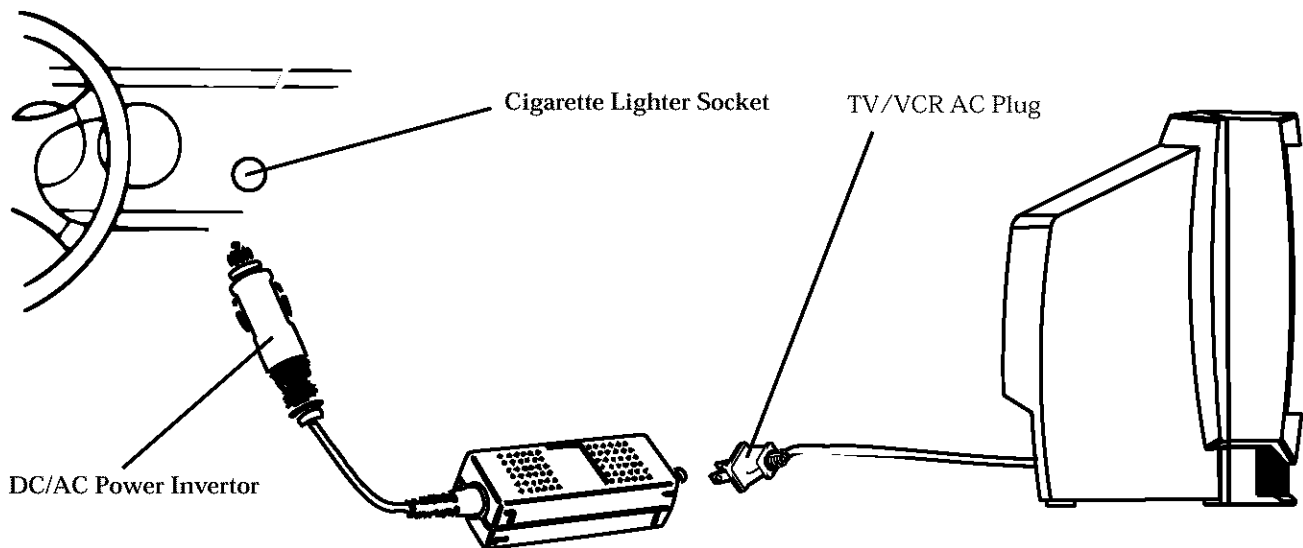

1. Insert the DC/AC Power Invertor's plug into the vehicle's cigarette lighter socket.
2. Insert the TV/VCR AC power plug into the DC/AC Power Invertor AC socket.
3. Place the DC/AC Power Invertor's ON/OFF switch into the ON position.
4. Press the TV/VCR POWER button.



# Buttons

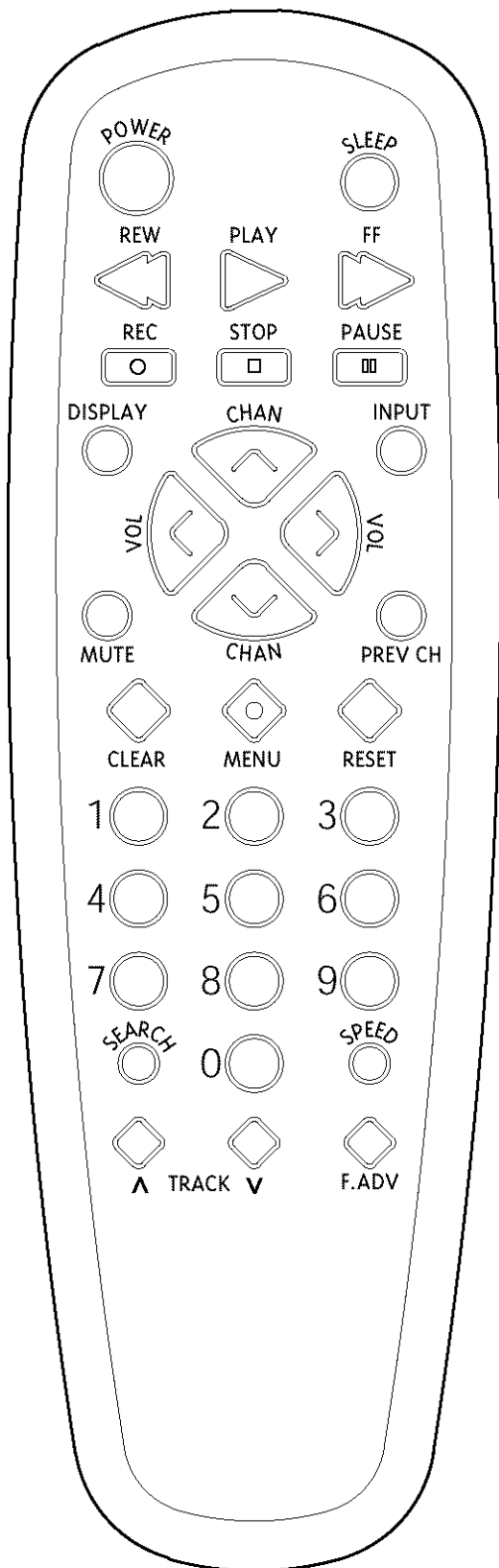

### CHAN $\wedge$ and $\vee$ (Channel up and down)

Selects next higher or lower channel in channel memory.

### CLEAR

Allows you to change menu entries or clear a timer recording.

Resets time counter to 0:00:00 when it is displayed.

### DISPLAY

Displays TV/VCR's current status.

Displays time counter when a tape is inserted.

Removes displays.

Advances to next program during program review.

### F.ADV (Frame Advance)

Fast forwards the tape through a commercial when a tape is playing.

Advances the tape one video frame at a time when the tape is in PAUSE mode.

### FF (Fast Forward)

Fast forwards the tape when the TV/VCR is stopped.

Searches the picture in forward motion during playback.

### INPUT

Switches between signals from the AUDIO and VIDEO INPUT jacks on the front, AUDIO and VIDEO INPUT jacks on the back, and TV signal.

### MENU

Displays the TV/VCR MAIN MENU.

### MUTE

Turns sound on or off.

## Buttons

### Numbers (0 through 9)

Select a channel up to 99 by pressing two numbers.

Select a cable channel over 99 by pressing and holding 1 until 1-- appears on the screen. Then press the other two numbers.

### PAUSE

Pauses the tape during playback.

Pauses recording to prevent recording of unwanted scenes.

### PLAY

Plays a tape.

### POWER

Turns TV/VCR on or off.

### PREV CH (Previous channel)

Switches between the last two channels.

Select one channel and then select the other using the number buttons. Press PREV CH to switch between the two channels.

### REC (Record)

Starts TV/VCR recording.

Used for express recording.

### RESET

Resets video functions to factory settings.

Used to reset time for wake-up timer (alarm).

### REW (Rewind)

Rewinds the tape when the TV/VCR is stopped.

Searches the picture in reverse motion during playback.

### SEARCH

Operates Commercial Skip during TV viewing.

Displays INDEX, ZERO, and BLANK search screens when tape is inserted in the TV/VCR.

Operates Commercial Scan by advancing tape 60 seconds during playback.

### SLEEP

Sets TV/VCR to automatically turn off in 30, 60, 90, or 120 minutes. *See page 10.*

### SPEED (Tape Speed)

Selects a recording speed (SLP, SP, or LP).

### STOP

Stops functions such as record, play, rewind, fast forward, and pause.

### TRACK ^ and v (Tracking up and down)

Lets you manually reduce the streaks that may appear in the picture during playback.

### VOL < and > (Volume up and down)

Raises and lowers sound.

# Using the TV/VCR Features

## On-Screen Displays

When you change channels, adjust volume, or use a VCR feature, on-screen displays appear to let you know the status of the TV/VCR.

### To Call Up On-Screen Displays

1. Press DISPLAY to display the function, time counter, date, time, and tape speed.  
If you do not press DISPLAY again, these displays will time out.
2. Press DISPLAY again:
  - **No tape in TV/VCR:** Displays removed.
  - **Tape in TV/VCR:** Time counter remains on screen. Will not time out. Press DISPLAY again to remove the time counter.

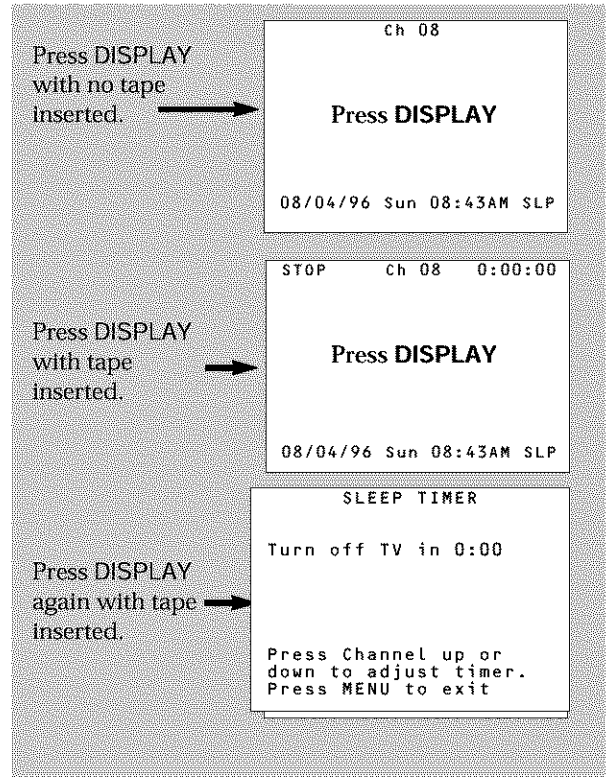

## Adjust the Video

Use the PICTURE QUALITY menu to adjust the picture for your personal preference. The TV/VCR will remember the settings you select.

### To Adjust Video

1. Press MENU to display the TV/VCR MAIN MENU.
2. Press 3 to display the PICTURE QUALITY menu.

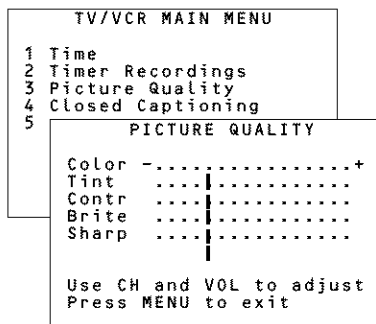

3. Press CHAN up or down to select the function you want to adjust.
  - Select Color to adjust color intensity.
  - Select Tint to adjust for natural fleshtones.
  - Select Contr (contrast) to adjust picture contrast.
  - Select Brite (brightness) to adjust picture brightness.
  - Select Sharp to adjust picture sharpness.

# Using the TV/VCR Features

## Closed Captioning

The closed captioning feature displays the audio of a program as text on the TV screen. This is useful to hearing impaired or anyone who wants to watch a program without sound.

There are four types of closed captions: Captions 1, Captions 2, Text 1 and Text 2. Captions 1 displays the full translation of the primary language in your area. Captions 2 may be used as a second source for secondary languages. Text 1 and Text 2 display on-screen boxes containing the text of general information not necessarily related to the program being watched.

Closed captioning is not available on all channels. Check your TV program listings for CC (closed caption) broadcasts.

## To View Closed Captions

1. Press MENU to display TV/VCR MAIN MENU.
2. Press 4 to display the CLOSED CAPTIONING menu.
3. Press 1 to change the Display.
  - There are three choices:  
OFF, ON, and ON WHEN MUTED.
  - Each time you press 1 the Display will change on the Closed Captioning menu screen.
4. Press 2 to select the Mode.
  - There are four choices:  
Caption 1, Caption 2, Text 1, and Text 2.
  - Each time you press 2 the Mode will change on the Closed Captioning menu screen.

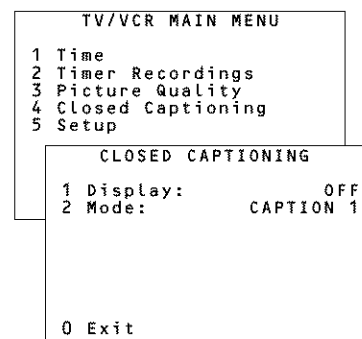

## Commercial Skip

Commercial Skip allows you to scan other channels during commercials. Each time you press SEARCH while watching TV the Commercial Skip timer increases 30 seconds up to four minutes. (SKIP display appears on the screen.) The TV/VCR will automatically switch back to the original channel when time runs out. To increase the time, press SEARCH. To cancel Commercial Skip, keep pressing SEARCH until the SKIP display disappears from the screen. (Commercial skip is not available when a tape is inserted into the TV/VCR.)

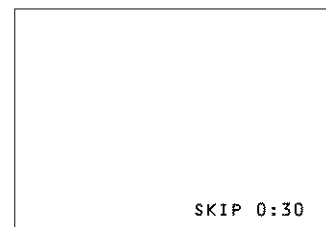

# Using the TV/VCR Features

## Sleep Timer

The sleep timer automatically turns the TV/VCR off after 30, 60, 90, or 120 minutes.

1. Press MENU to display the TV/VCR MAIN MENU.
2. Press 1 to display the TIME menu.
3. Press 2 to display the SLEEP TIMER screen.

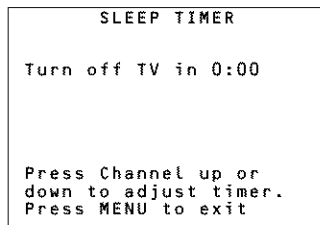
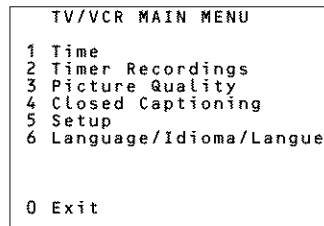

4. Press CHAN up or down to select 30, 60, 90, or 120 minutes.
5. Press MENU to exit.  
Press DISPLAY to check the amount of time remaining before the TV turns off.
6. To cancel the sleep timer, display the SLEEP TIMER, and repeatedly press CHAN until 0:00 is displayed on the screen.

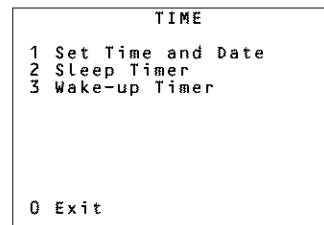

## Wake-Up Timer

The timer turns the TV/VCR on at a desired time. You can set it to wake you up in the morning or remind you that a favorite program is about to start.

1. Press MENU to display the TV/VCR MAIN MENU.
2. Press 1 to display the TIME menu.
3. Press 3 to display the WAKE-UP TIMER menu.

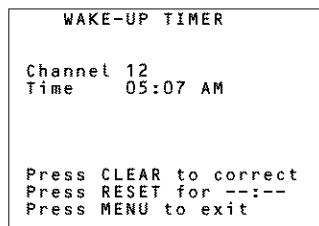
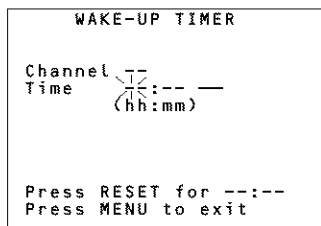

4. Use the number buttons to enter the channel number and time.
  - After you enter the time, press 1 for AM or 2 for PM.  
Example: press 0, then 5, then 0, then 7, then 2, for a time of 5:07PM.
  - Press CLEAR to correct an entry or RESET to cancel the timer.
5. Press MENU to set the timer.
  - The wake-up timer will turn on the TV/VCR every day. The WAKE-UP indicator lights on the front when the wake-up timer has turned on the TV/VCR.
  - Press any button on the remote or TV/VCR to turn off the WAKE-UP indicator. If you do not press a button, the TV/VCR turns off after 60 minutes.

### To Cancel the Wake-Up Timer

Follow steps 1-3 above, press RESET to cancel the timer, and then press MENU to exit.

The timer is also canceled if MENU is pressed before step 4 is completed.

# Operating Instructions

## To Play a Tape

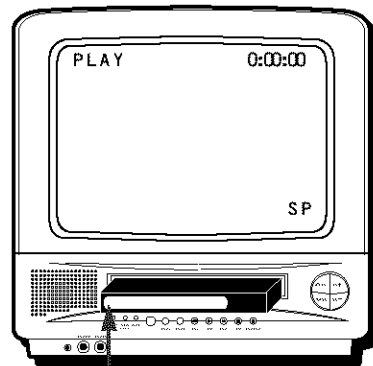

Safety Tab

1. Insert a tape in the TV/VCR.  
TV/VCR automatically turns on. The tape automatically begins to play if the safety tab on the cassette has been removed and the Auto Play feature has been turned on.
2. Press PLAY, if necessary.  
PLAY and the time counter appear on the screen.
3. If necessary, press TRACKING up or down on the remote or CHANNEL up or down on the TV/VCR to remove any streaks from the picture. *Details are on page 13.*
4. Press STOP on the remote or STOP/EJECT on the TV/VCR to stop playback.
5. Press REW.  
The TV/VCR will automatically rewind the tape if it reaches the end of the tape during playback. While rewinding, you can press POWER to turn off the TV/VCR and the TV/VCR will still rewind the tape.
6. Press STOP/EJECT on the TV/VCR to eject the tape once it is completely rewound.  
A cassette may be ejected with the power turned off.

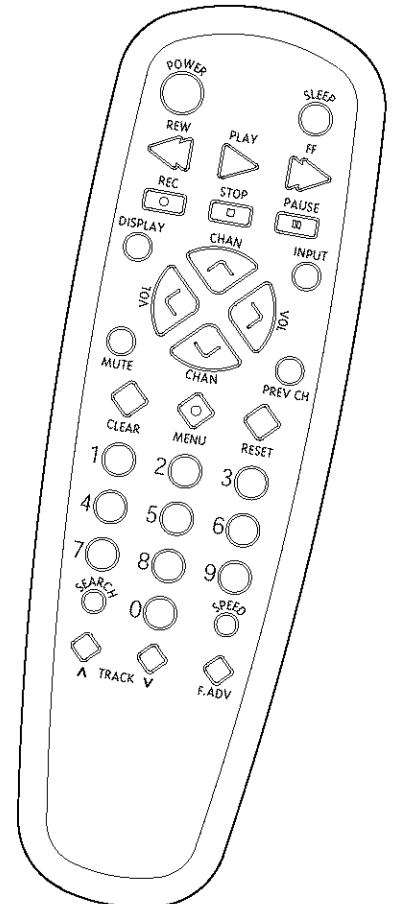

## Using the Playback Features

### Pause

This feature pauses the tape and allows you to examine the details of the scene. Pause works best for tapes recorded in SLP speed.

1. Press PAUSE on the remote during playback to pause the action.

The TV/VCR will automatically switch from pause to stop after a few minutes to prevent tape wear.

2. Press PAUSE or PLAY to return to playback.

### Frame Advance

Frame advance lets you view the video tape one frame at a time. Frame advance works best for tapes recorded in SLP speed.

1. Press PAUSE during playback to pause the action.

2. Press F.ADV each time you want to view a frame of the scene.

Press and hold F.ADV to view the tape in slow motion, frame-by-frame.

3. Press PAUSE or PLAY to return to playback.

### Picture Search

You can visually search a picture during playback. Sound is turned off during picture search. Picture search works best for tapes recorded in SLP speed.

1. During playback, press FF to search forward or REW to search in reverse.

If you start searching within five seconds of a previous search, the search speed will be slower for approximately eight seconds.

2. Press FF or REW again, or press PLAY to return to playback.

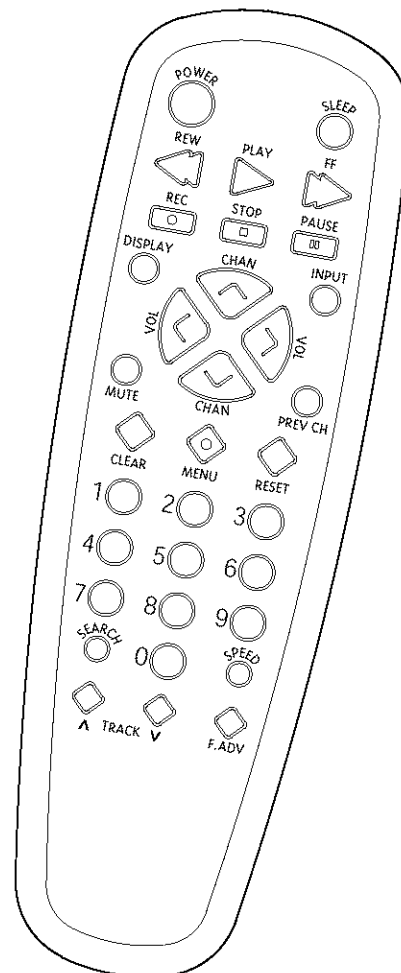

# Using the Playback Features

## Automatic Tracking

The TV/VCR has automatic tracking which adjusts the picture when playing a tape that was recorded on another VCR. Automatic tracking is turned on whenever a tape is inserted or the TV/VCR's power is turned on.

## Manual Tracking

Occasionally, you may need to manually adjust tracking on a tape recorded on a different VCR or camcorder. Tracking is used when playing a tape. It has no effect during recording.

- When streaks or snow appear in the picture during normal playback or slow motion, press TRACKING up or down on the remote or CHANNEL up or down on the TV/VCR for the best possible picture.
- To turn automatic tracking back on, press and hold both of the CHANNEL buttons on the front of the TV/VCR.

## Time Counter

The time counter helps locate the beginning or end of programs you taped. The time counter automatically resets to 0:00:00 whenever a tape is inserted, or you can press CLEAR when the time counter is displayed. For example, if a 30-minute program was recorded at the beginning of the tape and you wanted to record another program after it, you would:

1. Insert the pre-recorded tape.

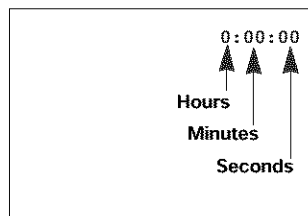

2. Press DISPLAY twice to display the time counter and fast forward the tape until 31 minutes appears on the screen. Then you can begin recording a second program.

## Commercial Scan

This is useful for skipping commercials or short program segments.

Press SEARCH during playback to advance the tape approximately 60 seconds.

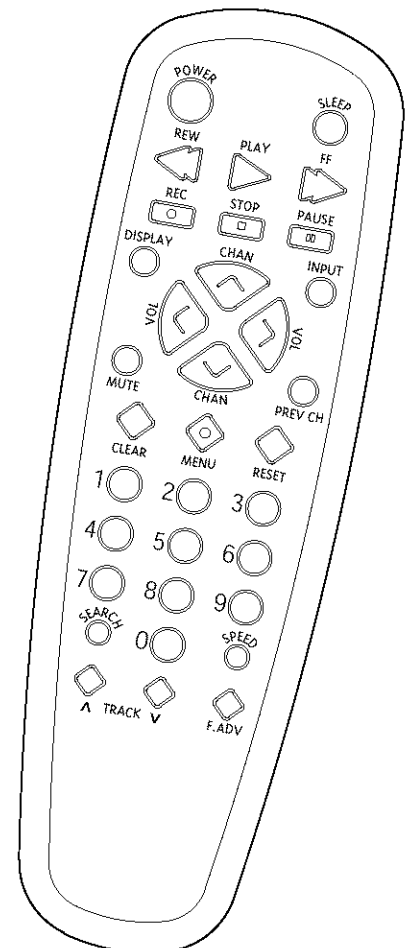



# Using the Playback Features

## Auto Play Feature

This feature enables the TV/VCR to automatically start playing a tape when it is inserted. (The safety tab on the tape must be removed.)

1. Press MENU to display the TV/VCR MAIN MENU.
2. Press 5 to display the SETUP menu.
3. Press 4 to change the Auto Play setting.

The Auto Play feature is set to ON at the factory.

- Select ON if you want a tape with its safety tab removed to start playing automatically.
- Select OFF if you do not want a tape with its safety tab removed to start playing automatically.

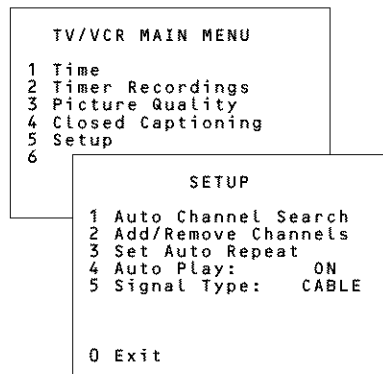

## Auto Repeat Feature

This feature tells the TV/VCR to play a tape (or part of a tape) continuously. The TV/VCR will automatically rewind the tape, or a selected portion of the tape, and play it repeatedly.

1. Using REW, FF, or PLAY, go to the place on the tape that you want to be the **beginning** of the section that automatically repeats. Reset the time counter to 0:00:00 by pressing DISPLAY, then CLEAR.
2. Using FF or PLAY, go to the place on the tape that you want to be the **end** of the section that plays continuously. Remember the numbers on the time counter. (2:55 is the end time for AUTO REPEAT in the example to the right.)
3. Press MENU to display the TV/VCR MAIN MENU.
4. Press 5 to display the SETUP menu.
5. Press 3 to display the AUTO REPEAT menu.
6. Using the number buttons, enter the amount of time you want the tape to repeat (the number from Step 2). In the example at right, the section that the TV/VCR will automatically repeat is 2:55 – two hours, 55 minutes long.
7. The REPEAT indicator on the front of the TV/VCR will light when you activate the Auto Repeat feature.

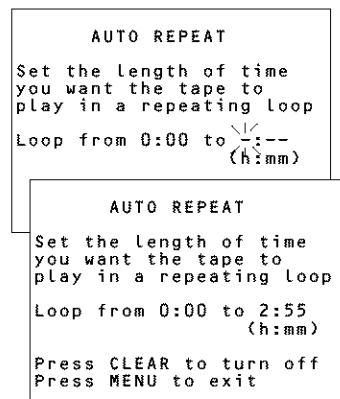

## To Cancel Auto Repeat

Press MENU, 5, 3, and CLEAR.

# Using the Playback Features

## Index Search

The TV/VCR automatically records index marks on the tape each time you begin recording. During playback you can locate the program you want to play by the number of index marks. Your TV/VCR has two index playback features. You can select a specific index number or search by scan and play.

### To Select Scan and Play Index Playback

1. Insert the pre-recorded tape and press STOP.
2. Press SEARCH to display the INDEX SEARCH screen.
3. Press FF to scan forward or REW to scan in reverse.  
When the TV/VCR locates an index mark, it will stop and play a few seconds of the program following the mark.
4. At any time during the search, press PLAY to stop searching and begin playback, or press STOP to stop the search.  
If the beginning or end of the tape is reached during the search, **End of tape** appears.

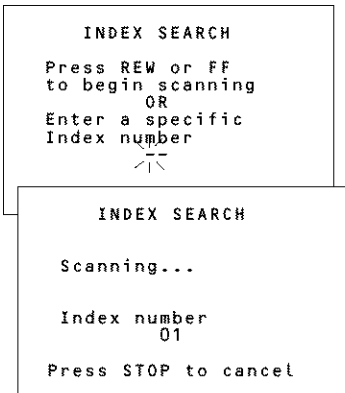

### To Select a Specific Index Number for Index Playback

1. Insert the pre-recorded tape and press STOP.
2. Press SEARCH to display the INDEX SEARCH screen.

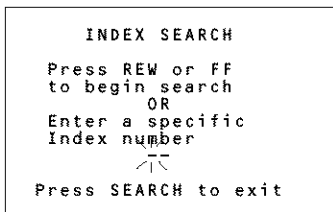

3. Use the number buttons to enter the number of the index mark you want the TV/VCR to search for.
4. Press FF to search forward or REW to search in reverse.  
When the TV/VCR locates the index mark, it will begin playback.  
When using index playback, the following index marks may be skipped by the TV/VCR.
  - The mark closest to the current location on the tape.
  - The mark at the beginning of a recorded segment that is five minutes or less.
  - The mark at the beginning of the tape.

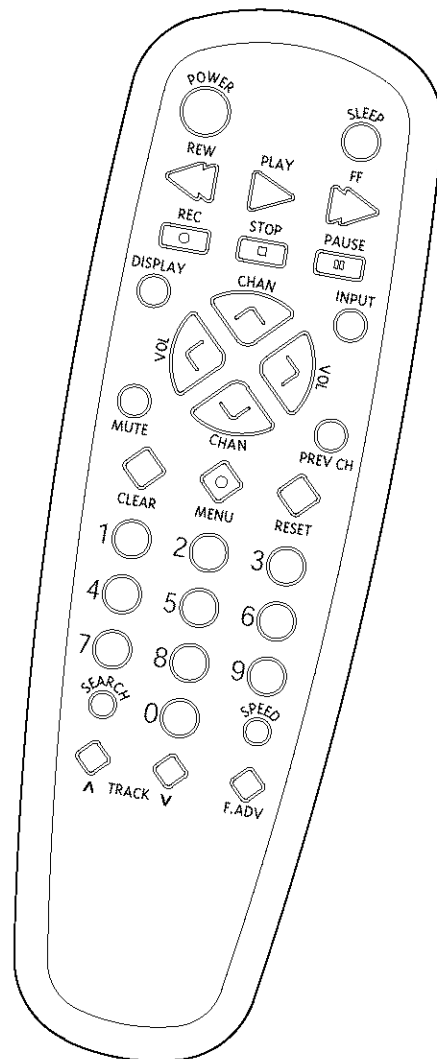

# Using the Playback Features

## Zero Search

This feature allows you to quickly return to a time counter reading of 0:00:00. This is especially convenient when you want to watch a segment of the tape several times.

1. Insert the pre-recorded tape. Press STOP.
2. Press DISPLAY twice to display only the time counter.
3. Use PLAY, FF, or REW to locate the start of the segment you want to repeat.
4. Press CLEAR to reset the time counter to 0:00:00.
5. Continue playing the tape and press STOP when you reach the end of the segment you want to repeat.
6. Press SEARCH twice to display the ZERO SEARCH screen. The current time counter is displayed.
7. Press REW or FF to return to 0:00:00.  
The tape rewinds or fast forwards to the 0:00:00 and begins playing.

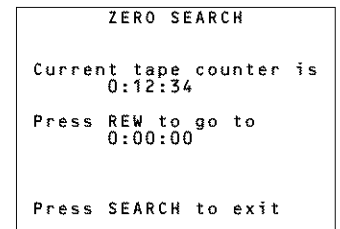

— OR —

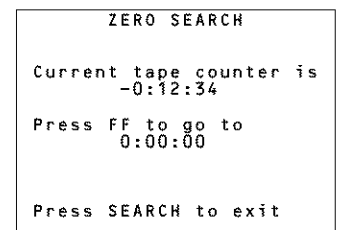

## Blank Search

The TV/VCR will search for blank portions of the tape that are more than six seconds in length.

1. Insert the pre-recorded tape and press STOP.
2. Press SEARCH three times to display the BLANK SEARCH screen.

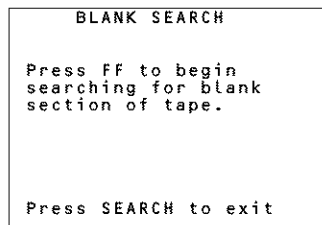

3. Press FF to begin searching for a segment that is at least six seconds of blank tape.
4. Press STOP to stop BLANK SEARCH.

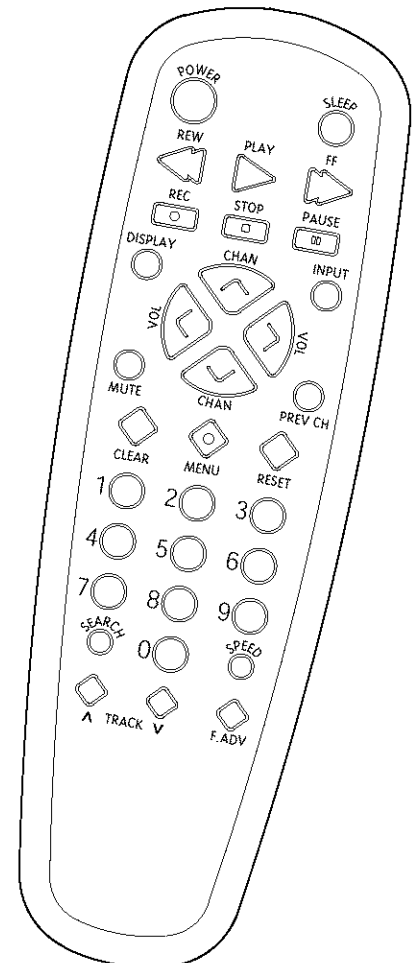

# Recording Features

## Recording Speeds

Press SPEED to select a recording speed.

Cassette	Recording Time		
	SP	SLP	LP
T-120	2Hrs	6Hrs	4Hrs
T-160	2Hrs 40Min	8Hrs	5Hrs 20Min

- SP (Standard Play) gives the best quality recording. That is why most pre-recorded, rental tapes are recorded in SP. Fewer programs can be recorded on the tape.
- SLP (Super Long Play) gives three times the recording time of tapes recorded in SP. Special effects such as pause, slow motion, picture search, and frame advance work in this speed.
- LP (Long Play) gives twice the recording time of tapes recorded in SP. Special effects are not recommended in this speed.

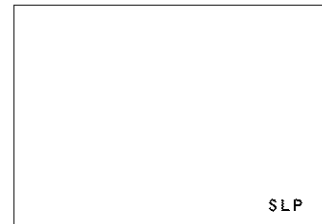

SLP



Tape Speed Indicator

## Recording Pause

This feature allows you to prevent recording short passages of unwanted material.

- Press PAUSE during recording to stop and start recording.  
The TV/VCR will automatically switch from pause to stop after a few minutes to prevent tape wear.

## Automatic Head Cleaner

The TV/VCR has an automatic head cleaner system. When a cassette is inserted, the head cleaning system is activated. This system minimizes the need for accessory cleaners or a visit to a Servicenter.

## Child Lock

This feature locks the TV/VCR to prevent anyone from using it. The TV/VCR must be ON and the remote control used in order to activate Child Lock.

- Press and hold the POWER button on the remote for six seconds to turn on the Child Lock feature. The TV/VCR turns off and the POWER indicator blinks six times.
- Press and hold the POWER button on the remote for six seconds to turn off the Child Lock feature. The POWER button blinks six times and the TV/VCR turns on.

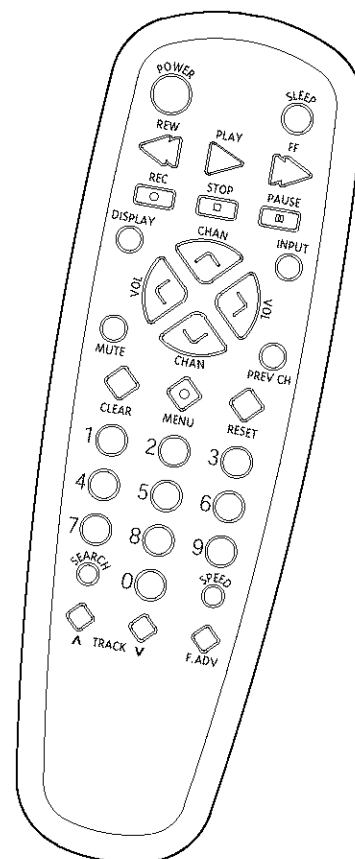

## Types of Recordings

Your TV/VCR provides different ways to record which are explained in the following sections:

- Basic Recording
- Express Recording
- Timer Recording
- Copying and Editing Tapes

## Basic Recording

### How to Make a Recording

1. Insert a tape with safety tab in place.
2. Press SPEED to select a recording speed.  
The tape speed indicator appears.
3. Select the channel to be recorded.  
If recording from the AUDIO/VIDEO INPUT jacks, use INPUT to select VIDEO1 (back panel jacks) or VIDEO2 (front panel jacks).
4. Press REC to begin recording.  
The indicator in the REC button on the front of the TV/VCR turns on during recording and RECORD appears on the screen.
5. Press STOP/EJECT on the TV/VCR or STOP on the remote to stop recording.

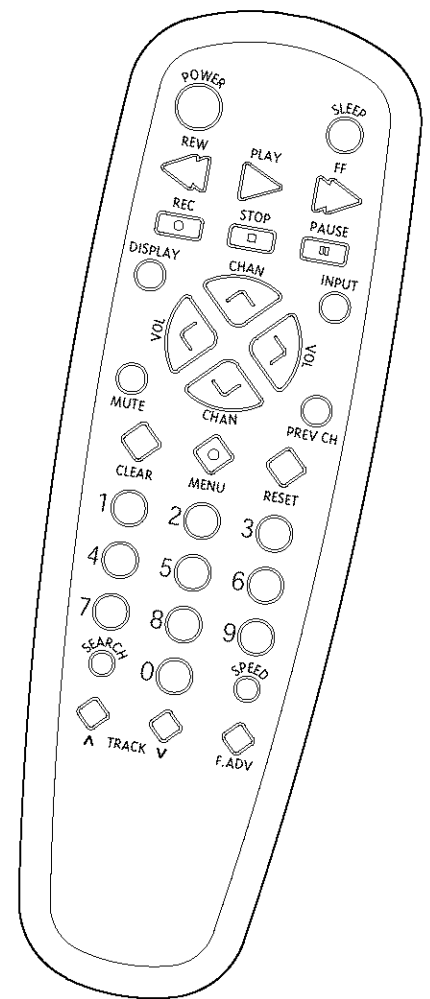

# Express Recording

Express recording lets you record up to four hours or to the end of the tape without programming the timer. You can begin recording immediately. The TV/VCR will stop automatically at the end of the recording.

## How to Use Express Recording

1. Insert a tape with safety tab in place.  
The TV/VCR will turn on.
2. Select the channel to be recorded.  
If recording from the AUDIO/VIDEO INPUT jacks, use INPUT to select VIDEO1 (back panel jacks) or VIDEO2 (front panel jacks).
3. Press SPEED to select a recording speed.  
You can also change the speed of the recording in progress.
4. Press REC twice to activate Express Recording.
5. Press REC repeatedly until the desired amount of recording time is displayed.  
Each time you press REC, the recording time increases by 30 minutes — up to tape end.

Press REC	Recording Time
0:30	(30 Min)
1:00	(1 Hr)
1:30	(1 Hr, 30 Min)
2:00	(2 Hrs)
3:00	(3 Hrs)
4:00	(4 Hrs)
Tape end	(Tape end)
0:00	(Turns Off)

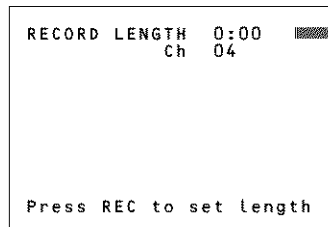

Display

The indicator in the REC button on the TV/VCR's front panel will light during recording.  
During recording, press REC to display the time remaining on the screen. Press REC again to increase the recording time.

## Stopping an Express Recording in Progress

Press and hold STOP/EJECT on the TV/VCR or STOP on the remote for a few seconds to stop the recording.

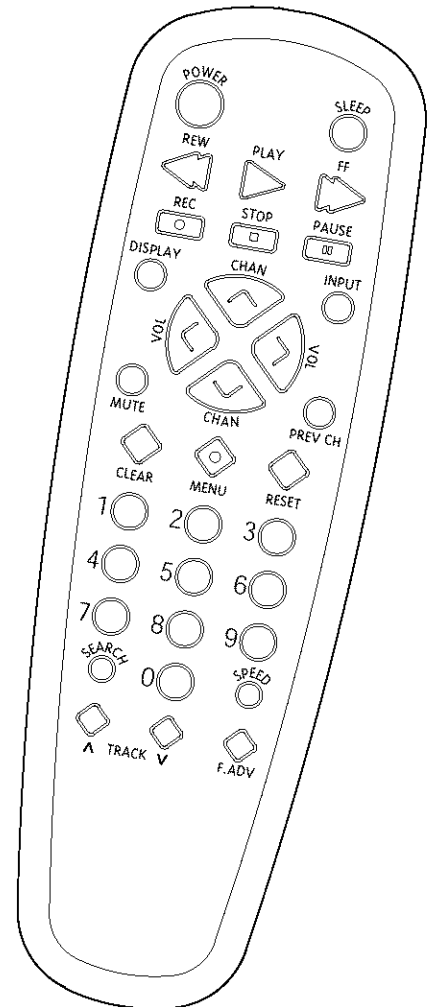

# Timer Recording

Timer recording lets you program the TV/VCR to record up to eight different programs within a one year period. Before setting the timer, make sure that the clock is set correctly.

## Setting a Timer Recording

1. Press MENU to display the TV/VCR MAIN MENU.
2. Press 2 to display the TIMER RECORDINGS menu.
3. Press 1 to Create a New Program.
4. Press 1, 2, 3, or 4 to select the type of program.
  - 1 One time — single program recorded once.
  - 2 Daily — program recorded at same time every day.
  - 3 Weekdays — program recorded at same time Monday through Friday.
  - 4 Weekly — program recorded at same time once a week.
5. Press number buttons to enter the channel number, start time including AM or PM, end time, and start date of the recording. Just follow the on-screen prompts.
  - If recording from the AUDIO/VIDEO IN jacks, press 00 to select the line input (VIDEO) instead of a channel.

Press CLEAR to correct an entry.
6. Press SPEED to select a recording speed.
7. Press MENU to save your program.
8. Repeat steps 3 – 6 for additional programs.
9. Insert a tape with safety tab intact before the recording is to begin.

The TIMER REC indicator lights in the TV/VCR's front panel.

If you turn the TV/VCR off, the TIMER REC indicator will flash if there is no cassette in the TV/VCR or the safety tab is missing from the cassette.

10. If using a cable box, turn it on and tune it to the channel you want to record before time for the recording to begin.

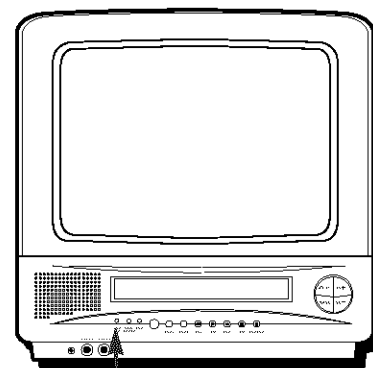
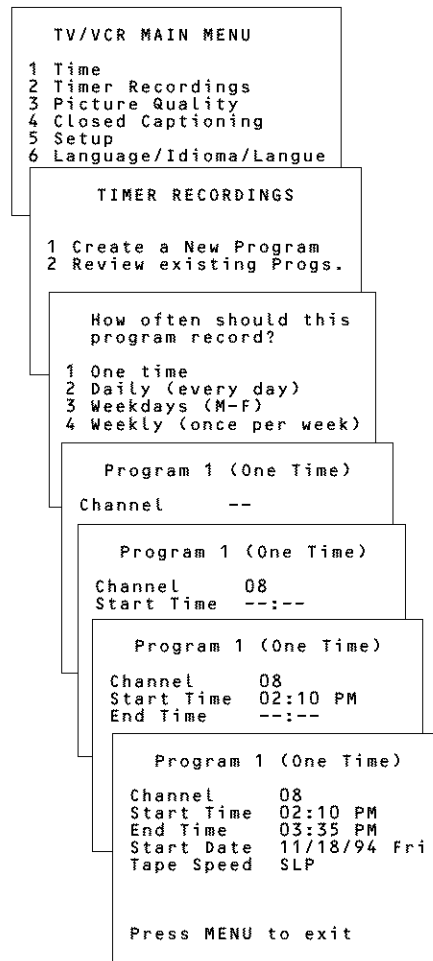

TIMER RECORD Indicator

# Timer Recording

## Checking or Clearing Timer Recordings

1. Press MENU on the remote to display the TV/VCR MAIN MENU.
2. Press 2 to display the TIMER RECORDINGS menu.
3. Press 2 to Review existing progs.
4. Press DISPLAY to review the next program in sequence.
5. Press CLEAR to erase a program.

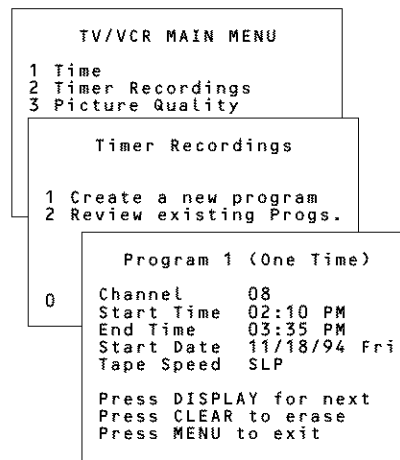

## Stopping A Timer Recording

1. Press STOP/EJECT on the TV/VCR or STOP on the remote.

A timer program in progress will be stopped. Only today's recording of a daily, weekdays, or weekly program is cancelled. The daily, weekdays, or weekly program remains in the timer.

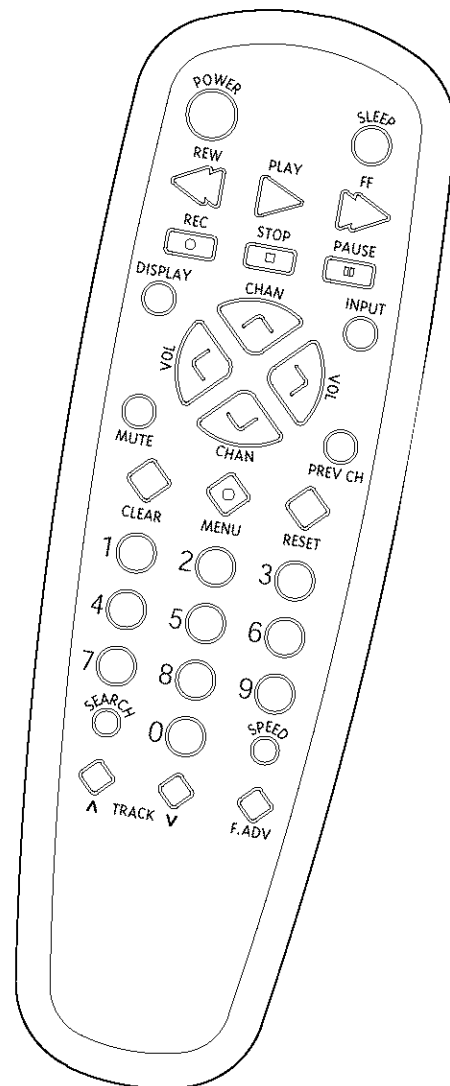



# Copying and Editing Tapes

## Operating Instructions (Refer to hookup on page 27.)

**Caution:** The unauthorized recording of television programs and other materials may infringe the rights of others.

Use another VCR or camcorder as the playback VCR and the TV/VCR as the recording VCR.

1. Turn on the VCR or camcorder and the TV/VCR.
2. Press INPUT once to select VIDEO1 (back panel jacks) or press INPUT twice to select VIDEO2 (front panel jacks).
3. Insert the tape you want to copy into the playback VCR or camcorder. Insert a blank tape with safety tab intact into the TV/VCR.
4. Start the playback VCR or camcorder playing. If the tape was not recorded on the playback VCR, streaks may appear and you may need to adjust the tracking. When you reach the place you want to begin copying, place the playback VCR or camcorder in play pause.
5. Press REC, then PAUSE, on the TV/VCR's remote.
6. Press PAUSE on **both** the VCR or camcorder and the TV/VCR's remote **at the same time** to begin copying the tape.
7. Edit out segments that you do not want to copy by pressing PAUSE on the TV/VCR's remote to stop copying the tape. Then, locate the next segment you want to copy on the playback VCR or camcorder by using FF, REW, or PLAY. Press PAUSE on the playback VCR or camcorder. Press PAUSE **at the same time on both** the VCR or camcorder and the TV/VCR's remote to resume copying.
8. Press STOP on **both** the VCR or camcorder and the TV/VCR's remote when you are finished.

Remember to press INPUT on the TV/VCR's remote for normal TV viewing on the TV/VCR.

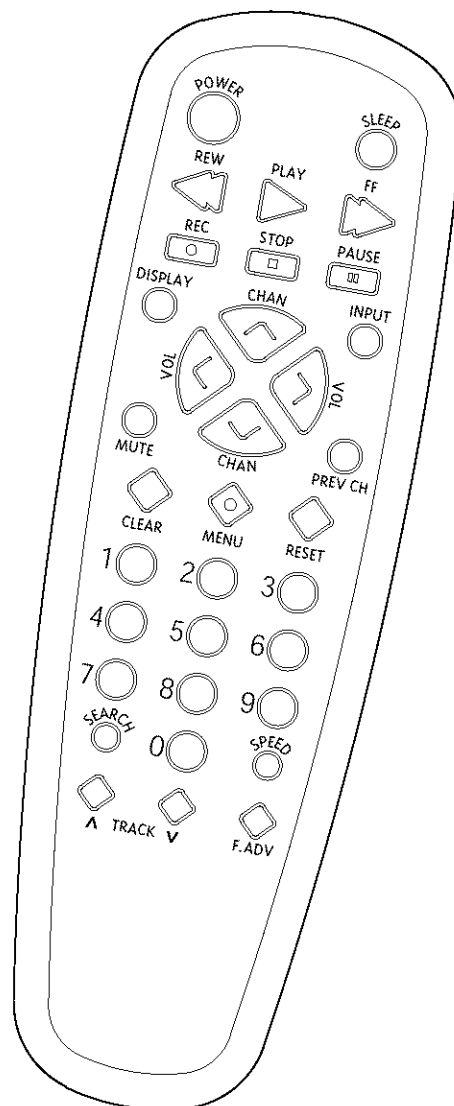
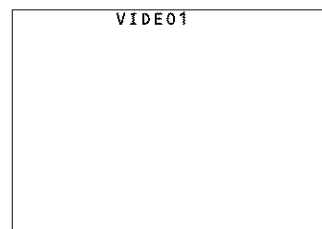

## Front Panel

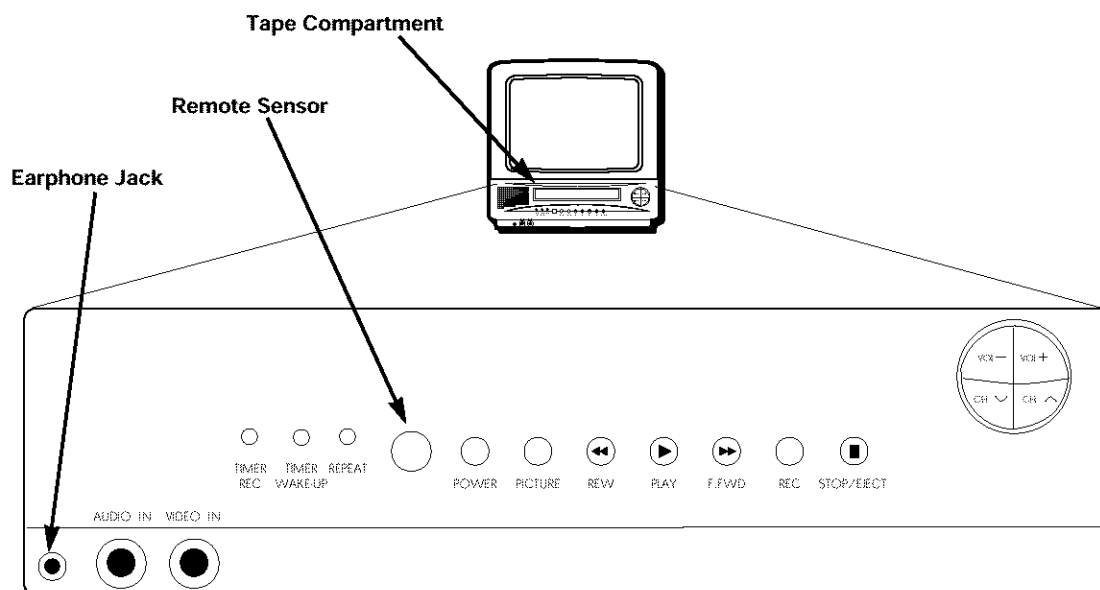

### Audio IN and Video IN Jacks

Receives audio signals from another component, like a VCR or camcorder when it is connected to these jacks.

Use INPUT to select VIDEO1 (back panel jacks) or VIDEO2 (front panel jacks) to record from these jacks.

### CHAN ^ and v (Channel up and down)

Selects next higher or lower channel in the TV/VCR's channel memory.

Used for manual tracking when a tape is playing.

### Earphone Jack

Connect an earphone (not supplied) to this jack.

### F.FWD (Fast Forward)

Fast forwards the tape when the VCR is stopped. Searches the picture forward during playback.

### PICTURE

Displays the PICTURE QUALITY menu. See page 8.

### PLAY

Plays a tape.

### POWER

Turns the TV/VCR on or off. The indicator in the button is lit when the power is on.

### REC (Record)

Press to start TV/VCR recording. The indicator in the button lights during recording.

### Remote Sensor

Receives signals from the remote. Aim remote at this sensor with no objects between them.

### REPEAT Indicator

Lights during auto repeat.

### REW (Rewind)

Rewinds the tape when the TV/VCR is stopped. Searches the picture in reverse during playback.

### STOP/EJECT

Stops normal functions — such as record, play, rewind, fast-forward, or pause. Press when a tape is stopped to eject the cassette.

### TIMER REC Indicator

Lights when a timer program has been set and a cassette with safety tab in place is in the TV/VCR.

Flashes when a timer recording has been set and the TV/VCR is turned off with no cassette inserted, a cassette with no safety tab has been inserted, or there has been a power interruption.

### TIMER WAKE UP Indicator

Lights when the wake-up timer turns on the TV/VCR.

### VOL + and - (Volume up and down)

Raises and lowers the sound.

## Back Panel

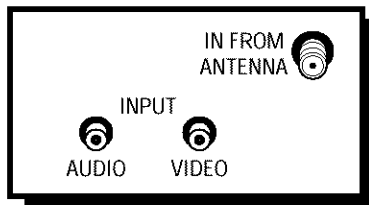

### IN FROM ANTENNA Jack

Receives the signal from an antenna or cable system.

### VIDEO and AUDIO INPUT Jacks

Receive signals from another component, such as a VCR or camcorder, when it is connected to these jacks.

To select these jacks, use INPUT to select VIDEO1 (back panel jacks) and VIDEO2 (front panel jacks).

## Hooking Up the TV/VCR

### Choosing a Hookup

Answer the questions to choose the hookup for your TV/VCR.

#### 1. How does your TV/VCR receive signals?

Choose one answer from below.

- A. Supplied dipole antenna – See page 25, Section A.
- B. Rabbit ears (set-top) and/or bowtie antenna – See page 25, Section B.
- C. Outside antenna – See page 25, Section B.
- D. Cable System – Go to question 2.

#### 2. What type of Cable-TV system\* do you have?

Choose one answer from below.

- A. Cable without a box – See page 25, Section B.
- B. Cable box to unscramble all channels – See page 26, Section A.
- C. Cable box to unscramble only premium channels, such as HBO, Showtime, Cinemax, etc. – See page 26, Section B.

\*You may need to contact your local cable company for assistance.

### Optional Hookup

**To hook up a VCR or camcorder for copying tapes — Turn to page 27.**

# Connect Supplied Antenna, Antenna, or Cable System Without a Cable Box

## A. Supplied Antenna

Follow these steps to connect the supplied antenna to your TV/VCR. Do not connect this antenna if you plan to connect a different type of indoor or outdoor antenna or cable system.

1. Insert the antenna base into the slot on the back of your TV/VCR.
2. Connect the twin-lead ends of the antenna to the screw terminals of the supplied antenna adapter.
3. Connect the antenna adapter to the **IN FROM ANTENNA** jack on the back of the TV/VCR.
4. Plug in the TV/VCR's power cord.
5. Turn to page 2 for "Setting Up the TV/VCR."

Adjust the length and position of the antenna rods for the best reception.

- For viewing VHF channels, extend the rods fully.
- For UHF viewing, shorten the rods.

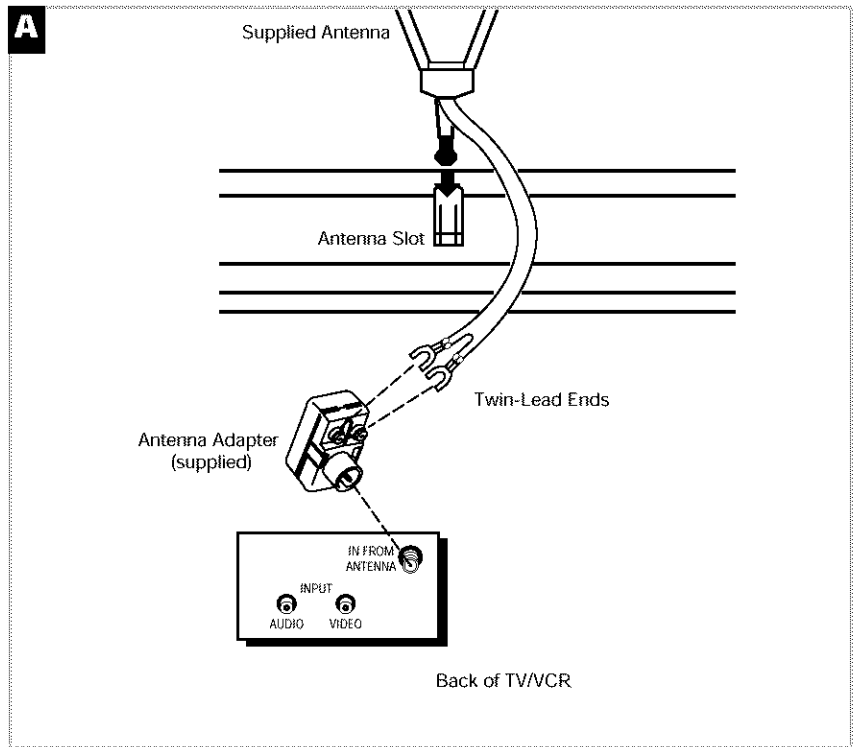

## B. Outside Antenna, Set-top Antenna, or Cable System Without a Cable Box

1. Connect as shown.  
This connection may require additional accessories not provided.
2. Plug in TV/VCR's power cord.
3. Turn to page 2 for "Setting Up the TV/VCR."

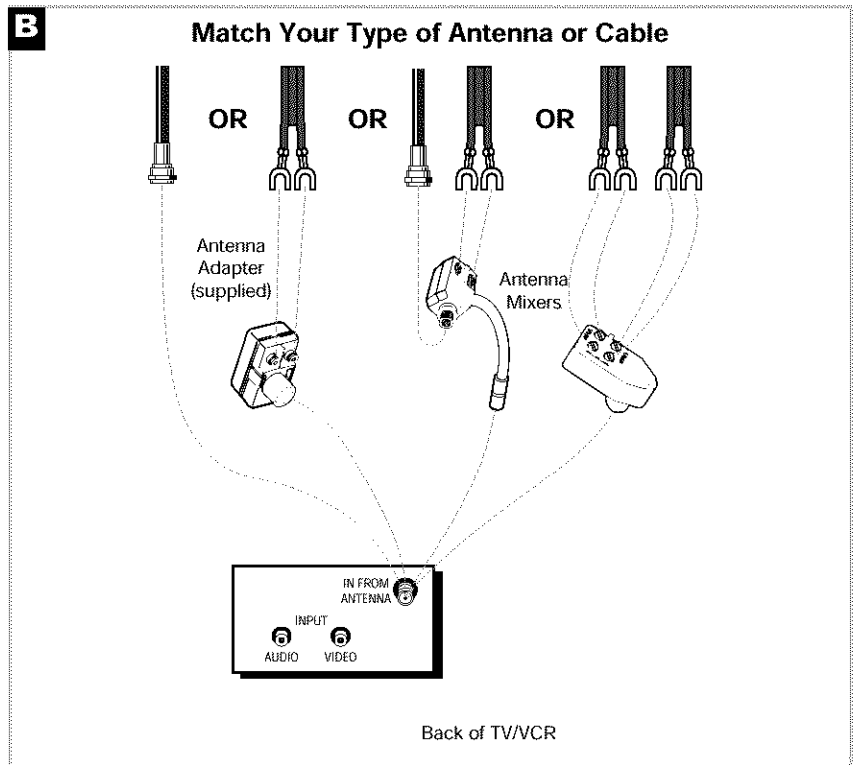

## Connect a Cable System With a Cable Box

### A. Cable Box Required to Unscramble All Channels

1. Connect as shown.  
This connection may require additional accessories not provided.
2. Plug in power cords of TV/VCR and cable box.
3. Turn to page 2 for "Setting Up the TV/VCR."

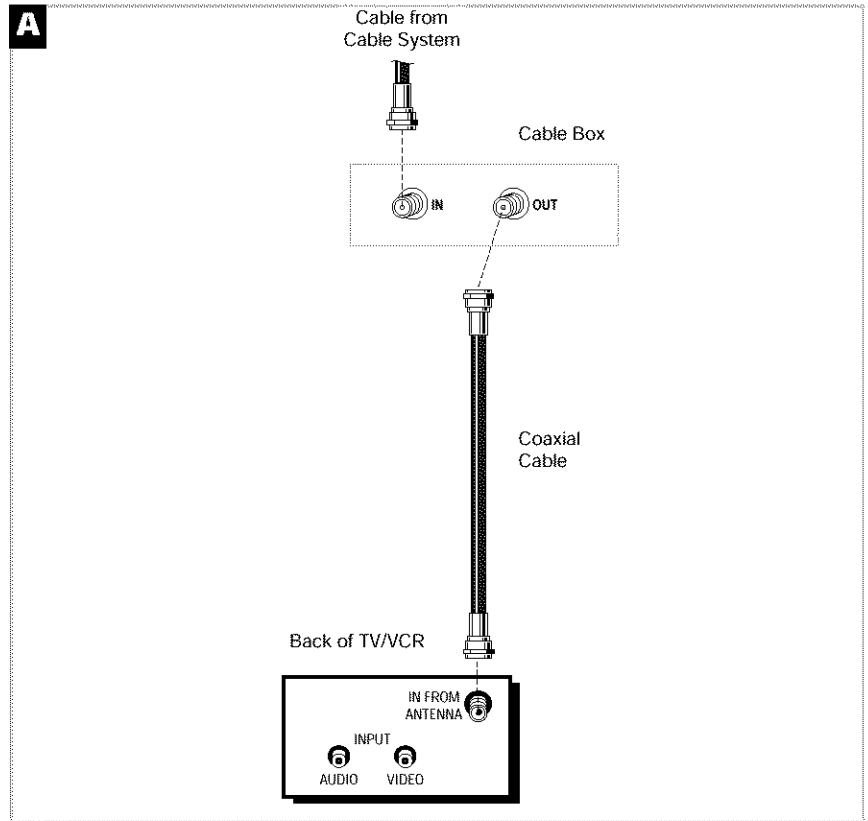

### B. Cable Box Required to Unscramble Premium Channels Only

1. Connect as shown.  
This connection requires additional accessories not provided.
2. Plug in power cords of TV/VCR and cable box.
3. Operation  
Place the A-B switch in the B position to watch premium channels. Place the A-B switch in the A position to watch other channels when cable box is not needed.
4. Turn to page 2 for "Setting Up the TV/VCR."

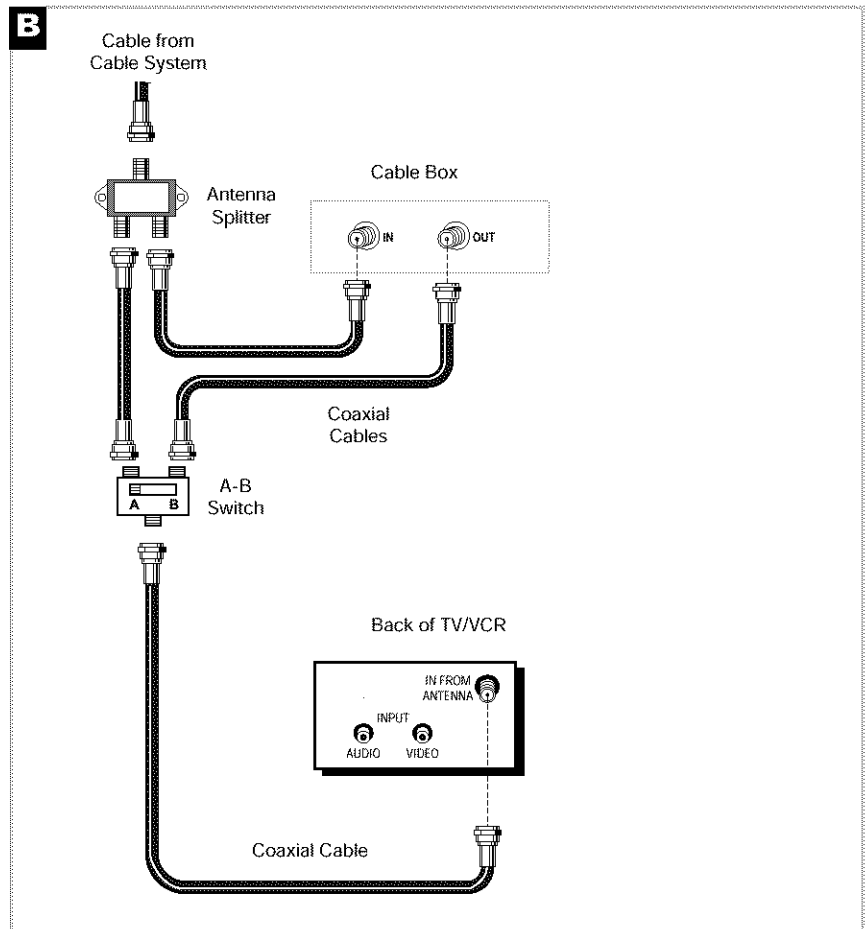

# Connect a VCR or Camcorder for Copying Tapes

## A. VCR for Copying Tapes

1. Connect as shown.

This connection requires additional accessories not provided.

2. Plug in power cords of VCR and TV/VCR.

3. Turn to page 22 for "Copying and Editing Tapes."

Press INPUT on the remote to select the line (audio/video) inputs on the TV/VCR to receive the signal from the VCR.

If your VCR has stereo AUDIO OUT jacks, connect the audio cable to the jack labeled MONO. If neither jack is labeled MONO, you may need a Y- adapter to hear both channels.

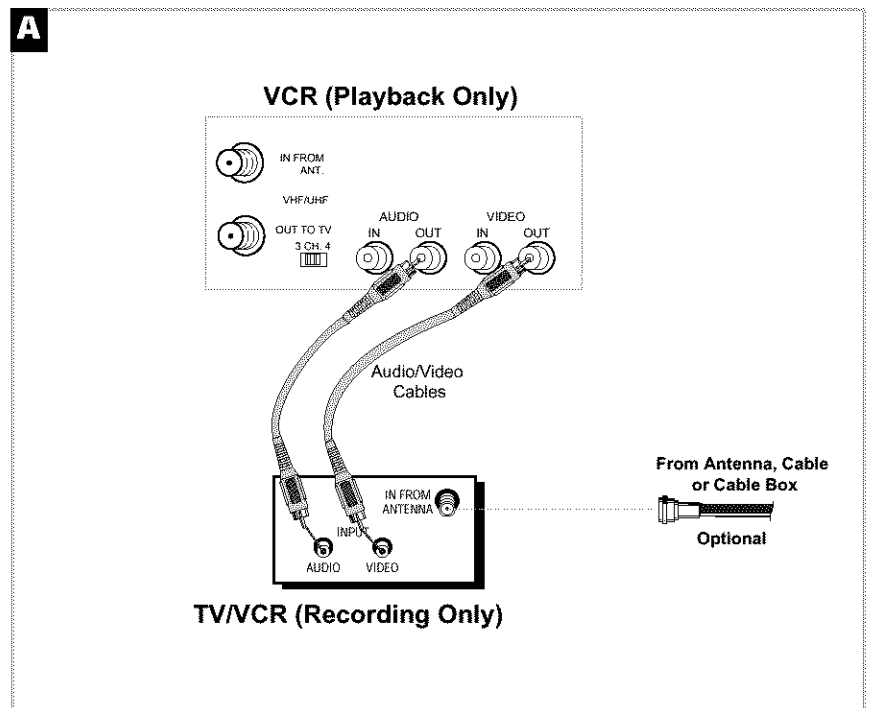

## B. Camcorder for Copying Tapes

1. Connect as shown.

This connection requires additional accessories not provided.

2. Plug in TV/VCR's power cord.

3. Turn to page 22 for "Copying and Editing Tapes."

Press INPUT on the remote to select the line (audio/video) inputs on the TV/VCR to receive the signal from the camcorder.

If your camcorder has stereo AUDIO OUT jacks, you may need a Y- adapter to hear both channels.

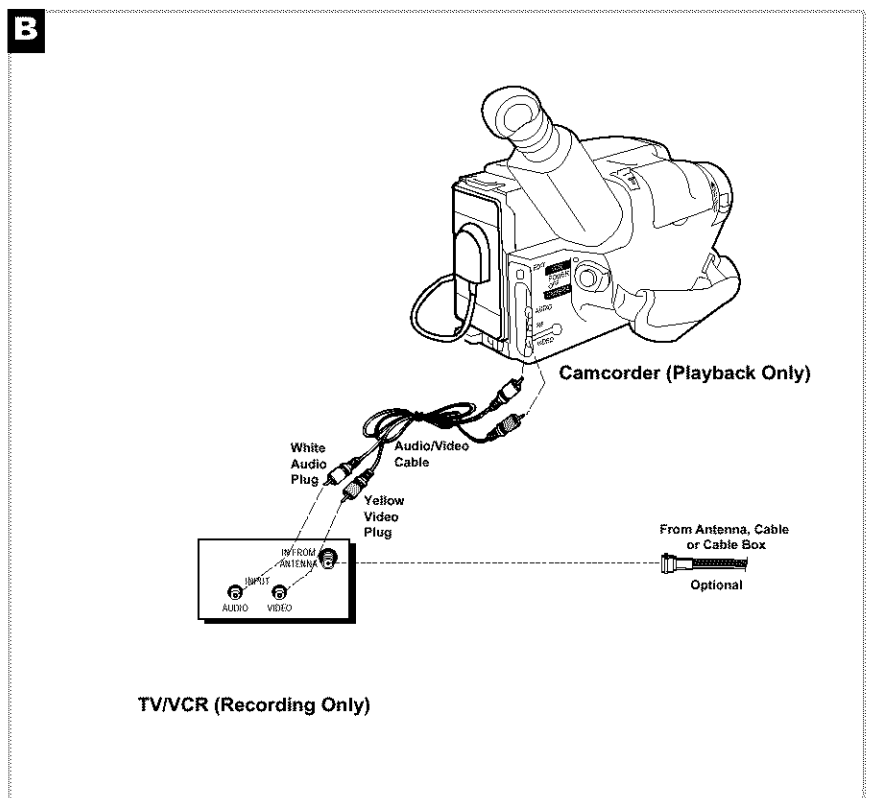

**Caution:** The unauthorized recording of television programs and other materials may infringe the rights of others.

## Trouble Checks

Sometimes problems can be easily solved by checking a few basic things. Check below before you call for help or take your TV/VCR to an Authorized RCA VCR Servicenter.

Problem	Solution
No power	<ul style="list-style-type: none"> <li>• Plug TV/VCR into an operating outlet.</li> <li>• Check connections.</li> </ul>
TV/VCR does not respond to remote	<ul style="list-style-type: none"> <li>• Aim remote at TV/VCR's remote sensor with no objects between them.</li> <li>• Change batteries.</li> </ul>
Poor or no picture during TV viewing	<ul style="list-style-type: none"> <li>• Switch to an active channel.</li> <li>• Check antenna connections. If using supplied dipole, try adjusting rods.</li> <li>• Check picture adjustments. <i>See page 8.</i></li> <li>• Make sure the line input is not selected. Press INPUT on the remote to switch between audio/video input jacks and tuner.</li> </ul>
No sound	<ul style="list-style-type: none"> <li>• Press VOLUME up to increase sound.</li> <li>• Sound has been muted. Press MUTE on remote or VOLUME up.</li> </ul>
Snow or streaks in picture or no picture during playback	<ul style="list-style-type: none"> <li>• Check tape — it may be worn out or of poor quality. Try another tape.</li> <li>• Some snow/streaks are normal during search, pause, frame advance, and slow-motion playback.</li> <li>• Press one of the TRACKING buttons on the remote or CHANNEL up or down on the TV/VCR to move the streaks up or down and out of the picture.</li> </ul>
Will not record or play	<ul style="list-style-type: none"> <li>• No cassette in TV/VCR.</li> <li>• Eject and re-insert cassette.</li> <li>• Broken tape — try another cassette.</li> <li>• Safety tab removed from cassette — TV/VCR will not record.</li> <li>• TV/VCR is in pause mode. Press PAUSE on the remote.</li> </ul>
Cannot insert or eject tape	<ul style="list-style-type: none"> <li>• Insert cassette with window facing up and safety tab facing out.</li> <li>• To remove cassette, TV/VCR must be connected to working outlet.</li> <li>• Turn POWER off and then on before trying to insert or remove cassette.</li> </ul>
Time counter not working	<ul style="list-style-type: none"> <li>• Press DISPLAY on remote to display time counter on screen. <i>See page 13.</i></li> <li>• The time counter does not advance during unrecorded portions of tape. When an unrecorded segment of tape is encountered, the time counter will hold its count until recorded material is detected again.</li> <li>• A minus (-) will appear in front of the time counter if you rewind the tape farther back than a counter reading of 0:00:00.</li> </ul>
Rewind does not operate	<ul style="list-style-type: none"> <li>• Tape already rewind.</li> </ul>
Timer recording not made or wrong program recorded	<ul style="list-style-type: none"> <li>• Program entered incorrectly (wrong channel or times). <i>See page 20.</i></li> <li>• Cable box was not turned on at time recording was to begin.</li> <li>• Power interruption. TIMER indicator flashes on front of TV/VCR.</li> <li>• Check to see if time and date are correct — including AM/PM.</li> <li>• Program exceeded tape's length or tape was not rewind beforehand.</li> <li>• No tape in TV/VCR, or cassette ejected if safety tab broken off.</li> </ul>

## Trouble Checks

Problem	Solution
Clock shows incorrect time or date	<ul style="list-style-type: none"> <li>• Power interruption. TIMER indicator flashes on front of TV/VCR.</li> <li>• Clock was not set accurately (check AM/PM and date). <i>See page 4.</i></li> <li>• Need to reset clock for daylight saving time or standard time. <i>See page 4.</i></li> </ul>
TV/VCR makes noise when stopped	<ul style="list-style-type: none"> <li>• TV/VCR is removing tape from heads. This is normal. The head cylinder inside the TV/VCR will continue to rotate for a few minutes after you put the VCR in the stop mode.</li> </ul>
Will not auto channel search active channels correctly	<ul style="list-style-type: none"> <li>• Check antenna or cable connections.</li> </ul>
Tape plays back in slow motion	<ul style="list-style-type: none"> <li>• Press PLAY to return to normal playback.</li> </ul>
Cannot see closed captions on screen	<ul style="list-style-type: none"> <li>• Closed caption function must be set to on. <i>See page 9.</i></li> <li>• Station may not be broadcasting closed captions.</li> </ul>
Box appears on screen	<ul style="list-style-type: none"> <li>• A text feature has been selected. <i>See page 9.</i></li> </ul>
TIMER indicator on front of TV/VCR is flashing	<ul style="list-style-type: none"> <li>• Power interruption. Check time and date setting (clock). <i>See page 4.</i></li> <li>• Timer program set and TV/VCR turned off with no cassette or cassette with no safety tab inserted. <i>See page 20.</i></li> </ul>
Tape plays over and over	<ul style="list-style-type: none"> <li>• Auto repeat turned on. <i>See page 14.</i></li> </ul>
Tape starts playing automatically	<ul style="list-style-type: none"> <li>• Auto play feature turned on. <i>See page 14.</i></li> </ul>
TV/VCR turns off automatically	<ul style="list-style-type: none"> <li>• Sleep timer turned on. Press POWER to turn TV/VCR back on.</li> </ul>
TV/VCR turns on automatically	<ul style="list-style-type: none"> <li>• Wake up timer (alarm) turned on. <i>See page 10.</i></li> </ul>
Cannot record one program while watching a different program	<ul style="list-style-type: none"> <li>• TV/VCR only has one tuner. Only one program can be watched and recorded at the same time.</li> </ul>
Power button on front of TV/VCR flashes briefly	<ul style="list-style-type: none"> <li>• Child Lock feature has been activated. <i>See page 17.</i></li> </ul>
VCR functions won't work	<ul style="list-style-type: none"> <li>• Child Lock feature has been activated. <i>See page 17.</i></li> </ul>
Receive same signal on more than one channel when using an antenna	<ul style="list-style-type: none"> <li>• Change Signal Type to Antenna on Setup Menu. Press MENU on remote, 5 for Setup Menu, and 5 again to change the Signal Type.</li> </ul>



## Cleaning the TV/VCR

Use a soft cloth or dusting attachment of your vacuum cleaner to dust your TV/VCR. Remove dust from the ventilation holes of the cabinet.

Plastic surfaces are easily scratched and can be marred by alcohol and various solvents. Avoid excessive use of oil-based furniture polishes since the materials used in the cabinet will accumulate more dust. We recommend using a non-abrasive, anti-static cleaner and polisher.

## Specifications

<b>Picture Tube</b>	13-inch measured diagonal 90° deflection
<b>Format:</b>	VHS
<b>Record/Playback System:</b>	Video: 2-Head Audio Track: One
<b>Video Signal System:</b>	EIA standard: NTSC color
<b>Antenna:</b>	75-ohm external VHF/UHF combined antenna terminal
<b>Tuner:</b>	USA: 181 channel tuning capability* (125 cable channels) Canada: 178 channel tuning capability* (122 cable channels)
<b>Type:</b>	Autoprogramming frequency synthesis
<b>Power Requirement:</b>	120V AC, 60 Hz
<b>Power Consumption:</b>	80 watts
<b>Dimensions:</b>	15.44 inches high (386 mm) 14.64 inches wide (366 mm) 14.84 inches deep (371 mm)
<b>Weight:</b>	29.7 pounds (13.5 kg)
<b>Operating Temperature Range:</b>	+41°F to +104°F
<b>Operating Humidity Range:</b>	10% to 75%

\* Check your cable company's compatibility requirements.

## Limited Warranty

### What your warranty covers:

- Any defect in material or workmanship.

### For how long after your purchase:

- Ninety days for labor charges.
- One year for parts.
- Two years for picture tube.

(The warranty period for rental units begins with the first rental or 45 days from date of shipment to the rental firm, whichever comes first.)

### What we will do:

- Pay any Authorized RCA VCR Servicenter the labor charges to repair your TV/VCR.
- Pay any Authorized RCA VCR Servicenter for the new or, at our option, rebuilt replacement parts and picture tube required to repair your TV/VCR.

### How you get service:

- For screen sized of 20" and smaller:  
Take your RCA TV/VCR to any Authorized RCA VCR Servicenter and pickup when repairs are complete.
- For screen sizes larger than 20":  
Request home service from any Authorized RCA VCR Servicenter.
- To identify your nearest Authorized RCA VCR Servicenter, ask your Dealer, look in the Yellow Pages, or call 1-800-336-1900.
- Show the Authorized Servicenter Representative your sales receipt or other evidence of purchase date.

### What your warranty does not cover:

- Customer instruction. (Your Owner's Manual clearly describes how to install, adjust, and operate your TV/VCR. Any additional information should be obtained from your Dealer.)
- Installation and related adjustments.
- Signal reception problems not caused by your TV/VCR.
- Damage from misuse or neglect.
- Cleaning of video/audio heads.
- Batteries.
- A TV/VCR that has been modified or incorporated into other products or is used for institutional or other commercial purposes.
- Images burnt onto the screen.
- Acts of God, such as but not limited to lightning charge.
- A TV/VCR purchased or serviced outside the USA.

### Product Registration:

- Please complete and mail the Product Registration Card packed with your TV/VCR. It will make it easier to contact you should it ever be necessary. The return of the card is not required for warranty coverage.

### How state law relates to this warranty:

- This warranty gives you specific legal rights, and you also may have other rights that vary from state to state.

### If you purchased your TV/VCR outside the United States:

- This warranty does not apply. Contact your dealer for warranty information.



For your nearest Authorized Servicenter  
call toll-free in the USA.

1-800-336-1900

Canadian Consumers —  
Your toll-free numbers are.

English: 1-800-522-0338  
French: 1-800-522-0445

If your product needs service, please contact your dealer or  
the nearest servicenter from the Yellow Pages. Please do not  
send any products to the Indianapolis address listed in this  
manual or on the carton. This will only add delays in service  
for your product.

 **THOMSON CONSUMER ELECTRONICS**  
**10330 N Meridian Street**  
**Indianapolis, IN 46290**

©1996 Thomson Consumer Electronics, Inc.  
Trademark(s)<sup>®</sup> Registered  
Marca(s) Registrada(s)  
Printed in Singapore  
**15168870**