



WEGATM

FD Trinitron

Operating Instructions

KV-36FS13

WARNING

To reduce the risk of fire or shock hazard, do not expose the TV to rain or moisture.



This symbol is intended to alert the user to the presence of uninsulated "dangerous voltage" within the product's enclosure that may be of sufficient magnitude to constitute a risk of electric shock to persons.



This symbol is intended to alert the user to the presence of important operating and maintenance (servicing) instructions in the literature accompanying the appliance.

CAUTION

TO PREVENT ELECTRIC SHOCK, MATCH WIDE BLADE OF PLUG TO WIDE SLOT, FULLY INSERT.

CAUTION

When using TV games, computers, and similar products with your TV, keep the brightness and contrast functions at low settings. If a fixed (non-moving) pattern is left on the screen for long periods of time at a high brightness or contrast setting, the image can be permanently imprinted onto the screen. Continuously watching the same program can cause the imprint of station logos onto the TV screen. These types of imprints are not covered by your warranty because they are the result of misuse.

Note on Caption Vision

This television receiver provides display of television closed captioning in accordance with §15.119 of the FCC rules.

Note on Cleaning the TV

Clean the TV with a soft dry cloth. Never use strong solvents such as thinner or benzine, which might damage the finish of the cabinet.

Note to CATV System Installer

This reminder is provided to call the CATV system installer's attention to Article 820-40 of the NEC that provides guidelines for proper grounding and, in particular, specifies that the cable ground shall be connected to the grounding system of the building, as close to the point of cable entry as practical.

Use of this television receiver for other than private viewing of programs broadcast on UHF or VHF or transmitted by cable companies for the use of the general public may require authorization from the broadcaster/cable company and/or program owner.

NOTIFICATION

This equipment has been tested and found to comply with the limits for a Class B digital device pursuant to Part 15 of the FCC Rules. These limits are designed to provide reasonable protection against harmful interference in a residential installation. This equipment generates, uses, and can radiate radio frequency energy and, if not installed and used in accordance with the instructions, may cause harmful interference with radio communications. However, there is no guarantee that interference will not occur in a particular installation. If this equipment does cause harmful interference to radio or television reception, which can be determined by turning the equipment off and on, the user is encouraged to try to correct the interference by one or more of the following measures:

- Reorient or relocate the receiving antennas.
- Increase the separation between the equipment and receiver.
- Connect the equipment into an outlet on a circuit different from that to which the receiver is connected.
- Consult the dealer or an experienced radio/TV technician for help.

You are cautioned that any changes or modifications not expressly approved in this manual could void your authority to operate this equipment.

Safety

- Operate the TV only on 120 V AC.
- The plug is designed, for safety purposes, to fit into the wall outlet only one way. If you are unable to insert the plug fully into the outlet, contact your dealer.
- If any liquid or solid object should fall inside the cabinet, unplug the TV immediately and have it checked by qualified service personnel before operating it further.

Installing

- To prevent internal heat buildup, do not block the ventilation openings.
- Do not install the TV in a hot or humid place, or in a place subject to excessive dust or mechanical vibration.
- The AC power cord is attached to the rear of the TV with hooks. Do not attempt to remove the cord from these hooks. Doing so could cause damage to the TV

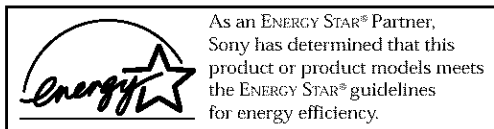

As an ENERGY STAR® Partner, Sony has determined that this product or product models meets the ENERGY STAR® guidelines for energy efficiency.

ENERGY STAR® is a U.S. registered mark.

Owner's Record

The model and serial numbers are provided on the front of this instruction manual and at the rear of the TV. Refer to them whenever you call upon your Sony dealer regarding this product.

About this Manual

This manual is for models KV-36FS13 and KV-36FS17. The menu and illustrations shown are for model KV-36FS17 to show the maximum features available. Differences in operation will be indicated in the text, for example, "For KV-36FS13 only."

Important Safeguards

For your protection, please read these instructions completely, and keep this manual for future reference.

Carefully observe and comply with all warnings, cautions and instructions placed on the set or described in the operating instructions or service manual.

WARNING

To guard against injury, the following basic safety precautions should be observed in the installation, use and servicing of the set.

Use

Power Sources

This set should be operated only from the type of power source indicated on the serial/model plate. If you are not sure of the type of electrical power supplied to your home, consult your dealer or local power company. For those sets designed to operate from battery power, refer to the operating instructions.



Grounding or Polarization

This set is equipped with a polarized AC power cord plug (a plug having one blade wider than the other), or with a three-wire grounding type plug (a plug having a third pin for grounding). Follow the instructions below:

For the set with a polarized AC power cord plug

This plug will fit into the power outlet only one way. This is a safety feature. If you are unable to insert the plug fully into the outlet, try reversing the plug. If the plug still fails to fit, contact your electrician to have a suitable outlet installed. Do not defeat the safety purpose of the polarized plug by forcing it in.



Alternate Warning

For the set with a three-wire grounding type AC plug

This plug will only fit into a grounding-type power outlet. This is a safety feature. If you are unable to insert the plug into the outlet, contact your electrician to have a suitable outlet installed. Do not defeat the safety purpose of the grounding plug.



Overloading

Do not overload wall outlets, extension cords or convenience receptacles beyond their capacity, since this can result in fire or electric shock.

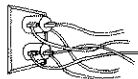

Always turn the set off when it is not being used. When the set is left unattended and unused for long periods of time, unplug it from the wall outlet as a precaution against the possibility of an internal malfunction that could create a fire hazard.



If a snapping or popping sound from a TV set is continuous or frequent while the TV is operating, unplug the TV and consult your dealer or service technician. It is normal for some TV sets to make occasional snapping or popping sounds, particularly when being turned on or off.

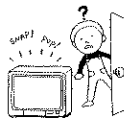

Object and Liquid Entry

Never push objects of any kind into the set through the cabinet slots as they may touch dangerous voltage points or short out parts that could result in a fire or electric shock. Never spill liquid of any kind on the set.

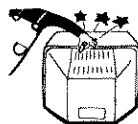

Cleaning

Unplug the set from the wall outlet before cleaning or polishing it. Do not use liquid cleaners or aerosol cleaners. Use a cloth lightly dampened with water for cleaning the exterior of the set.



Installation

Attachments

Do not use attachments not recommended by the manufacturer, as they may cause hazards.

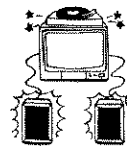

Water and Moisture

Do not use power-line operated sets near water — for example, near a bathtub, washbowl, kitchen sink, or laundry tub, in a wet basement, or near a swimming pool, etc.

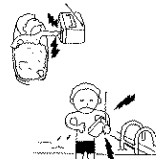

Accessories

Do not place the set on an unstable cart, stand, table or shelf. The set may fall, causing serious injury to a child or an adult and serious damage to the set. Use only a cart or stand recommended by the manufacturer for the specific model of TV. An appliance and cart combination should be moved with care. Quick stops, excessive force, and uneven surfaces may cause the appliance and cart combination to overturn.



Ventilation

The slots and openings in the cabinet and in the back or bottom are provided for necessary ventilation. To ensure reliable operation of the set, and to protect it from overheating, these slots and openings must never be blocked or covered.

- Never cover the slots and openings with a cloth or other materials.
- Never block the slots and openings by placing the set on a bed, sofa, rug or other similar surface.
- Never place the set in a confined space, such as a bookcase or built-in cabinet, unless proper ventilation is provided.
- Do not place the set near or over a radiator or heat register, or where it is exposed to direct sunlight.



Power-Cord Protection

Do not allow anything to rest on or roll over the power cord, and do not place the set where the power cord is subject to wear or abuse.

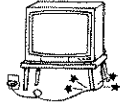

Antennas

Outdoor Antenna Grounding

If an outdoor antenna is installed, follow the precautions below. An outdoor antenna system should not be located in the vicinity of overhead power lines or other electric light or power circuits, or where it can come in contact with such power lines or circuits.

WHEN INSTALLING AN OUTDOOR ANTENNA SYSTEM, EXTREME CARE SHOULD BE TAKEN TO KEEP FROM CONTACTING SUCH POWER LINES OR CIRCUITS AS CONTACT WITH THEM IS ALMOST INVARIABLY FATAL.

Be sure the antenna system is grounded so as to provide some protection against voltage surges and built-up static charges. Section 810 of the National Electrical Code (NEC) in USA and Section 54 of the Canadian Electrical Code in Canada provides information with respect to proper grounding of the mast and supporting structure, grounding of the lead-in wire to an antenna discharge unit, size of grounding conductors, location of antenna discharge unit, connection to grounding electrodes, and requirements for the grounding electrode.

Antenna Grounding According to the NEC

Refer to section 54-300 of Canadian Electrical Code for Antenna Grounding.

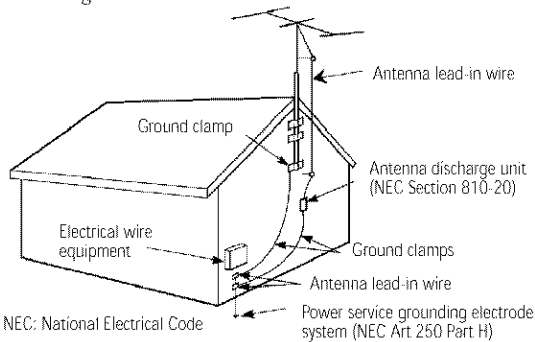

NEC: National Electrical Code

Lightning

For added protection for this television receiver during a lightning storm, or when it is left unattended and unused for long periods of time, unplug it from the wall outlet and disconnect the antenna. This will prevent damage to the receiver due to lightning and power-line surges.

Service

Damage Requiring Service

Unplug the set from the wall outlet and refer servicing to qualified service personnel under the following conditions:

- When the power cord or plug is damaged or frayed.
- If liquid has been spilled into the set.
- If the set has been exposed to rain or water.
- If the set has been subject to excessive shock by being dropped, or the cabinet has been damaged.
- If the set does not operate normally when following the operating instructions. Adjust only those controls that are specified in the operating instructions. Improper adjustment of other controls may result in damage and will often require extensive work by a qualified technician to restore the set to normal operation.
- When the set exhibits a distinct change in performance, it indicates a need for service.



Servicing

Do not attempt to service the set yourself since opening the cabinet may expose you to dangerous voltage or other hazards. Refer all servicing to qualified service personnel.

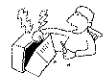

Replacement Parts

When replacement parts are required, be sure the service technician certifies in writing that he has used replacement parts specified by the manufacturer that have the same characteristics as the original parts.

Unauthorized substitutions may result in fire, electric shock or other hazards.

Safety Check

Upon completion of any service or repairs to the set, ask the service technician to perform routine safety checks (as specified by the manufacturer) to determine that the set is in safe operating condition, and to so certify. When the set reaches the end of its useful life, improper disposal could result in a picture tube implosion. Ask a qualified service technician to dispose of the set.



Contents

Introducing the FD Trinitron Wega

Overview	1
Presenting the FD Trinitron Wega.....	2
Package Contents	3
Using the Remote Control	3

Installing the TV

Overview	9
TV Controls and Connectors	10
Basic Connections (Connecting a Cable or Antenna)	12
Connecting a VCR and Cable.....	16
Connecting a VCR and Cable Box (KV-36FS17 only)	17
Connecting Two VCRs for Tape Editing	20
Connecting a Satellite Receiver	21
Connecting a Satellite Receiver with a VCR...22	
Connecting an Audio Receiver	24
Connecting a DVD Player with Component Video Connectors.....	25
Connecting a DVD Player with A/V Connectors	26
Connecting a Camcorder	27
Setting Up the TV Automatically	28

Using the Features

Overview	29
Using Favorite Channels	30
Using Picture in Picture (PIP) (KV-36FS17 only)	31

Using the Menus

Overview	35
Using the Video Menu	36
Using the Audio Menu	38
Using the Channel Menu.....	40
Using the Parent Menu	42
Using the Timer Menu	45
Using the Setup Menu.....	46
Using the Basic Menu.....	48

Other Information

Overview	49
Programming the Remote Control	50
Operating Other Components with Your TV Remote Control.....	52
Troubleshooting	54
Specifications	56
Index	57

Introducing the FD Trinitron Wega

Overview

This chapter defines the contents of your Wega TV and provides an overview of how to set up and use basic features.

<i>Topic</i>	<i>Page</i>
Presenting the FD Trinitron Wega	2
Package Contents	3
Using the Remote Control	3

Presenting the FD Trinitron Wega

The FD Trinitron Wega (pronounced VAY-GAH) is characterized by outstanding contrast, uncompromising accuracy, and corner-to-corner detail.

You will recognize the superiority of Wega technology almost immediately. The first thing you will probably notice is minimal glare from the flat picture tube. This flat-screen technology improves picture detail without distortion, unlike conventional curved screens. The FD Trinitron delivers outstanding image detail not only at the screen center, but also at the corners — so you can enjoy a bright, clear picture from any location in a room.

Features

Some of the features that you will enjoy with your new TV include:

- ❑ **16:9 Enhancement:** Vertical Compression technology that maximizes picture resolution on “anamorphic” or “enhanced for widescreen” sources, including selected DVDs.
- ❑ **Velocity Modulation:** Vertical line enhancement that sharpens picture definition.
- ❑ **Parental Control:** V-Chip technology allows parents to block unsuitable programming for younger viewers.
- ❑ **Component Video Input:** Offers the best video quality for DVD player connections.
- ❑ **S-VIDEO Input:** Provides a high-quality image for connected equipment.

Also, on the KV-36FS17 model:

- ❑ **Dual Tuner Picture in Picture (PIP):** Allows you to watch two programs at once.
- ❑ **Favorite Channel Preview:** Preview up to eight favorite channels without leaving the current channel.

Package Contents

Along with your new Trinitron TV, the packing box contains a remote control and two AA batteries. These items are all you need to set it up and operate the TV in its basic configuration.

Most peripherals come with the necessary cables to connect them. If you want to set up special configurations, you may need to buy extra cables or connectors. It is best to ensure that you have all needed materials on hand before beginning a special-connection project.

Using the Remote Control

The remote control is the primary mechanism for controlling your TV. Handle the remote control with care. avoid dropping it, getting it wet, placing it in direct sunlight, near a heater, or where the humidity is high.

Inserting Batteries

Insert two size AA (R6) batteries (supplied) by matching the + and - on the batteries to the diagram inside the battery compartment.

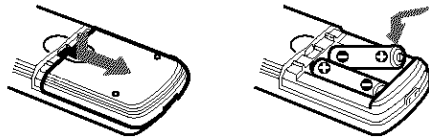

⚠ Remove the batteries to avoid damage from possible battery leakage whenever you anticipate that the remote control will not be used for an extended period.

Button Descriptions

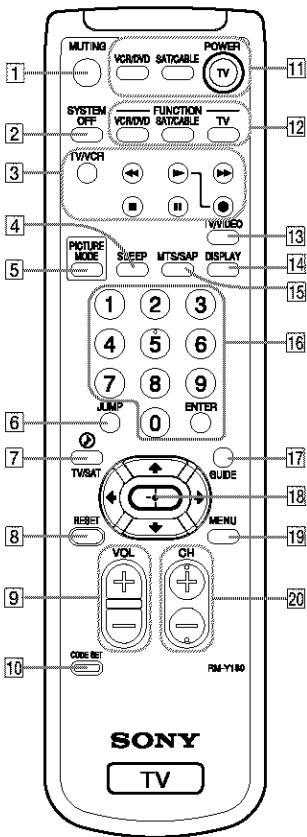









RM-Y180

Model	Remote
KV-36FS13	RM-Y180
KV-36FS17	RM-Y181

(See page 6)

The POWER button on the remote control (no. 11 in the illustration below) activates both the remote control and the TV.

Button	Description
1 MUTING	Mutes the sound. Press again or press VOL + to restore the sound.
2 SYSTEM OFF	Powers off all Sony equipment at once. (This feature may not work with older Sony equipment.)
3 TV/VCR	Switch between TV and VCR mode. If you have a non-Sony VCR, you will need to program the remote control to recognize your VCR. For details, see "Programming the Remote Control" on page 50
	Rewind
	Fast-forward
	Play
	Stop
	Pause (Press again to resume playback or recording)
RECORD	To record, press  and  simultaneously.
4 SLEEP	Press repeatedly until the TV displays the time in minutes (15, 30, 45, 60, or 90) that you want the TV to remain on before shutting off automatically. Cancel by pressing until SLEEP OFF appears.
5 PICTURE MODE	Cycles through the available video picture modes: Vivid, Standard, Movie, Sports. Also available in the Video menu. For details, see "Selecting Video Options" on page 36.
6 JUMP	Press to jump back and forth between two channels. The TV alternates between the current channel and the last channel that was selected.
7 TV/SAT	Switches between the TV and SAT (satellite) inputs when in SAT FUNCTION mode.
	Provides quick access for changing available audio settings. For details, see "Selecting Audio Options" on page 38.
8 RESET	Press when in a menu to reset the settings to the factory defaults.
9 VOL +/-	Adjusts the volume.
10 CODE SET	Used for programming the remote control to operate non-Sony video equipment. For details, see "Programming the Remote Control" on page 50.
11 POWER buttons (GREEN)	Turn on and off the TV and other audio/video equipment.

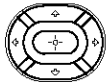
<i>Button</i>	<i>Description</i>
12 FUNCTION buttons (WHITE)	Select the equipment (TV, VCR/DVD, SAT/CABLE) that you want to operate. The indicator lights up momentarily when pressed to show which device the remote control is operating.
13 TV/VIDEO	Cycles through the video equipment connected to your TV's video inputs.
14 DISPLAY	Press once to display the current time and channel label (if set) and channel number. Press again to turn Display off. For details on setting the time, see "To set the Current Time" on page 45.
15 MTS/SAP	Cycles through the Multi-channel TV Sound (MTS) options: Stereo, Auto-SAP (Second Audio Program), and Mono. For details, see "Using the Audio Menu" on page 38.
16 0 - 9 and ENTER	Press 0 - 9 to select a channel, the channel changes after 2 seconds. Press ENTER to select immediately.
17 GUIDE	Displays the program guide of your satellite antenna.
18 	Arrows and Select. Pressing down on the center button selects the item.
19 MENU	Press to display the TV menu. Press again to exit from the menus.
20 CH +/-	Scan through channels.

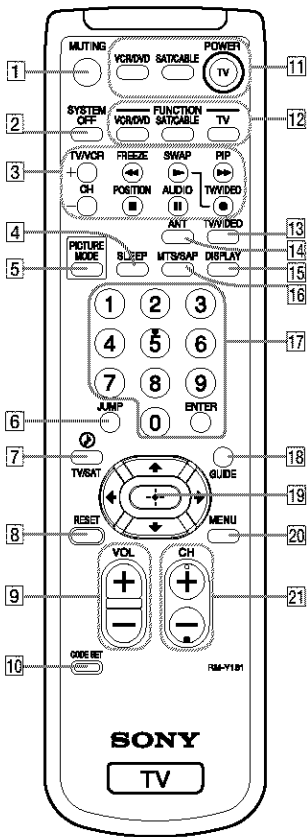

RM-Y181

The POWER button on the remote control (no. 11 in the illustration below) activates both the remote control and the TV.

Button	Description
1 MUTING	Mutes the sound. Press again or press VOL + to restore the sound.
2 SYSTEM OFF	Powers off all Sony equipment at once. (This feature may not work with older Sony equipment.)
3 TV/VCR CONTROLS and PIP CONTROLS	
AUDIO	Alternates sound between the main picture and the window picture.
CH +/-	Changes the channel in the window picture.
FREEZE	Freezes the window picture. Press again to restore the picture.
PIP	Turns on/off PIP. For details, see "Using Picture in Picture (PIP)" on page 31.
POSITION	Moves the location of the window picture.
SWAP	Switches the position of the main picture with the window picture.
TV/VCR	Changes the VHF/UHF output of the VCR.
TV/VIDEO	In the window picture, cycles through the video equipment connected to your TV's video inputs: TV, VIDEO 1, VIDEO 2, VIDEO 3, VIDEO 4.
4 SLEEP	Press repeatedly until the TV displays the time in minutes (15, 30, 45, 60, or 90) that you want the TV to remain on before shutting off automatically. Cancel by pressing until SLEEP OFF appears.
5 PICTURE MODE	Cycles through the available video picture modes: Vivid, Standard, Movie, Sports. Also available in the Video menu. For details, see "Selecting Video Options" on page 36.
6 JUMP	Press to jump back and forth between two channels. The TV alternates between the current channel and the last channel that was selected.
7 TV/SAT	Switches between the TV and SAT (satellite) inputs when in SAT FUNCTION mode.
	Provides quick access for changing available audio settings. For details, see "Selecting Audio Options" on page 38.
8 RESET	Press when in a menu to reset the settings to the factory defaults.
9 VOL +/-	Adjusts the volume.
10 CODE SET	Used for programming the remote control to operate non-Sony video equipment. For details, see "Programming the Remote Control" on page 50.

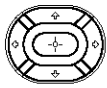
<i>Button</i>	<i>Description</i>
11 POWER buttons (GREEN)	Turn on and off the TV and other audio/video equipment.
12 FUNCTION buttons (WHITE)	Select the equipment (TV, VCR/DVD, SAT/CABLE) that you want to operate. The indicator lights up momentarily when pressed to show which device the remote control is operating.
13 TV/VIDEO	Cycles through the video equipment connected to your TV's video inputs.
14 ANT	Changes the VHF/UHF input to the AUX input.
15 DISPLAY	Press once to display the current time and channel label (if set) and channel number. Press again to turn Display off. For details on setting the time, see "To set the Current Time" on page 45.
16 MTS/SAP	Cycles through the Multi-channel TV Sound (MTS) options: Stereo, Auto-SAP (Second Audio Program), and Mono. For details, see "Using the Audio Menu" on page 38.
17 0 - 9 and ENTER	Press 0 - 9 to select a channel, the channel changes after 2 seconds. Press ENTER to select immediately.
18 GUIDE	Displays the program guide of your satellite antenna.
19 	Arrows and Select. Pressing down on the center button selects the item.
20 MENU	Press to display the TV menu. Press again to exit from the menus.
21 CH+/-	Changes the channel in the main picture.

Installing the TV

Overview

This chapter includes illustrated instructions for setting up your TV.

<i>Topic</i>	<i>Page</i>
TV Controls and Connectors	10
Basic Connections (Connecting a Cable or Antenna)	12
Connecting a VCR and Cable	16
Connecting a VCR and Cable Box (KV-36FS17 only)	17
Connecting Two VCRs for Tape Editing	20
Connecting a Satellite Receiver	21
Connecting a Satellite Receiver with a VCR	22
Connecting an Audio Receiver	24
Connecting a DVD Player with Component Video Connectors	25
Connecting a DVD Player with A/V Connectors	26
Connecting a Camcorder	27
Setting Up the TV Automatically	28

Note About the AC Power Cord

The AC power cord is attached to the rear of the TV with hooks. Use caution when removing the AC plug from its holder. Gently slide the cord in the upward direction without removing the cord from the two lower hooks.

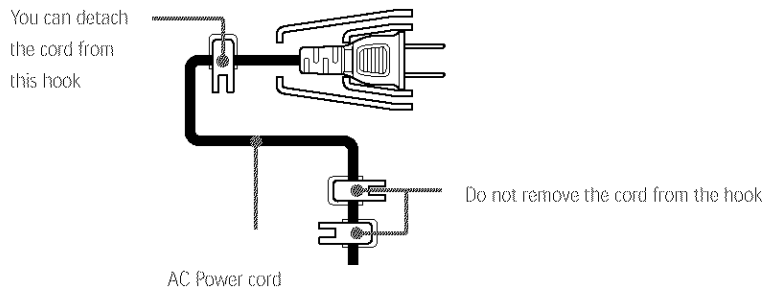

TV Controls and Connectors

Front Panel Menu Controls

The front panel menu controls allow access to the on-screen menus without the use of a remote control. Pressing the MENU button brings up the on-screen menus. The arrow buttons (↕) move the on-screen cursor in the menus and the (+) button selects the menu item.

TV Rear Panel

Model KV-36FS13

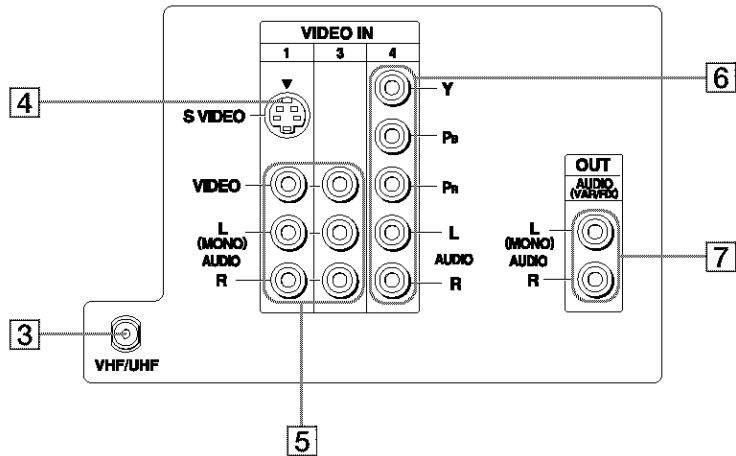

Model KV-36FS17

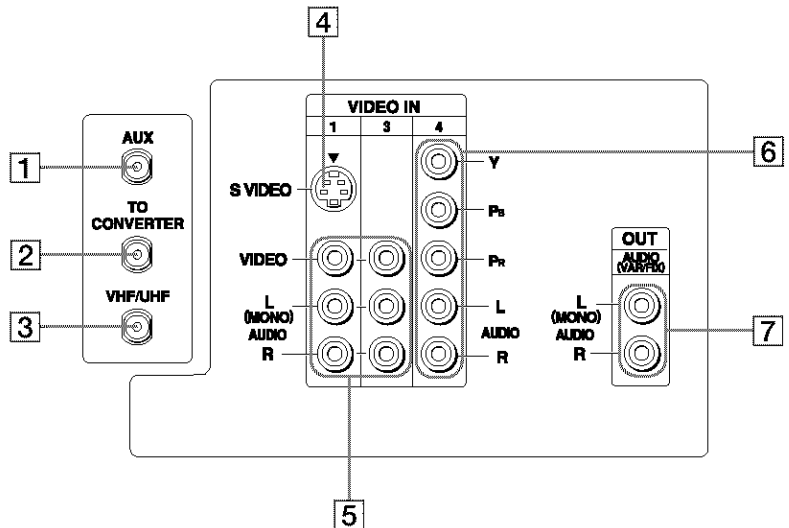

Back Panel Descriptions

<i>Connection</i>	<i>Description</i>
1 AUX (KV-36FS17)	Allows you to view local and cable channels if your cable provider does not feature local channels. You can switch between local and cable channels easily by pressing ANT on the remote control. Devices connected to the AUX input cannot be viewed in PIP.
2 TO CONVERTER (KV-36FS17)	This is a VHF/UHF out jack that lets you set up your TV to switch between scrambled channels (through a cable box) and normal cable channels (CATV). Use this jack instead of a splitter to get better picture quality when needing to switch between scrambled and unscrambled cable channels.
3 VHF/UHF	Connects to your VHF/UHF antenna or cable.
4 S VIDEO	Connects to the S VIDEO OUT jack of your VCR or other S VIDEO-equipped video component. Provides better picture quality than the VHF/UHF jacks or the Video IN jack.
5 AUDIO (L/R)/ VIDEO	Connects to the audio and video OUT jacks on your VCR or other video component. A third video input (VIDEO 2) is located on the front panel of the TV. The Audio and Video IN jacks provide better picture quality than the VHF/UHF jack.
6 Y, PB, PR, L, R	Connects to your DVD player's or Digital Set-top box's component video (Y, PB, PR) and audio (L/R) jacks.
7 AUDIO OUT (VAR/FIX) L (MONO)/R	Connects to the left and right audio inputs of your audio or video component. You can use these outputs to listen to your TV's audio through your stereo system.

Basic Connections (Connecting a Cable or Antenna)

Connecting Directly to Cable or an Antenna

The connection you choose depends on the cable found in your home.

Newer homes usually have standard coaxial cable:

VHF Only or VHF/UHF or Cable

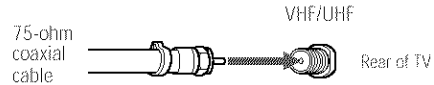

Older homes may have 300-ohm, twin-lead cable:

VHF Only or UHF Only or VHF/UHF

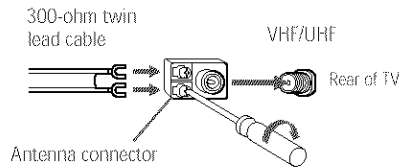

Other homes may have both:

VHF and UHF

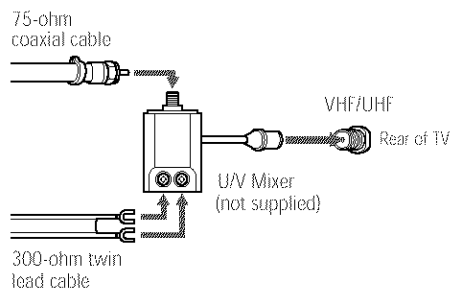

Cable and Antenna (KV-36FS17 only)

If your cable provider does not feature local channels, you may find this set-up convenient.

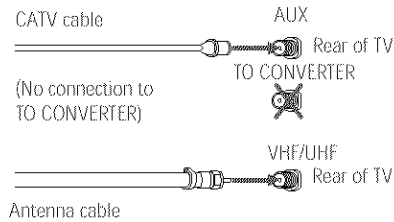

To receive channels using an antenna, instead of using the CATV cable

- 1 Select antenna mode by pressing the ANT button on the remote control. (This is a toggle: pressing the button once selects antenna mode; pressing the button again selects cable mode.)
- 2 Turn the Cable to OFF (see page 40).
- 3 Perform the Auto Program function (see page 40).

Basic Cable Box Connections

Cable Box and Cable

This is the preferred basic cable TV hookup to use if your cable TV company scrambles some channels, but not all of them (pay channels vs. regular cable channels), and you need to use a cable box.

With this setup you can:

- Use the TV remote control to change channels on your cable box when the signal is scrambled.
- Use the TV remote control to change channels using your TV when the signal is not scrambled. (Your TV's tuner provides a better signal than the cable box.)
- Use the PIP feature normally with the CATV input.
- Use the PIP feature partially with the cable box. (When you switch the TV input to AUX — to use the cable box — the scrambled picture will display only in the main window. If you turn on the PIP, you will be able to see any of the regular channels in the PIP window, but you cannot SWAP the pictures between the main and PIP windows.)

- 1 Connect the Cable TV cable to the TV's VHF/UHF jack.
- 2 Using a coaxial cable, connect the TV's TO CONVERTER jack to the cable box's IN jack. The TV's internal converter allows you to switch between unscrambled signals coming straight into the TV and scrambled signals coming into the TV through the cable box, eliminating the need for an external splitter.
- 3 Using a coaxial cable, connect the cable box's OUT jack to the TV's AUX jack.

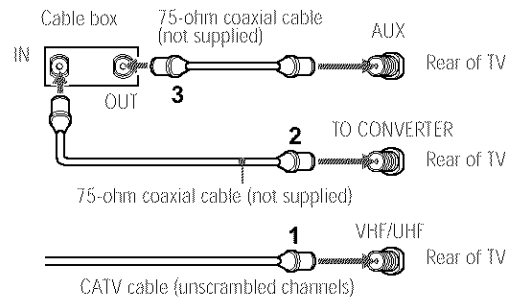

To switch between channels from cable box and channels from regular cable

- Press the ANT button on the TV remote control. (This is a toggle: pressing the button once selects the cable box; pressing the button again selects regular cable.)

To use the cable box

- Have your TV tuner set to channel 3 or 4 (as appropriate) and then use the cable box to switch channels.

To use the TV remote control to switch channels on the cable box

- Program the remote control as necessary. (See “Programming the Remote Control” on page 50.) Then use the remote control to switch cable box channels.

To prevent the accidental switching of TV channels

- When using the cable box, you need your TV to stay on a required channel (usually channel 3 or 4). You can use the TV's Channel Fix feature to lock in a specific channel. The Channel Fix feature is under the Channel menu. For details, see “Using the Channel Menu” on page 40.

Cable Box only

Use this hookup if:

- ❑ You subscribe to a cable TV system that scrambles or encodes all signals, requiring a cable box to view all channels, and
- ❑ You do not intend to hook up any other audio or video equipment to your TV.

When all channels are routed through your cable box, only one unscrambled signal is sent to the TV, so you cannot use the PIP feature. If some of your channels are scrambled, but others are not, consider using the hookup “Cable Box and Cable” on page 13 instead.

- 1 Connect the coaxial connector from your cable service to the cable box’s IN jack.
- 2 Using a coaxial cable, connect the cable box’s OUT jack to the TV’s VHF/UHF jack.

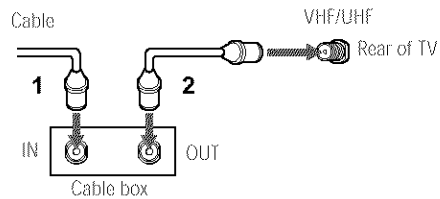

Connecting a VCR and Cable

Use this hookup if you subscribe to a cable TV (CATV) system that does not require a cable box.

- 1 Connect the CATV cable to the VCR's IN jack.
- 2 Using a coaxial cable, connect the VCR's OUT jack to the TV's VHF/UHF jack.
- 3 Using an A/V cable, connect the VCR's Audio and Video OUT jacks to the TV's Audio and Video IN jacks.

⚠ If the VCR you are connecting has an S VIDEO jack, you can use an S VIDEO cable for improved picture quality (compared to a combination audio/video cable). Because S VIDEO cables carry only the video signal, you will need audio cables for sound.

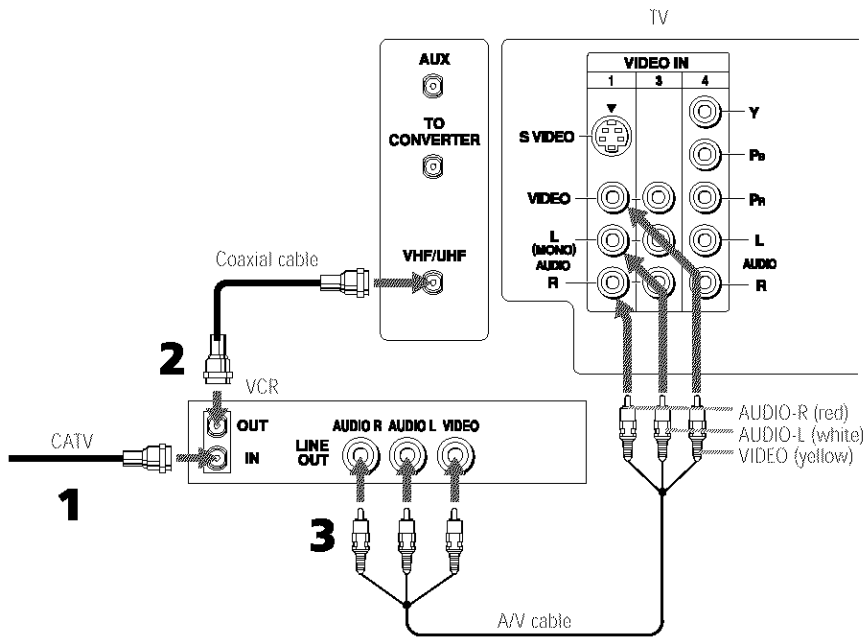

Connecting a VCR and Cable Box (KV-36FS17 only)

Use this hookup if:

- Your cable TV company scrambles some channels, but not all of them (pay channels vs. regular cable channels) and you therefore need to use a cable box, and
- You want to use the PIP feature.

With this setup you can:

- Use the TV remote control to change cable box channels when the signal is scrambled.
- Use the TV remote control to change TV channels when the signal is not scrambled. (Your TV's tuner provides a better signal than the cable box.)
- Use the PIP feature.
- Record both regular CATV and scrambled channels.

To connect a cable box and a VCR, you will need:

- A small, inexpensive device known as a splitter.
 - Three coaxial cables.
 - Either a combination audio/video cable, or an S VIDEO cable and audio cables.
- 1 Connect the CATV cable to the single (input) jack of the splitter.
 - 2 Use a coaxial cable to connect one of the two output jacks of the splitter to the TV's VHF/UHF jack.
 - 3 Use a coaxial cable to connect the other output jack of the splitter to the input jack of the cable box.
 - 4 Use a coaxial cable to connect the output jack of the cable box to the input jack of the VCR.
 - 5 Use the video line (yellow) of a combination audio/video (A/V) cable to connect the video output jack of the VCR to the video input jack of the TV.

 If the VCR has an S VIDEO jack, you can use an S VIDEO cable to improve picture quality; replace the yellow video cable of the combination A/V cable with the S VIDEO cable. You will still need audio cables for sound.

Connect the left (white) and right (red) audio output channels of the VCR to the respective input channels on the TV.

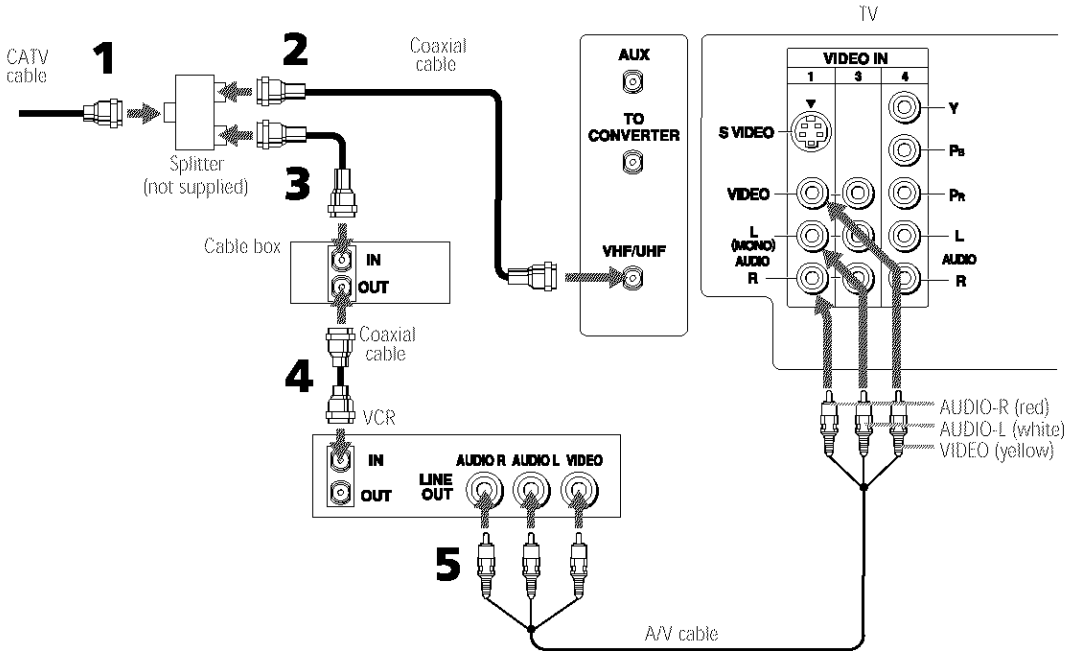

To view cable box channels

- Turn on the VCR and set it to the channel the cable box uses (channel 3 or 4). Set the TV to VIDEO 1. Use the cable box to switch channels.

To use the TV remote control to switch channels on the cable box

- Program the remote control as necessary. (See “Programming the Remote Control” on page 50.) Then use the remote control to switch cable box channels.

To use the TV remote control to switch channels on the VCR

- Program the remote control as necessary. (By default, the remote control is set for a Sony VCR; to change to another brand see “Programming the Remote Control” on page 50.) Then use the VCR buttons on the remote control to switch VCR channels.

To use PIP with the Cable Box

- Turn on the cable box and VCR. Use the remote control's TV/VIDEO (yellow) button to set the PIP output to VIDEO 1. Change the PIP channel via the cable box. (The cable box's tuner is used as the PIP video source; if you do not turn on the cable box, the PIP will not work.)

 This system is needed because the cable box unscrambles only one channel at a time (unlike regular cable, which makes all channels available concurrently).

Connecting Two VCRs for Tape Editing

If you connect two VCR's together, so you can record from one to the other, you may want to monitor the recording process. You can connect the recording VCR into your TV and then view what is being recorded. The procedure below shows you how to do this.

- 1 Using an A/V cable, connect the playback VCR's Audio and Video OUT jacks to the recording VCR's Audio and Video IN jacks.
- 2 Using an A/V cable, connect the recording VCR's Audio and Video OUT jacks to the TV's Audio and Video IN jacks.

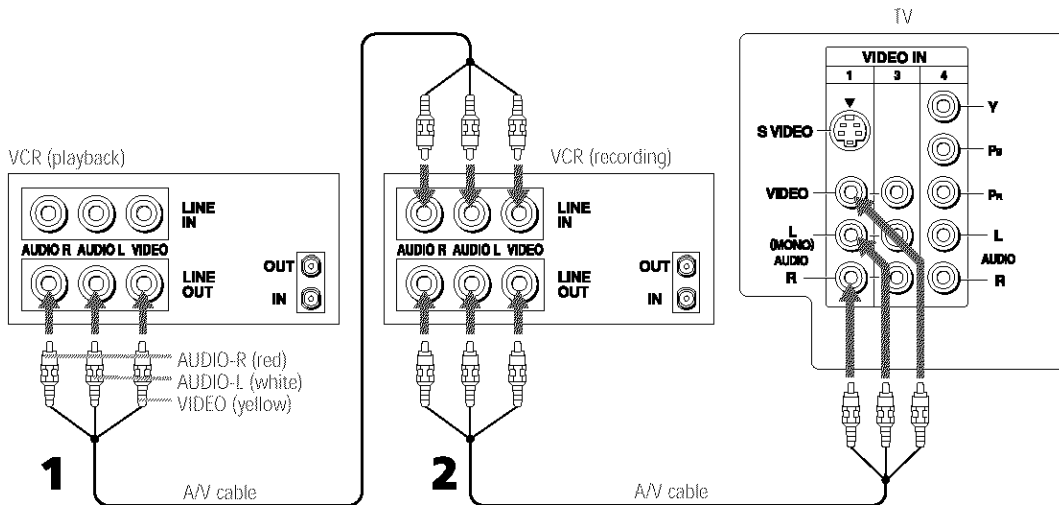

To change the video input of the VCR.

- See your VCR's user's guide for instructions.

To view what is being recorded

- Use the remote control to set the TV to the video input to which the recording VCR is connected. (VIDEO 1 in the illustration above.)

 If the VCRs you are connecting have S VIDEO jacks, you can use S VIDEO cables to improve picture quality; replace the yellow video cable of the combination A/V cable with the S VIDEO cable. You will still need audio cables for sound.

Connecting a Satellite Receiver

- 1 Connect the satellite antenna cable to the satellite receiver's SATELLITE IN jack.
- 2 Using an A/V cable, connect the satellite receiver's Audio and Video OUT jacks to the TV's Audio and Video IN jacks.
- 3 Connect a coaxial cable from your cable or antenna to the TV's VHF/UHF jack.

⚠ If the satellite receiver has an S VIDEO jack, you can use an S VIDEO cable to improve picture quality; replace the yellow video cable of the combination A/V cable with the S VIDEO cable. You will still need audio cables for sound.

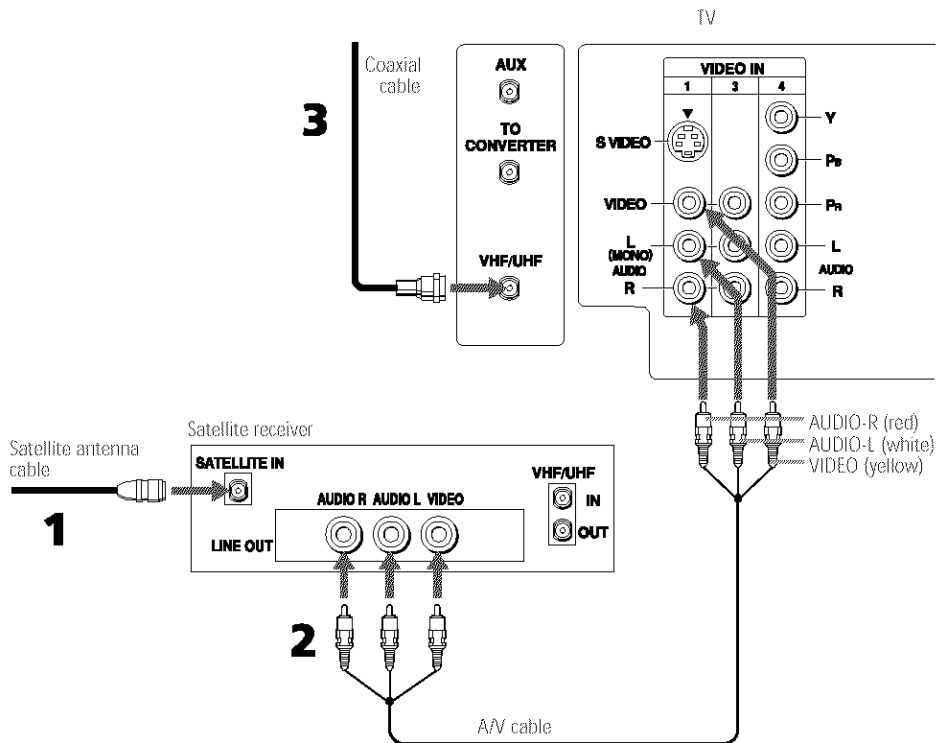

Connecting a Satellite Receiver with a VCR

- 1 Connect the satellite antenna cable to the satellite receiver's SATELLITE IN jack.
- 2 Connect the CATV cable to the VCR's VHF/UHF IN jack.
- 3 Using a coaxial cable, connect the VCR's OUT jack to the TV's VHF/UHF jack.
- 4 Using an A/V cable, connect the satellite receiver's Audio and Video OUT jacks to the VCR's Audio and Video IN jacks.
- 5 Using an A/V cable, connect the VCR's Audio and Video OUT jacks to the TV's Audio and Video IN jacks.

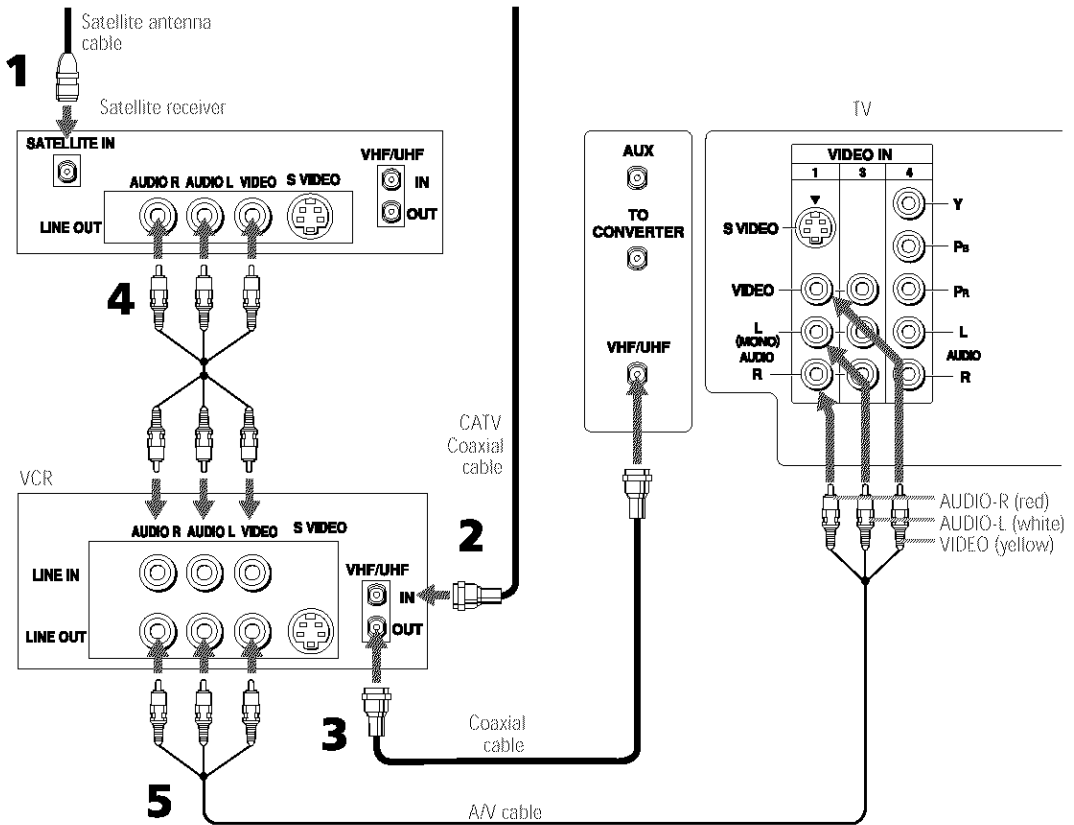

 If the satellite receiver and VCR have S VIDEO jacks, you can use an S VIDEO cable to improve picture quality; replace the yellow video cable of each combination A/V cable with the S VIDEO cable. You will still need audio cables for sound.

To change VCR video input

- See your VCR's user's guide for instructions.

To watch satellite TV, or the VCR

- Use the TV/VIDEO on the remote control to select video source.

To watch cable TV

- Use the TV/VIDEO on the remote control to select VHF/UHF source.

Connecting an Audio Receiver

For improved sound quality, you may want to send the TV's audio signals to your stereo system. The procedure below tells you how.

- 1 Using audio cables, connect the TV's Audio OUT jacks to the audio receiver's Audio LINE IN jacks.

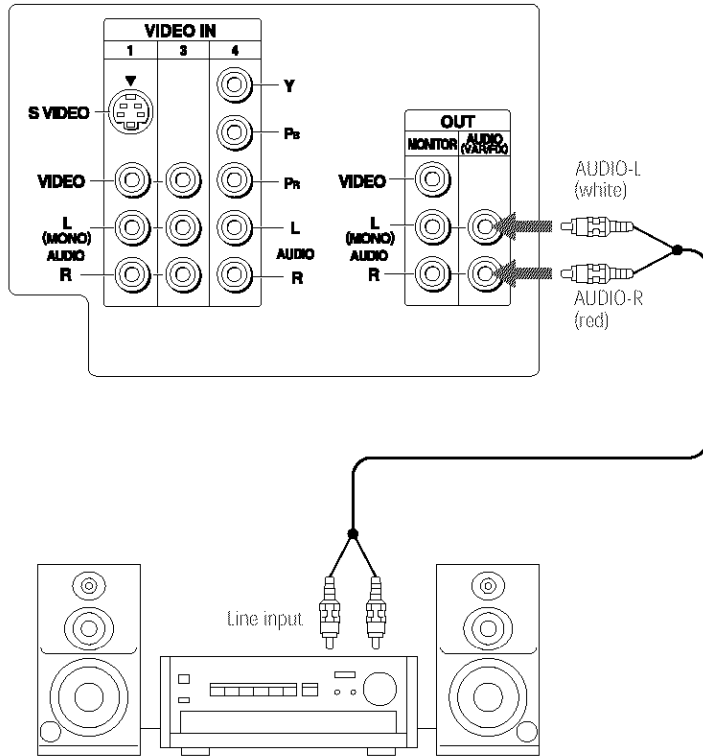

Connecting a DVD Player with Component Video Connectors

This is the preferred hookup to use if your DVD player has component video (Y, P_B, P_R) jacks.

- 1 Using three separate component video cables, connect the DVD player's Y, P_B and P_R jacks to the Y, P_B and P_R jacks on the TV. Use the VIDEO 4 connections.

 The Y, P_B and P_R jacks on your DVD player are sometimes labeled Y, C_B and C_R, or Y, B-Y and R-Y. If so, connect the cables to like colors.

- 2 Using an audio cable, connect the DVD player's Audio OUT jacks to the TV's Audio IN jacks. Be sure to use the same column (VIDEO 4) of inputs that you used for the video connection.

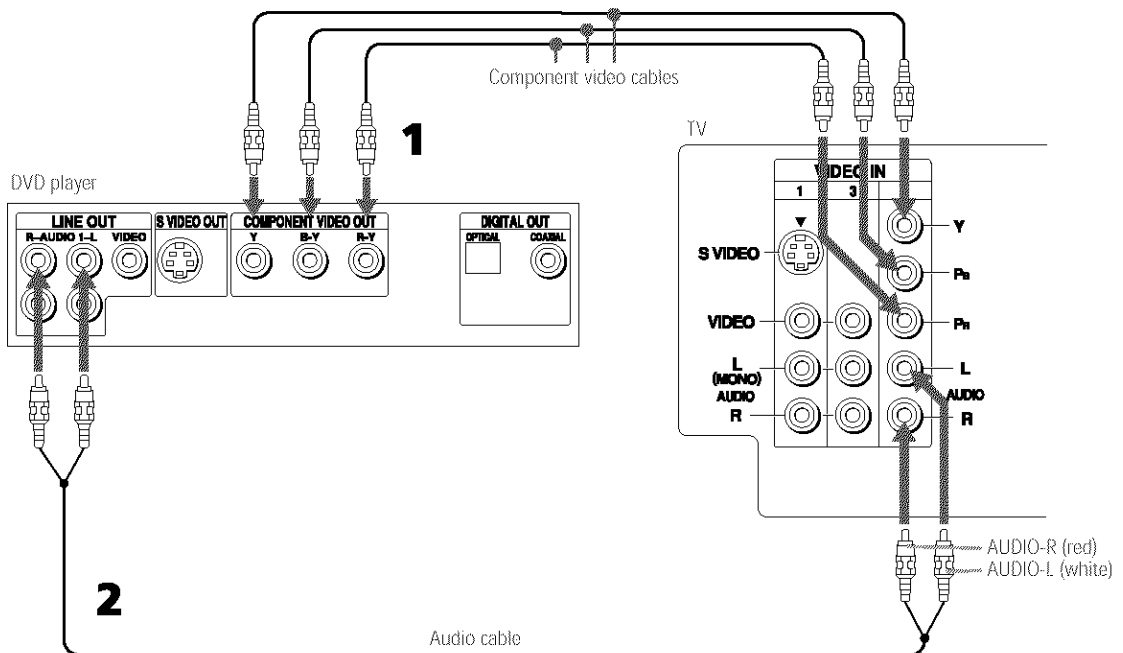

 You cannot record the signal from any equipment connected into the Y, P_B, P_R jacks.

Connecting a DVD Player with A/V Connectors

Use this hookup if your DVD player does not have component video (Y, Pb, Pr) jacks.

 An S VIDEO connection will give a good quality video signal, but if your DVD player has component video, that connection (described on the previous page) will give an even better video signal.

- 1 Using audio cables, connect the DVD player's Audio OUT jacks to the TV's Audio IN jacks.
- 2 Using an S VIDEO cable, connect the DVD player's S VIDEO jack to the TV's S VIDEO jack.

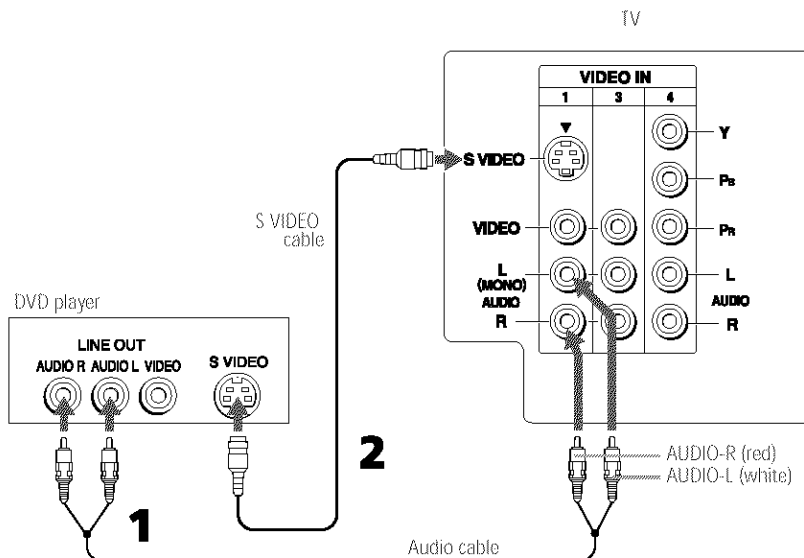

To switch between your TV and DVD

- Use the TV/VIDEO button on the remote control to switch from one input device to another.

Connecting a Camcorder

For easy connection of a camcorder, the TV has front Audio and Video inputs (shown below). If you prefer, however, you can connect the camcorder to the TV's rear Audio and Video IN jacks.

- 1 Using A/V cables, connect the camcorder's Audio and Video OUT jacks to the TV's Audio and Video IN jacks.

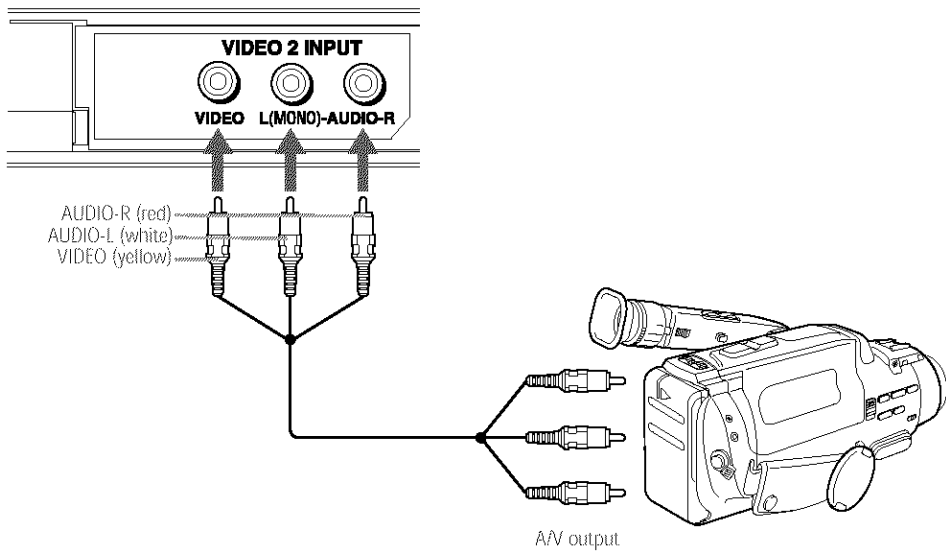

If you have a mono camcorder, connect its audio output to the TV's AUDIO L jack.

 If the camcorder has an S VIDEO jack, you can use an S VIDEO cable to improve picture quality; replace the yellow video cable of the combination A/V cable with the S VIDEO cable. You will still need audio cables for sound.

To view the camera's output

- Use the TV's remote control to set the appropriate input on the TV (VIDEO 2, in the illustration).

Setting Up the TV Automatically

After you finish connecting your TV, you need to run Auto Setup to set up your channels. The Auto Setup screen appears when you turn your TV on for the first time after installing it. If you do not want to set up the channels at this time, you can do it later by using the Auto Program feature in the Channel menu (see page 40).

 The Auto Setup feature does not apply for installations that use a cable box for all channel selection.

Using Auto Setup

- 1 Press POWER to turn on the TV.
- 2 Press the TV function button on the remote control.
- 3 Press CH+ on the front of your TV to run the Auto Setup or press CH- to exit. If you use the channel buttons on your remote control, be sure to use the main set of buttons.

To reset the TV to factory settings

- 1 Turn the TV on.
- 2 Hold down the RESET button on the remote control.
- 3 Press and release the POWER button on the TV. (The TV will turn itself off, then back on.)
- 4 Release the RESET button.

Using the Features

Overview

This chapter describes how to use special features of your TV.

<i>Topic</i>	<i>Page</i>
Using Favorite Channels	30
Using Picture in Picture (PIP) (KV-36FS17 only)	31

Using Favorite Channels

The Favorite Channel feature lets you select programs from a list of favorite channels that you specify.

To display a list of your favorite channels

- 1 If you have not already done so, create a list of favorite channels. (See the Favorite Channels section of “Selecting Channel Options” on page 40.)
- 2 If any menus are open, close them.
- 3 Press \oplus . (The Favorite Channels options appear.)



- 4 Press \uparrow or \downarrow to highlight the channel you want to watch. (If you have a KV-36FS17 model, the PIP window will open, showing a preview of the highlighted Favorite Channel.)
- 5 When you find the channel you want, press \oplus to select it.

Using Picture in Picture (PIP) (KV-36FS17 only)

Picture in Picture (PIP) allows you to watch two channels simultaneously — one in the main window and another in a secondary (PIP) window.

Displaying Picture in Picture

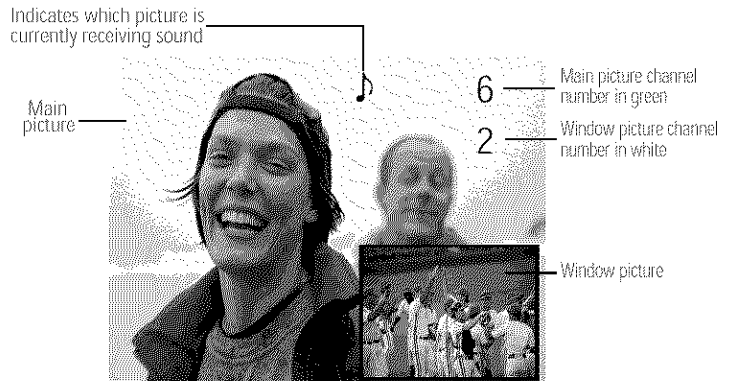

To use PIP:

- 1 Make sure your TV is tuned to a channel that you know is airing programming.
- 2 Press the **PIP** button (or the button labeled PIP). The window picture appears.
- 3 Use the yellow-labeled buttons on your remote control (see diagram) to control the PIP features (which are listed on the next page).

To check your PIP:

- 1 Tune your TV to a channel that you know is airing programming.
- 2 Press **SWAP** and select that same channel as the main window. You should now have the same program playing in both your main window and your picture window.
- 3 Use the PIP (yellow) **CH+/-** buttons to change the channel in the picture window.

 You must press **TV (FUNCTION)** before you can control PIP with the yellow-labeled buttons.

The AUX input cannot be viewed in the PIP window.

(Continued on the next page)

- 4 Now use the main CH+/- buttons of your remote control to change the channel in the main window. If this does not work, check “Troubleshooting” on page 54 for potential solutions.

PIP Functions

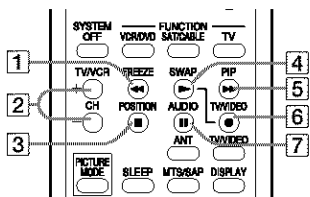

RM-Y181 remote control

<i>Yellow-labeled PIP Button</i>	<i>Description</i>
1 FREEZE	Freezes the window picture. Press again to restore the picture. The main window continues to play as usual.
2 CH +/-	Changes the channel in the window picture. To change the channel in the main window, use the main CH+/- buttons at the bottom of the remote control.
3 POSITION	Moves the location of the window picture among the four corners of the screen.
4 SWAP	Switches the main picture with the window picture. Press again to change them back.
5 PIP	Turns the PIP feature on and off. Press repeatedly to change the window size (1/9, 1/16, OFF).
6 TV/VIDEO	Cycles through available video equipment you have connected to the TV.
7 AUDIO	Alternates sound between the main picture and the window picture. The sound symbol (🔊) appears for 3 seconds, indicating whether you are hearing sound from the main picture or the window picture.

To change channels/programs in the PIP window

- Use the yellow PIP CH+/- button to scroll through the TV channels.
- Use the yellow TV/VIDEO button to cycle through your other video equipment connected to the TV, such as your VCR, DVD player or Satellite Receiver.

Setups that affect your ability to use PIP

- Any video equipment you have connected to the AUX input cannot be viewed in the PIP window.
- If you are viewing all channels through a cable box, the PIP feature will not work. The cable box only unscrambles one signal at a time, so the window picture will be the same as the main picture.
- You can use PIP to see pictures from different sources on your TV. For example, you can have a regular (CATV) channel and the output from a VCR or DVD player or satellite receiver on screen at the same time using PIP. To do this:

- 1 Connect the CATV cable to the UHF/VHF input on the back of the TV.
- 2 Connect the peripheral (VCR or DVD player or satellite receiver) to any of the VIDEO IN inputs on the the back of the TV.
- 3 Tune to one image in the main picture.
- 4 Tune to a second image in the PIP window.

You can then SWAP the images on the TV screen.

 Be sure to label your video sources to make them easier to find in the Display. See "Video Label" on page 47 for labeling instructions.

 You cannot use a signal from the AUX connection with PIP.

Using the Menus

Overview

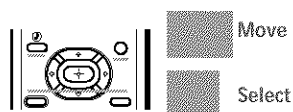

Arrow buttons

To end a menu session:

Press MENU again







To end one menu session
and move to another:

Press \uparrow to return to the
menu icons.

Opening and choosing a menu:

- 1 Press MENU to display the Menu screen.
- 2 Use the arrow buttons to move to the desired menu icon. Press \oplus to select it.
- 3 Use the arrow buttons to scroll up and down through the features.
- 4 See the specific menu page for instructions on moving through the menu.

The Menu gives you access to the following features:

<i>Menu Icon</i>	<i>Description</i>	<i>Page</i>
	Allows you to make adjustments to your picture settings. It also allows you to customize the Picture Mode based on the type of program you are viewing.	36
	Offers enhanced audio options such as listening to second audio programming (SAP) or customizing the Effect of the sound on your TV.	38
	Allows you to set up a Favorite Channel list, run the Auto Program function, and more.	40
	Lets you control the viewing of programs based on their ratings.	42
	Lets you set the clock on your TV and allows you to program your TV for scheduled viewing using the Timers.	45
	Provides several options for setting up your channels, labeling your video inputs, and selecting the language of the on-screen menus.	46
	Provides quick access to frequently used settings.	48



Using the Video Menu

To select the Video Menu

- 1 Press MENU.
- 2 Use the arrow buttons to move to the Video icon  and press \ominus .
- 3 Use the arrow buttons to scroll up and down through the options.
- 4 Press \ominus to select a feature. That feature's adjustment appears.
- 5 Use the arrow buttons to make the desired adjustments.
- 6 Press \ominus to select/set.
- 7 Press MENU to exit the menu screen.

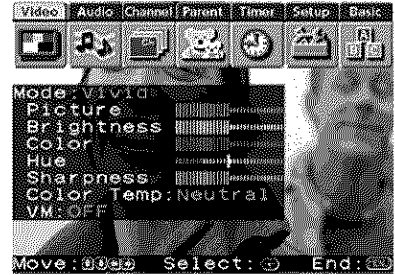

To restore the factory default settings for Picture, Brightness, Color, Hue, Sharpness, Color Temp and VM.

- Press RESET on the remote control when in the Video menu.

Selecting Video Options

 To change from one Video Mode to another, use the PICTURE MODE button on the remote control.

The Video Menu includes the following options.





Option	Description
Mode	Vivid
Customized picture viewing	Select for enhanced picture contrast and sharpness.
	Standard
	Select for standard picture settings.
	Movie
	Select to display a softer picture.
	Sports
	Select to display a brighter, more intense picture.
 You can alter the Video Menu settings (Picture, Brightness, Color, etc.) for each Mode.	
Picture	Adjust to increase picture contrast and deepen the color, or decrease picture contrast and soften the color.
Brightness	Adjust to brighten or darken the picture.
Color	Adjust to increase or decrease color intensity.
Hue	Adjust to increase or decrease the green tones.
Sharpness	Adjust to sharpen or soften the picture.

<i>Option</i>	<i>Description</i>
Color Temp	Choose from three color temperatures:
White	Cool Select to give the white colors a blue tint.
intensity	Neutral Select to give the white colors a neutral tint.
adjustment	Warm Select to give the white colors a red tint (NTSC-Standard).
VM	Sharpens picture definition to give every object a sharp, clean edge. Select from High, Low, OFF.
Velocity	
Modulation	



Using the Audio Menu

To select the Audio Menu



- 1 Press MENU.
- 2 Use the arrow buttons to move to the Audio icon  and press .
- 3 Use the arrow buttons to scroll up and down through the options.
- 4 Press  to select an option. That option's settings appear.
- 5 Use the arrow buttons to scroll through the settings.
- 6 Press  to select the desired setting.
- 7 Press MENU to exit the menu screen.



To restore the factory default settings for Treble, Bass, and Balance

- Press RESET on the remote control when in the Audio menu.

Selecting Audio Options

 As a shortcut to using the menus, use the  button on the remote control to cycle through available audio effects.

The Audio Menu includes the following options:

Option	Description
Treble	Adjust to decrease or increase higher-pitched sounds.
Bass	Adjust to decrease or increase lower-pitched sounds.
Balance	Adjust to emphasize left or right speaker balance.
Effect	Surround Select for Surround sound.
	OFF Normal stereo or mono reception.
MTS <i>Enjoy stereo, bilingual and mono programs</i>	Stereo Select for stereo reception when viewing a program broadcast in stereo.
	Auto-SAP Select to automatically switch the TV to second audio programs when a signal is received. (If no SAP signal is present, the TV remains in Stereo mode.)
	Mono Select for mono reception. (Use to reduce noise during weak stereo broadcasts.)
Speaker	ON Select to turn on the TV speakers.
	OFF Select to turn off the TV speakers and listen to the TV's sound only through your external audio system speakers.

<i>Option</i>	<i>Description</i>
Audio Out	This option can be set only when the Speaker option is set to OFF.
<i>Easy control of volume adjustments</i>	Variable The TV's speakers are turned off, but the volume output from your audio system can still be controlled by the TV's remote control.
	Fixed The TV's speakers are turned off and the volume output of the TV is fixed. Use your audio receiver's remote control to adjust the volume through your audio system.



Using the Channel Menu

To select the Channel Menu

- 1 Press MENU.
- 2 Use the arrow buttons to move to the Channel icon  and press \oplus .
- 3 Use the arrow buttons to scroll up and down through the options.
- 4 Press \oplus to select a feature. That feature's options appear.
- 5 Use the arrow buttons to scroll through the options.
- 6 Press \oplus to select the desired option.
- 7 Press MENU to exit the menu screen.





Selecting Channel Options

The Channel Menu includes the following options:

Option	Description
Favorite Channel	1 Press \oplus to select a favorite channel number.
	2 Use the arrow buttons to scroll through the channels until you find the channel you want to add to your favorites.
	3 Press \oplus to select it.
Cable	ON Select if you are receiving cable channels with a CATV cable.
	OFF Select if you are using an antenna.
 You should run Auto Program after changing the cable setting.	
Channel Fix <i>Useful when you have a cable box or satellite receiver connected</i>	2-6 "Fix" your TV's channel setting to 2 – 6 and use the cable box or Satellite receiver to change channels. Select one of these settings if you have connected the device to the VHF/UHF jack.
	AUX 2-6 Same as 2-6, except you select one of these settings if you have connected the device to the AUX jack (see page 11).
	VIDEO 1 Use this setting if you have connected the device to the Audio and Video IN jacks.
Auto Program	Automatically programs the TV for all receivable channels.

 Channels that you set to be skipped can be accessed only with the 0-9 buttons.



<i>Option</i>	<i>Description</i>
Channel Skip/Add	Removes and adds viewable channels.
	1 Use the arrow buttons to scroll through the channels until you find the channel you want to skip/add.
	2 Press  to select it.
	3 Press the arrow buttons to toggle between “Add” or “Skip.”
	4 Press  to select.
Channel Label	Label up to 40 channels with their station call letters.



Using the Parent Menu

The Parent menu allows you to set up the TV to block programs according to their content and rating levels.

To select the Parent Menu

- 1 Press MENU.
- 2 Use the arrow buttons to move to the Parent icon  and press .
- 3 Use the 0-9 buttons on the remote control to enter your four-digit password.
- 4 Confirm your password by entering it again. (The Parent menu options appear.)
- 5 Use the arrow buttons to scroll through the settings.
- 6 Press  to select the desired setting.
- 7 Press MENU to exit the menu screen.



 You need your password for any future access into the Parent menu. If you lose your password, see "Lost password" on page 55.

Using the Parent Menu

 If you are not familiar with the Parental Guideline rating system, you should select Child, Youth, or Young Adult to help simplify the rating selection. To set more restrictive ratings, select Custom.

 For descriptions of Child, Youth, and Young Adult ratings, see page 43.

The Parent menu includes the following options.

Option	Description
Parental Lock	OFF Parental lock is off. No programs are blocked from viewing.
Turn ratings on/off and select a rating system	Child Maximum ratings permitted are: <input type="checkbox"/> US: TV-Y, TV-G, G <input type="checkbox"/> Canada: C, G
	Youth Maximum ratings permitted are: <input type="checkbox"/> US: TV-PG, PG <input type="checkbox"/> Canada: 8 ans+
	Young Adult Maximum ratings permitted are: <input type="checkbox"/> US: TV-14, PG-13 <input type="checkbox"/> Canada: 14+, 13 ans+
	Custom Select to set ratings manually. <input type="checkbox"/> US: See page 43 for details. <input type="checkbox"/> Canada: See page 44 for details.
Change Password	For changing your password.

US Models: Selecting Custom Rating Options

 The content ratings will increase depending on the level of the age-based rating. For example, a program with a TV-PG V (Violence) rating may contain moderate violence, while a TV-14 V (Violence) rating may contain more intense violence.

 To ensure maximum blocking capability, the age-based ratings should be blocked.

 If you block unrated TV programs, be aware that the following types of programs may be blocked: emergency broadcasts, political programs, sports, news, public service announcements, religious programs and weather.

Viewing Blocked Programs

For US models, the Custom Rating Menu includes the following options. (For Canadian models, see page 44.)

<i>Option</i>	<i>Description</i>
Movie Rating	G All children and General Audience.
	PG Parental Guidance suggested.
	PG-13 Parental Guidance for children under 13.
	R Restricted viewing, parental guidance is suggested for children under 17.
	NC-17 and X No one 17 or under allowed.
TV Rating	Age-Based Options
<i>Block programs by their rating, content or both</i>	TV-Y All children.
	TV-Y7 Directed to older children.
	TV-G General Audience.
	TV-PG Parental Guidance suggested.
	TV-14 Parents Strongly cautioned.
	TV-MA Mature Audience only.
	Content-Based Options
	FV Fantasy Violence.
	D Suggestive Dialogue.
	L Strong Language.
	S Sexual situations.
	V Violence.
Unrated	Block Blocks all programs and movies that are broadcast without a rating.
<i>Block programs or movies that are broadcast without a rating</i>	Allow Allows programs and movies that are broadcast without a rating.

You can view blocked programs by entering the password. Press the ENTER button when tuned to a blocked program, then enter the password. This temporarily switches off the Parental Lock. To reactivate the Parental Lock settings, turn off the TV. When the TV is turned on again, your Parental Controls settings are reactivated.

Canadian Models: Selecting Custom Rating Options

For Canadian models, the Custom Rating Menu includes the following options. (For US models, see page 43.)

<i>Option</i>	<i>Description</i>	
English Rating	C	All children.
	C8	Children 8 years and older.
	G	General programming.
	PG	Parental Guidance.
	14+	Viewers 14 and older.
	18+	Adult programming.
French Rating	G	General programming.
	8 ans+	Not recommended for young children.
	13 ans+	Not recommended for ages under 13.
	16 ans+	Not recommended for ages under 16.
USA Rating	18 ans+	Programming restricted to adults.
	See "US Models" on page 43 for details.	

Viewing Blocked Programs

You can view blocked programs by entering the password. Press the ENTER button when tuned to a blocked program, then enter the password. This temporarily switches off the Parental Lock. To reactivate the Parental Lock settings, turn off the TV. When the TV is turned on again, your Parental Controls settings are reactivated.

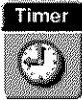



Using the Timer Menu

To select the Timer Menu

- 1 Press MENU.
- 2 Use the arrow buttons to move to the Timer icon  and press .



To set the Current Time

- 1 Use the arrow buttons to select “Current Time”, then press .
- 2 If it is currently Daylight Saving Time, be sure to set the mode to “ON” first. (Daylight Saving Time starts in the Spring, and ends in the Fall.)
- 3 Use the arrow buttons to enter the correct time, then press .
- 4 Press MENU to exit the menu screen.



To set the Timer

Before setting the timer, be sure to set your TV's clock to the current time (and, if appropriate, to Daylight Saving mode).

- 1 Use the arrow buttons to move to “Timer 1” or “Timer 2”, then press .
- 2 Use the arrow buttons to enter your date, time and channel preferences, then press  to select each one.
- 3 Press MENU to exit the menu screen. An LED on the front panel will light, indicating the timer has been set.

To reset the Clock or Timers

- Press RESET on the remote control, when in the Timer menu, to reset to the factory defaults.

Selecting Timer Options

The Timer Menu includes the following options:

Option	Description
Timer 1	Program
Timer 2	OFF
Current Time	Set the current time.
Daylight Saving	ON
	OFF



Using the Setup Menu

To select the Setup Menu

- 1 Press MENU.
- 2 Use the arrow buttons to move to the Setup icon  and press \odot .
- 3 Use the arrow buttons to scroll through the features.
- 4 Press \odot to select a feature. (That feature's options appear.)
- 5 Use the arrow buttons to scroll through the options.
- 6 Press \odot to select the desired option.
- 7 Press MENU to exit the menu screen.



Selecting Setup Options

The Setup Menu includes the following options:

<i>Option</i>	<i>Description</i>
Caption Vision	Allows you to select from three closed-caption modes (for programs that are broadcast with closed caption).
CC1, CC2, CC3, CC4	Displays a printed version of the dialog or sound effects of a program. (Should be set to CC1 for most programs.)
TEXT1, TEXT2, TEXT3, TEXT4	Displays network/station information presented using either half or the whole screen (if available). For closed captioning, set to CC1.
XDS (Extended Data Service)	Displays a network name, program name, program length, and time of the show (if the broadcaster offers this service).
OFF	Turns off Caption Vision.





<i>Option</i>	<i>Description</i>
Video Label	Allows you to label the audio/video components you connected to the TV, so you can identify them when using the TV/VIDEO button. When in the Setup menu's Video Label feature, use the arrow buttons to highlight an input to label, then press (+) to select it. Use the arrow buttons to scroll through the labels. Press (+) to select the component you connected to each of the input jacks on the back of your TV. Select "Skip" if you do not have a component connected to a particular set of input jacks.
VIDEO 1/2/3	Choose VHS, 8mm, Beta, LD, Game, SAT, DVD, Web, Receiver, DTV, Skip
VIDEO 4	Choose DVD, DTV, Skip
 If you select "Skip", your TV skips this connection when you press the TV/VIDEO button.	
Tilt Correction	Allows you to correct any tilt of the picture.
Language	Select to display all on-screen menus in your language of choice.
16:9 Enhanced	Provides enhanced picture resolution for widescreen (anamorphic) sources, such as selected DVD titles (only available when the TV is in VIDEO mode). Press TV/VIDEO and select from one of the following options:
	ON To activate.
	OFF To turn off 16:9.
Demo	Runs a demonstration of on-screen menus.

 To use this feature with widescreen DVDs, set your DVD player to 16:9 aspect ratio.





Using the Basic Menu

To select the Basic Menu

- 1 Press MENU.
- 2 Use the arrow buttons to move to the Basic icon  and press .
- 3 Use the arrow buttons to scroll through the features.
- 4 Press  to select a feature. (That feature's options appear.)
- 5 Use the arrow buttons to scroll through the options.
- 6 Press  to select the desired option.
- 7 Press MENU to exit the menu screen.



Selecting Basic Options

 As a shortcut to using the menus, use the  button on the remote control to cycle through available audio effects.

The Basic Menu includes the following options:

<i>Option</i>	<i>Description</i>	
Picture	Adjust the picture contrast.	
Caption Vision	Displays your current advanced-menu setting: (CC1-4, TEXT 1-4, or XDS) and OFF.	
Effect	Surround	Select for Surround sound.
	OFF	Normal stereo or mono reception.
Advanced Menu	Select to return to the advanced menus.	

Other Information

Overview

This chapter includes the following topics:

<i>Topic</i>	<i>Page</i>
Programming the Remote Control	50
Operating Other Components with Your TV Remote Control	52
Troubleshooting	54
Specifications	56
Index	57

Programming the Remote Control

The remote control is preset to operate Sony-brand video equipment.

If you have video equipment other than Sony brand that you want to control with the TV's remote control, use the following procedure to program the remote control.

 The equipment must have infrared (IR) remote capability in order to be used with the remote control.



- If more than one code number is listed, try entering them one by one until you come to the correct code for your component.
- If you enter a new code number, the code number you previously entered at that setting is erased.
- In some cases, you may not be able to operate your component with the supplied remote control. In such cases, use the component's own remote control unit.
- Whenever you remove the batteries to replace them, the code numbers may revert to the factory setting and must be reset.

- 1 Check the list of "Manufacturer's Codes" on page 51, and find the three-digit code number for the manufacturer of your component. (If more than one code number is listed, use the number listed first.

 You must do step 4 within 10 seconds of step 3, or you must redo steps 2 and 3.

- 2 Press CODE SET.
- 3 Press the function button for the type of component you want to control with the TV's remote control (VCR/DVD or SAT/CABLE).
- 4 Enter the three-digit manufacturer's code number.
- 5 Press ENTER.
- 6 To check if the code number works, aim the TV's remote control at the component and press the green POWER button that corresponds with that component. If it responds, you are done. If not, try using another code listed for that manufacturer.

Manufacturer's Codes

VCRs

<i>Manufacturer</i>	<i>Code</i>
Sony	301
Admiral (M. Ward)	327
Aiwa	338, 344
Audio Dynamic	314, 337
Broksonic	319, 317
Canon	309, 308
Citizen	332
Craig	302, 332
Criterion	315
Curtis Mathes	304, 338, 309
Daewoo	341, 312, 309
DBX	314, 336, 337
Dimensia	304
Emerson	319, 320, 316, 317, 318, 341
Fisher	330, 335
Funai	338
General Electric	329, 304, 309
Go Video	322, 339, 340
Goldstar	332
Hitachi	306, 304, 305, 338
Instant Replay	309, 308
JC Penney	309, 305, 304, 330, 314, 336, 337
JVC	314, 336, 337, 345, 346, 347
Kenwood	314, 336, 332, 337
LXI (Sears)	332, 305, 330, 335, 338
Magnavox	308, 309, 310
Marantz	314, 336, 337
Marta	332
Memorex	309, 335
Minolta	305, 304
Mitsubishi/ MGA	323, 324, 325, 326
Multitech	325, 338, 321
NEC	314, 336, 337

<i>Manufacturer</i>	<i>Code</i>
Olympic	309, 308
Optimus	327
Panasonic	308, 309, 306, 307
Pentax	305, 304
Philco	308, 309
Philips	308, 309, 310
Pioneer	308
Quasar	308, 309, 306
RCA/ PROSCAN	304, 305, 308, 309, 311, 312, 313, 310, 329
Realistic	309, 330, 328, 335, 324, 338
Sansui	314
Samsung	322, 313, 321
Sanyo	330, 335
Scott	312, 313, 321, 335, 323, 324, 325, 326
Sharp	327, 328
Shintom	315
Signature 2000 (M. Ward)	338, 327
SV2000	338
Sylvania	308, 309, 338, 310
Symphonic	338
Tashiro	332
Tatung	314, 336, 337
Teac	314, 336, 338, 337
Technics	309, 308
Toshiba	312, 311
Wards	327, 328, 335, 331, 332
Yamaha	314, 330, 336, 337
Zenith	331

Laserdisc Players

<i>Manufacturer</i>	<i>Code</i>
Sony	701
Panasonic	704, 710
Pioneer	702

DVD Players

<i>Manufacturer</i>	<i>Code</i>
Sony	751
Hitachi	758
JVC	756
Magnavox	757
Mitsubishi	761
Oritron	759
Panasonic	753
Philips	757
Pioneer	752
RCA	755
Samsung	758
Toshiba	754
Zenith	760

Cable Boxes

<i>Manufacturer</i>	<i>Code</i>
Sony	230
Hamlin/Regal	222, 223, 224, 225, 226
Jerrold/G. I.	201, 202, 203, 204, 205, 206, 207, 208, 218
Oak	227, 228, 229
Panasonic	219, 220, 221
Pioneer	214, 215
Scientific Atlanta	209, 210, 211
Tocom	216, 217
Zenith	212, 213

Satellite Receivers

<i>Manufacturer</i>	<i>Code</i>
Sony	801
Dish Network	810
Echostar	810
General Electric	802
Hitachi	805
Hughes	804
Mitsubishi	809
Panasonic	803
RCA/ PROSCAN	802, 808
Toshiba	806, 807

Operating Other Components with Your TV Remote Control

Operating a VCR

<i>To Do This ...</i>	<i>Press</i>
Turn on/off	VCR/DVD (green POWER button)
Select VCR	VCR/DVD (FUNCTION button)
Change channels	CH +/-
Record	▶ and ● simultaneously
Play	▶
Stop	■
Fast forward	▶▶
Rewind the tape	◀◀
Pause	(press again to resume normal playback)
Search the picture forward or backward	▶▶ or ◀◀ during playback (release to resume normal playback)
Change input mode	TV/VCR

Operating a DVD Player

<i>To Do This ...</i>	<i>Press</i>
Turn on/off	VCR/DVD (green POWER button)
Select DVD	VCR/DVD (FUNCTION button)
Play	▶
Stop	■
Pause	(press again to resume normal playback)
Step through different tracks of an audio disc	▶▶ to step forward, or ◀◀ to step backward
Step through different chapters of a video disc	CH+ to step forward, or CH- to step backward
Select tracks directly	0-9 buttons
Display the menu (Setup)	MENU





Operating a Cable Box

<i>To Do This ...</i>	<i>Press</i>
Turn on/off	SAT/CABLE (green POWER button)
Select Cable Box	SAT/CABLE (FUNCTION button)
Select a channel	0-9 buttons, ENTER
Change channels	CH +/-
Back to previous channel	JUMP

Operating a Satellite Receiver

<i>To Do This ...</i>	<i>Press</i>
Turn on/off	SAT/CABLE (green POWER button)
Select Satellite Receiver	SAT/CABLE (FUNCTION button)
Select a channel	0-9 buttons, ENTER
Change channels	CH +/-
Back to previous channel	JUMP
Change input mode	TV/SAT
Display channel number	DISPLAY
Display DBS guide	GUIDE
Display DBS menu	MENU
Move highlight (cursor)	arrows
Select item	 button

Operating an MDP (Laserdisc Player)

<i>To Do This ...</i>	<i>Press</i>
Turn on/off	VCR/DVD (green POWER button)
Select MDP	VCR/DVD (FUNCTION button)
Play	
Stop	
Pause	 (press again to resume normal playback)
Search the picture forward or backward	 or  during playback (release to resume normal playback)
Search a chapter forward or backward	CH +/-

Troubleshooting

<i>Problem</i>	<i>Possible Remedies</i>
Reset TV to factory settings	<input type="checkbox"/> Turn on the TV. While holding down the RESET button on the remote control, press the POWER button on the TV. (The TV will turn itself off, then back on again.) Release the RESET button.
No picture (screen not lit), no sound	<input type="checkbox"/> If your TV does not turn on, and a red light keeps flashing, your TV may need service. Call your local Sony Service Center. <input type="checkbox"/> Make sure the power cord is plugged in. <input type="checkbox"/> Push the power button on the front of the TV. <input type="checkbox"/> Check to see if the TV/VIDEO setting is correct: when watching TV, set to TV. When watching connected equipment, set to VIDEO 1, 2, 3, or 4, as appropriate. <input type="checkbox"/> Try another channel, it could be station trouble.
Remote control does not operate	<input type="checkbox"/> Batteries could be weak. Replace the batteries. <input type="checkbox"/> Press TV (FUNCTION) when operating your TV. <input type="checkbox"/> Make sure the TV's power cord is connected securely to the wall outlet. <input type="checkbox"/> Locate the TV at least 3-4 feet away from fluorescent lights. <input type="checkbox"/> Check the orientation of the batteries.
Dark, poor or no picture (screen lit), good sound	<input type="checkbox"/> Adjust the Picture setting in the Video menu (see page 36). <input type="checkbox"/> Adjust the Brightness setting in the Video menu (see page 36). <input type="checkbox"/> Check antenna/cable connections.
Good picture, no sound	<input type="checkbox"/> Press MUTING so that "MUTING" disappears from the screen (see page 4). <input type="checkbox"/> Make sure Speaker is set to ON in the Audio menu (see page 38).
Cannot receive upper channels (UHF) when using an antenna	<input type="checkbox"/> Change Cable to OFF (see page 40). <input type="checkbox"/> Use Auto Program in the Channel menu to add receivable channels that are not presently in the TV's memory (see page 40).
No color	<input type="checkbox"/> Adjust the Color settings in the Video menu (see page 36).
Only snow and noise appear on the screen	<input type="checkbox"/> Check the antenna/cable connections. <input type="checkbox"/> Try another channel; it could be station trouble. <input type="checkbox"/> Press ANT to change the input mode (see page 7).
Dotted lines or stripes	<input type="checkbox"/> Adjust the antenna. <input type="checkbox"/> Move the TV away from noise sources such as cars, neon signs, or hair-dryers.
TV is fixed to one channel	<input type="checkbox"/> Use Auto Program in the Channel menu to add receivable channels that are not presently in the TV's memory (see page 40). <input type="checkbox"/> Check your Channel Fix settings (see page 40).
Double images or ghosts	<input type="checkbox"/> Using a highly directional outdoor antenna or a cable may solve the problem.
Cannot operate menu	<input type="checkbox"/> If the item you want to choose appears in gray, you cannot select it.
Cannot receive any channels when using cable TV	<input type="checkbox"/> Use Auto Program in the Channel menu to add receivable channels that are not presently in the TV's memory (see page 40). <input type="checkbox"/> Check your cable settings. <input type="checkbox"/> Make sure Cable is set to ON in the Channel menu (see page 40).
Cannot gain enough volume when using a cable box	<input type="checkbox"/> Increase the volume of the cable box using the cable box's remote control. Then press TV (FUNCTION) and adjust the TV's volume.

<i>Problem</i>	<i>Possible Remedies</i>
Cannot receive channels	<ul style="list-style-type: none"> <input type="checkbox"/> Use Auto Program in the Channel menu to add receivable TV channels that are not presently in TV memory (see page 40).
Unable to select a channel	<ul style="list-style-type: none"> <input type="checkbox"/> Use Auto Program in the Channel menu to add receivable TV channels that are not presently in TV memory (see page 40).
Lost password	<ul style="list-style-type: none"> <input type="checkbox"/> In the password screen (see page 42), enter the following master password: 4357. The master password clears your previous password; it cannot be used to temporarily unblock channels.
Cannot change channels with the remote control	<ul style="list-style-type: none"> <input type="checkbox"/> If you are using the TV to change channels, be sure the TV FUNCTION button is selected. <input type="checkbox"/> If you are using another device to change channels, be sure you have not inadvertently switched your TV from the channel 3 or 4 setting. Use the Channel Fix feature to "fix" the channel based on the hookup you used (see page 40). <input type="checkbox"/> If you are using another device to change channels, be sure to press the green "FUNCTION" button for that device. For example, if you are using your VCR to change channels, be sure to press the VCR/DVD FUNCTION button.
Cannot cycle through the other video equipment connected to the TV	<ul style="list-style-type: none"> <input type="checkbox"/> Be sure the Video Label feature has not been set to "Skip" (see page 47).
There is a black box on the screen	<ul style="list-style-type: none"> <input type="checkbox"/> You have selected a text option in the Setup menu and no text is available. (See page 46 to reset Setup selections.) To turn off this feature, select OFF in the Caption Vision option. If you were trying to select closed captioning, select CCI instead of TEXT 1-4.
The remote control will not work in PIP mode	<ul style="list-style-type: none"> <input type="checkbox"/> Press the TV FUNCTION button. You may have inadvertently pressed the VCR/DVD FUNCTION button, which changes the PIP buttons to VCR mode.
There is no window picture, or it is just static	<ul style="list-style-type: none"> <input type="checkbox"/> Be sure your window picture is set to a video source/channel that has a program airing. <input type="checkbox"/> You may be tuned to a video input with nothing connected to it. Try cycling through your video inputs using the PIP TV/VIDEO button. <input type="checkbox"/> PIP is not set to receive a signal from the AUX input. If you connected a VCR, DVD player or Satellite Receiver to the AUX input on the TV, it will not show in the small window picture.
I get the same program in the window picture as in the main picture	<ul style="list-style-type: none"> <input type="checkbox"/> Both may be set to the same channel. Try changing channels in either the main picture or the window picture. <input type="checkbox"/> You may using a cable box for all your channels. If you must have a cable box to unscramble all channels, then you are limited to only one picture (because that is all that the cable box allows - one channel at a time). But if you need the cable box only part time (to unscramble premium channels), then you can use PIP when you are not using the cable box (when you use the CATV cable without going through the box).
I cannot get anything but TV in my window picture	<ul style="list-style-type: none"> <input type="checkbox"/> Be sure the video label has not been set to skip your video inputs. (See the Setup menu on page 47.)

If, after reading these operating instructions, you have additional questions related to the use of your Sony television, please call our Direct Response Center at 1-800-222-SONY (7669) (U.S. residents only) or (416) 499-SONY (7669) (Canadian residents only).

Specifications

All Models (General)		
Picture Tube	FD Trinitron® tube	
Antenna	75 ohm external terminal for VHF/UHF	
Television System	NTSC, American TV Standard	
Channel Coverage		
VHF	2-13	
UHF	14-69	
CATV	1-125	
Power Requirements	120V, 60 Hz	
Number of Inputs/Outputs		
Video (IN)	3	1 Vp-p, 75 ohms unbalanced, sync negative
S Video (IN)	1	Y: 1 Vp-p, 75 ohms unbalanced, sync negative C: 0.286 Vp-p (Burst signal), 75 ohms
Audio (IN)	4	500 mVrms (100% modulation) Impedance: 47 kilohm
Variable/Fixed Audio (OUT)	1	More than 408 mVrms at the maximum volume setting (Variable) More than 408 mVrms (Fixed) Impedance (output): 2 kilohms
Component Video Input	1 (Y, P _B , P _R)	Y: 1.0 Vp-p, 75 ohms unbalanced, sync negative; P _B : 0.7 Vp-p, 75 ohms P _R : 0.7 Vp-p, 75 ohms
KV-36FS13, 36FS17		
Supplied Accessories		
Remote Control		
KV-36FS13	RM-Y180	
KV-36FS17	RM-Y181	
AA (R6) Batteries	2 supplied for remote control	
Optional Accessories		
AV Cable	VMC-810/820/830 HG	
Audio Cable	RKC-515HG	
Component Video Cable	VMC-10/30 HG	
TV Stand	SU-36FD4	
Visible Screen Size	36 in (911 mm) picture measured diagonally	
Actual CRT Size	38 in (965.2 mm) picture measured diagonally	
Speaker Output	10 W x 2	
Dimensions (W x H x D)	910 x 791 x 650 mm (35 7/8 x 31 1/8 x 25 5/8 in)	
Mass	100 kg (220 lbs)	
Power Consumption		
In Use	200 W	
In Standby	2 W	

Index

16:9 (anamorphic or widescreen) 2, 47

A

Activating a PIP screen 31
Adding channels to the channel list 41
Adjusting the picture definition 37
ANT button 7
Aspect ratio, 16:9 47
Audio menu 35, 38
audio receiver, connecting 24
Auto Program (channel setup) 28, 40
Auto-SAP 35, 38
Auto setup 28

B

balance, adjusting 38
Basic menu 35, 48
bass, adjusting 38
batteries
 inserting in remote 3
bilingual audio 38
blocking programs. See ratings 42
brightness, adjusting 36

C

cable
 box, connecting with VCR 17
 connecting 12-15
 setting ON/OFF 40
 with VCR, connecting 16
cable box, using with TV remote control 53
camcorder, connecting 27
Caption Vision 46, 48
CATV. see cable
Channel List
 Adding channels to 41
 Removing channels from 41
Channel menu 35, 40
Channel Setup menu 40
Channel Skip/Add 41
channels
 creating labels 41
 setting up 28

closed caption modes 46
Code Set Button 4, 6, 50
color temperature, adjusting 37
color, adjusting 36

Connecting:

 Audio Receiver 24
 Cable or antenna 12-15
 Cable box 13-15
 Camcorder 27
 DVD player 25, 26
 Satellite receiver 21
 VCR 16-20
 VCR with satellite receiver 22

Contents of box 3

Controls and connections 10-11

Converter 14

D

Demo, menus 47
Display button 5, 7
Display, turning off 5, 7
DVD player
 using with TV remote control 52
 with A/V connectors, connecting 26
 with component video connectors,
 connecting 25

E

Enhanced picture resolution 47
Extended Data Service 46

F

Favorite Channel
 setting up 40
 using 30
features 2
Front Panel controls 10

G

Guide button 5, 7

H

Hookups 12-27
hue, adjusting 36

I

inputs, labeling 47

J

Jump button 4, 6

L

label
 channels 41
 video inputs 47
Languages 47
Locking programs 42

M

Manufacturer's Codes 51
MDP, using with TV remote control 53
Menu button 5, 7
menus
 Audio 35, 38
 Basic 35, 48
 Channel 35, 40
 Channel Setup 40
 Parent 35, 42
 Parental Control 42
 Setup 35, 46
 Timer 35, 45
 Video 35, 36
MTS 5, 38
Muting 4, 6

P

Parent menu 35, 42
parental control, described 2
password
 changing 42
picture contrast, adjusting 36
picture definition, adjusting 37
Picture in Picture (PIP), using 31
picture, adjusting 48
Picture Mode 4, 6
Picture size, adjusting in PIP 32
power cord, removing from holder 9

presetting channels 40
problems, troubleshooting 54-55

R

ratings, setting 42-43
ratings, viewing blocked programs 43, 44
Rear panel controls and connections 10-11
remote control
 described 4-7
 inserting batteries 3
 programming 50-51
Remote control, operating other components
 with
 VCR 52
 MDP 53
 Satellite receiver 53
 DVD 52
 Cable box 53
Removing channels from the channel list 41
Reset button 4, 6
resetting
 Audio options 38
 Timer options 45
 Video options 36

S

SAT/CABLE power button 4, 7
SAT/CABLE function button 5, 7
satellite receiver, using with TV remote control
 53
Setting favorite channels 40
setting up channels 28, 40
Setup menu 35, 46
sharpness, adjusting 36
Sleep timer/button 4, 6
speakers
 turning on/off 38
 using external speakers 38
specifications 56
surround sound 38, 48

T

- tape-to-tape editing 20
- tilt, correcting 47
- Time,
 - set current 45
 - set Daylight Saving 45
- Timer menu 35, 45
- Timer setting 45
- treble, adjusting 38
- troubleshooting 54-55
- TV function button 5, 7
- TV power button 4, 7
- TV/VIDEO button 5, 7

V

- VCR
 - connecting two, for tape editing 20
 - using with TV remote control 52
 - with cable box, connecting 17
 - with cable, connecting 16
 - with satellite receiver, connecting 21
- VCR/DVD power button 4, 7
- VCR/DVD function button 5, 7
- Velocity Modulation 2, 37
- video inputs, labeling 47
- Video menu 35, 36
- Video Modes, selecting 36

W

- Wega, described 2
- widescreen 47
- widescreen, described 2

