



FD Trinitron
WEGA™

Operating Instructions
KV-32H6

WARNING

To reduce the risk of fire or shock hazard, do not expose the TV to rain or moisture.



This symbol is intended to alert the user to the presence of uninsulated "dangerous voltage" within the product's enclosure that may be of sufficient magnitude to constitute a risk of electric shock to persons.



This symbol is intended to alert the user to the presence of important operating and maintenance (servicing) instructions in the literature accompanying the appliance.

CAUTION

TO PREVENT ELECTRIC SHOCK, MATCH WIDE BLADE OF PLUG TO WIDE SLOT, FULLY INSERT.

CAUTION

When using TV games, computers, and similar products with your TV, keep the brightness and contrast functions at low settings. If a fixed (non-moving) pattern is left on the screen for long periods of time at a high brightness or contrast setting, the image can be permanently imprinted onto the screen. Continuously watching the same program can cause the imprint of station logos onto the TV screen. These types of imprints are not covered by your warranty because they are the result of misuse.

Note on Caption Vision

This television receiver provides display of television closed captioning in accordance with §15.119 of the FCC rules.

Note on Cleaning the TV

Clean the TV with a soft dry cloth. Never use strong solvents such as thinner or benzine, which might damage the finish of the cabinet.

Note to CATV System Installer

This reminder is provided to call the CATV system installer's attention to Article 820-40 of the NEC that provides guidelines for proper grounding and, in particular, specifies that the cable ground shall be connected to the grounding system of the building, as close to the point of cable entry as practical.

Use of this television receiver for other than private viewing of programs broadcast on UHF or VHF or transmitted by cable companies for the use of the general public may require authorization from the broadcaster/cable company and/or program owner.

NOTIFICATION

This equipment has been tested and found to comply with the limits for a Class B digital device pursuant to Part 15 of the FCC Rules. These limits are designed to provide reasonable protection against harmful interference in a residential installation. This equipment generates, uses, and can radiate radio frequency energy and, if not installed and used in accordance with the instructions, may cause harmful interference with radio communications. However, there is no guarantee that interference will not occur in a particular installation. If this equipment does cause harmful interference to radio or television reception, which can be determined by turning the equipment off and on, the user is encouraged to try to correct the interference by one or more of the following measures:

- Reorient or relocate the receiving antennas.
 - Increase the separation between the equipment and receiver.
 - Connect the equipment into an outlet on a circuit different from that to which the receiver is connected.
 - Consult the dealer or an experienced radio/TV technician for help.
- You are cautioned that any changes or modifications not expressly approved in this manual could void your authority to operate this equipment.

Safety

- Operate the TV only on 120 V AC.
- The plug is designed, for safety purposes, to fit into the wall outlet only one way. If you are unable to insert the plug fully into the outlet, contact your dealer.
- If any liquid or solid object should fall inside the cabinet, unplug the TV immediately and have it checked by qualified service personnel before operating it further.

Installing

- To prevent internal heat buildup, do not block the ventilation openings.
- Do not install the TV in a hot or humid place, or in a place subject to excessive dust or mechanical vibration.
- The AC power cord is attached to the rear of the TV with hooks. Do not attempt to remove the cord from these hooks. Doing so could cause damage to the TV.

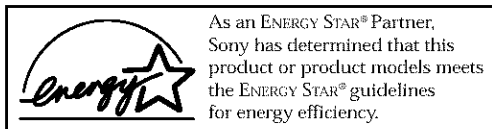

As an ENERGY STAR® Partner, Sony has determined that this product or product models meets the ENERGY STAR® guidelines for energy efficiency.

ENERGY STAR® is a U.S. registered mark.



The SRS (●)® (SOUND RETRIEVAL SYSTEM) is manufactured by Sony Corporation under license from SRS Labs, Inc. It is covered by U.S. Patent No. 4,748,669. Other U.S. and foreign patents pending. SRS and the (●)® symbol are trademarks of SRS Labs, Inc. SRS technology is incorporated under license from SRS Labs, Inc. Licensed by BBE Sound, Inc. under USP 4638258.4482866. BBE and BBE symbol are trademarks of BBE Sound, Inc. FD Trinitron and the Wega logo are trademarks of Sony Corporation.

Owner's Record

The model and serial numbers are provided on the front of this instruction manual and at the rear of the TV. Refer to them whenever you call upon your Sony dealer regarding this product.

Important Safeguards

For your protection, please read these instructions completely, and keep this manual for future reference.

Carefully observe and comply with all warnings, cautions and instructions placed on the set or described in the operating instructions or service manual.

WARNING

To guard against injury, the following basic safety precautions should be observed in the installation, use and servicing of the set.

Use

Power Sources

This set should be operated only from the type of power source indicated on the serial/model plate. If you are not sure of the type of electrical power supplied to your home, consult your dealer or local power company. For those sets designed to operate from battery power, refer to the operating instructions.



Grounding or Polarization

This set is equipped with a polarized AC power cord plug (a plug having one blade wider than the other), or with a three-wire grounding type plug (a plug having a third pin for grounding). Follow the instructions below:

For the set with a polarized AC power cord plug

This plug will fit into the power outlet only one way. This is a safety feature. If you are unable to insert the plug fully into the outlet, try reversing the plug. If the plug still fails to fit, contact your electrician to have a suitable outlet installed. Do not defeat the safety purpose of the polarized plug by forcing it in.



Alternate Warning

For the set with a three-wire grounding type AC plug

This plug will only fit into a grounding-type power outlet. This is a safety feature. If you are unable to insert the plug into the outlet, contact your electrician to have a suitable outlet installed. Do not defeat the safety purpose of the grounding plug.

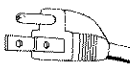

Overloading

Do not overload wall outlets, extension cords or convenience receptacles beyond their capacity, since this can result in fire or electric shock.

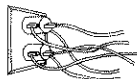

Always turn the set off when it is not being used. When the set is left unattended and unused for long periods of time, unplug it from the wall outlet as a precaution against the possibility of an internal malfunction that could create a fire hazard.



If a snapping or popping sound from a TV set is continuous or frequent while the TV is operating, unplug the TV and consult your dealer or service technician. It is normal for some TV sets to make occasional snapping or popping sounds, particularly when being turned on or off.

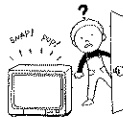

Object and Liquid Entry

Never push objects of any kind into the set through the cabinet slots as they may touch dangerous voltage points or short out parts that could result in a fire or electric shock. Never spill liquid of any kind on the set.

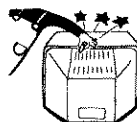

Cleaning

Unplug the set from the wall outlet before cleaning or polishing it. Do not use liquid cleaners or aerosol cleaners. Use a cloth lightly dampened with water for cleaning the exterior of the set.



Installation

Attachments

Do not use attachments not recommended by the manufacturer, as they may cause hazards.

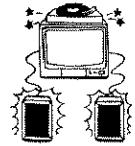

Water and Moisture

Do not use power-line operated sets near water — for example, near a bathtub, washbowl, kitchen sink, or laundry tub, in a wet basement, or near a swimming pool, etc.



Accessories

Do not place the set on an unstable cart, stand, table or shelf. The set may fall, causing serious injury to a child or an adult and serious damage to the set. Use only a cart or stand recommended by Sony for the specific model of TV. No part of the TV set should overhang any edge of the TV cart or stand; any overhanging edge is a safety hazard. An appliance and cart combination should be moved with care. Quick stops, excessive force, and uneven surfaces may cause the appliance and cart combination to overturn.



Ventilation

The slots and openings in the cabinet and in the back or bottom are provided for necessary ventilation. To ensure reliable operation of the set, and to protect it from overheating, these slots and openings must never be blocked or covered.

- ❑ Never cover the slots and openings with a cloth or other materials.
- ❑ Never block the slots and openings by placing the set on a bed, sofa, rug or other similar surface.
- ❑ Never place the set in a confined space, such as a bookcase or built-in cabinet, unless proper ventilation is provided.
- ❑ Do not place the set near or over a radiator or heat register, or where it is exposed to direct sunlight.



Power-Cord Protection

Do not allow anything to rest on or roll over the power cord, and do not place the set where the power cord is subject to wear or abuse.

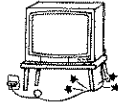

Antennas

Outdoor Antenna Grounding

If an outdoor antenna is installed, follow the precautions below. An outdoor antenna system should not be located in the vicinity of overhead power lines or other electric light or power circuits, or where it can come in contact with such power lines or circuits.

WHEN INSTALLING AN OUTDOOR ANTENNA SYSTEM, EXTREME CARE SHOULD BE TAKEN TO KEEP FROM CONTACTING SUCH POWER LINES OR CIRCUITS AS CONTACT WITH THEM IS ALMOST INVARIABLY FATAL.

Be sure the antenna system is grounded so as to provide some protection against voltage surges and built-up static charges. Section 810 of the National Electrical Code (NEC) in USA and Section 54 of the Canadian Electrical Code in Canada provides information with respect to proper grounding of the mast and supporting structure, grounding of the lead-in wire to an antenna discharge unit, size of grounding conductors, location of antenna discharge unit, connection to grounding electrodes, and requirements for the grounding electrode.

Antenna Grounding According to the NEC

Refer to section 54-300 of Canadian Electrical Code for Antenna Grounding.

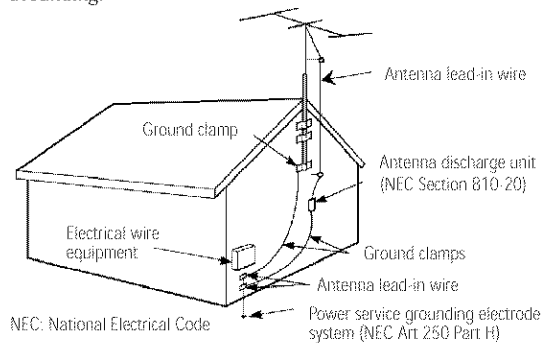

Lightning

For added protection for this television receiver during a lightning storm, or when it is left unattended and unused for long periods of time, unplug it from the wall outlet and disconnect the antenna. This will prevent damage to the receiver due to lightning and power-line surges.

Service

Damage Requiring Service

Unplug the set from the wall outlet and refer servicing to qualified service personnel under the following conditions:

- When the power cord or plug is damaged or frayed.
- If liquid has been spilled into the set.
- If the set has been exposed to rain or water.
- If the set has been subject to excessive shock by being dropped, or the cabinet has been damaged.
- If the set does not operate normally when following the operating instructions. Adjust only those controls that are specified in the operating instructions. Improper adjustment of other controls may result in damage and will often require extensive work by a qualified technician to restore the set to normal operation.
- When the set exhibits a distinct change in performance, it indicates a need for service.

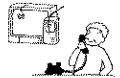
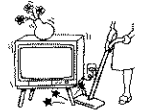

Servicing

Do not attempt to service the set yourself since opening the cabinet may expose you to dangerous voltage or other hazards. Refer all servicing to qualified service personnel.

Replacement Parts

When replacement parts are required, be sure the service technician certifies in writing that he has used replacement parts specified by the manufacturer that have the same characteristics as the original parts.

Unauthorized substitutions may result in fire, electric shock or other hazards.

Safety Check

Upon completion of any service or repairs to the set, ask the service technician to perform routine safety checks (as specified by the manufacturer) to determine that the set is in safe operating condition, and to so certify. When the set reaches the end of its useful life, improper disposal could result in a picture tube implosion. Ask a qualified service technician to dispose of the set.



Contents

Introducing the FD Trinitron Wega

Overview	1
Presenting the FD Trinitron Wega.....	2
Package Contents	3
Using the Remote Control	3

Installing the TV

Overview	7
TV Controls and Connectors	8
Basic Connection (Connecting Cable TV or Antenna)	10
Connecting a VCR and Cable.....	14
Connecting a VCR and Cable Box	15
Connecting Two VCRs for Tape Editing	18
Connecting a Satellite Receiver	19
Connecting a Satellite Receiver with a VCR	20
Connecting an Audio Receiver	22
Connecting a DVD Player with Component Video Connectors.....	23
Connecting a DVD Player with A/V Connectors.....	24
Connecting a Digital TV Receiver	25
Connecting a Camcorder	26
Using the CONTROL S Feature	27
Setting Up the TV Automatically	28

Using the Features

Overview	29
Using Favorite Channels.....	30
Using Twin View	31
Using the Freeze Function	34

Using the Menus

Overview	35
Using the Video Menu	36
Using the Audio Menu	38
Using the Channel Menu	40
Using the Parent Menu	42
Using the Timer Menu	46
Using the Setup Menu.....	47

Other Information

Overview	49
Programming the Remote Control	50
Operating Other Equipment with Your TV Remote Control	53
Troubleshooting	55
Specifications	57
Index	59

Introducing the FD Trinitron Wega

Overview

This chapter defines the contents of your Wega TV and provides an overview of how to set up and use basic features.

<i>Topic</i>	<i>Page</i>
Presenting the FD Trinitron Wega	2
Package Contents	3
Using the Remote Control	3

Presenting the FD Trinitron Wega

The FD Trinitron Wega (pronounced VAY-GAH) is characterized by outstanding contrast, uncompromising accuracy, and corner-to-corner detail.

You'll recognize the superiority of Wega technology almost immediately. The first thing you'll notice is minimal glare from the flat picture tube. This flat-screen technology improves picture detail without distortion, unlike conventional curved screens. The FD Trinitron delivers outstanding image detail not only at the screen center, but also at the corners — so you can enjoy a bright, clear picture from any location in a room.

Features

Some of the features that you will enjoy with your new TV include:

- ❑ **DRC Mode (Digital Reality Creation):** Unlike conventional line doublers, the DRC feature doubles vertical and horizontal lines, resulting in four times the density for quality sources such as DVD player, Satellite and Digital camcorder.
- ❑ **Twin View™:** Using Multi-Image Driver (MIDX), Twin View allows you to watch two programs side by side, with the ability to zoom in one picture. You can watch pictures from two different sources simultaneously.
- ❑ **16:9 Enhancement:** Vertical Compression technology that maximizes picture resolution on “anamorphic” or “enhanced for widescreen” sources, including selected DVDs.
- ❑ **Velocity Modulation:** Vertical line enhancement that sharpens picture definition.
- ❑ **Steady Sound:** Equalizes volume levels so there is consistent output between programs and commercials.
- ❑ **Parental Control:** V-Chip technology allows parents to block unsuitable programming for younger viewers.
- ❑ **Component Video Inputs:** Offers the best video quality for DVD (480p, 480i), and Digital Set-top box (HD1080i) connections.
- ❑ **S VIDEO Inputs:** Provides a high-quality video signal from connected equipment.
- ❑ **Favorite Channel Preview:** Preview up to eight favorite channels without leaving the current channel.

Package Contents

Your box contains your new Trinitron TV, a remote control and two AA batteries. No peripheral cables are included. If you intend to add additional equipment to your TV, please check the hookup instructions for your desired setup before you begin. You may need to purchase cables and/or splitters to complete the hookup properly.

Using the Remote Control

Inserting Batteries

Insert two size AA (R6) batteries (supplied) by matching the + and - on the batteries to the diagram inside the battery compartment.

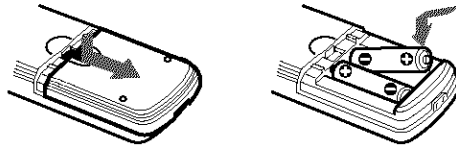



Remove the batteries to avoid damage from possible battery leakage whenever you anticipate that the remote control will not be used for an extended period. Handle the remote control with care. Avoid dropping it, getting it wet, or placing it in direct sunlight, near a heater, or where the humidity is high.

The following table describes the buttons on the remote control that are for more advanced functions.

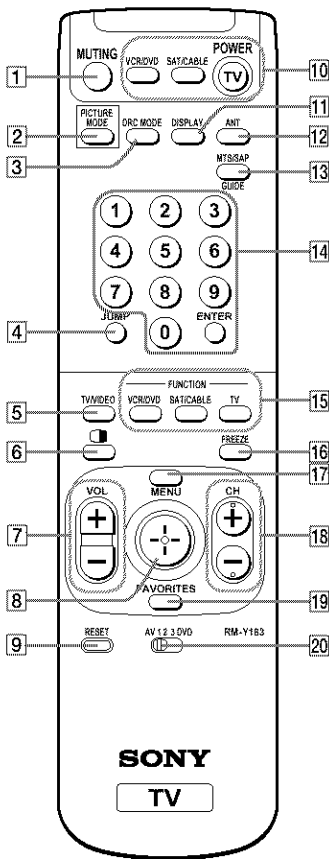
Button Descriptions



Button	Description
1 MUTING	Press to mute the sound. Press again or press VOL + to restore the sound.
2 PICTURE MODE	Press repeatedly to step through the available video picture modes: Vivid, Standard, Movie, Pro. Also available in the Video menu. For details, see "Selecting Video Options" on page 36.
3 DRC MODE	For high quality sources (i.e., DVD player, Satellite Receiver), this button cycles through the available high-resolution picture modes: Interlaced, Progressive. Also available in the Video menu. For details, see "Selecting Video Options" on page 36.
4 JUMP	Press to jump back and forth between two channels. The TV alternates between the current channel and the last channel that was selected.
5 TV/VIDEO	Cycles through the video equipment connected to your TV's video inputs: TV, VIDEO 1, VIDEO 2, VIDEO 3, VIDEO 4, VIDEO 5, VIDEO 6.
6 	Turns on/off Twin View. For details, see "Using Twin View" on page 31.
7 VOL +/-	Adjusts the volume.
8 	Joystick allows for movement of the on-screen cursor. Pressing down on the center of the joystick selects the item.
9 RESET	Press when in a menu to reset the settings to the factory defaults.
10 POWER buttons (GREEN)	Turn on and off the TV and other audio/video equipment you have programmed into the remote control. For instructions, see "Programming the Remote Control" on page 50.
11 DISPLAY	Press once to display the current time and channel label (if set) and channel number. Press again to turn Display off. See page 46 for details on setting the time.
12 ANT	Changes between the VHF/UHF input to the AUX input.

 To scan rapidly through the channels, press and hold down the CH+ or CH- button.

Button	Description
13 MTS/SAP	Press the TV FUNCTION button first, then press MTS/SAP to cycle through the Multi-channel TV Sound (MTS) options: Stereo, Auto-SAP (Second Audio Program), and Mono. For details, see "Using the Audio Menu" on page 38.
GUIDE	Press the SAT/CABLE FUNCTION button first, then press GUIDE to display the satellite program guide.
14 0 - 9 and ENTER	Press 0 - 9 to select a channel; the channel changes after 2 seconds. Press ENTER to select immediately.
15 FUNCTION buttons (WHITE)	Select the equipment (TV, VCR/DVD, SAT/CABLE) that you want to operate. The indicator lights up momentarily when pushed to show which device the remote control is operating.
16 FREEZE	Freezes the window picture. Press again to restore the picture.
17 MENU	Press to display the TV on-screen menu. Press again to exit from the menus.
18 CH +/-	Scan through channels.
19 FAVORITES	Displays the Favorite Channels list. For details, see "Using Favorite Channels" on page 30.
20 AV 1 2 3 DVD 	Use to switch control for connected video equipment. You can program one video source for each switch position (For details, see "Programming the Remote Control" on page 50).

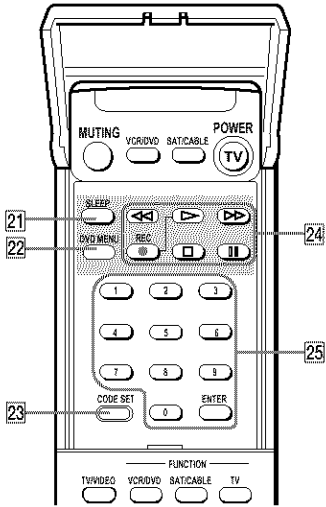

- 21** SLEEP Press repeatedly until the TV displays the time in minutes (15, 30, 45, 60, or 90) that you want the TV to remain on before shutting off automatically. Cancel by pressing until SLEEP OFF appears. While Sleep feature is set, press once to view remaining time
- 22** DVD MENU Displays the DVD menu.
- 23** CODE SET Used for programming the remote control to operate non-Sony video equipment. For details, see "Programming the Remote Control" on page 50.
- 24** VCR/DVD CONTROLS

 - ◀◀ Rewind
 - REC Record
 - ▶ Play
 - ▶▶ Fast-forward
 - ⏸ Pause
 - Stop
- 25** 0 - 9 and ENTER Press 0 - 9 to select a VCR channel.

Overview

This chapter includes illustrated instructions for setting up your TV.

<i>Topic</i>	<i>Page</i>
TV Controls and Connectors	8
Basic Connection (Connecting Cable TV or Antenna)	10
Connecting a VCR and Cable	14
Connecting a VCR and Cable Box	15
Connecting Two VCRs for Tape Editing	18
Connecting a Satellite Receiver	19
Connecting a Satellite Receiver with a VCR	20
Connecting an Audio Receiver	22
Connecting a DVD Player with Component Video Connectors	23
Connecting a DVD Player with A/V Connectors	24
Connecting a Digital TV Receiver	25
Connecting a Camcorder	26
Using the CONTROL S Feature	27
Setting Up the TV Automatically	28

Note About the AC Power Cord

The AC power cord is attached to the rear of the TV with a hook. Use caution when removing the AC plug from its holder. Gently slide the plug in the upward direction to remove from hook. Once removed, the AC power plug should automatically disengage from its stored location.

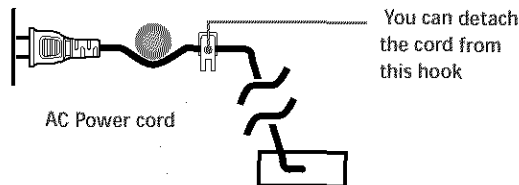

TV Controls and Connectors

Front Panel Menu Controls

The front panel menu controls allow access to the on-screen menus without the use of a remote control. Pressing the MENU button brings up the on-screen menus. The arrow buttons move the on-screen cursor in the menus and the SELECT button selects the menu item.



TV Rear Panel

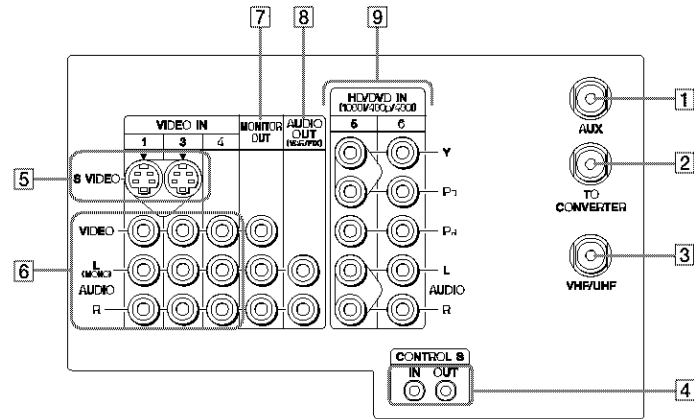

Connection	Description
1 AUX	Allows you to view local and cable channels if your cable provider does not feature local channels. You can switch between local and cable channels by pressing ANT on the remote control. Devices connected to the AUX input can be viewed only in the Twin View left picture.
2 TO CONVERTER	This is a VHF/UHF OUT jack that lets you set up your TV to switch between scrambled channels (through a cable box) and normal cable channels (CATV). Use this jack instead of a splitter to get better picture quality when switching between scrambled and unscrambled cable channels.

Connection	Description
3 VHF/UHF	Connects to your VHF/UHF antenna or cable.
4 CONTROL S IN/OUT	Allows the TV to receive (IN) and send (OUT) remote control signals to other Sony infrared-controlled audio or video equipment.
5 S VIDEO	Connects to the S VIDEO OUT jack of your VCR or other S VIDEO-equipped video equipment. Provides better picture quality than the VHF/UHF jacks or the Video IN jack.
6 VIDEO/AUDIO [L(MONO)/R]	Connect to the audio and video OUT jacks on your VCR or other video equipment. A video input (VIDEO 2) is located on the front panel of the TV. The Audio and Video IN jacks provide better picture quality than the VHF/UHF IN jack.
7 MONITOR OUT	Lets you record the program you are watching to a VCR. When two VCRs are connected, you can use your TV as a monitor for tape-to-tape editing (not available with 480p or 1080i when the input is to VIDEO 5 or 6).
8 AUDIO OUT (VAR/FIX) L (MONO)/R	Connect to the left and right audio inputs of your audio or video equipment.
9 HD/DVD IN (1080i/480p/480i)	Connect to your DVD player's or Digital Set-top box's component video (Y, PB, PR) and audio (L/R) jacks.

Basic Connection (Connecting Cable TV or Antenna)

Connecting Directly to Cable or to an Antenna

The connection you choose depends on the cable found in your home.

Newer homes are usually equipped with standard coaxial cable:

VHF Only or VHF/UHF or Cable

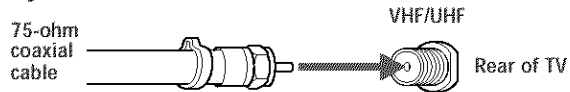

Older homes may have 300-ohm twin lead cable:

VHF Only or UHF Only or VHF/UHF

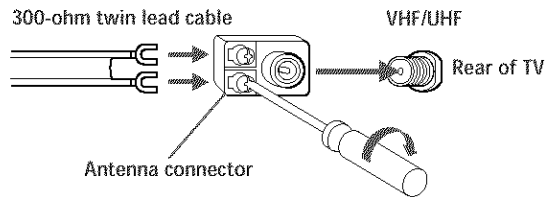

Some homes may have both:

VHF and UHF

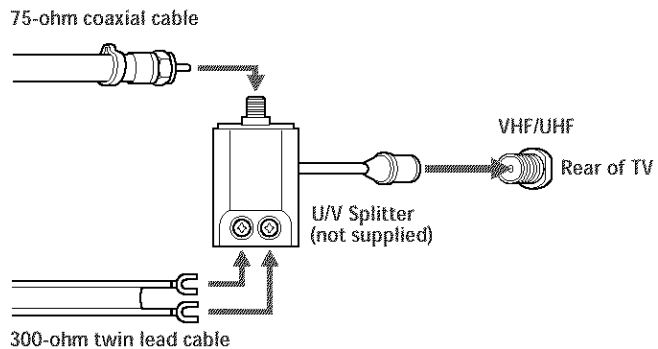

Cable and Antenna

If your cable provider does not feature local channels, you may find this set-up convenient.

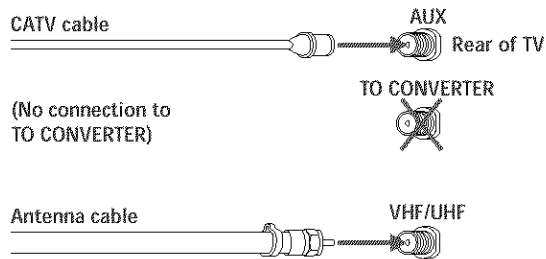

Select CABLE or antenna (ANT) mode by pressing ANT on the remote control.

To receive channels using an antenna, instead of the CATV cable:

- 1 Select antenna mode by pressing ANT on the remote control.
- 2 Turn the cable to OFF (see page 40).
- 3 Perform the Auto Program function (see page 40).

Cable Box Connections

Cable Box and Cable

This is the preferred basic cable TV hookup to use if your cable TV company scrambles some channels, but not all of them (pay channels vs. regular cable channels), so you need to use a cable box.

With this setup you can:

- Use the TV remote control to change channels using your cable box when the signal is scrambled.
- Use the TV remote control to change channels using your TV when the signal is not scrambled. (Your TV's tuner provides a better signal than the cable box.)
- Use the Twin View feature. (When all channels are routed through your cable box, only one signal is sent to the TV, so you cannot use the Twin View feature.)
- Use the Twin View feature normally with the CATV input.
- Use the Twin View feature partially with the cable box. When you switch the TV input to AUX — to use the cable box — the unscrambled picture from the cable box will display. You can display the signal from both AUX and VHF/UHF inputs in the left Twin View picture, but you can display only the signal from the VHF/UHF input in the right Twin View picture.

To set up your TV to use both a Cable Box and a direct-connect CATV cable:

- 1 Connect the Cable TV cable to the TV's VHF/UHF jack.
- 2 Using a coaxial cable, connect the TV's TO CONVERTER jack to the cable box's IN jack. The TV's internal converter allows you to switch between unscrambled signals coming straight into the TV and scrambled signals coming in through the cable box, eliminating the need for an external splitter.
- 3 Using a coaxial cable, connect the cable box's OUT jack to the TV's AUX jack.

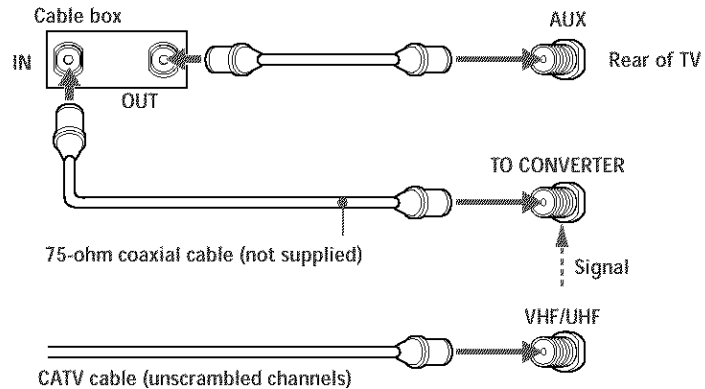

To switch between channels from Cable Box and channels coming directly into TV

- Press the ANT button on the TV remote control.

To use the TV remote control to switch channels on the cable box

- Program the remote control as necessary. (See “Programming the Remote Control” on page 50.)

To use the cable box

- Have your TV tuner set to channel 3 or 4 (as appropriate) and then use the Cable Box to change channels.

To prevent the accidental switching of TV channels

- When using the VCR or Cable Box, you can use the Channel Fix feature to lock in a channel. The Channel Fix feature is under the Channel menu. (See “Using the Channel Menu” on page 40.)

Cable Box Only

Use this hookup if:

- You subscribe to a cable TV system that uses scrambled or encoded signals requiring a cable box to view all channels, and
- You do not intend to hook up any other audio or video equipment to your TV.

When all channels are routed through your cable box, only one unscrambled signal is sent to the TV, so you cannot use the Twin View feature. If some channels are scrambled, but others are not, consider using the hookup on page 12 instead.

- 1 Connect the coaxial connector from your cable service to the cable box's IN jack.
- 2 Using a coaxial cable, connect the cable box's OUT jack to the TV's VHF/UHF jack.

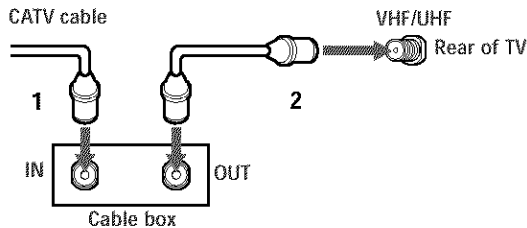
**To use the cable box**

- Have the TV tuner set to channel 3 or 4 (as appropriate) and then use the cable box to change channels.

To use the TV remote control to switch channels on the cable box

- Program the remote control as necessary. For details, see "Programming the Remote Control" on page 50.

To prevent accidental switching of TV channels

- Use the Channel Fix feature to lock in a channel. The Channel Fix feature is under the Channel menu. For details, see "Using the Channel Menu" on page 40.

Connecting a VCR and Cable

Use this hookup if you have cable TV that does not require a cable box.

- 1 Connect the cable TV cable to the VCR's IN jack.
- 2 Using a coaxial cable, connect the VCR's OUT jack to the TV's VHF/UHF jack.
- 3 Using an A/V cable, connect the VCR's Audio and Video OUT jacks to the TV's Audio and Video IN jacks.

⚠ If the VCR you are connecting has an S VIDEO jack, you can use an S VIDEO cable for improved picture quality (compared to a combination audio/video cable). Because an S VIDEO cable carries only the video signal, you will need audio cables for sound.

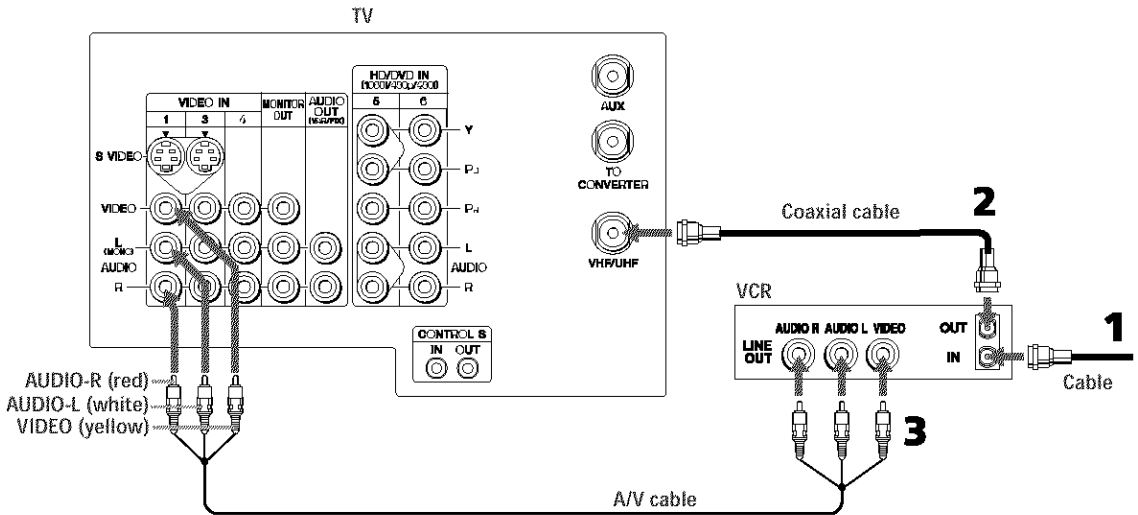

Connecting a VCR and Cable Box

Use this hookup if:

- Your cable TV company scrambles some channels, but not all of them (pay channels vs. regular cable channels), so you need to use a cable box, and
- You want to use the Twin View feature.

With this setup you can:

- Use the TV remote control to change channels using your cable box when the signal is scrambled.
- Use the TV remote control to change channels using your TV when the signal is not scrambled. (Your TV's tuner provides a better signal than the cable box.)
- Use the Twin View feature.
- Record both regular CATV and scrambled channels.

To connect a cable box and a VCR, you will need:

- A small, inexpensive device known as a splitter.
 - Three coaxial cables.
 - Either a combination audio/video cable, or an S VIDEO cable and audio cables.
- 1 Connect the CATV cable to the single (input) jack of the splitter.
 - 2 Use a coaxial cable to connect one of the two output jacks of the splitter to the TV's VHF/UHF jack.
 - 3 Use a coaxial cable to connect the other output jack of the splitter to the input jack of the cable box.
 - 4 Use a coaxial cable to connect the output jack of the cable box to the input jack of the VCR.
 - 5 Use the video line (yellow) of a combination audio/video (A/V) cable to connect the video output jack of the VCR to the video input jack of the TV.

 If your VCR has an S VIDEO jack, you can substitute an S VIDEO cable for the video line of an A/V cable. The S VIDEO cable will provide improved video signal quality. (You will need audio cables for sound.)

Connect the left (white) and right (red) audio output channels of the VCR to the respective input channels on the TV.

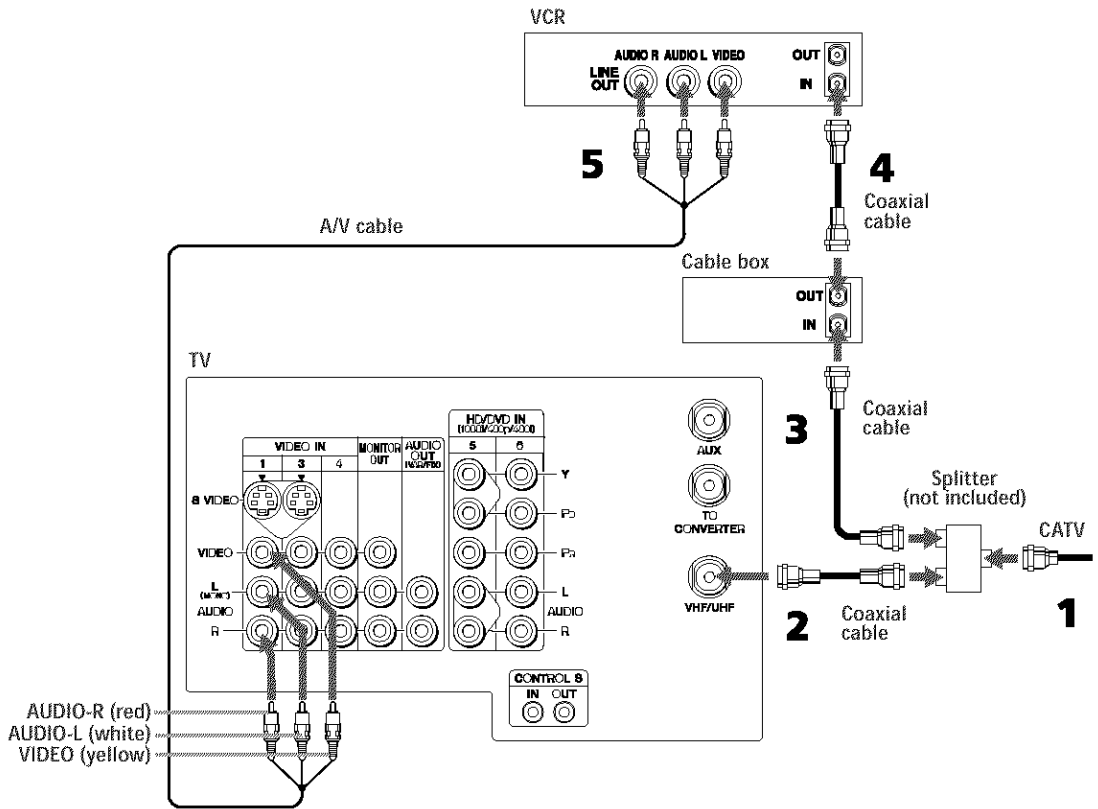

To switch between channels from cable box and channels from CATV

- Press the TV/VIDEO button on the TV remote control.

To view the cable box signals

- Match (channel 3 or 4) the channel setting of the VCR IN with the cable box OUT.

To use the TV remote control to change channels on the cable box

- Program the remote control as necessary. (For details, see “Programming the Remote Control” on page 50.) Then use the remote control to change the cable box channels.

To use Twin View with the cable box

- ❑ Turn on the VCR. (The VCR's tuner is used as one of the Twin View picture sources; if you do not turn on the VCR, the Twin View will not work.) Use the remote control's TV/VIDEO button to set the Twin View output to VIDEO 1. Change one Twin View channel by changing channels on the cable box.

Connecting Two VCRs for Tape Editing

If you connect two VCRs, so you can record from one to the other, you can connect the recording VCR into your TV to monitor what is being recorded. The procedure below shows you how to do this.

- 1 Using an A/V cable, connect the playback VCR's Audio and Video OUT jacks to the recording VCR's Audio and Video IN jacks.
- 2 Using an A/V cable, connect the recording VCR's Audio and Video OUT jacks to the TV's Audio and Video IN jacks.

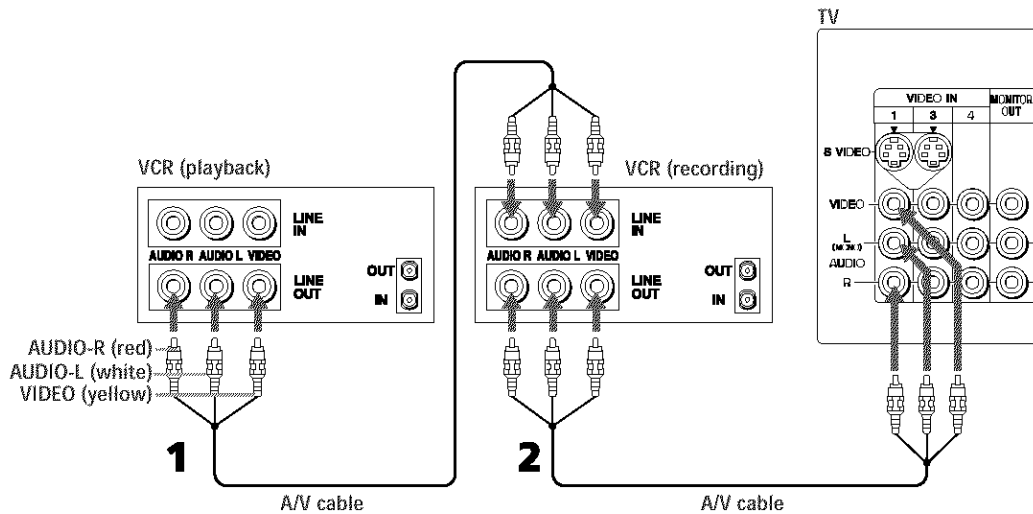

To change the video input of the VCR

- See your VCR's user guide for instructions.

To view what is being recorded

- Use the remote control to set the TV to the video input to which the recording VCR is connected. (VIDEO 1 in the illustration above.)

⚠ If the VCRs you are connecting have S VIDEO jacks, you can use S VIDEO cables for improved picture quality (compared to a combination audio/video cable). Because S VIDEO cables carry only the video signal, you will need audio cables for sound.

Connecting a Satellite Receiver

- 1 Connect the satellite antenna cable to the satellite receiver's SATELLITE IN jack.
- 2 Using an A/V cable, connect the satellite receiver's Audio and Video OUT jacks to the TV's Audio and Video IN jacks.
- 3 Connect a coaxial cable from your cable or antenna to the TV's VHF/UHF jack.

 If the receiver you are connecting has an S VIDEO jack, you can use an S VIDEO cable for improved picture quality (compared to a combination audio/video cable). Because S VIDEO cables carry only the video signal, you will need audio cables for sound.

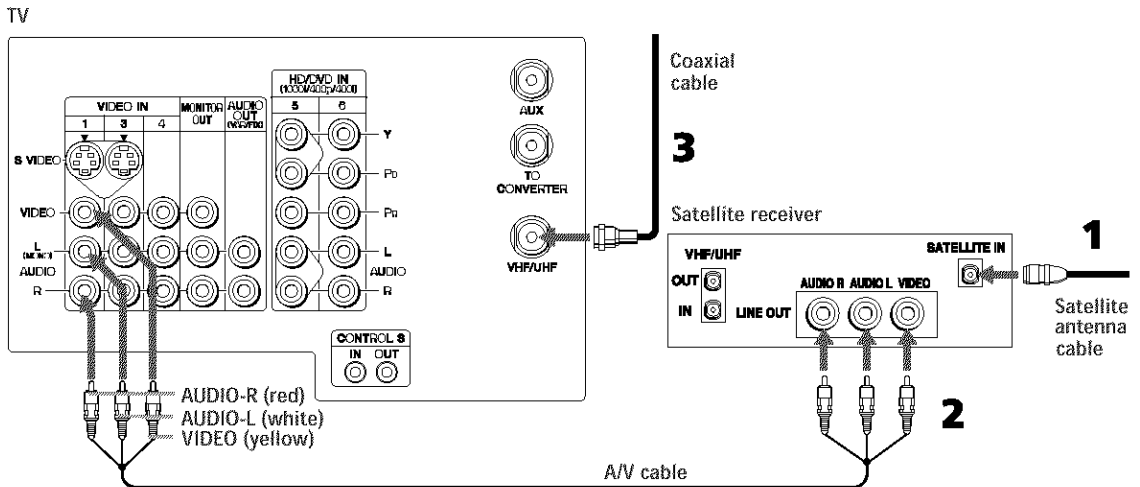

Connecting a Satellite Receiver with a VCR

- 1 Connect the satellite antenna cable to the satellite receiver's SATELLITE IN jack.
- 2 Connect the CATV cable to the VCR's VHF/UHF IN jack.
- 3 Using a coaxial cable, connect the VCR's OUT jack to the TV's VHF/UHF jack.
- 4 Using an A/V cable, connect the satellite receiver's Audio and Video OUT jacks to the VCR's Audio and Video IN jacks.
- 5 Using an A/V cable, connect the VCR's Audio and Video OUT jacks to the TV's Audio and Video IN jacks.

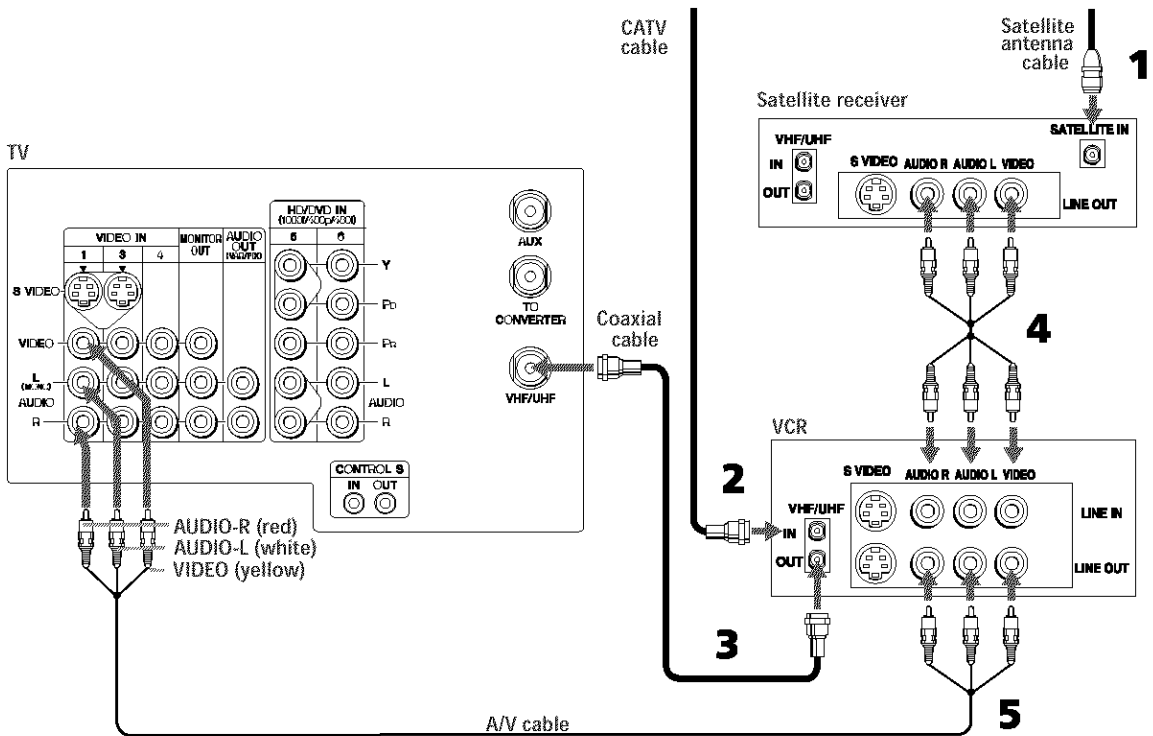

⚠ If the peripherals you are connecting have S VIDEO jacks, you can use S VIDEO cables for improved picture quality (compared to combination audio/video cables). Because S VIDEO cables carry only the video signal, you will need audio cables for sound.

- 6** If necessary, change the video input on your VCR. (See your VCR's user's guide for instructions on how to do that.)

To watch satellite TV, or the VCR

- Press TV/VIDEO on the remote control to select a video source.

To watch cable TV

- Press TV/VIDEO on the remote control to select VHF/UHF (to select the CATV cable on the TV).

Connecting an Audio Receiver

For better sound quality, you may want to connect your TV to your stereo system's audio receiver.

To connect to an audio receiver

- Use audio cables to connect the TV's Audio OUT jacks to the audio receiver's audio LINE IN jacks.

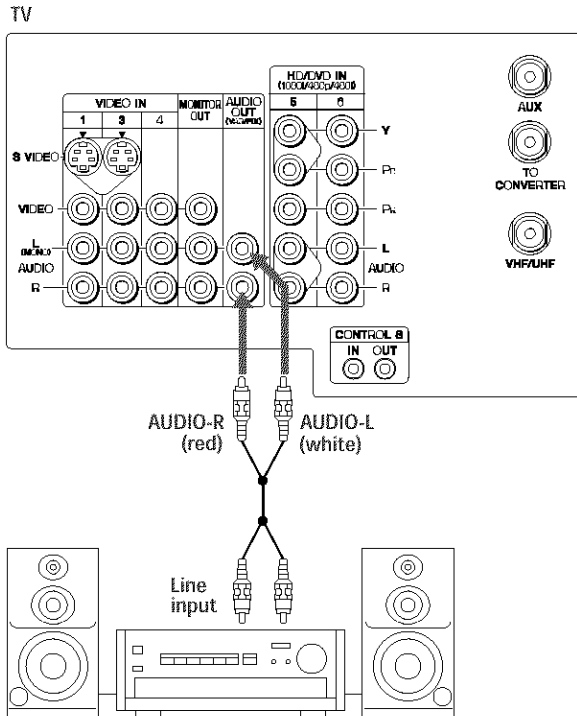

Connecting a DVD Player with Component Video Connectors

This is the preferred hookup to use if your DVD player has component (Y, PB, PR) jacks.

- 1 Using three separate component video cables, connect the DVD player's Y, PB and PR jacks to the Y, PB and PR jacks on the TV — the number 5 or 6 connections under HD/DVD IN.

⚠ The Y, PB and PR jacks on your DVD player are sometimes labeled Y, CB and CR, or Y, B-Y and R-Y. If so, connect the cables to like colors.

- 2 Using an audio cable, connect the DVD player's Audio OUT jacks to the TV's Audio IN jacks. Be sure to use the same column of inputs that you used for the video connection (HD/DVD IN 5 or 6).

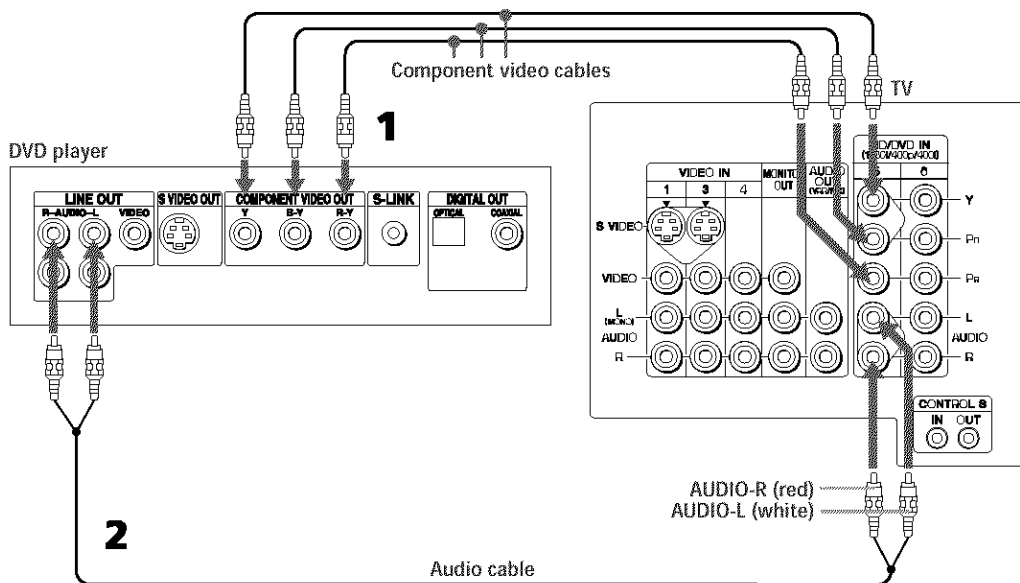

⚠ You cannot use the MONITOR OUT jacks to record the signal from any equipment connected into the Y, PB, PR jacks.

Connecting a DVD Player with A/V Connectors

Use this hookup if your DVD player does not have component (Y, PB, PR) jacks.

 An S VIDEO connection will give a good-quality video signal, but if your DVD player has component video, that connection (described on the previous page) will give an even better signal.

- 1 Using audio cables, connect the DVD player's Audio OUT jacks to the TV's Audio IN jacks.
- 2 Using an S VIDEO cable, connect the DVD player's S VIDEO jack to the TV's S VIDEO jack.

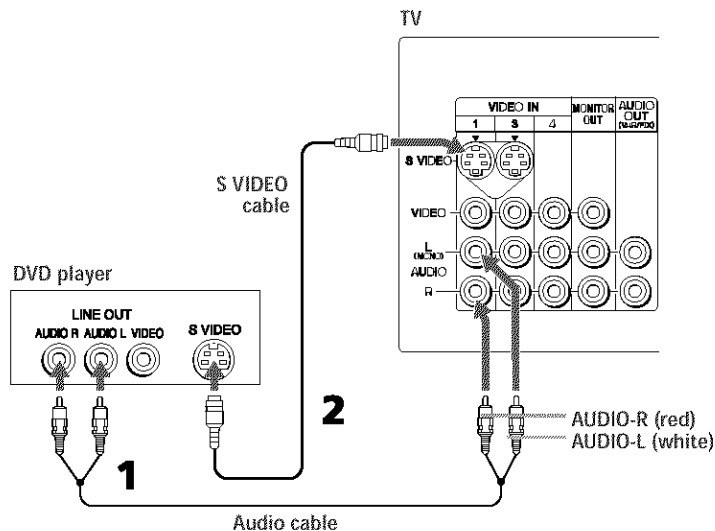

To switch between your TV and DVD

- Use the TV/VIDEO button on the TV's remote control to switch from one input device to another.

Connecting a Digital TV Receiver

 Be sure to read the manual for the Set-top box.

- 1 Using three separate component video cables, connect the Digital TV Set-top box's Y, P_B and P_R jacks to the TV.

 If you prefer, you can use an S VIDEO cable instead of the Y, P_B and P_R connections. The Y, P_B and P_R connections will provide the best-quality picture, but you cannot record the signal from any equipment connected to the Y, P_B and P_R inputs.

- 2 Using an audio cable, connect the Digital TV Set-top box's Audio OUT jacks to the TV's Audio IN jacks.

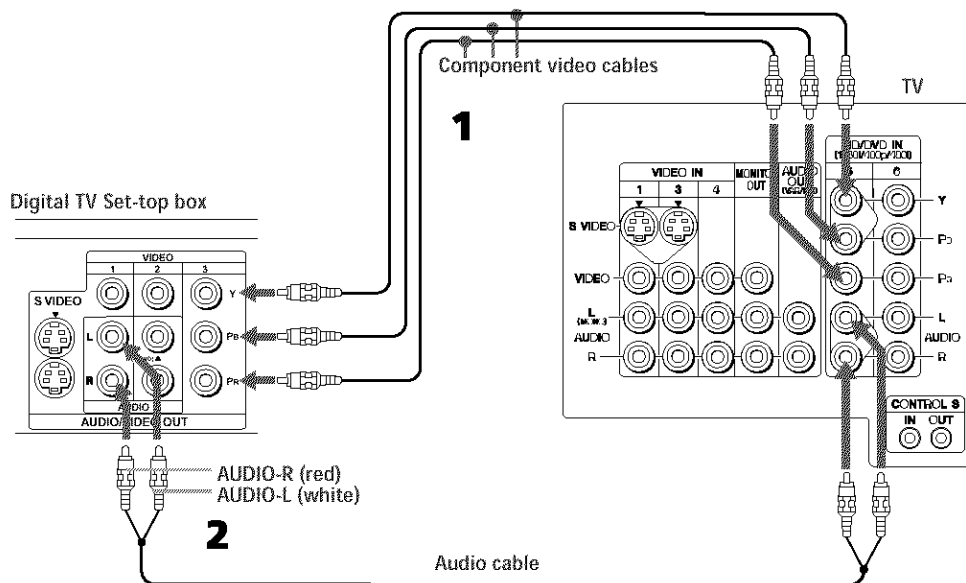

Connecting a Camcorder

For easy connection of the camcorder, the TV has front Audio and Video inputs (shown below). If you prefer, you can connect the camcorder to the TV's rear Audio and Video IN jacks.

- 1 Using A/V cables, connect the camcorder's Audio and Video OUT jacks to the TV's Audio and Video IN jacks.

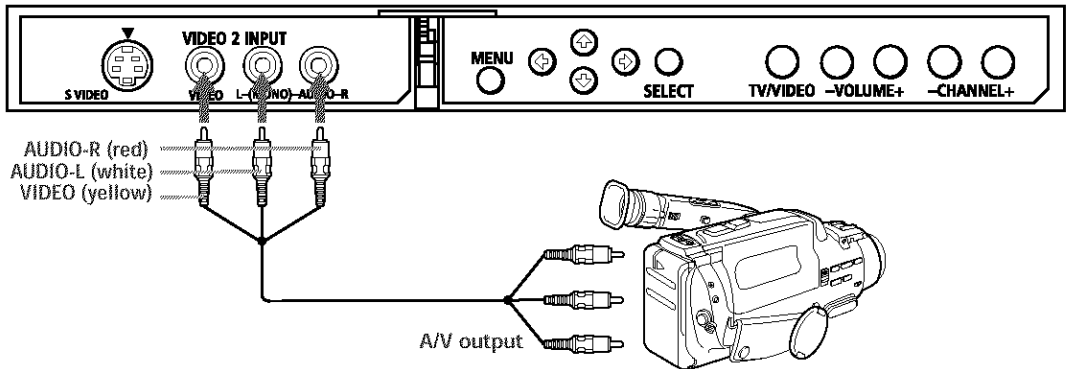

If you have a mono camcorder, connect its audio output to the TV's AUDIO L jack.

⚡ If the camcorder you are connecting has an S VIDEO jack, you can use an S VIDEO cable for improved picture quality (compared to a combination audio/video cable). Because S VIDEO cables carry only the video signal, you will also need audio cables for sound.

To view the camera's output

- Use the TV/VIDEO button on the front panel of the TV (or on the remote control) to set the TV to the video input to which the camcorder is connected. (VIDEO 2 in the illustration above.)

Using the CONTROL S Feature

The CONTROL S feature allows you to control your TV, plus other Sony equipment (such as a DVD player or VCR) connected to the TV, using only the TV's remote control. In addition to allowing you to control multiple devices with one remote control, the CONTROL S feature allows you to always point your remote control at your TV, instead of having to point it at the other equipment, which might be hidden or out of direct line of sight.

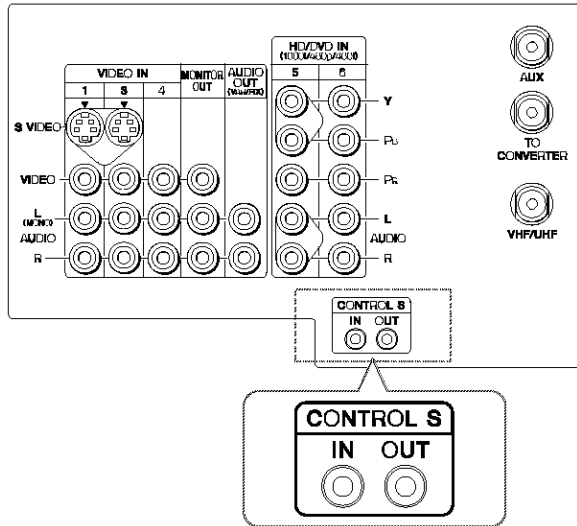

Setting Up the TV Automatically

After you finish connecting your TV, you can run Auto Setup to set up your channels. The Auto Setup screen appears when you turn your TV on for the first time after installing it. If you do not want to set up the channels at this time, you can do it later by using the Auto Program feature in the Channel menu (see page 40 for information regarding Channel menu).

 The Auto Setup feature does not apply for installations that use a cable box for all channel selection.

Using Auto Setup

- 1 Turn on the TV.
- 2 Press the TV FUNCTION button on the remote control.
- 3 Press CH+ to run Auto Setup.
- 4 After Auto Setup has run, press CH- to exit.

Reset TV to Factory Settings

To reset your TV to the factory settings

- 1 Turn on the TV.
- 2 Hold down the RESET button on the remote control.
- 3 Press and release the POWER button on the TV. (The TV will turn itself off, then back on.)
- 4 Release the RESET button.

Using the Features

Overview

This chapter describes how to use features of your TV.

<i>Topic</i>	<i>Page</i>
Using Favorite Channels	30
Using Twin View	31
Using the Freeze Function	34

Using Favorite Channels

The Favorite Channel feature lets you select programs from a list of favorite channels that you previously specified.

To display a list of your favorite channels:

- 1 If you have not already done so, create a list of favorite channels. (For information on setting up Favorite Channels see “Selecting Channel Options” on page 40.)
- 2 Press the FAVORITES button on the remote control.



- 3 Move the joystick \blacktriangle or \blacktriangledown to highlight the channel you want to watch. The program on that channel appears in the preview window.
- 4 Press the \oplus button to select the channel.

Using Twin View

Twin View lets you see two pictures — from an antenna, a VCR, a DVD, etc. — on the screen at the same time. (You can only hear the sound associated with one of the pictures however. You choose which picture's sound is selected.) You can change the relative size of each of the pictures.



Displaying Twin Pictures

To display twin pictures

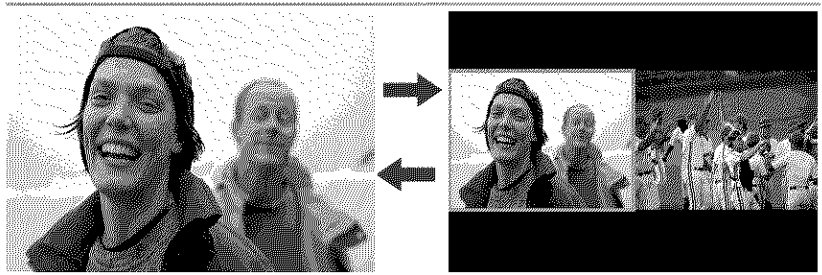
- 1 Press the  button on your remote control. (A second picture-window appears.)



2 To cancel twin pictures

- Press the  button
- or
- Press the  button.

Activating the Picture

With Twin View, the picture highlighted with a blue frame is active. In the active picture, you can:

- Change channels
- Adjust the volume.
- Switch the input sources (for example, press TV/VIDEO on the remote control).
- Change the picture size by pressing **▲/▼** on the joystick.

 Normally the TV memorizes the last-used sizes; when Twin View is turned off, then back on, the last-used sizes are displayed. If you are using the enhanced 16:9 picture, however, the aspect ratio changes to 4:3 in Twin View, and the picture is reformatted to that ratio.

To activate the right picture

- Move the joystick to the right (without pressing down on it).

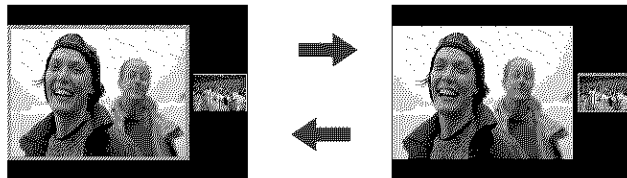

To activate the left picture

- Move the joystick to the left (without pressing down on it).

Factors affecting Twin View include:

- Equipment connected to the AUX and HD/DVD IN (numbers 5 and 6) inputs cannot be displayed in the right Twin View picture.

Changing the Picture Size

The zoom feature lets you vary the relative size of the left and right pictures.

- 1 Activate the picture whose size you want to change.
- 2 Press \blacktriangle on the joystick to enlarge the picture.
- 3 Press \blacktriangledown on the joystick to make the picture smaller.

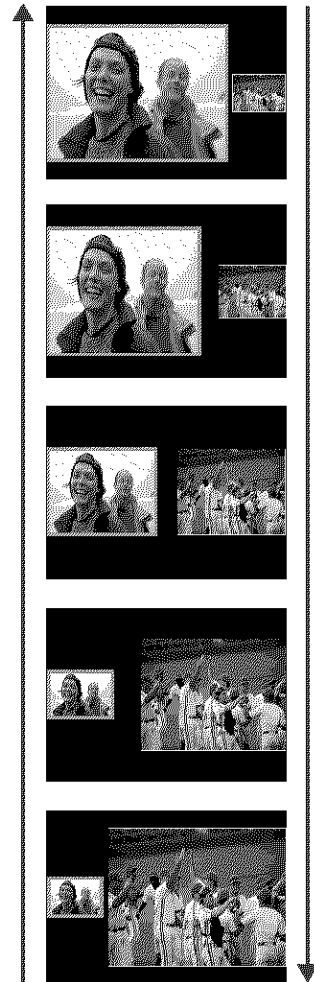

When you adjust the twin screen sizes, the TV memorizes the change. The next time you use the Twin View function, the memorized sizes appear.

Using the Freeze Function

The FREEZE button allows you to temporarily capture a program's picture. You can use this feature to write down information such as phone numbers, recipes, etc.

The FREEZE feature works only in normal view; if you are in Twin View, it will not work.

To use the FREEZE function

- 1 When the program information you want to capture is displayed, press the FREEZE button on the remote control.
- 2 The TV switches to Twin View mode and displays the "frozen" picture on the right, while the current program continues on the left.

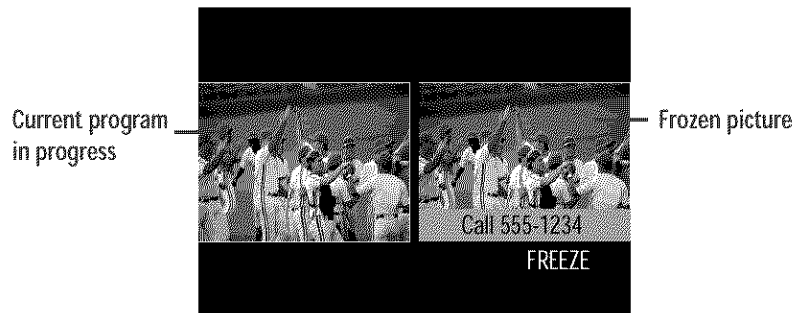







- 3 To cancel and return to normal viewing, press the FREEZE button.

Overview

Opening and choosing a menu:

- 1 Press the MENU button to display the Menu screen.
- 2 Move the joystick to the desired menu icon and press  to select it.
- 3 Use the joystick to scroll through the features.
- 4 See the specific menu page for instructions on moving through the menu.

The Menu gives you access to the following features:

<i>Menu Icon</i>	<i>Description</i>	<i>Page</i>
	VIDEO allows you to make adjustments to your picture settings. It also allows you to customize the Picture Mode based on the type of program you are viewing.	36
	AUDIO offers enhanced audio options such as listening to second audio programming (SAP), or customizing the effect of the sound on your TV.	38
	CHANNEL allows you to set up a Favorite Channel list, run the Auto Program function, and more.	40
	PARENT lets you control the viewing of programs based on their ratings.	42
	TIMER lets you set the clock on your TV and allows you to program your TV for scheduled viewing using the Timers.	46
	SETUP provides several options for setting up your channels, labeling your video inputs, and selecting the language of the on-screen menus.	47

To end a menu session:
Press MENU button again.

To end one menu session
and move to another:
Move the joystick upward
to return to the menu
icons.
Move the joystick to
choose the next menu icon
and press  to select it.



Using the Video Menu

To select the Video Menu

- 1 Press MENU.
- 2 Move the joystick to the Video icon  and press \odot .
- 3 Use the joystick to scroll through the features.
- 4 Press \odot to select a feature. That feature's adjustment appears.
- 5 Use the joystick to make the desired adjustments.
- 6 Press \odot to select the desired adjustment.
- 7 Press MENU to exit the menu screen.



To restore the factory default settings for Picture, Brightness, Color, Hue and Sharpness, Color Temp and VM.

- Press RESET on the remote control when in the Video menu.

Selecting Video Options

 To change from one Video Mode to another, use the PICTURE MODE button on the remote control.

The Video Menu includes the following options.

Option	Description
Mode	Vivid
<i>Customized picture viewing</i>	Standard
	Movie
	Pro

 You can alter the Video Menu settings (Picture, Brightness, Color, etc.) for each Mode.

Picture	Adjust to increase picture contrast and deepen the color or decrease picture contrast and soften the color.
Brightness	Adjust to brighten or darken the picture.
Color	Adjust to increase or decrease color intensity.
Hue	Adjust to increase or decrease the green tones.
Sharpness	Adjust to sharpen or soften the picture.

<i>Option</i>	<i>Description</i>
Color Temp	Choose from three color temperatures:
White intensity adjustment	Cool Select to give the white colors a blue tint.
	Neutral Select to give the white colors a neutral tint.
	Warm Select to give the white colors a red tint (NTSC-Standard).
VM Velocity Modulation	Sharpens picture definition to give every object a sharp, clean edge. Select from High, Medium, Low, Off.
DRC mode	Creates a high-resolution picture with 4x density, for high quality sources (i.e., DVD player, Satellite receiver).
Digital Reality Creation mode	Select from Interlaced or Progressive.
	Interlaced Recommended for moving pictures.
	Progressive Recommended for still images and text.



Using the Audio Menu

To select the Audio Menu

- 1 Press MENU.
- 2 Move the joystick to the Audio icon  and press \oplus .
- 3 Use the joystick to scroll through the options.
- 4 Press \oplus to select an option. That option's settings appear.
- 5 Use the joystick to make the desired adjustments.
- 6 Press \oplus to select the desired adjustment.
- 7 Press MENU to exit the menu screen.



To restore the factory default settings for Treble, Bass, and Balance

- Press RESET on the remote control when in the Audio menu.

Selecting Audio Options

The Audio Menu includes the following options:

<i>Option</i>	<i>Description</i>
Treble	Adjust to increase or decrease higher-pitched sounds.
Bass	Adjust to increase or decrease lower-pitched sounds.
Balance	Adjust to emphasize left or right speaker balance.
Steady Sound	ON Select to stabilize the volume.
	OFF Select to turn off Steady Sound.
Effect	SRS Produces a dynamic three-dimensional sound for stereo signals.
	Simulated Adds a surround-like effect to mono programs.
	OFF Normal stereo or mono reception.

<i>Option</i>	<i>Description</i>
<i>MTS Enjoy stereo, bilingual and mono programs</i>	Stereo Select for stereo reception when viewing a program broadcast in stereo.
	Auto-SAP Select to automatically switch the TV to second audio programs when a signal is received. (If no SAP signal is present, the TV remains in Stereo mode.)
	Mono Select for mono reception. (Use to reduce noise during weak stereo broadcasts.)
Speaker	ON Select to turn on the TV speakers.
	OFF Select to turn off the TV speakers and listen to the TV's sound only through your external audio system speakers.
<i>Audio Out Easy control of volume adjustments</i>	This option can be set only when the Speaker option is set to OFF.
	Variable Sound output varies according to the TV settings. Useful when you want to use the TV's remote control to adjust the output through a separate audio system.
	Fixed Sound output is held at a fixed level. Use your audio receiver's remote control to adjust the volume.



Using the Channel Menu

To select the Channel Menu





- 1 Press MENU.
- 2 Move the joystick to the Channel icon  and press \oplus .
- 3 Use the joystick to scroll through the features.
- 4 Press \oplus to select a feature. That feature's options appear.
- 5 Use the joystick to scroll through the options.
- 6 Press \oplus to select the desired option.
- 7 Press MENU to exit the menu screen.



Selecting Channel Options

The Channel Menu includes the following options:

Option	Description
Favorite Channel	1 Press \oplus to select a favorite channel number.
	2 Use the joystick to scroll through the channels until you find the channel you want to add to your favorites.
	3 Press \oplus to select it.
Cable	ON Select if you are receiving cable channels with a CATV cable.
	OFF Select if you are using an antenna.
 You should run Auto Program after changing the cable setting.	
Channel Fix <i>Useful when you have a cable box or satellite receiver connected</i>	2-6 "Fix" your TV's channel setting to 3 or 4 and use the cable box, VCR or satellite receiver to change channels. Select one of these settings if you have connected the device to the VHF/UHF jack.
	AUX 2-6 Same as 2-6, except you select one of these settings if you have connected the device to the AUX jack (see page 8).
	VIDEO 1 Use this setting if you have connected the device to the Audio and Video IN jacks.
Auto Program	Automatically programs the TV for all receivable channels from both VHF/UHF and AUX inputs.



<i>Option</i>	<i>Description</i>
Channel Skip/Add	Removes and adds viewable channels. <ol style="list-style-type: none">1 Use the joystick to scroll through the channels until you find the channel you want to skip/add.2 Press  to select it.3 Press the joystick (/) to toggle between “Add” and “Skip.”4 Press  to select.
Channel Label	Label up to 20 channels with their station call letters.



Using the Parent Menu

The Parent menu allows you to set up the TV to block programs according to their content and rating levels. These ratings are assigned by a federal rating board. Not all programs are rated. Using the Parental Lock blocks programs with a specific rating, but it does not block an entire channel.

To select the Parent Menu

- 1 Press MENU.
- 2 Move the joystick to the Parent icon  and press .
- 3 Use the 0-9 buttons on the remote control to enter your four-digit password.
- 4 Confirm your password by entering it again. (The Parent menu options appear.)
- 5 Use the joystick to scroll through the settings.
- 6 Press  to select the desired option.
- 7 Press MENU to exit the menu screen.



 You need your password for any future access into the Parent menu. If you lose your password, see "Lost password" on page 56.

Using the Parent Menu

 If you are not familiar with the Parental Guideline rating system, you should select Child, Youth, or Young Adult to help simplify the rating selection. To set more restrictive ratings, select Custom.

 For descriptions of Child, Youth, and Young Adult ratings, see page 44.

The Parent menu includes the following options.

<i>Option</i>	<i>Description</i>	
Parental Lock	OFF	Parental lock is off. No programs are blocked from viewing.
<i>Turn ratings on/off and select a rating system</i>	Child	Maximum ratings permitted are: <input type="checkbox"/> US: TV-Y, TV-G, G <input type="checkbox"/> Canada: TV-Y, C, G
	Youth	Maximum ratings permitted are: <input type="checkbox"/> US: TV-PG, PG <input type="checkbox"/> Canada: TV-PG, PG, 8 ans+
	Young Adult	Maximum ratings permitted are: <input type="checkbox"/> US: TV-14, PG-13 <input type="checkbox"/> Canada: TV-14, 14+, 13 ans+
	Custom	Select to set ratings manually. <input type="checkbox"/> US: See page 44 for details. <input type="checkbox"/> Canada: See page 45 for details.
Change Password	For changing your password.	

US Models: Selecting Custom Rating Options

 The content ratings will increase depending on the level of the age-based rating. For example, a program with a TV-PG V (Violence) rating may contain moderate violence, while a TV-14 V (Violence) rating may contain more intense violence.

 To ensure maximum blocking capability, the age-based ratings should be blocked.

 If you block unrated TV programs, be aware that the following types of programs may be blocked: emergency broadcasts, political programs, sports, news, public service announcements, religious programs and weather.

For US models, the Custom Rating Menu includes the following options. (For Canadian models, see page 45.)

<i>Option</i>	<i>Description</i>	
Movie Rating	G	All children and General Audience.
	PG	Parental Guidance suggested.
	PG-13	Parental Guidance for children under 13.
	R	Restricted viewing, parental guidance is suggested for children under 17.
	NC-17 and X	No one 17 and under allowed.
TV Rating	Age-Based Options	
<i>Block programs by their rating, content or both</i>	TV-Y	All children.
	TV-Y7	Directed to older children.
	TV-G	General Audience.
	TV-PG	Parental Guidance suggested.
	TV-14	Parents Strongly cautioned.
	TV-MA	Mature Audience only.
	Content-Based Options	
	FV	Fantasy Violence.
	D	Suggestive Dialogue.
	L	Strong Language.
	S	Sexual situations.
	V	Violence.
Unrated <i>Block programs or movies that are broadcast without a rating</i>	Block	Blocks all programs and movies that are broadcast without a rating.
	Allow	Allows programs and movies that are broadcast without a rating.

Canadian Models: Selecting Custom Rating Options

For Canadian models, the Custom Rating Menu includes the following options. (For US models, see page 44.)

<i>Option</i>	<i>Description</i>	
English Rating	C	All children.
	C8+	Children 8 years and older.
	G	General programming.
	PG	Parental Guidance.
	14+	Viewers 14 and older.
	18+	Adult programming.
French Rating	G	General programming.
	8 ans+	Not recommended for young children.
	13 ans+	Not recommended for ages under 13.
	16 ans+	Not recommended for ages under 16.
	18 ans+	Programming restricted to adults.
USA Rating	See "US Models" on page 44 for details.	



Viewing Blocked Programs

You can view a blocked program by entering the password. Press the ENTER button when tuned to a blocked program, and then enter the password. This temporarily switches off the Parental Lock. To reactivate the Parental Lock settings, turn off the TV. When the TV is turned on again, your Parental Controls settings are reactivated.





Using the Timer Menu

To select the Timer menu

- 1 Press MENU.
- 2 Use the joystick to move to the Timer icon  and press .



To set the Current Time

- 1 Use the joystick to select “Current Time”, then press .
- 2 If it is currently Daylight Saving Time, be sure to set that mode to “ON”. (Daylight Saving Time starts in the Spring and ends in the Fall.)
- 3 Use the joystick to enter the correct time, then press .
- 4 Press MENU to exit the menu screen.



To set the Timer

Before setting the timer, be sure to set your TV's clock to the current time (and, if appropriate, Daylight Saving Mode). To check the TV's time setting, press the DISPLAY button on the remote control.

- 1 Move the joystick to “Timer 1” or “Timer 2”, then press .
- 2 Use the joystick to enter your date, time and channel preferences, then press .
- 3 Press MENU to exit the menu screen.

To reset the Clock or Timers

- Press RESET on the remote control after selecting that option in the Timer menu. This resets to the factory defaults.

Selecting Timer Options

The Timer Menu includes the following options:

Option	Description
Timer 1	Program
Timer 2	Program
	Select to set the Timer by day, time, duration, and channel.
	OFF
	Select to turn off the Timer. (Your previous settings will be saved.)
Current Time	Set the current time.
Daylight Saving	ON
	Select in the Spring to turn on this mode during Daylight Saving Time.
	OFF
	Select in the Fall to turn off this mode at the end of Daylight Saving Time.



Using the Setup Menu

To select the Setup Menu

- 1 Press MENU.
- 2 Use the joystick to move to the Setup icon  and press \oplus .
- 3 Use the joystick to scroll through the features.
- 4 Press \oplus to select a feature. (That feature's options appear.)
- 5 Use the joystick to scroll through the options.
- 6 Press \oplus to select the desired option.
- 7 Press MENU to exit the menu screen.



Selecting Setup Options

The Setup Menu includes the following options:

<i>Option</i>	<i>Description</i>
Caption Vision	Allows you to select from three closed-caption modes (for programs that are broadcast with closed caption).
CC1, CC2, CC3, CC4	Displays a printed version of the dialog or sound effects of a program. (Should be set to CC1 for most programs.)
TEXT1, TEXT2, TEXT3, TEXT4	Displays network/station information presented using either half or the whole screen (if available).
XDS (Extended Data Service)	Displays a network name, program name, program length, and time of the show (if the broadcaster offers this service).
OFF	Turns off Caption Vision.

<i>Option</i>	<i>Description</i>
Video Label	Allows you to label the audio/video equipment you connected to the TV, so you can identify it when using the TV/VIDEO button. When in the Setup menu's Video Label feature, use the joystick to highlight an input to label, then press + to select it. Use the joystick to scroll through the labels. Press + to select the equipment you connected to each of the input jacks on the back of your TV. Select "Skip" if you do not have any equipment connected to a particular set of input jacks.
VIDEO 1/2/3/4	VHS, 8mm, Beta, LD, Game, SAT, DVD, Web, Receiver, DTV, Skip
VIDEO 5/6	HD, DVD, DTV, Skip
	 If you select "Skip", your TV skips this connection when you press the TV/VIDEO button.
Tilt Correction	Allows you to correct any tilt of the picture.
Language	Select to display all on-screen menus in your language of choice.
16:9 Enhanced	Provides enhanced picture resolution for widescreen sources, such as selected DVD titles (only available when the TV is in VIDEO mode). Press TV/VIDEO and select from one of the following options:
AUTO	To activate automatically when a 16:9 signal is received.
ON	To activate manually.
Demo	Runs a demonstration of on-screen menus.

 To use this feature with widescreen DVDs, set your DVD player to 16:9 aspect ratio.

 AUTO/ON will appear when TV is in VIDEO mode 1-6.
 ON/OFF will appear when TV is in VIDEO mode 5-6 and the 480p signal occurs.

Overview

This chapter includes the following topics:

<i>Topic</i>	<i>Page</i>
Programming the Remote Control	50
Operating Other Equipment with Your TV Remote Control	53
Troubleshooting	55
Specifications	57
Index	59

Programming the Remote Control

The remote control is preset to operate Sony brand video equipment.

<i>Sony Equipment</i>	<i>Switch Position on Remote Control</i>	<i>Programmable Code Number</i>
Beta, ED Beta VCRs	AV1	303
8 mm VCR	AV2	302
VHS VCR	AV3	301
DVD Player	DVD	751

If you have video equipment other than Sony brand that you want to control with the TV's remote control, use the following procedures to program the remote control.

 The equipment must have infrared (IR) remote capability in order to be used with the remote control.

From the "Manufacturer's Codes" listed on page 52, select the three-digit code number for the manufacturer's code for your equipment. If more than one code number is listed, start with the number listed first. Use the code number to complete the following procedure.

- 1 Move the slide switch to the desired equipment type.
- 2 Press CODE SET.

 You must perform step 3 within 10 seconds of step 2, or you must start again from step 2.

- 3 Press the white function button for the type of equipment you want to control with the TV's remote control (VCR/DVD or SAT/CABLE).
- 4 Enter the three-digit manufacturer's code number.
- 5 Press ENTER.
- 6 To check if the code number works, aim the TV's remote control at the equipment and press the green POWER button that corresponds with that equipment. If it responds, you are done. If not, try using the other codes listed for that manufacturer.

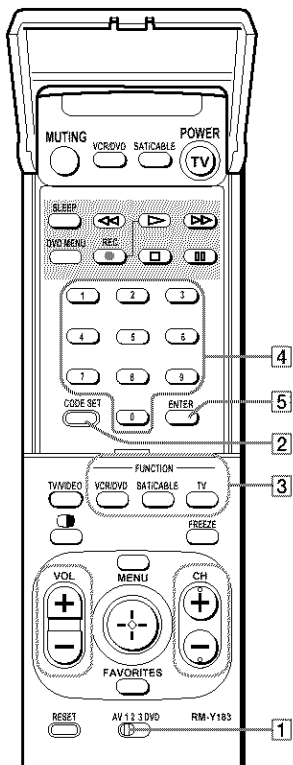

Tips

- ❑ If more than one code number is listed, try entering them one by one until you come to the correct code for your equipment.
- ❑ If you enter a new code number, the code number you previously entered at that setting is erased.
- ❑ In some cases, you may not be able to operate your equipment with the Sony remote control. In such cases, use the equipment's own remote control unit.
- ❑ Whenever you remove the batteries to replace them, the code numbers may revert to the factory setting and must be reset.

Manufacturer's Codes

VCRs

<i>Manufacturer</i>	<i>Code</i>
Sony	301, 302, 303
Admiral	327
(M. Ward)	
Aiwa	338, 344
Audio	314, 337
Dynamic	
Broksonic	319, 317
Canon	309, 308
Citizen	332
Craig	302, 332
Criterion	315
Curtis Mathes	304, 338, 309
Daewoo	341, 312, 309
DBX	314, 336, 337
Dimensia	304
Emerson	319, 320, 316, 317, 318, 341
Fisher	330, 335
Funai	338
General	329, 304, 309
Electric	
Go Video	322, 339, 340
Goldstar	332
Hitachi	306, 304, 305, 338
Instant Replay	309, 308
JC Penney	309, 305, 304, 330, 314, 336, 337
JVC	314, 336, 337, 345, 346, 347
Kenwood	314, 336, 332, 337
LXI (Sears)	332, 305, 330, 335, 338
Magnavox	308, 309, 310
Marantz	314, 336, 337
Marta	332
Memorex	309, 335
Minolta	305, 304
Mitsubishi/ MGA	323, 324, 325, 326
Multitech	325, 338, 321
NEC	314, 336, 337
Olympic	309, 308
Optimus	327

Manufacturer Code

Orion	317
Panasonic	308, 309, 306, 307
Pentax	305, 304
Philco	308, 309
Philips	308, 309, 310
Pioneer	308
Quasar	308, 309, 306
RCA/ PROSCAN	304, 305, 308, 309, 311, 312, 313, 310, 329
Realistic	309, 330, 328, 335, 324, 338
Sansui	314
Samsung	322, 313, 321
Sanyo	330, 335
Scott	312, 313, 321, 335, 323, 324, 325, 326
Sharp	327, 328
Shintom	315
Signature 2000 (M. Ward)	338, 327
SV2000	338
Sylvania	308, 309, 338, 310
Symphonic	338
Tashiro	332
Tatung	314, 336, 337
Teac	314, 336, 338, 337
Technics	309, 308
Toshiba	312, 311
Wards	327, 328, 335, 331, 332
Yamaha	314, 330, 336, 337
Zenith	331

Laserdisc Players

<i>Manufacturer</i>	<i>Code</i>
Sony	701
Panasonic	704, 710
Pioneer	702

DVD Players

<i>Manufacturer</i>	<i>Code</i>
Sony	751
GE	755
Hitachi	758
JVC	756
Magnavox	757
Mitsubishi	761
Oritron	759
Panasonic	753
Philips	757
Pioneer	752
RCA/ PROSCAN	755
Samsung	758
Toshiba	754
Zenith	760

Cable Boxes

<i>Manufacturer</i>	<i>Code</i>
Sony	230
Hamlin/Regal	222, 223, 224, 225, 226
Jerrold/G. I.	201, 202, 203, 204, 205, 206, 207, 208, 218
Oak	227, 228, 229
Panasonic	219, 220, 221
Pioneer	214, 215
Scientific	209, 210, 211
Atlanta	
Tocom	216, 217
Zenith	212, 213

Satellite Receivers

<i>Manufacturer</i>	<i>Code</i>
Sony	801
Dish Network	810
Echostar	810
General	802
Electric	
Hitachi	805
Hughes	804
Mitsubishi	809
Panasonic	803
RCA/ PROSCAN	802, 808
Toshiba	806, 807

Operating Other Equipment with Your TV Remote Control

Operating a VCR

Move the slide switch to the AV input you coded for this device.

<i>To Do This ...</i>	<i>Press</i>
Turn on/off	VCR/DVD (green POWER button)
Select VCR	VCR/DVD (white FUNCTION button)
Change channels	CH +/-
Record	▶ and REC simultaneously.
Play	▶
Stop	■
Fast forward	▶▶
Rewind the tape	◀◀
Pause	
Search the picture forward or backward	▶▶ or ◀◀ during playback (release to resume normal playback)

Operating a DVD Player

Move the slide switch to the AV input you coded for this device.

<i>To Do This ...</i>	<i>Press</i>
Turn on/off	VCR/DVD (green POWER button)
Select DVD	VCR/DVD (white FUNCTION button)
Play	▶
Stop	■
Pause	
Step through different tracks of an audio disc	▶▶ to step forward or ◀◀ to step backward
Step through different chapters of a video disc	CH+ to step forward or CH- to step backward
Display the DVD menu	DVD MENU
Select tracks directly	0-9 buttons

Operating a Cable Box

<i>To Do This ...</i>	<i>Press</i>
Turn on/off	SAT/CABLE (green POWER button)
Select Cable Box	SAT/CABLE (white FUNCTION button)
Select a channel	0-9 buttons, ENTER
Change channels	CH +/-
Back to previous channel	JUMP

Operating a Satellite Receiver

<i>To Do This ...</i>	<i>Press</i>
Turn on/off	SAT/CABLE (green POWER button)
Select Satellite Receiver	SAT/CABLE (white FUNCTION button)
Select a channel	0-9 buttons, ENTER
Change channels	CH +/-
Back to previous channel	JUMP
Display channel number	DISPLAY
Display SAT guide	GUIDE
Display SAT menu	MENU
Move highlight (cursor)	Joystick or arrows
Select item	⊕ button

Operating an MDP (Laserdisc Player)

Move the slide switch to the AV input you coded for this device.

<i>To Do This ...</i>	<i>Press</i>
Turn on/off	VCR/DVD (green POWER button)
Select MDP	VCR/DVD (white FUNCTION button)
Play	▶
Stop	■
Pause	
Search the picture forward or backward	▶▶ or ◀◀ during playback (release to resume normal playback)
Search a chapter forward or backward	CH +/-

Troubleshooting

Problem	Possible Remedies
No picture (screen not lit), no sound	<ul style="list-style-type: none"> <input type="checkbox"/> If your TV does not turn on, and a red light keeps flashing, your TV may need service. Call your local Sony Service Center. <input type="checkbox"/> Make sure the power cord is plugged in. <input type="checkbox"/> Push the power button on the front of the TV. <input type="checkbox"/> Check to see if the TV/VIDEO setting is correct: when watching TV, set to TV; when watching connected equipment, set to VIDEO 1, 2, 3, 4, 5 or 6, as appropriate. <input type="checkbox"/> Try another channel; it could be station trouble.
Remote control does not operate	<ul style="list-style-type: none"> <input type="checkbox"/> Batteries could be weak. Check the batteries and replace as necessary. <input type="checkbox"/> Press TV (FUNCTION) when operating your TV. <input type="checkbox"/> Make sure the TV's power cord is connected securely to the wall outlet. <input type="checkbox"/> Locate the TV at least 3-4 feet away from fluorescent lights. <input type="checkbox"/> Check the orientation of the batteries.
Dark, poor or no picture (screen lit), good sound	<ul style="list-style-type: none"> <input type="checkbox"/> Adjust the Picture setting in the Video menu (see page 36). <input type="checkbox"/> Adjust the Brightness setting in the Video menu (see page 36). <input type="checkbox"/> Check antenna/cable connections.
Good picture, no sound	<ul style="list-style-type: none"> <input type="checkbox"/> Press MUTING so that "MUTING" disappears from the screen (see page 4). <input type="checkbox"/> Make sure Speaker is set to ON in the Audio menu (see page 38).
Cannot receive upper channels (UHF) when using an antenna	<ul style="list-style-type: none"> <input type="checkbox"/> Change Cable to OFF (see page 40). <input type="checkbox"/> Use Auto Program in the Channel menu to add receivable channels that are not presently in memory (see page 40).
No color	<ul style="list-style-type: none"> <input type="checkbox"/> Adjust the Color settings in the Video menu (see page 36).
Only snow and noise appear on the screen	<ul style="list-style-type: none"> <input type="checkbox"/> Check the antenna/cable connections. <input type="checkbox"/> Try another channel (it could be station trouble). <input type="checkbox"/> Press ANT to change the input mode (see page 40).
Dotted lines or stripes	<ul style="list-style-type: none"> <input type="checkbox"/> Adjust the antenna. <input type="checkbox"/> Move the TV away from noise sources such as cars, neon signs, or hair-dryers.
TV is fixed to one channel	<ul style="list-style-type: none"> <input type="checkbox"/> Use Auto Program in the Channel menu to add receivable channels that are not presently in the TV's memory (see page 40). <input type="checkbox"/> Check your Channel Fix settings (see page 40).
Double images or ghosts	<ul style="list-style-type: none"> <input type="checkbox"/> Use a highly directional outdoor antenna or a cable (if the problem is caused by reflections from nearby mountains or tall buildings).
Cannot operate menu	<ul style="list-style-type: none"> <input type="checkbox"/> If the item you want to choose appears in gray, you cannot select it.
Cannot receive any channels when using cable TV	<ul style="list-style-type: none"> <input type="checkbox"/> Use Auto Program in the Channel menu to add receivable channels that are not presently in the TV's memory (see page 40). <input type="checkbox"/> Check your cable settings. <input type="checkbox"/> Make sure Cable is set to ON in the Channel menu (see page 40).

Problem	Possible Remedies
Cannot gain enough volume when using a cable box	<ul style="list-style-type: none">❑ Increase the volume of the cable box using the cable box's remote control. Then press TV (FUNCTION) and adjust the TV's volume.
Cannot receive channels	<ul style="list-style-type: none">❑ Use Auto Program in the Channel menu to add receivable TV channels that are not presently in TV memory (see page 40).
Unable to select a channel	<ul style="list-style-type: none">❑ Use Auto Program in the Channel menu to add receivable TV channels that are not presently in TV memory (see page 40).
Lost password	<ul style="list-style-type: none">❑ In the password screen (see page 42), enter the following master password: 4357. The master password clears your previous password; it cannot be used to temporarily unblock channels.
Cannot change channels with the remote control	<ul style="list-style-type: none">❑ Be sure you have not inadvertently switched your TV from channel 3 or 4 setting if you are using another device to change channels.❑ If you are using another device to control channels, be sure the "function" button for that device has been pressed.
Cannot cycle through the other video equipment connected to the TV	<ul style="list-style-type: none">❑ Be sure the Video Label feature has not been set to Skip (see page 48).
There is a black box on the screen	<ul style="list-style-type: none">❑ You have selected a text option in the Setup menu and no text is available. (See page 47 to reset Setup selections.) To turn this feature off, select OFF in the Caption Vision option. If you were trying to get closed captioning, select CC1 instead of Text 1-4.
There is no twin picture or it is just static	<ul style="list-style-type: none">❑ Be sure your twin picture is set to a video source/channel that has a program airing.❑ You may be tuned to a video input with nothing connected to it. Try cycling through your video inputs using the TV/VIDEO button.❑ Twin View is not set to receive a signal from the AUX input. If you have connected a VCR or satellite receiver to the AUX input on the TV, it will not show in the right picture.
I get the same program in both Twin View pictures	<ul style="list-style-type: none">❑ Both may be set to the same channel. Try changing channels in either the left or right picture.❑ You may be running all your channels through a cable box. The cable box will only unscramble one signal at a time. If possible, run a direct cable to your TV's VHF/UHF input. (This will only work if your cable system provides an unscrambled signal.)
I cannot get anything but TV channels in my left or right Twin View picture	<ul style="list-style-type: none">❑ Be sure the video label has not been set to skip your video inputs. See the Setup menu on pages 47 and 48.

If, after reading these operating instructions, you have additional questions related to the use of your Sony television, please call our Customer Information Services Center at 1-800-222-SONY (7669) (U.S. residents only) or (416) 499-SONY (7669) (Canadian residents only).

Specifications

All Models (General)

Picture Tube	FD Trinitron® tube	
Antenna	75 ohm external terminal for VHF/UHF	
Television System	NTSC, American TV Standard	
Channel Coverage		
VHF	2-13	
UHF	14-69	
CATV	1-125	
Power Requirements	120V, 60 Hz	
Number of Inputs/Outputs		
Video (IN)	4	1 V _{p-p} , 75 ohms unbalanced, sync negative
S Video (IN)	3	Y: 1 V _{p-p} , 75 ohms unbalanced, sync negative C: 0.286 V _{p-p} (Burst signal), 75 ohms
Audio (IN)	6	500 mV _{rms} (100% modulation) Impedance: 47 kilohm
Audio (OUT)	1	More than 408 mV _{rms} at the maximum volume setting (Variable) More than 408 mV _{rms} (Fixed) Impedance (output): 2 kilohms
Monitor Out	1	1 V _{p-p} , 75 ohms unbalanced, sync negative
CONTROL S (IN/OUT)	1	
Component Video Input	2 (Y, P _B , P _R)	Y: 1.0 V _{p-p} , 75 ohms unbalanced, sync negative; P _B : 0.7 V _{p-p} , 75 ohms P _R : 0.7 V _{p-p} , 75 ohms

Other Information

KV-32HS20

Supplied Accessories

Remote Control	RM-Y183
AA (R6) Batteries	2 supplied for remote control

Optional Accessories

AV Cable	VMC-810/820/830 HG
Audio Cable	RKC-515HG
S-LINK Cable	RK-G69HG
Component Video Cable	VMC-10/30 HG
TV Stand	SU-32HS2, SU-32XBR45
Visible Screen Size	32 in (812.8 mm) picture measured diagonally
Actual CRT Size	34 in (863.4 mm) picture measured diagonally
Speaker Output	15W x 2
Dimensions (W x H x D)	898.0 x 678.0 x 579.5 mm (35 3/8 x 26 3/4 x 27 7/8 in)
Mass	84 kg (185 lbs)
Power Consumption	
In Use	245 W
In Standby	2 W

KV-36HS20

Supplied Accessories

Remote Control	RM-Y183
AA (R6) Batteries	2 supplied for remote control

Optional Accessories

AV Cable	VMC-810/820/830 HG
Audio Cable	RKC-515HG
Component Video Cable	VMC-10/30 HG
TV Stand	SU-36HS2, SU-36XBR45
Visible Screen Size	36 in (914 mm) picture measured diagonally
Actual CRT Size	38 in (965.2 mm) picture measured diagonally
Speaker Output	15W x 2
Dimensions (W x H x D)	994 x 754.5 x 622 mm (39 1/4 x 29 3/4 x 24 1/2 in)
Mass	108 kg (238 lbs)
Power Consumption	
In Use	245 W
In Standby	2 W

Design and specifications are subject to change without notice.

Index

16:9 (widescreen) 2, 48

A

Adding channels to the channel list 40

Adjusting the picture definition 36

Adjusting the audio

Steady Sound 38

Activating Twin View 31

ANT button 4

antenna, connecting 10

Aspect ratio, 16:9

in Twin View 32

Audio menu 35, 38

audio receiver, connecting 22

Auto-SAP 39

Auto Program (channel setup) 28, 40

Auto setup 28, 40

B

balance, adjusting 38

bass, adjusting 38

batteries

inserting in remote 3

bilingual audio 39

blocking programs. See ratings.

brightness, adjusting 36

C

cable

box, connecting with VCR 15

connecting 10-13

setting ON/OFF 40

with VCR, connecting 14

cable box, using with TV remote control 54

camcorder, connecting 26

Caption Vision 47

CATV. see cable

Channel list, adding channels 30, 40

Channel menu 35, 40

Channel Setup menu 40

Channel Skip/Add 41

channels

creating labels 41

setting up 28

closed caption modes 47

Code Set button 6

color temperature, adjusting 37

color, adjusting 36

Connecting:

Audio receiver 22

Cable or antenna 10-13

Cable box 11-13, 15-16

Camcorder 26

Digital TV receiver 25

DVD player 23, 24

Satellite receiver 19-21

VCR 14-18

with Satellite receiver 20

Contents of package 3

CONTROL S 27

Controls and connectors 8-9

Converter 12

D

Demo, menus 48

Digital Reality Creation 37

Display button 4

Display, turning off 4

DRC, see Digital Reality Creation

DVD player

using with TV remote control 53

with A/V connectors, connecting 24

with component video connectors,
connecting 23

E

Enhanced picture resolution, 16:9 48

enlarging picture, a Twin View picture 33

Extended Data Service 47

F

- Favorite Channel
 - setting up 40
 - using 30
- Favorites button 5
- features 2
- Freeze, using 34
- Front Panel controls 8

G

- Guide button 5

H

- Hookups 10-26
- hue, adjusting 36

I

- inputs, labeling 48
- Installation 10-26

J

- Jump button 4

L

- label
 - channels 41
 - video inputs 48
- Languages, setting for closed captioning 48
- Locking programs 42-45

M

- Manufacturer's codes 52
- MDP, using with TV remote control 54
- Menu button 5
- menus
 - Audio 35, 38
 - Channel 35, 40
 - Channel Setup 40
 - Parent 35, 42
 - Parental Control 42
 - Setup 35, 47
 - Timer 35, 46
 - Video 35, 36
- Muting 4

P

- Parent menu 35, 42
- parental control, described 2
- password
 - changing 43, 56
- picture contrast, adjusting 36
- picture definition, adjusting 37
- Picture Mode 4, 36
- Picture size, adjusting in Twin View 33
- power cord, removing from holder 7
- presetting channels 40
- problems, troubleshooting 55-56

R

- ratings
 - setting 42-45
 - viewing blocked programs 45
- Rear panel controls and connections 8-9
- remote control
 - inserting batteries 3
 - programming 50-52
- Remote control, operating other equipment with
 - Cable box 54
 - DVD 53
 - MDP 54
 - Satellite receiver 54
 - VCR 53
- Remote control, buttons 4-6
- Reset button 4
- resetting
 - Audio options 38
 - Timer options 46
 - To factory settings 28
 - Video options 36

S

- SAT/CABLE Function button 5
- SAT/CABLE Power button 4
- satellite receiver
 - connecting 19, 20
 - using with TV remote control 54
- Setting favorite channel 40
- setting up channels 28
- Setup menu 35, 47
- sharpness, adjusting 36
- Sleep button 6

sound effect, adjusting 38
speakers
 turning on/off 39
 using external speakers 22, 39
specifications 57-58
SRS 38
Steady Sound
 adjusting 38
 described 2

T

tape-to-tape editing 18
Time, set current 46
Time, set daylight saving 46
Timer setting 46
tilt, correcting 48
Timer menu 35, 46
treble, adjusting 38
troubleshooting 55-56
TV Function button 5
TV Power button 4
TV/VIDEO button 4
Twin View
 activating a picture 32
 changing the picture size 33
 displaying a picture 31

V

VCR
 connecting two, for tape editing 18
 using with TV remote control 53
 with cable box, connecting 15
 with cable, connecting 14
 with satellite receiver, connecting 20
VCR/DVD Function button 5
VCR/DVD Power button 4
Velocity Modulation 2, 37
video inputs, labeling 48
Video menu 35, 36
Video Modes, selecting 36

W

Wega, described 2
widescreen 48
widescreen, described 2

Z

zoom feature, with Twin View 33

