

Panasonic[®]

Combination 15.2" LCD TV/DVD Player

Operating Instructions

Model No.

TC-15DT2

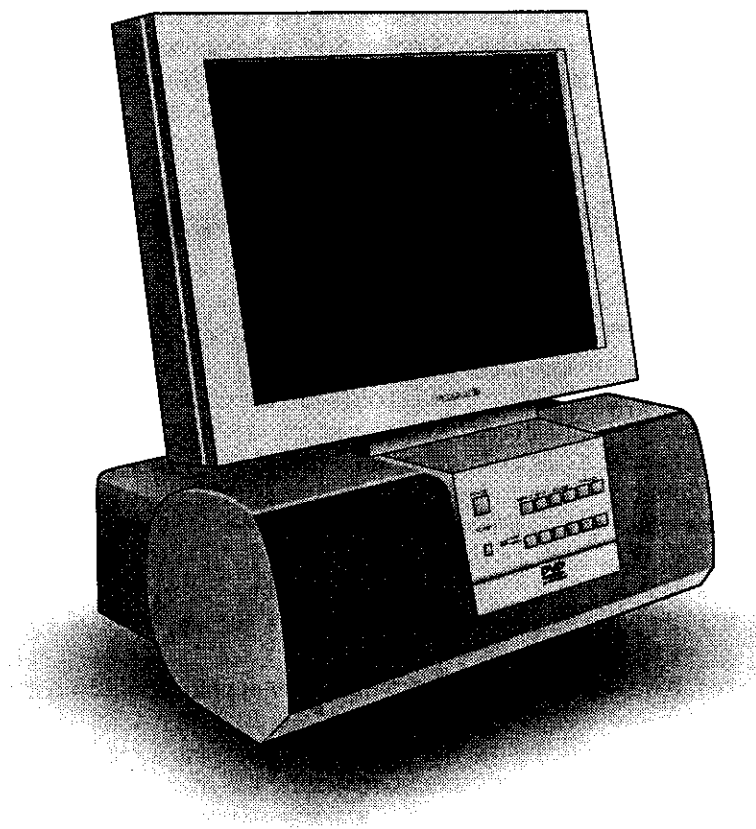

For assistance, please call : 1-800-211-PANA (7262)

or send e-mail to : consumerproducts@panasonic.com

or visit us at www.panasonic.com

(U.S.A)

For assistance, please call : 787-750-4300

(Puerto Rico)

This manual is divided into two parts, the "Install and TV Adjusts" and "DVD Operation Guide" :

Install and TV Adjusts: Details on installation of the unit and adjustments to achieve optimum quality of the TV.

DVD Operation Guide: Details on operating instructions for playing disks such as DVDs and CDs.

Before connecting, operating or adjusting this product, please read these instructions completely. Please keep this manual for future reference.

Important Safety Instructions



The lightning flash with arrow-head within a triangle is intended to tell the user that parts inside the product are a risk of electric shock to persons.



The exclamation point within a triangle is intended to tell the user that important operating and servicing instructions are in the papers with the appliance.

Note to CATV System Installer: This reminder is provided to direct the CATV system installer's attention to Article 820-40 of the NEC that provides guidelines for proper grounding and, in particular, specifies that the cable ground shall be connected to the grounding system of the building, as close to the point of cable entry as practical.

Important Safety Instructions for LCD TV

- 1) Read these instructions and apply them with your LCD TV.
- 2) Keep these instructions.
- 3) Heed all warnings.
- 4) Follow all instructions.
- 5) Do not use this apparatus near water. For example: Avoid placing it near a bathtub, washbowl, kitchen sink, or laundry tub, in a wet basement, or near a swimming pool, etc.
- 6) Clean only with dry cloth. Unplug this LCD TV from the wall outlet before cleaning. Do not use liquid or aerosol cleaners.
- 7) Do not block any ventilation openings. Install in accordance with the manufacturer's instructions. Slots and openings in the cabinet and the back or bottom are provided for ventilation, and to insure reliable operation of the LCD TV and to protect it from overheating. These openings must not be blocked or covered. There should be at least 10 cm of space from these openings. The openings should never be blocked by placing the LCD TV on a bed, sofa, rug or other similar surface. This LCD TV should not be placed in a built-in installation such as a bookcase unless proper ventilation is provided.
- 8) Do not install near any heat sources such as radiators, heat registers, stoves, or other apparatus (including amplifiers) that produce heat.
- 9) Protect the power cord from being walked on or pinched particularly at plugs, convenience receptacles, and the point where they exit from the apparatus.
- 10) Only use attachments/accessories specified by the manufacturer. Otherwise it may cause hazards.
- 11) Use only with the cart, stand, tripod, bracket, or table specified by the manufacturer, or sold with the apparatus. When a cart is used, use caution when moving the cart/apparatus combination to avoid injury from tip-over. 
- 12) Unplug this apparatus during lightning storms or when unused for long periods of time. This will prevent damage to the receiver due to lightning and power-line surges.
- 13) Refer all servicing to qualified service personnel. Servicing is required when the apparatus has been damaged in any way, such as power-supply cord or plug is damaged, liquid has been spilled or objects have fallen into the apparatus, the apparatus has been exposed to rain or moisture, does not operate normally, or has been dropped. Upon completion of any service or repairs to this LCD TV, ask the service technician to perform routine safety checks to determine that the television is in safe operating condition.
- 14) Operate only from the type of power source indicated on the marking label. If you are not sure of the type of power supplied to your home consult your television dealer or local power company.
- 15) Follow all warnings and instructions marked on the LCD TV.
- 16) Never push objects of any kind into this LCD TV through cabinet slots as they may touch dangerous voltage points or short out parts that could result in a fire or electric shock. Never spill liquid of any kind on the LCD TV.

Important Safety Instructions

17) If an outside antenna is connected to the television equipment, be sure the antenna system is grounded so as to provide some protection against voltage surges and built up static charges. In the U.S. Section 810-21 of the National Electrical Code provides information with respect to proper grounding of the mast and supporting structure, grounding of the lead-in wire to an antenna discharge unit, size of grounding conductors, location of antenna discharge unit, connection to grounding electrodes, and requirements for the grounding electrode.

18) An outside antenna system should not be located in the vicinity of overhead power lines or other electric light or power circuits, or where it can fall into such power lines or circuits. When installing an outside antenna system extreme care should be taken to keep from touching such power lines or circuits as contact with them might be fatal.

19) Unplug this LCD TV from the wall outlet, and refer servicing to qualified service personnel under the following conditions:

- a. When the power cord or plug is damaged or frayed.
- b. If liquid has been spilled into the LCD TV.
- c. If the LCD TV has been exposed to rain or water.
- d. If the LCD TV does not operate normally by following the operating instructions.

Adjust only those controls that are covered by the operating instructions as improper adjustment of other controls may result in damage and will often require extensive work by a qualified technician to restore the LCD TV to normal operation.

- e. If the LCD TV has been dropped or the cabinet has been damaged.
- f. When the LCD TV exhibits a distinct change in performance - this indicates a need for service.

20) When replacement parts are required, be sure the service technician to use replacement parts specified by the manufacture that have the same characteristics as the original part. Unauthorized substitutions may result in fire, electric shock, or other hazards.

21) **WARNING: TO REDUCE THE RISK OF FIRE OR ELECTRIC SHOCK, DO NOT EXPOSE THIS APPARATUS TO RAIN OR MOISTURE.**

22) **CAUTION: TO PREVENT ELECTRIC SHOCK DO NOT USE THIS PLUG WITH A RECEPTACLE OR OTHER OUTLET UNLESS THE BLADES CAN BE FULLY INSERTED TO PREVENT BLADE EXPOSURE.**

23) **CAUTION: USE WITH OTHER STAND IS CABABLE OF RESULTING IN INSTABILITY CAUSING POSSIBLE INJURY.**

24) **CAUTION: DANGER OF EXPLOSION IF BATTERY IS INCORRECTLY REPLACED. REPLACE ONLY WITH THE SAME OR EQUIVALENT TYPE.**

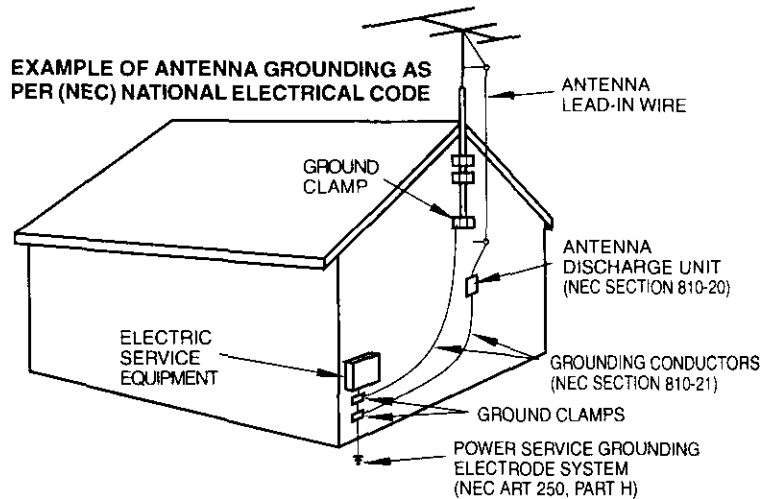

NOTE: ● This equipment is designed to operate in the U.S.A. and other countries where the broadcasting system and AC house current is exactly the same as in the U.S.A.
● The marking or retained image on the LCD panel resulting from fixed image use is not an operating defect and as such is not covered by Warranty. This product is not designed to display fixed image patterns for extended periods of time.

Important Information Regarding Use of Video Games, Computers, Caption or Other Fixed Image Displays.

The extended use of fixed image program material can cause a permanent "shadow image" on the LCD panel.

This background image is viewable on normal programs in the form of a stationary fixed image. This type of irreversible LCD panel deterioration can be limited by observing the following steps:

- A. Reduce the brightness/contrast setting to a minimum viewing level.
- B. Do not display the fixed image for extended periods of time.
- C. Turn the power off when not in actual use.

Dear Panasonic Customer

Welcome to the Panasonic family of customers.

We hope that you will have many years of enjoyment from your new 15.2" LCD TV with built in DVD player.

To obtain maximum benefit from your set, please read these Instructions before making any adjustments, and retain them for future reference.

Retain your purchase receipt also, and note down the model number and serial number of your set in the space provided on the rear cover of these instructions.

For assistance, please call : 1-800-211-PANA (7262)

or send e-mail to : consumerproducts@panasonic.com

or visit us at www.panasonic.com

(U.S.A)

For assistance, please call : 787-750-4300

(Puerto Rico)

Federal Communication Commission Information

This equipment has been tested and found to comply with the limits for a TV Broadcast Receiver, pursuant to Part 15 of the FCC Rules. These limits are designed to provide reasonable protection against harmful interference in a residential installation. This equipment generates, uses and can radiate radio frequency energy and, if not installed and used in accordance with the instructions, may cause harmful interference to radio communications. If this equipment does cause or receive interference, which can be determined by turning equipment off and on, the user is encouraged to try to correct the interference by one of the following measures:

Reorient or relocate the TV antenna.

Increase the separation between TV and other equipment.

Connect TV into separate outlet from other equipment.

Consult the dealer or an experienced radio/TV technician for help.

FCC Caution: Any changes or modifications not expressly approved by the party responsible for compliance could void the user's authority to operate this equipment.

CAUTION:

COMBINATION 15.2 " LCD TV/DVD PLAYER IS A CLASS 1 LASER PRODUCT. HOWEVER THIS COMBINATION 15.2 " LCD TV/DVD PLAYER USES A VISIBLE LASER BEAM WHICH COULD CAUSE HAZARDOUS RADIATION EXPOSURE IF DIRECTED. BE SURE TO OPERATE THE COMBINATION 15.2 " LCD TV/DVD PLAYER CORRECTLY AS INSTRUCTED.

**CLASS 1
LASER PRODUCT**

WHEN THIS COMBINATION 15.2 " LCD TV/DVD PLAYER IS PLUGGED TO THE WALL OUTLET, DO NOT PLACE YOUR EYES CLOSE TO THE OPENING OF THE DISC TRAY AND OTHER OPENINGS TO LOOK INTO THE INSIDE OF THIS PLAYER.

USE OF CONTROLS OR ADJUSTMENTS OR PERFORMANCE OF PROCEDURES OTHER THAN THOSE SPECIFIED HEREIN MAY RESULT IN HAZARDOUS RADIATION EXPOSURE.

DO NOT OPEN COVERS AND DO NOT REPAIR YOURSELF. REFER SERVICING TO QUALIFIED PERSONNEL.

Table of Contents

Install and TV Adjusts (start from the next page)

Important Safety Instructions	2	Tuning channels (Manual channel programming)	19
Federal Communication Commission Information	4	Playing a VCR or other peripheral equipment	20
Installation	6	Setting condition to be displayed	21
Disc handling	6	Stoppage of the Tray action (Child lock)	22
Maintenance	7	ASPECT Controls	23
SUPPLIED ACCESSORIES	7	Adjusting screen position and size	24
Remote control battery installation	7	Picture Adjustments	25
Connecting the Antenna Cable to the RF In Terminal	8	Audio Adjustments	27
Antenna / Cable Connection	8	Selecting STEREO/SAP/MONO	28
How to connect the input terminals	10	Closed Captions	29
How to connect the AV OUT Terminals	10	Lock Feature	30
How to connect the 5.1ch SURROUND AUDIO OUT Terminals	11	Customizing the VIDEO INPUT labels	33
Connecting Headphones / Earphones	12	Adjusting unnatural video images (3D Y/C FILTER)	34
Connecting OPTICAL audio cable	12	Automatically changing screen size for VIDEO INPUT modes	35
Power ON / OFF	13	When the top and bottom of the screen noise (IMAGE ADJ.)	35
How to Turn the Power On	13	Natural Color	36
Location of Controls	14	Noisy Picture	36
Flow Chart of TV menu	16		
Tuning channels (Automatic channel programming)	18		

DVD Operation Guide

Features of DVD on this Product	38	Storing a marker in the memory	51
Enjoying digital audio output from the digital audio output connector	39	Recalling / clearing a marker	51
Location of Controls for DVD Operation	40	Program play [Video CD / CD]	52
Basic play	42	Random play [Video CD / CD]	53
Recalling/clearing a marker	42	Changing audio soundtrack language [DVD]	54
Stopping play	43	Changing subtitle language [DVD]	55
Skipping chapters or tracks	44	Viewing from another angle [DVD]	55
Still picture (Pause)	44	Initial settings	56
Rapid advance (Rapid reverse)	44	Common procedures	56
Frame advance (Frame reverse) [DVD/Video CD]	45	Selecting disc language [DVD]	57
Slow-motion play [DVD/Video CD]	45	Selecting rating level [DVD]	57
Cancelling playback control [Video CD]	45	Selecting On-Screen Display menu language	59
General information about GUI screens	46	Selecting On-Screen Display Messages	59
Common procedures	46	Selecting TV screen Aspect	60
Detailed descriptions of each GUI icon	47	Selecting digital output	61
Screen for disc information (For DVD)	47	Speaker setting	62
Screen for disc information (For Video CD/CD)	48	Other settings	66
Screen for player information	49	Language code list	66
Shuttle screen	49	How images appear on your TV (aspect ratios of the screen)	67
Repeat play	50	Troubleshooting	68
Repeat viewing (Listening)	50	Maintenance	69
Repeating sections between two specific points (A-B repeat)	51	Specifications	70
Storing markers in memory to be viewed (listened to) again ...	51		

Installation

Receiver Location

Locate for comfortable viewing. Avoid placing where sunlight or other bright light (including reflections) will fall on the screen. Use of some types of fluorescent lighting can reduce remote control transmitter range.

Adequate ventilation is essential to prevent internal component failure. Keep away from areas of excessive heat or moisture. To insure optimum picture do not position magnetic equipment (motors, fans, other speakers, etc.) nearby.

Optional External Equipment

The Video/Audio connection between components can be made with shielded video and audio cables. For best performance, Antenna cables should utilize 75 ohm coaxial shielded wire. Cables are available from your dealer or electronic supply store. Before you purchase any cables, be sure you know what type of output and input connectors your various components require. Also determine the length of cable you'll need.

For optimum quality picture

When the LCD is exposed to light from outdoors or lighting fixtures, high-contrast pictures may not be displayed clearly. Turn off florescent lamps near the LCD and place in a location not exposed to outdoor light.

Disc handling

Handling precautions

- Hold the disc by the edges so the surface will not be soiled with fingerprints. Fingerprints, dirt and scratches can cause skipping and distortion. **(A)**:
- Do not write on the label side.
- Do not use record cleaning sprays, benzine, thinner, static electricity prevention liquids or any other solvent.
- Be careful not to drop or bend the disc.
- Do not install more than 1 disc on the disc tray.
- Do not close the disc tray if the disc is not installed properly. **(B)**
- Store the disc in its case when not in use.

If the surface is soiled **(C)**

Wipe gently with a soft, damp (water only) cloth.

When wiping discs, always wipe from the center toward the outer edge.

(If you wipe using a circular motion, circular scratches can occur, which will cause noise.)

If the disc is brought from a cold to a warm environment, moisture may form on the disc

Wipe with a soft, dry, lint-free cloth before using the disc.

Improper disc storage

You can damage discs if you store them in the following places:

- Areas exposed to direct sunlight
- Humid or dusty areas
- Areas directly exposed to a heat outlet or heating appliance

Discs which cannot be played with this player

- DVD with Region No. other than "1" or "ALL"
- DVD-ROM
- DVD-R/DVD-RAM
- CD-ROM
- VSD
- CDV
- CD-G
- CD-RW
- CVD+RW
- CDV
- SVCD
- Divx Video Disc etc.
- Do not try to play Photo CD or CD-R.
(Data on the disc may be damaged.)

A

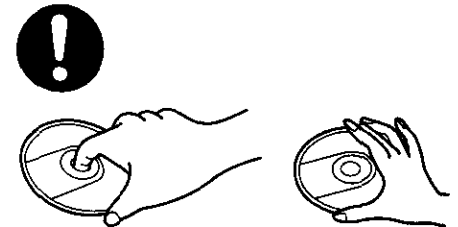

B

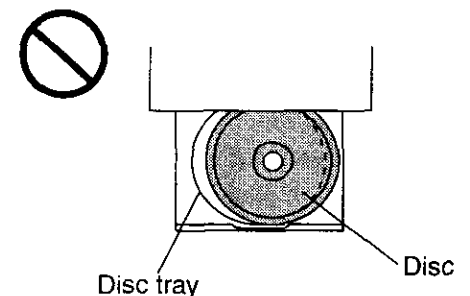

C

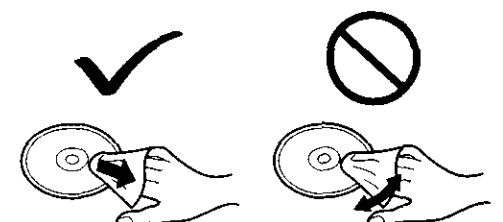

SUPPLIED ACCESSORIES

Check the accessories before installations.

- Operating Instruction book (TQBC0256)

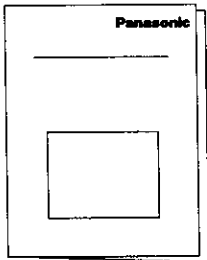

- Remote Control Transmitter (TNQE262)



- Battery for the Remote Control Transmitter (2 × AAA size)

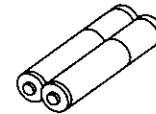

- Warranty Card

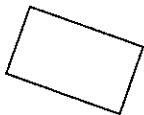

- Service Center List

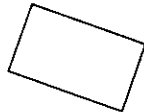

- AC Adaptor & AC Cord
AC Adaptor: (NOJEHK000001)
AC Cord: (K2CA2EA00005)

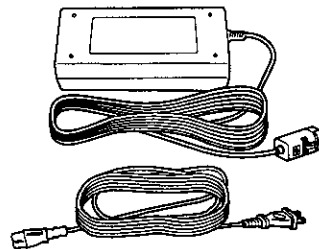

Remote control battery installation

Requires two AAA batteries.

1. Turn the transmitter face down. Remove top cover by pressing down on marking and sliding cover off in the direction indicated.
2. Install the batteries as shown in the battery compartment. (Polarity + or – must match the markings in the compartment).
3. Replace the cover and slide in reverse until the lock snaps.

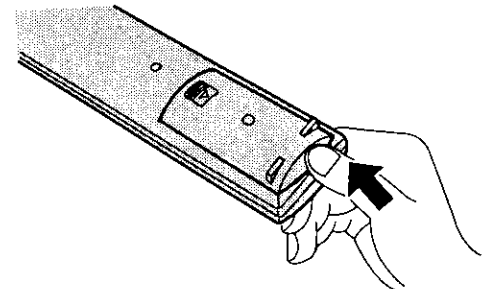
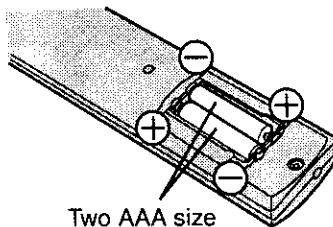
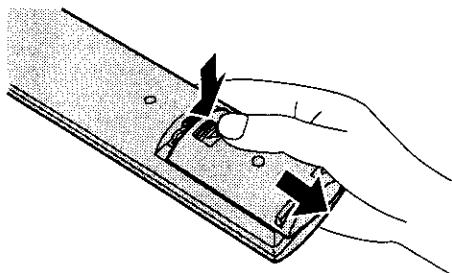

Helpful Hint:

For frequent remote control users, replace old battery with Alkaline batteries for longer life.

⚠ Precaution on battery use

Incorrect installation can cause battery leakage and corrosion that will damage the remote control transmitter.

Observe the following precautions:

1. Batteries should always be replaced as a pair. Always use new batteries when replacing the old set.
2. Do not combine a used battery with a new one.
3. Do not mix battery types (example: "Zinc Carbon" with "Alkaline").
4. Do not attempt to charge, short-circuit, disassemble, heat or burn used batteries.
5. Battery replacement is necessary when remote control acts sporadically or stops operating this unit.

Installation

Connecting the Antenna Cable to the RF In Terminal

Antenna Connection - For proper reception of VHF/UHF channels, an external antenna is required. For best reception an outdoor antenna is recommended. Antenna Mode must be set to TV.

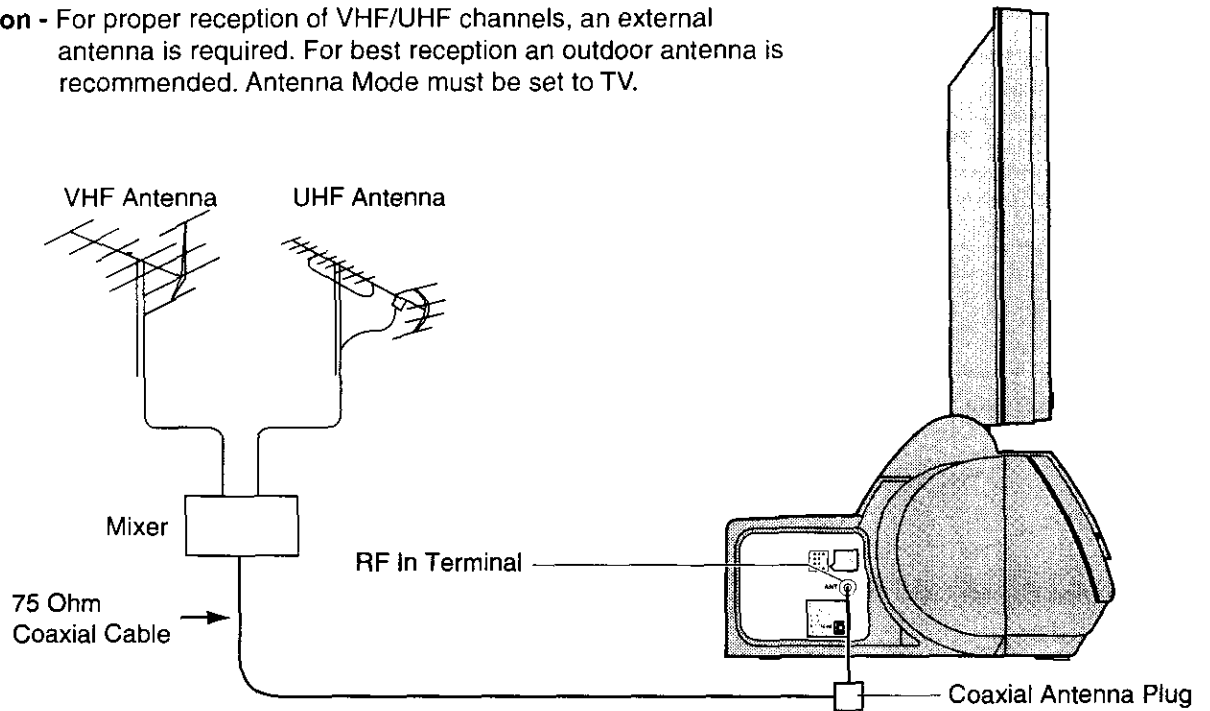

Antenna / Cable Connection

Incoming Cable From Home Antenna (75 Ohm)

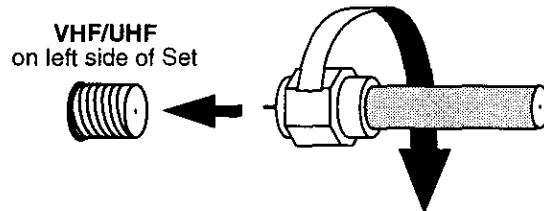

Incoming 75 Ohm Cable (From Cable Company)

Cable Connection - For reception of cable channels (01 - 125) connect the cable supplied by your local cable company. Antenna Mode must be set to CABLE. (Refer to Antenna Mode section.)

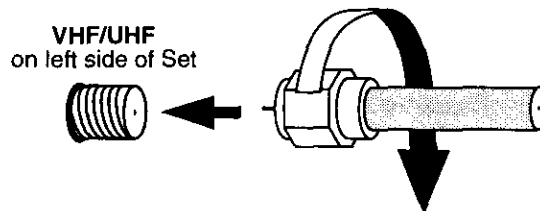

Note:

Certain cable systems offset some channels to reduce interference or have Premium (scrambled) channels. A cable converter box is required for proper reception. Check with your local Cable company for its compatibility requirements.

Antenna Connection (Cable Box, no VCR)

Use this configuration when connecting the TV to a cable TV system using a Cable Box.

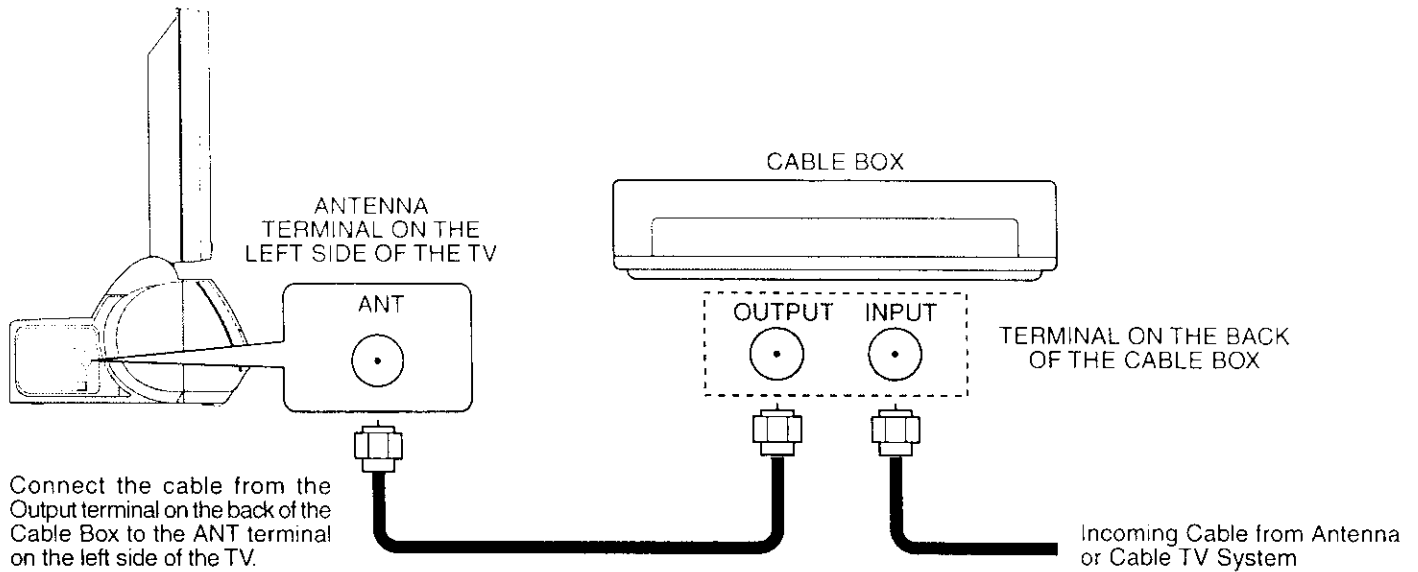

Antenna Connection (Cable Box, and VCR)

Use this configuration when connecting the TV to a cable TV system using a Cable Box and VCR.

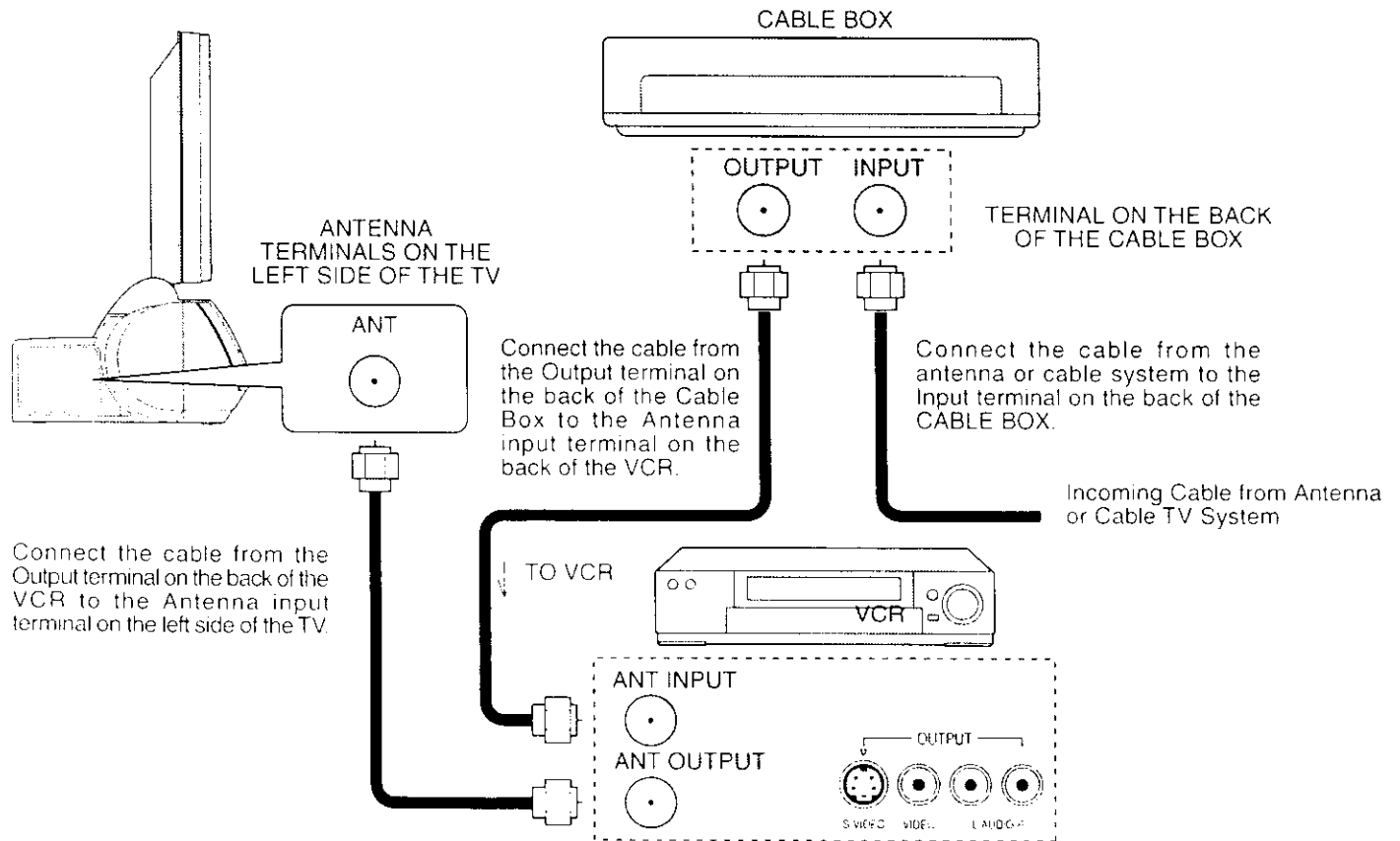

Note: When the antenna cable is connected to the TV antenna terminal via a cable box or VCR, set the TV channel to CH3 or CH4, cable. This does not apply when signal is input from VIDEO INPUT.

Installation

How to connect the input terminals

Connects VCRs and other peripheral equipment

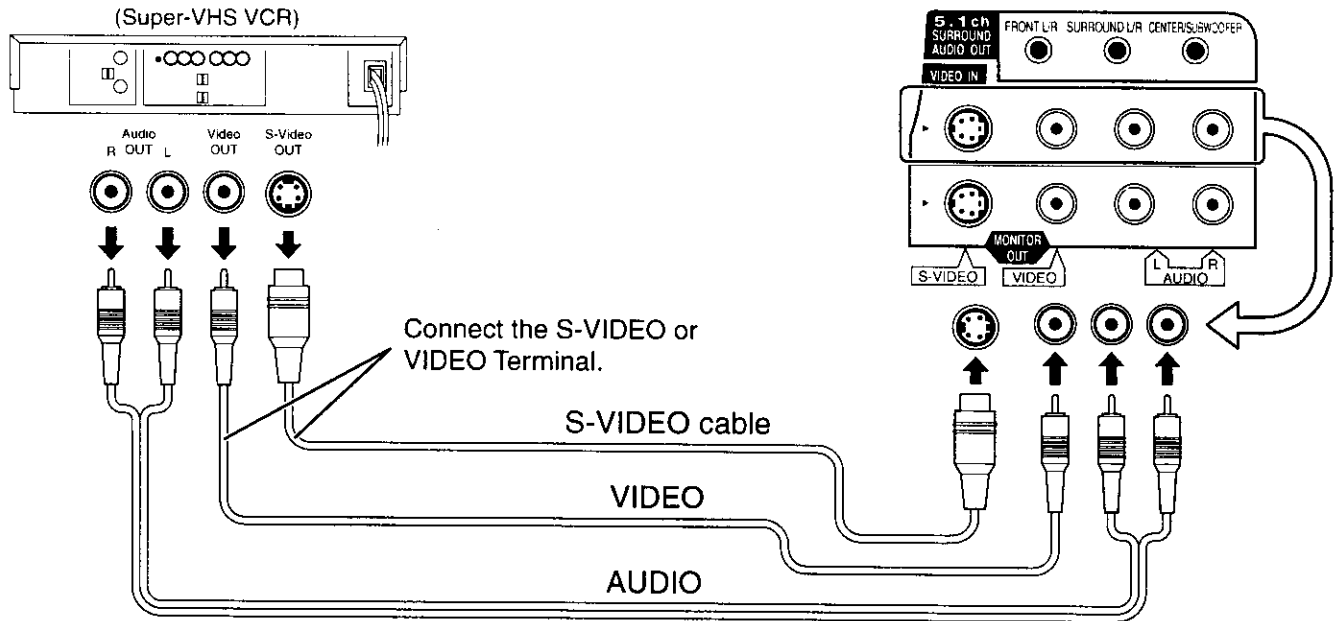

How to connect the AV OUT Terminals

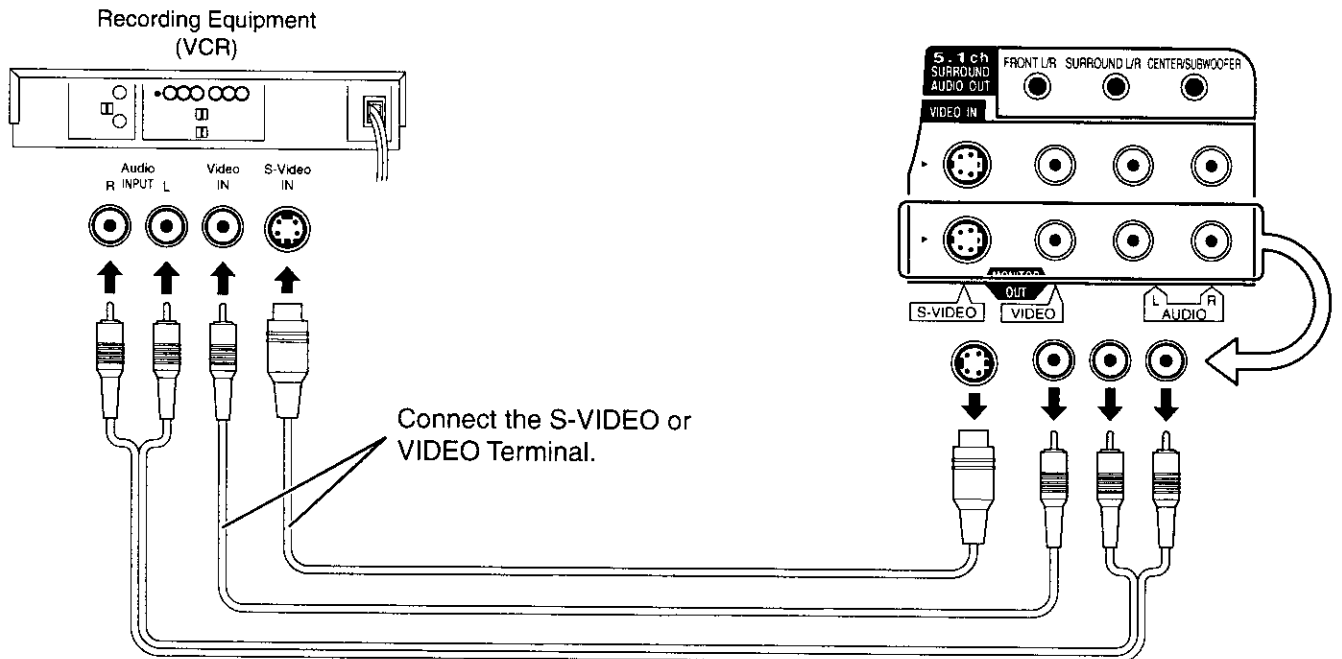

Notes:

- When a monaural VCR is used, connect the monaural audio cable to the AUDIO-L (Left) terminal.
- When connecting video cables, priority is given to the S-Video cable when the S-Video input terminal and the video input terminal are connected at the same time.

How to connect the 5.1ch SURROUND AUDIO OUT Terminals

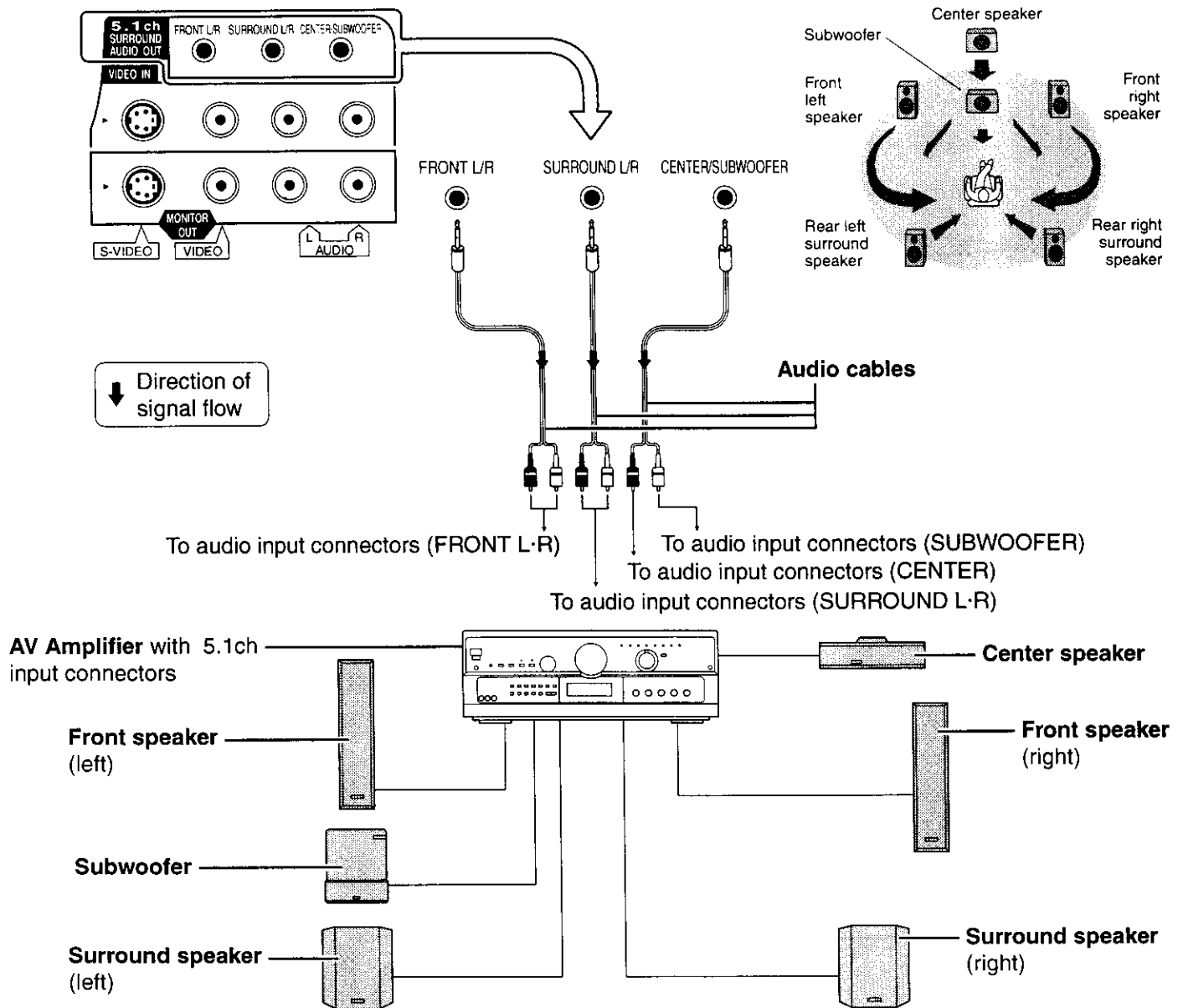

Notes:

- Additional equipment and cables shown are not supplied with this set.
- After connection is made, set the "7 Speaker Setting" (such as Yes/No and Large/Small) according to your speaker system. (Refer to "DVD Operating Guide")
- Turn Virtual Surround Sound (VSS) or Headphone VSS off if you are using more than just the two front speakers (see page 28). Sound will only come from the front speakers if VSS or Headphone VSS is turned on.

For your reference:

- This player can play CDs recorded in dts. When the player is connected to an AV amplifier with 5.1ch AUDIO OUT connectors, you can enjoy multi-channel audio of CDs recorded in dts as well as DVDs.

Installation

Connecting Headphones / Earphones

Connect headphones / earphones as follows.

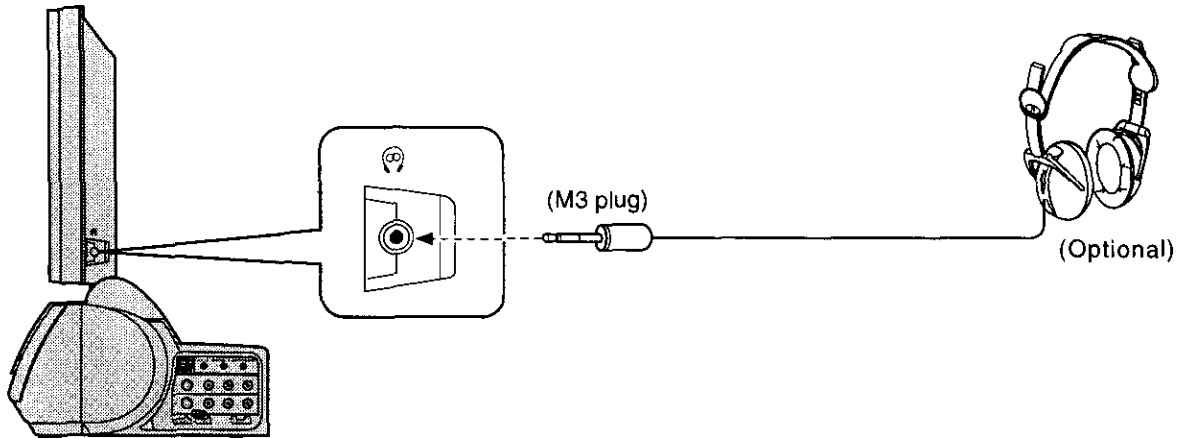

Connecting OPTICAL audio cable

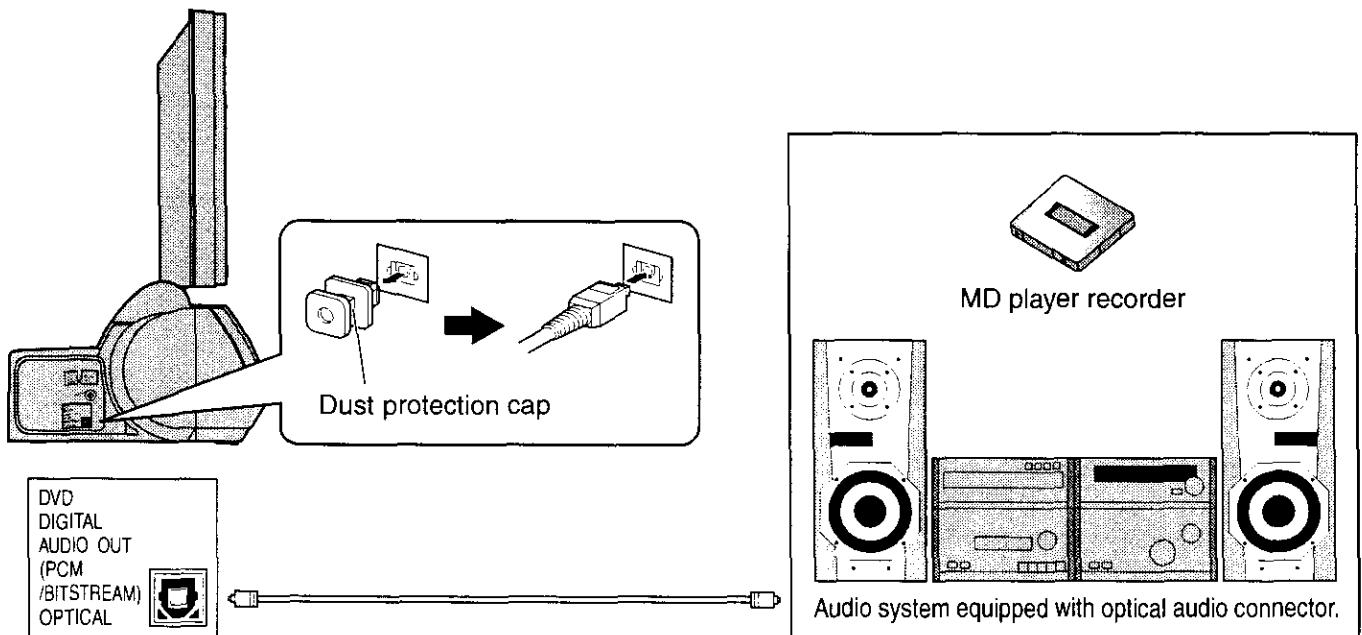

Refer to OPTICAL output for details on DVD Operating Guide.

Note:

When connecting the optical digital audio cable

- Remove the dust protection cap from the digital audio output connector and connect the cable firmly so that the configurations of both the cable and the connector match.
- Keep the dust protection cap and reattach when not using the connector.

Power ON / OFF

How to Turn the Power On

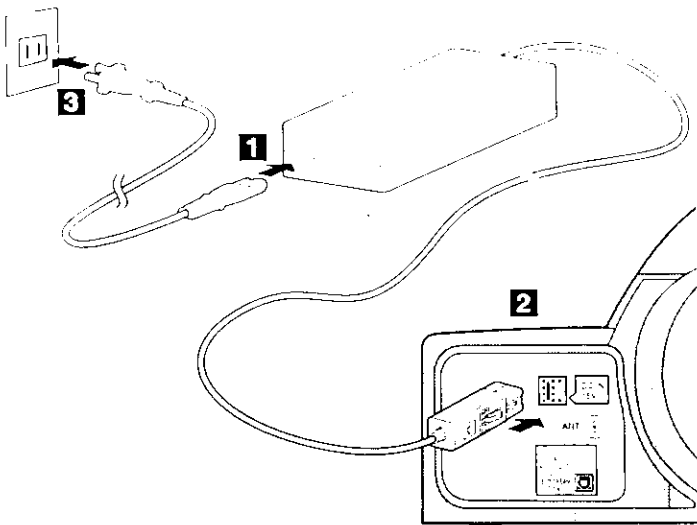

Connecting the Plug to the Wall Outlet
Push the POWER switch on the TV to turn the set on.
POWER-ON: Green

Example: The screen below is displayed for a while after the TV is turned on. (setting condition is an example.)

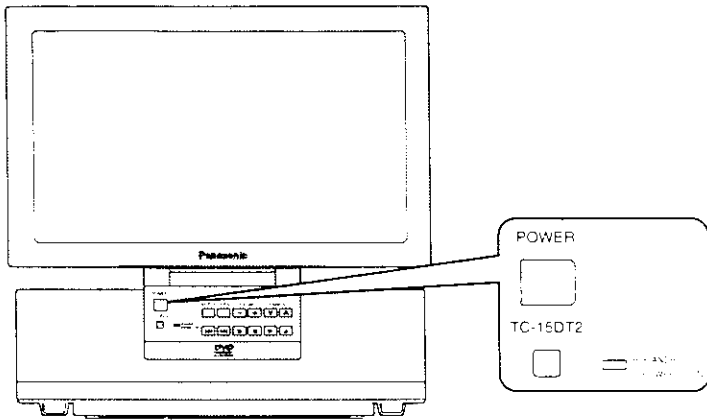
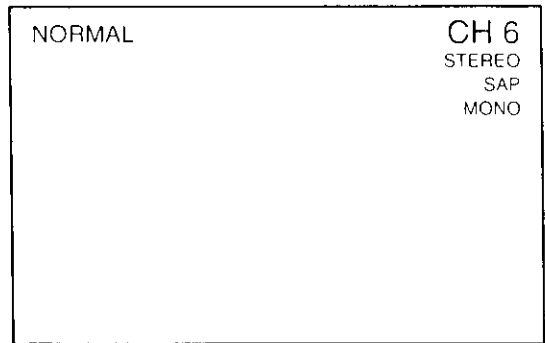

Press the POWER button on the remote control to turn the TV off: Red (standby)

Press the POWER button on the remote control to turn the TV on: Green

Turn the power to the TV set off by pressing the POWER switch on the TV when the TV is on or in standby mode.

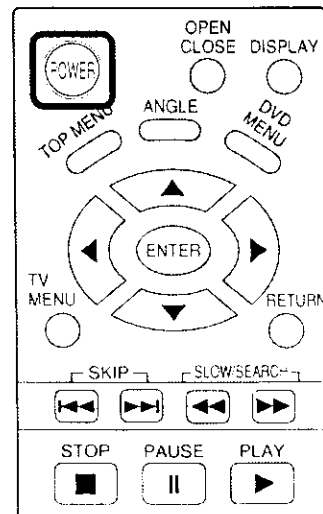
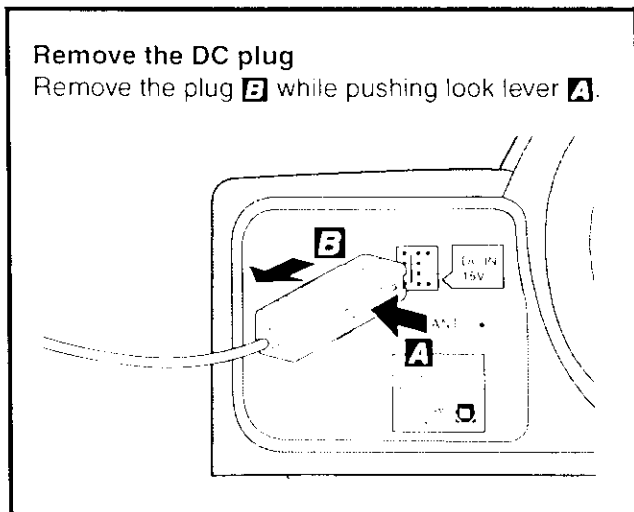

Location of Controls

Controls on the TV

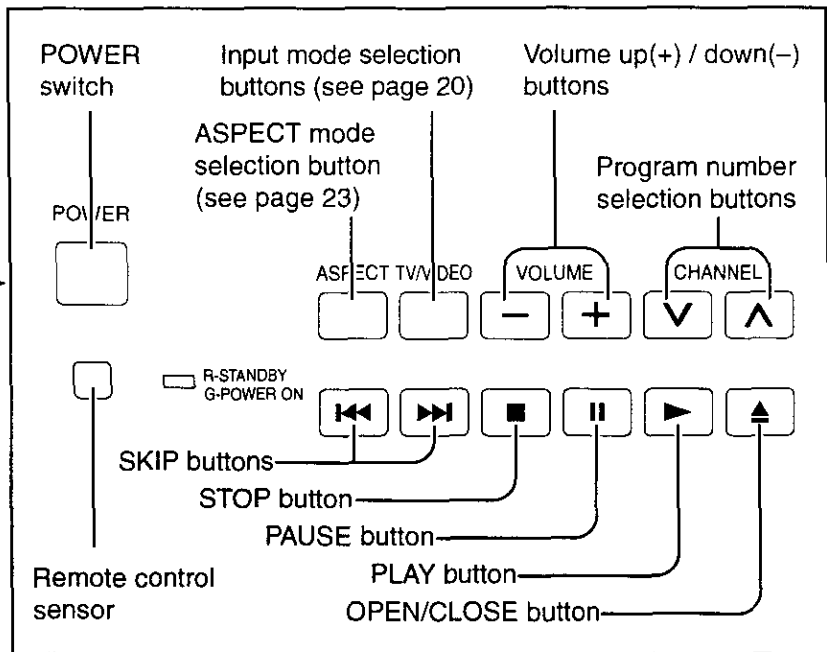
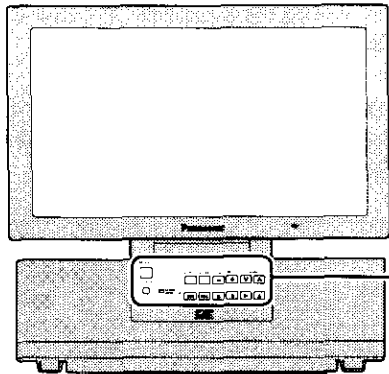

SLEEP timer button

The LCD TV may be preset to switch to stand-by after a fixed period. The setting changes to 30 minutes, 60 minutes, 90 minutes and 0 minutes (off timer cancelled) each time the button is pressed.

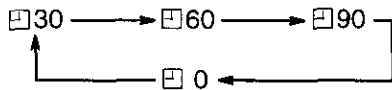

When three minutes remain, "3" will flash. The off timer is cancelled if the main power turn off. Starting three minutes before the power is automatically turned off, the remaining time, 3 → 2 → 1 will blink on the screen.

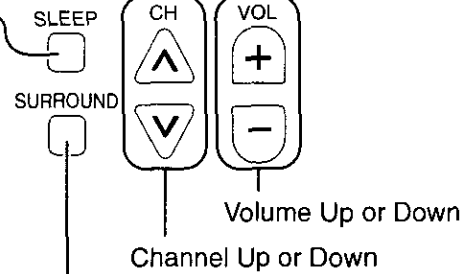

SURROUND button

The benefits of surround are enormous. You can be completely enveloped in sound, just as if you were at a concert hall or cinema. (See page 28)

Valid during DVD mode

REPEAT MODE A-B REPEAT PLAY MODE



PLAY MODE button (See page 42)

A-B REPEAT button (See page 51)

Repeating selections between two specific points.

REPEAT button (See page 50)

Location of Controls

Stand-by (ON/OFF) button

The television receiver must first be plugged into the wall outlet and turn on at the power switch (see page 20).

Use with DVD operation. (Refer to "DVD Operation Guide")

OPEN CLOSE button
Press to open or close DVD tray.

DISPLAY button
Press the DISPLAY button to display the current system status. Refer to "DVD Operation Guide" when using the DVD.

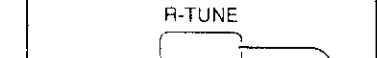
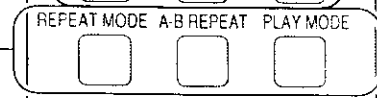
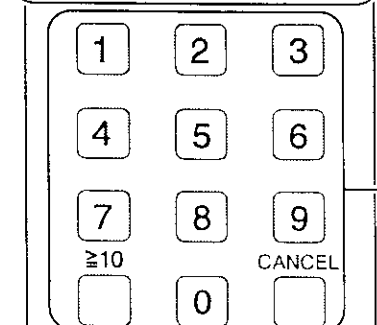
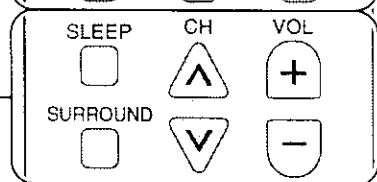
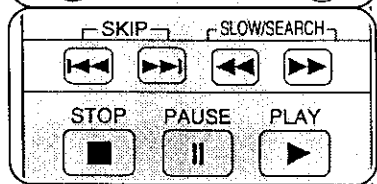
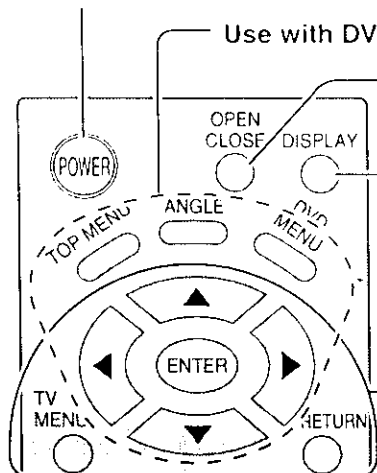

Panasonic
TV/DVD

Moves cursor to the left during menu mode.

Moves cursor upward during menu mode.

Moves cursor to the right during menu mode.

Moves cursor downward during menu mode.

Press the Menu button to display the Menu screen.

Press to return to before menu screen.

To disk operation use. (Refer to "DVD Operation Guide")

MUTE button
Press to mute the sound. Press again to reactivate sound. Sound is also reactivated when power is turned off or volume level is changed.

TV/VIDEO button
This input mode changes each time this button is pressed (see page 20).

ASPECT button
Change of screen size (see page 23).

Direct program number selection buttons

R-TUNE button
Switches to previously view to channel or video mode.

Flow Chart of TV menu

1

If the MENU button is pressed, the MENU screen will be displayed. If the MENU button is pressed once more while the menu screen is displayed, the MENU screen will be cleared.

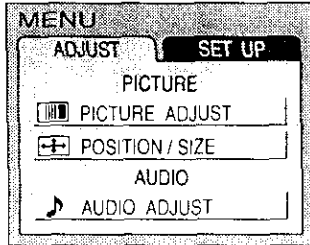
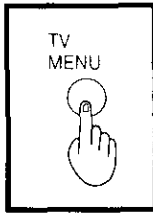

2

Select MENU desired by pushing Right "▶" button or Left "◀" button.

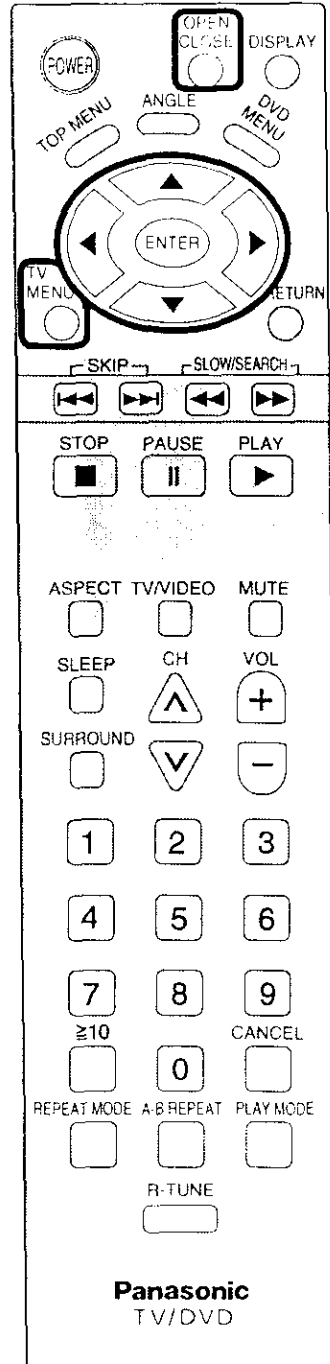
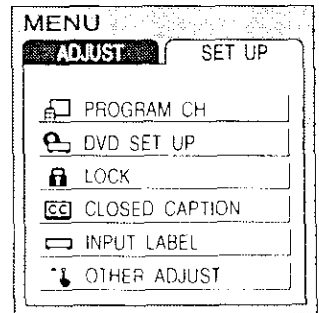
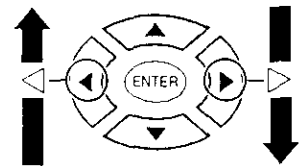
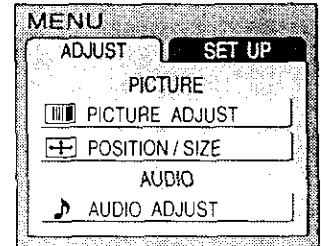
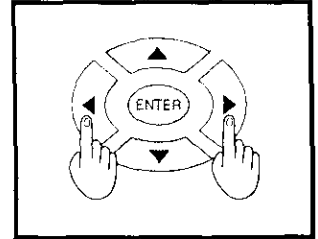

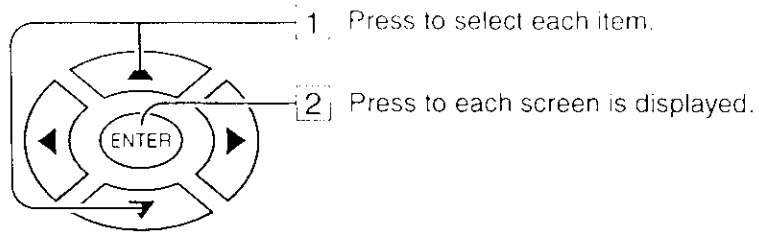

Notes:

- Items displayed in light blue cannot be adjusted.
- Display color changes according to input settings. (Press the TV/VIDEO button to switch inputs.)

TO PICTURE ADJUST menu

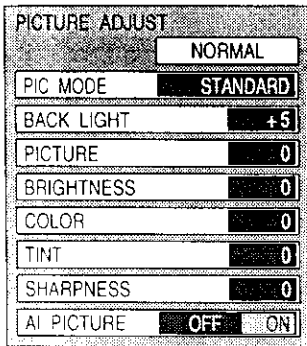

(See page 25)

TO POSITION/SIZE

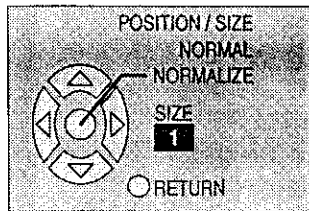

(See page 24)

TO AUDIO ADJUST menu

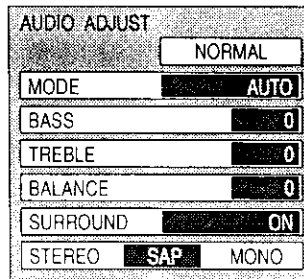

(See page 27)

TO PROGRAM CHANNELS adjust screen

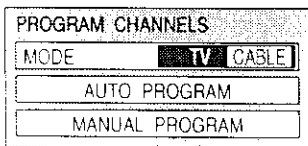

(See page 19)

TO DVD SET UP

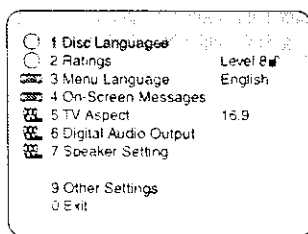

(Refer to "DVD Operation Guide")

TO LOCK selection screen

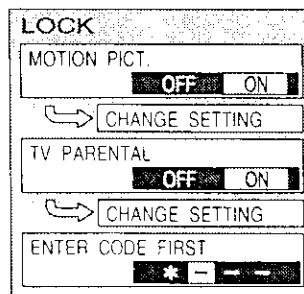

(See page 30)

TO VIDEO INPUT LABEL selection screen

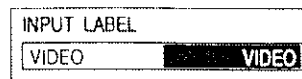

(See page 33)

TO CLOSED CAPTION selection screen

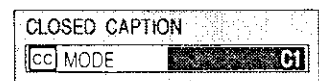

(See page 29)

TO OTHER ADJUST screen

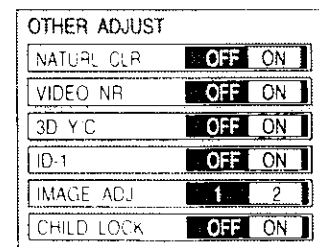

(See page 34-36)

Tuning channels (Automatic channel programming)

Automatically searches and adds receivable channels in the installed area and/or CATV signals to the program.

- 1** Press the TV MENU button to display the MENU screen and select SETUP.

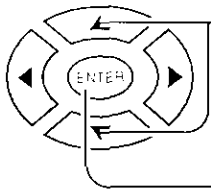

Press to select PROGRAM CH.

Press to display the PROGRAM CH screen.

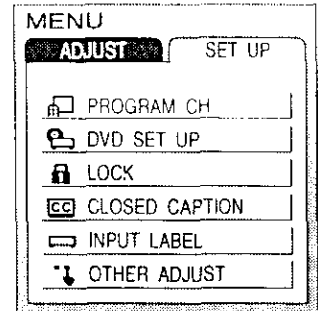

- 2** Press to select MODE.

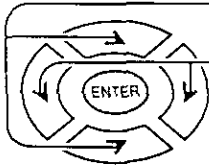

Press to select TV or CABLE.

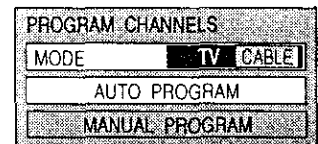

- 3** Press to select AUTO PROGRAM.

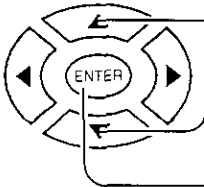

Press to display the confirmation screen.

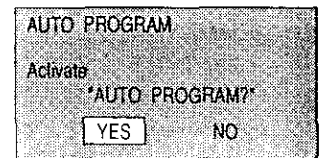

- 4** Press to select YES.

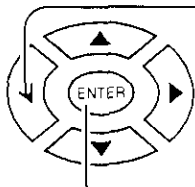

Press to run AUTO PROGRAM

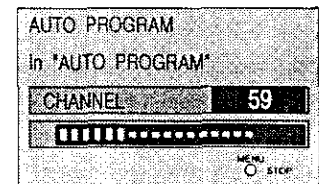

Channels will automatically advance until all channels have been scanned. Channel numbers with a video signal present will turn light blue. Which indicates it has been stored in the Channel Scan Memory.

- 5** Press the TV MENU button to exit the set up menu.

Notes:

- When buttons are pressed with AUTO PROGRAM running, the TV set will return to normal viewing. (Channel searched up to this point are added.)
- After AUTO PROGRAM is finished, the lowest channel number added will be received.
- When there are no receivable channels, channel 69 is displayed (channel 125 for cable TV).

Tuning channels (Manual channel programming)

Use this setting when changing setting of receiving channels or changing the channel display.

Turn the TV on and select the broadcast channel. Follow the steps on the previous page to display the PROGRAM CHANNEL screen.

Selecting the PROGRAM CHANNELS menu.

- 1** Press the TV MENU button to display the MENU screen and select SETUP.

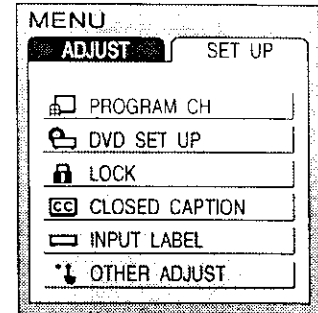
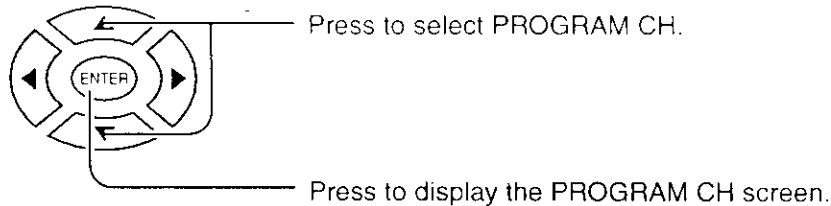

- 2** Press to select MODE.

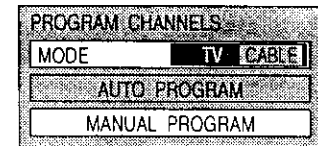
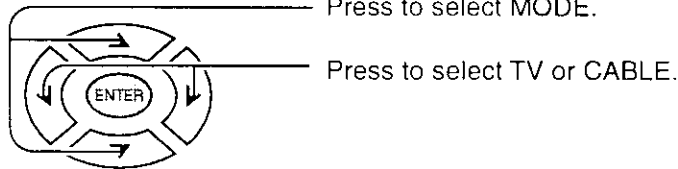

- 3** Press to select MANUAL PROGRAM.

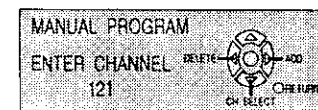
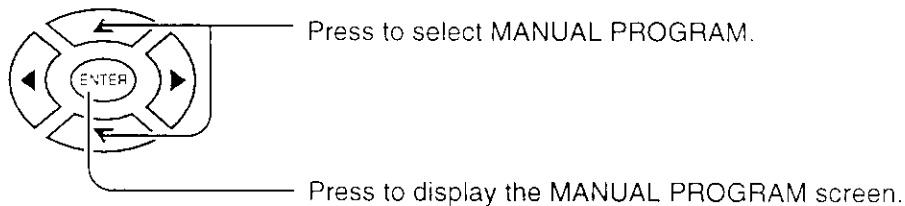

Adding or deleting channels

- 4** Press to select channel (or number keys).

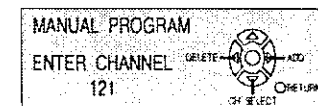
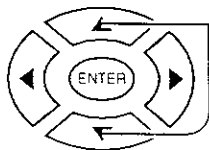

- 5** Press to add channels to memory (blue).

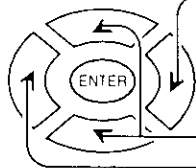

- Press to select channel.
- Press to delete channels from memory (yellow).

- 6** Repeat steps 4 and 5 to continue adding or deleting channels.

- 7** Press the TV MENU button to exit the set up menu.

Playing a VCR or other peripheral equipment

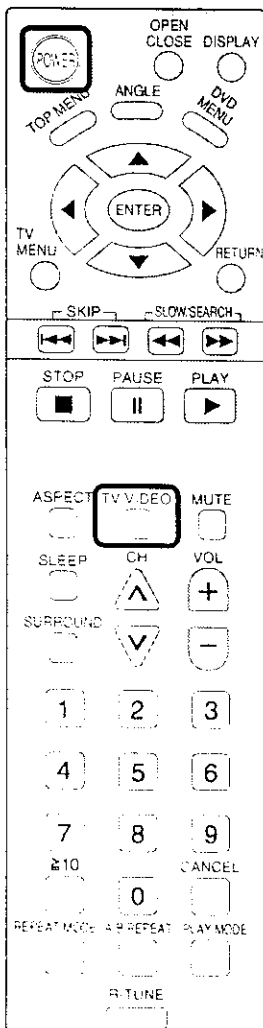
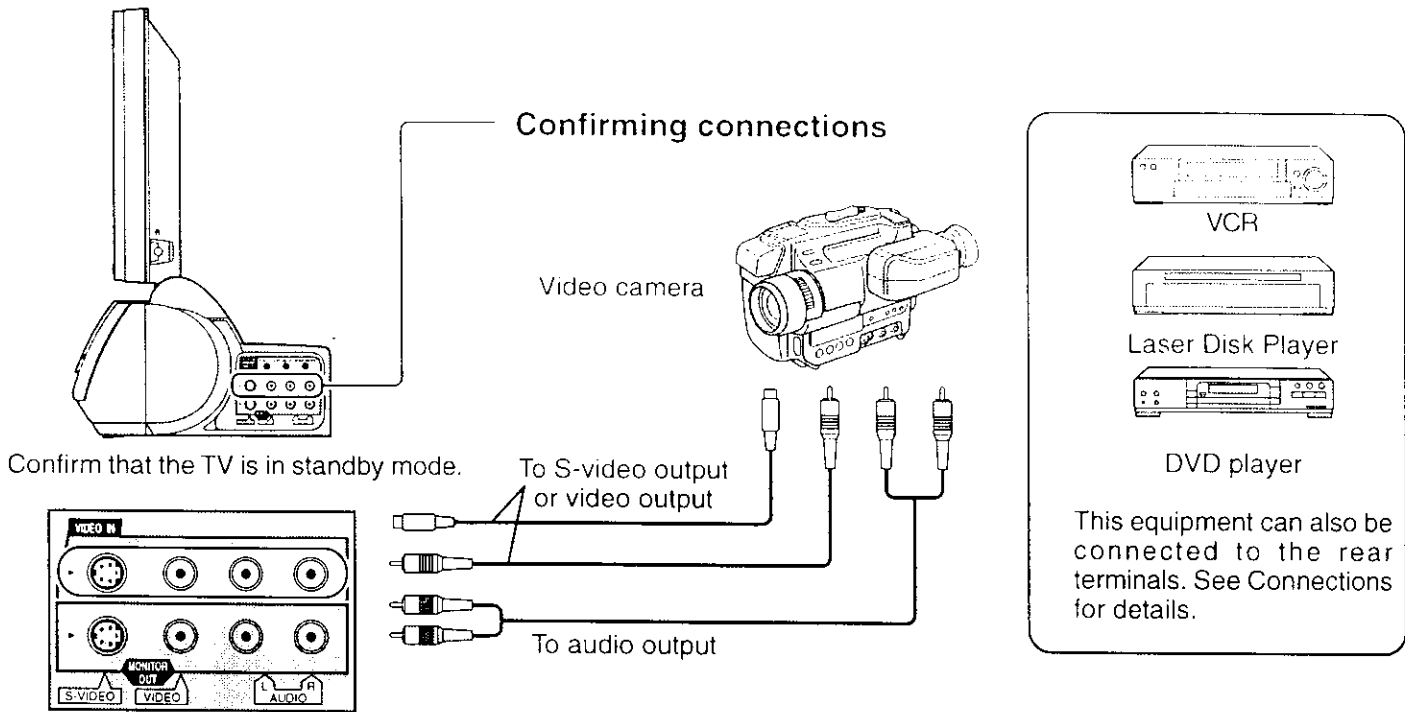

Turning the power on and switching input modes

1  Turn the TV on.

2  The input mode changes each time this button is pressed.

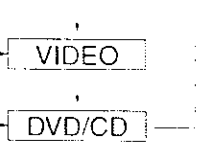
- When playing a video → VIDEO
 - When playing a DVD → DVD/CD
- 

Note:
When the remote control is unavailable, input modes can also be switched on the TV set using the TV/VIDEO button.

3 Operate the connected equipment.

Setting condition to be displayed

DISPLAY (On-screen display)

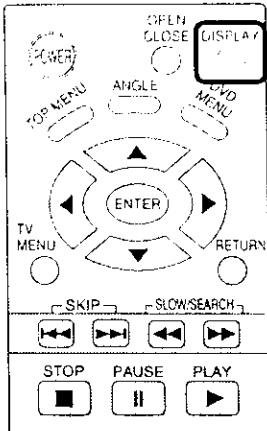

DISPLAY



Press this button to display channel number, off-timer remaining time, screen modes, and other settings. Display fades away into after about 3 seconds. Press this button again to delete channel number display.

Full Information

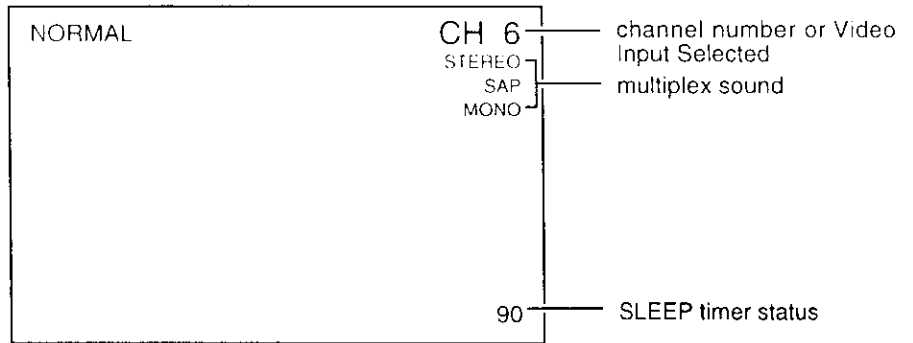

The GUI menu bar for DVD operation is displayed by pressing the DISPLAY button when the above screen is displayed.

DISPLAY



↓ Press to GUI screen



DISPLAY



DISPLAY



DISPLAY



The GUI screen changes everytime the DISPLAY button is pressed. (Refer to "DVD Operation Guide")

Stoppage of the Tray action (Child lock)

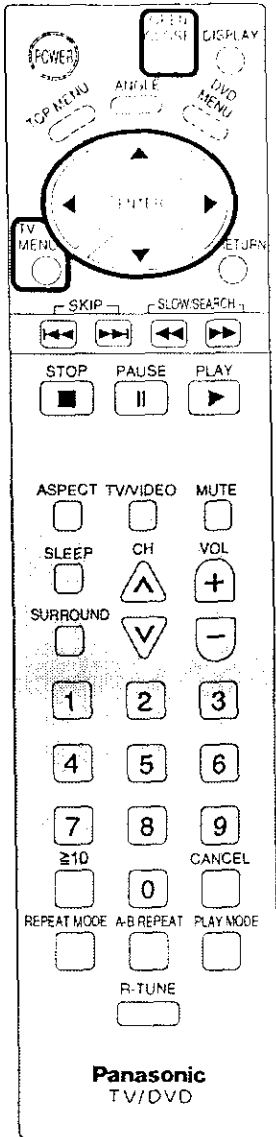

The DVD tray on the front can be locked to prevent young children slamming their fingers and to prevent debris from entering.

1 Press the TV MENU button to display the MENU screen and select SETUP.

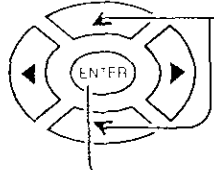
2  Press to select OTHER ADJUST.
Press to display the OTHER ADJUST screen.

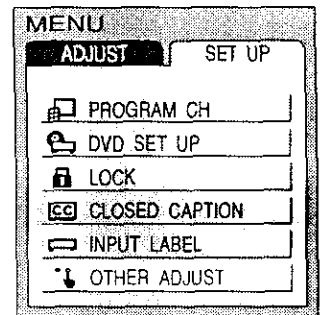

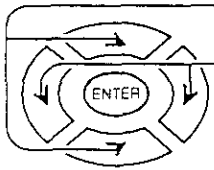
3  Press to select CHILD LOCK.
Press to set.

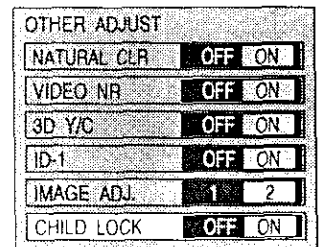

TV MENU



To end adjustment.

When the open close button is pressed when CHILD LOCK is ON, the below message is displayed and the tray will not open.

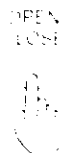

CHILD LOCK ON

Note:

The settings are memorized even after power is turned OFF.

ASPECT Controls

The LCD TV will allow you to enjoy viewing the picture at its maximum size, including wide screen cinema format picture.

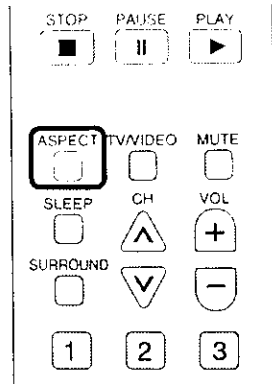

ASPECT button

The aspect mode changes each time the ASPECT button is pressed.

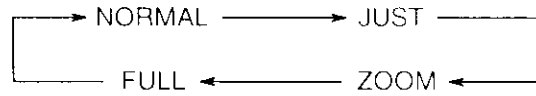

Mode	Picture	Explanation
NORMAL		NORMAL will display a 4:3 picture at its standard 4:3 size.
JUST		JUST mode will display a 4:3 picture at maximum size but with aspect correction applied to the center of the screen so that elongation is only apparent at the left and right edges of the screen. The size of the picture will depend on the original signal.
ZOOM		ZOOM mode magnifies the central section of the picture.
FULL		FULL will display the picture at its maximum size but with sight elongation.

Notes:

- When S1 is detected during S terminal connection, the screen size will change to FULL.
- When ID-1 signal on the broadcast wave is detected with ID-1 turned ON, the screen size changes to FULL or ZOOM.

Adjusting screen position and size

Adjusting screen

1



Press to select the screen mode to adjust.

2



Press to display the MENU screen.

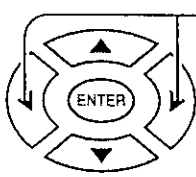
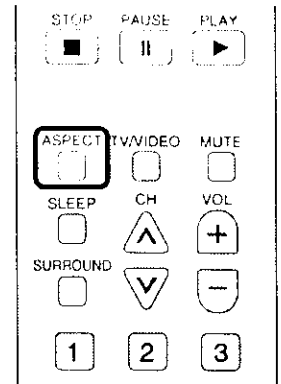

Press to select ADJUST menu.

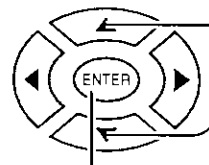
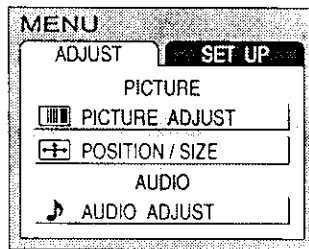

Press to select POSITION/SIZE.

press ACTION.

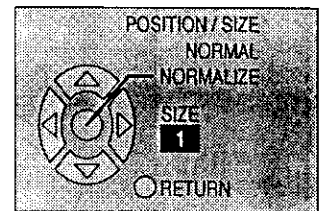

Switching screen width

During NORMAL mode, if noise appears on the ends of the image in SIZE 1, switch to SIZE 2.

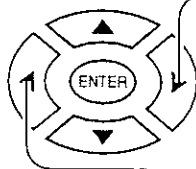

Press to narrow (SIZE 2).

Press to widen (SIZE 1).

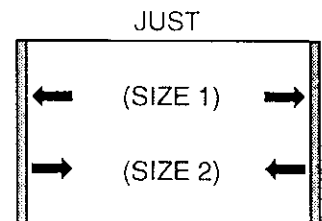
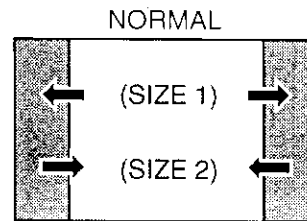

Moving Display images cut off from the screen

For ZOOM mode.

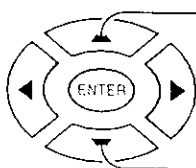

Press to move image upwards.

Press to move image downwards.

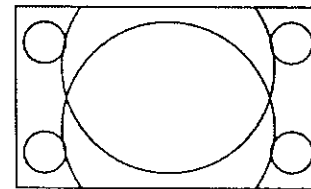

- To return to standard • ENTER
- To end adjustments • MENU (RETURN)

Notes:

- This TV is equipped with various screen modes. If a screen mode with a different aspect from the broadcast program is selected, image will appear differently. Select the proper screen mode with this in mind.
- Be careful when using this TV for commercial purposes or for public use, such as in cafes and hotels, for shrinking and enlarging images by using screen mode switching function (zoom, etc.) may violate copyright laws.
- Images displayed on a wide screen TV will be cut off or distorted at the edges, when viewing normal aspect images of 4:3 in ZOOM, JUST or FULL mode. Display in NORMAL mode to view the original image intended by the producer.
- The adjusted setting will be kept even when the TV is turned off.
- The signals output from the monitor output terminal on the right of the TV are not affected when the screen size and position are adjusted.

Picture Adjustments

- 1 Press the TV MENU button to display the MENU screen and select ADJUST.

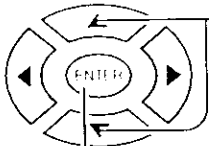

Press to select to PICTURE ADJUST.

Press to display the PICTURE ADJUST screen.

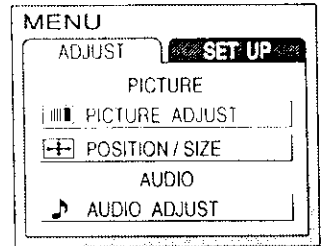

2

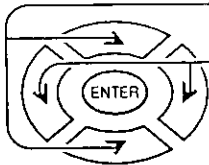

Press to select the menu to adjust.

Select the desired level by looking at the picture behind the menu.

NORMAL is displayed at default.

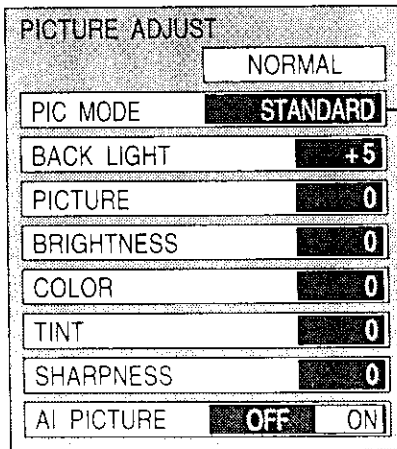
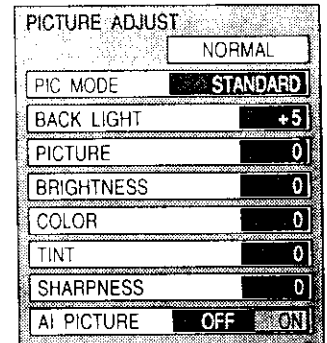

See next page

Press the left ◀ or right ▶ button to switch between modes.

— STANDARD — CINEMA — DYNAMIC —

STANDARD

STANDARD

Displays unaltered image.



CINEMA

CINEMA

Ideal for movies.



DYNAMIC

DYNAMIC

Displays a clear screen with contrast of light and dark.

Picture Adjustments

BACKLIGHT

Illuminance of the back light is adjusted.

PICTURE

Selects proper brightness and density for the room.

BRIGHTNESS

Adjusts for easier viewing of dark pictures such as night scenes and hair.

COLOR

Adjusts slightly to a lighter color.

TINT

Adjust for nice skin color.

SHARPNESS

Displays a sharp image.

AI PICTURE

Displays black and white colors clearer when turned ON.

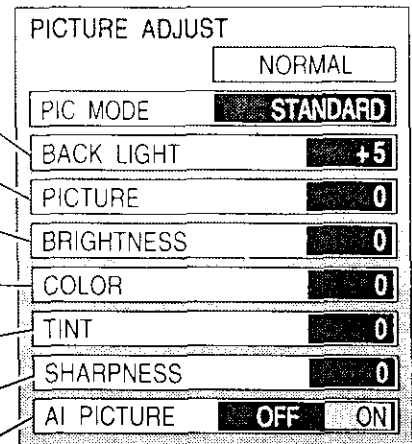

- To adjust each item, →

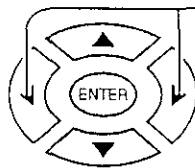

Press the up ▲ and down ▼ button and make adjustments using the left ◀ and ▶ right buttons.

- To reset to standard setting, →

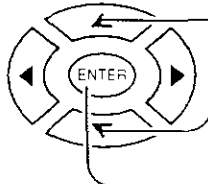

Select NORMALIZE with the up ▲ and down ▼ buttons.

Press ACTION.

- To return to normal viewing --



Press TV MENU button.

Note:

There is little change when PICTURE is increased with a bright picture or reduced with a dark picture.

Audio Adjustments

1 Press the TV MENU button to display the MENU screen and select ADJUST.

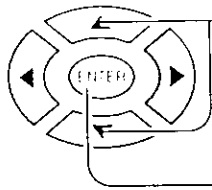

Press to select to AUDIO ADJUST.

Press to display the AUDIO ADJUST screen.

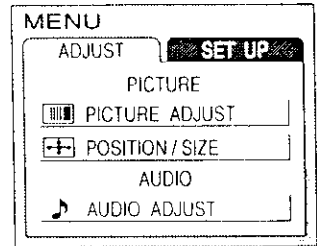

2 Press to select the menu to adjust each item.

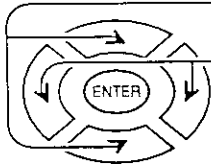

Select the desired level by listening to the sound.

BASS
Adjusts low sounds

TREBLE
Adjusts high sounds

BALANCE
Adjust left and right volumes

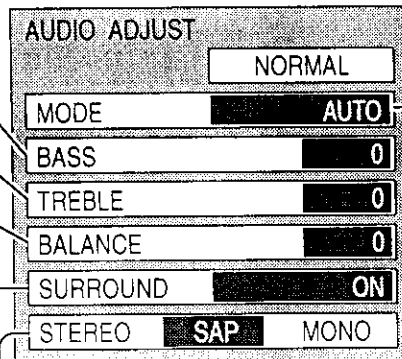

Selecting STEREO/
SAP/MONO.
(See next page)

SURROUND

To enjoy a concert hall effect, turn SURROUND to ON. During stereo sound or soft playing:

Note:

When VSS* is enabled during DVD mode, selections will rotate as follows:

→ OFF → VSS1 → VSS2

AUTO

Auto

Automatically adjusts quiet sound and loud sound for ease of listening.

STANDARD

STANDARD

Emits the original sound.

DYNAMIC

DYNAMIC

Gives contrast to sound.

MUSIC 1

MUSIC 1

For programs consisting mainly of music. Enhances high sounds (around 4 kHz).

MUSIC 2

MUSIC 2

Enhances high sounds even more. (Recommended for those who have slight hearing deficiencies.)

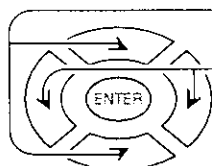

To reset to standard setting,

select NORMALIZE with the up ▲ and down ▼ buttons and press ENTER.

To adjust settings individually, press the AV up ▲ and down ▼ button to select the desired menu and adjust using the left ◀ and ▶ right buttons.

● To end adjustments

TV MENU



Press TV MENU button.

Note:

* Virtual Surround Sound (VSS) (See page 11, 28)

Selecting STEREO/SAP/MONO

Press the TV MENU button to display the MENU screen and select AUDIO ADJUST screen.

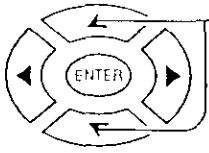

Press to select STEREO/SAP/MONO.

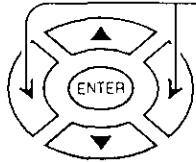

Press to select STEREO/SAP/MONO.

Red display : With signal
White display : No signal
 : MONO



TV MENU



Press to end.

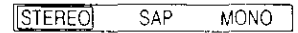
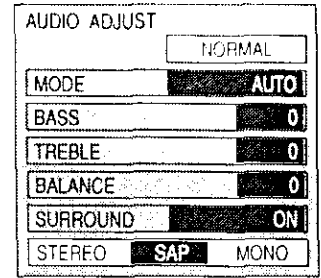

Helpful Hints:

- **STEREO** - Two channel Audio reception.
- **SAP** - Second Audio Programming (typically used for bilingual audio).
- **MONO** - Use when stereo signal is weak.

SURROUND Control

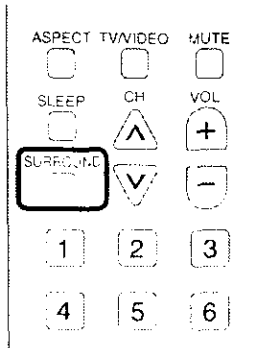

SURROUND



SURROUND Button

The benefits of surround are enormous. You can be completely enveloped in sound, just as if you were at a concert hall or cinema.

The surround setting switches on and off each time the SURROUND button is pressed.

TV/VIDEO mode :

SURROUND OFF



SURROUND ON

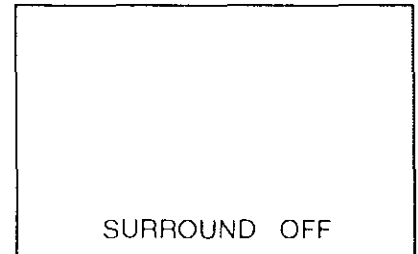

Notes:

- The surround settings are memorized separately for each SOUND mode (AUTO, STANDARD).
- Even from the MENU screen the surround setting is possible.

Closed Captions

This unit has a built in decoder that provides a visual depiction of the audio portion of a television program in the form of written words across the screen (white or colored letters on a black background). It allows the viewer to read the dialogue of a television program or other information.

1 Press the TV MENU button to display the MENU screen and select SETUP.

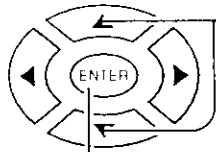

Press to select CLOSED CAPTION.

Press to display the CLOSED CAPTION screen.

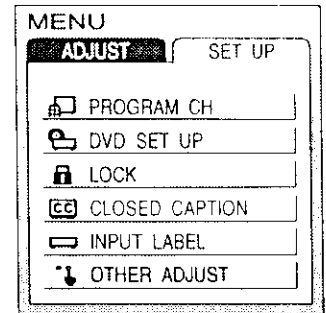

2 **CC** Mode

Activates the On-Screen Closed Caption feature. When activated this feature will remain on until OFF is selected in this menu.

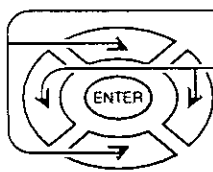

Press to select CC MODE.

Press to select from the following:

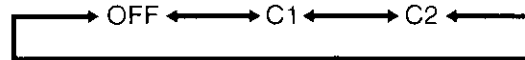

- **CAPTION OFF** - Recommended mode when Closed Caption is not being used.
- **CAPTION C1** - For video related information that can be displayed (up to 4 lines of script strategically placed on the television screen so that it does not obstruct relevant parts of the picture).
- **CAPTION C2** - Another mode used for video related information.

- To end adjustments →



Press TV MENU button.

Surround effects can be turned ON and OFF during TV/VIDEO mode but also switches as follows when DVDs with VSS signals are played:

DVD mode :

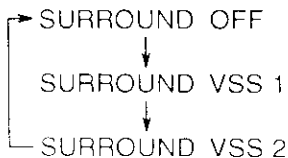

When DVDs with VSS signals are played and Headphone VSS is selected for VSS of the GUI screen (see page 49), SURROUND display switches as follows:

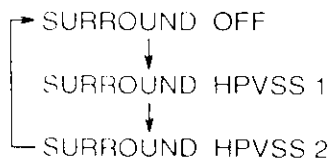

Note:
See pages 46 to 49 for details on GUI.

Lock Feature

In the United States, the V-CHIP consists of two rating systems, which are MPAA (MOTION PICTURE) and TV PARENTAL GUIDELINES. Its function is to block programs by the rating data in the XDS data packets sent from broadcasting stations. The user can select which rating programs should be blocked by the LOCK MENU options.

Note: The V-CHIP used in this unit model, is capable of selecting the U.S. ratings that are indicated in this manual.

Press the TV MENU button to display the MENU screen and select SETUP.

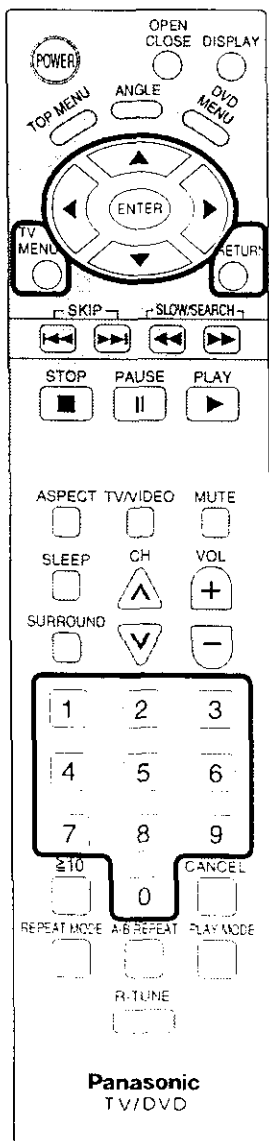

1

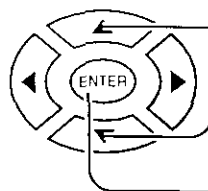

Press to select LOCK.

Press to display the LOCK screen.

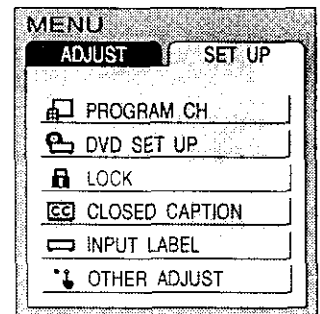

Input code

Enter any 4-digit number as a password. These numbers will be needed when deactivating the LOCK function.

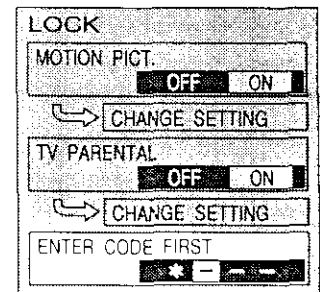

Note:

Use a code that is easy to remember or record it in a safe place.

2 Selecting broadcasts to lock.

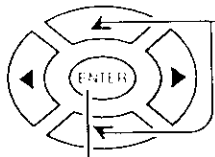

Press to select CHANGE SETTING (the menu following MOTION PICT. STATUS).

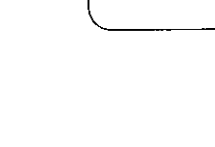

Press to display the MOTION PICTURE RATING screen.

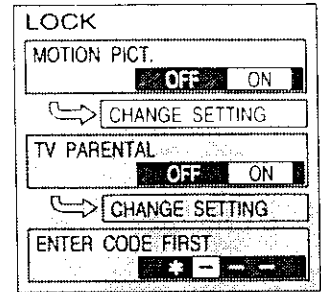

3

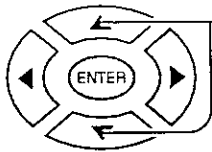

Press to select rating to lock.

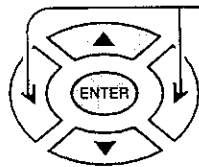

Press to select YES or NO.

Rating (turns red when on)

- G : General audience
- PG : Parental guidance suggested
- PG-13: Parental guidance needed under 13 years old
- R : Restricted
- NC17 : No one under 17 is admitted
- X : Pornography



RETURN



Press to return to LOCK screen.

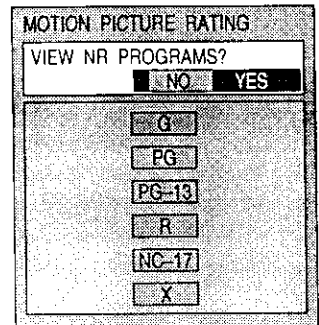

4 Setting MOTION PICT..

Locking and unlocking the ratings selected above.

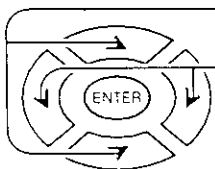

Press to select MOTION PICT..

Press to select ON or OFF.

ON : The broadcasts selected in the MOTION PICTURE RATING menu cannot be viewing.

OFF: LOCK is deactivated and any broadcast, regardless of the setting for MOTION PICTURE RATING, can be viewing.

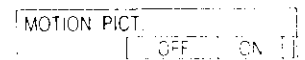
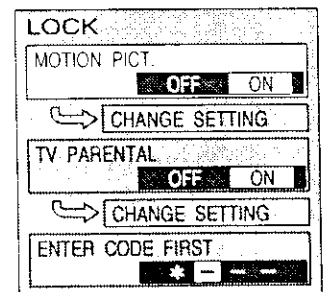

TV MENU



Press to set.

Lock Feature

TV PARENTAL GUIDE

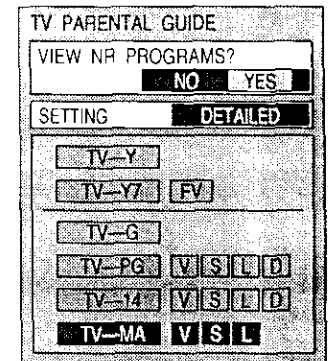
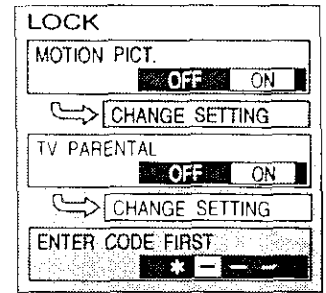
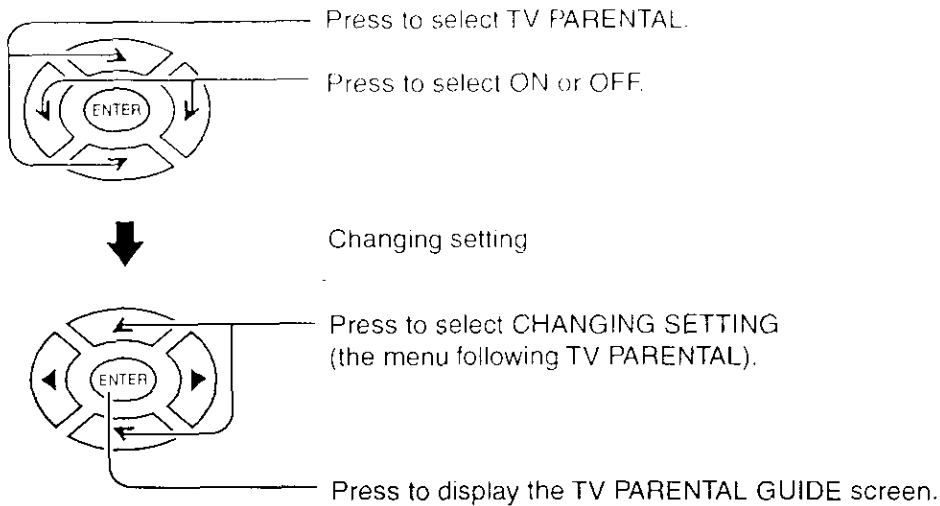

Setting the TV PARENTAL PROGRAMS screen

VIEW NR PROGRAMS?

- NO : Cannot view programs with NR signals.
- YES : Can view programs with NR signal.

SETTING

- BASIC : The up ▲ and down ▼ buttons change the selected title.
- DETAILED : The cursor selecting the title can be moved to select options displayed on the right. The down ▼ buttons moves the cursor to the right if options are available. The up ▲ buttons moves the cursor to the left and if there are no options to the left, the cursor will move up.

Locking and unlocking

- When a title field is selected, all ratings below this rating are selected.
- When options within an option field are selected, ratings below this rating within the same field are selected.
- Ratings displayed in green are unlocked and those displayed in red are blocked programs.

1. Ratings for children: These ratings are divided into ranks as follows.



2. Ratings for teenagers: These ratings are the same as the matrix system. This system is described in the below diagram. Ratings for all ages are on top and ratings for adults are on the bottom.

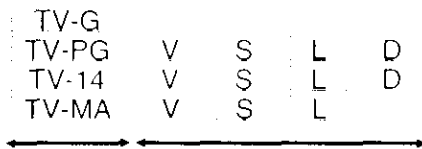

- To end adjustments

TV MENU

Press TV MENU button.



Customizing the VIDEO INPUT labels

Display for each VIDEO INPUT can be changed to match with the connected device (VCR, DVD Player).

Example: When changing VIDEO to LD.

- 1 Press the TV MENU button to display the MENU screen and select SETUP.

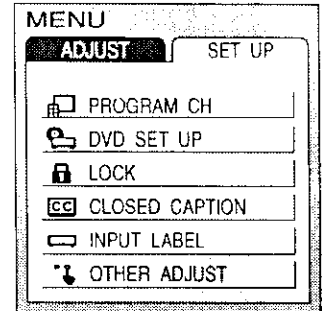
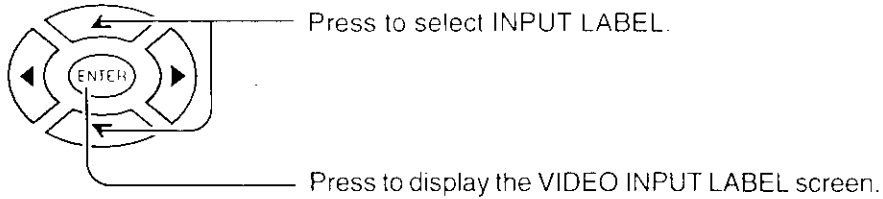

- 2 Press to change.

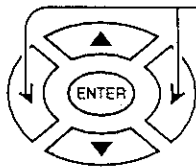

By pressing this button, display changes as follows:

```
graph LR; VIDEO --> VCR; VCR --> LD; LD --> GAME; GAME --> DVD; DVD --> DTV; DTV --> BLANK; BLANK --> VIDEO;
```

This button rotates in reverse.

TV MENU



Press to end.

Note:

When DVD or DTV is selected for the change, images are adjusted to match each input signal.

Adjusting unnatural video images (3D Y/C FILTER)

Selecting the VIDEO menu

Press the TV MENU button to display the MENU screen and select SETUP.

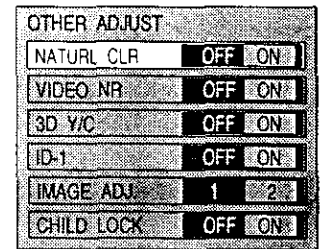
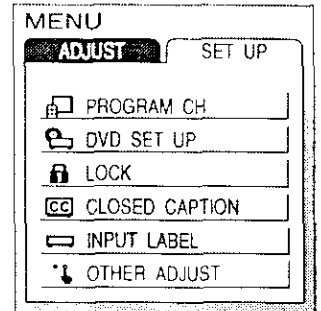
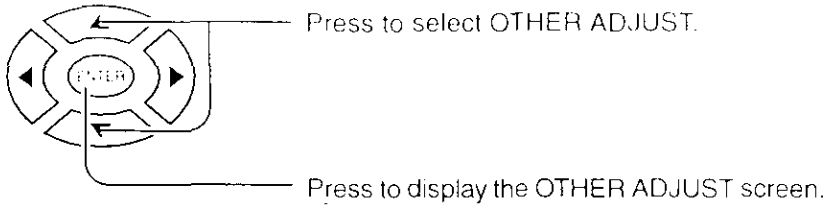

Switching to 3D Y/C FILTER

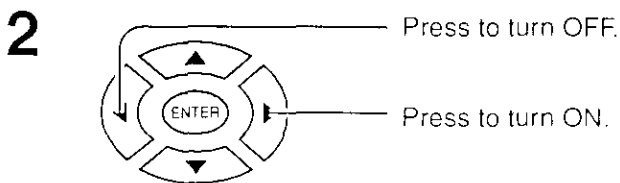
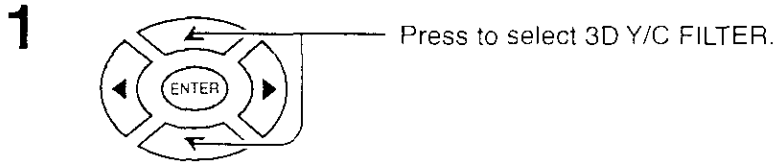

TV
MENU



Press to end.

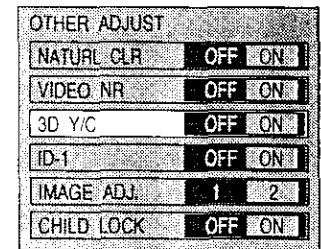

Automatically changing screen size for VIDEO INPUT modes

If the received signal contains screen size specifications in VIDEO INPUT the screen size is automatically changed.

1 Press the MENU button to display the MENU screen and select SETUP.

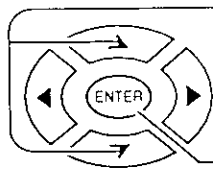

Press to select OTHER ADJUST.

Press to display the OTHER ADJUST screen.

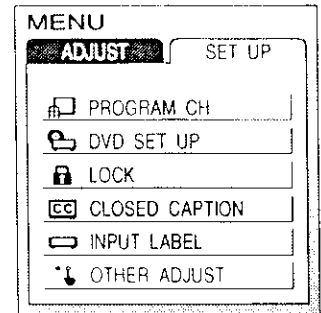

2 Press to select ID-1 (Image Detection).

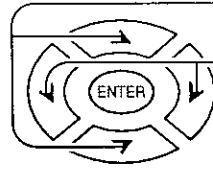

Press to set.

ON : When screen size specification signals are detected, screen size is automatically changed.

OFF : The screen size is not automatically changed. (Turn OFF if this function does not operate properly.)

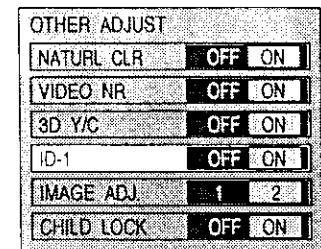

Press to end.

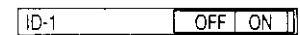

Note:

When ID-1 is detected and screen size is changed, FULL will be display.

When the top and bottom of the screen noise (IMAGE ADJ.)

1 Press the MENU button to display the MENU screen and select SETUP.

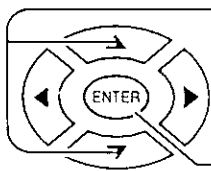

Press to select OTHER ADJUST.

Press to display the OTHER ADJUST screen.

2 Press to select IMAGE ADJ.

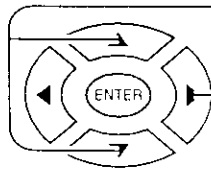

Press to select 2

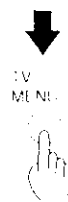
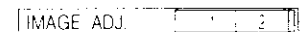
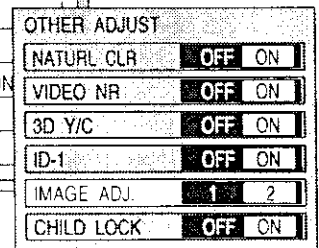
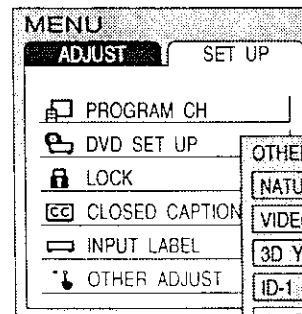

Press to exit menu.

(Example) 1

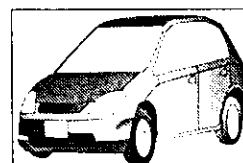

(Example) 2

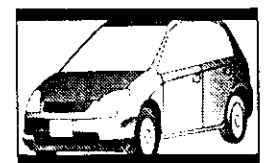

Notes:

- IMAGE ADJ. settings are stored for TV, VIDEO and DVD each.
- This setting will not change during ZOOM.

Natural Color

1 Press the MENU button to display the MENU screen and select SETUP.

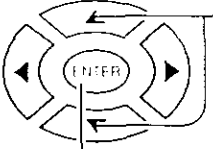
2  Press to select OTHER ADJUST.

Press to display the OTHER ADJUST screen.

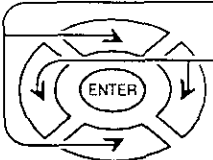
3  Press to select NATURL CLR.

Press to turn NATURL CLR ON.

TV MENU



Press to end.

Note:

Not available for COMPONENT VIDEO.

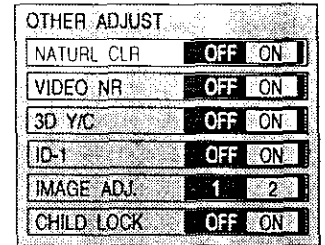
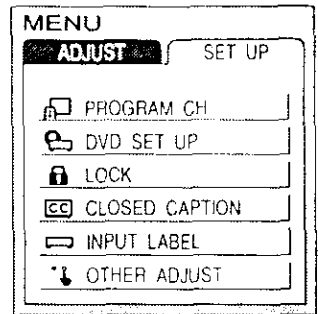

Noisy Picture

Reduces roughness of pictures.

1 Press the TV MENU button to display the MENU screen and select SETUP. Reduces roughness of pictures.

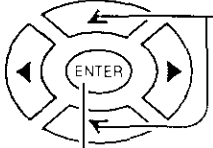
2  Press to select OTHER ADJUST.

Press to display the OTHER ADJUST screen.

3  Press to select VIDEO NR.

Press to set.

TV MENU



Press to exit menu.

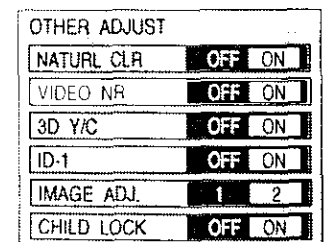
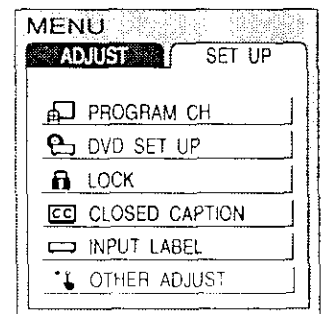

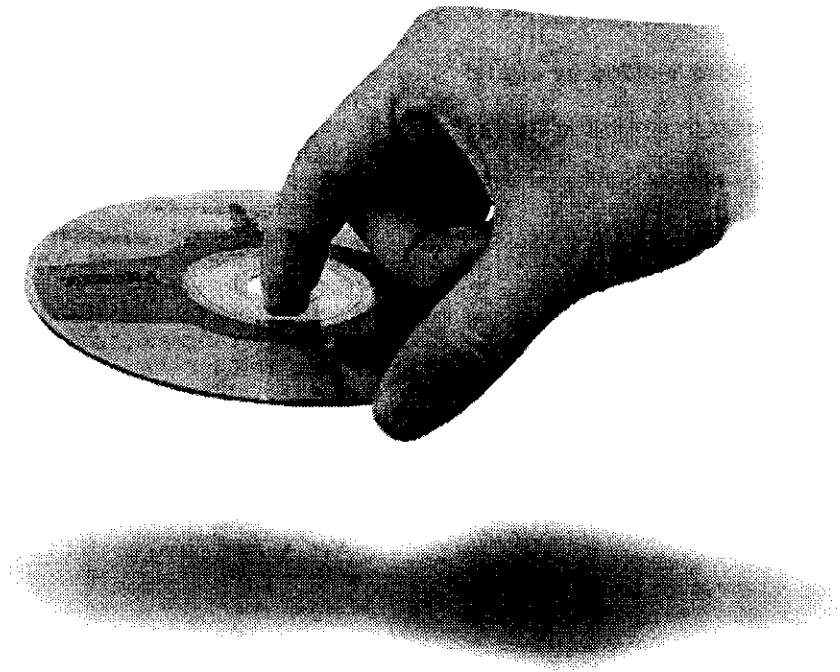

DVD Operation Guide

Features of DVD on this Product

High picture quality

- **10 bit video D/A converter**
Reproduces fine images faithfully.
- **An array of picture quality modes yielded by digital processing**
Signal deterioration is kept to minimum by processing the data digitally.
This feature can be used to tailor picture quality for DVD playback.

High sound quality

- **96 kHz/24 bit audio D/A converter**
This player enables 96 kHz/24-bit linear PCM signals, the highest specifications in DVD standards, to be reproduced faithfully. To support 96 kHz sampling/24 bit sound, the shaping noise of this multilevel digital sigma type D/A converter is kept flat up to 44 kHz, thus preventing the audio signals from being affected in any way. This means sound is reproduced faithfully.
- **Advanced Dolby Digital/dts (digital theater systems) 5.1ch surround decoder (See pages 11 and 62.)**
The advanced Dolby Digital /dts 5.1ch surround decoder incorporated in this player comes with speaker mode settings which support the low-range reproduction capability of the speakers, speaker level settings, delay time adjustment*, audio dynamic range suppression, and other features.
* Delay time adjustment is effective only for Dolby Digital DVDs (center and surround channels).
- **Dolby Digital/dts (digital theater systems) digital output (See page 11.)**
By connecting a Dolby Digital/dts decoder or an amplifier incorporating a Dolby Digital/dts decoder, you can enjoy high quality digital surround sound from Dolby Digital/dts discs.

Advanced Virtual Surround Sound (VSS) function (See page 28-29.)

Even when two front speakers are being used, simply press the VSS (Virtual Surround Sound) button during playback of a Dolby Digital DVD (2 channel or over) to provide a rear surround effect. This effect also works while listening with headphones. (This does not work with Karaoke DVDs. The effect depends on the kind of DVD used.)

Marker function (See page 51.)

This player can store a maximum of 5 positions in memory for convenient access.

Dialogue Enhancer (See pages 43 and 49.)

During playback of Dolby Digital/dts DVDs (2 channel or over) with the dialogue contained in the center channel, this function will boost the sound level of the center channel so that it is easier to hear the dialogue on movie software.

Graphical User Interface (GUI) screen (See page 46.)

By simply pressing the DISPLAY button on the remote control, information on the DVD/Video CD/CD player and disc can be displayed on the TV screen for easy identification. The player's operations and settings can be easily accessed by operating the joystick on the remote control while monitoring the TV screen. The color and position of the GUI screen can be changed.

Versatile DVD features

- **Multi-audio function (See page 54.)**
The audio soundtrack can be heard in up to 8 languages. (The number of languages depends on the software.)
- **Multi-subtitle function (See page 55.)**
Subtitles may be displayed in one of 32 languages. (The number of languages depends on the software.)
- **Multi-angle function (See page 55.)**
This function allows you to choose the camera angle of scenes shot from different angles. (Limited to DVDs recorded with multiple camera angles.)
- **Parental lock function (See page 57.)**
This function can prevent playback of DVD software which may be unsuitable for some audiences (especially for children). (Limited to DVDs encoded with specific rating level.)

Disc formats supported by this player

The player can playback discs bearing any of the following marks:



DVD
[8 cm disc/
12 cm disc]
NTSC



Video CD
[8 cm disc/
12 cm disc]
NTSC



CD
[8 cm disc/
12 cm disc]

Discs which cannot be played with this player

- DVD with Region No. other than "4" or "ALL"
- DVD-ROM
- DVD-R/DVD-RAM
- CD-ROM
- VSD
- Do not try to play Photo CD or CD-R. (Data on the disc may be damaged.)
- CDV
- CD-G
- CD-RW
- DVD + RW
- CVD
- SVCD
- Divx Video Disc etc.

Region Management Information

This player is designed to respond to the Region Management Information recorded on DVDs. The region number of this player is "1". If the region number described on the DVD does not correspond to the region number of this player, this player cannot play this disc. This player will play DVDs made for "ALL" regions. This player will play DVDs marked with labels containing the region number "1" or "ALL":

Example:

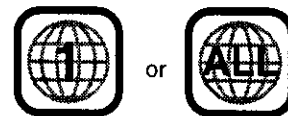

Location of Controls for DVD Operation

Enjoying digital audio output from the digital audio output connector

Note when connecting the optical digital audio cable

- Remove the dust protection cap from the optical digital audio output connector and connect the cable firmly so that the configurations of both the cable and the connector match.
- Keep the dust protection cap and reattach when not using the connector.

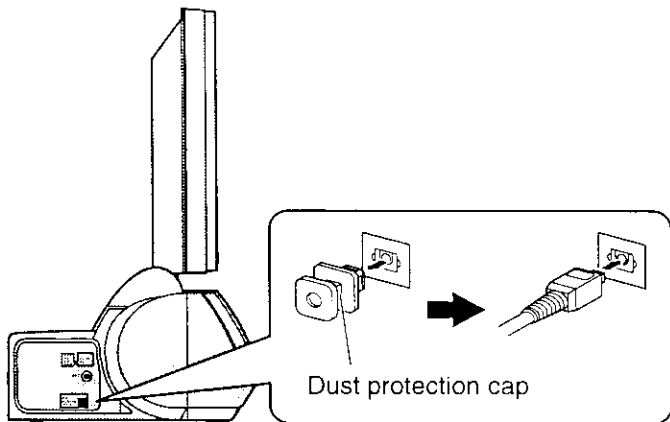

Optical/coaxial digital audio output connector

Disc	Sound recording format	Optical/coaxial digital audio output from connector
DVD	Dolby Digital	Dolby Digital bitstream (1–5.1ch) or PCM (2ch) (48 kHz/16 bit)** *2
	Linear PCM (48/96 kHz 16/20/24 bit)	Linear PCM (2ch) (48 kHz sampling/16 bit only) or no output**
	dts	PCM (2ch) (48 kHz/16 bit)*2 or dts bitstream (1–5.1ch)**
	MPEG audio	PCM (2ch) (48 kHz/16 bit)*2 or MPEG audio bitstream (1–7.1ch)**
Video CD	MPEG 1	PCM (44.1 kHz sampling)*2
CD	Linear PCM	Linear PCM (44.1 kHz sampling)
	dts**	PCM (2ch) (44.1 kHz/16 bit)** or dts bitstream (1–5.1ch)**

** The type of audio output from the connector can be selected by "7 Digital Audio Output" of the initial settings. (See page 61.)

* Compressed sound converted to PCM will be output.

** The settings and connections necessary to enjoy CDs recorded in dts are the same as for DVDs recorded in dts.

Note

- Some dts decoders which do not support DVD-dts interface may not work properly with the DVD/Video CD/CD player.

For your reference:

- Dolby Digital is a digital sound compression technique developed by the Dolby Laboratories, Inc. Supporting 5.1-channel surround sound, as well as stereo (2-channel) sound, this technique enables a large quantity of sound data to be efficiently recorded on a disc.
- The digital theater systems (dts) is a 5.1-channel surround sound system, which is widely used in movie theatres around the world. It allows the bit rate to be increased in order to provide good sound quality without excessively compressing the data.
- Linear PCM is a signal recording format used in a CD. While a CD is recorded in 44.1 kHz/16 bit, a DVD is recorded in 48 kHz/16 bit up to 96 kHz/24 bit.
- If you have a Dolby Pro Logic Surround decoder, you will obtain the full benefit of Pro Logic from the same DVD movies that provide full 5.1-channel Dolby Digital soundtracks, as well as from titles with the Dolby Surround mark.
- The digital audio output connector (optical) converts electrical signals into optical signals and transfers them to an amplifier. These optical signals are immune from electrical interference, and they also have minimal effect on other equipment.

Caution for the optional/coaxial digital audio output connector:

- Do not connect to the digital audio input of an amplifier that does not have Dolby Digital/dts/MPEG audio decoder.
- If such an amplifier should be connected to the player with "Bitstream" selected at the "2 Dolby digital", "3 DTS Digital Surround" (see page 61), any attempt to play DVDs (or CDs recorded in dts) may cause such a high level of noise that it may be harmful to your ears and damage your speakers.
- Video CDs and CDs can be played as they would normally be played.

Manufactured under license from Dolby Laboratories. "Dolby", "Pro Logic" and the double-D symbol are trademarks of Dolby Laboratories. Confidential Unpublished Works. © 1992-1997 Dolby Laboratories, Inc. All rights reserved.

Manufactured under license from Digital Theater Systems, Inc. "DTS" and "DTS Digital Surround" are trademarks of Digital Theater Systems, Inc. © 1996 Digital Theater Systems, Inc. All rights reserved.

Location of Controls for DVD Operation

Switches angles when scenes taken from several angles are being played back.

Opens and closes disk tray on the set.

Turns the power ON and OFF when the power on the TV set is ON.

OPEN
CLOSE DISPLAY

Displays disk information and settings when pressed during playback.

Displays the menu for disks with several titles recorded.

TOP MENU

ANGLE

DVD MENU

Displays the menu for DVDs with several menus.

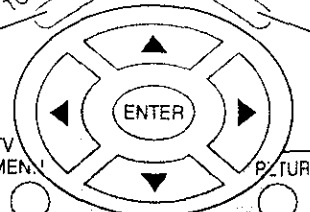

Used to make selections, SELECT Key adjustments and settings.

Searches the beginning of a scene or song.

SKIP SLOWSEARCH

For fast forwarding or slow playback.

Stops operation of disk.

STOP PAUSE PLAY

Pauses movies and music or forwards frames.

Plays the disk or turns the vocals ON and OFF for Karaoke.

ASPECT TV/VIDEO MUTE
SLEEP CH VOL
SURROUND

1 2 3
4 5 6
7 8 9
≥10 0 CANCEL

Used to select menus, songs, set time and input passwords.

Selects groups.

REPEAT MODE A-B REPEAT PLAY MODE
R-TUNE

Selects still pictures and playback modes.

Panasonic
TV/DVD

Functions of front operation panel

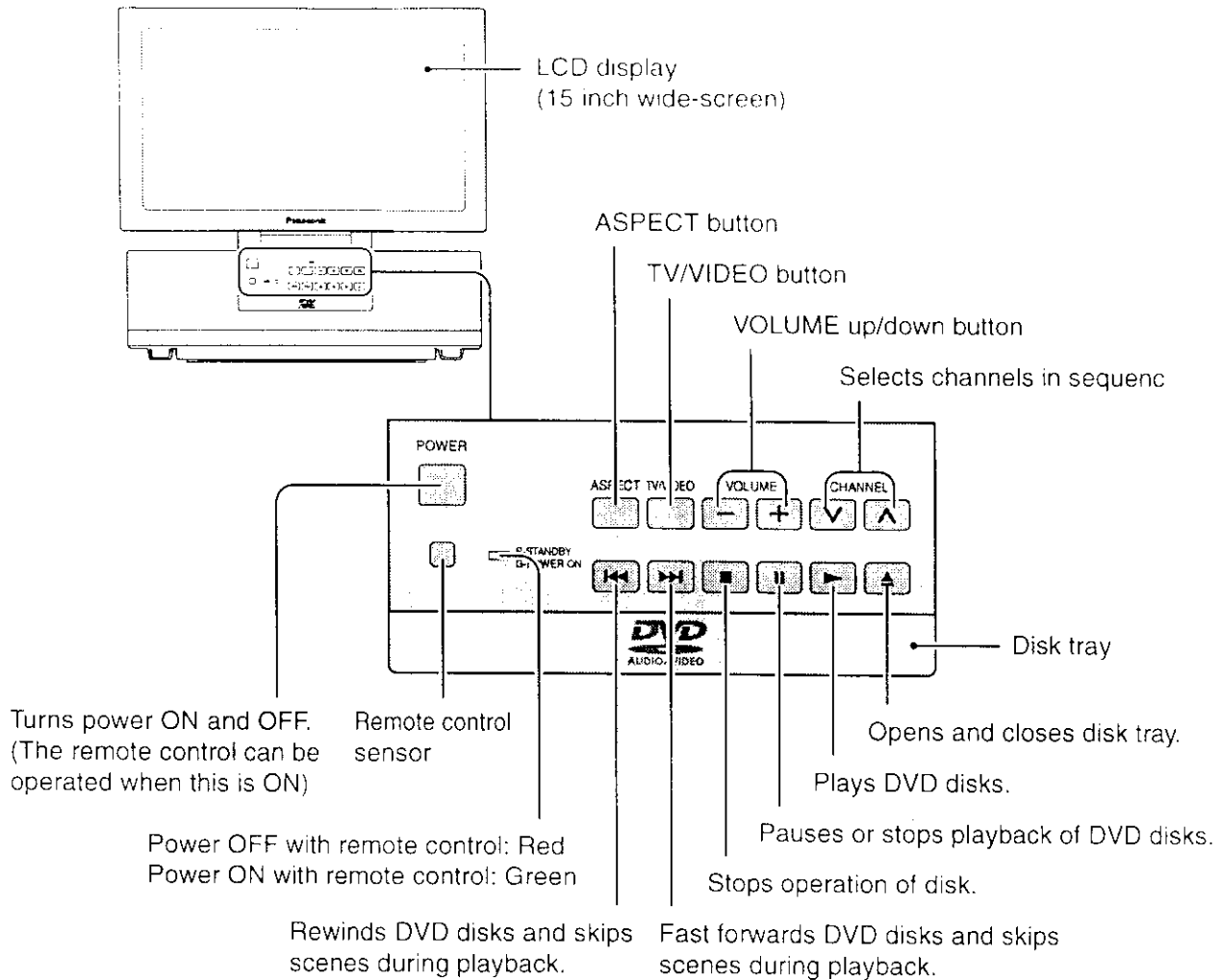

Basic play

Before enjoying DVD/Video CD/CD

The On-Screen menu language of your player has been factory preset to English.

You can change the menu language to French, Spanish. Refer to "Selecting On-Screen Display menu language" on page 59.

In the explanations given below it is assumed that English has been selected as the menu language.

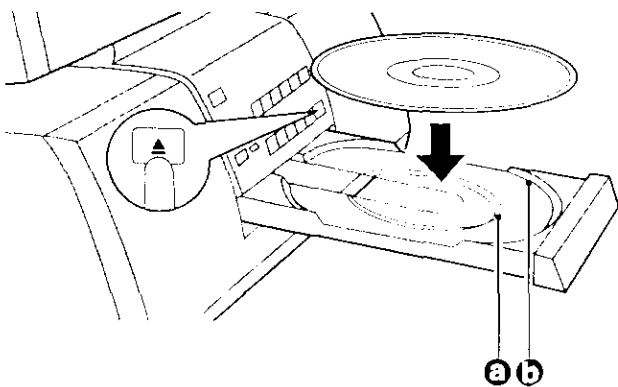
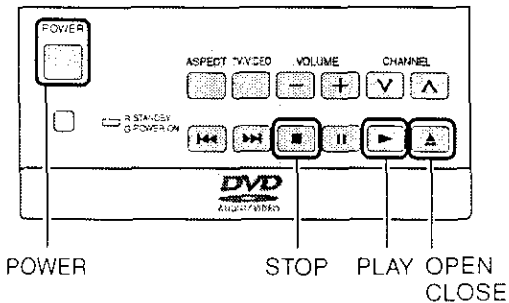
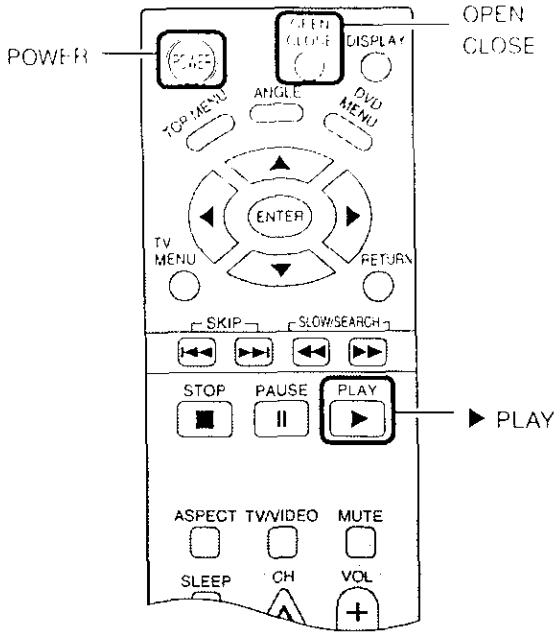

Recalling/clearing a marker

1 Press POWER to switch on the power.

(See page 20.)

2 Press OPEN CLOSE to open the disc tray.

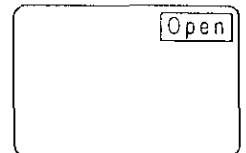

3 Place the disc on the disc tray with the label side to be played facing upwards.

(If the disc has a label)

Hold the disc without touching either of its surfaces, position it with the label side to be played facing upward, align it with the guides, and place it in position.

a 8 cm disc

b 12 cm disc

4 Press PLAY to displayed as follows.

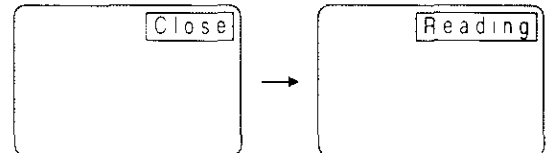

The disc tray is automatically closed and play begins.

- When the disc tray is closed by pressing OPEN CLOSE, press PLAY to start play.

- When a menu screen appears on the TV monitor

In the case of many movie DVDs, an interactive DVD or Video CD with playback control, a menu screen appears on the TV monitor. Perform step 5 to start play.

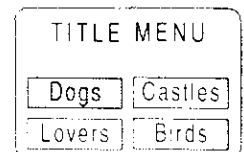

(Example of DVD)

5 Press SELECT (▲, ▼, ◀, ▶) button to select the item and press ENTER.

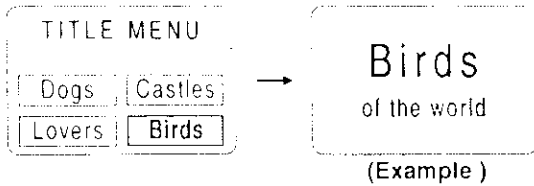

Play of the selected item now begins.

While watching movies

• Raising dialogue volume

The volume for the dialogue can be raised by displaying the GUI screen (for player information) and setting "Dialogue Enhancer" to "ON". (See page 49.)

This setting takes effect only for discs which are recorded with Dolby Digital/dts (2 channel or over) and with the

dialogue contained in the center channel.

When the menu continues onto another screen

After step 4 on page 42, press SKIP (▶▶|).

• To return to the previous menu screen

Press SKIP (◀◀|)

- Due to the design of some software titles, SKIP (◀◀, ▶▶) may not always work. For operation, refer also to the jacket of the disc concerned.

Stopping play and returning to the menu screen

Press DVD MENU or TOP MENU.

Play is suspended, and the menu screen is displayed.

- The buttons may not work depending on the disc used.

After operation

When the player is not in use, remove the disc and press POWER to set the player to the standby mode.

What is playback control?

If a Video CD has "playback control" written on its disc or jacket, it means that particular scenes or information can be selected for viewing interactively with the TV monitor using the menu screen.

Note

- The disc continues to rotate while the menu is displayed even after the player has finished playing a particular item. When no further selections are to be played, be sure to press STOP to clear the menu display.

For your reference:

- When ⊘ appears on the TV monitor when a button is pressed, the operation is prohibited by the player or disc.

Stopping play

Press STOP during play.

RESUME function

The player records the point where STOP was pressed during play.

- Press PLAY again, and play will resume from this point.
- When the tray is opened or STOP is pressed again, the RESUME function will be cleared.

This feature remains active if the player is set to the standby mode and then turned back ON.

Chapter review function (DVD only)

When PLAY is pressed while RESUME function the message shown on the right is briefly displayed.

Press PLAY to Chapter Review

If PLAY is pressed again while the above message is displayed on the screen, the first few seconds of each chapter from the beginning of the title up to the point where operation was stopped will be played. This makes it possible to review previous chapters. Normal playback will commence from the point where operation was stopped.

Note

- Cancelling the RESUME function will also clear the chapter review function.
- The chapter review function may not work with some DVDs.

Skipping chapters or tracks

Press SKIP (◀◀ , ▶▶) during play.

With the remote control

On the TV SET

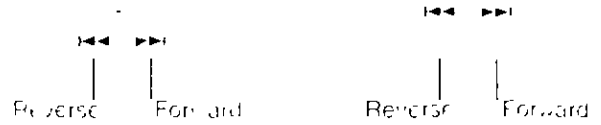

For your reference

- A chapter (DVD) or a track (Video CD) is skipped each time the button is pressed
- When SKIP (◀◀) is pressed once midway through a chapter/track, play returns to the start of that chapter/track. When it is pressed again, a chapter/track is skipped each time the button is pressed
- When SKIP (◀◀ ▶▶) is pressed during menu play of Video CDs with playback control, a menu screen may sometimes be recalled

Still picture (Pause)

Press PAUSE (||) during play.

- DVD/Video CD The player will be placed in the still picture mode
- CD The player will be placed in the pause mode
- Normal play is resumed when PLAY is pressed

Rapid advance (Rapid reverse)

Press SLOW/SEARCH (◀◀ , ▶▶) during play.

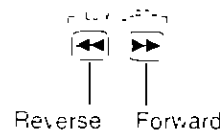

(Example)

- The speed of advance (reverse) is relatively slow at first. When the button is pressed again, the speed increases up to 5 steps
- Normal play is resumed when PLAY is pressed

For your reference

- When SLOW SEARCH (◀◀ ▶▶) is used during menu play of Video CDs with playback control, a menu screen may sometimes be recalled
- For DVDs and Video CDs, audio will be heard during scanning (forward direction only) at the initial scan speed. (See page 64.) For CDs, audio will be heard during scanning at every scan speed (1 to 5). (For dts CDs, audio will not be heard at any speed.)

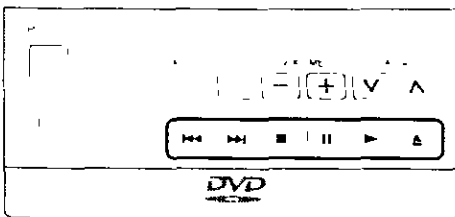
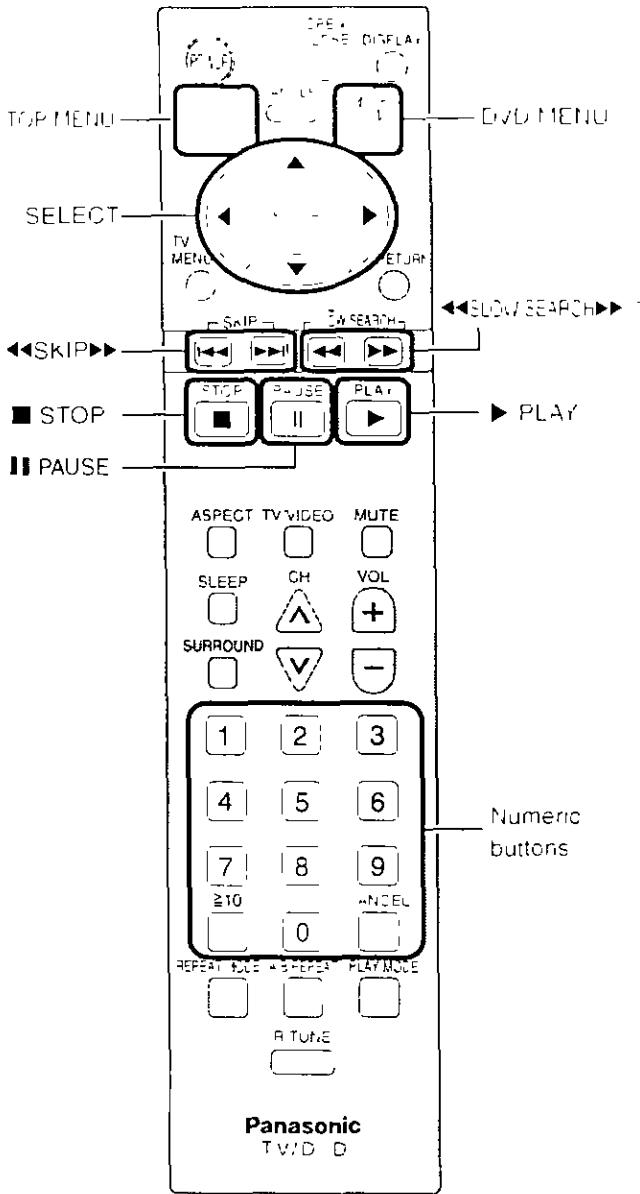

Frame advance (Frame reverse) [DVD/Video CD]

Press **SELECT** (◀ , ▶) in the still picture mode.
(See page 44.)

- ◀ : Reverse
- ▶ : Forward

- The disc is advanced (reversed) by one frame each time the **SELECT** (◀ , ▶) is pressed.
- When the **SELECT** (◀ , ▶) is kept pressed, consecutive frame advance (reverse) works.
- Normal play is resumed when **PLAY** is pressed.

Note

- For Video CDs, frame reverse is not possible.

For your reference:

- Pressing **PAUSE** also activates frame advance.
- Whether the pictures are advanced by a "Frame" or "Field" is automatic. (See page 64.)

Slow-motion play [DVD/Video CD]

Press **SLOW/SEARCH** (◀◀ , ▶▶) in the still picture mode. (See page 44.)

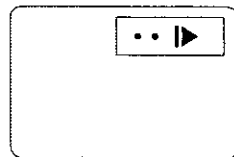
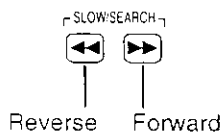

(Example)

- The speed of slow-motion is slow at first. When the button is pressed again, the speed increases up to 5 steps.
- Normal play is resumed when **PLAY** is pressed.

Note

- For Video CDs, slow-motion playback in reverse direction is not possible.

Cancelling playback control [Video CD]

1. Press **STOP** after the menu screen appears (after step 4 on page 42).
2. Press the numeric buttons to select a track.
(Play begins.)
 - Refer to the jacket etc. of the disc concerned for the track numbers.
 - Press "1" to start play from the beginning of the disc.

To return to menu play

Press **STOP** to stop playback and press **DVD MENU**.
Perform step 5 on page 43.

Using a TOP MENU [DVD]

Some movie discs may have two or more titles. If the disc has a title menu recorded on it, the **TITLE** button can be used to select the movie title. (The details of operation depend on the disc used.)

- 1 Press **TOP MENU** during play.

A list of the titles on the disc is now displayed.

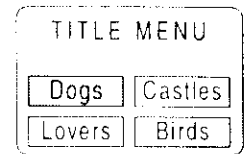

(Example)

- Pressing **TITLE** again resumes play from the scene when **TITLE** was first pressed.

- 2 Press **SELECT** (▲, ▼, ◀, ▶) button to select the item and press **ENTER** or **PLAY**.

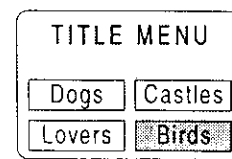

(Example)

The selected title now starts playing.

Using a DVD menu [DVD]

Some DVDs have unique menus. These menus can be for language selection, audio output selection and/or subtitle language selection, etc. Although the DVD menu's contents and operation differ from disc to disc, the following explains basic operation when this feature is used.

- 1 Press **DVD MENU** during play.

The DVD menu available on the disc is now displayed.

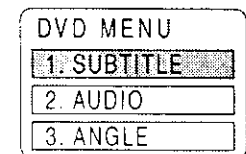

(Example)

- Pressing **MENU** again resumes play from the scene when **MENU** was first pressed.

- 2 Press **SELECT** (▲, ▼, ◀, ▶) button and press **ENTER**, or press the numeric buttons, to select the item.

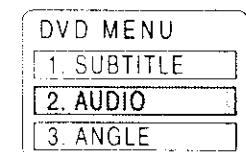

The selected title now starts playing

(Example)

When the menu continues onto another screen

Repeat step 2

General information about GUI screens

This player features GUI (Graphical User Interface) screens providing various functions. A "banner" will be displayed on the TV when DISPLAY button on the remote control is pressed. Operating the SELECT/ENTER button on the remote control will show disc information (title/chapter/track number, elapsed playing time, audio/subtitle language, and angle) and player information (repeat play, play mode, marker, picture mode, Virtual Surround Sound, master volume, etc.). Some icons allow the settings to be changed.

Common procedures

1 Press DISPLAY during play or in the stop mode.

Each time this button is pressed, the TV monitor changes as shown below.

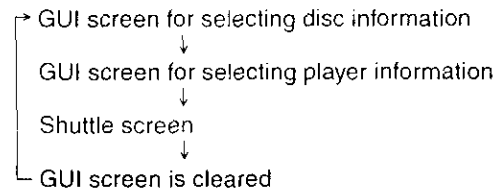

- Some functions cannot be accessed from the stop mode.

2 Press the SELECT (◀, ▶) button to select the item.

- The currently selected item is indicated by the yellow frame on the GUI screen.

3 Press the SELECT (▲, ▼) button to select the setting.

- For some functions, the setting will be registered immediately; for others, ENTER or PLAY must be pressed.
- When numbers are displayed (e.g. title No.), the numeric buttons are also effective for setting instead of the SELECT (▲, ▼) button. When numbers are entered with numeric buttons, press ENTER to register the setting.

Press RETURN to clear the GUI screen.

Examples of GUI screens

See **A**, **B** and **C** for detailed illustration.

The screens depend on the disc contents.

For your reference:

- The GUI screens may not be displayed when playing some kinds of DVD software.
- The color (blue, violet or green) of the GUI screen can be changed. (See page 59.)

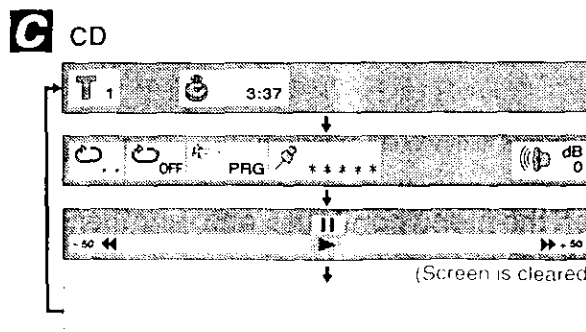
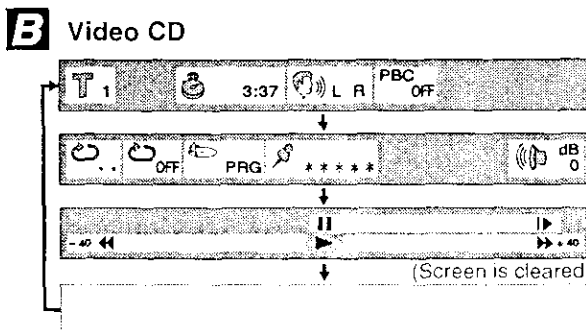
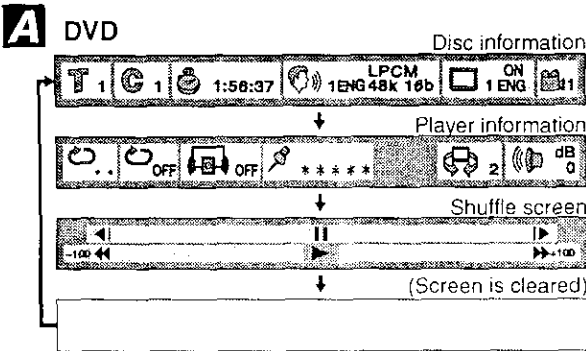
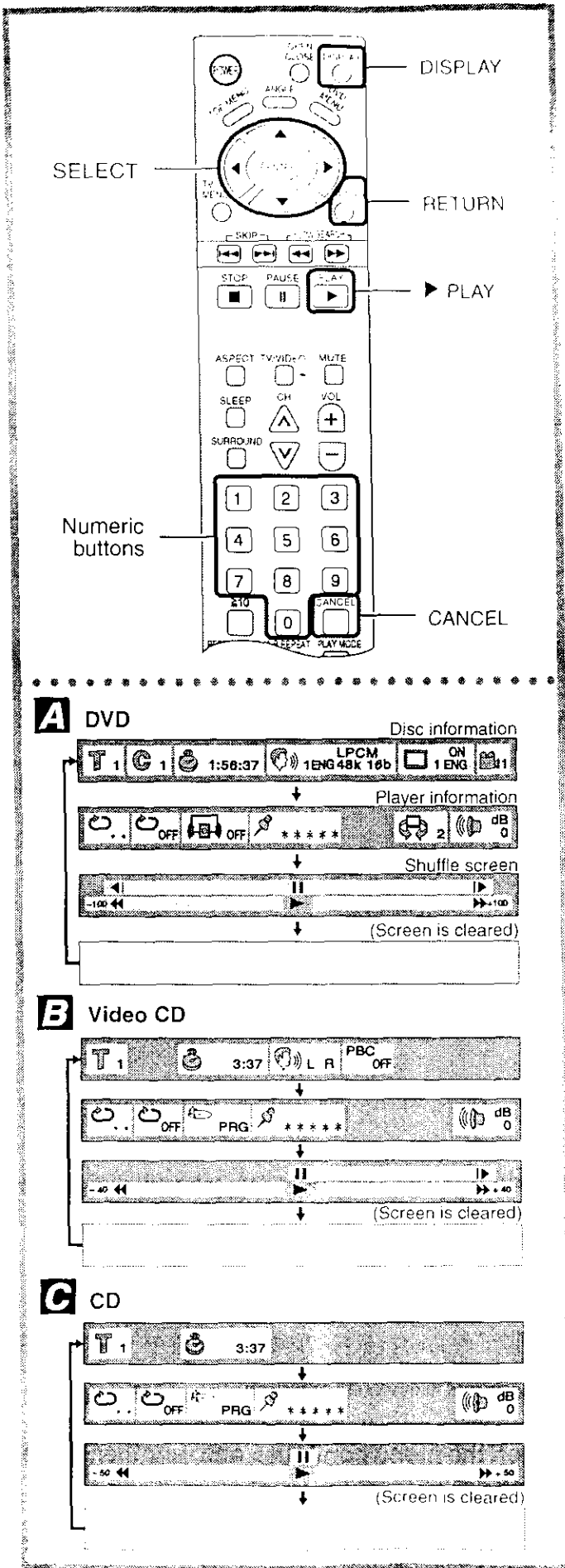

Detailed descriptions of each GUI icon

Screen for disc information (For DVD)

Title No. Change the title No. with time SELECT (▲, ▼) button or the numeric buttons and press ENTER.

Chapter No. Change the chapter No. with the SELECT (▲, ▼) button or the numeric buttons and press ENTER.

Elapsed playing time
(hour: minute: second)
Change the time with the numeric buttons and press ENTER.
Example: To specify "1 hour 56 min. 37 sec.", enter "15637".
(This function does not work with some discs.)

Angle No.
(See page 55.) Change the No. with the SELECT (▲, ▼) button or the numeric buttons.



Audio soundtrack language No. (See page 54.)	Change the No. with the SELECT (▲, ▼) button or the numeric buttons.				
Audio soundtrack language	ENG: English FRA: French DEU: German ITA: Italian ESP: Spanish NLD: Dutch SVE: Swedish NOR: Norwegian DAN: Danish	POR: Portuguese RUS: Russian JPN: Japanese CHI: Chinese KOR: Korean MAL: Malay VIE: Vietnamese THA: Thai *: Other			
Audio attribute	LPCM	96k or 48k	16b 20b 24b	Linear PCM ("k" stands for kHz and "d" stands of bit.)	
	Digital	1ch-3/2.1ch*		Dolby Digital	
	DTS	1ch-3/2.1ch*		dts	
	MPEG	1ch-3/2.1ch*		MPEG audio	
	Vocal	--- (OFF)			DVD Karaoke (Solo)
		ON			
	Vocal	--- (OFF)			DVD Karaoke (Duet)
V1 + V2					
V1					
		V2			

Subtitle language No. (See page 55,56.)	Change the No. with the SELECT (▲, ▼) button or the numeric buttons.	
Sub language	ENG: English FRA: French DEU: German ITA: Italian ESP: Spanish NLD: Dutch SVE: Swedish NOR: Norwegian DAN: Danish	POR: Portuguese RUS: Russian JPN: Japanese CHI: Chinese KOR: Korean MAL: Malay VIE: Vietnamese THA: Thai *: Other
Subtitle on/off	Select "ON" or "OFF" with the SELECT (▲, ▼) button.	
	OFF	Subtitles cleared.
	ON	Subtitles displayed.

• The GUI screen display indicates the number of channels recorded on the disc.

Example:
3/2.1ch

0: No low frequency effect (for subwoofer)
1: Low frequency effect (for subwoofer)

0: No Surround
1: Mono Surround
2: Stereo Surround (left/right)

0: Center
1: Front left + Front right
2: Front left + Front right + Center

For your reference

• "▲, ▼" around the icon means that the item can be changed with the SELECT (▲, ▼) button

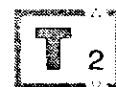

Detailed descriptions of each GUI icon

Screen for disc information (For Video CD/CD)

Track No. Change the Track No with the SELECT (▲, ▼) button or the numeric buttons and press ENTER.

Elapsed playing time
(minute: second)

Display is changed with the SELECT (▲, ▼) button.
 Elapsed playing time ←→ Remaining time of the track
 ←→ Remaining time of the disc

This function works with the following discs.

- CDs
- Video CDs with playback control when menu play is cancelled (Press STOP while the menu screen is displayed.)
- Video CDs which do not support playback control (Ver 1.1)

Playback controls (Video CD only) (See page 43.)	OFF	Menu play is off.
	ON	Menu play is on.



Audio mode (Video CD only) (See page 54.)	Change the mode with SELECT (▲, ▼) button.	
	LR	Left channel sound is output from the speaker (L), and right channel sound from the speaker (R).
	L	Left channel sound only is output.
	R	Right channel sound only is output.

Note

- Track No. and the elapsed playing time are not displayed during menu play of Video CDs with playback control
- It is not possible to turn playback control ON or OFF using the GUI screen

For your reference

- "▲, ▼" around the icon means that the item can be changed with the SELECT (▲, ▼) button

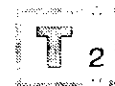

Screen for player information

A-B repeat play (See page 51.)

Press ENTER during to store location A and press ENTER again to store location B. Repeat play between the two locations starts. Press ENTER again to return to normal play.

Repeat play (See page 50.)

Select the mode during play with the SELECT (▲, ▼) button.

OFF	Normal play	DVD
C	Chapter repeat play	
T	Title repeat play	
OFF	Normal play	Video CD/ CD
T	Track repeat play	
A	Disc repeat play	

Marker (See page 51.)

Press ENTER during play and press ENTER again at the preferred point to store a marker. (Marker no. replaces "※".)

- To recall a marker, select the marker no. with the SELECT (◀, ▶) button and enter the selection with the SELECT button (◀, ▶).
- To clear a marker, select the marker no. with the SELECT (◀, ▶) button and press CANCEL.

• DVD Dialogue Enhancer (See page 43.)

Select the mode during play with the SELECT (▲, ▼) button.

OFF	Normal volume
ON	Louder volume

• Video CD/CD Play mode (See pages 52 and 53.)

PRG	Program play
RND	Random play
---	Normal play

Virtual Surround Sound (Dolby Digital DVD only) (See page 28.)

Select the mode during play with the SELECT (▲, ▼) button.

	VSS
	Headphone VSS
Select the mode during play with the SELECT (▲, ▼) button.	
OFF	VSS Off
1	VSS natural effect
2	VSS emphasized effect



Master volume

Adjust the master volume with the SELECT (▲, ▼) button. 0 to -127 dB or -∞

Note

- Repeat play and marker functions do not work with an interactive DVD or during menu play of a Video CD with playback control.
- A-B repeat play does not work with an interactive DVD.
- It is not possible to change the play mode using the GUI screen.
- The master volume can be set and stored separately for DVD, Video CD and CD.

Shuttle screen

Slow-motion play (Backward)

Press the SELECT (◀) button. (DVD only)

Still/Pause

Press the SELECT (▲) button.

Slow-motion play (Forward)

Press the SELECT (▶) button. (DVD/Video CD only)



Rapid reverse

Press the SELECT (◀) button

Play

Press the SELECT (▼) button

Repaid advance

Press the SELECT (▶) button

For your reference

- Each time the SELECT (◀, ▶) button is pressed, the speed of rapid reverse advance and slow-motion play increases up to 5 steps.
- The figures appearing at both ends of the shuttle screen stand for the maximum speeds of rapid reverse and rapid advance (DVD: +100/-100, Video CD: +40/-40, CD: +50/-50)

Repeat play

Repeat viewing (Listening)

Press REPEAT MODE during play.

Each time this button is pressed, the TV monitor changes as shown below and the disc will repeat a chapter or title (DVD) or a track (Video CD/CD)

• DVD

Normal play

Repeat of chapter being played

Repeat of title being played

Cancel repeat mode
(Normal play)

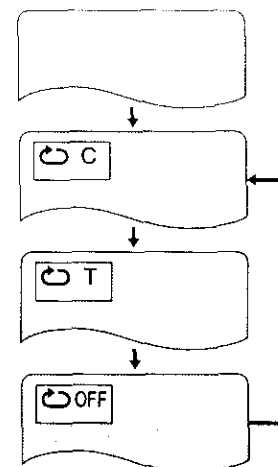

• Video CD / CD

Normal play

Repeat of track being played

Repeat of entire disc contents

Cancel repeat mode
(Normal play)

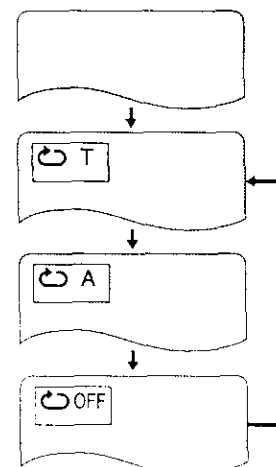

To return to normal play

Press REPEAT MODE until "OFF" is displayed.

Note

- Repeat play may not work correctly with some DVDs.
- Repeat play does not work with an interactive DVD or during menu play of a Video CD with playback control

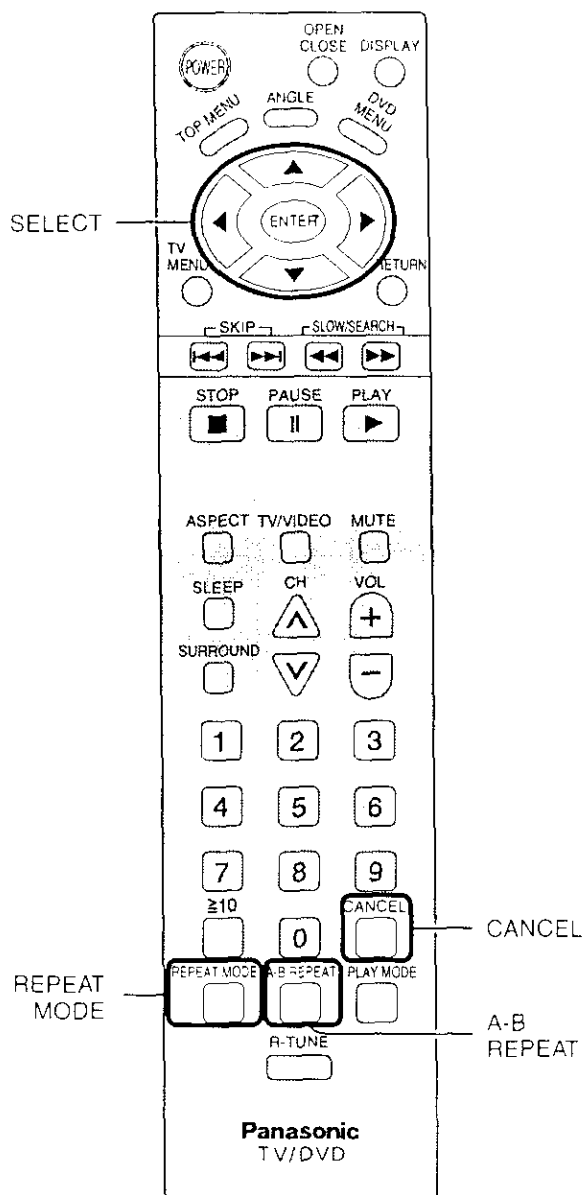

To enjoy program repeat play

If REPEAT MODE is pressed during program play (see page 52), the display changes as follows:

Program play

Repeat of programmed track being played

Repeat of all programs

Cancel repeat mode (Program play)

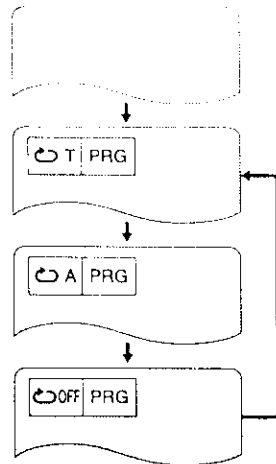

To return to program play

Press REPEAT MODE until "OFF" is displayed.

Repeating sections between two specific points (A-B repeat)

1 Press A-B REPEAT during play at the point where repeat play is to start (A).

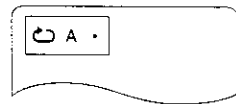

2 Press A-B REPEAT at the point where repeat play is to be concluded (B).

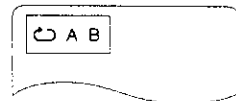

Repeat play of the section between points A and B starts.

To return to normal play

Press A-B REPEAT until " " is displayed.

Note

- A-B repeat play does not work with an interactive DVD.
- Some subtitles recorded around point A or B may fail to appear (DVD).
- A-B repeat play works only within a title (DVD) or a track (Video CD).

For your reference:

- The end of a track or title is automatically determined as point B

Storing markers in memory to be viewed (listened to) again

Storing a marker in the memory

1 Press the DISPLAY during play to display the Disk information.

2 Press SELECT (◀▶) button to select the marker item.

The marker screen appears on the TV monitor.

"*" indicates no marker has been stored yet.

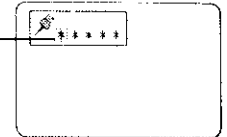

3 Press SELECT during play at the starting point to be viewed (listened to) again.

Indicates "MARK 1" is stored in the memory.

(If ENTER is pressed where any number is already displayed, the previous starting point will be replaced by the new one.)

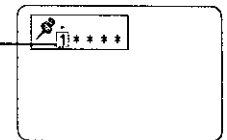

- Press select (▶) key and press ENTER to store the next marker.
- Up to 5 markers can be stored in the memory.
- Press MARKER to clear the display.

Recalling / clearing a marker

1 Press the DISPLAY during play to display the Disk information.

2 Press SELECT (◀▶) button to select the marker item.

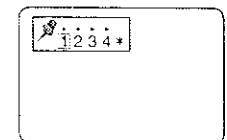

3 Press SELECT (◀▶) button to select the marker to be recalled/cleared.

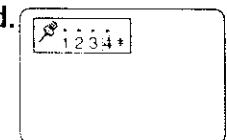

4 Press SELECT (▲) button to recall a marker.

or

Press CANCEL to clear a marker.

Play resumes from the point corresponding to the selected marker.

or

The selected marker is cleared.

Note

- Some subtitles recorded around the marker may fail to appear. [DVD]
- These operations do not work with an interactive DVD or during menu play of a Video CD with playback control

For your reference:

- All the markers are cleared when the player is set to the standby mode or turned off, or OPEN CLOSE is pressed.

Program play [Video CD / CD]

The player plays the tracks on the disc in an order you specify.

1 Press PLAY MODE in the stop mode.

The program playback screen appears on the TV monitor.

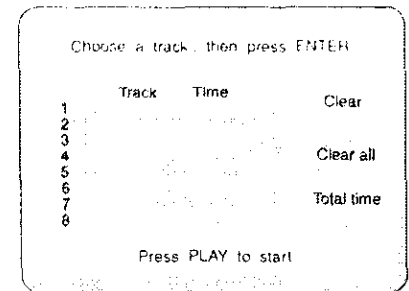

- To exit the screen
Press PLAY MODE twice.

2 Press ENTER and press SELECT (▲, ▼) button to select the track.

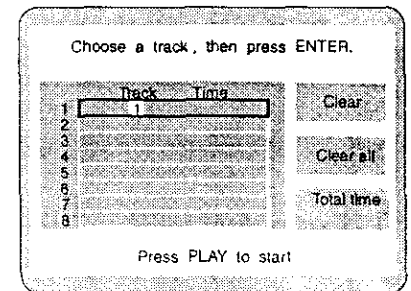

3 Press ENTER.

The selected track is stored in the memory.

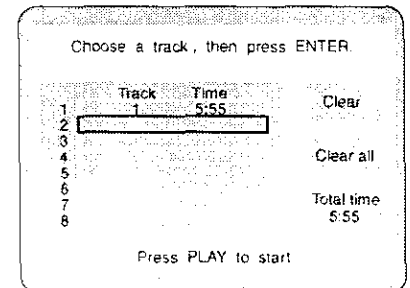

- Repeat steps 2 and 3 to select another track.
- Up to 18 tracks can be programmed.

4 Press PLAY.

Play now begins in the programmed sequence.

After playback

Play stops after the last programmed track

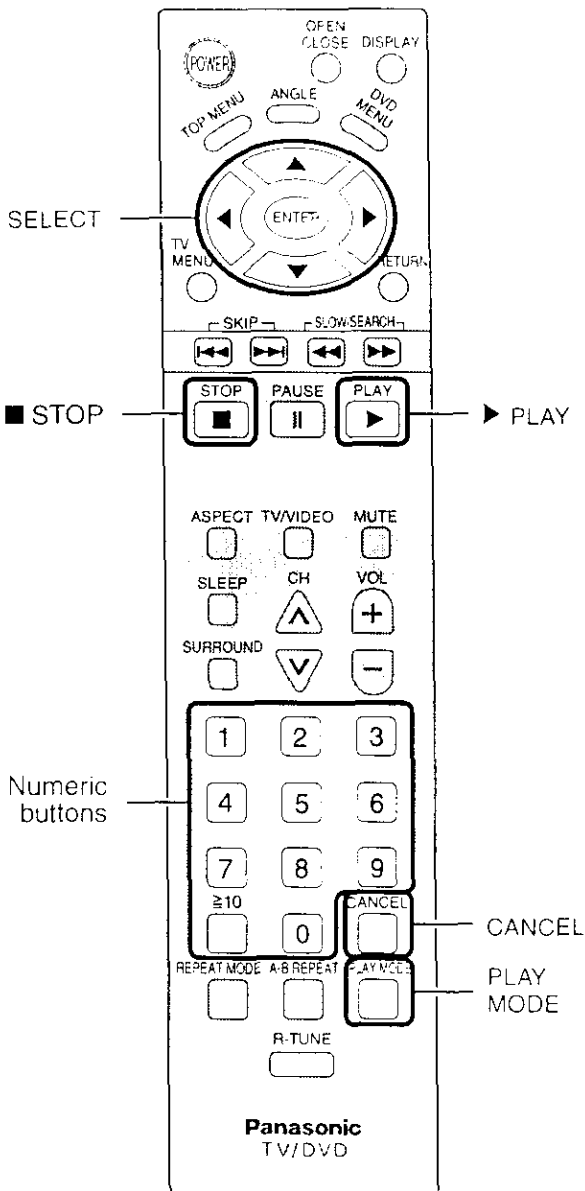

To return to normal play

1. Press STOP. (Program play is suspended.)
 2. Press PLAY MODE twice.
 3. Press PLAY.
Normal play begins from the beginning of the disc.
- The program is retained in the memory.

Clearing the program

When the program playback screen is displayed.

- **To clear the last program one by one**
Move to "Clear last" and press SELECT.
(Pressing CANCEL on the remote control also clears the last program.)
- **To clear the whole program**
Move to "Clear all" and press SELECT.
(The program is also cleared when the player is set to the standby mode or turned off, or OPEN CLOSE is pressed.)

Random play [Video CD / CD]

The player plays the tracks on the disc in random order.

1 Press PLAY MODE twice in the stop mode.

The random playback screen appears on the TV monitor.

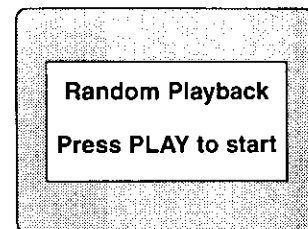

- **To exit the screen**
Press PLAY MODE once.

2 Press PLAY.

Play now begins in random order.

After playback

Play stops and the random playback screen is displayed.

To return to normal play

1. Press STOP. (Random play is suspended.)
2. Press PLAY MODE once.
3. Press PLAY.
Normal play begins from the beginning of the disc.

Changing audio soundtrack language [DVD]

It is possible to change the audio soundtrack language to a different language from the one selected at the initial settings if available. (See page 57.)

This operation works only with discs on which multiple audio soundtrack languages are recorded.

1 Press DISPLAY during play to display the disk information.

The program playback screen appears on the TV monitor.

- When no audio soundtrack is recorded, “-” will be displayed instead of the language number.

Number of the audio soundtrack language being played back

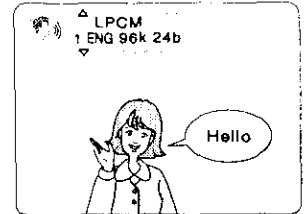

2 Press SELECT (◀ , ▶) to select the AUDIO soundtrack.

3 Press SELECT (▲ , ▼) to select the language.

Pressing the numeric buttons also changes the audio soundtrack language.

- Press DISPLAY or ENTER to clear the display.

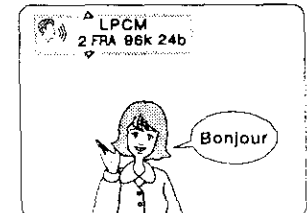

For your reference:

- When the preferred language is not selected, even after press the SELECT (▲ , ▼) button several times, it means that language is not available on the disc.
- When the power is turned on, or the disc is removed, the language heard is the one selected at the initial settings. If this language is not recorded on the disc, only the available language on the disc will be heard.

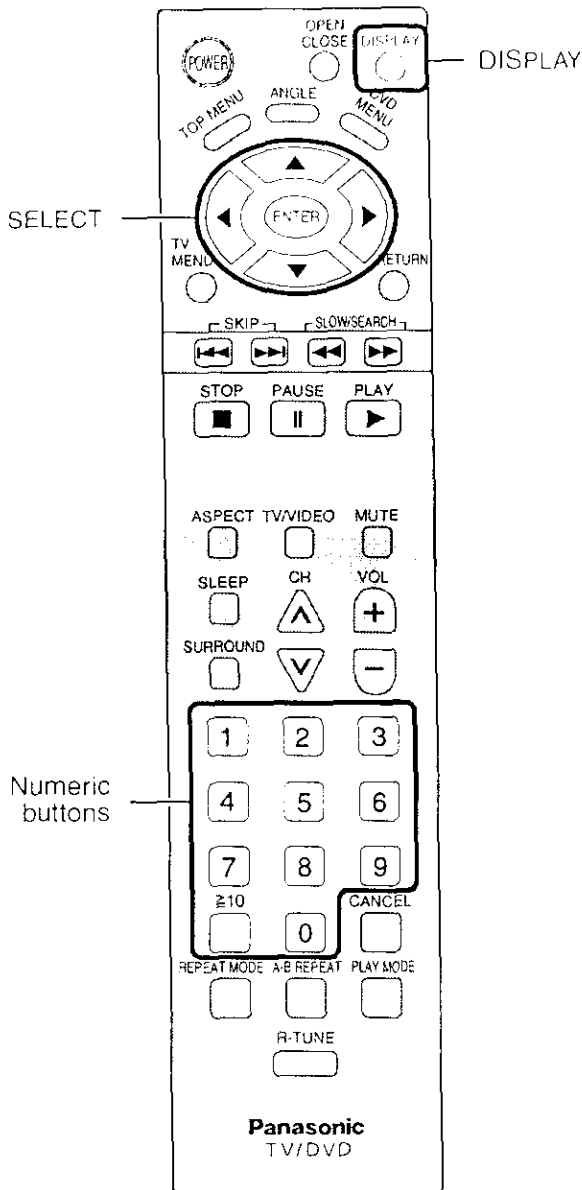

Changing subtitle language [DVD]

It is possible to change the subtitle language to a different language from the one selected at the initial settings if available. (See page 57.)

This operation works only with discs on which multiple subtitle languages are recorded.

1 Press DISPLAY button to display the player information.

- When no subtitles are recorded, "--" will be displayed instead of the language number.

Number of the audio soundtrack language being played back

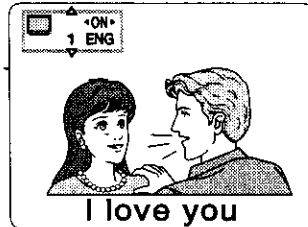

2 Press SELECT (◀ , ▶) to select SUBTITLE language item.

3 Press SELECT (▲ , ▼) to select the language.

Pressing the numeric buttons also changes the subtitle language.

- Press SUBTITLE or ENTER to clear the display.



To clear/display the subtitles

Press the SELECT (◀ , ▶) to select ON or OFF at step 2.

For your reference:

- When the preferred language is not selected, even after press the SELECT (▲ , ▼) several times, it means that language is not available on the disc.
- When the power is turned on, or the disc is removed, the language heard is the one selected at the initial settings. If this language is not recorded on the disc, only the available language on the disc will be heard.

Viewing from another angle [DVD]

Some DVDs contain scenes which have been shot simultaneously from a number of different angles. For these discs, the same scene can be viewed from these different angles with the ANGLE button. (The angles depend on the disc used.)

1 Press ANGLE during play.

Number of angle being played back

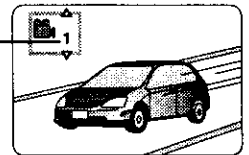

2 Press SELECT (▲ , ▼) to select the angle.

Pressing the numeric buttons also changes the angle.

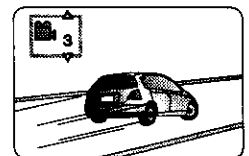

- Press ENTER to clear the display.

Note

- This function only works for titles having scenes recorded at different angles.

Initial settings

Once the initial settings have been completed, the player can always be operated under the same conditions (especially DVDs). The settings will be retained in the memory, until the settings are changed, even after switching to standby mode.

Common procedures

- 1 Press TV MENU to display menu screen during stop mode.

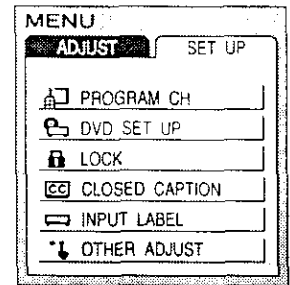

- 2 Press SELECT (◀, ▶) to select SETUP.

- 3 Press SELECT (▲, ▼) to select DVD SETUP, and press ENTER.

Initial Setting menu

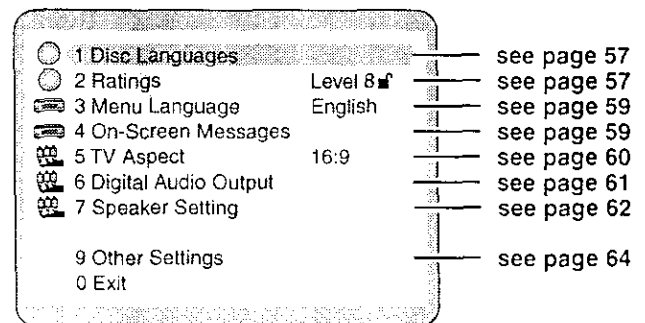

- 4 Press SELECT (▲, ▼) to select the item and press ENTER.

Each screen for setting the value is displayed.

- 1 Disc Languages
- 2 Ratings
- 3 Menu Language
- 4 On-Screen Messages
- 5 TV Aspect
- 6 Digital Audio Output
- 7 Speaker Setting
- 9 Other Settings

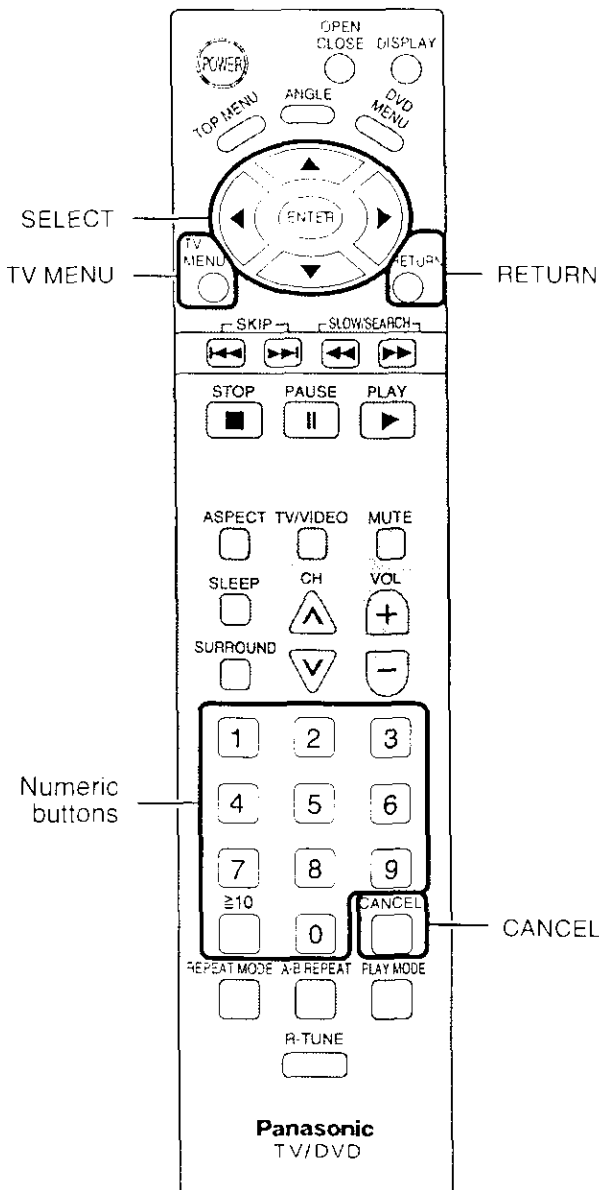

To cancel during setup operation

Press RETURN or select "0". (The previous screen is displayed.)

To clear the initial settings screen

Press SELECT (▲, ▼) to select "0" and press ENTER.
(Pressing TV MENU or RETURN also clears the initial settings screen.)

Note

- After the player is set to the "Lock All" setting in "2 Ratings", none of the initial settings, including "2 Ratings", can be changed if a DVD is left inside the player. In this case, remove the disc, and unlock the player.

For your reference:

- The numeric buttons can also be used instead of the SELECT (▲, ▼) button for selecting items or values. Pressing SELECT is not necessary.

Selecting disc language [DVD]

This is to select the audio soundtrack language, subtitle language and the language used in title menus or the DVD menus which will always be used for every disc to be played back.

- 1 At the initial settings screen (on page 56)
Press SELECT (▲, ▼) to select "1 Disc Languages" and press ENTER.

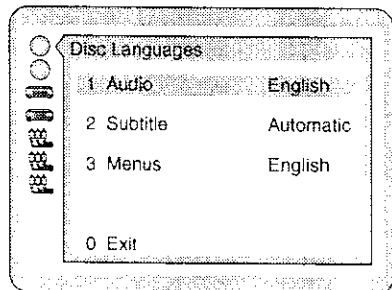

- 2 Press SELECT (▲, ▼) to Select the item and press ENTER.

- 1 Audio:
To select the audio soundtrack language.
- 2 Subtitle:
To select the subtitle language.
- 3 Menus:
To select the language used in title menus or the DVD menus.

- 3 Press SELECT (▲, ▼) to select the language and press ENTER.

When "1 Audio" is selected

- 1 English: English is selected. (Factory preset)
- 2 French / 3, Spanish: The language is selected.
- 4 Original: The original language of each disc will be selected.
- 5 Other ****: Another language can be selected. (Refer to the language codes on page 66. Press CANCEL if an incorrect language code is entered.)

When "2 Subtitle" is selected

- 1 Automatic: Subtitle language will automatically be selected in accordance with the audio soundtrack language. (Factory preset)
 - If the language selected for the "1 Audio" is actually used during playback, the subtitles will not appear.
 - If another language is used during playback, the subtitles will appear in the language selected at the setup "1 Audio".
- 2 English / 3, French / 4, Spanish: The language is selected.
- 5 Other ****: Another language can be selected. (Refer to the language codes on page 66. Press CANCEL if an incorrect language code is entered.)

When "3 Menus" is selected

- 1 English: English is selected. (Factory preset)
- 2 French / 3, Spanish: The language is selected.
- 4 Other ****: Another language of each disc will be selected. (Refer to the language codes on page 66. Press CANCEL if an incorrect language code is entered.)

The screen illustrated in step 1 is displayed. Select "0" with the SELECT (▲, ▼) button and press ENTER to return to the initial settings screen.

Also refer to "Common procedures" on page 56.

Note

- If the language selected is not available on the disc, the language designated by each disc will be selected.

Selecting rating level [DVD]

This is to disable the playing of some DVDs which are unsuitable for some audiences, for example, children.

- Some DVDs are encoded with a specific rating level. If the rating level of the disc is higher than that preset in the initial settings operation, playback of the disc will be prohibited.

- 1 At the initial settings screen (on page 56)
Press the SELECT (▲, ▼) button to select "2 Ratings" and press ENTER.

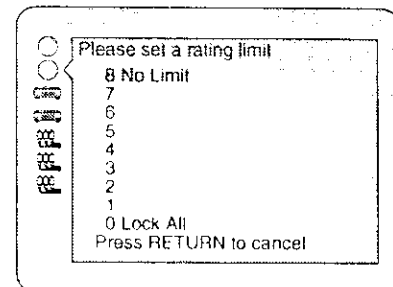

(Continued on the next page)

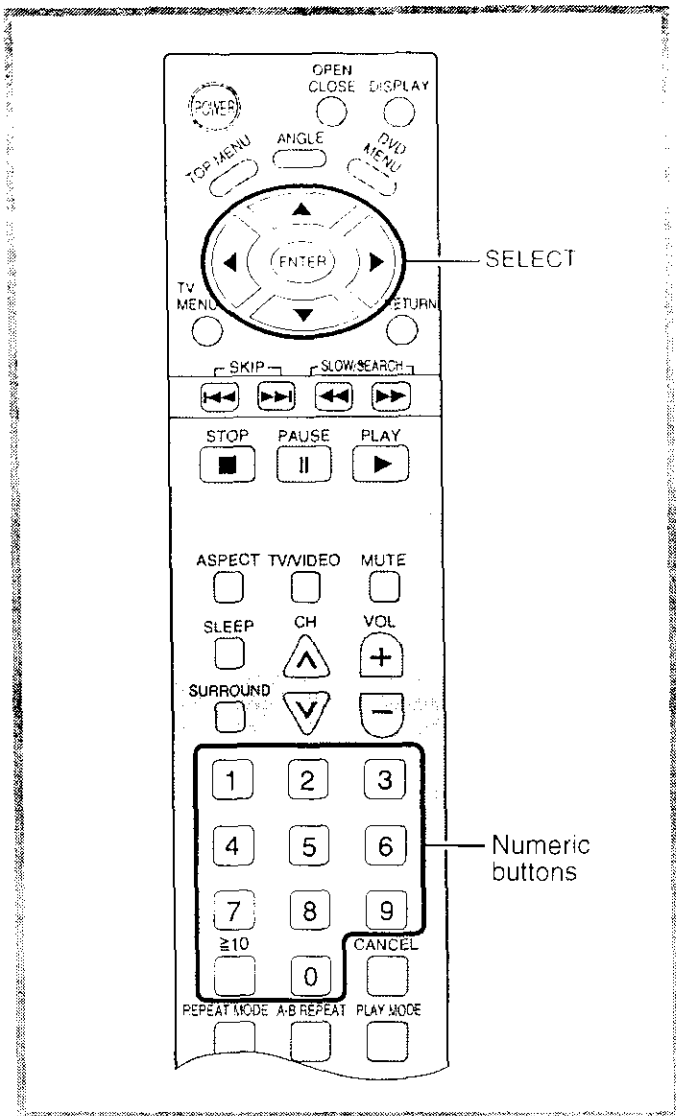

2 Press the SELECT (▲, ▼) button to select the level and press ENTER.

- Level 8:** All DVDs can be played back. (Factory preset)
- Level 7 to 2:** DVDs for general audiences/children can be played back. (DVDs for adults are prohibited.)
- Level 1:** DVDs for children can be played back. (DVDs for adults/general audiences are prohibited.)
- Level 0:** Playback of all DVDs is prohibited (e.g. to prohibit playback of DVDs for adults which are not encoded with rating level information).

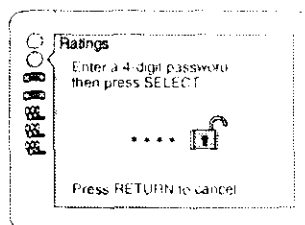

3 When level 7 or lower is selected Input a 4-digit password with the numeric buttons and press ENTER.

The lock symbol appears closed to show the rating is locked.

Example: "4343"

Do not forget your password.

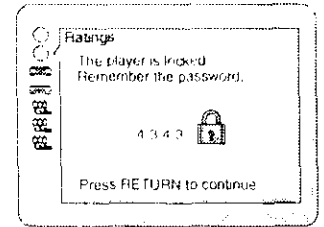

4 Press ENTER.

Setting is finished and the initial settings screen is displayed.

- The rating is locked. Any discs with a higher rating than the setting cannot be played back unless the password is entered.

When the player is locked

The following screen appears when "2 Ratings" is selected at the initial settings screen.

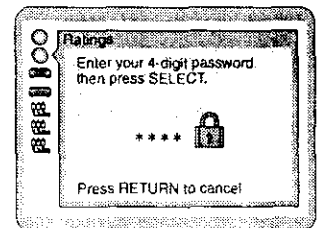

1. Input your 4-digit password and press ENTER.

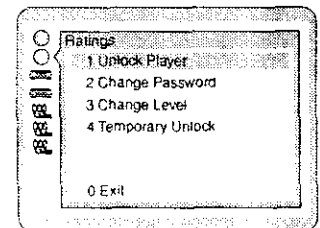

2 To unlock the player

Press "1" and then press ENTER.

To change the password

Press "2", enter a new 4-digit password and press ENTER, then press ENTER again.

To change the rating level Press "3", select a new level with the SELECT (▲, ▼) button, then press ENTER.

To unlock the player temporarily

Press "4" and then press ENTER.

- The rating is unlocked temporarily only for the current disc. The player is locked again when OPEN / CLOSE is pressed or the player is set to the standby mode.

To finish setting without changing the rating level Press "0".

Setting is finished and the initial settings screen is displayed.

Also refer to "Common procedures" on page 56.

Note

- Some discs may not be encoded with specific rating level information though its disc jacket says that it is for "adults". For those discs, the age restriction will not work

Selecting On-Screen Display menu language

This is to select the language to be used in the On-Screen Display menus which the player will show on the TV monitor.

- At the initial settings screen (on page 56)
Press **SELECT** (▲, ▼) to Select "3 Menu Language" and press **ENTER**.

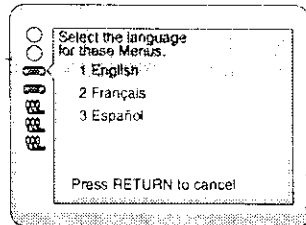







- Press **SELECT** (▲, ▼) to Select the language and press **ENTER**.

- English:
English is selected. (Factory preset)
- Français / 3, Español :
The language is selected.

Setting is finished and the initial settings screen is displayed.

Also refer to "Common procedures" on page 56.

When "2 Color and Position" is selected
The colors and positions are set as follows:

-  Blue (Factory preset)
-  Violet
-  Green
-  Blue
-  Violet
-  Green

The screen illustrated in step 1 is displayed. Select "0" with the **SELECT** (▲, ▼) button and press **ENTER** to return to the initial settings screen.

Also refer to "Common procedures" on page 56.

For your reference:

- When  is selected, "Play", "Still" and other displays as well as GUI screens will be displayed at a little lower position than the factory setting. It is recommended to choose this setting if the screen is only partially displayed.

Selecting On-Screen Display Messages

You can select whether "Play", "Still" and other displays will be displayed or not, and the color and position of "Play", "Still" and other displays as well as GUI screens.

- At the initial settings screen (on page 56)
Press **SELECT** (▲, ▼) to select "4 On-Screen Messages" and press **ENTER**.

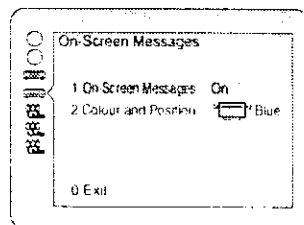

- Press **SELECT** (▲, ▼) to select the setting and press **ENTER**.

When "1 On-Screen Messages" is selected

- On: "Play", "Still" and other displays will always appear on the TV screen (Factory preset)
- Off: "Play", "Still" and other displays will not appear on the TV screen.

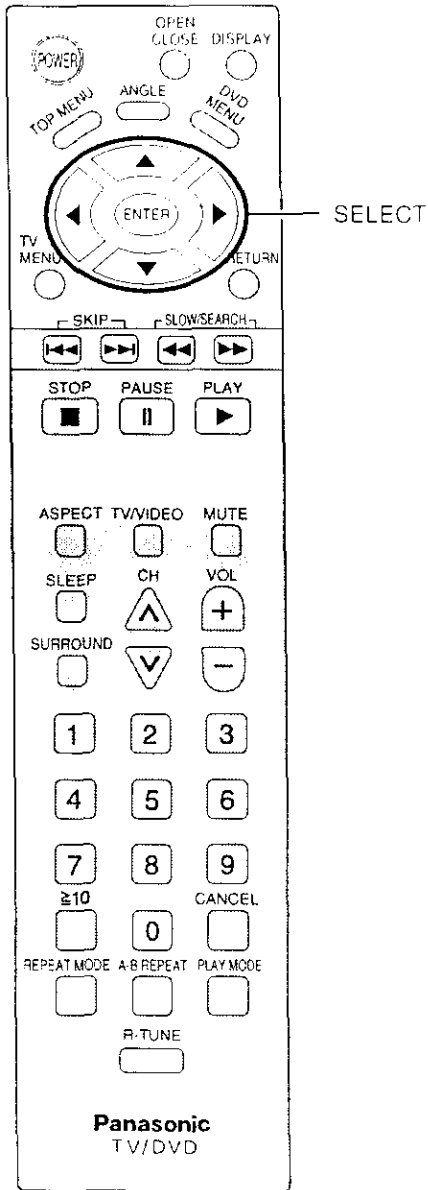

Selecting TV screen Aspect

Select the TV aspect, conventional size screen (4:3) or wide-screen (16:9), when connecting to your TV set.

- 1 At the initial settings screen (on page 56) Press **SELECT** (▲, ▼) to Select "5 TV Aspect" and press **ENTER**.

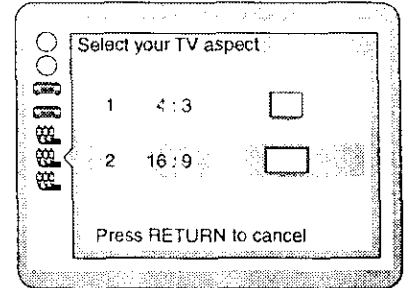

- 2 Press **SELECT** (▲, ▼) to select the TV aspect and press **ENTER**.

- 1 4:3:
Select when a conventional TV set is connected.
- 2 16:9:
Select when a wide-screen TV set is connected.
(Factory preset)

Setting is finished and the initial settings screen is displayed.

Also refer to "Common procedures" on page 56.

For your reference:

- For further details on the images which appear on the TV screen (aspect ratios of the screen), see page 67.

Selecting digital output

Select the digital output to be output from the optical/coaxial digital audio output connector of the player.

- At the initial settings screen (on page 56) Press **SELECT** (▲, ▼) to select "6 Digital Audio Output" and press **ENTER**.

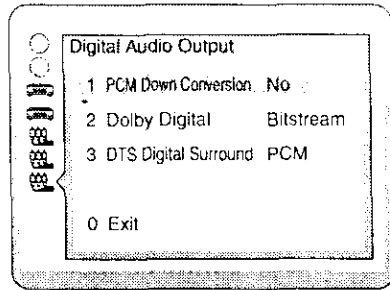

- Press **SELECT** (▲, ▼) to select the item and press **ENTER**.

1 PCM Down Conversion:

To select whether digital audio converted to 48 kHz/16 bit is output from the optical/coaxial digital audio output connector or no digital audio is output during playback of DVDs recorded in 96 kHz Linear PCM.

(If the DVD is recorded in 48 kHz Linear PCM, digital audio converted to 48 kHz/16 bit is output irrespective of the setting.)

2 Dolby Digital:

To select the signal format (Bitstream or PCM) to be output from the optical/coaxial digital audio output connector during playback of DVDs recorded in Dolby Digital.

3 DTS Digital Surround:

To select the signal format (PCM or Bitstream) to be output from the optical/coaxial digital audio output connector during playback of DVDs recorded in dts.

- Press **SELECT** (▲, ▼) to select the setting and press **ENTER**.

When "1 PCM Down Conversion" is selected

- No**: Digital audio of 48 kHz/16 bit is output during playback of DVDs recorded in 48 kHz Linear PCM. No digital audio is output during playback of DVDs recorded in 96 kHz Linear PCM. However, audio will be output using the original audio recording system if the DVD has not been copyright-protected. (Factory preset)
- Yes**: During playback of DVDs recorded in 48 kHz or 96 kHz Linear PCM, digital audio converted to 48 kHz/16 bit is output. (Digital output of PCM audio is restricted to 48 kHz/16 bit or below for copyright protection.)

When "2 Dolby Digital" is selected

- Bitstream**^{**}: Dolby Digital bitstream (1ch-2 PCM; 5.1ch) is output during playback of DVDs recorded in Dolby Digital. (Factory preset) Select this setting when the player is connected to a Dolby Digital decoder.
- PCM**: Digital audio converted to 48 kHz/16 bit PCM (2ch) is output during playback of DVDs recorded in Dolby Digital

When "3 DTS Digital Surround" is selected

- PCM**: Digital audio converted to 48 kHz/16 bit PCM (2ch) is output during playback of DVDs recorded in dts. (Factory preset)
- Bitstream**^{**}: dts bitstream is output during playback of DVDs recorded in dts. Select this setting when the player is connected to a dts decoder.

The screen illustrated in step 1 is displayed. Select "0" with press **SELECT** (▲, ▼) button and press **ENTER** to return to the initial settings screen.

Also refer to "Common procedures" on page 56.

(Continued on the next page)

Recommended setting of "Digital Audio Output"

Make settings as shown in table below depending on the kind of equipment that is connected to the optical/coaxial digital audio output connector.

Type of equipment to be connected	Recommended setting		
	1 PCM Down Conversion	2 Dolby Digital	3 DTS Digital Surround
No equipment is connected	No	<u>Bitstream</u>	<u>PCM</u>
Dolby Digital decoder	Yes ^{**}	<u>Bitstream</u>	<u>PCM</u>
Dolby Digital dts decoder	Yes ^{**}	<u>Bitstream</u>	Bitstream
Dolby Digital dts audio decoder	Yes ^{**}	<u>Bitstream</u>	Bitstream

• Underlined items are factory preset.

^{**} Do not connect to the digital audio input of an amplifier that does not have Dolby Digital/dts audio decoder: if such an amplifier should be connected to the player with "Bitstream" selected at the "2 Dolby Digital", "3 dts", any attempt to play DVDs (or CDs recorded in dts) may cause such a high level of noise that it may be harmful to your ears and damage speakers.

^{**} 96 kHz PCM sound is converted to 48 kHz/16 bit sound when this player is connected with an optical digital audio cable. Do the following if you wish to take advantage of high quality 96 kHz sound.

Select "1 No" and connect this player's audio output connector to an amplifier's audio input connector with the audio/video cable (included) or an audio cable (not included). Note that PCM, Dolby Digital, and dts signals will all be output in 2 channel, analog form.

Speaker setting

- At the initial settings screen (on page 56) Press **SELECT** (▲, ▼) to select "8 Speaker Setting" and press **ENTER**.

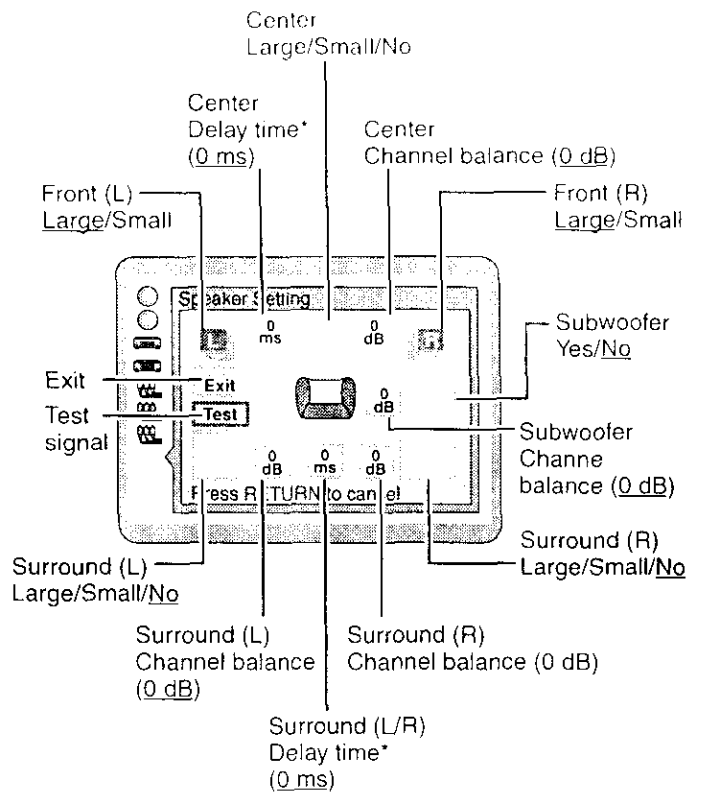
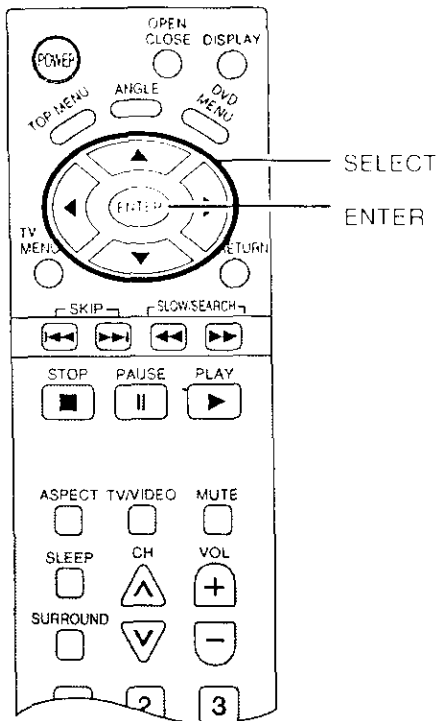

- Underlined items are factory preset.
- * Delay time adjustment is effective only for DVDs recorded in Dolby Digital.

- Press **SELECT** (▲, ▼) to select the item and press **ENTER**.

- Press **SELECT** (▲, ▼) to select the setting and press **ENTER**.

Speaker icons:

- If the speaker is connected, display the icon with press **SELECT** (▲, ▼) button and press **ENTER**.
- If the speaker supports low-frequency (under 100 Hz) reproduction, select the large icon. If the speaker does not support low-frequency reproduction, select the small icon. [When a subwoofer is not connected, be sure to select "Large" for the front speakers (L / R).]

In case of surround speaker (L)

No Large / Yes Small / Yes

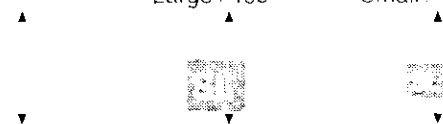

(Continued on the next page)

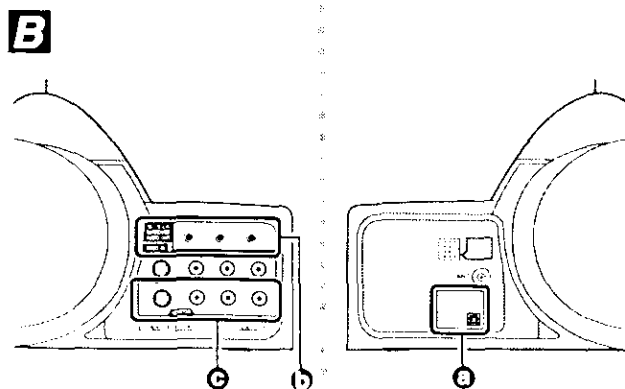
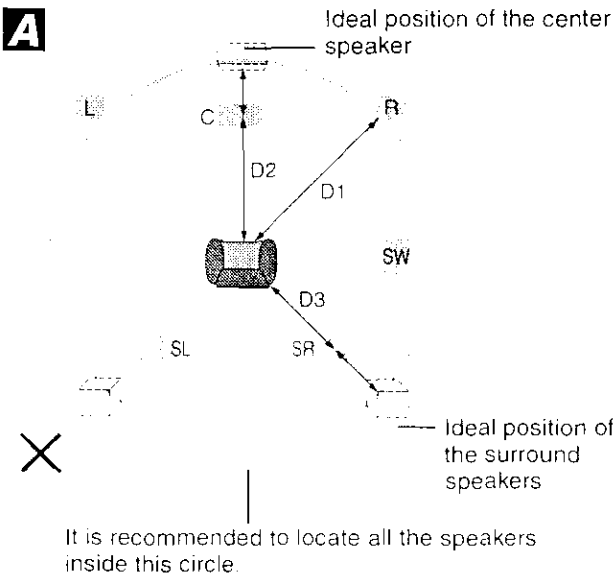

Delay time [only for Dolby Digital discs] (A):

If the surround speakers or the center speaker can't be installed at an equal distance to the front speakers from the listening position, change the delay time to get better surround effect.

- When D2 or D3 is equal to or larger than D1, no setting is necessary. Otherwise, change the setting according to the table below.

Speaker	Difference between D1 and D2 / D3	Delay time
Centers speaker (D2)	approx. 50 cm	1.3 ms
	approx. 100 cm	2.6 ms
	approx. 150 cm	3.9 ms
	approx. 200 cm	5.3 ms
Surround speakers (D3)	approx. 200 cm	5.3 ms
	approx. 400 cm	10.6 ms
	approx. 600 cm	15.9 ms

To adjust the channel balance using the test signal

1. Select "Test" with press SELECT (▲, ▼, ◀, ▶), and then press ENTER.
(Test signals will be output clockwise from each speaker except the subwoofer consecutively.)
2. While listening to the test signal, press SELECT (▲, ▼) button to adjust the volume of each speaker until the test signal is heard at a similar level from all speakers.
3. Press ENTER. (The test signals are stopped.)

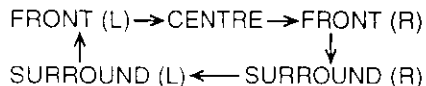

Note

- Test signal is not output from the subwoofer. Subwoofer volume should be adjusted to suit the material being

4 Press SELECT (▲, ▼, ◀, ▶) to select "Exit" and press ENTER.

Setting is finished and the initial settings screen is displayed.

Also refer to "Common procedures" on page 56.

Playing MPEG 2 multi-channel audio (B)

MPEG 2 multi-channel audio is output from the 5.1 channel output connectors (B) if you have set the center, surround and subwoofer speakers to "Yes" in "8 Speaker Setting", just as with Dolby Digital and dts.

If you are using 2 channel audio output connectors (C), the digital audio output connectors (when "1 PCM" is selected in "4 MPEG" in the digital audio output settings on page 61) (D), or the phones jack, however, then only the signals for the front speaker channels are output.

If you intend to use one of these types of terminals, go to "8 Speaker Setting" and set the center, surround, and subwoofer channels to "No".

Speaker setting

Other settings

Compression of the sound's dynamic range and other special settings can be performed.

- 1 At the initial settings screen (on page 56) Press **SELECT** (▲, ▼) to select "9 Other Settings" and press **ENTER**.

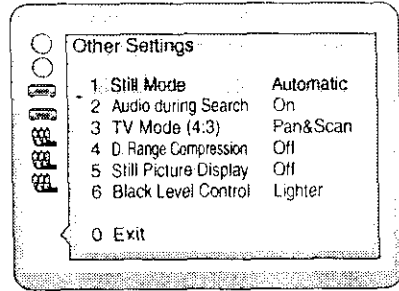

- 2 Press **SELECT** (▲, ▼) to select the item and press **ENTER**.

1 Still Mode:

Select either "Field still" or "Frame still" to prevent jittering or improve the video quality of small text or fine patterns in the still picture mode.

2 Audio during Search:

To select whether audio is heard during search (forward direction) at the initial scan speed or not.

3 TV Mode (4:3):

To select whether wide-screen video material will be played back in the pan and scan style or in the letterbox style on a conventional size TV.

4 D. (Dynamic) Range Compression:

To select the dynamic range during playback.

5 Still Picture Display:

To display the picture type, I, P or B in the still picture mode.

6 Black Level Control:

Adjusts the dark shades of the image in gradation.

- 3 Press **SELECT** (▲, ▼) to select the setting and press **ENTER**.

When "1 Still Mode" is selected

- 1 Automatic: "Field still" and "Frame still" are automatically selected in the still picture mode. (Factory preset)
- 2 Field: "Field still" is always selected. Select this setting when jittering occurs when "1 Automatic" is selected.
- 3 Frame: "Frame still" is always selected. Select this setting when small text or fine patterns cannot be seen clearly when "1 Automatic" is selected.

When "2 Audio during Search" is selected

- 1 On: Audio will be heard during search at the initial scan speed. (Factory preset)
- 2 Off: Select this setting when audio during search at the initial scan speed is not desired.

When "3 TV Mode (4:3)" is selected

- 1 Pan & Scan: Wide-screen video material will be played back in the pan and scan style on a conventional size TV. (Factory preset)
 - Video material not formatted in the pan and scan style will be played back in the letterbox style. (See page 67.)
- 2 Letterbox: Wide-screen video material will be played back in the letterbox style on a conventional size TV.

When "4 D. (Dynamic) Range Compression" is selected

- 1 Off: Normal audio range is selected. (Factory preset)
- 2 On: Select this setting to enjoy dynamic sound at low volume. Dynamic range is the difference in volume between the quietest and loudest sounds. Dynamic Compression limits level for listening at low volume. This is useful late at night. This function only works with Dolby Digital DVD.

When "5 Still Picture Display" is selected

- 1 Off: The picture type (I / P / B) will not be displayed on the TV screen in the still picture mode. (Factory preset)
- 2 On: The picture type (I / P / B) will be displayed on the TV screen in the still picture mode. Since I-Picture features the best picture quality, it is recommended that the screen be frozen with I-Picture when the picture quality is to be adjusted.

When "6 Black Level Control" is selected

Adjusts the dark shades of the image in gradation

- 1 Lighter
- 2 Darker

The screen illustrated in step 1 is displayed. Select "0" with the **SELECT** (▲, ▼) button and press **SELECT** to return to the initial settings screen.

Also refer to "Common procedures" on page 56.

Note

- It is recommended that the "1 PAL 60" is selected at the "6 NTSC Disc Output" when a PAL TV is connected; however, the images shown below will appear on the TV screen. Black bars appear at the top and bottom parts of the TV screen. (The picture may be compressed vertically.)



For your reference:

- When the "2 On" is selected at the "5 Still Picture Display", the following screen is displayed in the still picture mode;

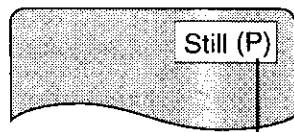

Example: P-Picture

- **Field**
Half of the video information (video signal) in a frame is called a field. With conventional TV systems, a signal frame (a single screen) consists of two fields.
- **Field still**
Only one field (half of the video information) is displayed on the TV screen, so the apparent resolution is low. However, there is no blurring on the screen.
- **Frame**
Individual images in a video or on the TV are called frames.
- **Frame still**
The two fields are displayed, alternately, on the TV screen, so the image is blurry. However, the image quality is better than field images.

- **I/P/B**
The MPEG 2 standard adopted for DVD uses the following 3 picture types for the coding of each picture (frame) on the TV screen.

I:I-Picture (Intra coded picture)

This is the standard picture type, and each picture is coded separately.

P:P-Picture (Predictive coded picture)

This picture type is computed on the basis of a past I-Picture or P-Picture.

B:B-Picture (Bidirectionally-predictive coded picture)

This picture type is computed by comparing the previous and subsequent I-Picture or P-Picture. It has the lowest volume of information.

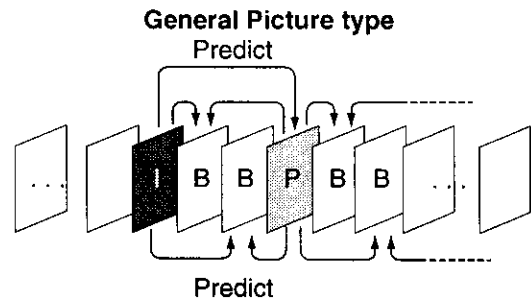

















Language code list

Enter the appropriate code number for the initial settings "Audio", "Subtitle" and/or "Menus" (See page 57)

Code	Language	Code	Language	Code	Language	Code	Language
6565	Afar	7079	Faroese	7678	Lingala	8375	Slovak
6566	Abkhazian	7082	French	7679	Laotian	8376	Slovenian
6570	Afrikaans	7089	Frisian	7684	Lithuanian	8377	Samoan
6577	Ameharic	7165	Irish	7686	Latvian, Lettish	8378	Shona
6582	Arabic	7168	Scots Gaelic	7771	Malagasy	8379	Somali
6583	Assamese	7176	Galician	7773	Maori	8381	Albanian
6588	Aymara	7178	Galician	7775	Macedonian	8382	Serbian
6590	Azerbaijani	7185	Gujarati	7776	Malayalam	8385	Sundanese
6665	Bashkir	7265	Hausa	7778	Mongolian	8386	Swedish
6669	Byelorssian	7273	Hindi	7779	Moldavian	8387	Swahili
6671	Bulgarian	7282	Croatianb	7782	Marathi	8465	Tamil
6672	Bihari	7285	Hungarian	7783	Malay	8469	Telugu
6678	Bengali; Bangla	7289	Armenian	7784	Maltese	8471	Taj i k
6679	Tibetan	7365	Interlingua	7789	Burmese	8472	Thai
6682	Breton	7378	Indonesian	7865	Nauru	8473	Tigrinya
6765	Catalan	7383	Icelandic	7869	Nepali	8475	Turkmen
6779	Corsican	7384	Italian	7876	Dutch	8476	Tagalog
6783	Czech	7387	Hebrew	7879	Norwegian	8479	Tonga
6789	Welsh	7465	Japanese	7982	Oriya	8482	Turkish
6865	Danish	7473	Yiddish	8065	Punjabi	8484	Tatar
6869	German	7487	Javanese	8076	Polish	8487	Tw i
6890	Bhutani	7565	Georgian	8083	Pashto, Pushto	8575	Ukrainian
6976	Greek	7575	Kazakh	8084	Portuguese	8582	Urdu
6978	English	7576	Greenlandic	8185	Quechua	8590	Uzbek
6979	Esperanto	7577	Cambodian	8277	Rhaeto-Rmance	8673	Vietnamese
6983	Spanish	7578	Kannada	8279	Romanian	8679	Volap k
6984	Estonian	7579	Korean	8285	Russian	8779	Wolof
6985*	Basque	7587	Kashmiri	8365	Sanskrit	8872	Xhosa
7065	Persian	7585	Kurdish	8368	Sindhi	8979	Yoruba
7073	Finnish	7589	Ki rghiz	8372	Serbo-Croatian	9072	Chinese
7074	Fiji	7665	Latin	8373	Singhalese	9085	Zulu

How images appear on your TV (aspect ratios of the screen)

The Images on the TV screen depend on the type of software and the TV set

Type of software	TV set (Screen mode)			
	4:3	16:9 ("FULL" mode)	16:9 ("ZOOM" mode)	16:9 ("AUTO" mode)
Wide-screen (pan and scan format) 	Right and left edges are cut off 	Full screen 	Top and bottom edges are cut off 	Full screen 
Wide-screen (pan and scan format) 	Letterbox (with black bands at top and bottom) 			
Software (4:3) 	Full screen 	Screen horizontally enlarged 	Top and bottom edges are cut off. 	Full screen (with black bands at right and left) 
Software (4:3, Letterbox) 	Letterbox (with black bands at top and bottom) 	Screen horizontally enlarged (with black bands at top and bottom) 	Full screen 	Screen in which the picture at the far left and far right ends only is extended horizontally (with black bands at top and bottom) 

• The images which appear on the TV screen, and what each screen mode is called, depend on the manufacturer of the TV set and type of TV set. Consult the instruction manual provided with your TV set.

For your reference:

- **Letterbox**
Black bands are inserted at the top and bottom of the screen to fill in the gaps where the size of the picture is smaller than the screen.
- **Pan and scan**
Part of the wide-screen picture (either at both sides or one side of the screen) is automatically eliminated so that the picture fills the whole screen.

Troubleshooting

Before requesting service for this LCD/DVD combo, check the chart below for a possible cause of the problem you are experiencing. Some simple checks or a minor adjustment on your part may eliminate the problem and restore proper operation. If you are in doubt about some of the check points, or if the remedies indicated in the chart do not solve the problem, consult your dealer for instructions.

Symptoms (Common)	Checks	Page
Power does not turn ON	<ul style="list-style-type: none"> ● Is the power plug plugged in? ● Is the AC adapter plug securely connected to the unit? ● If the power does not turn on using the remote, check if the TV set is turned on. 	– 13
Remote control does not function	<ul style="list-style-type: none"> ● Are the batteries dead or inserted incorrectly? ● Is the remote control sensor in direct light of florescent lamps or other strong sources of light? 	7 –
Image shakes Image is not clear or no color	<ul style="list-style-type: none"> ● Is the antenna cable connected properly? ● When using a VCR and selecting channels on the TV, is the TV/VIDEO mode for the VCR set to TV? 	8, 9 25
Image appears doubled or tripled.	<ul style="list-style-type: none"> ● Check cable signal, connections or wire. 	–
A black stripe appears for a moment when changing channels using the VCR.	<ul style="list-style-type: none"> ● The image distorts when channels are changed. 	–
Images disappear at the top and bottom of the screen	<ul style="list-style-type: none"> ● When using 16:9 image software, there is no picture at the top and bottom of the screen (cinema vision size software, etc.). 	–
During ZOOM or JUST modes, the image is cut off at the top and bottom.	<ul style="list-style-type: none"> ● Has the screen position been changed? → If so, adjust screen positioning. 	–
Channel number remains displayed.	<ul style="list-style-type: none"> ● Press the DISPLAY button. During VIDEO input, channel number is displayed until an image is displayed. 	21
Play fails to start even when PLAY is pressed. Play starts but then stops immediately.	<ul style="list-style-type: none"> ● Condensation has formed: wait about 1 to 2 hours for it to evaporate. ● This player cannot play discs other than DVDs, Video CD and CD. ● The disc may be dirty and may require cleaning. ● Ensure that the disc is installed with the label of the side to be played facing upwards. 	–
There may be red spots, blue spots and green spots on the screen.	<ul style="list-style-type: none"> ● This is a characteristic of liquid crystal panels and is not a problem. The liquid crystal panel is built with very high precision technology giving you fine picture details. Occasionally, a few non-active pixels may appear on the screen as a fixed point of blue, green, or red. Please note the this does not affect the performance of your LCD TV. 	–

Symptoms (DVD)	Checks	Page
No subtitles.	<ul style="list-style-type: none"> ● Subtitles appear only with discs which contain them. 	–
Alternative audio soundtrack (or subtitle) languages fail to be selected.	<ul style="list-style-type: none"> ● An alternative language is not selected with discs which do not contain more than one language. ● In the case of some discs, the alternative language cannot be selected. Try selecting it from the DVD menu if one is available. 	45
Angle cannot be changed.	<ul style="list-style-type: none"> ● This function is dependent on software availability. Even if a disc has a number of angles recorded, these angles may be recorded for specific scenes only. 	–
Play does not start even when title is selected.	<ul style="list-style-type: none"> ● Confirm the “2 Ratings” setting. 	57
Audio soundtrack and/or subtitle language is not the one selected at the initial settings.	<ul style="list-style-type: none"> ● If the audio soundtrack and/or subtitle language does not exist on the disc, the language selected at the initial settings will not be seen/heard. 	–
The menu is displayed in French (example).	<ul style="list-style-type: none"> ● The setup “3 Menus” of “1 Disc Languages ” is set to French: select English. 	57
No surround sound.	<ul style="list-style-type: none"> ● Choose the setting at “8 Speaker Setting” which matches our speaker system. ● No surround sound is output when the virtual surround effect is activated (“VSS 1”, “VSS 2”, “Headphone VSS 1” or “Headphone VSS 2”). Select “VSS OFF” or “Headphone VSS OFF”. 	62 28-29

Symptoms (Video CD)	Checks	Page
No menu play.	This function works only for Video CDs with playback control.	43

Maintenance

Do not wipe the LCD with water

Clean the LCD using a dry soft cloth such as gauze. If the LCD is heavily soiled, apply OA cleaner for LCD panels to the cloth and wipe off gently. Do not use keton chemicals such as acetone, solvents such as xylene or toluene, or water.

Wipe the cabinet with a soft cloth

If the cabinet is heavily soiled, wipe with a well-wrung soft cloth dipped in kitchen cleanser (neutral) diluted with water.

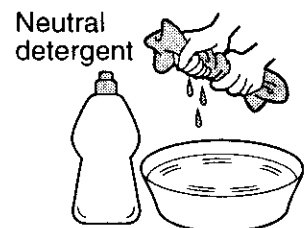

CAUTION :

If water or similar substances get inside the monitor via the liquid crystal panel surface, a malfunction may result.

Specifications

Power Source		AC 120 V, 60 Hz	
Power Consumption		Average use : 54 W (Maximum Current 3.62 A) Stand-by condition : 0.45 W	
LCD		TFT 15.2-inch, 16 : 9 aspect ratio, 854 × 480 dots, 409,920 pixel	
Screen Size		13.19 " (335 mm) (W) × 7.4 " (188 mm) (H) × 15.12 " (384 mm) (DIAGONAL)	
Channel Capability-181		VHF-12 : UHF-56 : Cable-125	
Sound	Speaker	3 " 5/32 (8 cm) × 2	
	Audio Output	6 W [3 W + 3 W] (10 % THD) Power Frequency Response 35 Hz ~ 16 kHz	
	Headphones	M3 (3.5 mm) Jack (16 Ω ~ 32 Ω)	
FEAUTURES		DVD Player CLOSED CAPTION	3D Y/C FILTER V-Chip
Disc Played		DVD-VIDEO/DVD-AUDIO disc 12 cm single-sided, single-layer 12 cm single-sided, dual-layer 12 cm double-sided, single-layer 8 cm single-sided, single-layer 8 cm single-sided, dual-layer 8 cm double-sided, single-layer	COMPACT disc (CD-DA, VIDEO CD) 12 cm disc 8 cm disc
Accessories Supplied			
Remote control Transmitter		TNQE262	Battery : AAA (R03) Battery × 2
AC Adaptor		AC Adaptor : N0JEHK000001	AC Cord : K2CA2EA00005
Operating Conditions		Temperature : 42 °F - 95 °F (5 ° - 35 °C) Humidity : 20 % - 80 % (non-condensing)	
Connection Terminals			
VIDEO INPUT		S-VIDEO (Mini DIN 4Pin) VIDEO (Pin Jack) AUDIO L-R (Pin Jack × 2)	Y : 1.0 Vp-p (75 Ω) C : 0.286 Vp-p (75 Ω) 1.0 Vp-p (75 Ω) 0.5 Vrms
AUDIO OUT		5.1 ch SURROUND AUDIO OUT FRONT L/R : STEREO M3 JACK SURROUND L/R : STEREO M3 JACK CENTER/SUBWOOFER : STEREO M3 JACK	
Dimensions (W × H × D)		15.24 " (387 mm) × 14.69 " (373 mm) × 8.9 " (226 mm)	
Weight (Mass)		approx. 21.19 lb. (approx. 9.6 kg) Net	

Note

- Design and Specifications are subject to change without notice. Weight and Dimensions shown are approximate.

