

Panasonic®

22" LCD TV Operating Instructions

Model No.

TC-22LT1

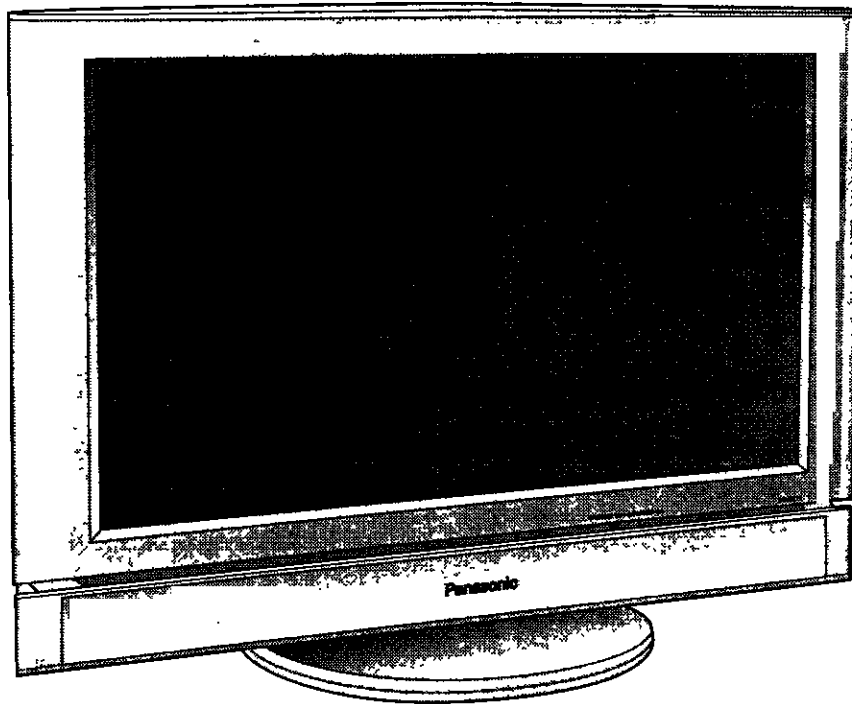

For assistance, please call : 1-800-211-PANA (7262)

or send e-mail to : consumerproducts@panasonic.com

or visit us at www.panasonic.com

(U.S.A)

For assistance, please call : 787-750-4300

(Puerto Rico)

Before connecting, operating or adjusting this product, please read these instructions completely. Please keep this manual for future reference.

Important Safety Instructions

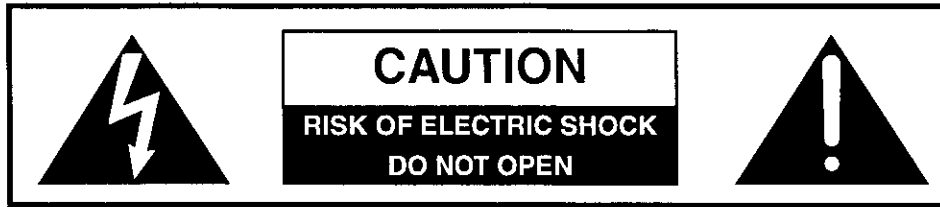

The lightning flash with arrow-head within a triangle is intended to tell the user that parts inside the product are a risk of electric shock to persons.



The exclamation point within a triangle is intended to tell the user that important operating and servicing instructions are in the papers with the appliance.

Note to CATV System Installer: This reminder is provided to direct the CATV system installer's attention to Article 820-40 of the NEC that provides guidelines for proper grounding and, in particular, specifies that the cable ground shall be connected to the grounding system of the building, as close to the point of cable entry as practical.

Important Safety Instructions for LCD TV

- 1) Read these instructions and apply them with your LCD TV.
- 2) Keep these instructions.
- 3) Heed all warnings.
- 4) Follow all instructions.
- 5) Do not use this apparatus near water. For example: Avoid placing it near a bathtub, washbowl, kitchen sink, or laundry tub, in a wet basement, or near a swimming pool, etc.
- 6) Clean only with dry cloth. Unplug this LCD TV from the wall outlet before cleaning. Do not use liquid or aerosol cleaners.
- 7) Do not block any ventilation openings. Install in accordance with the manufacturer's instructions.
Slots and openings in the cabinet and the back or bottom are provided for ventilation, and to insure reliable operation of the LCD TV and to protect it from overheating. These openings must not be blocked or covered. There should be at least 10 cm of space from these openings. The openings should never be blocked by placing the LCD TV on a bed, sofa, rug or other similar surface. This LCD TV should not be placed in a built-in installation such as a bookcase unless proper ventilation is provided.
- 8) Do not install near any heat sources such as radiators, heat registers, stoves, or other apparatus (including amplifiers) that produce heat.
- 9) Protect the power cord from being walked on or pinched particularly at plugs, convenience receptacles, and the point where they exit from the apparatus.
- 10) Only use attachments/accessories specified by the manufacturer. Otherwise it may cause hazards.
- 11) Use only with the cart, stand, tripod, bracket, or table specified by the manufacturer, or sold with the apparatus. When a cart is used, use caution when moving the cart/apparatus combination to avoid injury from tip-over.
- 12) Unplug this apparatus during lightning storms or when unused for long periods of time. This will prevent damage to the receiver due to lightning and power-line surges.
- 13) Refer all servicing to qualified service personnel. Servicing is required when the apparatus has been damaged in any way, such as power-supply cord or plug is damaged, liquid has been spilled or objects have fallen into the apparatus, the apparatus has been exposed to rain or moisture, does not operate normally, or has been dropped.
Upon completion of any service or repairs to this LCD TV, ask the service technician to perform routine safety checks to determine that the television is in safe operating condition.
- 14) Operate only from the type of power source indicated on the marking label. If you are not sure of the type of power supplied to your home consult your television dealer or local power company.
- 15) Follow all warnings and instructions marked on the LCD TV.
- 16) Never push objects of any kind into this LCD TV through cabinet slots as they may touch dangerous voltage points or short out parts that could result in a fire or electric shock. Never spill liquid of any kind on the LCD TV.



Important Safety Instructions

17) If an outside antenna is connected to the television equipment, be sure the antenna system is grounded so as to provide some protection against voltage surges and built up static charges. In the U.S. Selection 810-21 of the National Electrical Code provides information with respect to proper grounding of the mast and supporting structure, grounding of the lead-in wire to an antenna discharge unit, size of grounding conductors, location of antenna discharge unit, connection to grounding electrodes, and requirements for the grounding electrode.

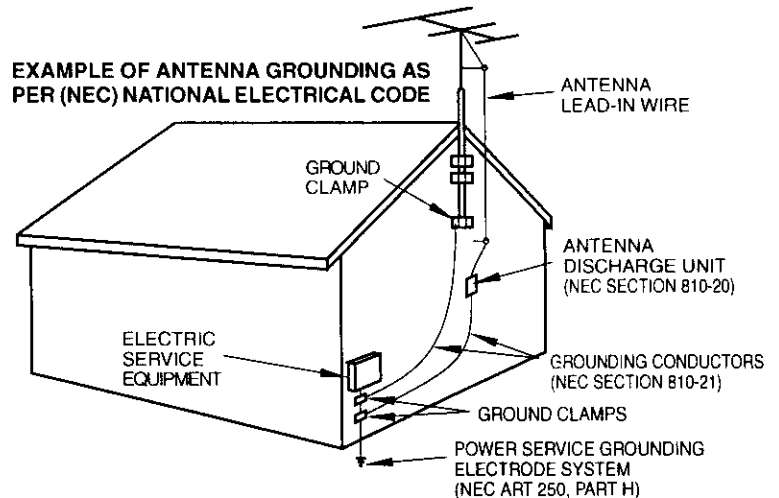

18) An outside antenna system should not be located in the vicinity of overhead power lines or other electric light or power circuits, or where it can fall into such power lines or circuits. When installing an outside antenna system extreme care should be taken to keep from touching such power lines or circuits as contact with them might be fatal.

- 19) Unplug this LCD TV from the wall outlet, and refer servicing to qualified service personnel under the following conditions:
- When the power cord or plug is damaged or frayed.
 - If liquid has been spilled into the LCD TV.
 - If the LCD TV has been exposed to rain or water.
 - If the LCD TV does not operate normally by following the operating instructions.

Adjust only those controls that are covered by the operating instructions as improper adjustment of other controls may result in damage and will often require extensive work by a qualified technician to restore the LCD TV to normal operation.

- If the LCD TV has been dropped or the cabinet has been damaged.
 - If the LCD TV exhibits a distinct change in performance - this indicates a need for service.
- 20) When replacement parts are required, be sure the service technician to use replacement parts specified by the manufacture that have the same characteristics as the original part. Unauthorized substitutions may result in fire, electric shock, or other hazards.
- 21) **WARNING: TO REDUCE THE RISK OF FIRE OR ELECTRIC SHOCK, DO NOT EXPOSE THIS APPARATUS TO RAIN OR MOISTURE.**
- 22) **CAUTION: TO PREVENT ELECTRIC SHOCK DO NOT USE THIS PLUG WITH A RECEPTACLE OR OTHER OUTLET UNLESS THE BLADES CAN BE FULLY INSERTED TO PREVENT BLADE EXPOSURE.**
- 23) **CAUTION: USE WITH OTHER STAND IS CABABLE OF RESULTING IN INSTABILITY CAUSING POSSIBLE INJURY.**
- 24) **CAUTION: DANGER OF EXPLOSION IF BATTERY IS INCORRECTLY REPLACED. REPLACE ONLY WITH THE SAME OR EQUIVALENT TYPE.**

NOTE: ● This equipment is designed to operate in the U.S.A. and other countries where the broadcasting system and AC house current is exactly the same as in the U.S.A.

- The marking or retained image on the LCD panel resulting from fixed image use is not an operating defect and as such is not covered by Warranty. This product is not designed to display fixed image patterns for extended periods of time.

Important Information Regarding Use of Video Games, Computers, Caption or Other Fixed Image Displays.

The extended use of fixed image program material can cause a permanent "shadow image" on the LCD panel.

This background image is viewable on normal programs in the form of a stationary fixed image. This type of irreversible LCD panel deterioration can be limited by observing the following steps:

- Reduce the brightness/contrast setting to a minimum viewing level.
- Do not display the fixed image for extended periods of time.
- Turn the power off when not in actual use.

Dear Panasonic Customer

Welcome to the Panasonic family of customers. We hope that you will have many years of enjoyment from your new 22" LCD TV.

To obtain maximum benefit from your set, please read these Instructions before making any adjustments, and retain them for future reference.

Retain your purchase receipt also, and note down the model number and serial number of your set in the space provided on the rear cover of these instructions.

<p>For assistance, please call : 1-800-211-PANA (7262) or send e-mail to : consumerproducts@panasonic.com or visit us at www.panasonic.com (U.S.A)</p>
--

<p>For assistance, please call : 787-750-4300 (Puerto Rico)</p>
--

<p>Federal Communication Commission Information</p>

This equipment has been tested and found to comply with the limits for a TV Broadcast Receiver, pursuant to Part 15 of the FCC Rules. These limits are designed to provide reasonable protection against harmful interference in a residential installation. This equipment generates, uses and can radiate radio frequency energy and, if not installed and used in accordance with the instructions, may cause harmful interference to radio communications. If this equipment does cause or receive interference, which can be determined by turning equipment off and on, the user is encouraged to try to correct the interference by one of the following measures:

- Reorient or relocate the TV antenna.
- Increase the separation between TV and other equipment.
- Connect TV into separate outlet from other equipment.
- Consult the dealer or an experienced radio/TV technician for help.

FCC Caution: Any changes or modifications not expressly approved by the party responsible for compliance could void the user's authority to operate this equipment.

Table of Contents

Important Safety Instructions	2	ASPECT Controls	18
Federal Communication Commission Information	4	Playing a VCR or other peripheral equipment	19
SUPPLIED ACCESSORIES	5	Picture Adjustments	20
Installation	6	Audio Adjustments	22
Receiver Location	6	MUTE	23
Optional External Equipment	6	Adjusting screen position and size	24
For optimum quality picture	6	Closed Captions	25
How to use the LCD stand	6	Lock Feature	26
Remote control battery installation	7	Customizing the VIDEO INPUT labels	29
AC Adaptor installation	7	Adjusting unnatural video images (3D Y/C FILTER)	30
Connecting the Antenna Cable to the RF In Terminal	8	Natural Color	30
How to connect the input terminals	10	Video Noise Reduction	31
How to connect the AUDIO OUT Terminals	11	Automatically changing screen size for VIDEO INPUT modes	31
Connecting Headphones / Earphones	11	When the top and bottom of the screen noise (IMAGE ADJ.)	32
Basic Controls	12	Attaching and removing the connection terminal cover	33
Controls and Turn the Power On	13	Troubleshooting	34
Flow Chart of MENU	14	Maintenance	34
Tuning channels (Automatic channel programming)	16	Specifications	35
Tuning channels (Manual channel programming)	17		

SUPPLIED ACCESSORIES

Check the accessories before installations.

- Operating Instruction book (TQBE0427)

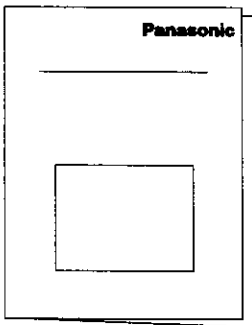

- Remote Control Transmitter with lithium battery (N2QAFC000006)

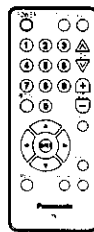

- F Type Antenna Adapter (K1SGABCA0001)



- Warranty Card/ Service Center List

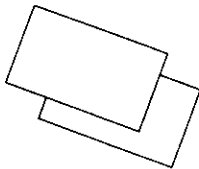

- AC Adaptor & AC Cord
AC Adaptor: (N0JZHK000004)
AC Cord: (K2CA2EA00005)

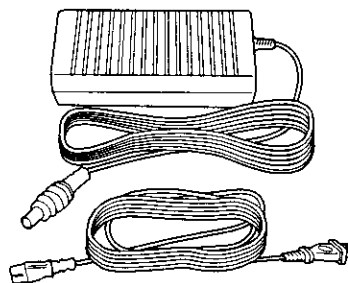

- D-Y/P_B/P_r Conversion Cable (K2KZ9DB00001) × 2

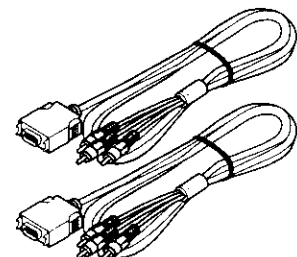

- Connection terminal cover

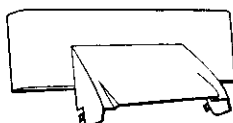

Installation

Receiver Location

Locate for comfortable viewing. Avoid placing where sunlight or other bright light (including reflections) will fall on the screen. Use of some types of fluorescent lighting can reduce remote control transmitter range.

Adequate ventilation is essential to prevent internal component failure. Keep away from areas of excessive heat or moisture. To insure optimum picture do not position magnetic equipment (motors, fans, other speakers, etc.) nearby.

Optional External Equipment

The Video/Audio connection between components can be made with shielded video and audio cables. For best performance, Antenna cables should utilize 75 ohm coaxial shielded wire. Cables are available from your dealer or electronic supply store. Before you purchase any cables, be sure you know what type of output and input connectors your various components require. Also determine the length of-cable you'll need.

For optimum quality picture

When the LCD is exposed to light from outdoors or lighting fixtures, high-contrast pictures may not be displayed clearly. Turn off florescent lamps near the LCD and place in a location not exposed to outdoor light.

How to use the LCD stand

Adjust the stand to your desired angle. The stand angle can be adjusted between 0° to 15° back, 30° left and 30° right.

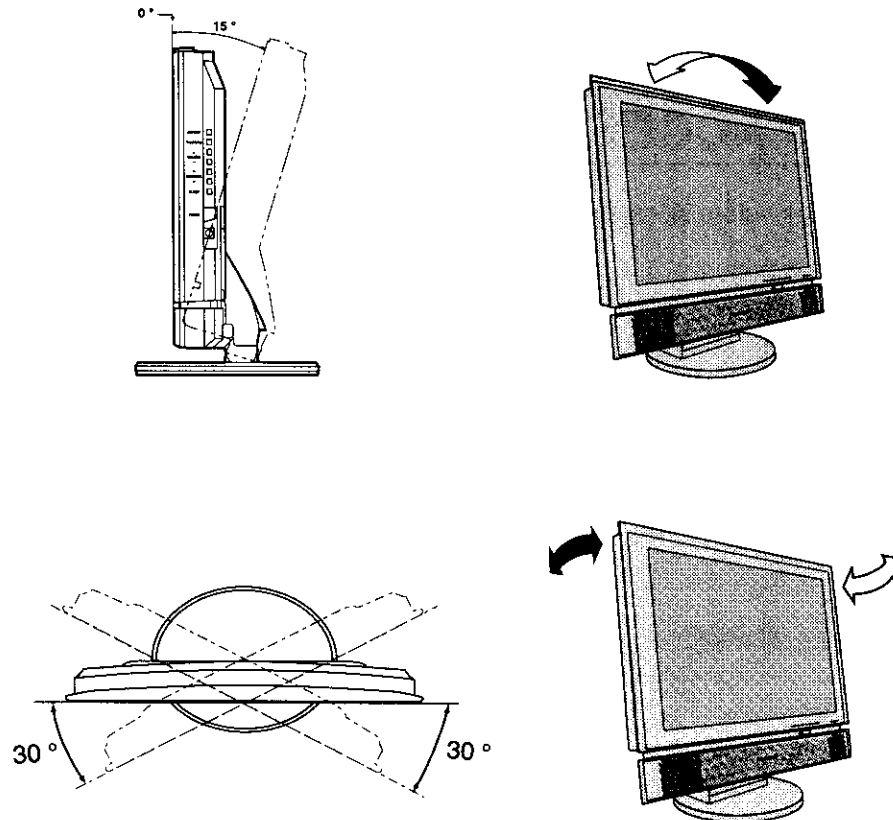

Remote control battery installation

Remove the insulation sheet.

The lithium battery is included in the remote control at the time of delivery.
Remove the insulation sheet to operate the remote control.

Back of the Remote Control

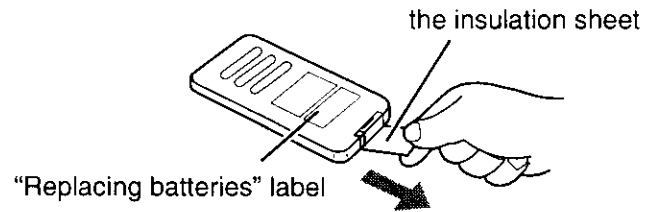

Replacing batteries

Replace batteries by following the steps below:

Requires a CR2025 battery

1. Draw out the battery tray by sliding latch 1 and pulling in the direction of 2 as shown below.
2. Remove battery as shown below. Install the battery in the battery tray. (Confirm that the positive pole marked “+” is facing up.)
3. Replace the tray and slide back the latch until it snaps in place.

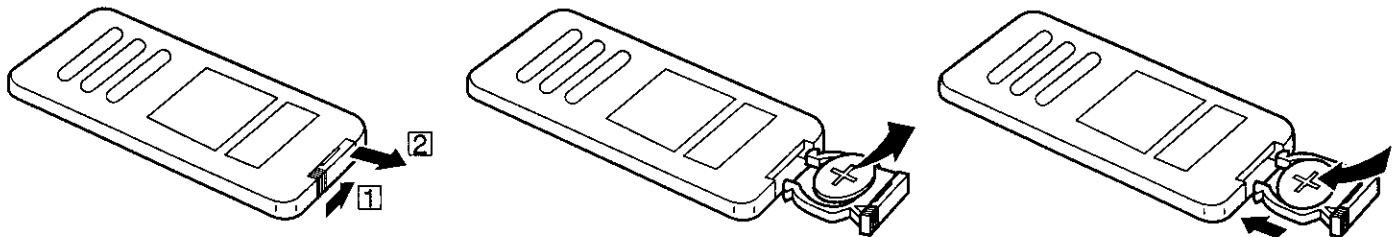

⚠ Caution

Keep batteries out of children’s reach. If batteries are swallowed, contact a physician immediately.

⚠ Precaution on battery use

Incorrect installation can cause battery leakage and corrosion that will damage the remote control transmitter.

Observe the following precautions:

1. Always use new batteries when replacing the old set.
2. Do not attempt to charge, short-circuit, disassemble, heat or burn used batteries.
3. Battery replacement is necessary when remote control acts sporadically or stops operating this unit.

Notes:

- Do not drop, apply shock or step on the remote control.
- Do not spill water on the remote control.
- Do not place objects between the remote control and remote control receiver.
- Do not use remote controls for other equipments at the same time.
- If the TV does not operate even when operating the remote control from a close range, it is time to replace the batteries (product number: CR2025).
Refer to the label on back of the remote control for directions on replacing batteries.

AC Adaptor installation

- Be sure to use the power cord and AC adaptor (model no. : N0JZHK000004) included in the accessories.
- Usage of AC adaptors other than specified may cause malfunctions.

Installation

Connecting the Antenna Cable to the RF In Terminal

Antenna Connection - For proper reception of VHF/UHF channels, an external antenna is required. For best reception an outdoor antenna is recommended. Antenna Mode must be set to TV.

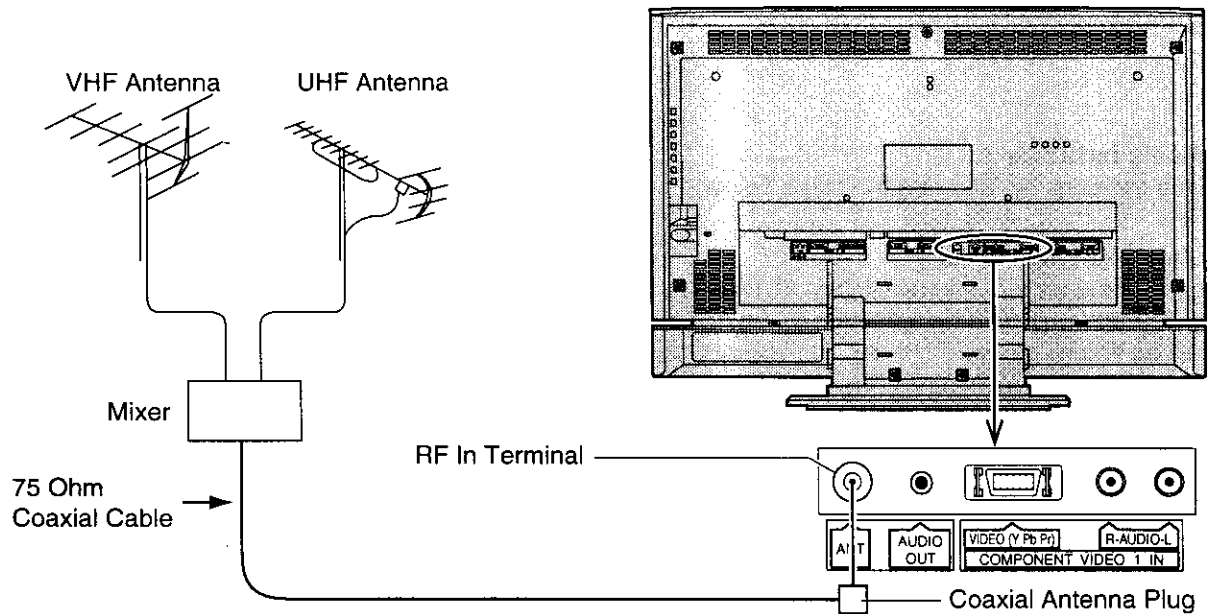

Antenna / Cable Connection

- Incoming Cable From Home Antenna (75 Ohm)

- Incoming 75 Ohm Cable (From Cable Company)

Cable Connection - For reception of cable channels (01 - 125) connect the cable supplied by your local cable company. Antenna Mode must be set to CABLE. (Refer to Antenna Mode section.)

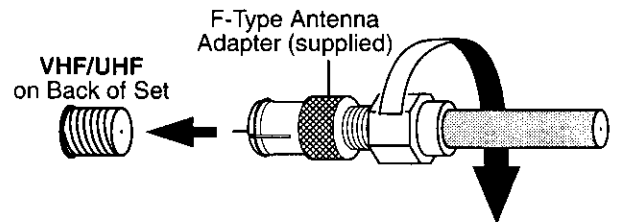

Note:

Certain cable systems offset some channels to reduce interference or have Premium (scrambled) channels. A cable converter box is required for proper reception. Check with your local Cable company for its compatibility requirements.

Refer to page 33 for details on attaching and removing the connection terminal cover.

Antenna Connection (Cable Box, no VCR)

Use this configuration when connecting the TV to a cable TV system using a Cable Box.

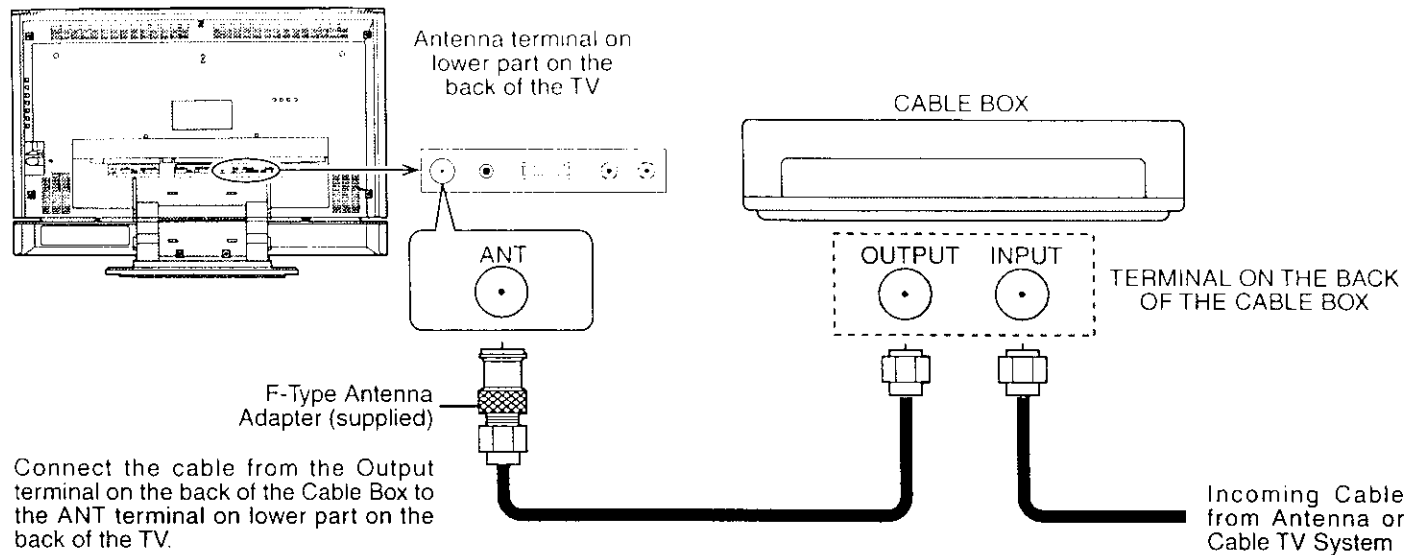

Antenna Connection (Cable Box, and VCR)

Use this configuration when connecting the TV to a cable TV system using a Cable Box and VCR.

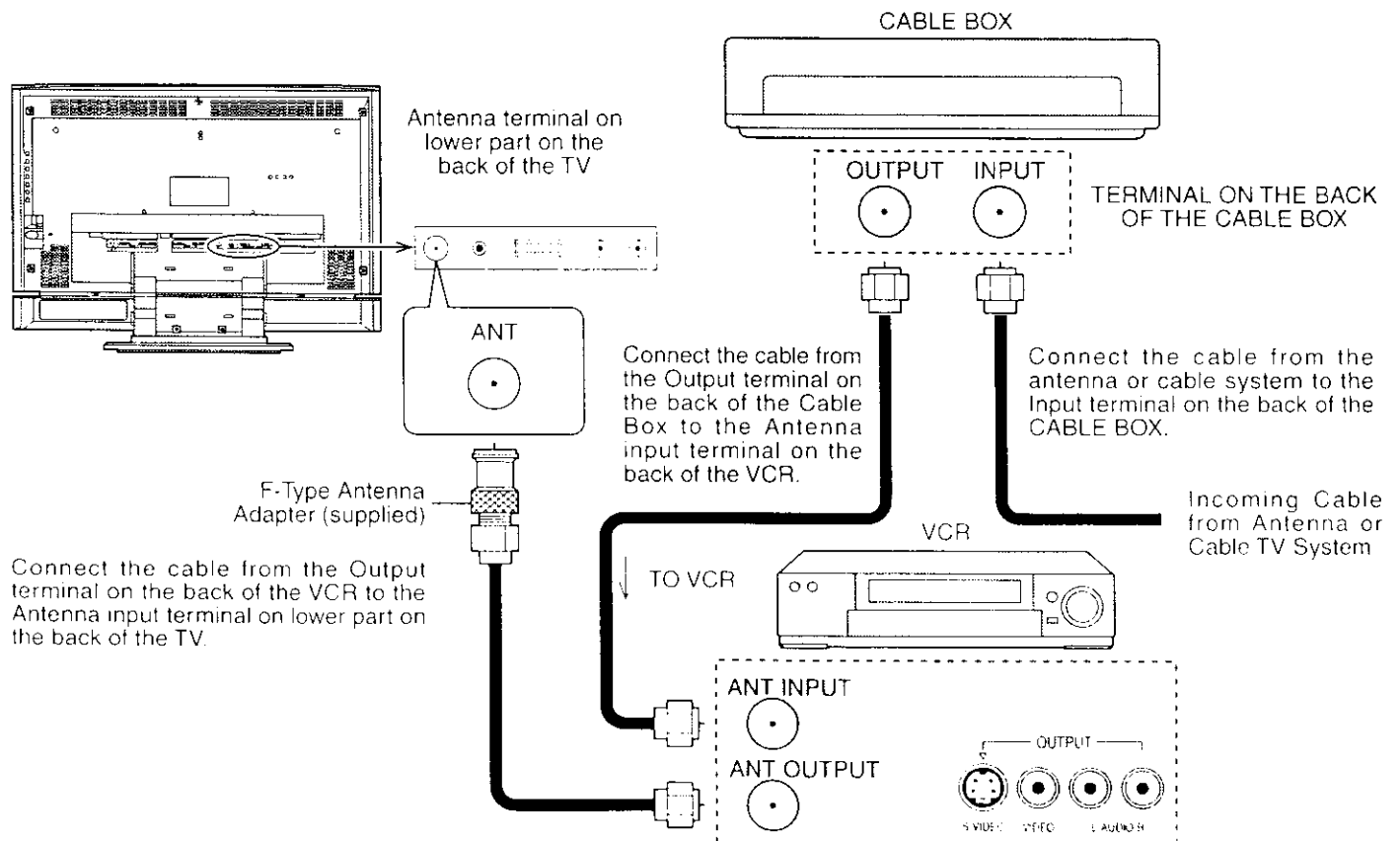

Note: When the antenna cable is connected to the TV antenna terminal via a cable box or VCR, set the TV channel to CH3 or CH4, cable. This does not apply when signal is input from VIDEO INPUT.

Installation

How to connect the input terminals

Connects VCRs and other peripheral equipment

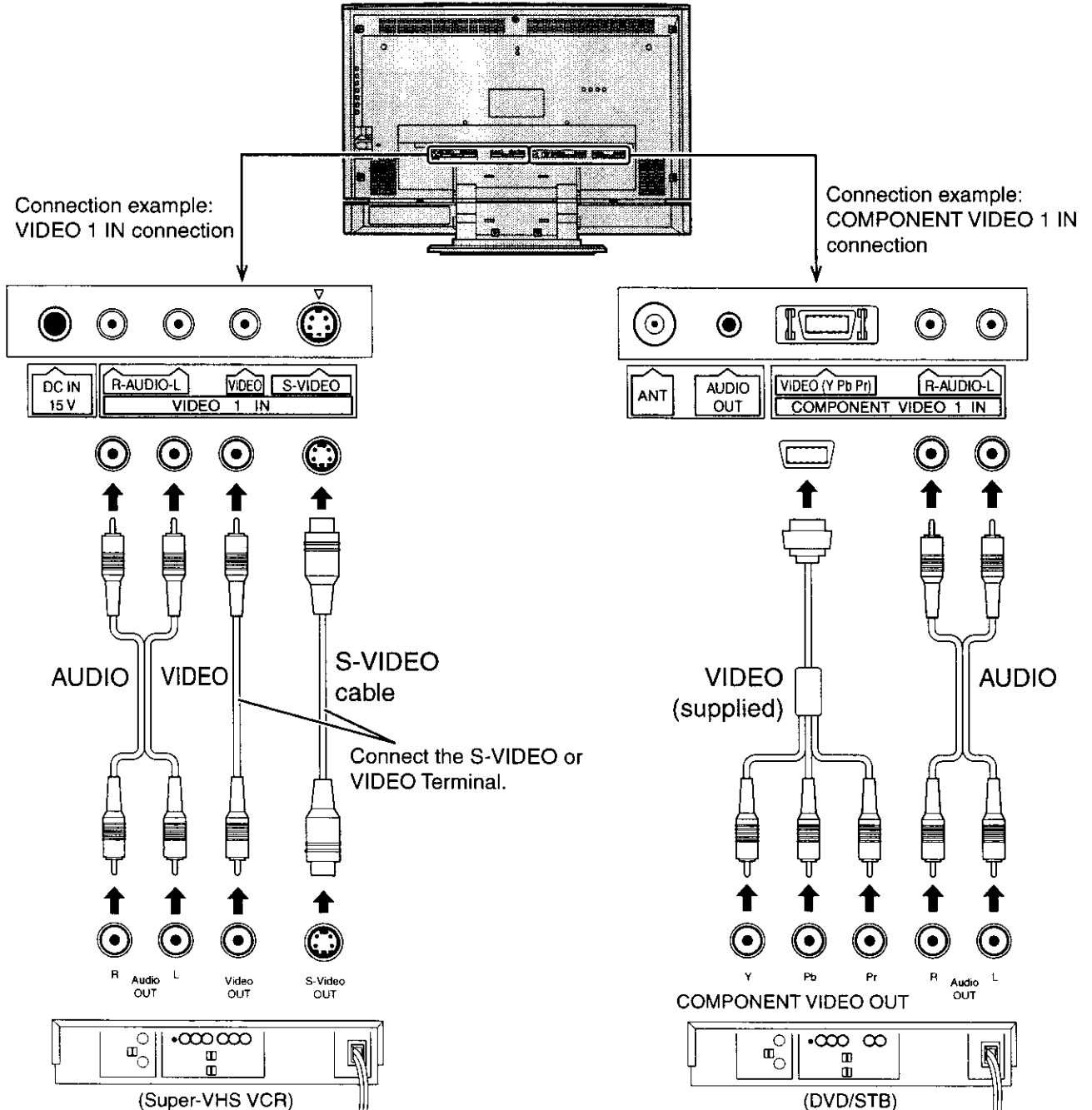

Notes:

- (1) When a monaural VCR is used, connect the monaural audio cable to the AUDIO-L (Left) terminal.
- (2) Similar connections are available at the INPUT terminals.
Select the desired VIDEO input position by pushing the TV/VIDEO button. (See page 19)
- (3) When connecting video cables, priority is given to the S-Video cable when the S-Video input terminal and the video input terminal are connected at the same time.

How to connect the AUDIO OUT Terminals

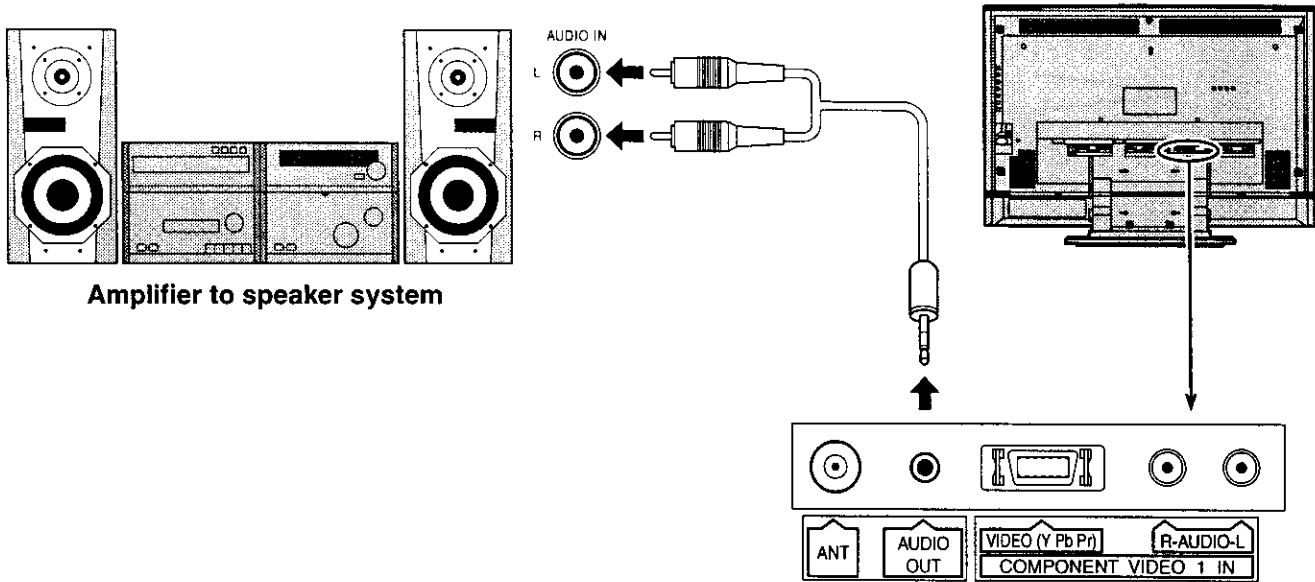

Amplifier to speaker system

Note:

The volume control output of the LCD TV will fix. (SOUND, ADJUST, VOLUME UP/DOWN and SURROUND ON/OFF are not functional for output signals from the AUDIO OUT terminals.)

Connecting Headphones / Earphones

Connect headphones / earphones as follows.

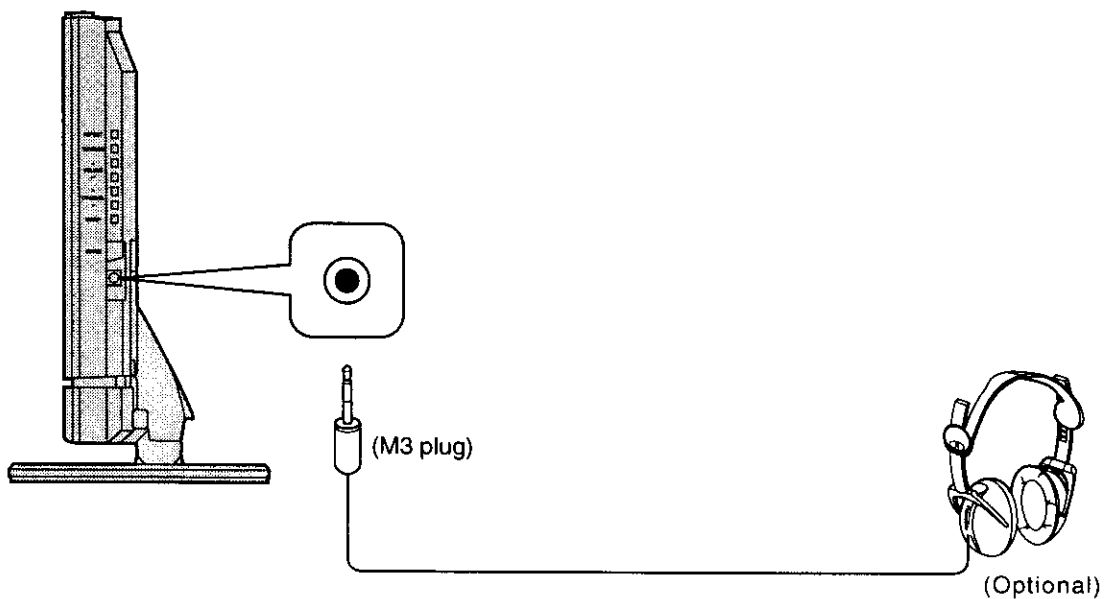

Use Volume Up or Down button to control volume level.

Basic Controls

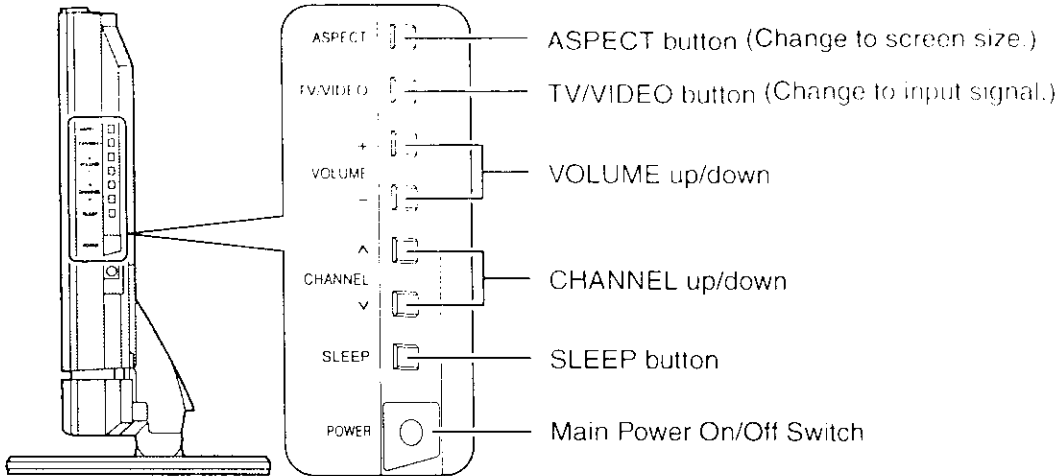

Power button

Press to turn this unit ON or OFF. (See page 13)

Note:

The Wide LCD TV's power cord must first be plugged into the wall outlet and then turned on at the Main POWER switch.

Direct program number selection buttons

R-TUNE button

Switches to previously view to channel or video mode.

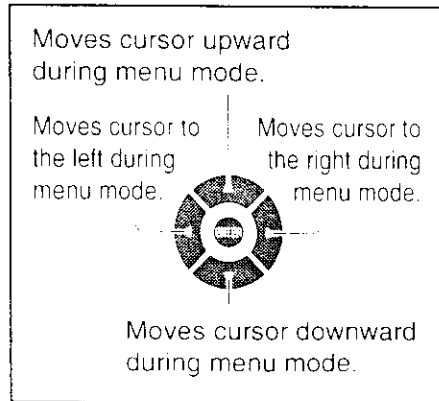

MENU button

Press to display the Menu screen.

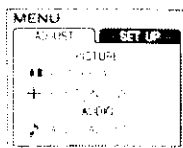

TV/VIDEO button

This input mode changes each time this button is pressed. (See page 19)

DISPLAY button

The screen below is displayed for 3 seconds.

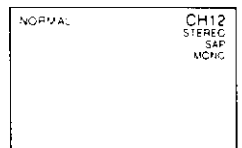

Changes to the next channel up

Changes to the next channel down

Increase volume

Reduces volume

MUTE button

Push this button to mute the sound. (See page 23)

ASPECT button

Change of screen size (See page 18)

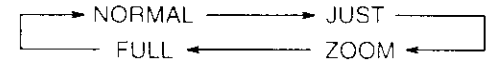

SLEEP button

The Wide LCD TV may be preset to switch to stand-by after a fixed period. The setting changes to 30 minutes, 90 minutes and 0 minutes (off timer cancelled) each time the button is pressed.

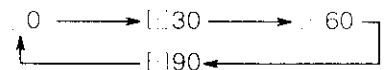

When 3 minutes remain, "Off timer 3" will flash. The off timer is cancelled if a power interruption occurs.

Before the timer automatically turns the power off, the remaining time will blink on the screen ("3" for 3 minutes, "2" for 2 minutes and "1" for 1 minute before power off).

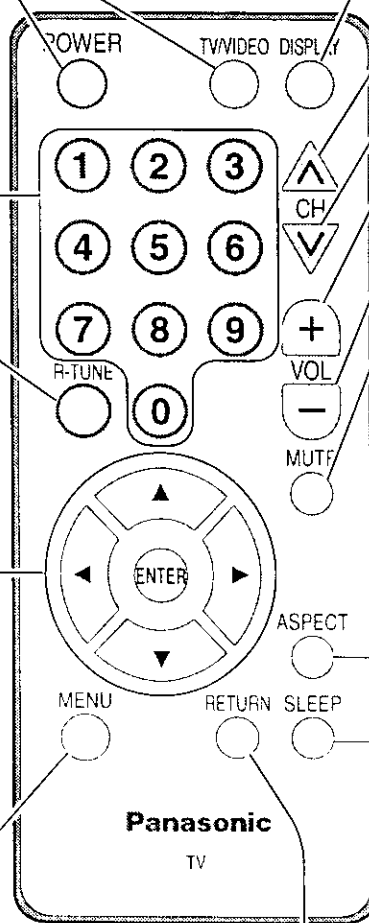

RETURN button

Controls and Turn the Power On

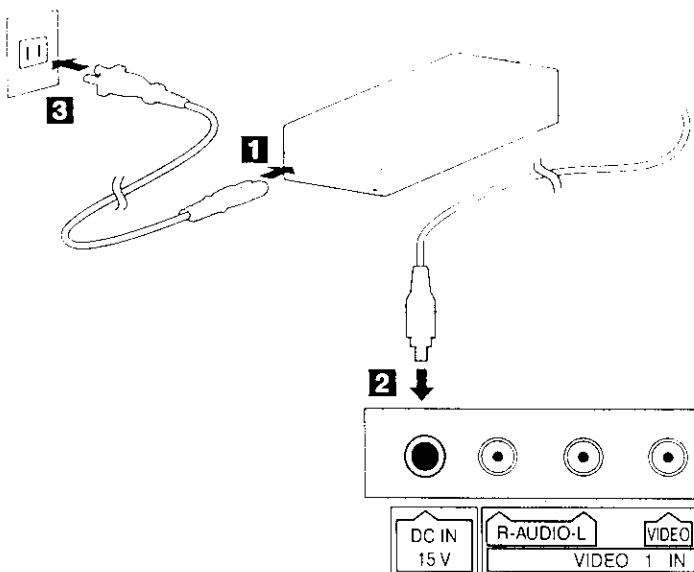

Connect the AC cable and power supply to the Wall outlet connecting the DC plug to DC in Jack
 Push the POWER switch on the TV to turn the set on.
 POWER-ON: Green

Example: This screen below is displayed for a while after the TV is turned on. (setting condition is an example.)

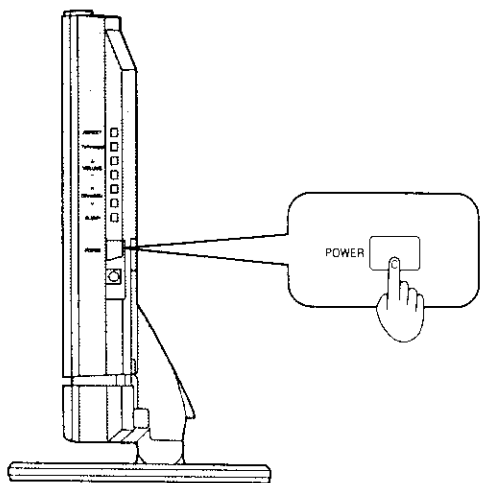
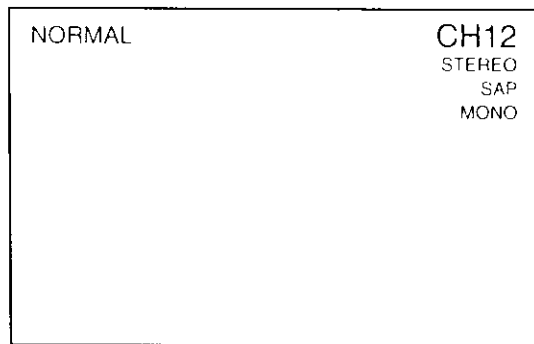

POWER



Press the POWER button on the remote control to turn the TV off: Red (standby)

Press the POWER button on the remote control to turn the TV on: Green

Turn the power to the TV set off by pressing the POWER switch on the TV when the TV is on or in standby mode.

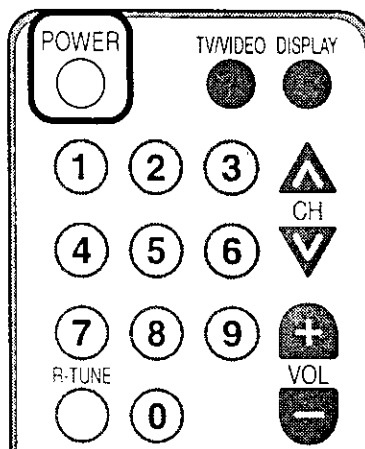
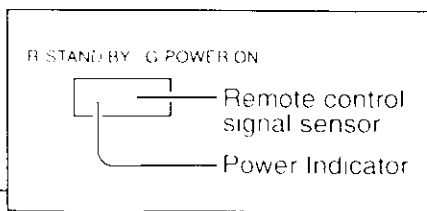
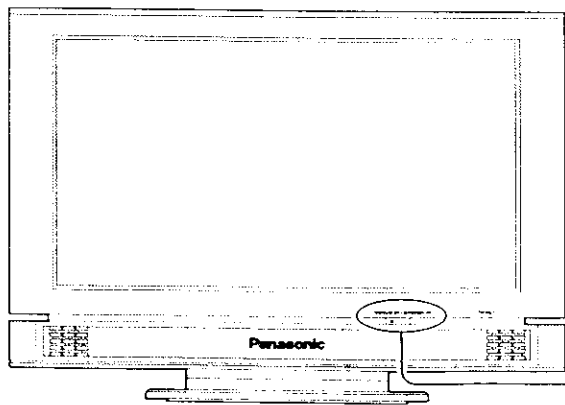

Flow Chart of MENU

All adjustments and setting functions equipped in this set can be made using the menu buttons.
The menu screen is composed of 2 menus, the ADJUST menu and the SET UP menu.

1

If the MENU button is pressed, the MENU screen will be displayed.
If the MENU button is pressed once more while the menu screen is displayed, the MENU screen will be cleared.

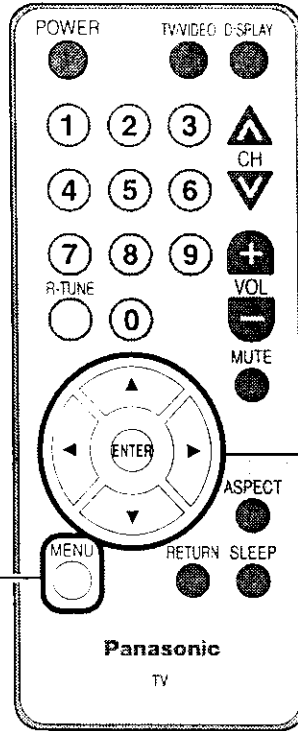
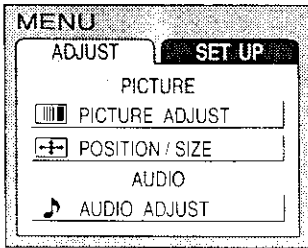
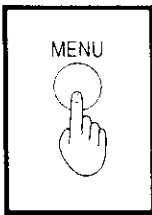

2

Select MENU desired by pushing Right "▶" button or Left "◀" button.

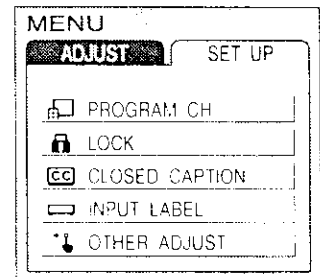
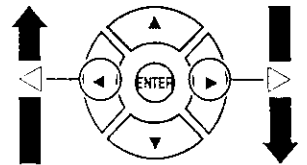
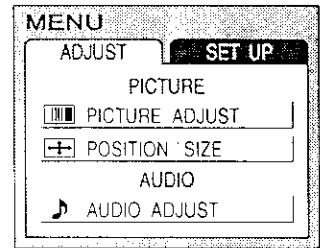
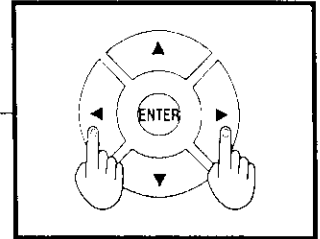

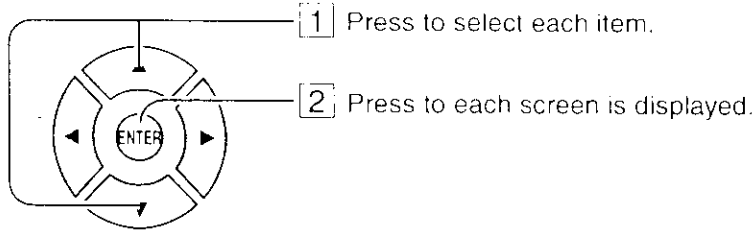

TO PICTURE ADJUST menu

PICTURE ADJUST	
	NORMAL
PIC MODE	STANDARD
BACK LIGHT	+5
PICTURE	0
BRIGHTNESS	0
COLOR	0
TINT	0
SHARPNESS	0
AI PICTURE	OFF ON

(See page 20)

TO POSITION/SIZE

POSITION / SIZE	
	NORMAL
	NORMALIZE
SIZE	1
RETURN	

(See page 24)

TO AUDIO ADJUST menu

AUDIO ADJUST	
	NORMAL
MODE	AUTO
BASS	0
TREBLE	0
BALANCE	0
SURROUND	ON
STEREO	SAP MONO

(See page 22)

TO VIDEO INPUT LABEL selection screen

INPUT LABEL	
VIDEO1	VIDEO1
VIDEO2	VIDEO2
COMPONENT1	COMPONENT1
COMPONENT2	COMPONENT2

(See page 29)

TO LOCK selection screen

LOCK	
MOTION PICT.	OFF ON
CHANGE SETTING	
TV PARENTAL	OFF ON
CHANGE SETTING	
ENTER CODE FIRST	
* - -	

(See page 26)

TO CLOSED CAPTION selection screen

CLOSED CAPTION	
CC MODE	CI

(See page 25)

TO PROGRAM CHANNELS adjust screen

PROGRAM CHANNELS	
MODE	TV CABLE
AUTO PROGRAM	
MANUAL PROGRAM	

(See page 16, 17)

TO OTHER adjust screen

OTHER ADJUST	
NATURE CLR	OFF ON
VIDEO NR	OFF ON
3D Y/C	OFF ON
ID-1	OFF ON
IMAGE ADJ	1 2

(See page 30, 31)

Tuning channels (Automatic channel programming)

Automatically searches and adds receivable channels in the installed area and/or CATV signals to the program.

- 1** Press the MENU button to display the MENU screen and select SETUP.

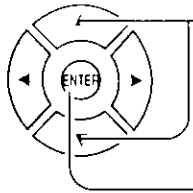

Press to select PROGRAM CH.

Press to display the PROGRAM CH screen.

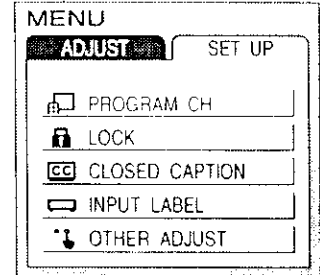

- 2** Press to select MODE.

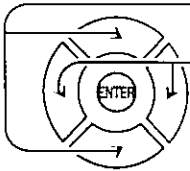

Press to select TV or CABLE.

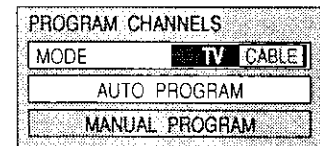

- 3** Press to select AUTO PROGRAM.

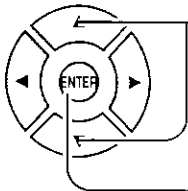

Press to display the confirmation screen.

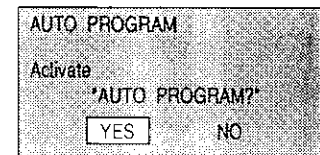

- 4** Press to select YES.

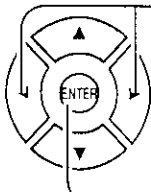

Press to run AUTO PROGRAM.

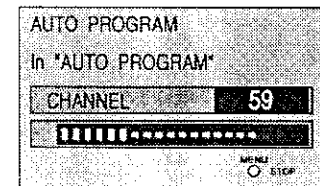

Channels will automatically advance until all channels have been scanned. Channel numbers with a video signal present will turn light blue. Which indicates it has been stored in the Channel Scan Memory.

- 5** Press the MENU button to exit the set up menu.

Notes:

- When buttons are pressed with AUTO PROGRAM running, the TV set will return to normal viewing. (Channel searched up to this point are added.)
- After AUTO PROGRAM is finished, the lowest channel number added will be received.
- When there are no receivable channels, channel 69 is displayed (channel 125 for cable TV).

Tuning channels (Manual channel programming)

Use this setting when changing setting of receiving channels or changing the channel display.

Turn the TV on and select the broadcast channel. Follow the steps on the previous page to display the PROGRAM CHANNEL screen.

This PROGRAM CHANNEL screen can be displayed when the MAIN picture is a TV broadcast.

Selecting the PROGRAM CHANNELS menu.

- 1 Press the MENU button to display the MENU screen and select SETUP.

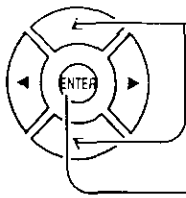

Press to select PROGRAM CH.

Press to display the PROGRAM CH screen.

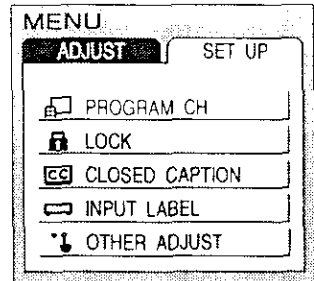

- 2 Press to select MODE.

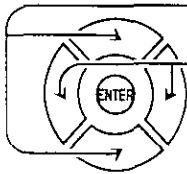

Press to select TV or CABLE.

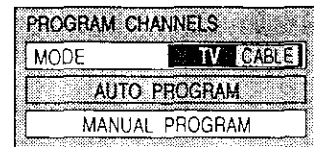

- 3 Press to select MANUAL PROGRAM.

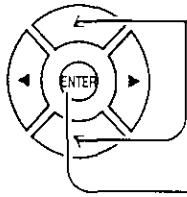

Press to display the MANUAL PROGRAM screen.

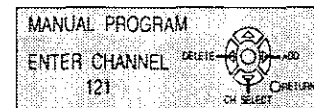

Adding or deleting channels

- 4 Press to select channel (or number keys).

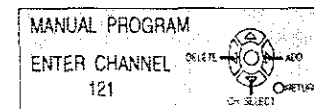
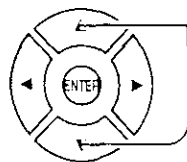

- 5 Press to select channel.

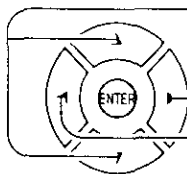

Press to add channels to memory (blue).

Press to delete channels from memory (yellow).

- 6 Repeat steps 4 and 5 to continue adding or deleting channels.

- 7 Press the MENU button to exit the set up menu.

ASPECT Controls

The LCD TV will allow you to enjoy viewing the picture at its maximum size, including wide screen cinema format picture.

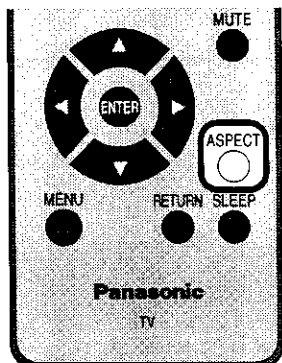

ASPECT button

The aspect mode changes each time the ASPECT button is pressed.

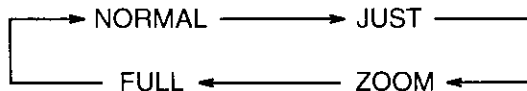

Mode	Picture	Explanation
NORMAL		NORMAL will display a 4:3 picture at its standard 4:3 size.
JUST		JUST mode will display a 4:3 picture at maximum size but with aspect correction applied to the center of the screen so that elongation is only apparent at the left and right edges of the screen. The size of the picture will depend on the original signal.
ZOOM		ZOOM mode magnifies the central section of the picture.
FULL		FULL will display the picture at its maximum size but with slight elongation.

Notes:

- (1) The ASPECT mode settings are stored for TV, VIDEO1, VIDEO2, COMPONENT1 and COMPONENT2 individually.
- (2) During 525p (480p) signal, only FULL and ZOOM screens can be selected.

Playing a VCR or other peripheral equipment

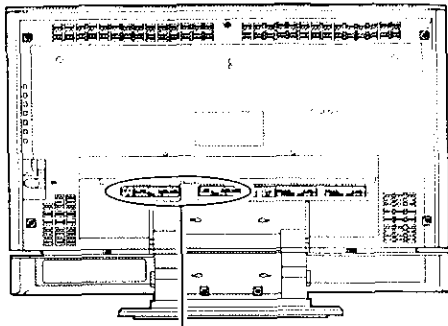

Confirm that the TV is in standby mode.

Confirming VIDEO 1 or 2 connections

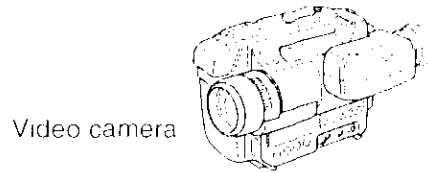
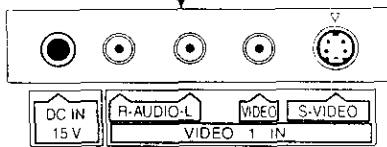

Video camera

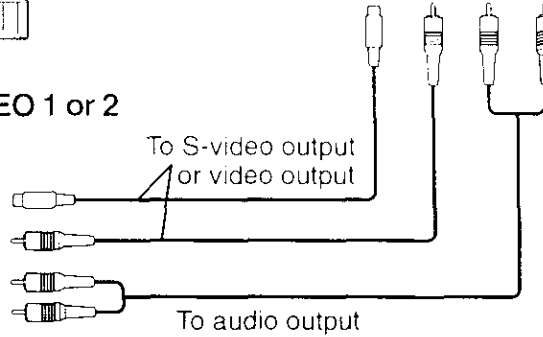

VCR

Laser Disk Player

DVD player

This equipment can also be connected to the rear terminals. See Connections for details.

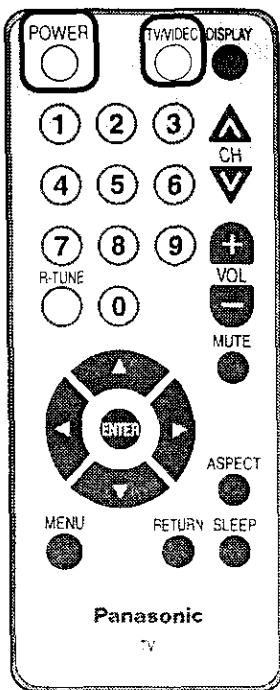

Turning the power on and switching input modes

1

POWER



Turn the TV on.

2

TV-VIDEO



The input mode changes each time this button is pressed.

- When playing a video

- When playing a DVD

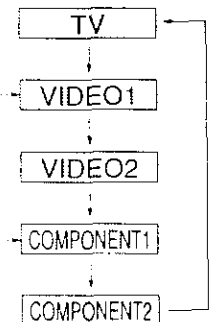

Note:

When the remote control is unavailable, input modes can also be switched on the TV set using the TV/VIDEO button.

3

Operate the connected equipment.

Picture Adjustments

- 1 Press the MENU button to display the MENU screen and select ADJUST.

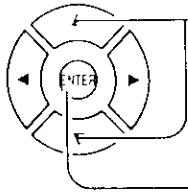

Press to select to PICTURE ADJUST.

Press to display the PICTURE ADJUST screen.

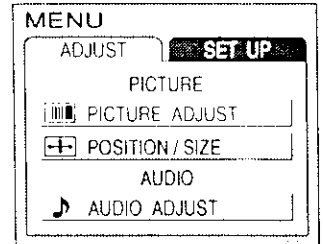

NORMAL is displayed at default.

2

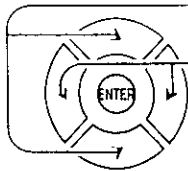

Press to select the menu to adjust.

Select the desired level by looking at the picture behind the menu.

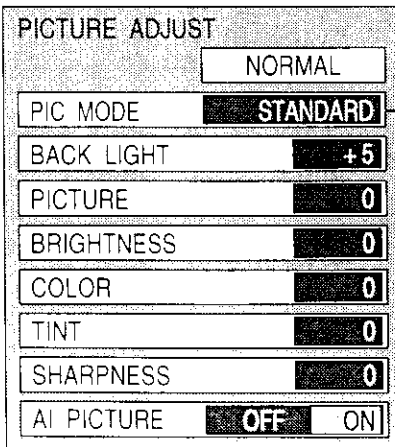
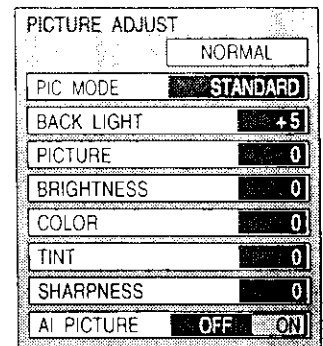

See next page

Press the left ◀ or right ▶ button to switch between modes.



STANDARD

STANDARD

Displays unaltered image.



CINEMA

CINEMA

Ideal for movies.



DYNAMIC

DYNAMIC

Displays a clear screen with contrast of light and dark.

Note:

PICTURE adjustments are stored for TV, VIDEO1, VIDEO2, COMPONENT1 and COMPONENT2 individually.

Picture Adjustments

- BACKLIGHT** —
Illuminance of the back light is adjusted.
- PICTURE** —
Selects proper brightness and density for the room.
- BRIGHTNESS** —
Adjusts for easier viewing of dark pictures such as night scenes and hair.
- COLOR** —
Adjusts slightly to a lighter color.
- TINT** —
Adjust for nice skin color.
- SHARPNESS** —
Displays a sharp image.
- AI PICTURE** —
Displays black and white colors clearer when turned ON.

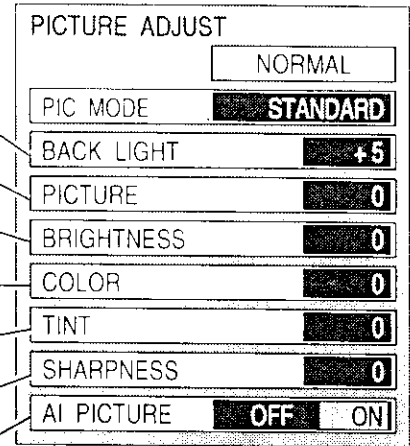

- To adjust each item, →

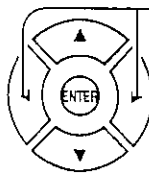

Press the up ▲ and down ▼ button and make adjustments using the left ◀ and ▶ right buttons.

- To reset to standard setting, →

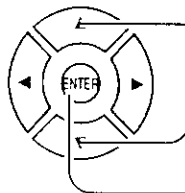

Select NORMALIZE with the up ▲ and down ▼ buttons.

Press ACTION.

- To return to normal viewing →



Press MENU button.

Note:

PICTURE adjustments can be made for DYNAMIC, STANDARD and CINEMA each.

Audio Adjustments

1 Press the MENU button to display the MENU screen and select SETUP.

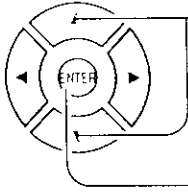

Press to select to AUDIO ADJUST.

Press to display the AUDIO ADJUST screen.

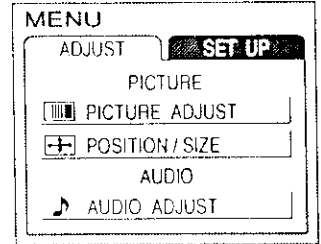

2

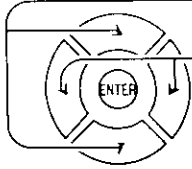

Press to select the menu to adjust each item.

Select the desired level by listening to the sound.

BASS
Adjusts low sounds

TREBLE
Adjusts high sounds

BALANCE
Adjust left and right volumes

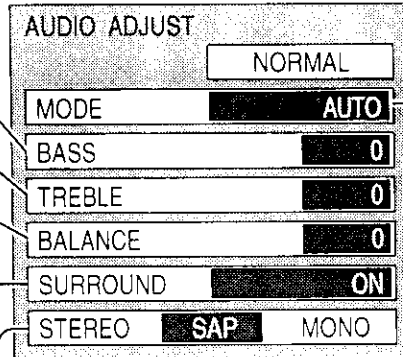

SURROUND
To enjoy a concert hall effect, turn SURROUND to ON.

Selecting STEREO/
SAP/MONO.
(See next page)

AUTO

Auto

Automatically adjusts quiet sound and loud sound for ease of listening.

STANDARD

STANDARD

Emits the original sound.

DYNAMIC

DYNAMIC

Gives contrast to sound.

MUSIC 1

MUSIC 1

For programs consisting mainly of music. Enhances high sounds (around 4 kHz).

MUSIC 2

MUSIC 2

Enhances high sounds even more. (Recommended for those who have slight hearing deficiencies.)

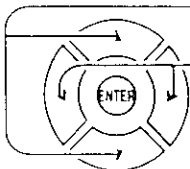

To reset to standard setting,

select NORMALIZE with the up ▲ and down ▼ buttons and press ENTER.

BASS, TREBLE, BALANCE and SURROUND adjustments are stored for each AUDIO menu.

• To end adjustments •

MENU

Press MENU button.



Audio Adjustments

Selecting STEREO/SAP/MONO

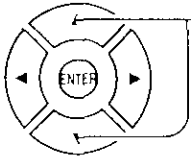

Press to select STEREO/SAP/MONO.

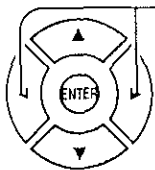
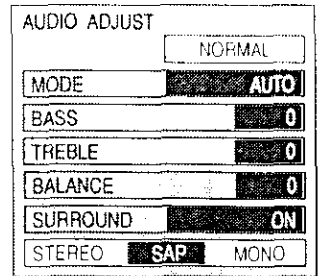

Press to select STEREO/SAP/MONO.

Red display : With signal
White display : No signal
 : MONO

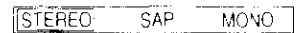

Press to end.

- **STEREO** - Two channel Audio reception.
- **SAP** - Second Audio Programming (typically used for bilingual audio).
- **MONO** - Use when stereo signal is weak.

MUTE

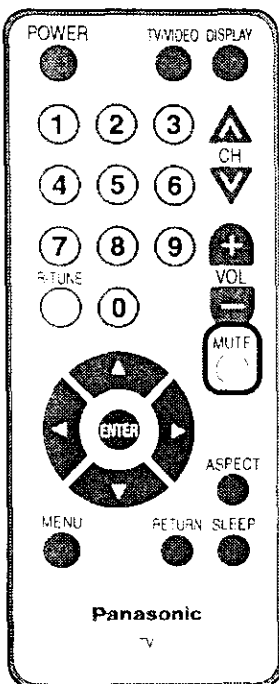

Useful when answering the phone or receiving unexpected visitors

MUTE



Press this button to mute the sound.

Press again to reactivate sound.

Sound is also reactivated when power is turned off or volume level is changed.

Adjusting screen position and size

Adjusting screen

1  Press to select the screen mode to adjust.

2  Press to display the MENU screen.

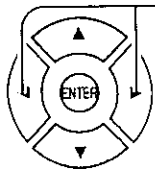
 Press to select ADJUST menu.

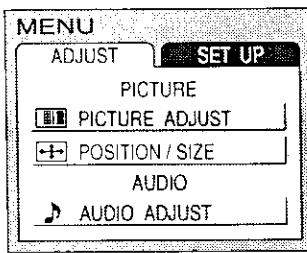

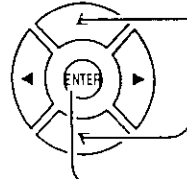
 Press to select POSITION/SIZE.

 press ACTION.

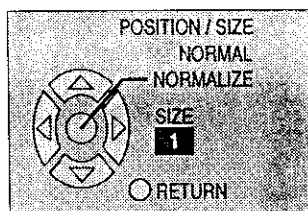
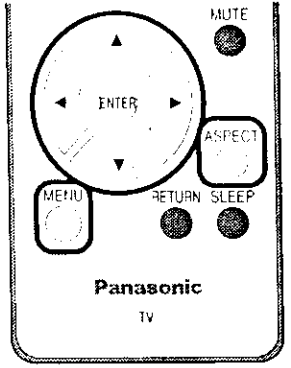

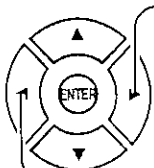

Switching screen width

During NORMAL and JUST mode, if noise appears on the ends of the image in SIZE 1, switch to SIZE 2.

 Press to narrow (SIZE 2).

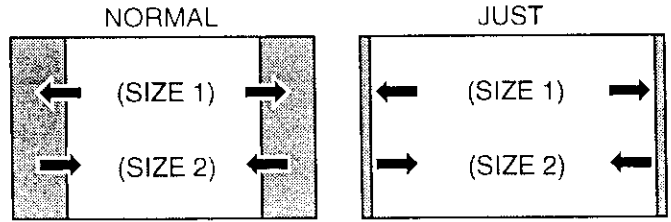
 Press to widen (SIZE 1).



Moving Displaying images cut off from the screen

For ZOOM mode.

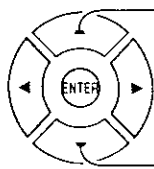
 Press to move image upwards.

 Press to move image downwards.

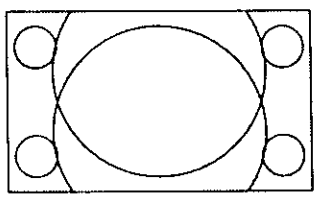

- To return to standard → ENTER
- To end adjustments → MENU (RETURN)

Notes:

- This TV is equipped with various screen modes. If a screen mode with a different aspect from the broadcast program is selected, image will appear differently. Select the proper screen mode with this in mind.
- Be careful when using this TV for commercial purposes or for public use, such as in cafes and hotels, for shrinking and enlarging images by using screen mode switching function (zoom, etc.) may violate copyright laws.
- Images displayed on a wide screen TV will be cut off or distorted at the edges, when viewing normal aspect images of 4:3 in ZOOM, JUST or FULL mode. Display in NORMAL mode to view the original image intended by the producer.
- The adjusted setting will be kept even when the TV is turned off.

Closed Captions

This unit has a built in decoder that provides a visual depiction of the audio portion of a television program in the form of written words across the screen (white or colored letters on a black background). It allows the viewer to read the dialogue of a television program or other information.

- 1 Press the MENU button to display the MENU screen and select SETUP.

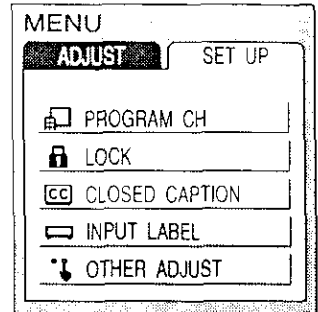
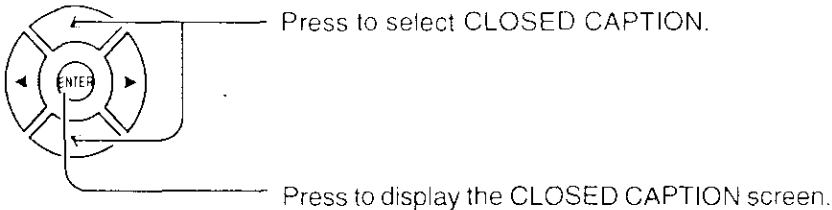

2 **CC** Mode

Activates the On-Screen Closed Caption feature. When activated this feature will remain on until OFF is selected in this menu.

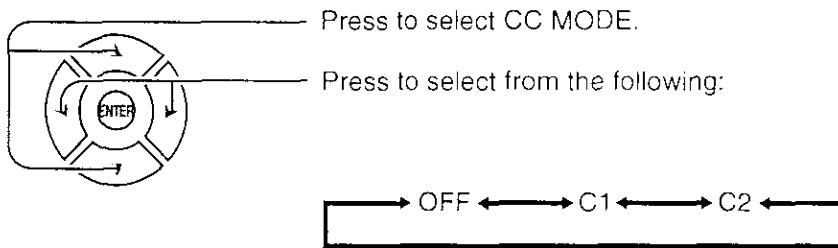

- **CAPTION OFF** - Recommended mode when Closed Caption is not being used.
- **CAPTION C1** - For video related information that can be displayed (up to 4 lines of script strategically placed on the television screen so that it does not obstruct relevant parts of the picture).
- **CAPTION C2** - Another mode used for video related information.

- To end adjustments →

MENU



Press MENU button.

Lock Feature

In the United States, the V-CHIP consists of two rating systems, which are MPAA (MOTION PICTURE) and TV PARENTAL GUIDELINES. Its function is to block programs by the rating data in the XDS data packets sent from broadcasting stations. The user can select which rating programs should be blocked by the LOCK MENU options.

Note: The V-CHIP used in this unit model, is capable of selecting the U.S. ratings that are indicated in this manual.

Press the MENU button to display the MENU screen and select SETUP.

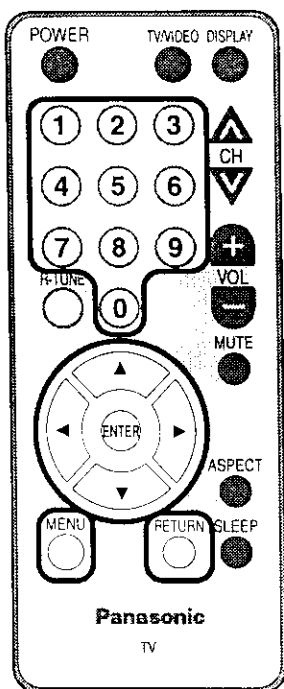

1

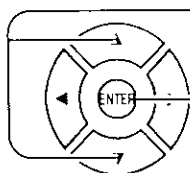

Press to select LOCK.

Press to display the LOCK screen.

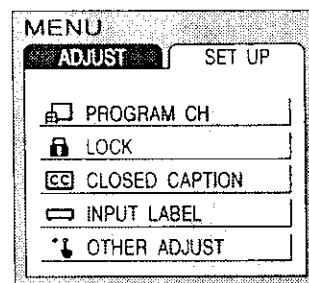

Input code

Enter any 4-digit number as a password. These numbers will be needed when deactivating the LOCK function.

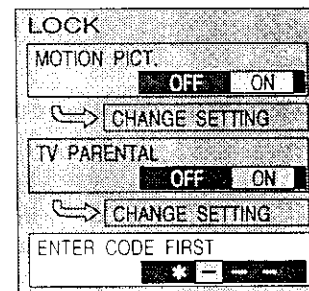

2

Selecting broadcasts to lock.

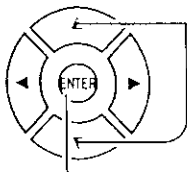

Press to select CHANGE SETTING (the menu following MOTION PICT.).

Press to display the MOTION PICTURE RATING screen.

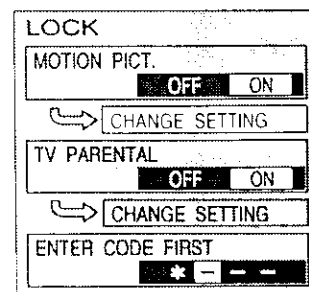

Note:

Use a code that is easy to remember or record it in a safe place.

3

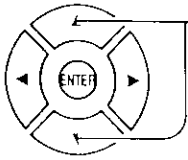

Press to select rating to lock.

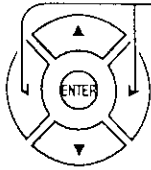

Press to select YES or NO.

Rating (turns red when on)

- G : General audience
- PG : Parental guidance suggested
- PG-13: Parental guidance needed under 13 years old
- R : Restricted
- NC17 : No one under 17 is admitted
- X : Pornography



RETURN



Press to return to LOCK screen.

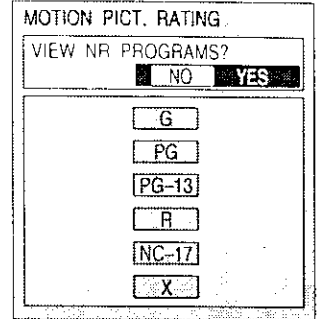

4

Setting MOTION PICT..

Locking and unlocking the ratings selected above.

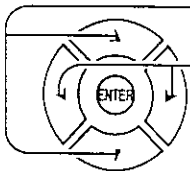

Press to select MOTION PICT..

Press to select ON or OFF.

ON : The broadcasts selected in the MOTION PICTURE RATING menu cannot be viewing.

OFF: LOCK is deactivated and any broadcast, regardless of the setting for MOTION PICTURE RATING, can be viewing.

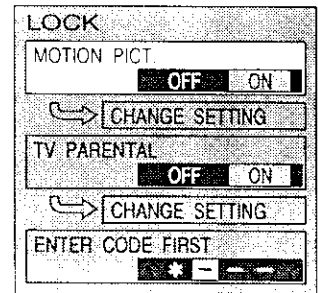

MENU



Press to set.

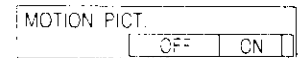

Lock Feature

TV PARENTAL GUIDE

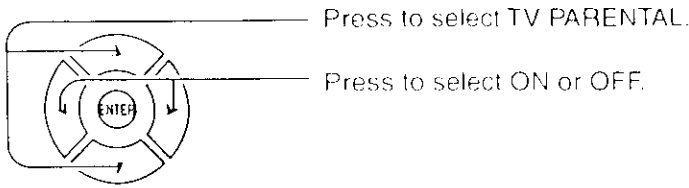

Changing setting

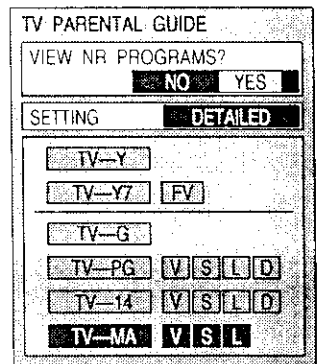
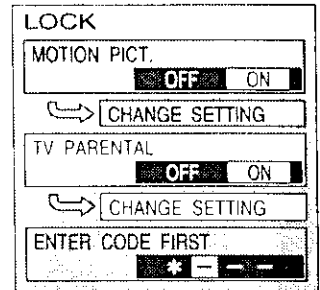
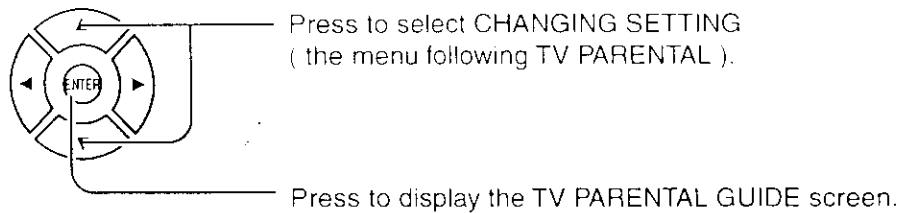

Setting the TV PARENTAL PROGRAMS screen

VIEW NR PROGRAMS?

NO : Cannot view programs with NR signals.

YES : Can view programs with NR signal.

SETTING

BASIC : The up ▲ and down ▼ buttons change the selected title.

DETAILED : The cursor selecting the title can be moved to select options displayed on the right. The down ▼ buttons moves the cursor to the right if options are available. The up ▲ buttons moves the cursor to the left and if there are no options to the left, the cursor will move up.

Locking and unlocking

- When a title field is selected, all ratings below this rating are selected.
- When options within an option field are selected, ratings below this rating within the same field are selected.
- Ratings displayed in green are unlocked and those displayed in red are blocked programs.

1. Ratings for children: These ratings are divided into ranks as follows.



2. Ratings for teenagers: These ratings are the same as the matrix system. This system is described in the below diagram. Ratings for all ages are on top and ratings for adults are on the bottom.

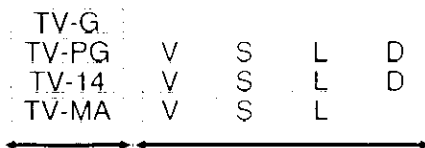

• To end adjustments

MENU

Press MENU button.



Customizing the VIDEO INPUT labels

Display for each VIDEO INPUT can be changed to match with the connected device (VCR, DVD Player).

Example: When changing VIDEO to LD.

- 1 Press the MENU button to display the MENU screen and select SETUP.

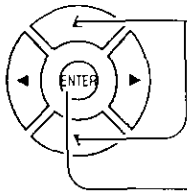

Press to select INPUT LABEL.

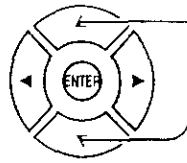

Press to display the VIDEO INPUT LABEL screen.

Press to select VIDEO or COMPONENT.

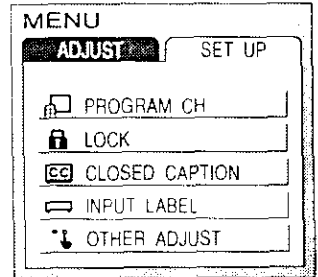

2

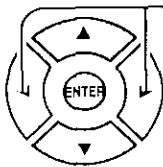

Press to change.

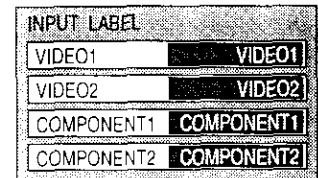

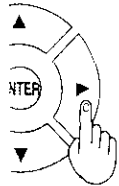

By pressing this button, display changes as follows:

```

    → VIDEO1, 2 (or COMPONENT1, 2) → VCR → LD
    ← BLANK ← DTV ← DVD ← GAME ←
    
```

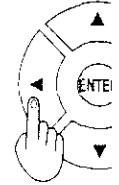

This button rotates in reverse.

MENU



Press to end.

Adjusting unnatural video images (3D Y/C FILTER)

1 Press the MENU button to display the MENU screen and select SETUP.

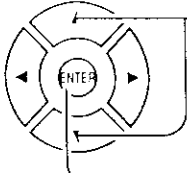
2  Press to select OTHER ADJUST.

Press to display the OTHER ADJUST screen.

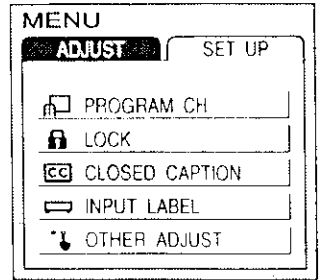

3  Press to select 3D Y/C.

Press to turn ON.

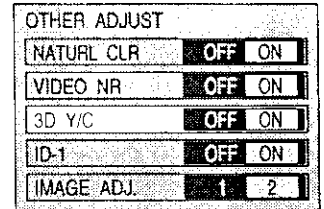

Press to end.

Note:

Not available for COMPONENT VIDEO.

Natural Color

1 Press the MENU button to display the MENU screen and select SETUP.

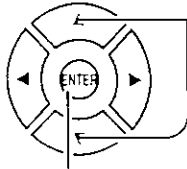
2  Press to select OTHER ADJUST.

Press to display the OTHER ADJUST screen.

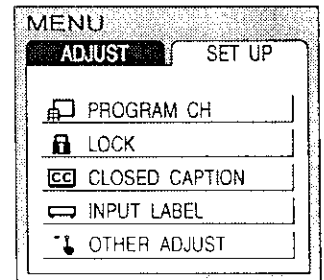

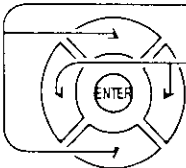
3  Press to select NATURL CLR.

Press to turn NATURL CLR ON.

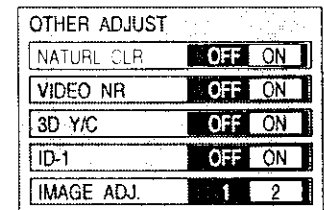

Press to end.

Note:

Not available for COMPONENT VIDEO.

Video Noise Reduction

1 Press the MENU button to display the MENU screen and select SETUP.

2 Press to select OTHER ADJUST.

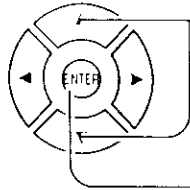

Press to display the OTHER ADJUST screen.

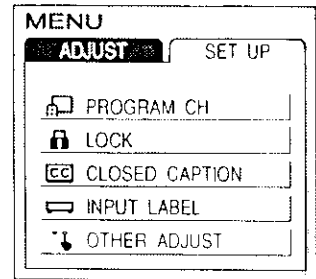

3 Press to select VIDEO NR.

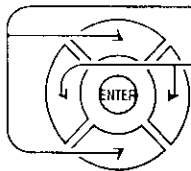

Press to set the VIDEO NR ON.

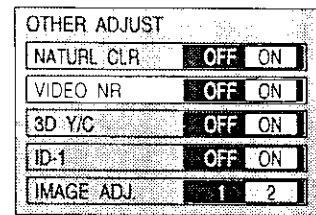

Press to exit menu.

Automatically changing screen size for VIDEO INPUT modes

If the received signal contains screen size specifications in VIDEO INPUT the screen size is automatically changed.

1 Press the MENU button to display the MENU screen and select SETUP.

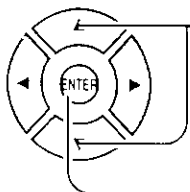

Press to select OTHER ADJUST.

Press to display the OTHER ADJUST screen.

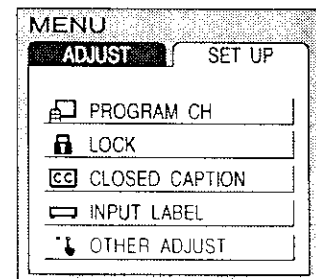

2 Press to select ID-1 (Image Detection).

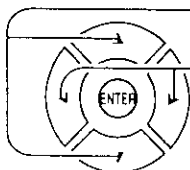

Press to set.

ON : When screen size specification signals are detected, screen size is automatically changed.
 OFF : The screen size is not automatically changed. (Turn OFF if this function does not operate properly.)

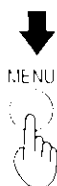
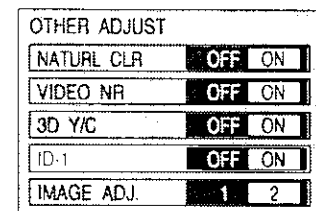

Press to end.



Note:

When ID-1 is detected and screen size is changed, FULL or WIDE will be display

When the top and bottom of the screen noise (IMAGE ADJ.)

1 Press the MENU button to display the MENU screen and select SETUP.

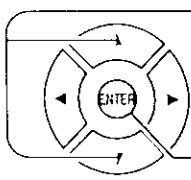

Press to select OTHER ADJUST.

Press to display the OTHER ADJUST screen.

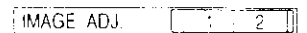
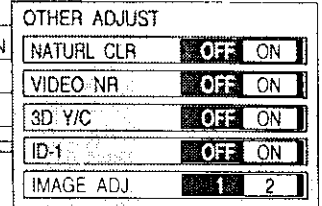
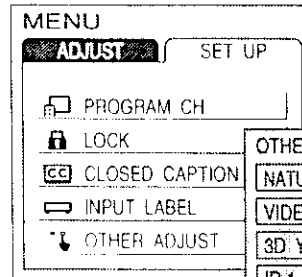

2

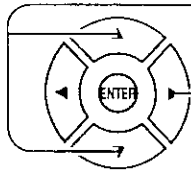

Press to select IMAGE ADJ.

Press to select 2.



Press to exit menu.

(Example) 1

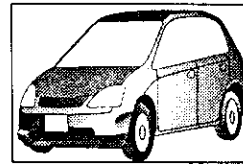

(Example) 2

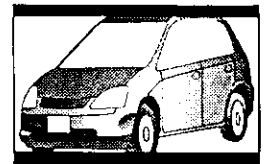

Notes:

- IMAGE ADJ. settings are stored for TV, VIDEO1, VIDEO2, COMPONENT1 and COMPONENT2 each.
- This setting will not change during ZOOM.

Attaching and removing the connection terminal cover

Attach the connection terminal cover after all cables are connected to the terminals on the back of the set.

Attaching the cables

Fix the cables in place using clampers 1, 2, 3, and 4.

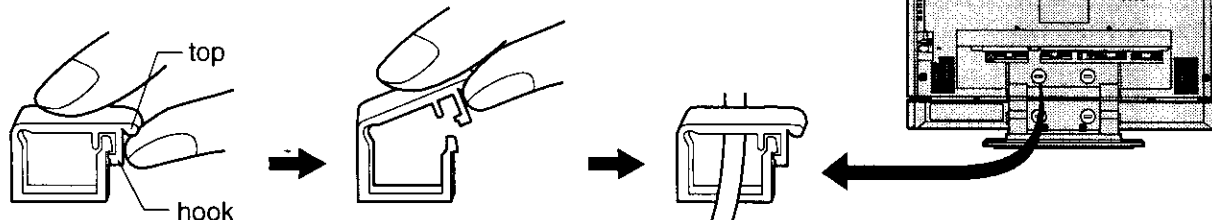

Hold the top of the clamer with your thumb and pull out with your index finger to release the hook.

Attaching

1. Insert the two ribs at the top of the cover into the holes on the set.
2. From this position, push the lower part of the cover into the set.
3. Snap the ribs on the lower right and left of the cover into the set.

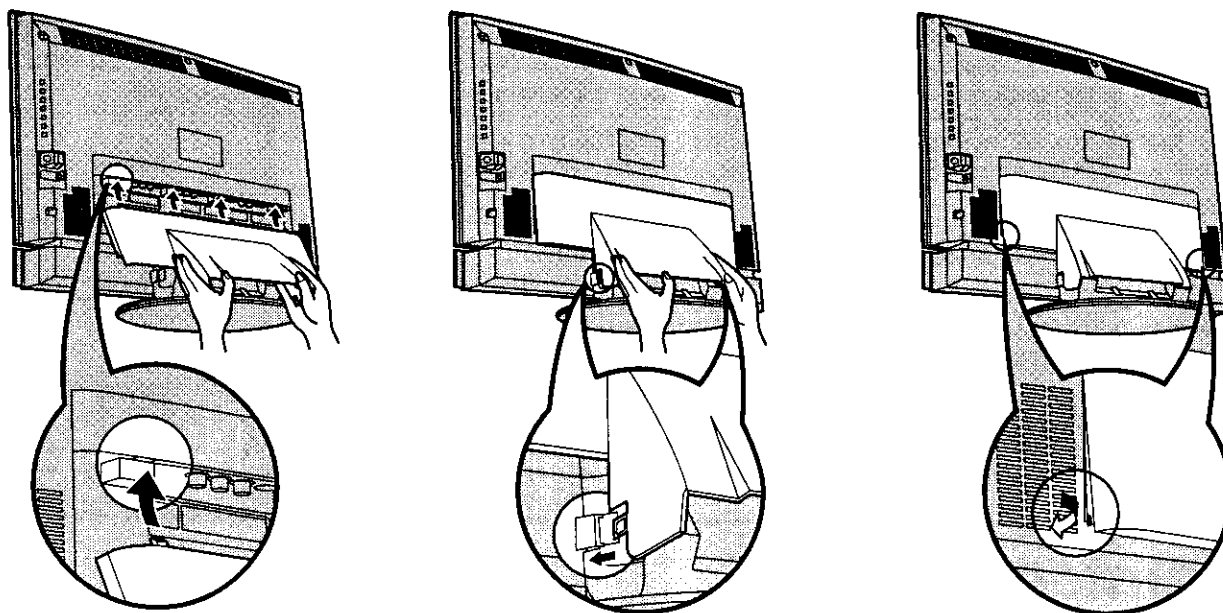

Removing

1. Press the left and right rib with locking function of the cover as shown in the diagram, and pull out.
2. Remove the cable cover by holding on to the lock on the center of the right and left sides.

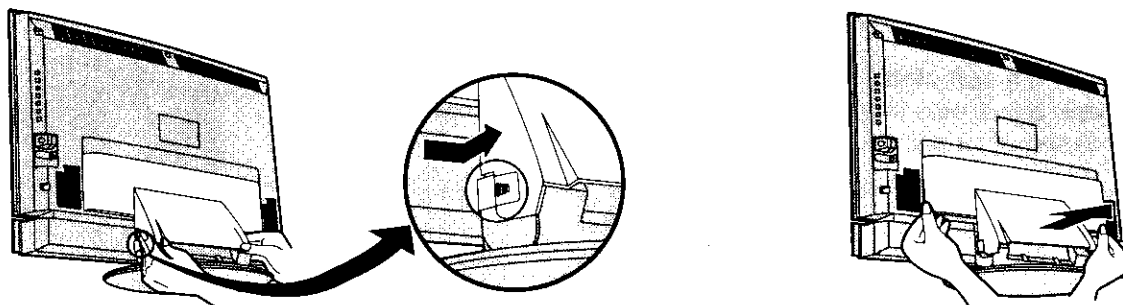

Troubleshooting

Before requesting service for this LCD TV, check the chart below for a possible cause of the problem you are experiencing. Some simple checks or a minor adjustment on your part may eliminate the problem and restore proper operation. If you are in doubt about some of the check points, or if the remedies indicated in the chart do not solve the problem, consult your dealer for instructions.

Symptoms	Checks	Page
Power does not turn ON	<ul style="list-style-type: none"> ● Is the power plug plugged in? ● Is the AC adapter plug securely connected to the unit? ● If the power does not turn on using the remote, check if the TV set is turned on. 	<p>– 13</p>
Remote control does not function	<ul style="list-style-type: none"> ● Are the batteries dead or inserted incorrectly? ● Is the remote control sensor in direct light of florescent lamps or other strong sources of light? 	<p>7 –</p>
Image shakes Image is not clear or no color	<ul style="list-style-type: none"> ● Is the antenna cable connected properly? ● When using a VCR and selecting channels on the TV, is the TV/VIDEO mode for the VCR set to TV? 	<p>8, 9 19</p>
Image appears doubled or tripled.	<ul style="list-style-type: none"> ● Check cable signal, connections or wire. 	–
A black stripe appears for a moment when changing channels using the VCR.	<ul style="list-style-type: none"> ● The image distorts when channels are changed. 	–
Images disappear at the top and bottom of the screen	<ul style="list-style-type: none"> ● When using 16:9 image software, there is no picture at the top and bottom of the screen (cinema vision size software, etc.). 	–
During ZOOM or JUST modes, the image is cut off at the top and bottom.	<ul style="list-style-type: none"> ● Has the screen position been changed? → If so, adjust screen positioning. 	–
Channel number remains displayed.	<ul style="list-style-type: none"> ● Press the DISPLAY button. During VIDEO input, channel number is displayed until an image is displayed. 	–
There may be red spots, blue spots and green spots on the screen.	<ul style="list-style-type: none"> ● This is a characteristic of liquid crystal panels and is not a problem. The liquid crystal panel is built with very high precision technology giving you fine picture details. Occasionally, a few non-active pixels may appear on the screen as a fixed point of blue, green, or red. Please note the this does not affect the performance of your LCD TV. 	–

Maintenance

Do not wipe the LCD with water

Clean the LCD using a dry soft cloth such as gauze. If the LCD is heavily soiled, apply OA cleaner for LCD panels to the cloth and wipe off gently. Do not use keton chemicals such as acetone, solvents such as xylen or toluene, or water.

Wipe the cabinet with a soft cloth

If the cabinet is heavily soiled, wipe with a well-wrung soft cloth dipped in kitchen cleanser (neutral) diluted with water.

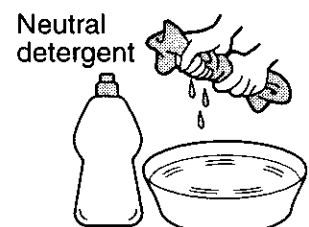

CAUTION :

If water or similar substances get inside the monitor via the liquid crystal panel surface, a malfunction may result.

Specifications

Power Source		AC 100 ~ 240 V, 50 / 60 Hz	
Power Consumption		Average use : 69 W (Maximum Current 0.7 A) Stand-by condition : 4 W (at 120 – 240 V)	TV set DC 15 V, 4.1 A max.
LCD		22-inch, 16 : 9 aspect ratio LCD panel	
Screen Size		19.17 " (487 mm) (W) × 10.79 " (274 mm) (H)	
Channel Capability-181		VHF-12 : UHF-56 : Cable-125	
Sound	Speaker	Tweeter (4 × 7 cm 2pcs, 8 Ω), Woofer (φ 5 cm 2pcs, 4 Ω)	
	Audio Output	9W (2.5 W + 2.5 W + 4.0 W (Woofer)), 10 % THD, 50 Hz ~ 20 kHz	
	Headphones	M3 (3.5 mm) Jack × 1	
FEATURES		3D Y/C Digital Comb Filter Aero - Hammer® Double Woofer System (2 Way 4 Speaker System) CLOSED CAPTION V-Chip	
Accessories Supplied			
Remote control Transmitter		N2QAFC000006	Battery : CR2025 × 1
AC Adaptor		AC Adaptor : N0JZHK000004	AC Cord : K2CA2EA00005
Operating Conditions		Temperature : 41 °F - 95 °F (5 ° - 35 °C) Humidity : 5 % - 90 % RH (non-condensing)	
Connection Terminals			
VIDEO IN	VIDEO	RCA PIN Type × 2	1.0 Vp-p
	S-VIDEO	Mini DIN 4-pin × 2	Y : 1 Vp-p (75 Ω), C : 0.286 Vp-p (75 Ω)
	AUDIO L-R	RCA PIN Type × 2	1.0 Vp-p
COMPONENT IN VIDEO		D Type Connector × 2	Y, P _B , P _R
	AUDIO L-R	RCA PIN Type × 2	0.5 Vrms
AUDIO OUT		M3 Stereo Jack × 1	0.5 Vrms
Dimensions (W × D × H)			
Including TV Stand		23.07 " (586 mm) × 9.45 " (240 mm) × 16.69 " (424 mm)	
TV Set Only		23.07 " (586 mm) × 2.64 " (67 mm) × 15.27 " (388 mm)	
Weight (Mass)		25.35 lb. (11.5 kg) Net	

Note:

Design and Specifications are subject to change without notice. Weight and Dimensions shown are approximate.

Customer' Record

The model number and serial number of this product can be found on its rear panel. You should note this serial number in the space provided below and retain this book, plus your purchase receipt, as a permanent record of your purchase to aid in identification in the event of theft or loss, and for Warranty Service purposes.

Model Number TC-22LT1 _____

Serial Number _____

**Panasonic Consumer Electronics
Company, Division of Matsushita
Electric Corporation of America**
One Panasonic Way Secaucus
New Jersey 07094

**Panasonic Sales Company,
Division of Matsushita Electric of
Puerto Rico Inc. ("PSC")**
Ave. 65 de Infanteria, Km 9.5
San Gabriel Industrial Park,
Carolina, Puerto Rico 00985