

Panasonic®

Color Television Operating Instructions

CT-27D11D

CT-32D11C

CT-36D11C

CT-27D31C

CT-32D31C



CT-36D31C

CT-2772SC

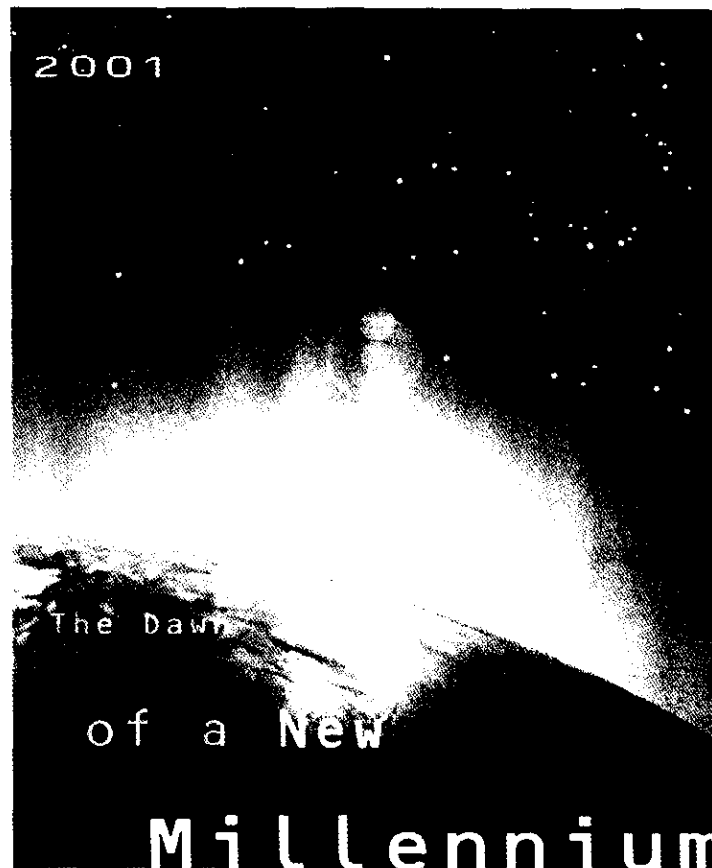
CT-3274SC



TQB2AA0398 10112
PRINTED IN MEXICO

	WARNING RISK OF ELECTRIC SHOCK DO NOT OPEN	
WARNING: To reduce the risk of electric shock do not remove cover or back. No user-serviceable parts inside. Refer servicing to qualified service personnel.		



The lightning flash with arrow head within a triangle is intended to tell the user that parts inside the product are a risk of electric shock to persons.



The exclamation point within a triangle is intended to tell the user that important operating and servicing instructions are in the papers with the appliance.

WARNING: To prevent fire or shock hazard, do not expose this appliance to rain or moisture.

Table of Contents

Feature Comparison Chart	3
Congratulations	4
Customer Record	4
Care and Cleaning	4
Specifications	4
Installation	5
Television Location	5
Optional Cable Connections	6
AC Power Supply Cord	6
Cable / Antenna Connection	6
Optional Equipment Connections	7
VCR Connection	7
Digital TV - Set Top (DTV-STB) or DVD Player connection	8
Amplifier Connection (To Audio Amp)	8
1 Tuner Picture In Picture (PIP) Operation Only	9
PIP Operation with a VCR and Cable Box	9
PIP Operation with a VCR - No Cable Box	10
2 Tuner Picture In Picture (PIP) Operation Only	11
PIP Operation with a VCR and Cable Box	11
PIP Operation with a VCR - No Cable Box	12
Main Menu	13
Remote Control Buttons	13
Remote Control Guide	13
Main Menu Feature Chart	14
Special Features	17
Menu Languages	17
Program Channels	17
CC (Closed Captioning)	17
Other Adjustments - Auto Power ON/Channel Banner	17
Sleep Timer	18
Timer 1 and Timer 2	18
Picture -Video Adjustments	19
Picture - Other Adjustments	19
Channels - Favorites	20
Channels - Caption	20
Skip Feature	20
Lock - Mode	21
Troubleshooting Chart	22

Read these instructions completely before operating TV.

Contents are subject to change without notice or obligation.

Copyright 2001 by Matsushita Electric Corporation of America. All rights reserved.
Unauthorized copying and distribution is a violation of law.



Feature Comparison Chart

MODELS		CT-27D11D	CT-27D31C	CT-2772SC	CT-32D11C	CT-32D31C	CT-3274SC	CT-36D11C	CT-36D31C
FEATURES									
SPECIAL FEATURES	MENU LANGUAGE ENG/SPAN/FR	<input type="checkbox"/>	<input type="checkbox"/>	<input type="checkbox"/>	<input type="checkbox"/>	<input type="checkbox"/>	<input type="checkbox"/>	<input type="checkbox"/>	<input type="checkbox"/>
	NO PIP	<input type="checkbox"/>			<input type="checkbox"/>			<input type="checkbox"/>	
	1 TUNER PIP			<input type="checkbox"/>					
	2 TUNER PIP		<input type="checkbox"/>			<input type="checkbox"/>	<input type="checkbox"/>		<input type="checkbox"/>
	VIDEO INPUT PICTURE MEMORY	<input type="checkbox"/>	<input type="checkbox"/>	<input type="checkbox"/>	<input type="checkbox"/>	<input type="checkbox"/>	<input type="checkbox"/>	<input type="checkbox"/>	<input type="checkbox"/>
	CLOSED CAPTIONING	<input type="checkbox"/>	<input type="checkbox"/>	<input type="checkbox"/>	<input type="checkbox"/>	<input type="checkbox"/>	<input type="checkbox"/>	<input type="checkbox"/>	<input type="checkbox"/>
	V-CHIP CAPABILITY	<input type="checkbox"/>	<input type="checkbox"/>	<input type="checkbox"/>	<input type="checkbox"/>	<input type="checkbox"/>	<input type="checkbox"/>	<input type="checkbox"/>	<input type="checkbox"/>
	75 OHM INPUT	<input type="checkbox"/>	<input type="checkbox"/>	<input type="checkbox"/>	<input type="checkbox"/>	<input type="checkbox"/>	<input type="checkbox"/>	<input type="checkbox"/>	<input type="checkbox"/>
	CHANNEL INFO BANNER	<input type="checkbox"/>	<input type="checkbox"/>	<input type="checkbox"/>	<input type="checkbox"/>	<input type="checkbox"/>	<input type="checkbox"/>	<input type="checkbox"/>	<input type="checkbox"/>
	VIDEO NORM	<input type="checkbox"/>	<input type="checkbox"/>	<input type="checkbox"/>	<input type="checkbox"/>	<input type="checkbox"/>	<input type="checkbox"/>	<input type="checkbox"/>	<input type="checkbox"/>
AUDIO	AUDIO NORM	<input type="checkbox"/>	<input type="checkbox"/>	<input type="checkbox"/>	<input type="checkbox"/>	<input type="checkbox"/>	<input type="checkbox"/>	<input type="checkbox"/>	<input type="checkbox"/>
	STEREO	<input type="checkbox"/>	<input type="checkbox"/>	<input type="checkbox"/>	<input type="checkbox"/>	<input type="checkbox"/>	<input type="checkbox"/>	<input type="checkbox"/>	<input type="checkbox"/>
	AI SOUND	<input type="checkbox"/>	<input type="checkbox"/>	<input type="checkbox"/>	<input type="checkbox"/>	<input type="checkbox"/>	<input type="checkbox"/>	<input type="checkbox"/>	<input type="checkbox"/>
	BASS/BALANCE/TREBLE	<input type="checkbox"/>	<input type="checkbox"/>	<input type="checkbox"/>	<input type="checkbox"/>	<input type="checkbox"/>	<input type="checkbox"/>	<input type="checkbox"/>	<input type="checkbox"/>
	SURROUND	<input type="checkbox"/>	<input type="checkbox"/>	<input type="checkbox"/>	<input type="checkbox"/>	<input type="checkbox"/>	<input type="checkbox"/>	<input type="checkbox"/>	<input type="checkbox"/>
	NUMBER OF SPEAKERS	2	2	2	2	2	2	2	2
	A/V IN (REAR/FRONT)	3 (2/1)	3 (2/1)	3 (2/1)	3 (2/1)	3 (2/1)	3 (2/1)	3 (2/1)	3 (2/1)
A/V JACKS	AUDIO OUT	<input type="checkbox"/>	<input type="checkbox"/>	<input type="checkbox"/>	<input type="checkbox"/>	<input type="checkbox"/>	<input type="checkbox"/>	<input type="checkbox"/>	<input type="checkbox"/>
	S-VHS INPUT	<input type="checkbox"/>	<input type="checkbox"/>	<input type="checkbox"/>	<input type="checkbox"/>	<input type="checkbox"/>	<input type="checkbox"/>	<input type="checkbox"/>	<input type="checkbox"/>
	COMPONENT INPUT	<input type="checkbox"/>	<input type="checkbox"/>	<input type="checkbox"/>	<input type="checkbox"/>	<input type="checkbox"/>	<input type="checkbox"/>	<input type="checkbox"/>	<input type="checkbox"/>
	HEADPHONE JACK	<input type="checkbox"/>	<input type="checkbox"/>	<input type="checkbox"/>	<input type="checkbox"/>	<input type="checkbox"/>	<input type="checkbox"/>	<input type="checkbox"/>	<input type="checkbox"/>

Congratulations

Your new TV features a solid state chassis that is designed to give you many years of enjoyment. It was thoroughly tested and tuned at the factory for best performance.

Customer Record

The model and serial number of this product are located on the back of the TV. You should note the model and serial number in the space provided and retain as a permanent record of your purchase. This will aid in identification in the event of theft or loss.

Model
Number

Serial
Number

Care and Cleaning

Screen (Turn TV Off)

- Use a mild soap solution or window cleaner with a soft clean cloth. DO NOT USE ABRASIVE CLEANERS.
- Avoid excessive moisture and wipe dry.

Note: Do not spray any type of cleaning fluid directly on the screen.

Cabinet and Remote Control

- For cabinets and remote control, use a soft cloth dampened with water or a mild detergent solution. Avoid excessive moisture and wipe dry.
- Do not use benzene, thinner or other petroleum based products.

Specifications

Power Source CT-27D11D (2.0A) CT-27D31C (2.1A) CT-2772SC (2.1A) CT-32D11C (2.2A) CT-32D31C (2.2A) CT-3274SC (2.2A) CT-36D11C (2.4A) CT-36D31C (2.4A)	120V AC, 60Hz
Channel Capability - 181	VHF-12; UHF-56; Cable-125
Video Input Jacks	1Vp-p, 75 Ohm, Phono Jack Type
Audio Input Jacks	500mV RMS 47K Ohm
Audio Output Jacks	0-2.0V RMS 4.7K Ohm
Component Input (Y / P_B / P_R)	75 Ohm, Phono Jack Type
S-Video Input Jacks	S-Video (Y-C) Connector

Specifications are subject to change without notice or obligation.

Installation

Television Location

This unit is intended to be used with an optional stand or entertainment centre. Consult your dealer for available options.

- Avoid excessive sunlight or bright lights, including reflections.
- Keep away from excessive heat or moisture. Inadequate ventilation may cause internal component failure.
- Fluorescent lighting may reduce remote control transmitting range.
- Keep away from magnetic equipment, including motors, fans and external speakers.

CAUTION: Use this television receiver only with the cart, stand, tripod, bracket, or table specified by the manufacturer, or sold with the apparatus. When a cart is used, use caution when moving the cart/apparatus combination to avoid injury from tip-over. In order to avoid injury to children, never place your television receiver on a piece of furniture that is capable of being tilted by a child leaning on it, pulling on it, standing on it, or climbing on it.



CT-27D11D, CT-27D31C, CT-2772SC:

CAUTION: This television receiver for use only with PANASONIC TY-27GPN stand. Use with other carts (or stands) is capable of resulting in instability causing possible injury.

CT-32D11C, CT-32D31C, CT-3274SC:

CAUTION: This television receiver for use only with PANASONIC TY-32GPN stand. Use with other carts (or stands) is capable of resulting in instability causing possible injury.

CT-36D11C, CT-36D31C:

CAUTION: This television receiver for use only with PANASONIC TY-36G22 stand. Use with other carts (or stands) is capable of resulting in instability causing possible injury.

Optional Cable Connections

Shielded audio and video cables should be used between components. For best results:

- Use 75-ohm coaxial shielded cables.
- Use appropriate input and output connectors, that match your component connectors.
- Avoid long cables to minimize interference.

AC Power Supply Cord

CAUTION: TO PREVENT ELECTRIC SHOCK MATCH WIDE BLADE OF PLUG TO WIDE SLOT OF AC OUTLET AND FULLY INSERT. DO NOT USE A PLUG WITH A RECEPTACLE OR OTHER OUTLET UNLESS THE BLADE CAN BE FULLY INSERTED TO PREVENT BLADE EXPOSURE.

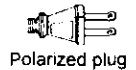

PROTECT POWER CORDS FROM BEING WALKED ON, ROLLED OVER, CRIMPED, BENT OR PINCHED, PARTICULARLY AT PLUGS, CONVENIENCE RECEPTACLES, AND THE POINT WHERE THEY EXIT FROM THE APPARATUS.

Cable / Antenna Connection

For proper reception, either a cable or antenna connection is required.

Cable Connection

Connect the cable supplied by your local cable company.

Note: A cable converter box may be required for proper reception. Check with your local cable company for compatibility requirements.

Incoming Cable from
Cable Company

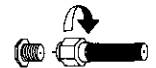



75 Ohm VHF/UHF
on back of TV

Antenna Connections

- For proper reception of VHF/UHF channels, an external antenna is required. For best reception an outdoor antenna is recommended.
- Antenna Mode must be set to TV.

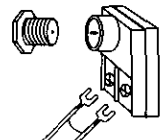
Incoming Cable from
Home Antenna



 Cable Preset
Cable Mode is preset at the factory. Antenna users must change to Antenna Mode in the Setup Menu.

Optional Equipment Connections

VCR Connection

VCRs, video disc players, video game equipment, and DSS equipment can also be connected to the video inputs. See the optional equipment manual for more information.

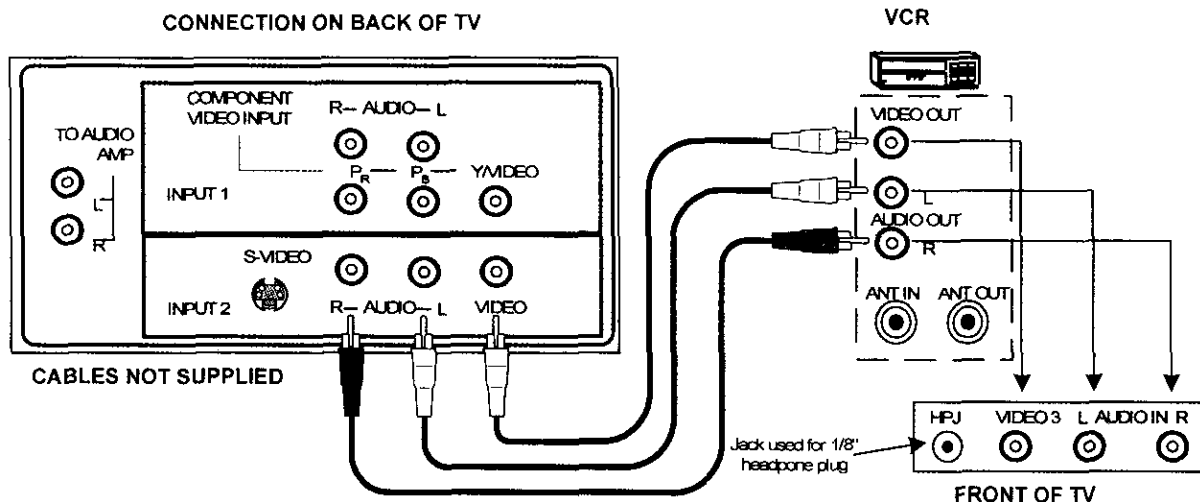

Procedure

1. Connect equipment as shown to front or rear Audio/Video input jacks.

Note: Front and rear Audio/Video connectors cannot be operated at the same time.

2. Select the Video mode by pressing TV/VIDEO button.
3. Operate optional equipment as instructed in equipment manual.

IMPORTANT INFORMATION REGARDING USE OF VIDEO GAMES, COMPUTERS, DSS OR OTHER FIXED IMAGE DISPLAYS.

The extended use of fixed image program material can cause a permanent "shadow image" on the picture tube. This background image is viewable on normal programs in the form of a stationary fixed image. This type of irreversible picture tube deterioration can be limited by observing the following steps:

- A. Reduce the brightness/contrast setting to a minimum viewing level.
- B. Do not display the fixed image for extended periods of time.
- C. Turn the power off when not in actual use.

Note: The marking or retained image on the picture tube resulting from fixed image use is not an operating defect and as such is not covered by Warranty. This product is not designed to display fixed image patterns for extended periods of time.

OPTIONAL EQUIPMENT CONNECTIONS

Digital TV - Set-Top Box (DTV-STB) or DVD Player Connection

Use this diagram to connect the Panasonic DTV-STB (Digital TV-Set-Top Box) to the back of your TV.

TERMINALS ON BACK OF DTV-STB OR DVD PLAYER

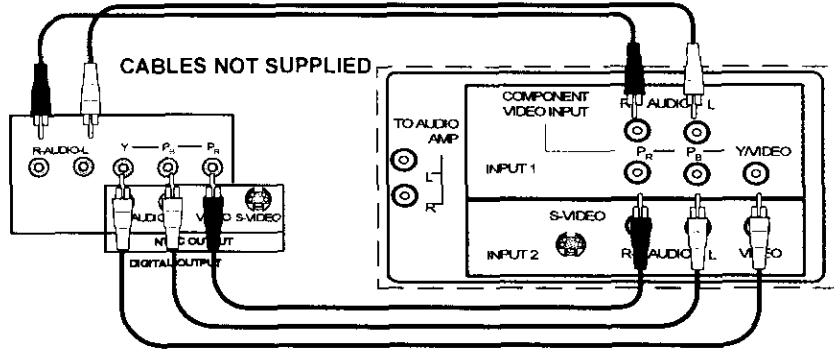

COMPONENT VIDEO INPUT TERMINALS ON BACK OF TV

Notes:

- There are three video inputs, Y, P_B, and P_R. Separate component colour inputs provide luminance and color separation. Use the L (left) and R (right) audio inputs.
- Select DTV-STB to 480i output mode. TV set can receive 480i signal only.

Amplifier Connection (To Audio Amp)

Connect to an external audio amplifier input for listening to a stereo system.

Note: TO AUDIO AMP terminals cannot be connected directly to external speakers.

Audio Adjustments

1. Select TV SPEAKERS ON from AUDIO menu.
2. Set amplifier volume to minimum.
3. Adjust TV volume to desired level.
4. Adjust amplifier volume to match the TV.
5. Select TV SPEAKERS OFF&VAO from AUDIO menu.
6. Volume, mute, bass, treble and balance are now controlled from the TV.

Note: In OFF&FAO the volume is controlled by the external amplifier.

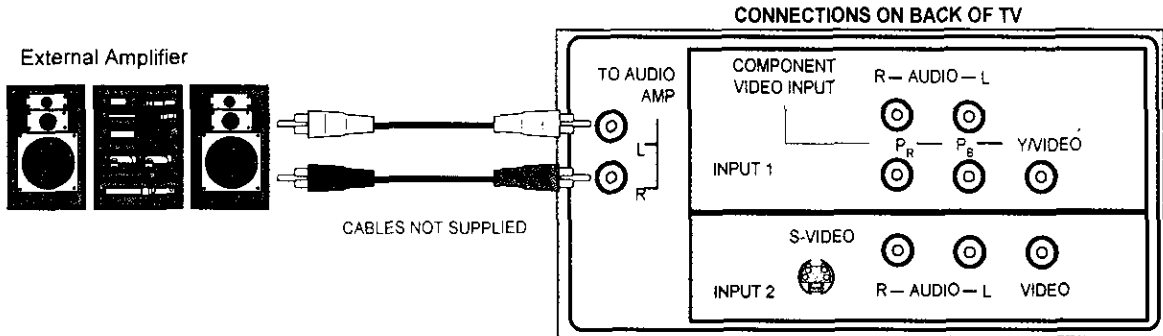

1 Tuner Picture In Picture (PIP) Operation Only

Note: Refer to the FEATURE COMPARISON CHART on page 3 for your television PIP capability.

PIP Operation with a VCR and Cable Box

This television includes a Picture In Picture (PIP) feature. A second video source (VCR, Camcorder, etc.) is required to provide a second picture. Connect your television to a VCR and Cable Box, as shown.

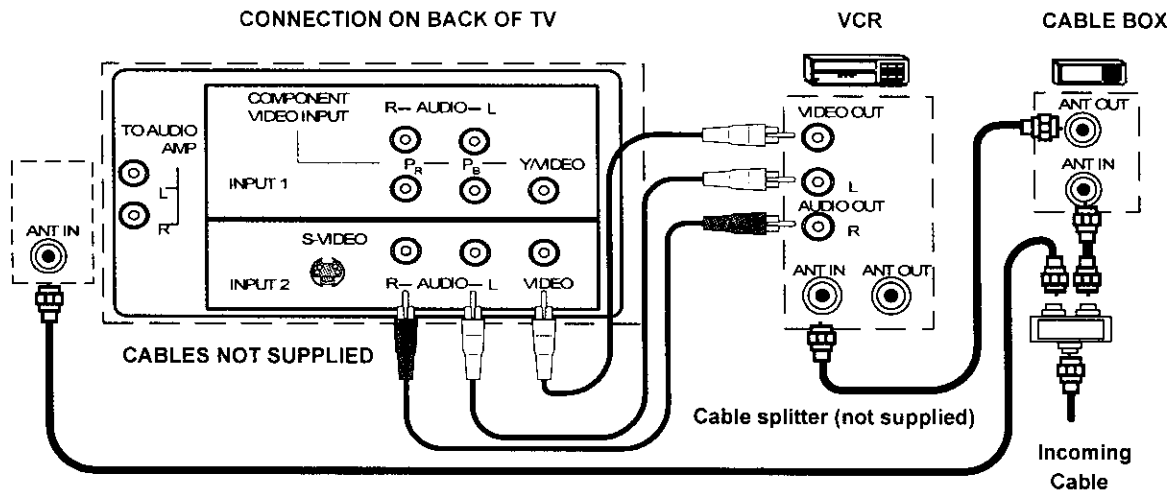

Note: The Remote Control must be programmed with supplied codes to operate the VCR and Cable Box. See Programming the Remote Control in the **Remote Control Quick Reference Guide**.

Procedure

Press the **PIP** button on the Remote Control to display the PIP frame.

Note: The PIP picture is the same as the main picture, initially.

To view a different picture in the PIP frame:

- Press the **TV/VIDEO** button on the Remote Control to select the video PIP source.
- Verify the **CABLE BOX** and **VCR** are **ON** and the VCR is tuned to **channel 3**.
- Choose channels for the *PIP* frame by pressing the **CBL** button on the Remote Control and using the numeric keypad or **CH** up/down buttons.
- Choose channels for the *Main Picture* by pressing the **TV** button on the Remote Control and using the numeric keypad or **CH** up/down buttons.

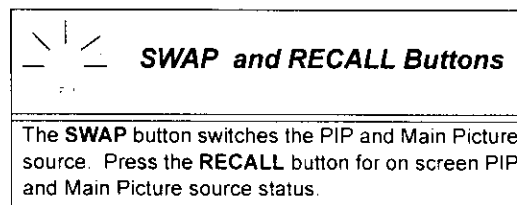

1 Tuner PIP Operation with a VCR - No Cable Box

Note: Refer to the FEATURE COMPARISON CHART on page 3 for your television PIP capability.

This television includes a Picture In Picture (PIP) feature. A second video source (VCR) is required to provide a second picture.

Connect your television to a VCR, as shown:

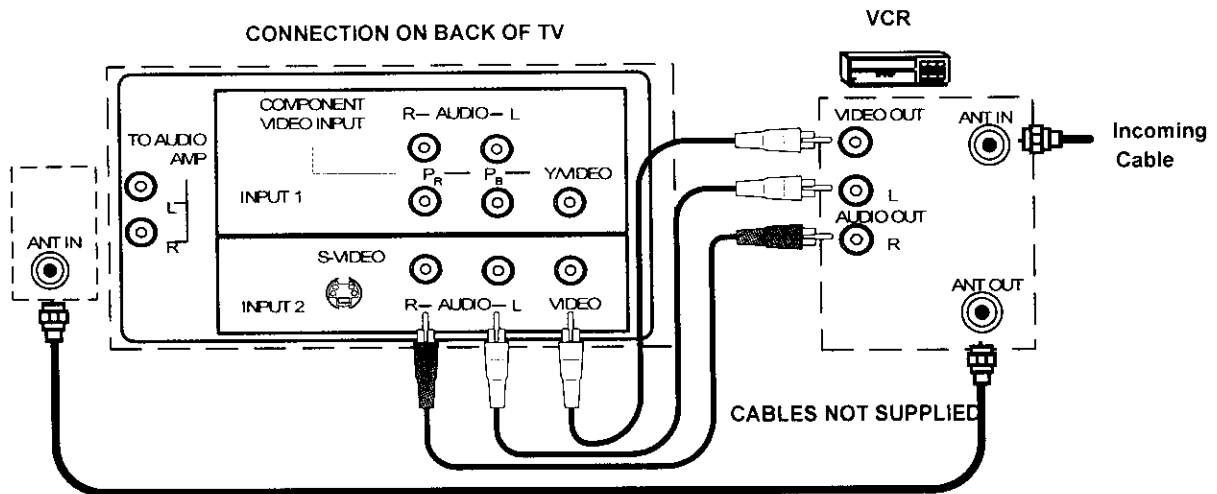

Note: The Remote Control must be programmed with the supplied codes to operate the VCR. See Programming the Remote Control in the Remote Control Quick Reference Guide.

Procedure

Turn the VCR OFF and tune the TV to channel 3.

Press the **PIP** button on the Remote Control to display the PIP frame on screen.

Note: The PIP picture is the same as the Main picture, initially.

- Press the **TV/VIDEO** button on the Remote Control to select the VIDEO PIP source.
- Press the **VCR** button on the Remote Control and turn ON the VCR.
- Press the **TV/VCR** button on the Remote Control.
- Choose channels for *PIP* frame by pressing **VCR CHANNEL** up/down buttons on the Remote Control.
- Choose channels for the *Main Picture* by pressing the **TV** button on the Remote Control and using the numeric keypad or **CH** up/down buttons.

	SWAP and RECALL Buttons
<p>The SWAP button switches the PIP and Main Picture source. Press the RECALL button for on screen PIP and Main Picture source status.</p>	

2 Tuner Picture In Picture (PIP) Operation

Note: Refer to the FEATURE COMPARISON CHART on page 3 for your television PIP capability.

PIP Operation with a VCR and Cable Box

This television includes a two tuner Picture In Picture (PIP) feature. This allows watching two (2) live broadcasts at the same time without or with an external video source (VCR).

Without A VCR (External Video Source)

Procedure

7. Connect incoming cable to antenna (ANT) input on back of TV.
8. Press the **PIP** button on the Remote Control to display the PIP frame.
Note: The audio is for the Main Picture only.
9. Choose channels for the **PIP** frame by pressing the Remote Control **PIP CHANNEL** up/down buttons.
10. Choose channels for the **Main Picture** by pressing the Remote Control **CH** up/down buttons or by using the numeric keypad.

With A VCR (External Video Source) And Cable Box

Connect your television to a VCR and Cable Box, as shown.

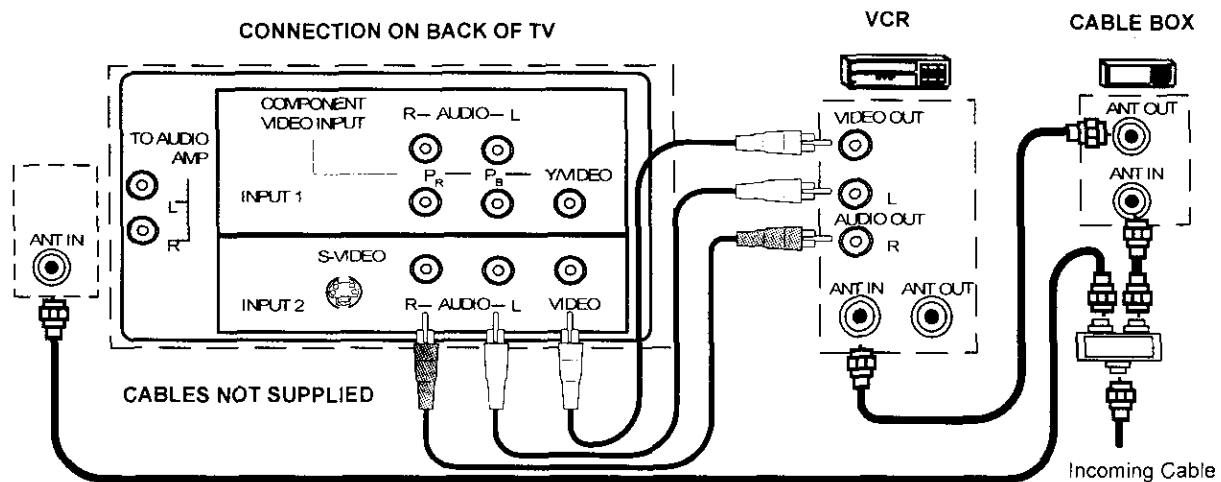

Note: The Remote Control must be programmed with supplied codes to operate the VCR and Cable Box. See Programming the Remote Control in the **Remote Control Quick Reference Guide**.

Procedure

Press the **PIP** button on the Remote Control to display the PIP frame.

Note: The audio is from the Main Picture only.

To view scrambled channels through your Cable Box in the PIP frame:

1. Press the **TV/VIDEO** button on the Remote Control to select the same video input to which your cable box is connected.
2. Verify the **CABLE BOX** and **VCR** are **ON** and the **VCR** tuned to channel 3.
3. Choose channels for the **PIP** frame by pressing the **CBL** button on the Remote Control and using the numeric keypad or **PIP CHANNEL** up/down buttons.
4. Choose channels for the **Main Picture** by pressing the **TV** button on the Remote Control and using the numeric keypad or **CH** up/down buttons.

Note: The **SWAP** button switches the on screen **PIP** and **Main Picture** source. Press the **RECALL** button for **PIP** and **Main Picture** source status.



2 TUNER PIP OPERATION WITH A VCR - NO CABLE BOX

2 Tuner PIP Operation with a VCR - No Cable Box

Note: Refer to the FEATURE COMPARISON CHART on page 3 for your television PIP capability.

This television includes a two tuner Picture In Picture (PIP) feature. This allows watching two (2) live broadcasts at the same time without or with an external video source (VCR).

Connect your television to a VCR, as shown.

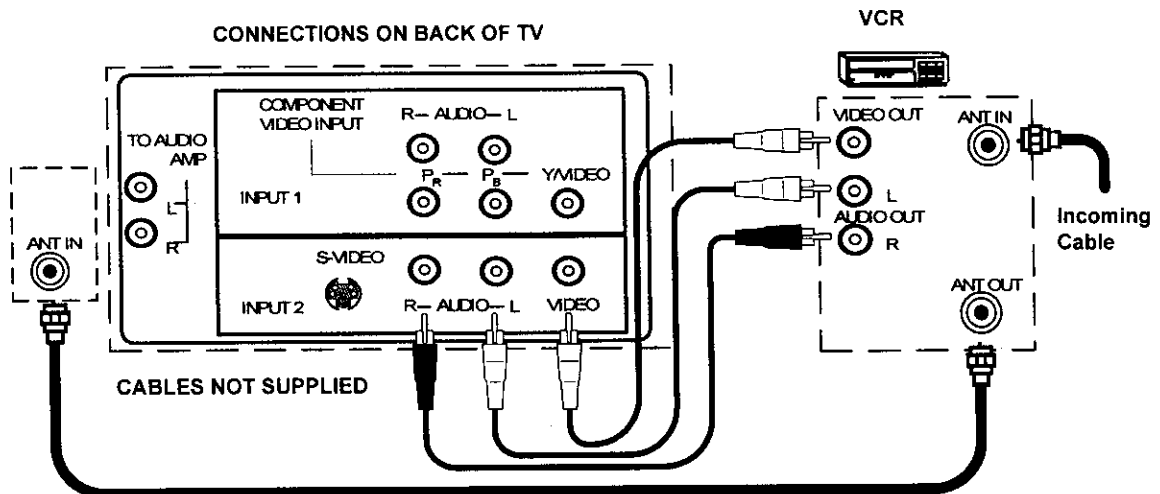

Note: The Remote Control must be programmed with the supplied codes to operate the VCR. See Programming the Remote Control in the Remote Control Quick Reference Guide.

Procedure

Press the **PIP** button on the Remote Control to display the PIP frame on screen.

Note: The audio is from the Main Picture only.

To view an external video source in the PIP frame:

1. Press the **TV/VIDEO** button on the Remote Control to select the same video input to which your **VCR** is connected.
2. Verify the **VCR** is on.
3. Choose channels for the *Main Picture* by pressing the **TV** button on the Remote Control and using the numeric keypad or **CH** up/down button.
4. Choose channels for the *PIP frame* by pressing the **TV** button on the Remote Control and using the **PIP Channel** up/down buttons.



SWAP and RECALL Buttons

The **SWAP** button switches the PIP and Main Picture source. Press the **RECALL** button for on screen PIP and Main Picture source status.

Main Menu

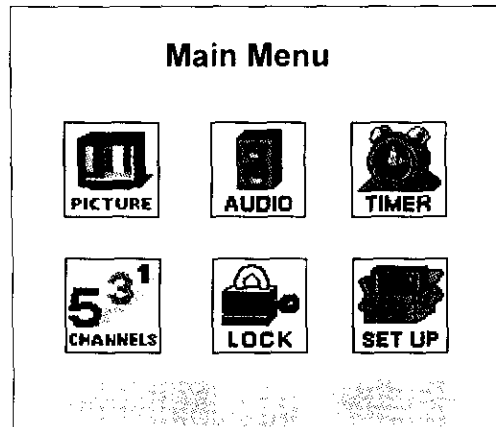

Procedures

1. Press the **ACTION** button on the remote control to display Main Menu.
2. Press the **CH** up/down or **VOL** right/left button to highlight the desired icon.
3. Press the **ACTION** button to display icon features and submenus.
4. Press the **CH** up/down buttons to select desired icon features.
5. Press the **VOL** right button to highlight submenus.
6. Press the **CH** up/down to select desired submenu.
7. Press the **VOL** right/left button to select or adjust submenu.
8. Press the **ACTION** button repeatedly to exit menus.

Remote Control Buttons

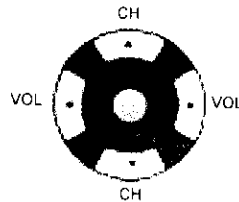

Remote ACTION / Navigation Button





Remote Control Guide

The **Remote Control Quick Reference Guide** is located within the package provided with this TV.

Main Menu Feature Chart

MENU	DESCRIPTION
 SET UP	SET UP
LANGUAGES	<input type="checkbox"/> Select English, Spanish, or French menu.
PROG. CHAN (Program Channels)	<input type="checkbox"/> MODE - Select Cable or TV. See Installation section in manual. <input type="checkbox"/> AUTO PROGRAM - Automatically program channels having a signal into memory. <input type="checkbox"/> MANUAL PROGRAM - Manually add or delete channels from memory.
 (Closed Captioning)	<input type="checkbox"/> CC ON MUTE - Activate C1-C2 for Closed Captioning display when the remote MUTE button is pressed. <input type="checkbox"/> CC MODE - Select C1 or C2 for Closed Captioning, program guides and other information.
OTHER ADJ.	<input type="checkbox"/> AUTO POWER ON - Select SET to power up the TV at the same time as the Cable Box or other components or select OFF. <input type="checkbox"/> CHAN BANNER - Select ON to display onscreen banner when changing channels. <i>Note: Press RECALL to display onscreen Channel Banner at any time.</i>
 AUDIO	AUDIO
AUDIO ADJ. (Adjustments)	<input type="checkbox"/> MODE - Select STEREO, SAP (Second Audio Program) or MONO. (Use MONO when stereo signal is weak.) <input type="checkbox"/> BASS - Increase or decrease the bass response. <input type="checkbox"/> TREBLE - Increase or decrease the treble response. <input type="checkbox"/> BALANCE - Emphasize the left/right speaker volume. <input type="checkbox"/> NORMAL - Reset BASS, TREBLE and BALANCE to factory default.
OTHER ADJ. (Adjustments)	<input type="checkbox"/> AI SOUND - Automatically adjust volume to maintain a comfortable listening level. (AI sound is not available in VIDEO mode).
SURROUND	<input type="checkbox"/> Enhances audio response when listening to stereo.

Main Menu Feature Chart (Cont.)

MENU	DESCRIPTION
SPEAKERS	<input type="checkbox"/> ON - TV speakers operate normally. <input type="checkbox"/> OFF & VAO (Variable Audio Output) - TV speakers off - audio adjustable by TV. <input type="checkbox"/> OFF & FAO (Fixed Audio Output)- TV speakers off - audio adjustable only by the external amplifier.
 TIMER	TIMER
CLOCK SET	<input type="checkbox"/> Set the time and the day of the week. (Time will display onscreen after turning on the television, pressing the RECALL button or changing channels).
SLEEP	<input type="checkbox"/> Set timer to turn off TV in 30, 60 or 90 minutes. Select NO to turn timer off.
TIMER 1 TIMER 2	<input type="checkbox"/> Set one or both timers to automatically turn television on and off at selected times, on selected channels, and on selected days. (Clock must be set to use Timer features).
 PICTURE	PICTURE
VIDEO ADJ. (Adjustments)	<input type="checkbox"/> COLOR - Adjust desired colour intensity. <input type="checkbox"/> TINT - Adjust natural flesh tones. <input type="checkbox"/> BRIGHTNESS - Adjust dark areas for crisp detail. <input type="checkbox"/> PICTURE - Adjust white areas of picture. <input type="checkbox"/> SHARPNESS - Adjust clarity of outline detail. <input type="checkbox"/> NORMAL- Reset all picture adjustments to factory default settings.
OTHER ADJ. (Adjustments)	<input type="checkbox"/> COLOR TEMP - Adjust white balance to COOL (blue), WARM (red) or NORMAL..
 CHANNELS	CHANNELS
FAVORITES	<input type="checkbox"/> CHANNEL SCAN - Select FAV (16 FAVOURITES) or ALL channels to scan channels using the up/down CH buttons.

Main Menu Feature Chart (Cont.)

MENU	DESCRIPTION
CAPTION	<input type="checkbox"/> MANUAL CAPTION - Enter channel numbers and captions manually. <input type="checkbox"/> INPUT LABEL - Label video connections for onscreen display of optional equipment. <i>Note: This receiver has a skip feature, which will allow the user to skip Input modes when pressing TV/VIDEO button.</i>
 LOCK	LOCK
MODE	<input type="checkbox"/> Lock All Channels or Game with a secret code. <i>Note: For more information about Block Programs, see the V-CHIP Parental Lock manual provided with the TV package.</i>
HOW LONG?	<input type="checkbox"/> Select the period of time (12, 24, 48 hours or ALWAYS) for your option to be locked.

Special Features

SET UP

Menu Languages

In SET UP Menu, select IDIOMA / LANGUE to change menu language to ENGLISH, ESPAÑOL (Spanish), or FRANÇAIS (French).

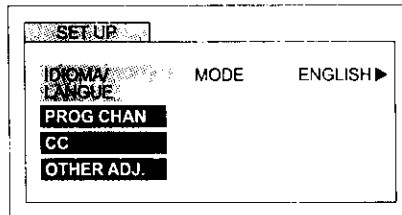

Prog Chan (Program Channels)

In SET UP menu under PROG CHAN select:

- MODE to select TV (antenna) or CABLE mode depending on the signal source.
- AUTO PROGRAM to automatically program all channels with a signal.
- MANUAL PROGRAM to manually add or delete channels.

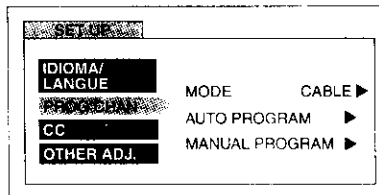

CC (Closed Captioning)

This television contains a built-in decoder that displays **CC** (closed captioned) text across the screen. It allows the viewer to read the dialogue of a television program or other information. The program viewed must include Closed Captioning for the feature to work.

in SET UP menu under **CC**, select:

- CC** On Mute to activate C1-C2 for Closed Captioning display when the remote MUTE button is pressed.
- CC** MODE to select C1 or C2 for Closed Captioning, program guides and other information.

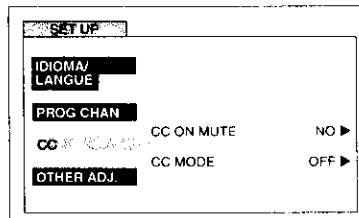

Other Adjustments

- Auto Power ON - Select SET to power up the TV at the same time as the Cable Box or other components or select OFF.
- Channel Banner - Select ON to display onscreen banner when changing channels.

TIMER

Sleep

In TIMER menu, select SLEEP to turn TV off in 30, 60 or 90 minutes. Select NO to turn off timer.

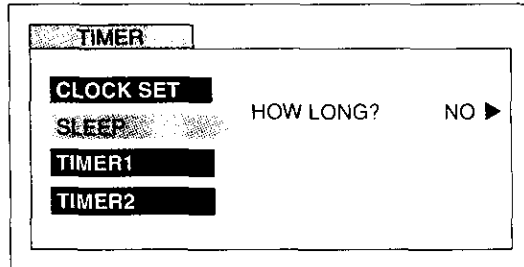

Timer 1 and Timer 2

In TIMER menu, select one or both timers to turn the television on and off at selected times, on selected channels, and on selected days.

Note: TIME must be entered in CLOCK SET to operate TIMER features.

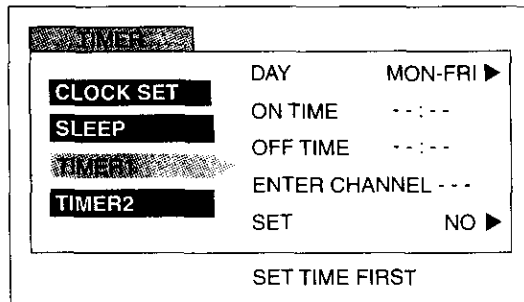

Turn Off After 90 Minutes

The TV automatically turns OFF after 90 minutes when turned on by the TIMER. If the OFF time is selected or if a key is pressed, the automatic OFF after 90 minutes will be cancelled.



TIMER Activation

The TIMER is active when the TV is OFF or ON. The TV will switch to the selected channel at the selected time set in the TIMER.

PICTURE

Video Adjustments

In Picture menu under VIDEO ADJ. select:

- COLOR - Adjust desired color intensity.
- TINT - Adjust natural flesh tones.
- BRIGHTNESS - Adjust dark areas for crisp detail.
- PICTURE - Adjust white areas of picture.
- SHARPNESS - Adjust clarity of outline detail.
- NORMAL - Reset all picture adjustments to factory default settings.

Note: Video adjustments can be individually set for each video input mode.

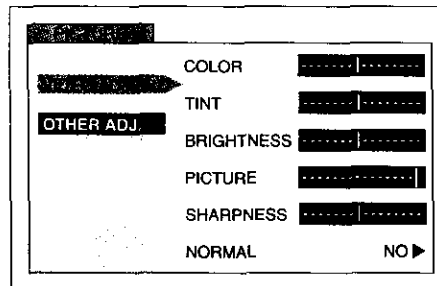

Other Adjustments

In Picture menu under OTHER ADJ. select:

- COLOR TEMP to increase and decrease WARM (red) and COOL (blue) colors to suit personal preferences

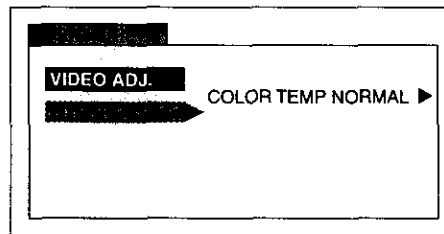

SPECIAL FEATURES

CHANNELS

Favorites

In CHANNELS menu under FAVORITES select:

- CHANNEL SCAN FAV to enter up to 16 favorite channels.
- CHANNEL SCAN ALL to scan all channels when using the CH up/down buttons.

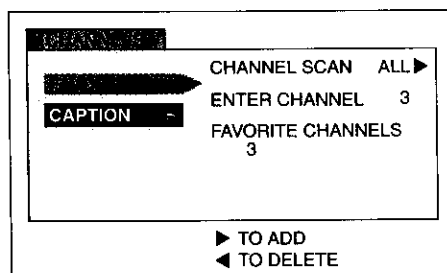

Caption

In CHANNELS menu under CAPTION select:

- MANUAL CAPTION to enter numbers and captions manually.
- INPUT LABEL to label video input connections for onscreen display.

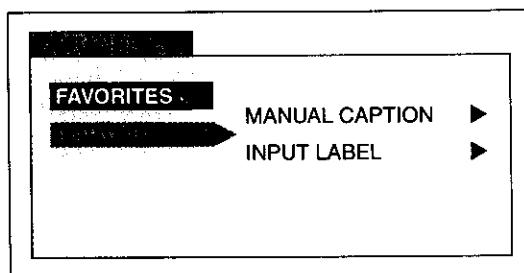

Video Input Skip Feature

This receiver has a Video Input Skip Feature, which will allow the user to skip desired Input modes when pressing TV/VIDEO button.

- Select desired video Input mode (VIDEO 1, VIDEO 2, or VIDEO 3.)
- Press the volume left button while the first character is highlighted to skip selected Video mode.

Note: To delete skip feature, press the volume right button while the desired video input mode is highlighted.

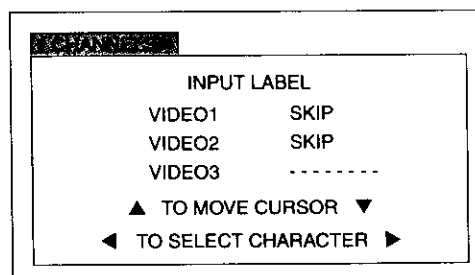

LOCK

MODE

To use LOCK options:

- ENTER CODE FIRST - Use the numeric keypad to enter a four-digit secret code. After entering your secret code for the first time, the onscreen display will change to CHANGE CODE.

Note: Use a code that is easy to remember or record it in a safe place.

In MODE submenu select:

- LOCK SET to choose:
 - OFF - To turn lock function off.
 - ALL - To lock all channels and video inputs.
 - CHANNEL - To lock up to four channels of your choice.
 - GAME - To lock channels 3, 4 and video inputs.

BLOCK PROGRAMS* - To use Block Programs Ratings.

CHANGE CODE - Use numeric keypad to change your four-digit secret code.

Note: If in CHANGE CODE you enter a different code from the one used previously, the new code becomes the controlling code.

Press the **ACTION** button to return to submenu, then select HOW LONG to choose the period of time you want your option to be locked (12, 24, 48 hours or ALWAYS).

Note: Be cautious when selecting ALWAYS. If ALWAYS is selected, and you forget your secret code, the television must be serviced by a qualified technician in order to clear the LOCK setup.

Press the **ACTION** button to return to submenu, and to exit menus.

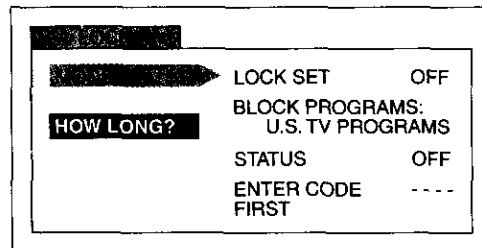

















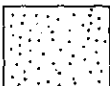

Note: If GAME, CHANNEL or ALL is selected, and if a blocked channel or video input is selected, the message PG (Parent Guard) displays in the upper right corner of the television screen.

Unlock LOCK SET by reentering the same four-digit secret code and selecting OFF.

*For more information about Block Programs, see the V-CHIP Parental Lock manual provided with the TV package.

Troubleshooting Chart

Before calling for service, determine the symptoms and follow suggested solutions.

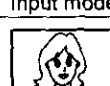
AUDIO	VIDEO	Solutions
 Noisy Audio	 Snowy Video	Adjust Antenna Location and Connection
 Noisy Audio	 Multiple Image	Adjust Antenna Location and Connection Check Antenna Lead-in Wire
 Noisy Audio	 Interference	Move TV from Electrical Appliances, Lights, Vehicles, and Medical Equipment
 No Audio	 Normal Video	Increase Volume Check Mute Check TV SPEAKERS on/off Change Channel
 Noisy Audio	 No Video with Snow	Set TV or Cable Mode Properly Check Antenna Cables
 No Audio	 No Video / No PIP	Check Power Cord is Plugged into Active Outlet Adjust Brightness and Audio Controls Change Channel Check Cable Connections Program the Remote Control Again Check Second Video Source Operation
 Normal Audio	 No Color	Adjust Color Settings Change Channel
 Wrong Audio	 Normal Video	Check Audio Is Set To Stereo Or Mono, Not SAP
 Normal Audio	 Missing Video Input mode	De-Select Skip Feature Located In The Channel Menu
 Normal Audio	 Normal Video	Replace Remote Control Batteries
Intermittent Remote Control Operation		

Panasonic Canada Inc.
5770 Ambler Drive
Mississauga, Ontario
Canada L4W 2T3
Tel.: (905) 624-5010
Télc.: (905) 624-9714
www.panasonic.ca

