

Owner's Manual

CRAFTSMAN®

**20.0 HP
ELECTRIC START
42" MOWER
6 SPEED TRANSAXLE
LAWN TRACTOR**

Model No.
917.272431

- Safety
- Assembly
- Operation
- Maintenance
- Repair Parts

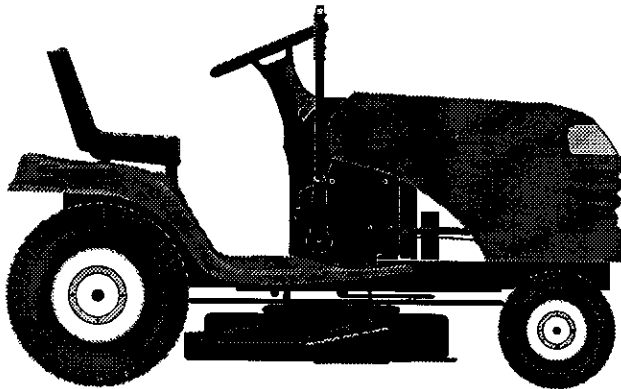

This product has a low emission engine which operates differently from previously built engines. Before you start the engine, read and understand this Owner's Manual.

CAUTION:

Read and follow all Safety Rules and Instructions before operating this equipment.

For answers to your questions about this product, Call:

1-800-659-5917
Sears Craftsman Help Line
5 am - 5 pm, Mon - Sat

Sears, Roebuck and Co., Hoffman Estates, IL 60179
Visit our Craftsman website: www.sears.com/craftsman

TABLE OF CONTENTS

Warranty	2	Maintenance	19
Safety Rules	3	Service and Adjustments	23
Product Specifications	6	Storage	29
Assembly	8	Troubleshooting	30
Operation	12	Repair Parts	34
Maintenance Schedule	19	Parts Ordering	Back Cover

WARRANTY

LIMITED TWO YEAR WARRANTY ON CRAFTSMAN RIDING EQUIPMENT PARTS

For two (2) years from the date of purchase, if this Craftsman Riding Equipment is maintained, lubricated and tuned up according to the instructions in the owner's manual, Sears will repair or replace, free of charge, any parts found to be defective in material or workmanship. Warranty service is available free of charge by returning your Craftsman riding equipment to your nearest Sears Service Center. In-home warranty service is available but a trip charge will apply. This warranty applies only while this product is in the United States.

This Warranty does not cover:

- Expendable items which become worn during normal use, such as blades, spark plugs, air cleaners, belts and oil filters.
- Tire replacement or repair caused by punctures from outside objects, such as nails, thorns, stumps, or glass.
- Repairs necessary because of operator abuse, including but not limited to, damage caused by towing objects beyond the capability of the riding equipment, impacting objects that bend the frame or crankshaft, or over speeding the engine.
- Repairs necessary because of operator negligence, including but not limited to, electrical and mechanical damage caused by improper storage, failure to use the proper grade and amount of engine oil, failure to keep the deck clear of flammable debris, or the failure to maintain the equipment according to the instructions contained in the owner's manual.
- Engine (fuel system) cleaning or repairs caused by fuel determined to be contaminated or oxidized (stale). In general, fuel should be used within thirty (30) days of its purchase date.
- Riding equipment used for commercial or rental purposes. A product is "used for commercial purpose" if it is used for any purpose other than single family household dwellings or in usage where profit is made.

LIMITED 90 DAY WARRANTY ON BATTERY

For ninety (90) days from date of purchase, if any battery included with this riding equipment proves defective in material or workmanship and our testing determines the battery will not hold a charge, Sears will replace the battery at no charge. Warranty service is available free of charge by returning your Craftsman riding equipment to your nearest Sears Service Center. In-home warranty service is available but a trip charge will apply. This warranty applies only while this product is in the United States.

TO LOCATE THE NEAREST SEARS SERVICE CENTER OR TO SCHEDULE IN-HOME WARRANTY SERVICE, SIMPLY CONTACT SEARS AT 1-800-4-MY-HOME

This Warranty gives you specific legal rights, and you may also have other rights which may vary from state to state.

Sears, Roebuck and Co., D/817 WA, Hoffman Estates, IL 60179

SAFETY RULES

IMPORTANT: This cutting machine is capable of amputating hands and feet and throwing objects. Failure to observe the following safety instructions could result in serious injury or death.

I. GENERAL OPERATION

- Read, understand, and follow all instructions in the manual and on the machine before starting.
- Only allow responsible adults, who are familiar with the instructions, to operate the machine.
- Clear the area of objects such as rocks, toys, wire, etc., which could be picked up and thrown by the blade.
- Be sure the area is clear of other people before mowing. Stop machine if anyone enters the area.
- Never carry passengers.
- Do not mow in reverse unless absolutely necessary. Always look down and behind before and while backing.
- Be aware of the mower discharge direction and do not point it at anyone. Do not operate the mower without either the entire grass catcher or the guard in place.
- Slow down before turning.
- Never leave a running machine unattended. Always turn off blades, set parking brake, stop engine, and remove keys before dismounting.
- Turn off blades when not mowing.
- Stop engine before removing grass catcher or unclogging chute.
- Mow only in daylight or good artificial light.
- Do not operate the machine while under the influence of alcohol or drugs.
- Watch for traffic when operating near or crossing roadways.
- Use extra care when loading or unloading the machine into a trailer or truck.
- Data indicates that operators, age 60 years and above, are involved in a large percentage of riding mower-related injuries. These operators should evaluate their ability to operate the riding mower safely enough to protect themselves and others from serious injury.
- Keep machine free of grass, leaves or other debris build-up which can touch hot exhaust / engine parts and burn. Do not allow the mower deck to plow leaves or other debris which can cause build-up to occur. Clean any oil or fuel spillage before operating or storing the machine. Allow machine to cool before storage.

II. SLOPE OPERATION

Slopes are a major factor related to loss-of-control and tipover accidents, which can result in severe injury or death. All slopes require extra caution. If you cannot back up the slope or if you feel uneasy on it, do not mow it.

DO:

- Mow up and down slopes, not across.
- Remove obstacles such as rocks, tree limbs, etc.
- Watch for holes, ruts, or bumps. Uneven terrain could overturn the machine. *Tall grass can hide obstacles.*
- Use slow speed. Choose a low gear so that you will not have to stop or shift while on the slope.
- Follow the manufacturer's recommendations for wheel weights or counterweights to improve stability.
- Use extra care with grass catchers or other attachments. These can change the stability of the machine.
- Keep all movement on the slopes *slow* and *gradual*. Do not make sudden changes in speed or direction.
- Avoid starting or stopping on a slope. If tires lose traction, disengage the blades and proceed slowly *straight* down the slope.

DO NOT:

- *Do not* turn on slopes unless necessary, and then, turn slowly and gradually downhill, if possible.
- *Do not* mow near drop-offs, ditches, or embankments. The mower could suddenly turn over if a wheel is over the edge of a cliff or ditch, or if an edge caves in.
- *Do not* mow on wet grass. Reduced traction could cause sliding.
- *Do not* try to stabilize the machine by putting your foot on the ground.
- *Do not* use grass catcher on steep slopes.

SAFETY RULES

III. CHILDREN

Tragic accidents can occur if the operator is not alert to the presence of children. Children are often attracted to the machine and the mowing activity. *Never* assume that children will remain where you last saw them.

- Keep children out of the mowing area and under the watchful care of another responsible adult.
- Be alert and turn machine off if children enter the area.
- Before and when backing, look behind and *down* for small children.
- Never carry children. They may fall off and be seriously injured or interfere with safe machine operation.
- Never allow children to operate the machine.
- Use extra care when approaching blind corners, shrubs, trees, or other objects that may obscure vision.

IV. SERVICE

- Use extra care in handling gasoline and other fuels. They are flammable and vapors are explosive.
 - Use only an approved container.
 - Never remove gas cap or add fuel with the engine running. Allow engine to cool before refueling. Do not smoke.
 - Never refuel the machine indoors.
 - Never store the machine or fuel container inside where there is an open flame, such as a water heater.

- Never run a machine inside a closed area.
- Keep nuts and bolts, especially blade attachment bolts, tight and keep equipment in good condition.
- Never tamper with safety devices. Check their proper operation regularly.
- Keep machine free of grass, leaves, or other debris build-up. Clean oil or fuel spillage. Allow machine to cool before storing.
- Stop and inspect the equipment if you strike an object. Repair, if necessary, before restarting.
- Never make adjustments or repairs with the engine running.
- Grass catcher components are subject to wear, damage, and deterioration, which could expose moving parts or allow objects to be thrown. Frequently check components and replace with manufacturer's recommended parts, when necessary.
- Mower blades are sharp and can cut. Wrap the blade(s) or wear gloves, and use extra caution when servicing them.
- Check brake operation frequently. Adjust and service as required.





- Be sure the area is clear of other people before mowing. Stop machine if anyone enters the area.
- Never carry passengers or children even with the blades off.
- Do not mow in reverse unless absolutely necessary. Always look down and behind before and while backing.
- Never carry children. They may fall off and be seriously injured or interfere with safe machine operation.
- Keep children out of the mowing area and under the watchful care of another responsible adult.
- Be alert and turn machine off if children enter the area.
- Before and when backing, look behind and down for small children.
- Mow up and down slopes (15° Max), not across.
- Remove obstacles such as rocks, tree limbs, etc.
- Watch for holes, ruts, or bumps. Uneven terrain could overturn the machine. Tall grass can hide obstacles.

SAFETY RULES

- Use slow speed. Choose a low gear so that you will not have to stop or shift while on the slope.
- Avoid starting or stopping on a slope. If tires lose traction, disengage the blades and proceed slowly straight down the slope.
- If machine stops while going uphill, disengage blades, shift into reverse and back down slowly.
- Do not turn on slopes unless necessary, and then, turn slowly and gradually downhill, if possible.

 Look for this symbol to point out important safety precautions. It means **CAUTION!!! BECOME ALERT!!! YOUR SAFETY IS INVOLVED.**

 **CAUTION:** In order to prevent accidental starting when setting up, transporting, adjusting or making repairs, always disconnect spark plug wire and place wire where it cannot contact spark plug.

 **CAUTION:** Do not coast down a hill in neutral, you may lose control of the tractor.

 **CAUTION:** Tow only the attachments that are recommended by and comply with specifications of the manufacturer of your tractor. Use common sense when towing. Operate only at the lowest possible speed when on a slope. Too heavy of a load, while on a slope, is dangerous. Tires can lose traction with the ground and cause you to lose control of your tractor.

 **WARNING:** Engine exhaust, some of its constituents, and certain vehicle components contain or emit chemicals known to the State of California to cause cancer and birth defects or other reproductive harm.

 **WARNING:** Battery posts, terminals and related accessories contain lead and lead compounds, chemicals known to the State of California to cause cancer and birth defects or other reproductive harm. **Wash hands after handling.**

PRODUCT SPECIFICATIONS

GASOLINE CAPACITY AND TYPE:	1.25 GALLONS UNLEADED REGULAR
OIL TYPE (API-SF-SJ):	SAE 30 (ABOVE 32°F) SAE 5W-30 (BELOW 32°F)
OIL CAPACITY:	4.0 PINTS
SPARK PLUG: (GAP: .040")	CHAMPION RC12YC
GROUND SPEED FORWARD (MPH):	1 ST 1.2 2 ND 1.5 3 RD 2.4 4 TH 3.5 5 TH 4.8 6 TH 5.3 REVERSE: 1.5
TIRE PRESSURE:	FRONT: 14 PSI REAR: 10 PSI
CHARGING SYSTEM:	16AMPS @ 3600 RPM
BATTERY:	AMP/HR: 28 MIN. CCA: 230 CASE SIZE: U1R
BLADE BOLT TORQUE:	27-35 FT. LBS.

CONGRATULATIONS on your purchase of a new tractor. It has been designed, engineered and manufactured to give you the best possible dependability and performance. Should you experience any problem you cannot easily remedy, please contact a Sears or other qualified service center. We have competent, well-trained technicians and the proper tools to service or repair this tractor.

Please read and retain this manual. The instructions will enable you to assemble and maintain your tractor properly. Always observe the "SAFETY RULES".

REPAIR AGREEMENT

A Repair Agreement is available on this product. Contact your nearest Sears store for details.

CUSTOMER RESPONSIBILITIES

- Read and observe the safety rules.
- Follow a regular schedule in maintaining, caring for and using your tractor.
- Follow the instructions under "Maintenance" and "Storage" sections of this owner's manual.

 **WARNING:** This tractor is equipped with an internal combustion engine and should not be used on or near any unimproved forest-covered, brush-covered or grass-covered land unless the engine's exhaust system is equipped with a spark arrester meeting applicable local or state laws (if any). If a spark arrester is used, it should be maintained in effective working order by the operator. In the state of California the above is required by law (Section 4442 of the California Public Resources Code). Other states may have similar laws. Federal laws apply on federal lands. A spark arrester for the muffler is available through your nearest Sears service center (See REPAIR PARTS section of this manual).

UNASSEMBLED PARTS

Steering Wheel



Steering Wheel Insert

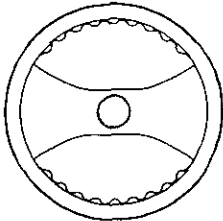

(1) Hex Bolt
3/8-16 x 1

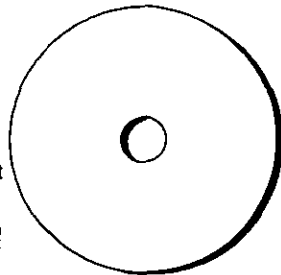
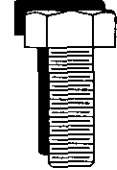

(1) Large Flat Washer



(1) Hex Bolt 5/16-18 x 1-1/4



(1) Locknut 5/16-18



(1) Lockwasher 3/8



Steering Extension Shaft



Steering Wheel Adapter



Steering Boot

Seat

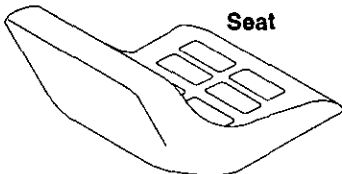

- (1) Washer
17/32 x 1-3/16 x 12 Gauge
- (1) Knob

Keys

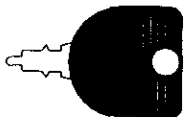

(2) Keys

(1) Oil Drain Tube
For Future Use



Slope Sheet

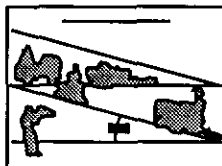

Video Cassette

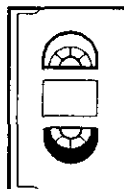

ASSEMBLY

Your new tractor has been assembled at the factory with exception of those parts left unassembled for shipping purposes. To ensure safe and proper operation of your tractor all parts and hardware you assemble must be tightened securely. Use the correct tools as necessary to insure proper tightness. Review the video cassette before you begin.

TOOLS REQUIRED FOR ASSEMBLY

A socket wrench set will make assembly easier. Standard wrench sizes you need are listed below.

- (1) 9/16" wrench (2) 1/2" wrench
- (1) Utility knife (1) Pliers
- (1) Tire pressure gauge

When right or left hand is mentioned in this manual, it means, from your point of view, when you are in the operating position (seated behind the steering wheel).

TO REMOVE TRACTOR FROM CARTON

UNPACK CARTON

1. Remove all accessible loose parts and parts cartons from carton.
2. Cut, from top to bottom, along lines on all four corners of carton, and lay panels flat.
3. Check for any additional loose parts or cartons and remove.

BEFORE REMOVING TRACTOR FROM SKID

ATTACH STEERING WHEEL

ASSEMBLE EXTENSION SHAFT AND BOOT

1. Slide extension shaft onto lower steering shaft. Align mounting holes in extension and lower shafts and install 5/16 hex bolt and locknut. Tighten securely.

IMPORTANT: Tighten bolt and nut securely to 18-22 ft. lbs torque.

2. Place tabs of steering boot over tab slots in dash and push down to secure.

INSTALL STEERING WHEEL

3. Position front wheels of the tractor so they are pointing straight forward.
4. Remove steering wheel adapter from steering wheel and slide adapter onto steering shaft extension.
5. Position steering wheel so cross bars are horizontal (left to right) and slide inside boot and onto adapter.

6. Assemble large flat washer, 3/8 lock washer, 3/8 hex bolt and tighten securely.
7. Snap steering wheel insert into center of steering wheel.
8. Remove protective materials from tractor hood and grill.

IMPORTANT: Check for and remove any staples in skid that may puncture tires where tractor is to roll off skid.

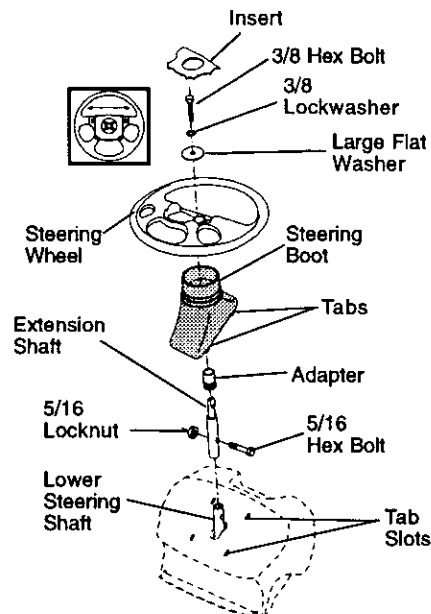

HOW TO SET UP YOUR TRACTOR

CHECK BATTERY

1. Lift seat pan to raised position and open battery box door.
- NOTE:** If this battery is put into service after month and year indicated on label (label located between terminals) charge battery for minimum of one hour at 6-10 amps. (See "BATTERY" in Maintenance section of this manual for charging instructions).

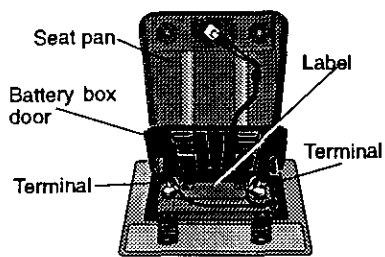

INSTALL SEAT

Adjust seat before tightening adjustment knob.

1. Remove adjustment knob and flat washer securing seat to cardboard packing and set aside for assembly of seat to tractor.
2. Pivot seat upward and remove from the cardboard packing. Remove the cardboard packing and discard.
3. Place seat on seat pan so head of shoulder bolt is positioned over large slotted hole in pan.
4. Push down on seat to engage shoulder bolt in slot and pull seat towards rear of tractor.
5. Pivot seat and pan forward and assemble adjustment knob and flat washer loosely. Do not tighten.
6. Lower seat into operating position and sit in seat.
7. Slide seat until a comfortable position is reached which allows you to press clutch/brake pedal all the way down.
8. Get off seat without moving its adjusted position.
9. Raise seat and tighten adjustment knob securely.

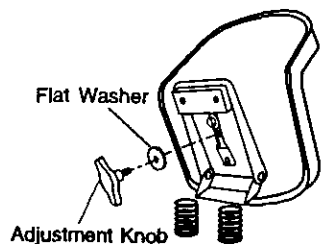
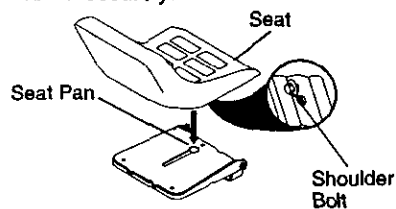

NOTE: You may now roll or drive your tractor off the skid. Follow the appropriate instruction below to remove the tractor from the skid.

TO ROLL TRACTOR OFF SKID (See Operation section for location and function of controls)

1. Press lift lever plunger and raise attachment lift lever to its highest position.
2. Release parking brake by depressing clutch/brake pedal.
3. Place gearshift lever in neutral (N) position.
4. Roll tractor forward off skid.
5. Remove banding holding deflector shield up against tractor.

TO DRIVE TRACTOR OFF SKID (See Operation section for location and function of controls)

WARNING: Before starting, read, understand and follow all instructions in the Operation section of this manual. Be sure tractor is in a well-ventilated area. Be sure the area in front of tractor is clear of other people and objects.

1. Be sure all the above assembly steps have been completed.
2. Check engine oil level and fill fuel tank with gasoline.
3. Sit on seat in operating position, depress clutch/brake pedal and set the parking brake.
4. Place gear shift lever in neutral (N) position.
5. Press lift lever plunger and raise attachment lift lever to its highest position.
6. Start the engine. After engine has started, move throttle control to idle position.
7. Depress clutch/brake pedal into full "BRAKE" position and hold. Move gearshift lever to 1st gear.
8. Slowly release clutch/brake pedal and slowly drive tractor off skid.
9. Apply brake to stop tractor, set parking brake and place gearshift lever in neutral position.
10. Turn ignition key to "OFF" position. Continue with the instructions that follow.

INSTALL MULCHER PLATE

(If previously removed)

1. Raise and hold deflector shield in upright position.
2. Place front of mulcher plate over front of mower deck opening and slide into place, as shown.
3. Hook front latch into hole on front of mower deck.
4. Hook rear latch into hole on back of mower deck.

CAUTION: Do not remove deflector shield from mower. Raise and hold shield when attaching mulcher plate and allow it to rest on plate while in operation.

TO CONVERT TO BAGGING OR DISCHARGING

Simply remove mulcher plate and store in a safe place. Your mower is now ready for discharging or installation of optional grass catcher accessory.

NOTE: It is not necessary to change blades. The mulcher blades are designed for discharging and bagging also.

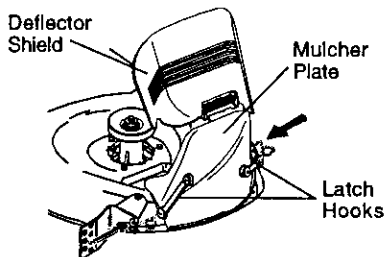

CHECK TIRE PRESSURE

The tires on your tractor were overinflated at the factory for shipping purposes. Correct tire pressure is important for best cutting performance.

- Reduce tire pressure to PSI shown in "PRODUCT SPECIFICATIONS" section of this manual.

CHECK DECK LEVELNESS

For best cutting results, mower housing should be properly leveled. See "TO LEVEL MOWER HOUSING" in the Service and Adjustments section of this manual.

CHECK FOR PROPER POSITION OF ALL BELTS

See the figures that are shown for replacing motion and mower blade drive belts in the Service and Adjustments section of this manual. Verify that the belts are routed correctly.

CHECK BRAKE SYSTEM

After you learn how to operate your tractor, check to see that the brake is properly adjusted. See "TO ADJUST BRAKE" in the Service and Adjustments section of this manual.

✓CHECKLIST

Before you operate and enjoy your new tractor, we wish to assure that you receive the best performance and satisfaction from this quality product.

Please review the following checklist:











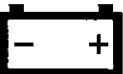















- ✓ All assembly instructions have been completed.
- ✓ No remaining loose parts in carton.
- ✓ Battery is properly prepared and charged.(Minimum 1 hour at 6 amps).
- ✓ Seat is adjusted comfortably and tightened securely.
- ✓ All tires are properly inflated. (For shipping purposes, the tires were overinflated at the factory).
- ✓ Be sure mower deck is properly leveled side-to-side/front-to-rear for best cutting results. (Tires must be properly inflated for leveling).
- ✓ Check mower and drive belts. Be sure they are routed properly around pulleys and inside all belt keepers.
- ✓ Check wiring. See that all connections are still secure and wires are properly clamped.

While learning how to use your tractor, pay extra attention to the following important items:

- ✓ Engine oil is at proper level.
- ✓ Fuel tank is filled with fresh, clean, regular unleaded gasoline.
- ✓ Become familiar with all controls - their location and function. Operate them before you start the engine.
- ✓ Be sure brake system is in safe operating condition.

OPERATION

These symbols may appear on your tractor or in literature supplied with the product. Learn and understand their meaning.

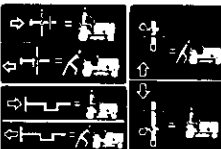
					
BATTERY	CAUTION OR WARNING	REVERSE	FORWARD	FAST	SLOW
					
ENGINE ON	ENGINE OFF	OIL PRESSURE	LIGHTS ON	OVER TEMP LIGHT	
					
FUEL	CHOKE	MOWER HEIGHT	PARKING BRAKE LOCKED	UNLOCKED	MOWER LIFT
	R	N	H	L	
ATTACHMENT CLUTCH ENGAGED	REVERSE	NEUTRAL	HIGH	LOW	PARKING BRAKE
					
IGNITION	ATTACHMENT CLUTCH DISENGAGED	KEEP AREA CLEAR (SEE SAFETY RULES SECTION)	SLOPE HAZARDS (SEE SAFETY RULES SECTION)		
					
DANGER, KEEP HANDS AND FEET AWAY	FREE WHEEL (Automatic Models only)				

KNOW YOUR TRACTOR

READ THIS OWNER'S MANUAL AND SAFETY RULES BEFORE OPERATING YOUR TRACTOR

Compare the illustrations with your tractor to familiarize yourself with the locations of various controls and adjustments. Save this manual for future reference.

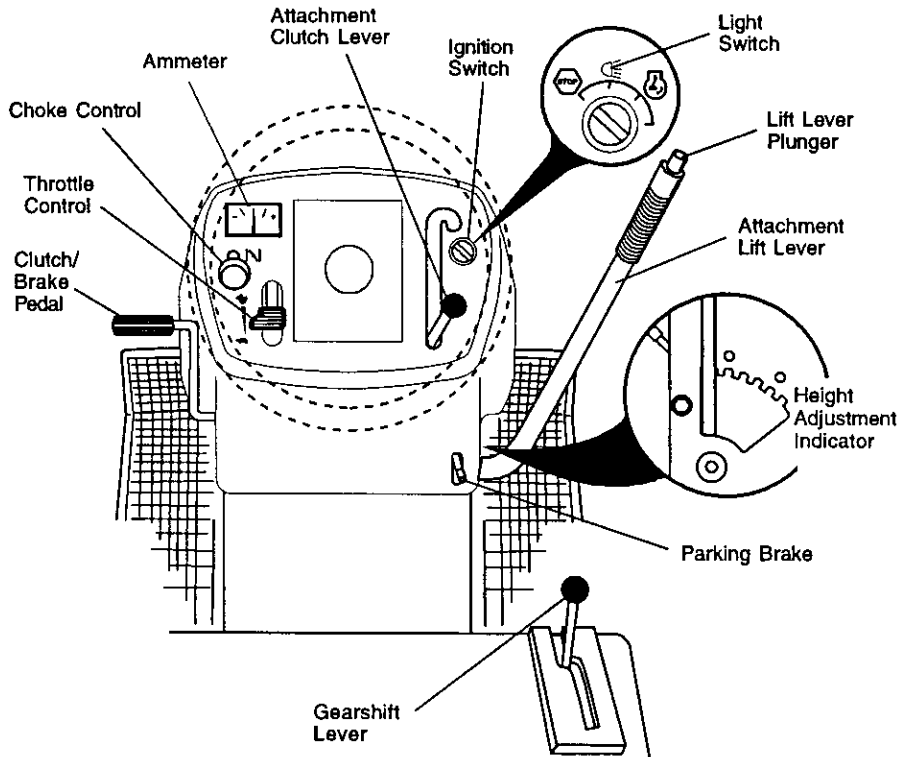

Our tractors conform to the safety standards of the American National Standards Institute.

ATTACHMENT CLUTCH LEVER: Used to engage the mower blades, or other attachments mounted to your tractor.

LIGHT SWITCH: Turns the headlights on and off.

THROTTLE CONTROL: Used for starting and controlling engine speed.

CHOKE CONTROL: Used when starting a cold engine.

CLUTCH/BRAKE PEDAL: Used for declutching and braking the tractor and starting the engine.

PARKING BRAKE: Locks clutch/brake pedal into the brake position.

GEARSHIFT LEVER: Selects the speed and direction of tractor.

ATTACHMENT LIFT LEVER: Used to raise, lower, and adjust the mower deck or other attachments mounted to your tractor.

LIFT LEVER PLUNGER: Used to release attachment lift lever when changing its position.

IGNITION SWITCH: Used for starting and stopping the engine.

AMMETER: Indicates battery charging (+) or discharging (-).



The operation of any tractor can result in foreign objects thrown into the eyes, which can result in severe eye damage. Always wear safety glasses or eye shields while operating your tractor or performing any adjustments or repairs. We recommend a wide vision safety mask over spectacles, or standard safety glasses.

HOW TO USE YOUR TRACTOR TO SET PARKING BRAKE

Your tractor is equipped with an operator presence sensing switch. When engine is running, any attempt by the operator to leave the seat without first setting the parking brake will shut off the engine.

1. Depress clutch/brake pedal into full "BRAKE" position and hold.
2. Place parking brake lever in "ENGAGED" position and release pressure from clutch/brake pedal. Pedal should remain in "BRAKE" position. Make sure parking brake will hold tractor secure.

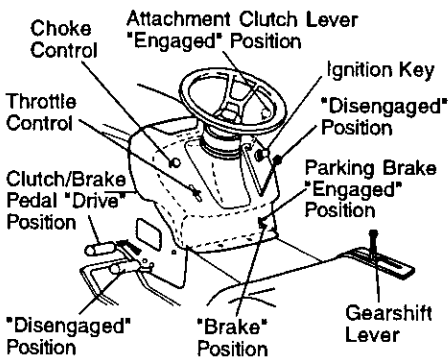

STOPPING

MOWER BLADES -

- To stop mower blades, move attachment clutch lever to "DISENGAGED" position.

GROUND DRIVE -

- To stop ground drive, depress clutch/brake pedal into full "BRAKE" position.
- Move gearshift lever to neutral (N) position.

ENGINE -

- Move throttle control to slow position.
- NOTE:** Failure to move throttle control to slow position and allowing engine to idle before stopping may cause engine to "backfire".

- Turn ignition key to "OFF" position and remove key. Always remove key when leaving tractor to prevent unauthorized use.

- Never use choke to stop engine.

IMPORTANT: Leaving the ignition switch in any position other than "OFF" will cause the battery to be discharged, (dead).

NOTE: Under certain conditions when tractor is standing idle with the engine running, hot engine exhaust gases may cause "browning" of grass. To eliminate this possibility, always stop engine when stopping tractor on grass areas.

CAUTION: Always stop tractor completely, as described above, before leaving the operator's position; to empty grass catcher, etc.

TO USE THROTTLE CONTROL

Always operate engine at full throttle.

- Operating engine at less than full throttle reduces the battery charging rate.
- Full throttle offers the best bagging and mower performance.

TO USE CHOKE CONTROL

Use choke control whenever you are starting a cold engine. Do not use to start a warm engine.

- To engage choke control, pull knob out. Slowly push knob in to disengage.

TO MOVE FORWARD AND BACKWARD

The direction and speed of movement is controlled by the gearshift lever.

1. Start tractor with clutch/brake pedal depressed and gearshift lever in neutral (N) position.
2. Move gearshift lever to desired position.
3. Slowly release clutch/brake pedal to start movement.

IMPORTANT: Bring tractor to a complete stop before shifting or changing gears. Failure to do so will shorten the useful life of your transaxle.

TO ADJUST MOWER CUTTING HEIGHT

The position of the attachment lift lever determines the cutting height.

- Grasp lift lever.
- Press plunger with thumb and move lever to desired position.

The cutting height range is approximately 1-1/2 to 4". The heights are measured from the ground to the blade tip with the engine not running. These heights are approximate and may vary depending upon soil conditions, height of grass and types of grass being mowed.

- The average lawn should be cut to approximately 2-1/2 inches during the cool season and to over 3 inches during hot months. For healthier and better looking lawns, mow often and after moderate growth.
- For best cutting performance, grass over 6 inches in height should be mowed twice. Make the first cut relatively high; the second to desired height.

TO ADJUST GAUGE WHEELS

Gauge wheels are properly adjusted when they are slightly off the ground when mower is at the desired cutting height in operating position. Gauge wheels then keep the deck in proper position to help prevent scalping in most terrain conditions.

NOTE: Adjust gauge wheels with tractor on a flat level surface.

1. Adjust mower to desired cutting height (See "TO ADJUST MOWER CUTTING HEIGHT" in the Operation section of this manual).
2. With mower in desired height of cut position, gauge wheels should be assembled so they are slightly off the ground. Install gauge wheel in appropriate hole with shoulder bolt, 3/8 washer, and 3/8-16 locknut and tighten securely.
3. Repeat for opposite side installing gauge wheel in same adjustment hole.

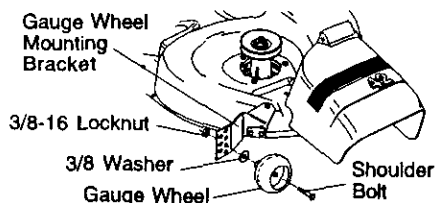

TO OPERATE MOWER

Your tractor is equipped with an operator presence sensing switch. Any attempt by the operator to leave the seat with the engine running and the attachment clutch engaged will shut off the engine.

1. Select desired height of cut.
2. Start mower blades by engaging attachment clutch control.

TO STOP MOWER BLADES - disengage attachment clutch control.

CAUTION: Do not operate the mower without either the entire grass catcher, on mowers so equipped, or the deflector shield in place.

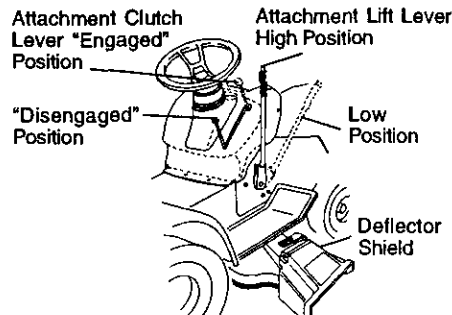

TO OPERATE ON HILLS

CAUTION: Do not drive up or down hills with slopes greater than 15° and do not drive across any slope. A slope guide at the back of your manual is provided for your use.

- Choose the slowest speed before starting up or down hills.
- Avoid stopping or changing speed on hills.
- If slowing is necessary, move throttle control lever to slower position.
- If stopping is absolutely necessary, push clutch/brake pedal quickly to brake position and engage parking brake.
- Move gearshift lever to 1st gear. Be sure you have allowed room for tractor to roll slightly as you restart movement.
- To restart movement, slowly release parking brake and clutch/brake pedal.
- Make all turns slowly.

TO TRANSPORT

- Raise attachment lift to highest position with attachment lift control.
- When pushing or towing your tractor, be sure gearshift lever is in neutral (N) position.
- Do not push or tow tractor at more than five (5) MPH.

NOTE: To protect hood from damage when transporting your tractor on a truck or a trailer, be sure hood is closed and secured to tractor. Use an appropriate means of tying hood to tractor (rope, cord, etc.).

TOWING CARTS AND OTHER ATTACHMENTS

Tow only the attachments that are recommended by and comply with specifications of the manufacturer of your tractor. Use common sense when towing. Too heavy of a load, while on a slope, is dangerous. Tires can lose traction with the ground and cause you to lose control of your tractor.

BEFORE STARTING THE ENGINE CHECK ENGINE OIL LEVEL

The engine in your tractor has been shipped, from the factory, already filled with summer weight oil.

1. Check engine oil with tractor on level ground.
 2. Remove oil fill cap/dipstick and wipe clean, reinsert the dipstick and screw cap tight, wait for a few seconds, remove and read oil level. If necessary, add oil until "FULL" mark on dipstick is reached. Do not overfill.
- For cold weather operation you should change oil for easier starting (See "OIL VISCOSITY CHART" in the Maintenance section of this manual).
 - To change engine oil, see the Maintenance section in this manual.

ADD GASOLINE

- Fill fuel tank. Use fresh, clean, regular unleaded gasoline with a minimum of 87 octane. (Use of leaded gasoline will increase carbon and lead oxide deposits and reduce valve life). Do not mix oil with gasoline. Purchase fuel in quantities that can be used within 30 days to assure fuel freshness.

IMPORTANT: When operating in temperatures below 32°F(0°C), use fresh, clean winter grade gasoline to help insure good cold weather starting.

⚠WARNING: Experience indicates that alcohol blended fuels (called gasohol or using ethanol or methanol) can attract moisture which leads to separation and formation of acids during storage. Acidic gas can damage the fuel system of an engine while in storage. To avoid engine problems, the fuel system should be emptied before storage of 30 days or longer. Drain the gas tank, start the engine and let it run until the fuel lines and carburetor are empty. Use fresh fuel next season. See Storage Instructions for additional information. Never use engine or carburetor cleaner products in the fuel tank or permanent damage may occur.

⚠CAUTION: Fill to bottom of gas tank filler neck. Do not overfill. Wipe off any spilled oil or fuel. Do not store, spill or use gasoline near an open flame.

TO START ENGINE

When starting the engine for the first time or if the engine has run out of fuel, it will take extra cranking time to move fuel from the tank to the engine.

1. Sit on seat in operating position, depress clutch/brake pedal and set parking brake.
2. Place gear shift lever in neutral (N) position.
3. Move attachment clutch to "DISENGAGED" position.
4. Move throttle control to fast position
5. Pull choke control out for a cold engine start attempt. For a warm engine start attempt the choke control may not be needed.

NOTE: Before starting, read the warm and cold starting procedures below.

6. Insert key into ignition and turn key clockwise to "START" position and release key as soon as engine starts. Do not run starter continuously for more than fifteen seconds per minute. If the engine does not start after several attempts, push choke control in, wait a few minutes and try again. If engine still does not start, pull the choke control out and retry.

WARM WEATHER STARTING (50° F and above)

7. When engine starts, slowly push choke control in until the engine begins to run smoothly. If the engine starts to run roughly, pull the choke control out slightly for a few seconds and then continue to push the control in slowly.
- The attachments and ground drive can now be used. If the engine does not accept the load, restart the engine and allow it to warm up for one minute using the choke as described above.

COLD WEATHER STARTING (50° F and below)

7. When engine starts, slowly push choke control in until the engine begins to run smoothly. Continue to push the choke control in small steps allowing the engine to accept small changes in speed and load, until the choke control is fully in. If the engine starts to run roughly, pull the choke control out slightly for a few seconds and then continue to push the control in slowly. This may require an engine warm-up period from several seconds to several minutes, depending on the temperature.

- The attachments can be used during the engine warm-up period and may require the choke control be pulled out slightly.

NOTE: If at a high altitude (above 3000 feet) or in cold temperatures (below 32 F) the carburetor fuel mixture may need to be adjusted for best engine performance. See "TO ADJUST CARBURETOR" in the Service and Adjustments section of this manual.

MOWING TIPS

- Mower should be properly leveled for best mowing performance. See "TO LEVEL MOWER HOUSING" in the Service and Adjustments section of this manual.
- The left hand side of mower should be used for trimming.
- Drive so that clippings are discharged onto the area that has been cut. Have the cut area to the right of the machine. This will result in a more even distribution of clippings and more uniform cutting.
- When mowing large areas, start by turning to the right so that clippings will discharge away from shrubs, fences, driveways, etc. After one or two rounds, mow in the opposite direction making left hand turns until finished.
- If grass is extremely tall, it should be mowed twice to reduce load and possible fire hazard from dried clippings. Make first cut relatively high; the second to the desired height.
- Do not mow grass when it is wet. Wet grass will plug mower and leave undesirable clumps. Allow grass to dry before mowing.
- **Always operate engine at full throttle when mowing** to assure better mowing performance and proper discharge of material. Regulate ground speed by selecting a low enough gear to give the mower the best cutting performance as well as the quality of cut desired.
- When operating attachments, select a ground speed that will suit the terrain and give best performance of the attachment being used.

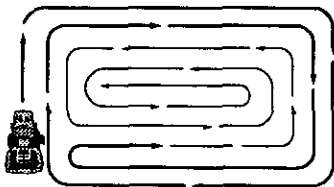

MULCHING MOWING TIPS

IMPORTANT: For best performance, keep mower housing free of built-up grass and trash. Clean after each use.

- The special mulching blade will recut the grass clippings many times and reduce them in size so that as they fall onto the lawn they will disperse into the grass and not be noticed. Also, the mulched grass will biodegrade quickly to provide nutrients for the lawn. Always mulch with your highest engine (blade) speed as this will provide the best recutting action of the blades.
- Avoid cutting your lawn when it is wet. Wet grass tends to form clumps and interferes with the mulching action. The best time to mow your lawn is the early afternoon. At this time the grass has dried and the newly cut area will not be exposed to the direct sun.
- For best results, adjust the mower cutting height so that the mower cuts off only the top one-third of the grass blades. For extremely heavy mulching, reduce your width of cut on each pass and mow slowly.
- Certain types of grass and grass conditions may require that an area be mulched a second time to completely hide the clippings. When doing a second cut, mow across or perpendicular to the first cut path.
- Change your cutting pattern from week to week. Mow north to south one week then change to east to west the next week. This will help prevent matting and graining of the lawn.

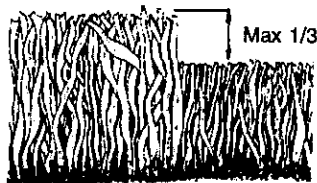

MAINTENANCE

MAINTENANCE SCHEDULE		SERVICE DATES						
FILL IN DATES AS YOU COMPLETE REGULAR SERVICE		BEFORE EACH USE	EVERY 4 HOURS	EVERY 25 HOURS	EVERY 50 HOURS	EVERY 100 HOURS	EVERY SEASON	BEFORE STORAGE
T R A C T O R	Check Brake Operation	✓	✓					
	Check Tire Pressure	✓	✓					
	Check Operator Presence and Interlock Systems	✓						
	Check for Loose Fasteners	✓			✓ ⁷		✓	
	Sharpen/Replace Mower Blades			✓ ⁴				
	Lubrication Chart			✓ ⁴			✓	
	Check Battery Level							✓
	Clean Battery and Terminals			✓ ⁶				✓
	Check Transaxle Cooling			✓				
	Adjust Blade Belt(s) Tension					✓ ⁵		
Adjust Motion Drive Belt(s) Tension					✓ ⁵			
E N G I N E	Check Engine Oil Level	✓	✓					
	Change Engine Oil			✓ ^{2,3}			✓	
	Clean Air Filter			✓ ²				
	Clean Air Screen			✓ ²				
	Inspect Muffler/Spark Arrester				✓			
	Replace Oil Filter (if equipped)					✓ ^{1,2}		
	Clean Engine Cooling Fins					✓ ²		
	Replace Spark Plug					✓	✓	
	Replace Air Filter Paper Cartridge					✓ ²		
Replace Fuel Filter							✓	

- 1 - Change more often when operating under a heavy load or in high ambient temperatures.
 2 - Service more often when operating in dirty or dusty conditions.
 3 - If equipped with oil filter, change oil every 50 hours.
 4 - Replace blades more often when mowing in sandy soil.
 5 - If equipped with adjustable system.
 6 - Not required if equipped with maintenance-free battery.
 7 - Tighten front axle pivot bolt to 35 ft.-lbs. maximum. Do not overtighten.

GENERAL RECOMMENDATIONS

The warranty on this tractor does not cover items that have been subjected to operator abuse or negligence. To receive full value from the warranty, operator must maintain tractor as instructed in this manual. Some adjustments will need to be made periodically to properly maintain your tractor.

All adjustments in the Service and Adjustments section of this manual should be checked at least once each season.

- Once a year you should replace the spark plug, clean or replace air filter, and check blades and belts for wear. A new spark plug and clean air filter assure proper air-fuel mixture and help your engine run better and last longer.

BEFORE EACH USE

- Check engine oil level.
- Check brake operation.
- Check tire pressure.
- Check operator presence and interlock systems for proper operation.
- Check for loose fasteners.

LUBRICATION CHART

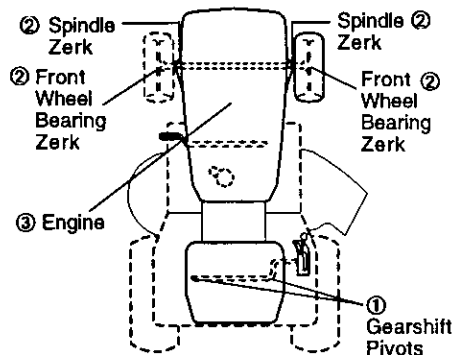

- SAE 30 or 10w30 motor oil
- General Purpose Grease
- Refer to Maintenance "ENGINE" Section

IMPORTANT: Do not oil or grease the pivot points which have special nylon bearings. Viscous lubricants will attract dust and dirt that will shorten the life of the self-lubricating bearings. If you feel they must be lubricated, use only a dry, powdered graphite type lubricant sparingly.

TRACTOR

Always observe safety rules when performing any maintenance.

BRAKE OPERATION

If tractor requires more than six (6) feet stopping distance at high speed in highest gear, then brake must be adjusted. (See "TO ADJUST BRAKE" in the Service and Adjustments section of this manual).

TIRES

- Maintain proper air pressure in all tires (See "PRODUCT SPECIFICATIONS" section of this manual).
- Keep tires free of gasoline, oil, or insect control chemicals which can harm rubber.
- Avoid stumps, stones, deep ruts, sharp objects and other hazards that may cause tire damage.

NOTE: To seal tire punctures and prevent flat tires due to slow leaks, tire sealant may be purchased from your local parts dealer. Tire sealant also prevents tire dry rot and corrosion.

OPERATOR PRESENCE SYSTEM

Be sure that operator presence and interlock systems are working properly. If your tractor does not function as described below, repair the problem immediately.

- The engine should not start unless the brake pedal is fully depressed and attachment clutch control is in the disengaged position.
- When the engine is running, any attempt by the operator to leave the seat without first setting the parking brake should shut off the engine.
- When the engine is running and the attachment clutch is engaged, any attempt by the operator to leave the seat should shut off the engine.
- The attachment clutch should never operate unless the operator is in the seat.

BLADE CARE

For best results mower blades must be kept sharp. Replace bent or damaged blades.

BLADE REMOVAL

1. Raise mower to highest position to allow access to blades.
2. Remove hex bolt, lock washer and flat washer securing blade.
3. Install new or resharpened blade with trailing edge up towards deck as shown.

IMPORTANT: To ensure proper assembly, center hole in blade must align with star on mandrel assembly.

4. Reassemble hex bolt, lock washer and flat washer in exact order as shown.
5. Tighten bolt securely (27-35 Ft. Lbs. torque).

IMPORTANT: Blade bolt is grade 8 heat treated.

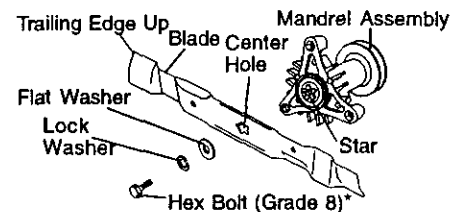

*A Grade 8 heat treated bolt can be identified by six lines on the bolt head.

TO SHARPEN BLADE

NOTE: We do not recommend sharpening blade - but if you do, be sure the blade is balanced.

Care should be taken to keep the blade balanced. An unbalanced blade will cause excessive vibration and eventual damage to mower and engine.

- The blade can be sharpened with a file or on a grinding wheel. Do not attempt to sharpen while on the mower.
- To check blade balance, you will need a 5/8" diameter steel bolt, pin, or a cone balancer. (When using a cone balancer, follow the instructions supplied with balancer.)

NOTE: Do not use a nail for balancing blade. The lobes of the center hole may appear to be centered, but are not.

- Slide blade on to an unthreaded portion of the steel bolt or pin and hold the bolt or pin parallel with the ground. If blade is balanced, it should remain in a horizontal position. If either end of the blade moves downward, sharpen the heavy end until the blade is balanced.

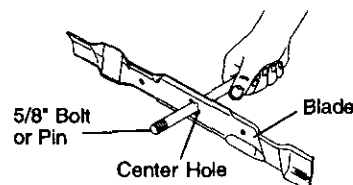

BATTERY

Your tractor has a battery charging system which is sufficient for normal use. However, periodic charging of the battery with an automotive charger will extend its life.

- Keep battery and terminals clean.
- Keep battery bolts tight.
- Keep small vent holes open.
- Recharge at 6-10 amperes for 1 hour.

NOTE: The original equipment battery on your tractor is maintenance free. Do not attempt to open or remove caps or covers. Adding or checking level of electrolyte is not necessary.

TO CLEAN BATTERY AND TERMINALS

Corrosion and dirt on the battery and terminals can cause the battery to "leak" power.

1. Open battery box door.
2. Disconnect **BLACK** battery cable first then **RED** battery cable and remove battery from tractor.
3. Rinse the battery with plain water and dry.
4. Clean terminals and battery cable ends with wire brush until bright.
5. Coat terminals with grease or petroleum jelly.
6. Reinstall battery (See "REPLACING BATTERY" in the SERVICE AND ADJUSTMENTS section of this manual).

V-BELTS

Check V-belts for deterioration and wear after 100 hours of operation and replace if necessary. The belts are not adjustable. Replace belts if they begin to slip from wear.

TRANSAXLE COOLING

Keep transaxle free from build-up of dirt and chaff which can restrict cooling.

ENGINE

LUBRICATION

Only use high quality detergent oil rated with API service classification SF-SJ. Select the oil's SAE viscosity grade according to your expected operating temperature.

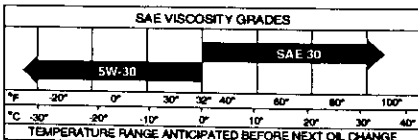

NOTE: Although multi-viscosity oils (5W30, 10W30 etc.) improve starting in cold weather, these multi-viscosity oils will result in increased oil consumption

when used above 32°F. Check your engine oil level more frequently to avoid possible engine damage from running low on oil.

Change the oil after every 50 hours of operation or at least once a year if the tractor is not used for 50 hours in one year.

Check the crankcase oil level before starting the engine and after each eight (8) hours of operation. Tighten oil fill cap/dipstick securely each time you check the oil level.

TO CHANGE ENGINE OIL

Determine temperature range expected before oil change. All oil must meet API service classification SF-SJ.

- Be sure tractor is on level surface.
 - Oil will drain more freely when warm.
 - Catch oil in a suitable container.
1. Remove oil fill cap/dipstick. Be careful not to allow dirt to enter the engine when changing oil.
 2. Remove cap from end of drain valve and install the drain tube onto the fitting.
 3. Unlock drain valve by pushing inward slightly and turning counterclockwise.
 4. To open, pull out on the drain valve.
 5. After oil has drained completely, close and lock the drain valve by pushing inward and turning clockwise until the pin is in the locked position as shown.
 6. Remove the drain tube and replace the cap onto to the end of the drain valve.
 7. Refill engine with oil through oil fill dipstick tube. Pour slowly. Do not overfill. For approximate capacity see "PRODUCT SPECIFICATIONS" section of this manual.
 8. Use gauge on oil fill cap/dipstick for checking level. Be sure dipstick cap is tightened securely for accurate reading. Keep oil at "FULL" line on dipstick.

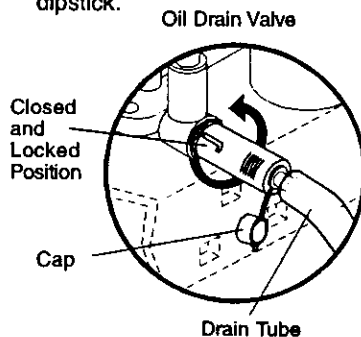

CLEAN AIR SCREEN

Air screen must be kept free of dirt and chaff to prevent engine damage from overheating. Clean with a wire brush or compressed air to remove dirt and stubborn dried gum fibers.

CLEAN AIR INTAKE/COOLING AREAS

To insure proper cooling, make sure the grass screen, cooling fins, and other external surfaces of the engine are kept clean at all times.

Every 100 hours of operation (more often under extremely dusty, dirty conditions), remove the blower housing and other cooling shrouds. Clean the cooling fins and external surfaces as necessary. Make sure the cooling shrouds are reinstalled.

NOTE: Operating the engine with a blocked grass screen, dirty or plugged cooling fins, and/or cooling shrouds removed will cause engine damage due to overheating.

AIR FILTER

Your engine will not run properly using a dirty air filter. Clean the foam pre-cleaner after every 25 hours of operation or every season. Service paper cartridge every 100 hours of operation or every season, whichever occurs first.

Service air cleaner more often under dusty conditions.

1. Remove knobs and cover.

TO SERVICE PRE-CLEANER

2. Wash it in liquid detergent and water.
3. Squeeze it dry in a clean cloth.
4. Saturate it in engine oil. Wrap it in clean, absorbent cloth and squeeze to remove excess oil.

NOTE: If very dirty or damaged, replace pre-cleaner.

TO SERVICE CARTRIDGE

5. Clean cartridge by tapping gently on flat surface. If very dirty or damaged, replace cartridge.
6. Reinstall pre-cleaner cartridge, cover and secure with knobs.

IMPORTANT: Petroleum solvents, such as kerosene, are not to be used to clean the cartridge. They may cause deterioration of the cartridge. Do not oil cartridge. Do not use pressurized air to clean or dry cartridge.

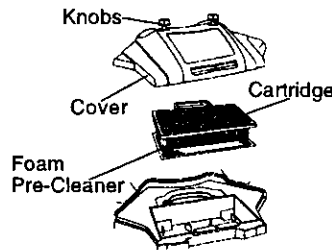

ENGINE OIL FILTER

Replace the engine oil filter every season or every other oil change if the tractor is used more than 100 hours in one year.

MUFFLER

Inspect and replace corroded muffler and spark arrester (if equipped) as it could create a fire hazard and/or damage.

SPARK PLUGS

Replace spark plugs at the beginning of each mowing season or after every 100 hours of operation, whichever occurs first. Spark plug type and gap setting are shown in "PRODUCT SPECIFICATIONS" section of this manual.

IN-LINE FUEL FILTER

The fuel filter should be replaced once each season. If fuel filter becomes clogged, obstructing fuel flow to carburetor, replacement is required.

1. With engine cool, remove filter and plug fuel line sections.
2. Place new fuel filter in position in fuel line with arrow pointing towards carburetor.
3. Be sure there are no fuel line leaks and clamps are properly positioned.
4. Immediately wipe up any spilled gasoline.

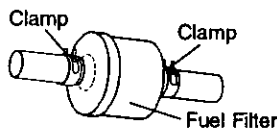

CLEANING

- Clean engine, battery, seat, finish, etc. of all foreign matter.
- Keep finished surfaces and wheels free of all gasoline, oil, etc.
- Protect painted surfaces with automotive type wax.

We do not recommend using a garden hose to clean your tractor unless the electrical system, muffler, air filter and carburetor are covered to keep water out. Water in engine can result in a shortened engine life.

SERVICE AND ADJUSTMENTS



CAUTION: BEFORE PERFORMING ANY SERVICE OR ADJUSTMENTS:

1. Depress clutch/brake pedal fully and set parking brake.
2. Place gearshift lever in neutral (N) position.
3. Place attachment clutch in "DISENGAGED" position.
4. Turn ignition key "OFF" and remove key.
5. Make sure the blades and all moving parts have completely stopped.
6. Disconnect spark plug wire from spark plug and place wire where it cannot come in contact with plug.

TRACTOR

TO REMOVE MOWER

Mower will be easier to remove from the right side of tractor.

1. Place attachment clutch in "DISENGAGED" position.
2. Move attachment lift lever forward to lower mower to its lowest position.
3. Roll belt off engine pulley.
4. Remove small retainer spring, and lift clutch spring off pulley bolt.
5. Remove large retainer spring, slide collar off and push housing guide out of bracket.
6. Disconnect anti-swaybar from chassis bracket by removing retainer spring.
7. Disconnect suspension arms from rear deck brackets by removing retainer springs.

8. Disconnect front links from deck by removing retainer springs.
9. Raise lift lever to raise suspension arms. Slide mower out from under tractor.

IMPORTANT: If an attachment other than the mower deck is to be mounted on the tractor, remove the front links and hook the clutch spring into square hole in frame.

TO INSTALL MOWER

1. Raise attachment lift lever to its highest position.
2. Slide mower under tractor with deflector shield to right side of tractor.
3. Lower lift lever to its lowest position.
4. Install mower in reverse order of removal instructions.

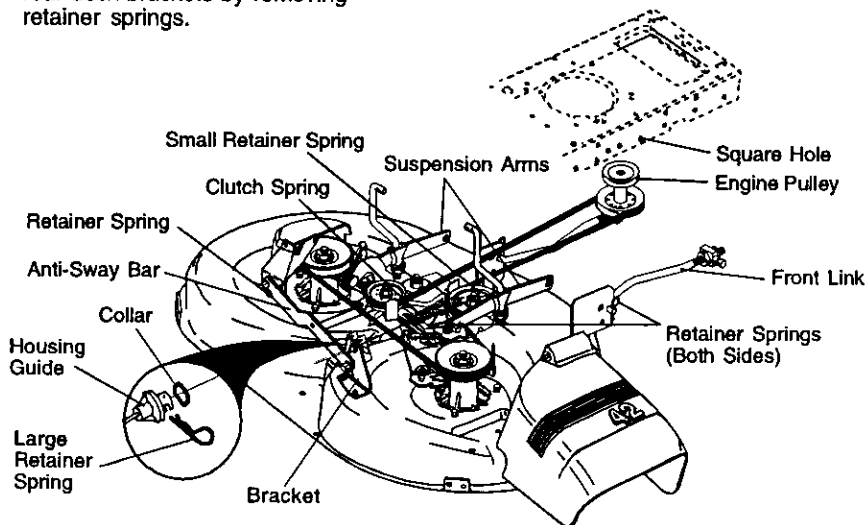

TO LEVEL MOWER HOUSING

Adjust the mower while tractor is parked on level ground or driveway. Make sure tires are properly inflated (See "PRODUCT SPECIFICATIONS" section of this manual). If tires are over or underinflated, you will not properly adjust your mower.

SIDE-TO-SIDE ADJUSTMENT

- Raise mower to its highest position.
- At the midpoint of both sides of mower, measure height from bottom edge of mower to ground. Distance "A" on both sides of mower should be the same or within 1/4" of each other.
- If adjustment is necessary, make adjustment on one side of mower only.
- To raise one side of mower, tighten lift link adjustment nut on that side.
- To lower one side of mower, loosen lift link adjustment nut on that side.

NOTE: Each full turn of adjustment nut will change mower height about 1/8".

- Recheck measurements after adjusting.

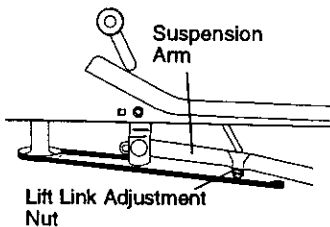
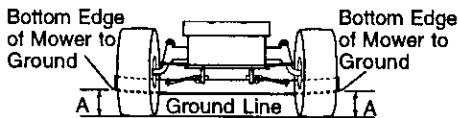

FRONT-TO-BACK ADJUSTMENT

IMPORTANT: Deck must be level side-to-side. If the following front-to-back adjustment is necessary, be sure to adjust both front links equally so mower will stay level side-to-side.

To obtain the best cutting results, the mower housing should be adjusted so that the front is approximately 1/8" to 1/2" lower than the rear when the mower is in its highest position.

Check adjustment on right side of tractor. Measure distance "D" directly in front and behind the mandrel at bottom edge of mower housing as shown.

- Before making any necessary adjustments, check that both front links are equal in length.
- If links are not equal in length, adjust one link to same length as other link.
- To lower front of mower loosen nut "E" on both front links an equal number of turns.
- When distance "D" is 1/8" to 1/2" lower at front than rear, tighten nuts "F" against trunnion on both front links.
- To raise front of mower, loosen nut "F" from trunnion on both front links. Tighten nut "E" on both front links an equal number of turns.
- When distance "D" is 1/8" to 1/2" lower at front than rear, tighten nut "F" against trunnion on both front links.
- Recheck side-to-side adjustment.

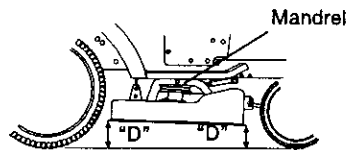

Both Front Links Should be Equal in Length

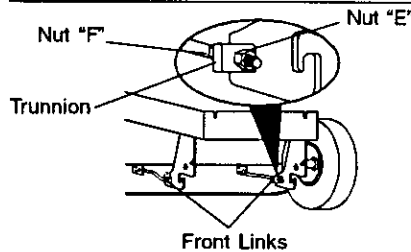
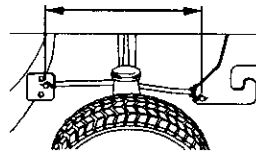

TO REPLACE MOWER BLADE DRIVE BELT

The mower blade drive belt may be replaced without tools. Park the tractor on level surface. Engage parking brake.

BELT REMOVAL -

1. Remove mower from tractor (See "TO REMOVE MOWER" in this section of this manual).
2. Work belt off both mandrel pulleys and idler pulleys.
3. Pull belt away from mower.

BELT INSTALLATION -

4. Install new belt in reverse order of removal.
5. Make sure belt is in all pulley grooves and inside all belt guides.
6. Install mower in reverse order of removal instructions.

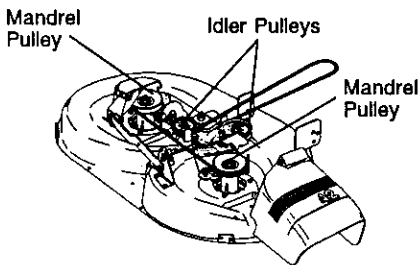

TO ADJUST BRAKE

Your tractor is equipped with an adjustable brake system which is mounted on the right side of the transaxle. If tractor requires more than six (6) feet stopping distance at high speed in highest gear on a level dry concrete or paved surface, then brake must be adjusted.

1. Depress clutch/brake pedal and engage parking brake.
2. Measure distance between brake operating arm and nut "A" on brake rod.
3. If distance is other than 1-1/2", loosen jam nut and turn nut "A" until distance becomes 1-1/2". Retighten jam nut against nut "A".
4. Road test tractor for proper stopping distance as stated above. Readjust if necessary. If stopping distance is still greater than six (6) feet in highest gear, further maintenance is necessary. Contact a Sears or other qualified service center.

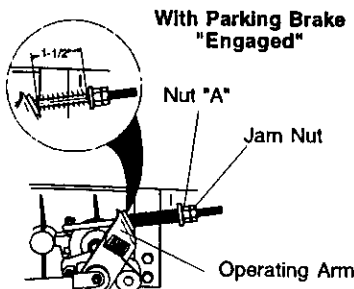

TO REPLACE MOTION DRIVE BELT

Park the tractor on level surface. Engage parking brake. For assistance, there is a belt installation guide decal on bottom side of left footrest.

1. Remove mower (See "TO REMOVE MOWER" in this section of this manual.)
2. Remove belt from stationary idler and clutching idler.
3. Pull belt slack toward rear of tractor. Remove belt upwards from transaxle pulley by deflecting belt keepers.
4. Pull belt toward front of tractor and remove downwards from around engine pulley.
5. Install new belt by reversing above procedure.

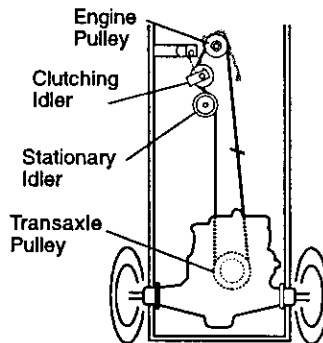

TRANSAXLE GEAR SHIFT LEVER NEUTRAL ADJUSTMENT

The transaxle should be in neutral when the gear shift lever is in neutral (N) (lock gate) position. The adjustment is preset at the factory; however, if adjustment is needed, proceed as follows:

1. Make sure transaxle is in neutral (N).
2. Loosen adjustment bolt in front of the right rear wheel.
3. Position the gear shift lever in the neutral (N) position.
4. Tighten adjustment bolt securely.

NOTE: When the tractor rear wheels move freely, the transaxle is in neutral.
NOTE: If additional clearance is needed to get to adjustment bolt, move mower deck height to the lowest position.

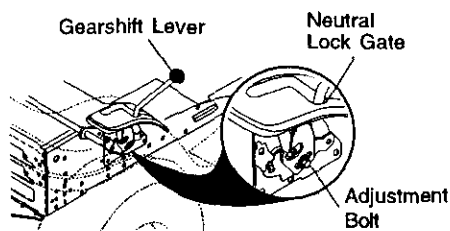

TO ADJUST STEERING WHEEL ALIGNMENT

If steering wheel crossbars are not horizontal (left to right) when wheels are positioned straight forward, remove steering wheel and reassemble per instructions in the Assembly section of this manual.

FRONT WHEEL TOE-IN/CAMBER

The front wheel toe-in and camber are not adjustable on your tractor. If damage has occurred to affect the front wheel toe-in or camber, contact a Sears or other qualified service center.

TO REMOVE WHEEL FOR REPAIRS

1. Block up axle securely.
2. Remove axle cover, retaining ring and washers to allow wheel removal (rear wheel contains a square key - Do not lose).
3. Repair tire and reassemble.
NOTE: On rear wheels only: align grooves in rear wheel hub and axle. Insert square key.
4. Replace washers and snap retaining ring securely in axle groove.
5. Replace axle cover.

NOTE: To seal tire punctures and prevent flat tires due to slow leaks, tire sealant may be purchased from your local parts dealer. Tire sealant also prevents tire dry rot and corrosion.

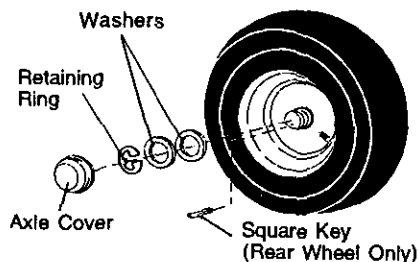

TO START ENGINE WITH A WEAK BATTERY

CAUTION: Lead-acid batteries generate explosive gases. Keep sparks, flame and smoking materials away from batteries. Always wear eye protection when around batteries.

If your battery is too weak to start the engine, it should be recharged. (See "BATTERY" in the MAINTENANCE section of this manual).

If "jumper cables" are used for emergency starting, follow this procedure:

IMPORTANT: Your tractor is equipped with a 12 volt negative grounded system. The other vehical must also be a 12 volt negative grounded system. Do not use your tractor battery to start other vehicles.

TO ATTACH JUMPER CABLES -

1. Connect each end of the RED cable to the POSITIVE (+) terminal of each battery, taking care not to short against chassis.
2. Connect one end of the BLACK cable to the NEGATIVE (-) terminal of fully charged battery.
3. Connect the other end of the BLACK cable to good CHASSIS GROUND, away from fuel tank and battery.

TO REMOVE CABLES, REVERSE ORDER -

1. BLACK cable first from chassis and then from the fully charged battery.
2. RED cable last from both batteries.

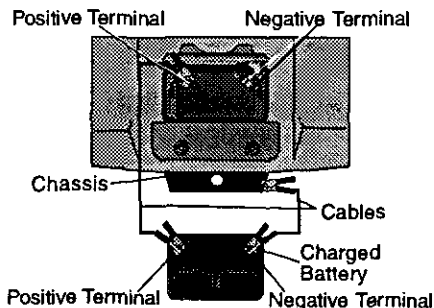

REPLACING BATTERY

CAUTION: Do not short battery terminals by allowing a wrench or any other object to contact both terminals at the same time. Before connecting battery, remove metal bracelets, wristwatch bands, rings, etc.

Positive terminal must be connected first to prevent sparking from accidental grounding.

1. Lift seat pan to raised position and open battery box door.
2. Disconnect BLACK battery cable first then RED battery cable and carefully remove battery from tractor.
3. Install new battery with terminals in same position as old battery.
4. First connect RED battery cable to positive (+) terminal with hex bolt and keps nut as shown. Tighten securely.
5. Connect BLACK grounding cable to negative (-) terminal with remaining hex bolt and keps nut. Tighten securely.
6. Close battery box door.

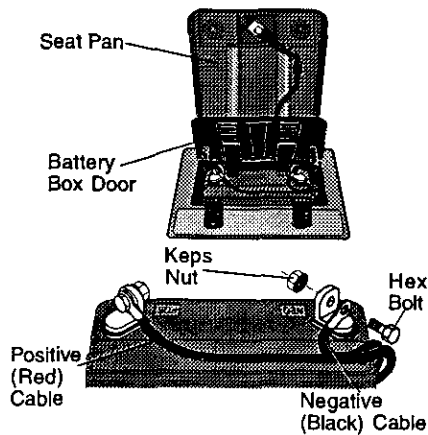

TO REPLACE HEADLIGHT BULB

1. Raise hood.
2. Pull bulb holder out of the hole in the backside of the grill.
3. Replace bulb in holder and push bulb holder securely back into the hole in the backside of the grill.
4. Close hood.

INTERLOCKS AND RELAYS

Loose or damaged wiring may cause your tractor to run poorly, stop running, or prevent it from starting.

- Check wiring. See electrical wiring diagram in the Repair Parts section.

TO REPLACE FUSE

Replace with 20 amp automotive-type plug-in fuse. The fuse holder is located behind the dash.

TO REMOVE HOOD AND GRILL ASSEMBLY

1. Raise hood.
2. Unsnap headlight wire connector.
3. Stand in front of tractor. Grasp hood at sides, tilt toward engine and lift off of tractor.
4. To replace, reverse above procedure.

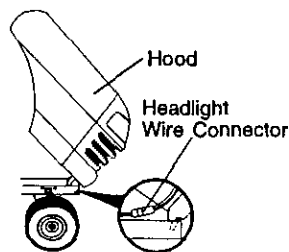

ENGINE

Maintenance, repair, or replacement of the emission control devices and systems, which are being done at the customer's expense, may be performed by any non-road engine repair establishment or individual. Warranty repairs must be performed by an authorized engine manufacturer's service outlet.

TO ADJUST THROTTLE CONTROL CABLE

The throttle control has been preset at the factory and adjustment should not be necessary. Check adjustment as described below before loosening cable. If adjustment is necessary, proceed as follows:

1. With engine not running, move throttle control lever to fast position.
2. Check that swivel is against stop. If it is not, loosen cable clamp screw and pull cable back until swivel is against stop. Tighten cable clamp screw securely.

TO ADJUST CHOKE CONTROL

The choke control has been preset at the factory and adjustment should not be necessary. Check adjustment as described below before loosening cable. If adjustment is necessary, proceed as follows:

1. With engine not running, move choke control (located on dash panel) to full choke position.
2. Loosen knob and remove cover assembly from air cleaner.
3. Choke should be closed. If it is not, loosen casing clamp screw and move choke cable until choke is completely closed. Tighten casing clamp screw securely.
4. Replace air cleaner cover assembly and tighten knob.

TO ADJUST CARBURETOR

Your carburetor is not adjustable. If your engine does not operate properly due to suspected carburetor problems, take your tractor to an authorized service center for repair and/or adjustment.

High speed stop is factory adjusted. Do not adjust - damage may result.

IMPORTANT: Never tamper with the engine governor, which is factory set for proper engine speed. Overspeeding the engine above the factory high speed setting can be dangerous. If you think the engine-governed high speed needs adjusting, contact a Sears or other qualified service center, which has proper equipment and experience to make any necessary adjustments.

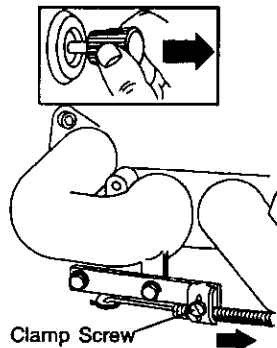
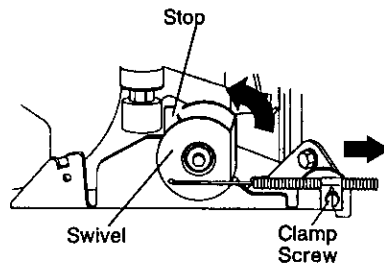

STORAGE

Immediately prepare your tractor for storage at the end of the season or if the tractor will not be used for 30 days or more.

CAUTION: Never store the tractor with gasoline in the tank inside a building where fumes may reach an open flame or spark. Allow the engine to cool before storing in any enclosure.

TRACTOR

Remove mower from tractor for winter storage. When mower is to be stored for a period of time, clean it thoroughly, remove all dirt, grease, leaves, etc. Store in a clean, dry area.

1. Clean entire tractor (See "CLEANING" in the Maintenance section of this manual).
2. Inspect and replace belts, if necessary (See belt replacement instructions in the Service and Adjustments section of this manual).
3. Lubricate as shown in the Maintenance section of this manual.
4. Be sure that all nuts, bolts and screws are securely fastened. Inspect moving parts for damage, breakage and wear. Replace if necessary.
5. Touch up all rusted or chipped paint surfaces; sand lightly before painting.

BATTERY

- Fully charge the battery for storage.
- After a period of time in storage, battery may require recharging.
- To help prevent corrosion and power leakage during long periods of storage, battery cables should be disconnected and battery cleaned thoroughly (see "TO CLEAN BATTERY AND TERMINALS" in the Maintenance section of this manual).
- After cleaning, leave cables disconnected and place cables where they cannot come in contact with battery terminals.
- If battery is removed from tractor for storage, do not store battery directly on concrete or damp surfaces.

ENGINE

FUEL SYSTEM

IMPORTANT: It is important to prevent gum deposits from forming in essential fuel system parts such as carburetor, fuel hose, or tank during storage.

Also, experience indicates that alcohol blended fuels (called gasohol or using ethanol or methanol) can attract moisture which leads to separation and formation of acids during storage. Acidic gas can damage the fuel system of an engine while in storage.

1. Drain the fuel tank.
 2. Start the engine and let it run until the fuel lines and carburetor are empty.
- Never use engine or carburetor cleaner products in the fuel tank or permanent damage may occur.
 - Use fresh fuel next season.

NOTE: Fuel stabilizer is an acceptable alternative in minimizing the formation of fuel gum deposits during storage. Add stabilizer to gasoline in fuel tank or storage container. Always follow the mix ratio found on stabilizer container. Run engine at least 10 minutes after adding stabilizer to allow the stabilizer to reach the carburetor. Do not drain the gas tank and carburetor if using fuel stabilizer.

ENGINE OIL

Drain oil (with engine warm) and replace with clean engine oil. (See "ENGINE" in the Maintenance section of this manual).

CYLINDER(S)

1. Remove spark plug(s).
2. Pour one ounce of oil through spark plug hole(s) into cylinder(s).
3. Turn ignition key to "START" position for a few seconds to distribute oil.
4. Replace with new spark plug(s).

OTHER

- Do not store gasoline from one season to another.
- Replace your gasoline can if your can starts to rust. Rust and/or dirt in your gasoline will cause problems.
- If possible, store your tractor indoors and cover it to give protection from dust and dirt.
- Cover your tractor with a suitable protective cover that does not retain moisture. Do not use plastic. Plastic cannot breathe which allows condensation to form and will cause your tractor to rust.

IMPORTANT: Never cover tractor while engine and exhaust areas are still warm.

TROUBLESHOOTING CHART

PROBLEM	CAUSE	CORRECTION
Will not start	<ol style="list-style-type: none"> 1. Out of fuel. 2. Engine not "CHOKED" properly. 3. Engine flooded. 4. Bad spark plug. 5. Dirty air filter. 6. Dirty fuel filter. 7. Water in fuel. 8. Loose or damaged wiring. 9. Carburetor out of adjustment. 10. Engine valves out of adjustment. 	<ol style="list-style-type: none"> 1. Fill fuel tank. 2. See "TO START ENGINE" in Operation section. 3. Wait several minutes before attempting to start. 4. Replace spark plug. 5. Clean/replace air filter. 6. Replace fuel filter. 7. Drain fuel tank and carburetor, refill tank with fresh gasoline and replace fuel filter. 8. Check all wiring. 9. See "To Adjust Carburetor" in Service Adjustments section. 10. Contact a Sears or other qualified service center.
Hard to start	<ol style="list-style-type: none"> 1. Dirty air filter. 2. Bad spark plug. 3. Weak or dead battery. 4. Dirty fuel filter. 5. Stale or dirty fuel. 6. Loose or damaged wiring. 7. Carburetor out of adjustment. 8. Engine valves out of adjustment. 	<ol style="list-style-type: none"> 1. Clean/replace air filter. 2. Replace spark plug. 3. Recharge or replace battery. 4. Replace fuel filter. 5. Drain fuel tank and refill with fresh gasoline. 6. Check all wiring. 7. See "To Adjust Carburetor" in Service Adjustments section. 8. Contact a Sears or other qualified service center.
Engine will not turn over	<ol style="list-style-type: none"> 1. Clutch/brake pedal not depressed. 2. Attachment clutch is engaged. 3. Weak or dead battery. 4. Blown fuse. 5. Corroded battery terminals. 6. Loose or damaged wiring. 7. Faulty ignition switch. 8. Faulty solenoid or starter. 9. Faulty operator presence switch(es). 	<ol style="list-style-type: none"> 1. Depress clutch/brake pedal. 2. Disengage attachment clutch. 3. Recharge or replace battery. 4. Replace fuse. 5. Clean battery terminals. 6. Check all wiring. 7. Check/replace ignition switch. 8. Check/replace solenoid or starter. 9. Contact a Sears or other qualified service center.
Engine clicks but will not start	<ol style="list-style-type: none"> 1. Weak or dead battery. 2. Corroded battery terminals. 3. Loose or damaged wiring. 4. Faulty solenoid or starter. 	<ol style="list-style-type: none"> 1. Recharge or replace battery. 2. Clean battery terminals. 3. Check all wiring. 4. Check/replace solenoid or starter.

TROUBLESHOOTING CHART

PROBLEM	CAUSE	CORRECTION
Loss of power	<ol style="list-style-type: none"> 1. Cutting too much grass/too fast. 2. Throttle in "CHOKE" position. 3. Build-up of grass, leaves and trash under mower. 4. Dirty air filter. 5. Low oil level/dirty oil. 6. Faulty spark plug. 7. Dirty fuel filter. 8. Stale or dirty fuel. 9. Water in fuel. 10. Spark plug wire loose. 11. Dirty engine air screen/fins. 12. Dirty/clogged muffler. 13. Loose or damaged wiring. 14. Carburetor out of adjustment. 15. Engine valves out of adjustment. 	<ol style="list-style-type: none"> 1. Set in "Higher Cut" position/ reduce speed. 2. Adjust throttle control. 3. Clean underside of mower housing. 4. Clean/replace air filter. 5. Check oil level/change oil. 6. Clean and regap or change spark plug. 7. Replace fuel filter. 8. Drain fuel tank and refill with fresh gasoline. 9. Drain fuel tank and carburetor, refill tank with fresh gasoline and replace fuel filter. 10. Connect and tighten spark plug wire. 11. Clean engine air screen/fins. 12. Clean/replace muffler. 13. Check all wiring. 14. See "To Adjust Carburetor" in Service Adjustments section. 15. Contact a Sears or other qualified service center.
Excessive vibration	<ol style="list-style-type: none"> 1. Worn, bent or loose blade. 2. Bent blade mandrel. 3. Loose/damaged part(s). 	<ol style="list-style-type: none"> 1. Replace blade. Tighten blade bolt. 2. Replace blade mandrel. 3. Tighten loose part(s). Replace damaged parts.
Engine continues to run when operator leaves seat with attachment clutch engaged	<ol style="list-style-type: none"> 1. Faulty operator-safety presence control system. 	<ol style="list-style-type: none"> 1. Check wiring, switches and connections. If not contact a Sears or other qualified service center.
Poor cut - uneven	<ol style="list-style-type: none"> 1. Worn, bent or loose blade. 2. Mower deck not level. 3. Buildup of grass, leaves, and trash under mower. 4. Bent blade mandrel. 5. Clogged mower deck vent holes from buildup of grass, leaves, and trash around mandrels. 	<ol style="list-style-type: none"> 1. Replace blade. Tighten blade bolt. 2. Level mower deck. 3. Clean underside of mower housing. 4. Replace blade mandrel. 5. Clean around mandrels to open vent holes.

TROUBLESHOOTING CHART

PROBLEM	CAUSE	CORRECTION
Mower blades will not rotate	<ol style="list-style-type: none"> 1. Obstruction in clutch mechanism. 2. Worn/damaged mower drive belt. 3. Frozen idler pulley. 4. Frozen blade mandrel. 	<ol style="list-style-type: none"> 1. Remove obstruction. 2. Replace mower drive belt. 3. Replace idler pulley. 4. Replace blade mandrel.
Poor grass discharge	<ol style="list-style-type: none"> 1. Engine speed too slow. 2. Travel speed too fast. 3. Wet grass. 4. Mower deck not level. 5. Low/uneven tire air pressure. 6. Worn, bent or loose blade. 7. Buildup of grass, leaves and trash under mower. 8. Mower drive belt worn. 9. Blades improperly installed. 10. Improper blades used. 11. Clogged mower deck vent holes from buildup of grass, leaves, and trash around mandrels. 	<ol style="list-style-type: none"> 1. Place throttle control in "FAST" position. 2. Shift to slower speed. 3. Allow grass to dry before mowing. 4. Level mower deck. 5. Check tires for proper air pressure. 6. Replace/sharpen blade. Tighten blade bolt. 7. Clean underside of mower housing. 8. Replace mower drive belt. 9. Reinstall blades sharp edge down. 10. Replace with blades listed in this manual. 11. Clean around mandrels to open vent holes.
Headlight(s) not working (if so equipped)	<ol style="list-style-type: none"> 1. Switch is "OFF". 2. Bulb(s) or lamp(s) burned out. 3. Faulty light switch. 4. Loose or damaged wiring. 5. Blown fuse. 	<ol style="list-style-type: none"> 1. Turn switch "ON". 2. Replace bulb(s) or lamp(s). 3. Check/replace light switch. 4. Check wiring and connections. 5. Replace fuse.
Battery will not charge	<ol style="list-style-type: none"> 1. Bad battery cell(s). 2. Poor cable connections. 3. Faulty regulator (if so equipped). 4. Faulty alternator. 	<ol style="list-style-type: none"> 1. Replace battery. 2. Check/clean all connections. 3. Replace regulator. 4. Replace alternator.
Engine "backfires" when turning engine "OFF"	<ol style="list-style-type: none"> 1. Engine throttle control not set at "SLOW" position for 30 seconds before stopping engine. 	<ol style="list-style-type: none"> 1. Move throttle control to "SLOW" position and allow to idle for 30 seconds before stopping engine.

TRACTOR -- MODEL NUMBER 917.272431

SCHEMATIC

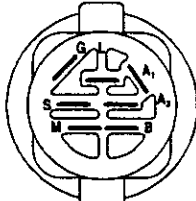
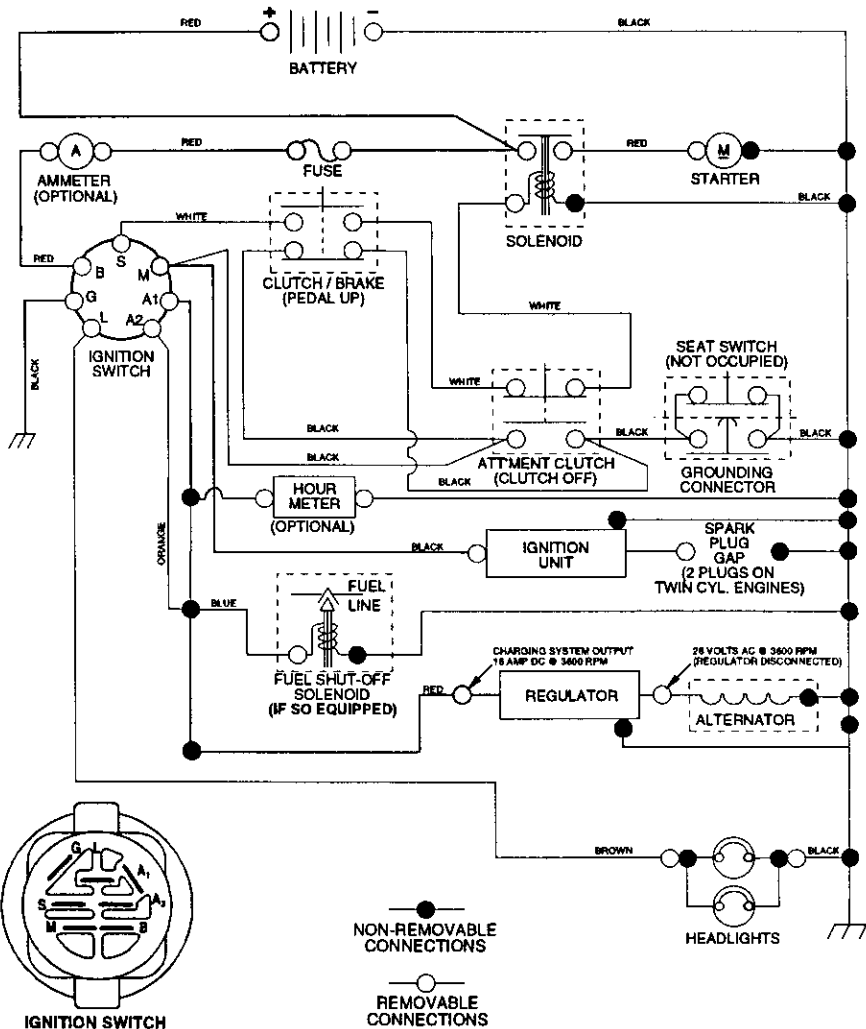

IGNITION SWITCH

POSITION	CIRCUIT	"MAKE"
OFF	M+G+A1	NONE
RUN/LIGHT	B+A1	A2+L
RUN	B+A1	NONE
START	B + S + A1	NONE

WIRING INSULATED CLIPS

NOTE: IF WIRING INSULATED CLIPS WERE REMOVED FOR SERVICING OF UNIT, THEY SHOULD BE REPLACED TO PROPERLY SECURE YOUR WIRING.

REPAIR PARTS

TRACTOR -- MODEL NUMBER 917.272431

ELECTRICAL

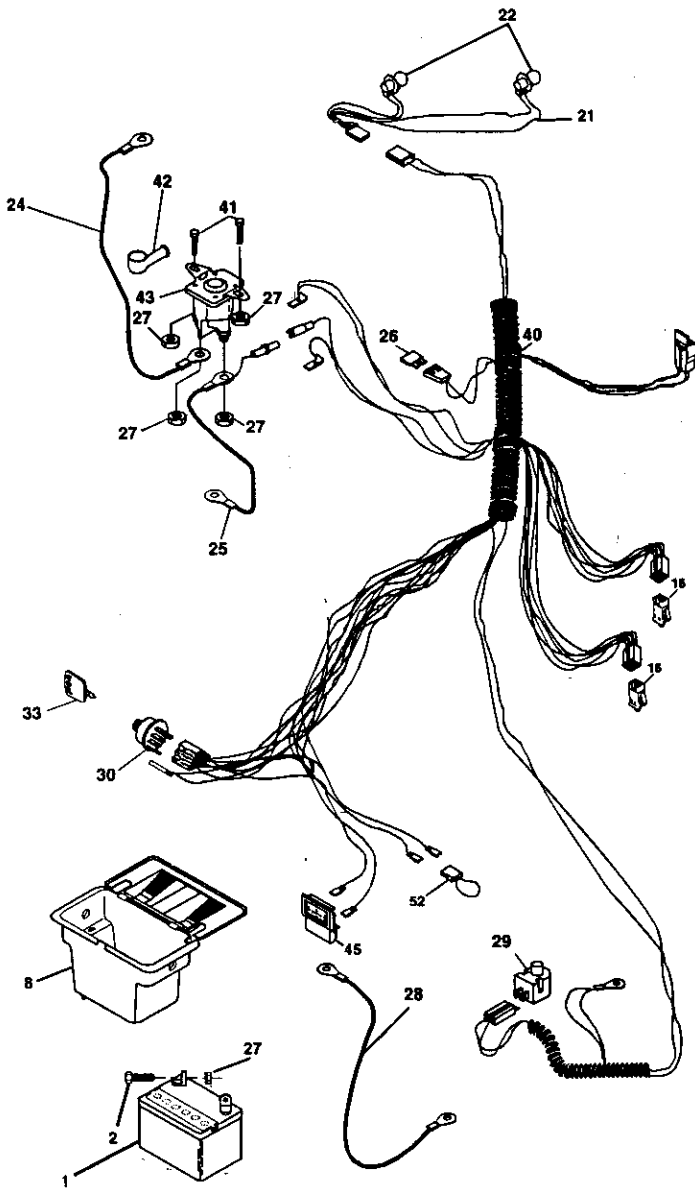

ELECTRICAL

TRACTOR -- MODEL NUMBER 917.272431

KEY PART NO.	NO.	DESCRIPTION
1	163465	Battery 12 VOLT 28 AMP
2	74760412	Bolt Hex Hd 1/4-20unc x 3/4
8	156417	Case Battery
16	153664	Switch, Interlock Push-in
21	175688	Harness Light Socket (W/4152J)
22	4152J	Bulb
24	4799J	Cable Battery
25	146147	Cable Battery
26	175158	Fuse
27	73510400	Nut Keps Hex 1/4-20 Unc
28	4207J	Cable Ground
29	121305X	Switch Seat
30	175566	Switch Ign
33	140403	Key Molded Craftsman
40	178437	Harness Ign
41	71110408	Bolt Blk. Fin Hex 1/4-20 Unc x 1/2
42	131563	Cover Terminal
43	178861	Solenoid
45	122822X	Ammeter Rectangular 15 Amp
52	141940	Protection Wire Loop

NOTE: All component dimensions given in U. S.
Inches 1 inch = 25.4 mm

TRACTOR -- MODEL NUMBER 917.272431
CHASSIS AND ENCLOSURES

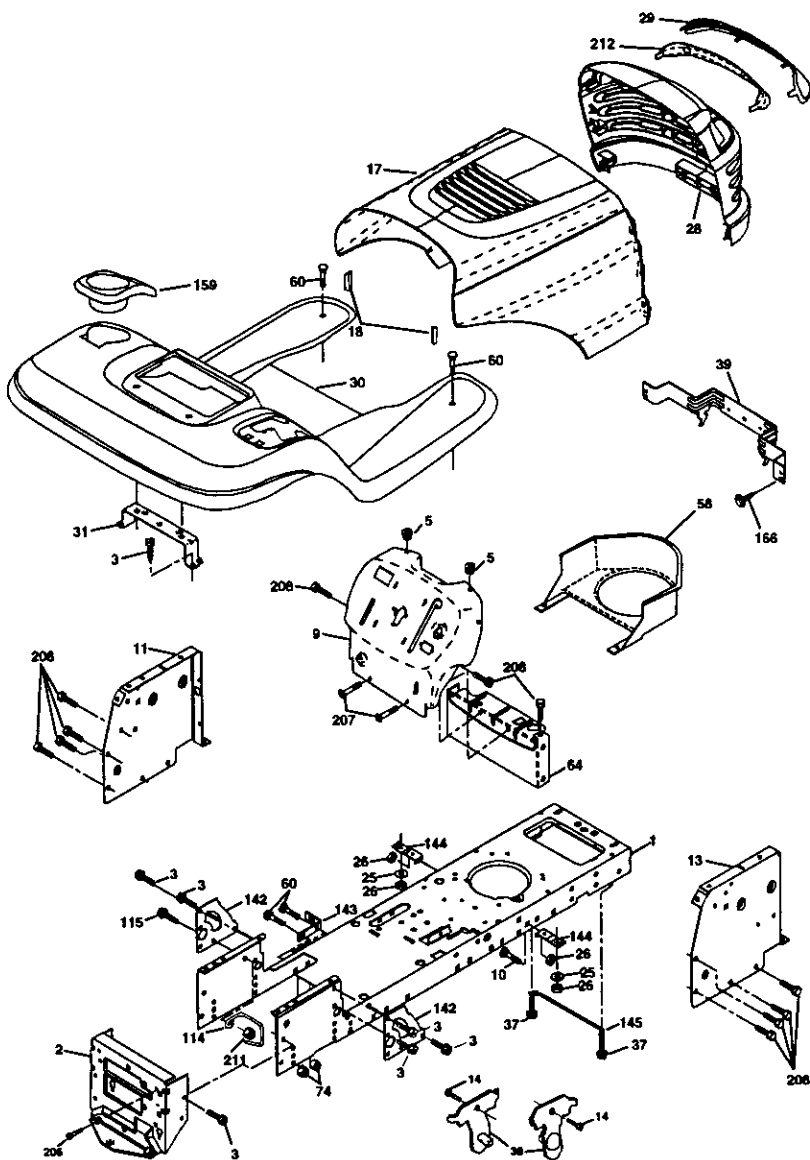

**TRACTOR -- MODEL NUMBER 917.272431
CHASSIS AND ENCLOSURES**

KEY PART NO.	PART NO.	DESCRIPTION
1	174619	Chassis Assembly
2	176554	Drawbar
3	17060612	Screw 3/8-16 x 3/4
5	155272	BumperHood/Dash
9	168337X013	Dash
10	STD533710	Bolt, Carriage 3/8-16 x 1
11	155927	Panel, Dash, L.H.
13	172107X010	Panel, Dash, R.H.
14	17490608	Screw Thdrol 3/8-16 x 1/2
17	174330X612	Hood Assembly
18	126938X	BumperHood
25	19131312	Washer 13/32 x 13/16 x 12 Gauge
26	STD541437	Locknut, Hex, with Insert 3/8-16 Unc
28	177403	Grille/Lens Asm
29	174332X599	Lens, Laser
30	175692X612	Fend/Ftrest
31	139976	Bracket, Fender Support
37	17490508	Screw Thdrol 5/16-18 x 1/2
38	175710	Pivot Bracket Assembly
39	174714	Bracket Pivot Laser LT
58	174930	Air Duct P/L B&S
60	STD533707	Bolt Rdhd Sqnk 3/8-16 UNC x 3/4
64	154798	Dash Lower STLT
74	STD541437	Nut Crownlock 3/8-16 UNC
114	158112	Keeper Belt Rear Lh Stl
115	17060620	Screw 3/8-16 x 1-1/4
142	165867	Plate Reinforcement STLT
143	154966	Bracket Swaybar Chassis
144	175582	Bracket Pnt Footrest STLT
145	156524	Rod Pivot Chassis/Hood
159	155123X428	Cupholder
166	164863	Screw Hwhd. Hi-Lo. #13-16 x 3/4
206	170165	Bolt Shoulder 5/16-18 TT
207	17670508	Screw Thdrol 5/16-18 x 1/2
208	17670608	Screw Thdrol 3/8-16 x 1/2
211	145212	Nut Hexflange Lock
212	175143	Insert Lens Reflective Laser
--	5479J	Plug Button

NOTE: All component dimensions given in U. S.
inches 1 inch = 25.4 mm

TRACTOR -- MODEL NUMBER 917.272431
GROUND DRIVE

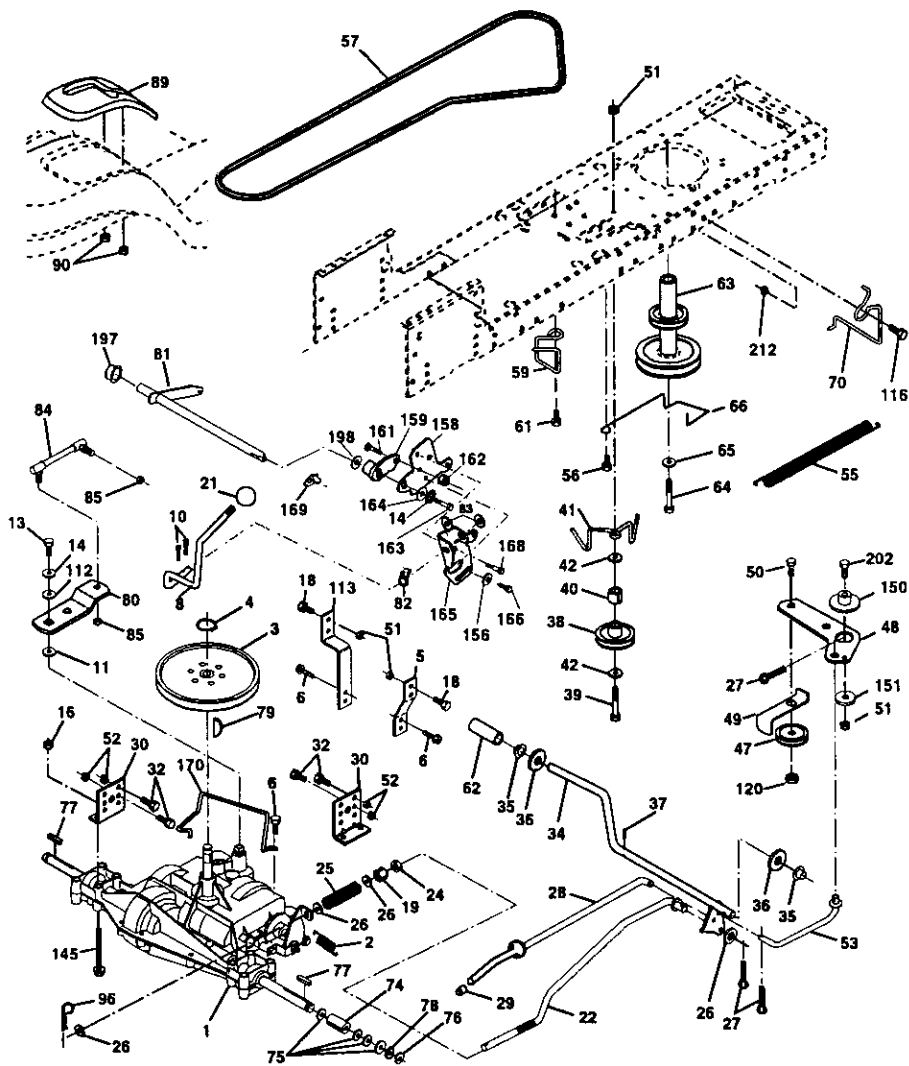

TRACTOR -- MODEL NUMBER 917.272431

GROUND DRIVE

KEY PART NO.	PART NO.	DESCRIPTION	KEY PART NO.	PART NO.	DESCRIPTION
1	-----	Transaxle (See Breakdown)	62	8883R	Cover, Pedal
		Peerless 206-545C	63	175410	Pulley, Engine
2	146682	Spring, Return, Brake	64	71170764	Bolt, Hex 7/16-20 x 4 Grade 5
3	123666X	Pulley, Transaxle	65	STD551143	Washer
4	12000028	Ring, Retainer	66	154778	Keeper, Belt, Engine, Fool-Proof
5	121520X	Strap, Torque	70	134683	Guide, Mower Drive Belt, R.H.
6	17060512	Screw 5/16-18 x 3/4	74	137057	Spacer, Axle
8	165866	Rod Shifter Fender STLT	75	121749X	Washer 25/32 x 1-1/4 x 16 Ga.
10	STD561210	Pin, Cotter	76	STD581075	E-Ring
11	105701X	Washer, Shift Plate	77	123583X	Key, Square 2.0 x .1845/.1865
13	74550412	Bolt 1/4-28 UNF W/Patch Gr. 8	78	121748X	Washer 25/32 x 1-5/8 x 16 Ga
14	10040400	Washer Lock Hvy Helical	79	STD580025	Key Woodruff
16	73800500	Nut Lock Hx W/Ins 5/16-18	80	145090	Arm, Shift
18	STD523710	Bolt Fin Hex 3/8-16UNC x 1 Gr 5	81	165592	Shaft Asm Cross Tapered 650 20
19	STD541437	Nut	82	165711	Spring, Torsion
21	106933X	Knob	83	19171216	Washer 17/32 x 3/4 x 16 Ga.
22	130604	Rod, Brake	84	166231	Link Transaxle
24	STD541237	Nut	85	150360	Nut, Nylock
25	106888X	Spring, Brake Rod	89	158391X428	Console, Shift, STLT
26	STD551037	Washer	90	124346X	Nut, Self-Thdng, Wsh Hd 1/4
27	STD561210	Pin	96	STD624003	Retainer Spring 1"
28	175765	Rod, Parking Brake	112	19091210	Washer 9/32 x 3/4 x 10 Gauge
29	71673	Cap, Parking Brake	113	127285X	Strap Torque 90 Degrees
30	169592	Bracket, Transaxle	116	72140608	Bolt Rdhd Sqneck 3/8-16 x 1
32	STD523107	Bolt	120	73900600	Nut Lock Fig. 3/8-16
34	175578	Shaft Assembly, Foot Pedal	145	74490540	Bolt, Hex Fighd 5/16-18 Gr. 5
35	120183X	Bearing, Nylon	150	175456	Spacer Retainer
36	STD551062	Washer	151	19133210	Washer 13/32 x 2 x 10 Ga.
37	STD571810	Roll Pin	156	166002	Washer Srted 5/16ID x 1.125
38	165936	Pulley, Composite, Flat	158	165589	Bracket Shift Mount
39	74760648	Bolt Fin Hex 3/8-16 x 3	159	165494	Hub Tapered Flange Shift Lt
40	175461	Spacer, Split	161	72140406	Bolt Rdhd Sqnc 1/4-20 x 3/4 Gr. 5
41	175556	Keeper, Belt, Idler	162	73680400	Nut Crownlock 1/4-20 Unc
42	19131312	Washer 13/32 x 13/16 x 12 Ga.	163	74780416	Bolt Hex Fin 1/4-20Unc x 1 Gr 5
47	127783	Pulley, Idler, V-Groove, Plastic	164	19091010	Washer 5/8 x .281 x 10 Ga
48	154407	Bellcrank Clutch Grnd Div Stl	165	165623	Bracket Pivot Lever
49	123205X	Retainer, Belt	166	166880	Screw 5/16-18 x 5/8
50	STD523715	Bolt	168	165492	Bolt Shoulder 5/16-18 x .561
51	STD541437	Nut Crown Lock 3/8-16 UNC	169	165580	Plate Fastening Lt
52	STD541431	Nut Crown Lock 5/16-18 UNC	170	173898	Keeper Belt Transaxle Gear
53	105710X	Link, Clutch	197	169613	Nyliner Snap-In
55	105709X	Spring, Clutch Return	198	169593	Washer Nyliner
56	17060616	Screw 3/8-16 x 1.0	202	72110614	Bolt Carr. SH 3/8-16 x 1-3/4
57	130801	V-Belt, Ground Drive	212	145212	Nut Hex Fig. Lock
59	169691	Keeper, Belt, Center Span			
61	17060612	Screw 3/8-16 x 3/4			

NOTE: All component dimensions given in U. S. inches 1 inch = 25.4 mm

STEERING **TRACTOR -- MODEL NUMBER 917.272431**

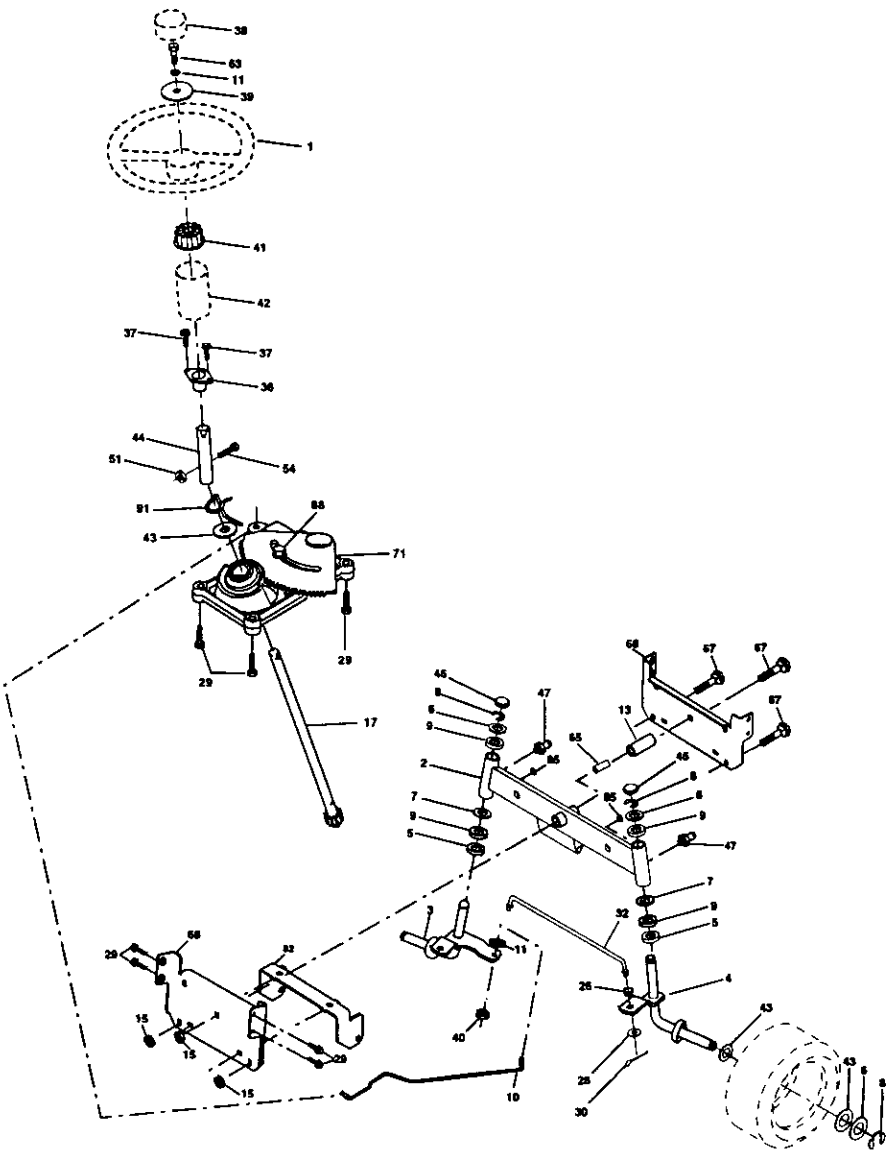

STEERING

TRACTOR -- MODEL NUMBER 917.272431

KEY PART NO.	NO.	DESCRIPTION
1	159944X428	Steering Wheel
2	154427	Axle Assembly STMP Dropped STL
3	169840	Spindle Assembly, L.H.
4	169839	Spindle Assembly, R.H.
5	6266H	Bearing, Race, Thrust, Hardened
6	121748X	Washer 25/32 x 1-5/8 x 16 Gauge
7	19272016	Washer 27/32 x 1-1/4 x 16 Gauge
8	12000029	Ring, Klip
9	3366R	Bearing, Steering Column
10	175121	Draglink
11	STD551137	Washer, Lock
13	136518	Spacer, Bearing, Axle
15	145212	Nut, Hexflange Lock
17	177876	Shaft Assembly, Steering
26	126847X	Bushing, Link, Drag
28	19131416	Washer 13/32 x 7/8 x 16 Gauge
29	17060612	Screw 3/8-16 x 3/4
30	STD561210	Pin Cotter
32	130465	Rod, Tie
36	155099	Bushing, Steering
37	152927	Screw
38	159946X428	Insert, Steering Wheel
39	19132411	Washer 13/32 x 2-3/8 x 12 Gauge
40	STD541537	Gripco Nut
41	159945	Adaptor, Steering Wheel
42	145054X428	Boot, Steering Shaft
43	121749X	Washer 25/32 x 1-1/4 x 16 Gauge
44	153720	Extension Shaft Steering LR.LT
46	121232X	Cap, Spindle
47	6855M	Fitting, Grease
51	STD541431	Nut Lock Hex w/Ins. 5/16-18 UNC
54	74780520	Bolt Fin Hex 5/16-18 UNC x 1-1/4
63	STD523710	Bolt, Fin Hex 3/8-16 UNC x 1 Gr 5
65	160367	Spacer Axle
67	72140618	Bolt RDHD SQNK 3/8-16 x 2-1/4
68	169827	Axle, Brace
71	175146	Steering Asm
82	169835	Bracket Susp Chassis Front
85	133835	Fastner Christmas Tree
88	175118	Bolt Shoulder 7/16-20
91	175553	Clip Steering

NOTE: All component dimensions given in U. S.
Inches 1 inch = 25.4 mm

TRACTOR -- MODEL NUMBER 917.272431

ENGINE

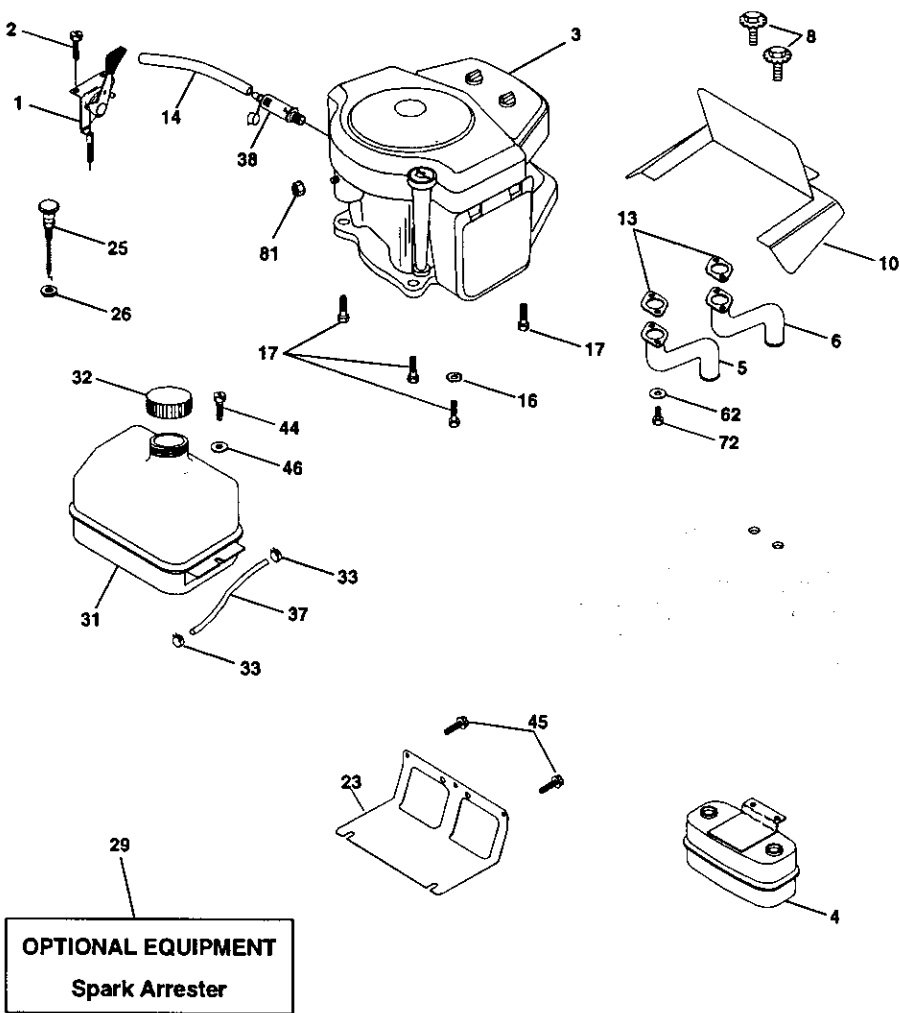

OPTIONAL EQUIPMENT
Spark Arrester

ENGINE**TRACTOR -- MODEL NUMBER 917.272431**

KEY PART NO.	PART NO.	DESCRIPTION
1	170546	Control, Throt Paddle
2	17720410	Screw, Hex Thd Cut 1/4-20 x 5/8
3	-----	Engine, B&S, (See Breakdown) No. 407777-0121-E3
4	149723	Muffler Exhaust
5	159955	Exhaust Asm. Left
6	160589	Exhaust Asm. Right
8	171877	Bolt 5/16-18unc x 3/4 W/Sems
10	162797	Heat Shield Lt
13	165391	Gasket, Muffler
14	148456	Tube Drain Oil Easy
16	STD551237	Washer Lock Ext Tooth 3/8
17	17490624	Screw Thdrol 3/8-16x1-1/2 Tytt
23	169837	Shield, Brn/Dbr Guard
25	145996	Control Choke
26	73920600	Nut Keps 3/8-24 Unf
29	137180	Arrestor, Spark
31	109202X	Tank, Fuel
32	158990	Cap Fuel Guage
33	123487X	Clamp, Hose
37	137040	Line, Fuel
38	148315	Plug, Oil Drain Easy
44	17670412	Screw Hxwsh Thdrol 1/4-20 x 3/4
45	17000612	Screw Hex Wsh 3/8-16 x 3/4
46	19091416	Washer 9/32 x 7/8 x 16 Ga
62	10040500	Washer Lock Hlcl 5/16
72	71070512	Screw Hx Hd Cap 5/16-18 x 3/4
81	73510400	Nut Keps Hex 1/4-20 Starter Nut

NOTE: All component dimensions given in U. S.
Inches 1 inch = 25.4 mm

TRACTOR -- MODEL NUMBER 917.272431
SEAT ASSEMBLY

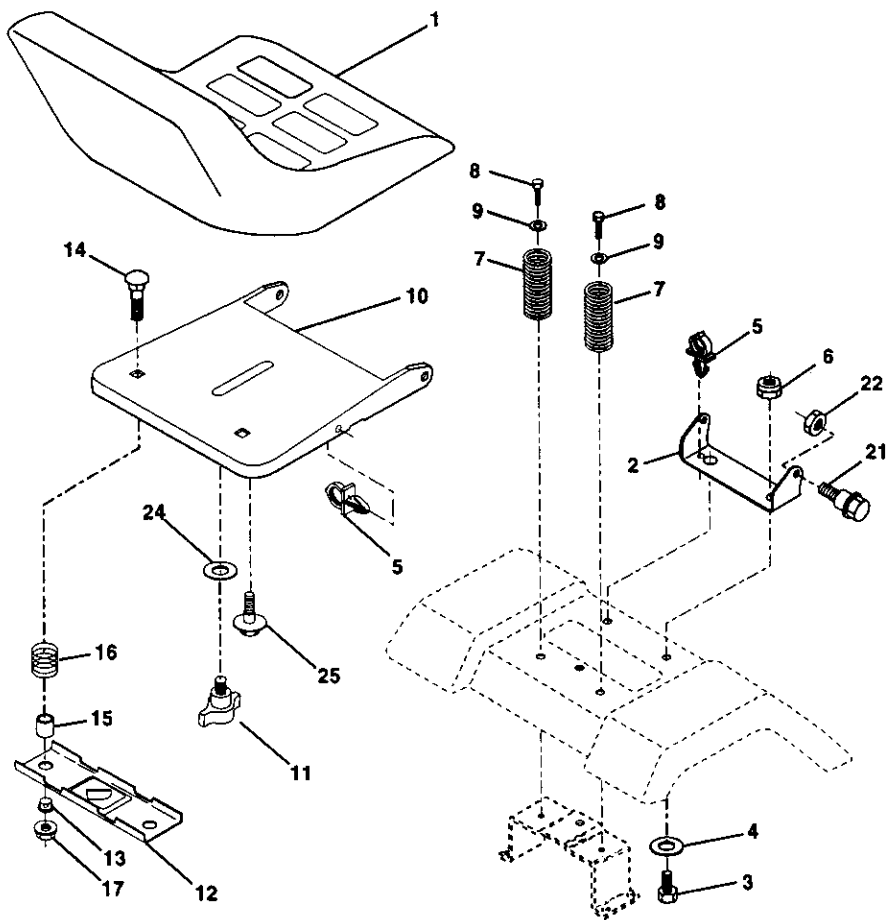

**KEY PART
 NO. NO.**

KEY PART NO.	NO.	DESCRIPTION
1	140123	Seat 3350 Blk/blk Craftsman
2	140551	Bracket Pnt Pivot Seat (blk)
3	71110616	Bolt Fin Hex 3/8-16unc X 1
4	19131610	Washer 13/32 X 3/4 X 10 Ga
5	145006	Clip Push In Hinged
6	STD541437	Nut Hex Lock w/Ins 3/8-16 Unc
7	124181X	Spring Seat Cprsn 2 250 Blk Zi
8	17000616	Screw 3/8-16 x 1.5 SMGML
9	19131614	Washer 13/32 X 1 X 14 Ga
10	174894	Pan Pnt Seat (blk)
11	166369	Knob Seat
12	121246X	Bracket Pnt Mounting Switch

**KEY PART
 NO. NO.**

KEY PART NO.	NO.	DESCRIPTION
13	121248X	Bushing Snap Blk Nyl 50 Id
14	72050412	Bolt Rdhd Sht Nk 1/4-20x1-1/2
15	134300	Spacer Split 28 X 96 Zinc
16	121250X	Spring Cprsn 1 27 Blk Pnt
17	123976X	Nut Lock 1/4 Lge Fig Gr 5 Zinc
21	171852	Bolt Shoulder 5/16-18 Unc-2A
22	STD541431	Nut Hex Lock w/Ins 5/16-18
24	19171912	Washer 17/32 X 1-3/16 X 12 Ga.
25	127018X	Bolt Shoulder 5/16-18 X 62

NOTE: All component dimensions given in U. S. inches 1 inch = 25.4 mm

TRACTOR -- MODEL NUMBER 917.272431

DECALS

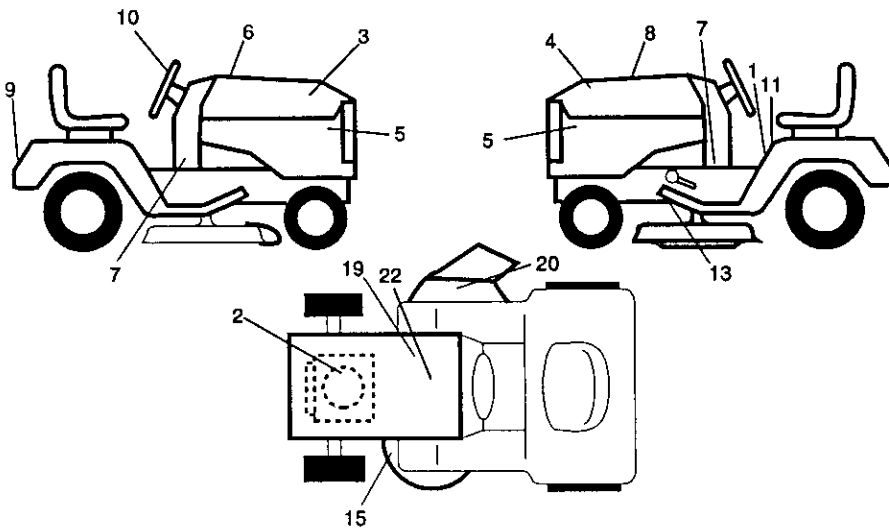

KEY PART NO.	NO.	DESCRIPTION	KEY PART NO.	NO.	DESCRIPTION
1	156439	Decal, Fender Danger Sears	11	156368	Decal, Fender STLT Oper Inst E/
2	165407	Decal, Engine	S		
3	177356	Decal, Hood, R.H.	13	146046	Decal, V-Belt Dr Sch Tractor
4	177357	Decal, Hood, L.H.	15	160396	Decal, Mower Drive Schematic
5	177355	Decal, Hood Side	19	138047	Decal, Battery Diehard Sears
6	133644	Decal, Maintenance	20	172331	Decal, Deck Sears
7	177284	Decal, Lower Dash	22	149516	Decal, Battery
8	174321	Decal, Rplcmnt	--	138311	Decal, Lift Handle
9	163204	Decal, Fender, Craftsman Gold	--	165800X428	Pad Footrest LH STLT
10	164065	Decal Strng Whl	--	165799X428	Pad Footrest RH STLT
			--	178407	Owner's Manual, English
			--	178408	Owner's Manual, Spanish

WHEELS AND TIRES

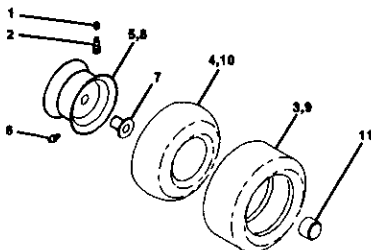

KEY PART NO.	NO.	DESCRIPTION
1	59192	Valve Cap, Tire
2	65139	Stem, Valve
3	106222X	Tire, Front
4	59904	Tube, Front Tire (Not Provided, Service Item Only)
5	106732X427	Rim, Front
6	278H	Fitting, Grease (Front Wheel Only)
7	9040H	Bearing, Flange (Front Wheel Only)
8	106108X427	Rim, Rear
9	122082X	Tire, Rear
10	7152J	Tube, Rear Tire (Not Provided, Service Item Only)
11	104757X428	Cap, Axle

NOTE: All component dimensions given in U. S. Inches 1 inch = 25.4 mm

TRACTOR -- MODEL NUMBER 917.272431
LIFT ASSEMBLY

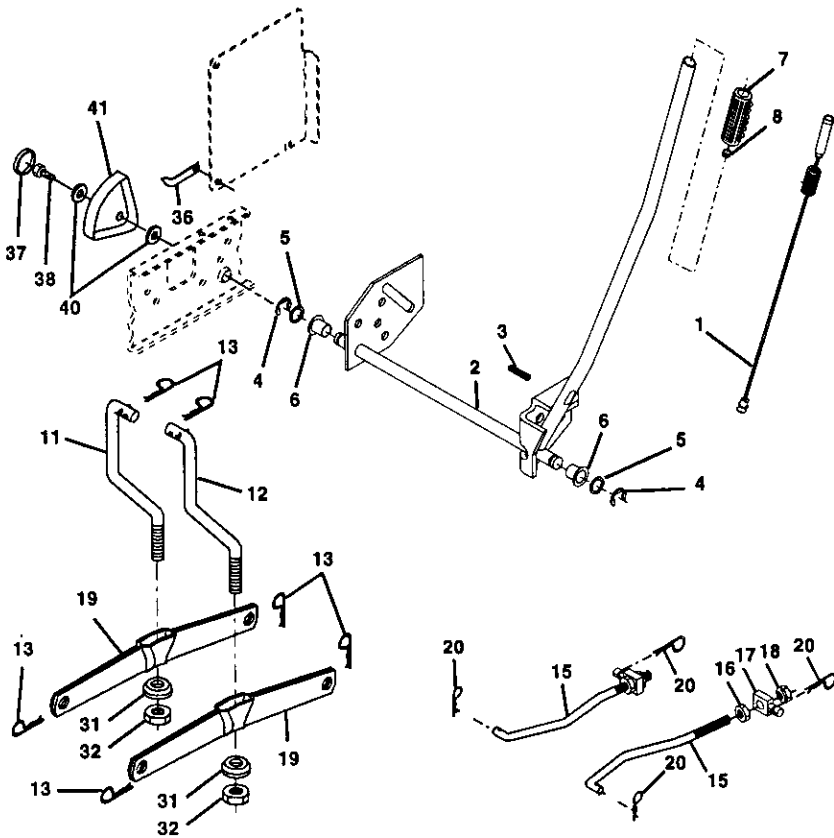

TRACTOR -- MODEL NUMBER 917.272431**LIFT ASSEMBLY**

KEY PART NO.	NO.	DESCRIPTION
1	159460	Lift Lever Inner Wire Assembly
2	159471	Shaft Assembly, Lift
3	105767X	Pin, Groove
4	12000002	E-Ring
5	19211621	Washer 21/32 x 1 x 21 Gauge
6	120183X	Bearing, Nylon
7	125631X	Grip, Handle, Fluted
8	122365X	Button, Plunger, Red
11	139865	Link, Lift, L.H.
12	139866	Link, Lift, R.H.
13	STD624008	Retainer Spring
15	173288	Link, Front
16	73350800	Nut, Hex, Jam 1/2-13 UNC
17	175689	Trunnion
18	73800800	Nut Lock w/Wsh 1/2-13 UNC
19	139868	Arm, Suspension, Rear
20	163552	Retainer Spring
31	169865	Bearing, Pvt, Lift
32	73540600	Nut, Crownlock 3/8-24
36	155097	Pointer Hght. Ind
37	123935X	Plug Hole Blk
38	17060516	Screw 5/16-18 x 1
40	19112410	Washer 11/32 x 1-1/2 x 10 Ga
41	155098	Indication Hght.

NOTE: All component dimensions given in U. S.
Inches 1 inch = 25.4 mm

TRACTOR -- MODEL NUMBER 917.272431

MOWER DECK

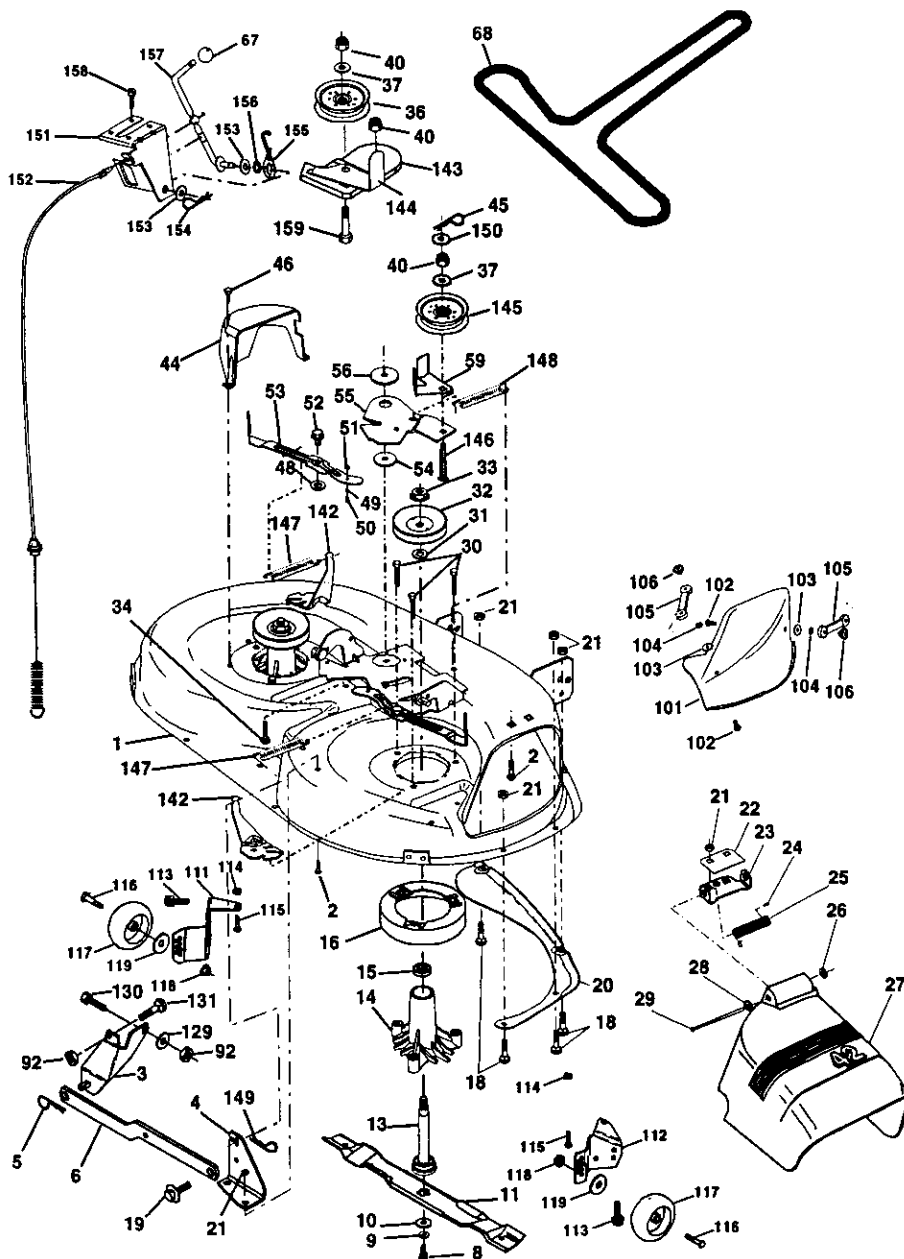

TRACTOR -- MODEL NUMBER 917.272431

MOWER DECK

KEY PART NO.	NO.	DESCRIPTION	KEY PART NO.	NO.	DESCRIPTION
1	165892	Mower Deck Assembly, 42"	59	141043	Guard, TUV Idler
2	STD533107	Bolt	67	149846	Knob Custom Oval
3	138017	Bracket Assembly, Sway Bar, Front	68	144959	V-Belt
4	165460	Bracket Sway Bar 38/42" Deck	92	STD541437	Nut
5	STD624008	Retainer Spring	101	136420	Mulcher Cover
6	130832	Arm, Suspension, Rear	102	71081010	Screw Pan HD Phillip 10-24 x 5/8
8	850857	Bolt, Hex 3/8-24 x 1.25 Gr. 8	103	19061216	Washer #10
9	STD551137	Washer, Lock	104	STD551110	Washer, Lock
10	140296	Washer, Hardened	105	160793	Latch Assembly, Bagger
11	134149	Blade, Mulching	106	2029J	Nut, Weld
13	137645	Shaft Assembly, Mandrel, Vented	111	155197	Bracket, Gauge, Wheel L.H.
14	128774	Housing, Mandrel, Vented	112	155198	Bracket, Gauge, Wheel R.H.
15	110485X	Bearing, Ball, Mandrel	113	17060514	Screw 5/16-18
16	174493	Stripper, Mower Deck	114	STD541431	Nut, Hex, Keps 5/16-18 UNC
18	72140505	Bolt, Carriage 5/16-18 x 5/8	115	72110504	Bolt, Carriage 5/16 UNC x 1/2
19	132827	Bolt, Shoulder	116	4898H	Bolt, Shoulder
20	159770	Baffle, Vortex	117	165746	Wheel, Gauge
21	STD541431	Nut Crownlock 5/16-18 UNC	118	73930600	Nut, Centerlock 3/8-16
22	134753	Stiffener Bracket	119	STD551037	Washer 3/8 x 7/8 x 14 Gauge
23	131267	Bracket, Deflector	121	143723	Bracket
24	105304X	Cap, Sleeve	129	19131312	Washer 13/32 x 13/16 x 12 Ga.
25	123713X	Spring, Torsion, Deflector	130	STD523710	Bolt, Fin Hex 3/8-16 UNC x 1 Gr. 5
26	110452X	Nut, Push	131	STD533710	Bolt, Rdhd Sqnk 3/8-16UNC x 1
27	130968X428	Shield, Deflector	142	165890	Arm Spring Brake Mower
28	19111016	Washer 1 1/32 x 5/8 x 16 Ga.	143	157109	Bracket Arm Idler 42"
29	131491	Rod, Hinge	144	158634	Keeper Belt 42" Clutch Cable
30	157722	Screw Thdrol Washer Head	145	165888	Pulley Idler Flat
31	129963	Washer, Spacer	146	171977	Bolt Carriage Idler
32	153535	Pulley, Mandrel	147	131335	Spring Extension
33	178342	Nut, Toplock, Flanged	148	169022	Spring Return Idler
34	STD533717	Bolt	149	165898	Retainer Spring Yellow Zinc
36	131494	Pulley, Idler, Flat	150	19091216	Washer 9/32 x 3/4 x 16 Ga.
37	STD551037	Washer 13/32 x 13/16 x 16 Gauge	151	169670	Bracket Clutch
40	STD541437	Nut Crownlock 3/8-16 UNC	152	169676	Cable Clutch 42 In
44	140088	Guard, Mandrel, L.H.	153	169674	Washer Flat 3/8" Type B
45	STD624003	Retainer	154	169675	Spring Retainer
46	137729	Screw, Thd. Roll 1/4-20 x 5/8	155	169671	Spring Retention Lever
48	133944	Washer, Hardened	156	169672	Spacer
49	174284	Roller Assembly, Cam Follower	157	169669	Rod Clutch
50	131340	Bolt, Shoulder #10-24 Grade 5	158	17720410	Screw Hex Thd Cut 1/4-20 x 5/8
51	STD541410	Locknut	159	STD533717	Bolt Rdhd Sqn 3/8-16Unc x 1-3/4
52	139888	Bolt, Shoulder 5/16-18 UNC	--	130794	Mandrel Assembly (Includes Key Numbers 8-10, 13-15, 31 and 32)
53	131845	Arm Assembly, Pad, Brake	--	169583	Replacement Mower, Complete
54	133943	Washer, Hardened			
55	155046	Arm, Idler			
56	165723	Spacer, Retainer			

NOTE: All component dimensions given in U. S. inches 1 inch = 25.4 mm

**TRACTOR -- MODEL NUMBER 917.272431
PEERLESS TRANSAXLE--MODEL NUMBER 206-545C**

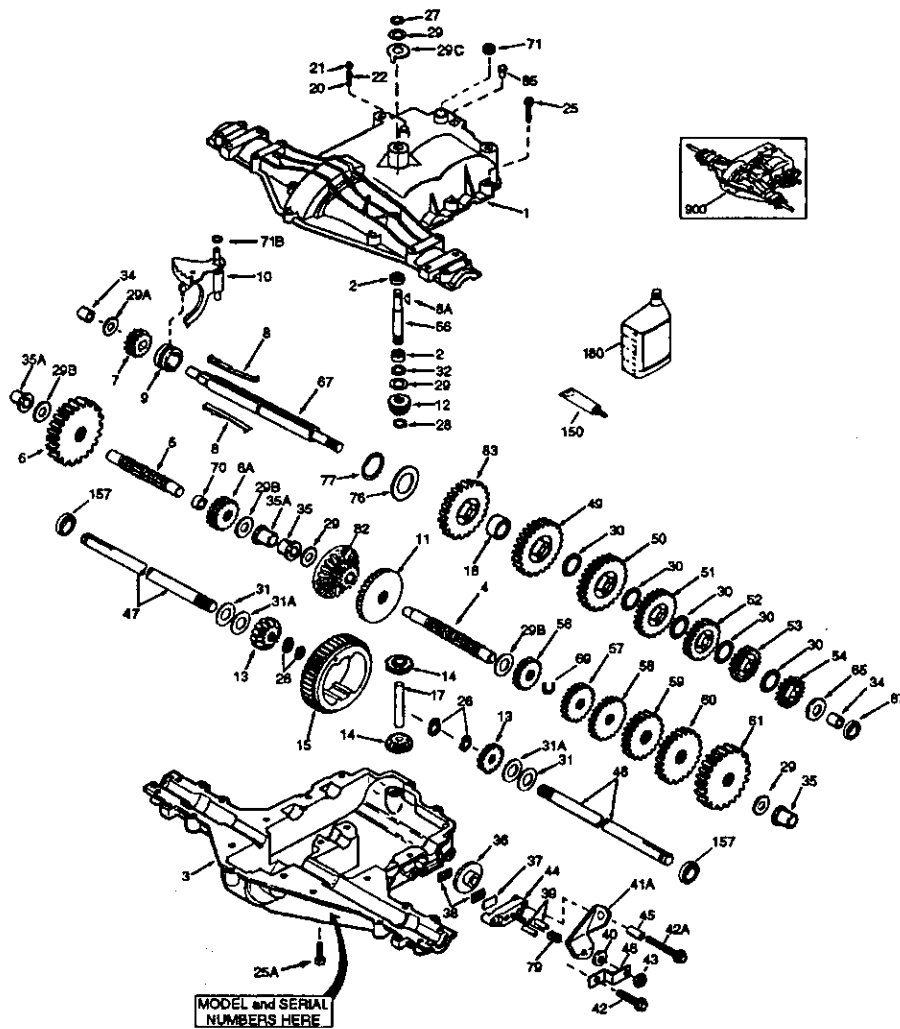

TRACTOR -- MODEL NUMBER 917.272431

PEERLESS TRANSAXLE--MODEL NUMBER 206-545C

KEY PART NO. NO.	DESCRIPTION	KEY PART NO. NO.	DESCRIPTION
1	772147 Transaxle Cover	39	786026 Dowel Pin
2	780086A Needle Bearing 5/8"	40	792076A Flat Washer .312 ID x .059W
3	770128 Transaxle Case	41A	790079 Brake Lever
4	776395 Countershaft	42	792073A Screw 1/4 - 20 x 1-1/4"
5	776409 Output Shaft	42A	792085A Screw 1/4 - 20 x 2 1/4"
6	778364 Spur Gear (38 teeth)	43	792075 Locknut 5 / 16 - 24
6A	778369 Spur Gear (15 teeth)	44	790025 Brake Pad Holder
7	778330 Spur Gear (11 teeth)	45	786066 Spacer .2625 x 1.0
8	792180 Shift Key	46	786086 Brake Lever Bracket
8A	792047 Woodruff Key #9	47	774690 Axle (11-15 / 16" Long)
9	784352 Shift Collar	48	774691 Axle (16 - 1 / 2" long)
10	784378 Shift Rod & Fork	49	778356 Spur Gear (29 teeth)
11	778334 Bevel Gear (30 teeth)	50	778338 Spur Gear (27 teeth)
12	778309 Input Bevel Pinion (13 teeth)	51	778354 Spur Gear (23 teeth)
13	778368 Bevel Gear (13 teeth) (Include. 14)	52	778352 Spur Gear (19 teeth)
14	778368 Bevel Pinion (13 teeth) (Include. 13)	53	778350 Spur Gear (16 teeth)
15	778370 Ring Gear (43 teeth)	54	778346 Spur Gear (15 teeth)
17	786188 Drive Pin	56	778355 Spur Gear (11 teeth)
18	786102 Spacer 1.130 X .895	57	778337 Spur Gear (13 teeth)
20	792077A Ball 5/16" dia	58	778353 Spur Gear (17 teeth)
21	792078 Set Screw 3/8 - 16 x 3/8"	59	778351 Spur Gear (21 teeth)
22	792079 Spring .310 OD x .625 L	60	778349 Spur Gear (24 teeth)
25	792073A Screw 1/4 - 20 x 1-1/4"	61	778345 Spur Gear (25 teeth)
25A	792177 Screw 1/4-20 x 1-3/8"	65	780189 Flat Washer .563 ID x .062W
26	792125 Retaining Ring (pkg of 2)	66	776422 Input Shaft
27	792035 Retaining Ring	67	776396 Shifter & Brake Shaft
28	788040 Retaining Ring	69	792170 Retaining Ring
29	780072 Thrust Washer .627 ID x .031W	70	786187 Spacer .890
29A	780160 Thrust Washer .762 ID x .031W	71	788069 Square Cut Ring
29B	780051 Thrust Washer .762 ID x .031W	71B	788092 "O" Ring
29C	780199 Anti-Rotation Washer .632	76	780090 Flat Washer 1.128 ID x .058W
30	780108 Cup Washer 1.127 ID x .032W	77	788078A Inverted Retaining Ring
31	780001 Flat Washer .750 ID x .056W (Use As Needed)	79	792144 Spring .430 OD x .5000 L
31A	780195 Flat Washer .750 ID x .062W	82	778333 Bevel & Spur Gear (30 & 13 teeth)
32	788083 Oil Seal 5/8"	83	778338 Spur Gear (27 teeth)
34	780194 Bushing .583	85	792154 Oil Fill Plug
35	780193 Flanged Bushing 5 / 8" ID	87	788089A Oil Seal 9 / 16"
35A	780197 Flanged Bushing .751	150	788093A Liquid Gasket RTV Silicone
36	790075 Brake Disk	157	788088A Oil Seal 3 / 4"
37	790007 Brake Pad Plate	180	730229A Gear Oil 80W90
38	799021 Brake Pad (pkg of 2)	900	794712 Replacement MST 206-545C Transaxle

NOTE: All component dimensions given in U.S.
inches 1 inch = 25.4 mm

**TRACTOR – MODEL NUMBER 917.272431
BRIGGS & STRATTON ENGINE-MODEL NUMBER 407777, TYPE NUMBER 0121-E3**

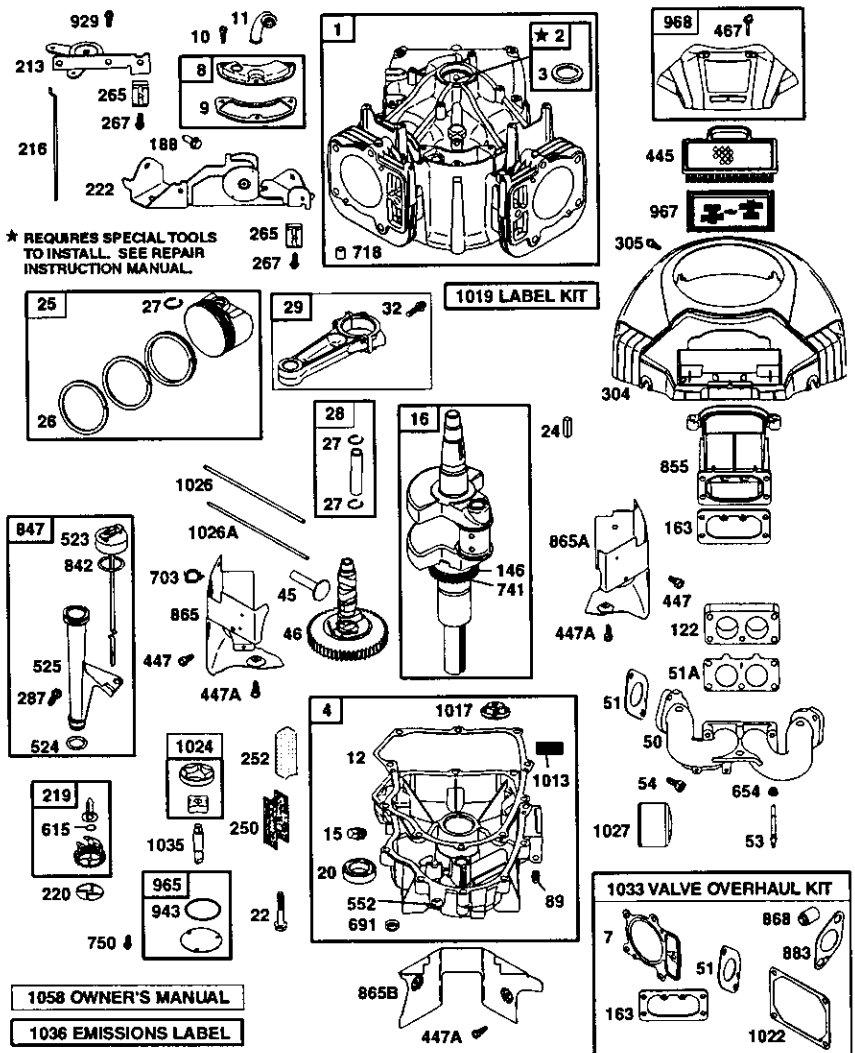

TRACTOR - MODEL NUMBER 917.272431
BRIGGS & STRATTON ENGINE-MODEL NUMBER 407777, TYPE NUMBER 0121-E3

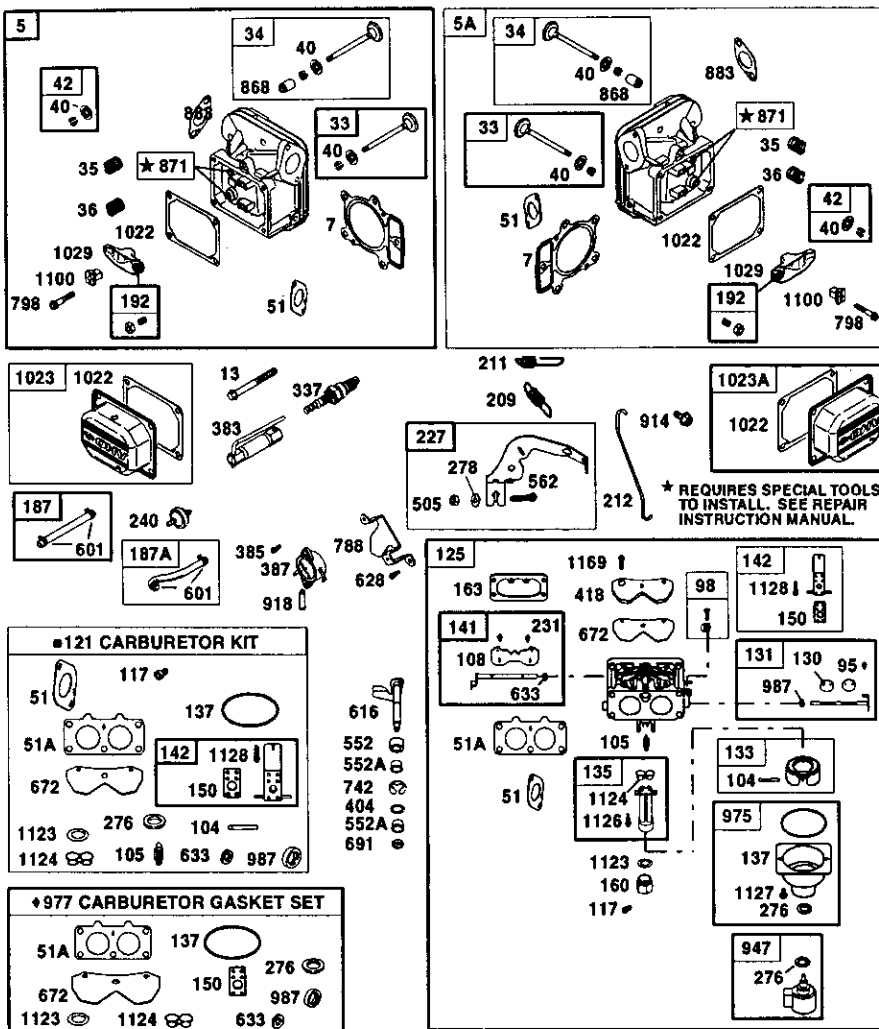

**TRACTOR – MODEL NUMBER 917.272431
BRIGGS & STRATTON ENGINE-MODEL NUMBER 407777, TYPE NUMBER 0121-E3**

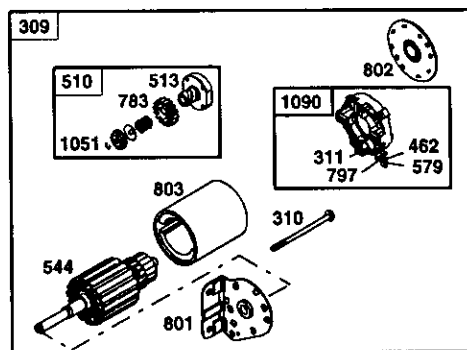
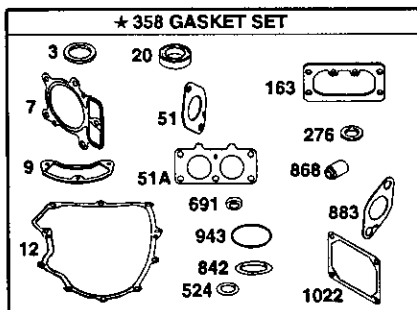
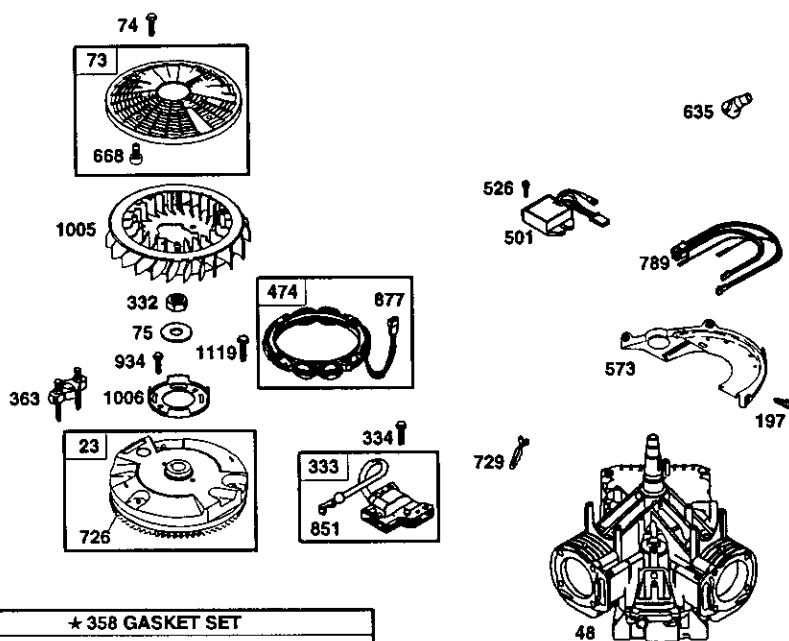

TRACTOR – MODEL NUMBER 917.272431
BRIGGS & STRATTON ENGINE-MODEL NUMBER 407777, TYPE NUMBER 0121-E3

KEY NO.	PART NO.	DESCRIPTION	KEY NO.	PART NO.	DESCRIPTION
1	690231	Cylinder Assembly	121	499811	Carburetor Overhaul Kit
2	499585	Bushing-Cylinder	122	690952	Spacer-Carburetor
3	391086	• Seal-Oil	125	499804	Carburetor
4	690069	Sump-Engine	130	690993	Valve-Throttle
5	499587	Head-Cylinder No. 1	131	499805	Throttle Shaft Kit
5A	499595	Head-Cylinder No. 2	133	499806	Float-Carburetor
7	690962	•+ Gasket-Cylinder Head	135	499803	Fuel Transfer Tube
8	499601	Breather Assembly	137	690994	Ø‡ Gasket-Float Bowl
9	690937	• Gasket-Breather	141	499807	Ø Choke Shaft Kit
10	690960	Screw (Breather Assy.)	142	499808	Ø Nozzle-Carburetor
11	690942	Tube-Breather	146	94388	Key-Timing
12	690945	• Gasket-Crankcase	150	690995	Ø‡ Gasket-Nozzle
13	690360	Screw (Cylinder Head)	160	690996	Retainer-Solenoid
15	690946	Plug-Oil Drain	163	691001	•+ Gasket-Air Cleaner
16	691046	Crankshaft	187	691050	Line-Fuel (Cut to Required Length)
20	690947	• Seal-Oil (PTO Side)	187A	691049	Line-Fuel
22	690308	Screw (Engine Sump)	188	690960	Screw (Control Bracket)
23	691053	Flywheel	192	690083	Adjuster-Rocker Arm
24	222698	Key-Flywheel	197	690960	Screw (Back Plate)
25	499588	Piston Assembly (Std.)	209	691018	Spring-Governor
	499589	Piston Assembly (.010 O.S.)	211	691019	Spring-Governed Idle
	499590	Piston Assembly (.020 O.S.)	212	691020	Link-Throttle
	499591	Piston Assembly (.030 O.S.)	213	691021	Bracket-Choke Control
26	499604	Ring Set-Piston (Std.)	216	691022	Link-Choke
	499605	Ring Set-Piston (.010 O.S.)	219	394348	Gear-Governor
	499606	Ring Set-Piston (.020 O.S.)	220	690412	Washer (Governor Lever)
	499607	Ring Set-Piston (.030 O.S.)	222	691023	Bracket-Control
27	690975	Lock-Piston Pin	227	691048	Control Lever-Governor
28	499582	Pin-Piston	231	690718	Screw (Choke Valve)
29	499583	Rod-Connecting	240	691035	Filter-Fuel
32	690976	Screw (Connecting Rod)	250	690957	Retainer-Breather
33	499596	Valve-Exhaust	252	690956	Element-Breather
34	499597	Valve-Intake	265	691024	Clamp-Casing
35	690963	Spring-Valve (Intake)	267	695134	Screw (Casing Clamp)
36	690963	Spring-Valve (Exhaust)	276	690997	•Ø‡ Sealing Washer
40	690964	Retainer-Valve	278	690097	Washer (Gov. Control Lever)
42	499586	Keeper-Valve	287	690960	Screw (Dipstick Tube)
45	690977	Valve Tappet	304	691004	Housing-Blower
46	690978	Cam Shaft	305	691005	Screw (Blower Housing)
48	693893	Short Block	309	691262	Motor-Starter
50	690948	Manifold-Intake	310	691263	Bolt-Starter Motor
51	90949	•Ø‡ Gasket-Intake	311	497608	Brush Set
51A	690950	•Ø‡ Gasket-Intake	332	691059	Nut (Flywheel)
53	690951	Stud (Carburetor)	333	691060	Armature-Magneto
54	690953	Screw (Intake Manifold)	334	691061	Screw (Magneto Armature)
73	691055	Screen-Rotating	337	691043	Spark Plug
74	691057	Screw (Rotating Screen)	358	499889	Gasket Set
75	691056	Washer (Flywheel)	363	691062	Flywheel Puller
89	690283	Plug-Oil			
95	690718	Screw (Throttle Valve)			
98	499802	Idle Speed Kit	•		Included in Engine Gasket Set, Key. No. 358
104	690984	• Pin-Float Hinge	Ø		Included in Carburetor Overhaul Kit, Key. No. 121
105	690985	• Valve-Float Needle	‡		Included in Carburetor Gasket Set, Key. No. 977
108	690986	Valve-Choke	+		Included in Valve Overhaul Kit, Key. No. 1033
117	690232	Ø Jet-Main (Standard)			
	690989	Jet-Main (High Altitude)			

NOTE: All component dimensions given in U.S. inches 1 inch = 25.4 mm

TRACTOR – MODEL NUMBER 917.272431
BRIGGS & STRATTON ENGINE-MODEL NUMBER 407777, TYPE NUMBER 0121-E3

KEY NO.	PART NO.	DESCRIPTION	KEY NO.	PART NO.	DESCRIPTION
383	690966	Wrench-Spark Plug	855	691011	Adapter-Air
385	690960	Screw (Fuel Pump)	865	691012	Cover-Air Guide
387	808656	Pump-Fuel	865A	691014	Cover-Air Guide
404	690442	Washer (Governor Crank)	865B	691015	Cover-Air Guide
418	690999	Plate-Cover	868	690968	*+ Seal-Valve
445	499486	Filter-Air Cleaner Cartridge	871	690969	Bushing-Guide
447	691003	Screw (Air Guide Cover)	877	399916	Alternator Connector/Wire
447A	690960	Screw (Air Guide Cover)	883	690970	*+ Gasket-Exhaust
462	691261	Washer (Starter Cable)	914	690960	Screw (Rocker Cover)
467	691008	Knob-Air Cleaner	918	694000	Hose-Vacuum
474	691064	Alternator	929	691003	Screw (Choke Control Bracket)
501	691185	Regulator	934	691058	Screw (Fan Retainer)
505	691029	Nut (Gov. Control Lever)	943	690589	* O-Ring Seal (Oil Pump Cover)
510	497606	Drive-Starter	947	499809	Solenoid-Fuel
513	692024	Clutch-Drive	965	499613	Oil Pump Cover
523	691036	Dipstick	967	273638	Filter-Pre-Cleaner
524	691032	* Dipstick Tube Seal	968	499788	Cover-Air Cleaner
525	691037	Dipstick Tube	975	499810	Bowl-Float
526	690960	Screw (Regulator)	977	499812	Gasket Set-Carburetor
544	— — —	Armature-Starter (Service with 691262 Starter Motor)	987	691000	∅‡ Seal-Throttle Shaft
552	690552	Bushing-Governor Crank	1005	691243	Fan-Flywheel
552A	690553	Bushing-Governor Crank	1006	691247	Retainer-Fan
562	690311	Bolt (Gov. Control Lever)	1013	690954	Nipple-Oil Filter
573	691009	Plate-Back	1017	690770	Oil Pump Screen
579	691029	Nut (Starter Cable)	1019	690103	Label Kit
601	691038	Clamp-Hose	1022	690971	*+ Gasket-Rocker Cover
615	690317	Retainer-Governor Shaft	1023	499599	Cover-Rocker (Cyl. No. 1)
616	691045	Crank-Governor	1023A	499600	Cover-Rocker (Cyl. No. 2)
628	690960	Screw (Fuel Pump Bracket)	1024	499054	Pump-Oil
633	690998	∅‡ Seal-Choke Shaft	1026	690981	Rod-Push (Steel)
635	66538	Boot-Spark Plug	1026A	690982	Rod-Push (Aluminum)
654	690958	Nut (Carburetor)	1027	492932	Filter-Oil
668	691215	Spacer	1029	690972	Rocker Arm
672	690234	∅‡ Gasket-Carburetor Plate	1033	499890	Valve Overhaul Kit
691	690657	* Governor Shaft Seal	1035	691042	Shaft-Pump
697	690372	Screw (Drive Cap)	1036	695104	Emissions Label
703	691010	Clip	1051	691265	Ring-Retaining
718	690959	Pin-Locating	1058	274277	Owner's Manual
726	499612	Gear-Ring	1090	691293	Retainer-Brush
729	694123	Wire Clip	1100	690973	Rocker Arm Pivot
741	690980	Gear-Timing	1119	691183	Screw (Alternator)
742	690328	E-Ring Retainer	1123	690987	∅‡ O-Ring Seal (Solenoid Retainer)
750	691033	Screw (Oil Pump Cover)	1124	690988	∅‡ O-Ring Seal-Fuel Transfer Tube
783	693058	Gear-Pinion	1126	690991	Screw (Fuel Transfer Tube)
788	691039	Fuel Pump Bracket	1127	690992	Screw (Float Bowl)
789	695050	Harness-Wiring	1128	690990	∅ Screw (Carburetor Nozzle)
797	693167	Screw (Brush Retainer)	1169	690990	Screw (Carburetor Cover Plate)
798	690967	Screw (Rocker Arm)	— —	445777-0027-E2	Replacement Engine
801	691283	Cap-Drive			RPM Settings: Low Speed: 1900-2100
802	691286	Cap-End			High Speed: 3000-3200
803	— — —	Housing (Service with 691262 Starter Motor)			
842	691031	* Dipstick/Tube Seal			
847	499602	Dipstick/Tube Assembly			
851	691234	Terminal-Sparkplug			

- * Included in Engine Gasket Set, Key. No. 358
- ∅ Included in Carburetor Overhaul Kit, Key. No. 121
- ‡ Included in Carburetor Gasket Set, Key. No. 977
- + Included in Valve Overhaul Kit, Key. No. 1033

NOTE: All component dimensions given in U.S. inches 1 inch = 25.4 mm

SERVICE NOTES

SERVICE NOTES

SUGGESTED GUIDE FOR SIGHTING SLOPES FOR SAFE OPERATION

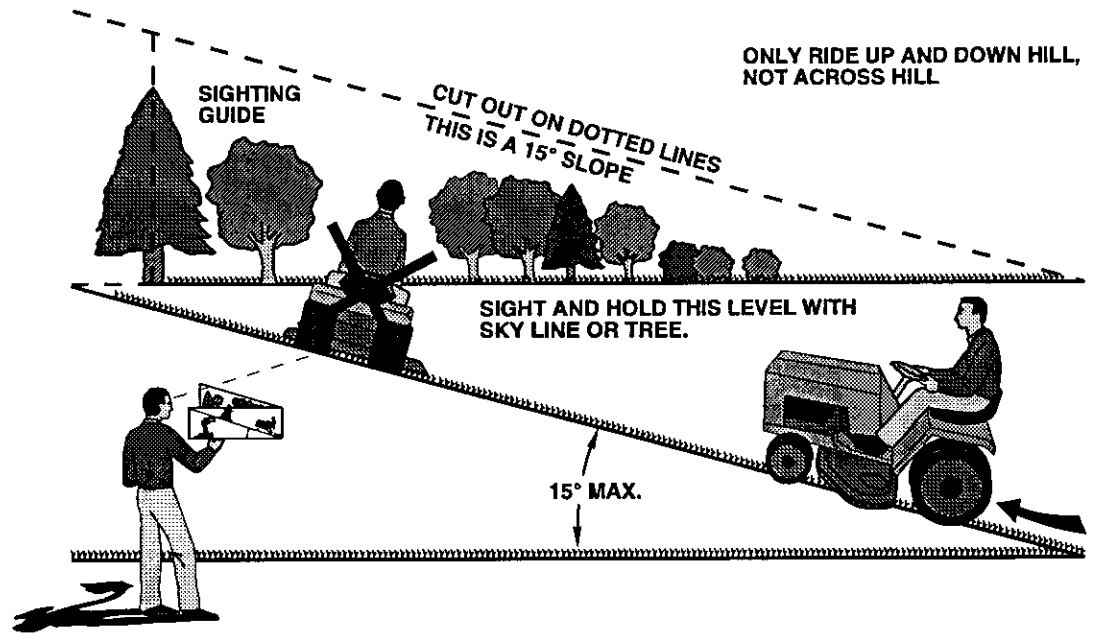

 Operate your Tractor up and down the face of slopes (not greater than 15°), never across the face. Make turns gradually to prevent tipping or loss of control. Exercise extreme caution when changing direction on slopes.

Get it fixed, at your home or ours!

For repair of major brand appliances **in your own home** . . .
no matter who made it, no matter who sold it!

1-800-4-MY-HOME[®] Anytime, day or night
(1-800-469-4663) (U.S.A. and Canada)
www.sears.com www.sears.ca

For repair of carry-in products like vacuums, lawn equipment, and
electronics, call for the nearest **Sears Parts and Repair Center**.

1-800-488-1222 Anytime, day or night (U.S.A. only)
www.sears.com

For the replacement parts, accessories and owner's manuals
that you need to do-it-yourself, call **Sears PartsDirectSM**!

1-800-366-PART 6 a.m. – 11 p.m., 7 days a week
(1-800-366-7278) (U.S.A. only)
www.sears.com/partsdirect

To purchase or inquire about a Sears Service Agreement
or Sears Maintenance Agreement:

1-800-827-6655 (U.S.A.) **1-800-361-6665** (Canada)
7 a.m. – 5 p.m., CST, Mon. – Sat. 9 a.m. – 8 p.m. EST, M – F, 4 p.m. Sat.

Para pedir servicio de reparación a
domicilio, y para ordenar piezas:
1-888-SU-HOGARSM
(1-888-784-6427)

Au Canada pour service en français:
1-800-LE-FOYER^{MC}
(1-800-533-6937)
www.sears.ca



© Sears, Roebuck and Co.

® Registered Trademark / TM Trademark / SM Service Mark of Sears, Roebuck and Co.

® Marca Registrada / TM Marca de Fábrica / SM Marca de Servicio de Sears, Roebuck and Co.

^{MC} Marque de commerce / ^{MC} Marque déposée de Sears, Roebuck and Co.