

Color Television Operating Instructions

Panasonic®

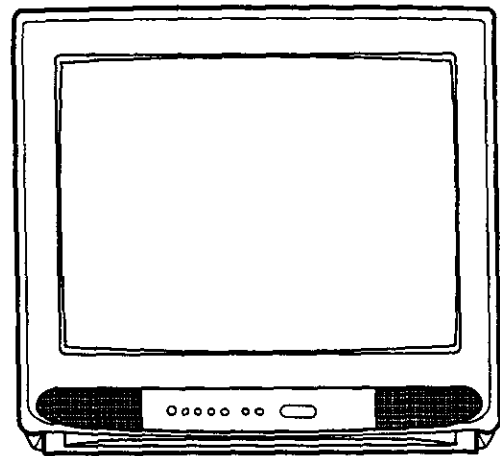

CT-32G11

Read these instructions completely before operating.
Contents subject to change without notice or obligation.

Copyright 1995 by Matsushita Electric Corporation of America.
All rights reserved. Unauthorized copying and distribution is a violation of law.

Printed in USA
TQB2AA0050

Safety Instructions

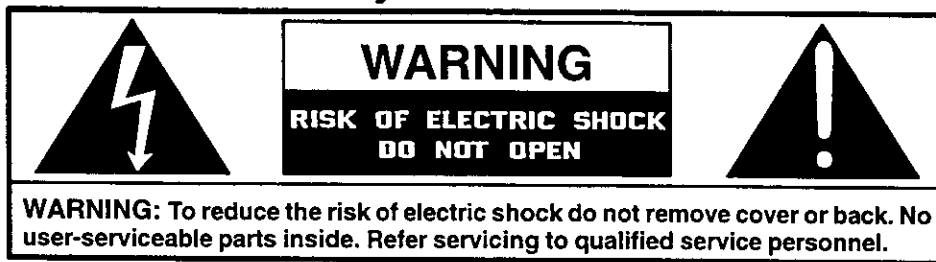

The lightning flash with arrow-head within a triangle is intended to tell the user that parts inside the product are a risk of electric shock to persons.



The exclamation point within a triangle is intended to tell the user that important operating and servicing instructions are in the papers with the appliance.

Note To CATV System Installer: This reminder is provided to call the CATV system installer's attention to Article 820-40 of the NEC that provides guidelines for proper grounding and, in particular, specifies that the cable ground shall be connected to the grounding system of the building, as close to the point of cable entry as practical.

Safety Instructions For Television Receivers

1. Read and apply the operating instructions provided with your television receiver.
2. Read all of the instructions given here and retain them for later use.
3. Unplug this television receiver from the wall outlet before cleaning. Do not use liquid or aerosol cleaners. Use a damp cloth for cleaning.
4. Do not use attachments not recommended by the television receiver manufacturer as they may cause hazards.
5. Do not use this television receiver near water. For example: Avoid placing it near a bathtub, washbowl, kitchen sink, or laundry tub, in a wet basement, or near a swimming pool, etc.
6. Do not place this television receiver on an unstable cart, stand, or table. The television receiver may fall, causing serious injury to a child or adult, and serious damage to the appliance. Use only with a cart or stand recommended by the manufacturer, or sold with the television receiver. Wall or shelf mounting should follow the manufacturer's instructions, and should use a mounting kit approved by the manufacturer.
- 6A. An appliance and cart combination should be moved with care. Quick stops, excessive force, and uneven surfaces may cause the appliance and cart combination to overturn.
7. Slots and openings in the cabinet and the back or bottom are provided for ventilation, and to insure reliable operation of the television receiver and to protect it from overheating. These openings must not be blocked or covered. The openings should never be blocked by placing the television receiver on a bed, sofa, rug or other similar surface. This television receiver should never be placed near or over a radiator or heat register. This television receiver should not be placed in a built-in installation such as a bookcase unless proper ventilation is provided.
8. Operate only from the type of power source indicated on the marking label. If you are not sure of the type of power supplied to your home consult your television dealer or local power company. For television receivers designed to operate from battery power, refer to the operating instructions.
9. This television receiver is equipped with a polarized alternating-current line plug (a plug having one blade wider than the other). This plug will fit into the power outlet only one way. This is a safety feature. If you are unable to insert the plug fully into the outlet, try reversing the plug. If the plug should still fail to fit, contact your electrician to replace your obsolete outlet. Do not defeat the safety purpose of the polarized plug.
10. Do not allow anything to rest on the power cord. Do not locate this television receiver where the cord will be abused by persons walking on it.
11. Follow all warnings and instructions marked on the television receiver.
12. Do not overload wall outlets and extension cords as this can result in fire or electric shock.
13. Never push objects of any kind into this television receiver through cabinet slots as they may touch dangerous voltage points or short out parts that could result in a fire or electric shock. Never spill liquid of any kind on the television receiver.

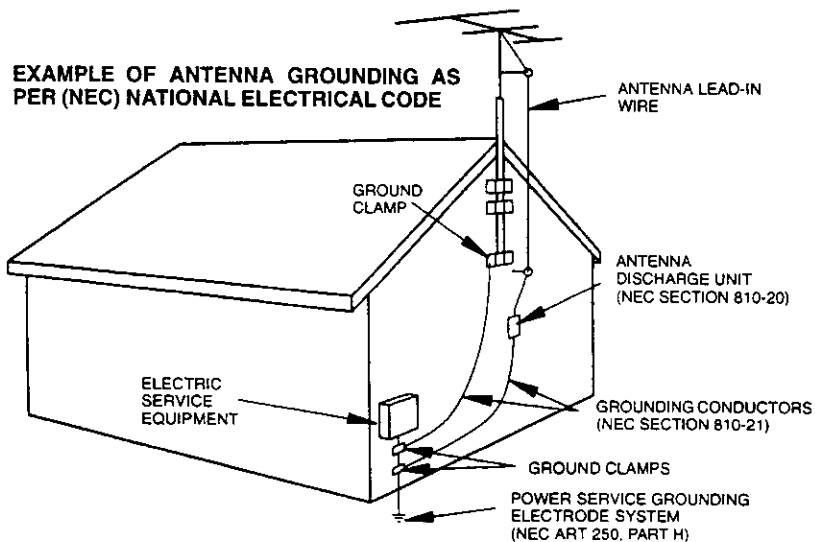

14. If an outside antenna is connected to the television equipment, be sure the antenna system is grounded so as to provide some protection against voltage surges and built up static charges. In the U.S. Section 810 of the National Electrical Code and in Canada Part 1 of the Canadian Electrical Code provides information with respect to proper grounding of the mast and supporting structure, grounding of the lead-in wire to an antenna discharge unit, size of grounding conductors, location of antenna-discharge unit, connection to grounding electrodes, and requirements for the grounding electrode. See Figure.
15. For added protection for this television receiver during a lightning storm, or when it is left unattended and unused for long periods of time, unplug it from the wall outlet and disconnect the antenna. This will prevent damage to the receiver due to lightning and power-line surges.
16. An outside antenna system should not be located in the vicinity of overhead power lines or other electric light or power circuits, or where it can fall into such power lines or circuits. When installing an outside antenna system extreme care should be taken to keep from touching such power lines or circuits as contact with them might be fatal.
17. Unplug this television receiver from the wall outlet, and refer servicing to qualified service personnel under the following conditions:
 - a. When the power cord or plug is damaged or frayed.
 - b. If liquid has been spilled into the television receiver.
 - c. If the television receiver has been exposed to rain or water.
 - d. If the television receiver does not operate normally by following the operating instructions. Adjust only those controls that are covered by the operating instructions as improper adjustment of other controls may result in damage and will often require extensive work by a qualified technician to restore the television receiver to normal operation.
 - e. If the television receiver has been dropped or the cabinet has been damaged.
 - f. When the television receiver exhibits a distinct change in performance – this indicates a need for service.
18. Do not attempt to service this television receiver yourself as opening or removing covers may expose you to dangerous voltage or other hazards. Refer all servicing to qualified service personnel.
19. When replacement parts are required, be sure the service technician has used replacement parts specified by the manufacturer that have the same characteristics as the original part. Unauthorized substitutions may result in fire, electric shock, or other hazards.
20. Upon completion of any service or repairs to this television receiver, ask the service technician to perform routine safety checks to determine that the television is in safe operating condition.
21. **WARNING: To prevent fire or shock hazard, do not expose this appliance to rain or moisture.**
22. **CAUTION: TO PREVENT ELECTRIC SHOCK DO NOT USE THIS (POLARIZED) PLUG WITH A RECEPTACLE OR OTHER OUTLET UNLESS THE BLADES CAN BE FULLY INSERTED TO PREVENT BLADE EXPOSURE.**

NOTE: This equipment is designed to operate in the U.S.A., Canada and other countries where the broadcasting system and AC house current is exactly the same as in the U.S.A. and Canada.

Important Information Regarding Use of Video Games, Computers, Teletext or Other Fixed Image Displays.

The extended use of fixed image program material can cause a permanent "shadow image" on the picture tube. This background image is viewable on normal programs in the form of a stationary fixed image. This type of irreversible picture tube deterioration can be limited by observing the following steps:

- A. Reduce the brightness/contrast setting to a minimum viewing level.
- B. Do not display the fixed image for extended periods of time.
- C. Turn the power off when not in actual use.

NOTE: The marking or retained image on the picture tube resulting from fixed image use is not an operating defect and as such is not covered by Warranty. This product is not designed to display fixed image patterns for extended periods of time.

Specifications

Power Source: 120V, 60Hz, AC
Channel Capability: 181 channels (See chart)
 VHF 2~13, UHF 14~69, Cable 125 channels
Video Input Jack: 1V p-p, 75 ohm, phono jack type
Audio Input Jacks: 47K ohm, 500mV rms
To Audio AMP Jacks: 0~2.0V rms 4.7K ohm
Stereo Sound
Closed Caption Display

Specifications are subject to change without notice or obligation.

Channel Capability Chart

BAND	USA/CAN
VHF	12
UHF	56
CABLE (Mid-Band)	15
CABLE (Super Band)	14
CABLE (Hyper Band)	28
CABLE (Ultra Band)	56
TOTAL CHANNELS	181

Introduction

Congratulations on Your New Purchase

Your new video component features an all solid state chassis which is designed to give you many years of enjoyment. It was thoroughly tested and adjusted at the factory for best performance.

In order for you to take full advantage of your new video component, please read and follow the installation and operating instructions supplied with this product.

Customer's Record

The model and serial number of this product may be found on its back cover. You should note the model and serial number in the space provided and retain this book as a permanent record of your purchase to aid in identification in the event of theft or loss.

Model Number: _____ Serial Number: _____

Table of Contents

Safety Instructions	2	Picture Adjustments	13
Specifications	3	Picture Norm	13
Introduction	4	Color, Tint, Brightness, Picture and Sharpness ..	13
Installation	5	Audio Adjustment	14
Receiver Location	5	Audio Norm	14
Optional External Equipment Connections	5	Bass, Treble, and Balance	14
AC Power Supply Cord	5	Mode (Stereo/SAP/Mono)	15
Battery Installation	5	AI Sound	15
Antenna/Cable Connections	6	TV Speakers	16
Other Video Equipment	6	Lock	17
Optional Equipment Connection and Operation ..	7	Lock (Game Guard)	17
Stereo Connection (To Audio AMP)	7	Unlock (Game Guard)	17
Video/Audio Connection	7	Channel Caption (Station Identifier)	18
Location of Controls (Remote and Receiver)	8	Timer Features	19
Quick Reference Control Operation	8	Sleep Timer	19
Remote Quick Reference Functional Key Chart ..	9	Program Timer	19
Control Operation	10	Set-Up Features	20
Power Button	10	Set Time (Clock)	20
Volume (Vol) Buttons	10	Ant (Antenna)	20
Mute Button	10	Auto Prog (Program)	21
R-Tune (Rapid Tune) Button	10	Manual Prog (Program)	21
Channel Change (UP/DOWN)	10	<input type="checkbox"/> On Mute	22
Numeric Keypad (0 through 9 Buttons)	10	<input type="checkbox"/> Mode	22
VCR Function Buttons	10	Trilingual Menu System	23
TV/Video Button	11	Care and Cleaning	24
Recall Button	11	Programming The Universal Remote Control	25
Cable Power Button	11	VCR and Cable Converter Box Infrared Codes ...	26
Multi Button	11	Troubleshooting Chart	27
Main Menu Icons Selection	12	Power Loss	27
Trilingual Menu Selection (English/Spanish/French)	12		

Installation

Receiver Location

This unit is intended to be used with an optional stand or entertainment center. Consult your dealer for available options. Locate for comfortable viewing. Avoid placing where sunlight or other bright light (including reflections) will fall on the screen.

Use of some types of fluorescent lighting may reduce remote control transmitter range.

Adequate ventilation is essential to prevent internal component failure. Keep away from areas of excessive heat or moisture.

To insure optimum color purity, do not position magnetic equipment (motors, fans, other speakers, etc.) nearby.

Optional External Equipment Connections

The Video/Audio connections between components can be made with shielded video and audio cables. For best performance, video cables should utilize 75 ohm coaxial shielded wire. Cables are available from your dealer or electronic supply house.

Before you purchase any cables, be sure you know what type of output and input connectors your various components require. Also determine the length of cable you'll need.

AC Power Supply Cord

CAUTION: To prevent electric shock, match wide blade of plug to wide slot of AC outlet and fully insert. DO NOT USE this (polarized) plug with a receptacle or other outlet unless the blade can be fully inserted to prevent blade exposure.

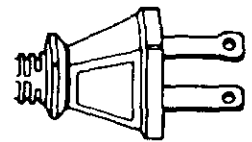

Polarized Plug

Remote Control Battery Installation

Batteries: Use two "AA" batteries.

1. Turn the Transmitter face down. To remove top cover, press down on marking and slide cover off in the direction indicated.
2. Install the batteries as shown in the battery compartment. (Polarity (+) or (-) must be correct.)
3. Replace the cover and slide in reverse until the lock snaps.
4. For heavy Remote Control use, replace old batteries with Alkaline batteries for longer life.

NOTE: Incorrect installation can cause battery leakage and corrosion that will damage the Remote Control Transmitter.

Observe the Following Precautions:

1. Batteries must be replaced as a pair.
2. Do not combine a used battery with a new one.
3. Do not mix battery types (Example: Zinc Carbon with Alkaline).
4. Do not attempt to charge, short-circuit, disassemble, heat or burn used batteries.
5. Battery replacement is necessary when Remote Control reacts sporadically or stops operating the Receiver.

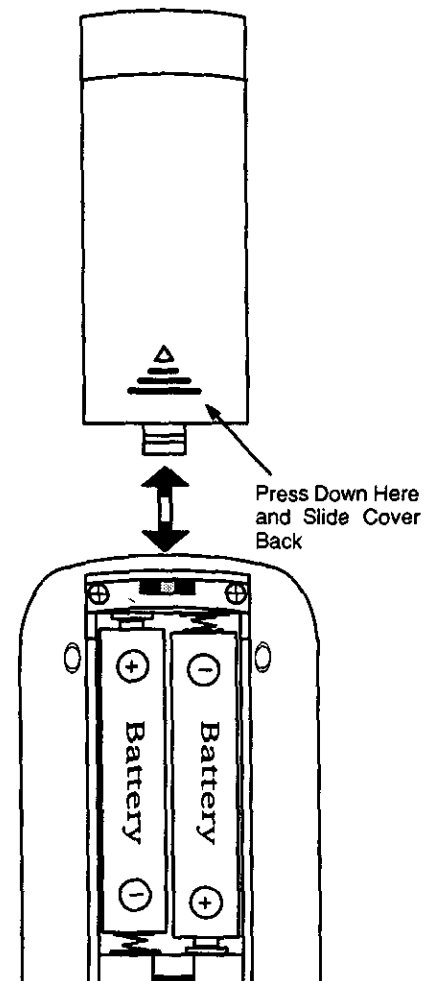

Installation (cont.)

Antenna/Cable Connections

Antenna Connection – For proper reception of VHF/UHF channels an external antenna is required. For best reception an outdoor antenna is recommended. Antenna Mode must be set to TV. (Refer to Antenna Mode section.)

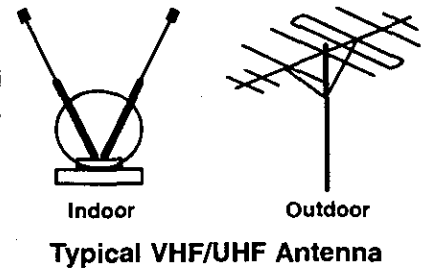

Incoming Cable From Home Antenna (75 Ohm)

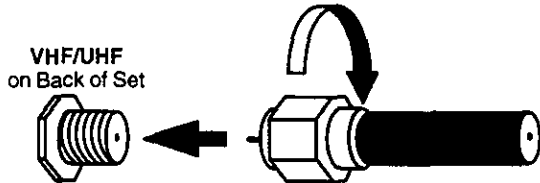

Incoming Cable From Home Antenna (300 Ohm)

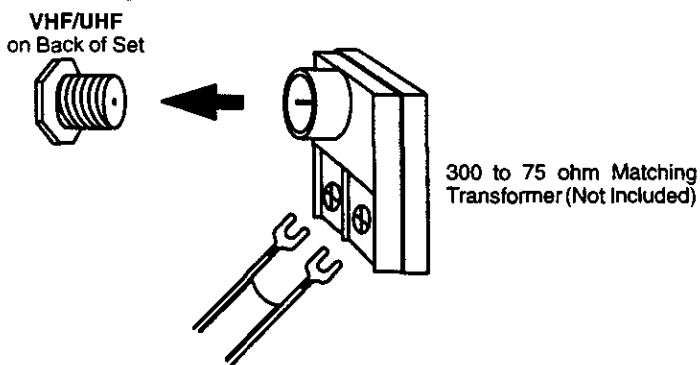

Cable Connection – For reception of cable channels, connect the cable supplied by your local cable company. Antenna Mode must be set to CABLE. (Refer to Antenna Mode section.)

Incoming 75 Ohm Cable (from Cable Company)

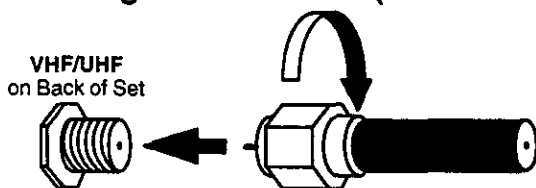

NOTE: Certain cable systems offset some channels to reduce interference or have Premium (scrambled) channels. A cable converter box is required for proper reception. Check with your local Cable company for compatibility requirements.

Other Video Equipment

VCRs, Video Disc Players, Computers, TV games, and Teletext equipment can also be connected to the antenna input connection.

Optional Equipment Connection and Operation

To Audio AMP Connection (Stereo)

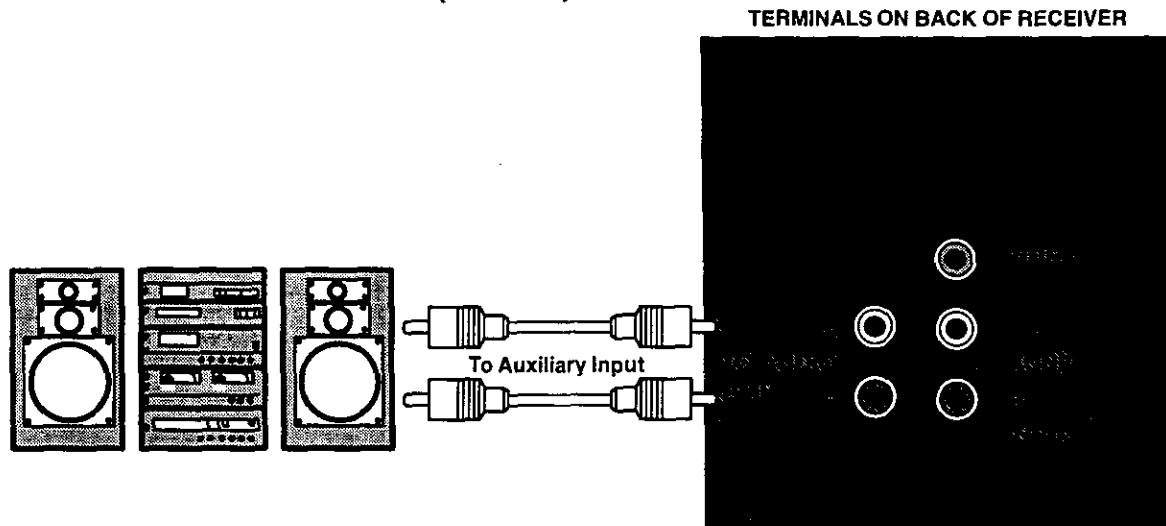

• To Audio AMP

Connect to an external audio amp auxiliary input for monitoring sound through a stereo system.

NOTE: TO AUDIO AMP terminals cannot be used for external speakers.

Adjustment – When an audio amp is connected to “TO AUDIO AMP” terminals:

1. Select TV SPEAKERS “ON” Mode. (Refer to the Audio Menu TV Speakers section.)
2. Set volume of audio amp to near minimum.
3. Adjust volume of TV to desired listening level.
4. Adjust volume of audio amp to match the level of TV.
5. Select TV SPEAKERS OFF&VAO (Variable Audio Output) Mode. (Refer to the Audio Menu TV Speakers section.)
6. Audio bass, treble, balance, volume, and mute can now be controlled by the TV Remote Control. When OFF&FAO (Fix Audio Output) mode is selected in the Audio Menu, the external amplifier speakers are controlled by the Audio Amplifier.

Video/Audio Connection

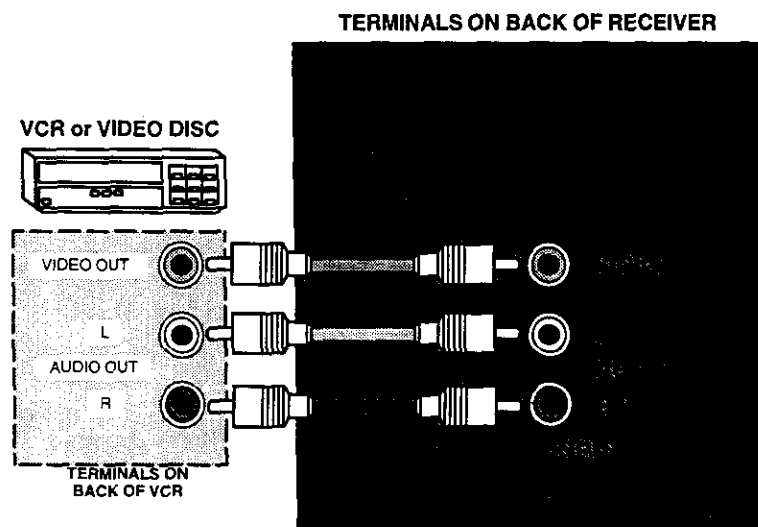

Operation

1. Connect optional equipment as shown to INPUT.
2. Select the Video mode by pressing the TV/VIDEO button.
3. Operate optional equipment (VCR-VDP) as instructed in Optional Equipment manual.

Location of Controls (Remote & Receiver)

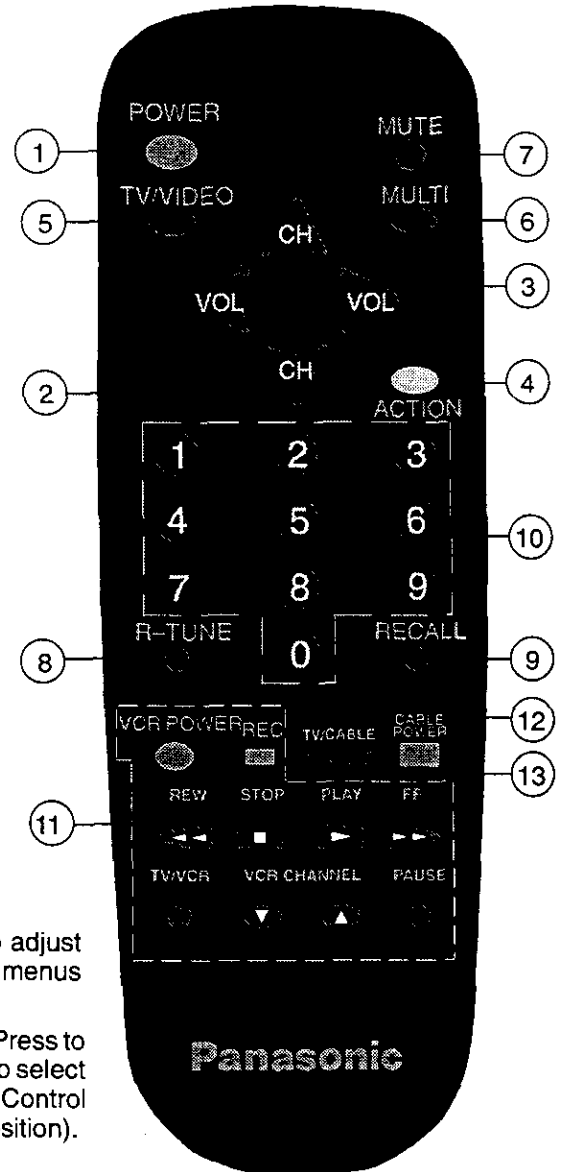
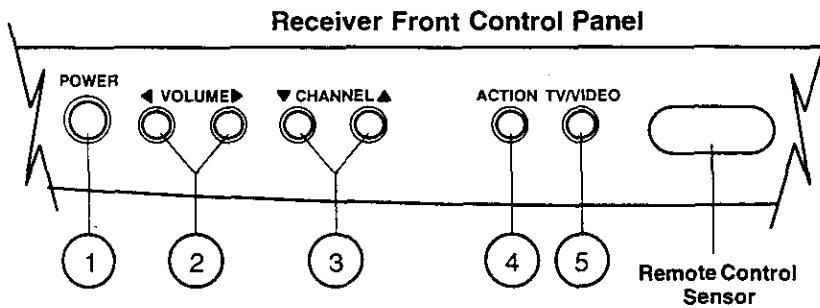

Quick Reference Control Operation

- ① **Power Button** – Press to turn ON or OFF.
- ② **Vol (Volume) Buttons** – Press to adjust Sound Level. Press to adjust Audio Menus, Video Menus and select operating features when menus are displayed.
- ③ **Ch (Channel) Buttons** – Press to select programmed channels. Press to highlight desired features when menus are displayed. Also used to select Cable Converter box channels after programming Remote Control Infrared codes (the TV/CABLE switch must be set in CABLE position).
- ④ **Action Button** – Press to display Main Menu and access On Screen feature and Adjustment Menus.
- ⑤ **TV/Video Button** – Press to select TV or Video Input.
- ⑥ **Multi Button** – Programmable to operate up to six Remote Function buttons.
- ⑦ **Mute Button** – Press to mute sound. A second press returns sound.
- ⑧ **R-Tune (Rapid Tune) Button** – Press to switch between two channels.
- ⑨ **Recall Button** – Press to display Time, status of Sleep Timer, Channel, Video Mode, Channel Caption and Audio Mode.
- ⑩ **Keyboard "0 through 9" Buttons** – Press desired channel number to access any channel.
- ⑪ **VCR Function Buttons** – Programmable to operate many brands of VCRs, TV/CABLE switch must be in TV position.
- ⑫ **Cable Power Button** – Programmable to operate selected CATV converter boxes.
- ⑬ **TV/Cable Switch** – This switch is used to select the proper mode when programming Remote Control Infrared codes or operating the TV or external equipment (VCR or Cable Converter box).

Remote Control

Quick Reference Functional Key Chart

KEY	OPERATES	FUNCTION	
POWER 	TV	Turns TV On and Off	
MUTE 	TV	Mutes TV Audio	
TV/VIDEO 	TV	Selects the TV Input Mode	
MULTI 	ALL COMPONENTS	Programmable Button that can operate up to six (6) Remote Functions at once	
ACTION 	TV	Activates TV Menus	
	TV CABLE TV CABLE	 	Channel Up/Down, Menu Navigation Channel Up/Down Volume Up/Down, Menu Navigation Search for Infrared Code when Programming Remote
	TV VCR CABLE	Selects Channel Selects Code in Game Guard Menu Selects Channel in Channel Caption Menu Selects Channel in Timer Menu Selects Infrared Code when Programming Remote Selects Infrared Code when Programming Remote	
R-TUNE 	TV	Switches Between Two (2) Channels	
RECALL 	TV	Displays Channel, Time, and Audio Mode	
TV/CABLE 	TV CABLE	TV Mode Selection for Remote Control Also VCR Mode Selection for Remote Control CATV Mode Selection for Remote Control	
CABLE POWER 	CABLE	Turns Cable On and Off	
VCR POWER 	VCR	Turns VCR On and Off	
	VCR	Standard VCR Control Keys Record Rewind Stop Play Fast Forward Selects TV/VCR Mode VCR Channel Up/Down Pause	

Control Operation

Power Button — Press the POWER button to turn ON. Press again to turn OFF.



Volume Button — Press the VOLUME (VOL) LEFT/RIGHT button for desired listening level (when On-Screen menus are not displayed).

Located On Remote Control

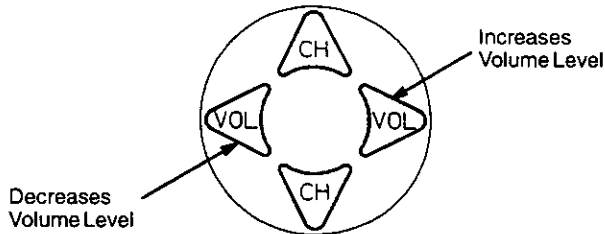

Mute Button — Press the MUTE button to quickly reduce sound level (Mute will appear on screen). Press again to restore sound.



R-Tune Button — Pressing the R-TUNE (RAPID TUNE) button will switch between the last two channels selected on the numeric keypad.

NOTE: When rapidly scanning channels with the CHANNEL UP/DOWN button, pressing the R-TUNE button will switch between the last channel scanned, and initial channel at the start of scanning.

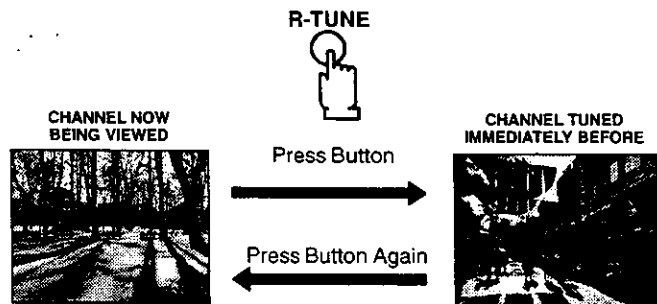

Helpful Hints:

- Helpful information will display On Screen momentarily when Receiver is first turned on and when the channel is changed.
- When using keyboard entry for channels 10, 11, and 12 in the CABLE mode, there is a slight delay before channel change because of the capability of tuning cable channels 100 to 125.

Channel Change (UP/DOWN)

Press the CHANNEL (CH) UP/DOWN button to sequentially scan through programmed channels (when On-Screen menus are not displayed).

NOTE: TV/CABLE switch (located on Remote) must be set in TV position.

Located on Remote Control 

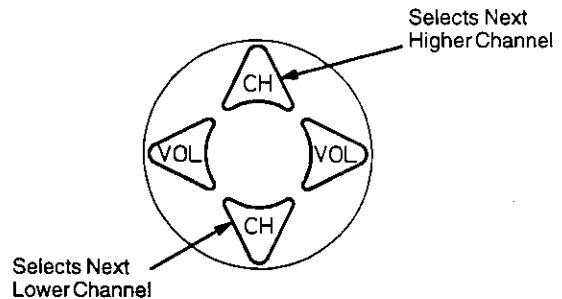

Numeric Keypad (0 through 9 Buttons)

Press two digits on the numeric keypad 0 through 9 buttons (Example press 0, then 5 for channel 05). For channels over 99, press three digits on keyboard.

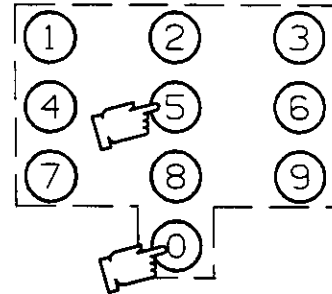

VCR Function Buttons — The VCR FUNCTION buttons have been designed to operate numerous brands of VCRs. The infrared code must be obtained prior to use. (Please refer to Programming the Universal Remote for programming instructions.)

NOTE: The TV/CABLE switch (located on Remote) must be in the TV position.

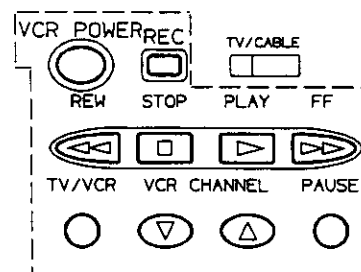

Control Operation (cont.)

TV/Video Button – Press the TV/VIDEO button to select desired input.



Signal coming from:

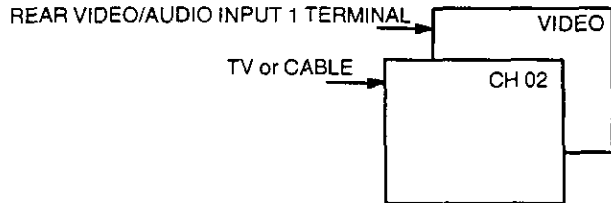

Recall Button – Press the RECALL button to review:

- ① Audio Mode status
- ② CH number or Video Input selected
- ③ Sleep Timer status
- ④ Clock time
- ⑤ Channel Caption (Station Identifier)

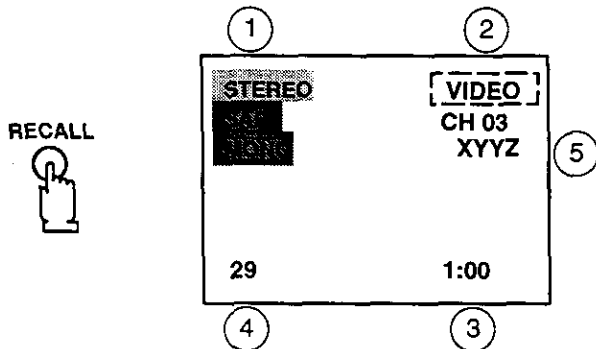

Cable Power Button – The CABLE POWER button on the Remote Control has been designed to operate selected brands of Cable Television Converter boxes. The proper cable television converter box infrared code must be obtained prior to use. (Please refer to Programming the Universal Remote for programming instructions.) The Remote Control TV/CABLE switch should be in the CABLE position.

NOTE: The CHANNEL UP/DOWN buttons on the Remote may be used for selecting Cable Converter box channels.



Located On Remote Control

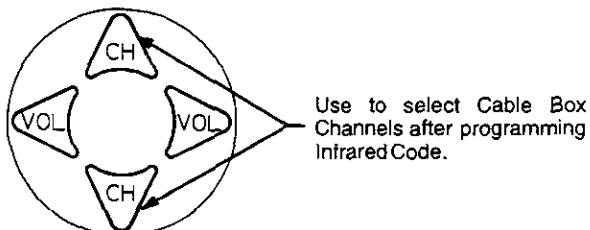

Multi Button

The **MULTI** button can be programmed to operate up to six (6) Remote function buttons at the same time. For Example: TV Power/On, VCR Power/On (selected brands) can be operated at the same time with one press of the MULTI button.

Procedure

1. First program the Remote for the selected VCR Infrared access code. Confirm that the Remote Control is compatible with the equipment.
2. Face the Remote Control transmitter away from all equipment remote sensors.
3. Press and hold down the Remote TV Power button, then press and hold down the MULTI button at the same time. Release buttons (All previous commands will be erased.)

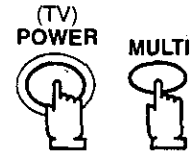

PRESS SIMULTANEOUSLY

4. Press a maximum of six (6) function buttons on the Remote. Each button you press is equal to one function. If six (6) Remote button functions are entered, all will register in the MULTI button memory in the sequence entered. When less than six Remote button functions are entered, press the MULTI button to end the program mode. (Waiting more than 30 seconds without pressing another button will also end the program mode.)

The following is an example of Remote functions that can be programmed into the MULTI button.

- TV Power – For turning TV ON and OFF.
- VCR Power – For turning VCR ON and OFF (selected brands after programming its Infrared access code, if necessary). Both can be turned ON or OFF with one press of the MULTI button.

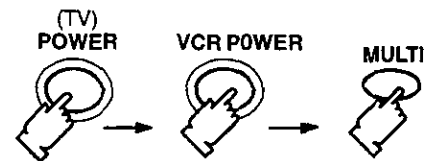

To delete entered functions – Repeat step 3. Now you can enter from one to six different Remote functions.

NOTE: You can also program the MULTI button to perform most individual Remote Control button functions. Buttons which continuously perform a function as long as pressed (Volume Up/Down, Channel Up/Down, etc.) cannot be programmed. Only those buttons which perform a function when initially pressed (Power On/Off, Mute, Direct Channel Entry, etc.) can be programmed.

Main Menu Icons Selection

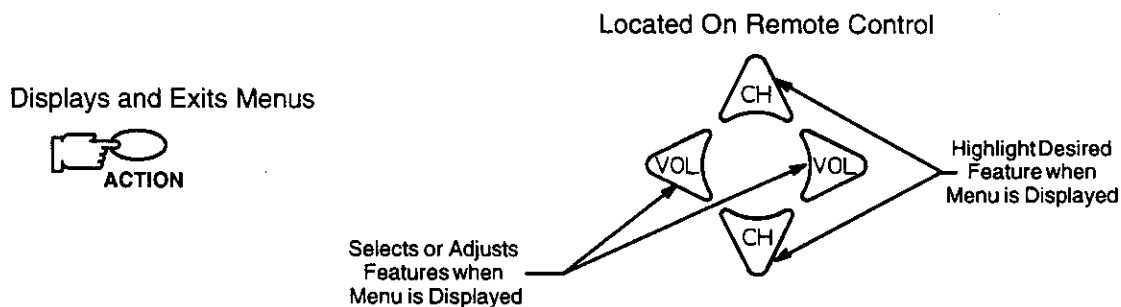
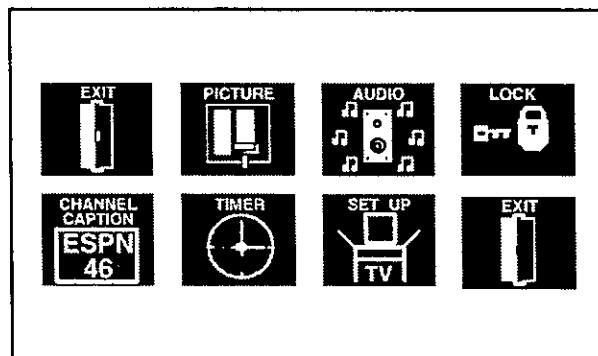

1. Press the ACTION button to display the Main Menu with Icons.
2. Press the CH UP/DOWN and the VOL LEFT/RIGHT buttons to select the desired Icon when the Main Menu is displayed (selected Icon will be indicated in Red). (Press the VOL buttons for left and right movement and the CH buttons for up or down movement.)
3. Press the ACTION button after selecting the desired Icon.
4. To exit the Main Menu first select the EXIT Icon, then press the ACTION button.

Trilingual Menu Selection

The Language Menu is factory set to ENGLISH. Follow these instructions to change the Language Menu to Spanish, French, and back to English.

1. Press the ACTION button to display the Main Menu.
2. Press the CH UP/DOWN and VOL LEFT/RIGHT buttons to highlight the Set Up Icon.
3. Press the ACTION button to display the Set-Up Menu.

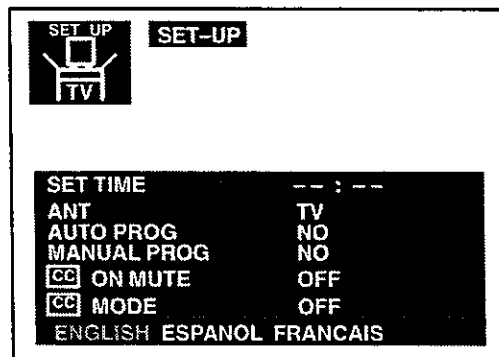

4. Press the CH UP/DOWN button to highlight ENGLISH ESPANOL FRANCAIS.
5. Press the VOL LEFT/RIGHT button to select "ENGLISH", "ESPANOL", or "FRANCAIS".
6. Press the ACTION button twice to exit the SET-UP Menu.

Picture Adjustments

- Picture Norm
- Color
- Tint
- Brightness
- Picture
- Sharpness

Located On Remote Control

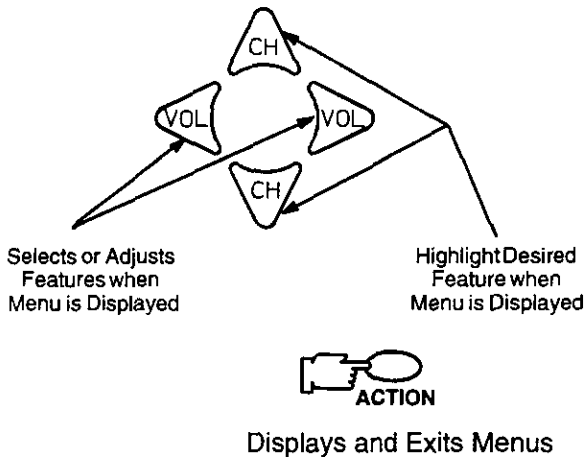

Picture Norm – This feature is used to reset Color, Tint, Brightness, Picture and Sharpness adjustments back to a factory preset level.

1. Press the ACTION button to display the Main Menu.
2. Press the CH UP/DOWN and VOL LEFT/RIGHT buttons to highlight the Picture Icon.
3. Press the ACTION button to display the Picture Adjustment Menu.

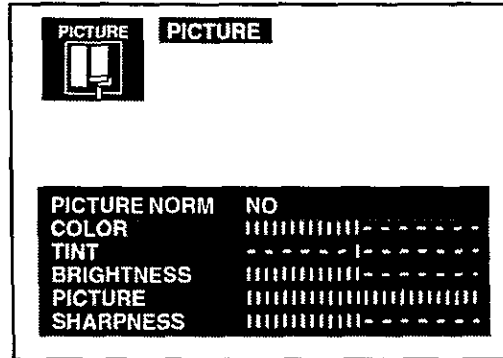

4. Press the CH UP/DOWN button to highlight PICTURE NORM (if necessary).
5. Press the VOL LEFT/RIGHT button to select SET to Normalize Color, Tint, Brightness, Picture and Sharpness.
6. Press the ACTION button twice to exit Menus.

Color, Tint, Brightness, Picture and Sharpness Adjustments

1. Press the ACTION button to display the Main Menu.
2. Press the CH UP/DOWN and VOL LEFT/RIGHT buttons to highlight the Picture Icon.
3. Press the ACTION button to display the Picture Adjustment Menu.

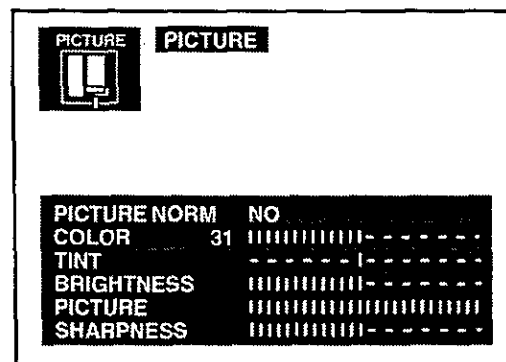

4. Press the CH UP/DOWN button to highlight the desired Picture Adjustment (Color, Tint, Brightness, Picture or Sharpness).
5. Press the VOL LEFT/RIGHT button to adjust your selection. (The selected Picture Adjustment will be displayed).
6. Repeat steps 4 and 5 for the remaining Picture Adjustments.
7. Press the ACTION button twice to exit Menus.

Helpful Hints:

Picture Adjustments:

COLOR – adjust for desired color intensity.

TINT – adjust for natural flesh tones.

BRIGHTNESS – adjust so dark areas of picture slightly become black for a crisp detail.

PICTURE – adjust the white areas of the picture as desired.

SHARPNESS – adjust for best clarity of outline detail.

Audio Adjustment

- Audio Norm
- Bass
- Treble
- Balance
- Mode
- AI Sound
- TV Speakers

Located On Remote Control

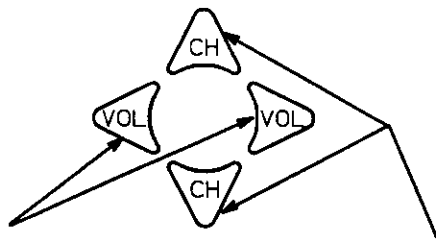

Selects or Adjusts Features when Menu is Displayed

Highlight Desired Feature when Menu is Displayed



Displays and Exits Menus

Audio Norm – This feature is used to reset BASS, TREBLE, and BALANCE back to a factory preset level.

1. Press the ACTION button to display the Main Menu.
2. Press the CH UP/DOWN and VOL LEFT/RIGHT buttons to select the Audio Icon.
3. Press the ACTION button to display the Audio Adjustment Menu.

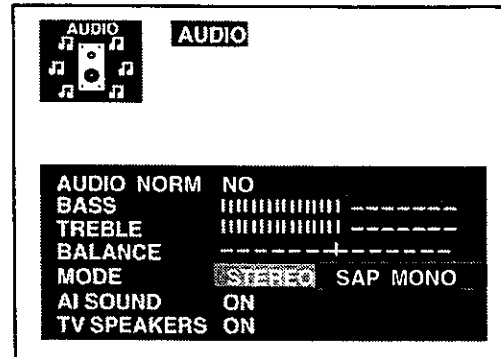

4. Press the CH UP/DOWN button to highlight AUDIO NORM.
5. Press the VOL LEFT/RIGHT button to select "YES" to Normalize Bass, Treble, and Balance.
6. Press the ACTION button twice to exit Menus.

Bass, Treble, and Balance Adjustment

1. Press the ACTION button to display the Main Menu.
2. Press the CH UP/DOWN and VOL LEFT/RIGHT buttons to select the Audio Icon.
3. Press the ACTION button to display the Audio Adjustment Menu.

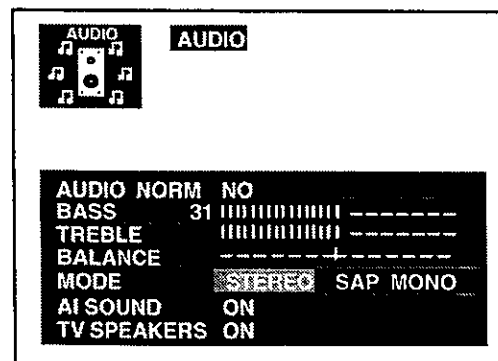

4. Press the CH UP/DOWN button to highlight BASS, TREBLE, or BALANCE.
5. Press the VOL LEFT/RIGHT button to adjust for desired audio response.
6. Repeat steps 4 and 5 for remaining Audio functions.
7. Press the ACTION button twice to exit Menus.

Helpful Hints:

BASS – To increase or decrease the Bass response.
TREBLE – To increase or decrease the Treble response.
BALANCE – To emphasize the Right and Left Speaker's volume.

NOTE: When TV SPEAKERS is in the OFF&FAO mode, the BASS, TREBLE, and BALANCE adjustments will indicate FIXED.

Audio Adjustment (cont.)

Located On Remote Control

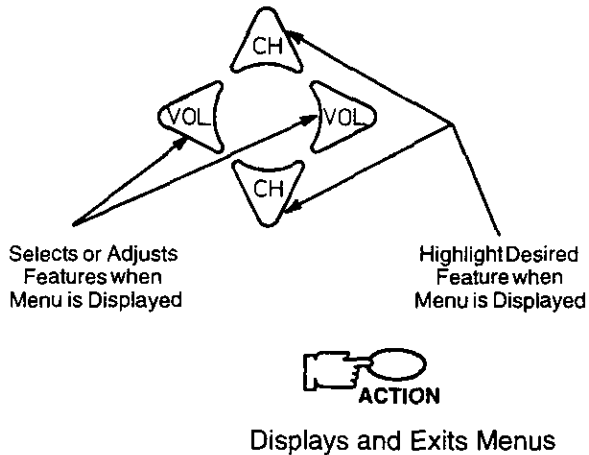

Mode (Stereo/SAP/Mono)

When Audio is broadcast in Stereo or SAP an On-Screen display will appear on initial Turn On and Channel Change. The available choices will be indicated in red.

1. Press the ACTION button to display the Main Menu.
2. Press the CH UP/DOWN and VOL LEFT/RIGHT buttons to highlight the Audio Icon.
3. Press the ACTION button to select and display the Audio Adjustment Menu.

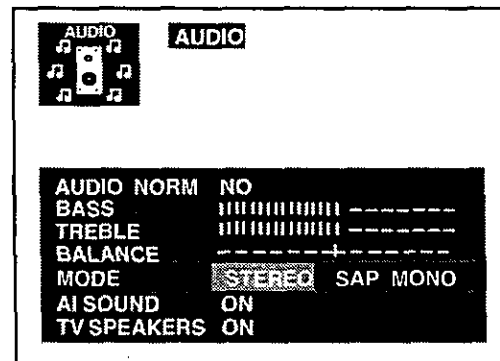

4. Press the CH UP/DOWN button to highlight MODE.
5. Press the VOL LEFT/RIGHT button to highlight Stereo, SAP (Second Audio Programming), or Mono.
6. Press the ACTION button twice to exit Menus.

AI Sound – This feature regulates the volume between programs and commercial audio to maintain a constant sound output level.

1. Press the ACTION button to display the Main Menu.
2. Press the CH UP/DOWN and VOL LEFT/RIGHT buttons to highlight the Audio Icon.
3. Press the ACTION button to display the Audio Adjustment Menu.

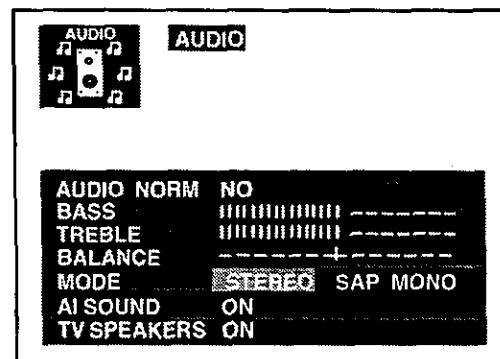

Helpful Hints:

STEREO – Two channel Audio reception.
 SAP – Second Audio Programming (typically used for bilingual audio).
 MONO – Use when stereo signal is weak.

4. Press the CH UP/DOWN button to highlight AI SOUND.
5. Press the VOL LEFT/RIGHT button to select AI SOUND ON or OFF.
6. Press the ACTION button twice to exit the Audio Adjustment Menu.

Audio Adjustment (cont.)

Located On Remote Control

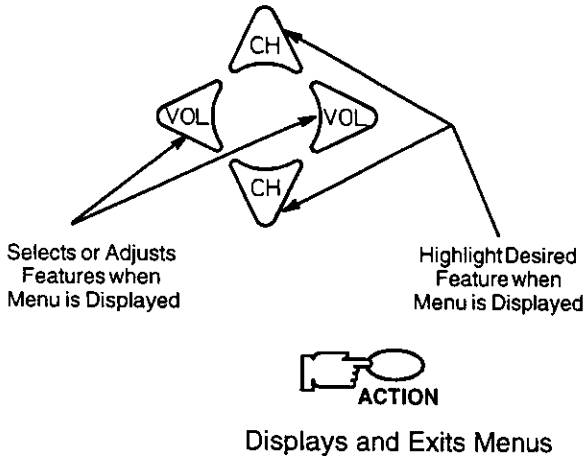

TV Speakers – This feature is used to turn the internal speakers ON or OFF. It is used when the Receiver is connected to an External Audio Amplifier. (Refer to “To Audio Amp Connection” section for further information.)

1. Press the ACTION button to display the Main Menu.
2. Press the CH UP/DOWN and VOL LEFT/RIGHT buttons to select the Audio Icon.
3. Press the ACTION button to display the Audio Adjustment Menu.

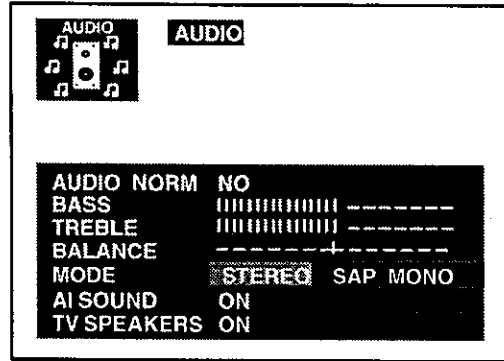

4. Press the CH UP/DOWN button to highlight TV SPEAKERS.
5. Press the VOL LEFT/RIGHT button to select ON, OFF&VAO, or OFF&FAO.
 - ON – TV SPEAKERS operate normally.
 - OFF&VAO (Variable Audio Output) – TV SPEAKERS off, the sound output varies according to the TV volume. Use the TV remote to control the volume, muting, bass, treble, and balance of the External Amplifier System.
 - OFF&FAO (Fixed Audio Output) – TV SPEAKERS off, sound output is not adjustable. The audio is controlled by the External Amplifier System volume control.
6. Press the ACTION button twice to exit the Menus.

Lock

Located On Remote Control

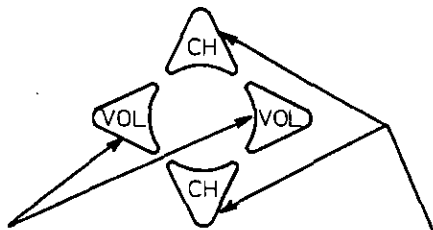

Selects or Adjusts Features when Menu is Displayed

Highlight Desired Feature when Menu is Displayed



Displays and Exits Menus

Lock (Game Guard) – Prevents video games and other video sources from being viewed. Channel 3, 4, and video inputs are locked out for 12, 24, or 48 hours.

NOTE: Be sure to understand this feature before attempting its use. **Use a code that you will remember or write down the code for reference.**

1. Press the ACTION button to display the Main Menu.
2. Press the CH UP/DOWN and VOL LEFT/RIGHT buttons to highlight the Lock icon.
3. Press the ACTION button to display the Lock (Game Guard) Menu.

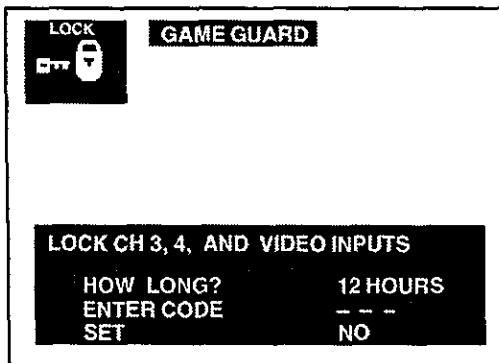

4. HOW LONG should already be highlighted. Press the VOL RIGHT button to select the desired amount of time (12, 24, or 48 hours) for Game Guard (Lock-out) to be activated.
5. Press the CH DOWN button to highlight "ENTER CODE". Then enter a 3-digit code with the Remote Control Keyboard. "SET" should be highlighted after entering the last digit.
IMPORTANT NOTE: Use a code that you will remember or write down the code for reference.
6. Press the VOL LEFT/RIGHT button after entering 3-digit code. "Game Guard Locked" will display On Screen.

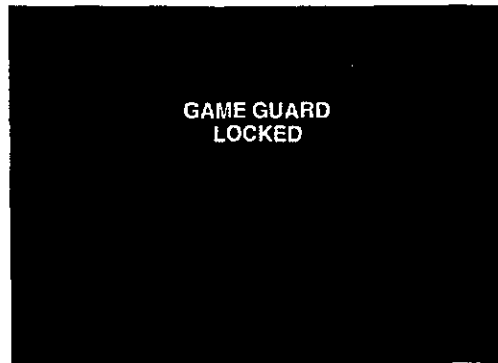

Game Guard Activated

Unlock (Game Guard)

To unlock the Game Guard feature, repeat steps 1 through 3. Enter the same 3-digit code previously used in step 5 with Remote Control Keyboard.

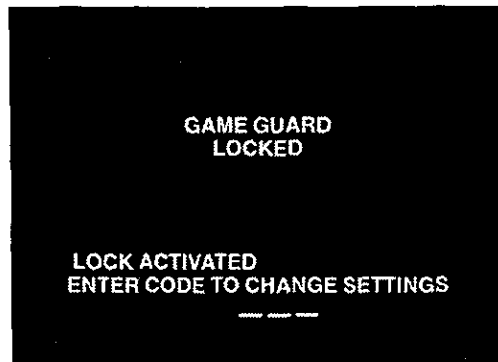

Enter Same 3-Digit Code Previously Used

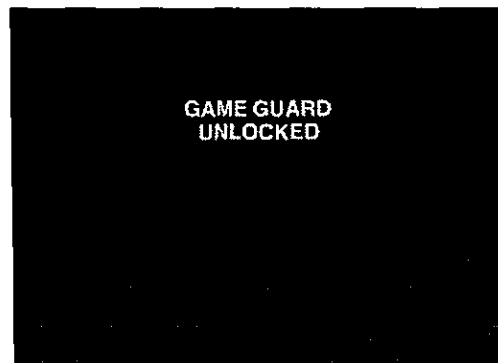

If 3-Digit Code is the Same

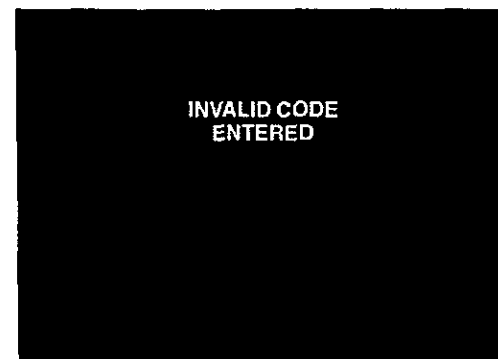

If 3-Digit Code is not the Same

Channel Caption

Located On Remote Control

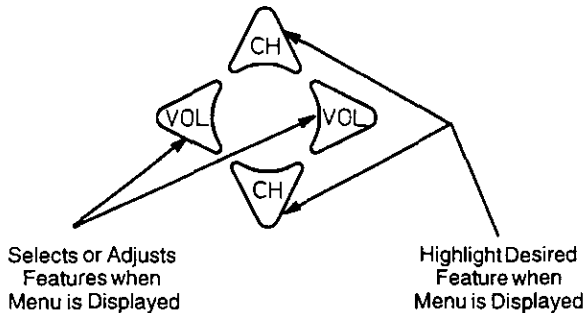

Displays and Exits Menus

Channel Caption (Station Identifier)

This feature allows you to enter the call names of up to 30 stations into memory (using up to four (4) characters for each station). The call name will then display along with the channel number when changing channels or pressing RECALL.

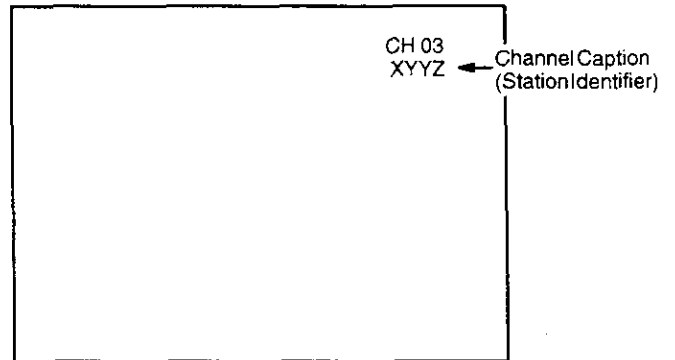

1. Press the ACTION button to display the Main Menu.
2. Press the CH UP/DOWN and VOL LEFT/RIGHT buttons to highlight the Channel Caption Icon.
3. Press the ACTION button to select and display the Channel Caption Menu.

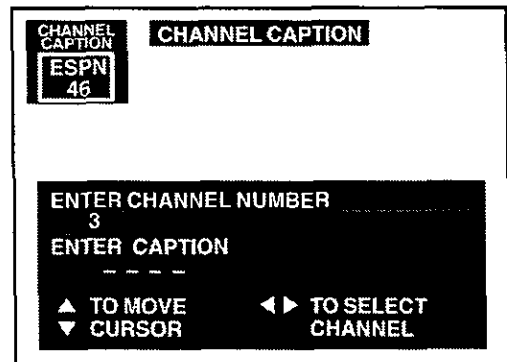

4. Press the VOL LEFT/RIGHT button, or use the numeric keypad (0 through 9 buttons), to enter the channel number you wish to assign a Station Identifier.
5. Press the CH DOWN button to highlight ENTER CAPTION.
6. Press the VOL LEFT/RIGHT button to select first character in Station Identifier. Then press the CH DOWN button to move cursor to the second position and repeat until the complete Station Identifier is entered (up to four (4) characters).
7. Press the CH UP/DOWN button to highlight ENTER CHANNEL NUMBER. Then repeat steps 4 through 6 to continue adding Channel Station Identifier(s).
8. Press the ACTION button twice to exit Menus.

Note: To delete a Channel Caption (Station Identifier) from memory, all four character positions in the ENTER CAPTION area must display a dash mark (-).

Helpful Hints:

When the maximum number of station identifiers are entered, FULL will be displayed in the caption position.

Timer Features

Special Feature:

Automatic OFF after 90 minutes.

The TV has a special feature that will shut itself **OFF** after 90 minutes when turned **ON** by the program timer unless a function key is pressed during the 90 minutes.

This feature is useful so that the TV will not remain **ON** unattended for an extended period of time.

Programming the **OFF** timer will also cancel the automatic **OFF** feature.

Sleep Timer – This feature is used for automatic turn off in 30, 60, or 90 minutes.

NOTE: Display will flash 3, 2, and 1 to indicate the last three remaining minutes prior to turn off. The Recall display will also appear.

1. Press the ACTION button to display the Main Menu.
2. Press the CH UP/DOWN and VOL LEFT/RIGHT buttons to highlight the Timer Icon.
3. Press the ACTION button to display the Timer Control Menu. SLEEP TIMER position should already be highlighted. If not, press CH UP/DOWN to highlight SLEEP TIMER.

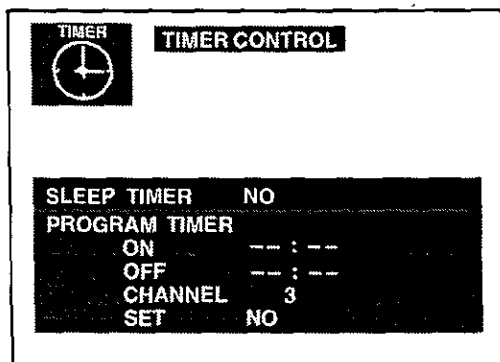

4. Press the VOL RIGHT button to select 30, 60, or 90 minutes (Sleep Timer will be activated).
5. Press the ACTION button twice to exit Menus.

NOTE: To deactivate Sleep Timer repeat steps 1 through 4. In step 4 select "NO" instead of minutes.

Helpful Hints:

Press the RECALL button to display the remaining minutes for Sleep Timer; the time will display in the bottom left corner.

Program Timer – This feature is capable of turning the TV on, tuned to a desired channel, and off at a predetermined time (one day or daily).

NOTE: The clock must be set for this feature to operate. (Refer to the Set-Up Menu to set time.)

1. Press the ACTION button to display the Main Menu.
2. Press the CH UP/DOWN and VOL LEFT/RIGHT buttons to highlight the Timer Icon.
3. Press the ACTION button to display the Timer Control Menu.

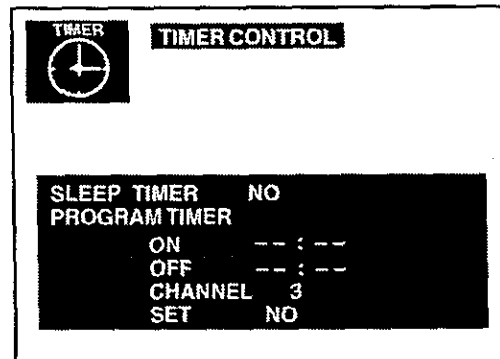

4. Press the CH DOWN button to highlight ON (time).
5. Press the VOL LEFT/RIGHT button repeatedly to set hours (set AM/PM accordingly).
6. Press the CH DOWN button to highlight the minutes position.
7. Press the VOL LEFT/RIGHT button repeatedly to set minutes.
8. Press the CH DOWN button to highlight OFF (time).
9. Repeat steps 5 through 7 for setting OFF (time).
10. Press the CH DOWN button to highlight CHANNEL.
11. Press the VOL LEFT/RIGHT button or use the Remote Control Keyboard to enter the channel number desired when the set turns ON.
12. Press the CH DOWN button to highlight SET.
13. Press the VOL RIGHT button to select:
 - NO – not activated.
 - ONE DAY – activated.
 - DAILY – activated.

NOTE: To deactivate Program Timer select NO in step 13.

14. Press the ACTION button twice to exit Menus.

Helpful Hints:

- If you see GAME GUARD in the upper right hand corner, the channel or Video Input you have selected has been locked out.
- If the Program Timer ON functions while the set is operating, the set will automatically tune to the channel designated in the Timer Program.

Set-Up Features

- Set Time
- Ant (Antenna)
- Auto Prog (Program)
- Manual Prog (Program)
- CC (Closed Caption) on Mute
- CC (Closed Caption) Mode
- English, Espanol (Spanish), or Francais (French)

Located On Remote Control

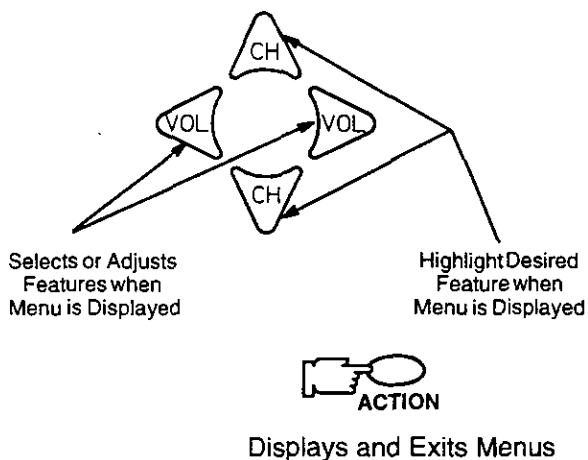

Set Time — Clock (when set) will display on screen at initial Turn On, after a channel change and when pressing the RECALL button. The time must be set first in order to operate the Program ON/OFF Timer.

1. Press the ACTION button to display the Main Menu.
2. Press the CH UP/DOWN and VOL LEFT/RIGHT buttons to highlight the Set Up Icon.
3. Press the ACTION button to display the Set-Up Menu, SET TIME will be highlighted.

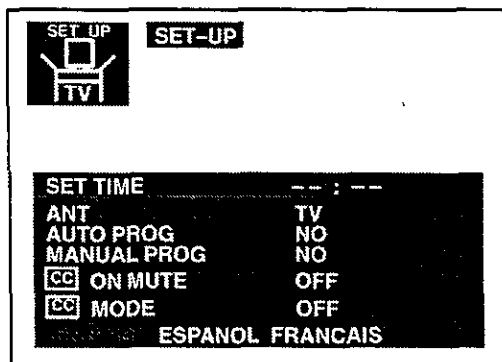

4. Press the VOL LEFT/RIGHT button to set hours (set AM/PM accordingly).
5. Press the CH DOWN button to select minutes position.
6. Press the VOL LEFT/RIGHT button repeatedly to set minutes.
7. Press the ACTION button twice to exit the Set-Up Menu.

Ant (Antenna) — The proper Input mode must be selected for the type of signal at the antenna input.

- TV mode is used when the Receiver is not connected to a cable TV system, for example when using a VHF/UHF antenna (channels 02 - 69).
- Cable mode is used when the Receiver is connected to a Cable TV system and you are not using a cable company converter box (channels 01 - 125).

1. Press the ACTION button to display the Main Menu.
2. Press the CH UP/DOWN and VOL LEFT/RIGHT buttons to highlight the Set Up Icon.
3. Press the ACTION button to display the Set-Up Menu.

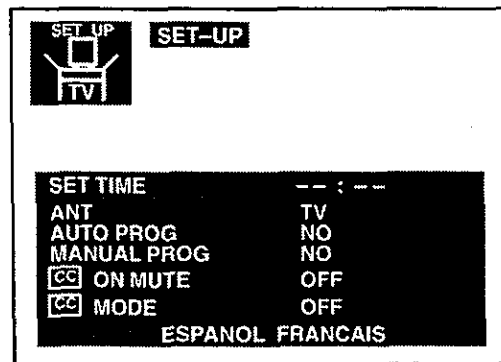

4. Press the CH DOWN button to highlight ANT.
5. Press the VOL LEFT/RIGHT button to select TV or CABLE.
6. Press the ACTION button twice to exit the Set-Up Menu.

Set-Up Features (cont.)

Located On Remote Control

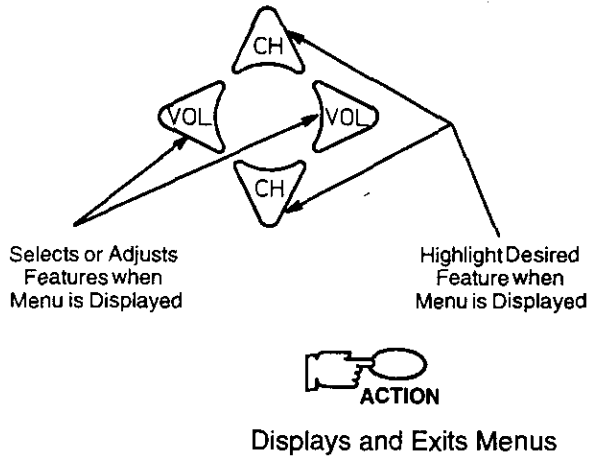

Auto Prog (Program) – This feature allows you to place all channels with a video signal into Channel Scan Memory.

1. Press the ACTION button to display the Main Menu.
2. Press the CH UP/DOWN and VOL LEFT/RIGHT buttons to highlight the Set-Up Icon.
3. Press the ACTION button to display the Set-Up Menu.

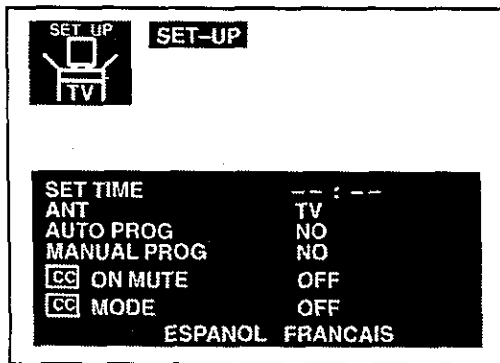

4. Press the CH DOWN button to highlight AUTO PROG.
5. Press the VOL LEFT/RIGHT button to start Auto Programming. Channels will automatically advance until all channels have been scanned.
6. Press the ACTION button twice after completion of Auto Programming to exit the Set-Up Menu.

Note: Channels with signal present, will turn blue when stored in Channel Scan Memory.

Manual Prog (Program) – This feature allows you to select which channels are placed into Channel Scan Memory.

1. Press the ACTION button to display the Main Menu.
2. Press the CH UP/DOWN and VOL LEFT/RIGHT buttons to highlight the Set Up Icon.
3. Press the ACTION button to display the Set-Up Menu.

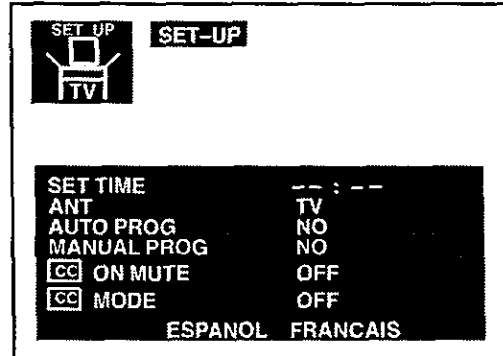

4. Press the CH DOWN button to highlight MANUAL PROG.
5. Press the VOL LEFT/RIGHT button to display the Manual Programming Menu.

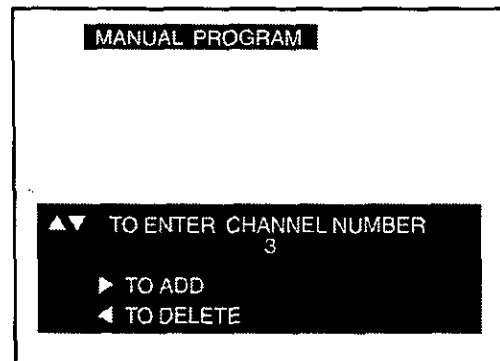

6. Use the CH UP/DOWN button or the numeric keypad (0 through 9 buttons) to select channels.
7. Press the VOL RIGHT button to **add** channel(s) to memory (Blue). Press the VOL LEFT button to **delete** channels from memory (Yellow).
8. Repeat steps 6 and 7 to continue adding or deleting channels.
9. Press the ACTION button twice to exit the Manual Programming Menus.

Set Up Features (cont.)

Located On Remote Control

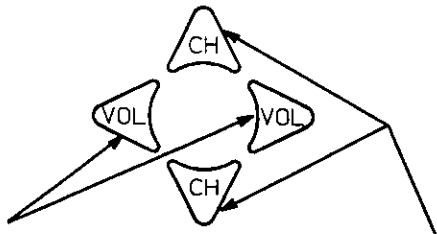

Selects or Adjusts Features when Menu is Displayed

Highlights Desired Feature when Menu is Displayed



Displays and Exits Menus

CC Mute

Activates the On-Screen Closed Captioning when the MUTE button on the Remote Control is pressed. To deactivate press the MUTE button again.

NOTE: This feature only functions when the Close Caption Mode is in the OFF position. The program being viewed must be broadcast with Closed Caption. (Refer to your local TV guide.)

1. Press the ACTION button to display the Main Menu.
2. Press the CH DOWN and VOL RIGHT buttons to select the Set Up Icon.
3. Press the ACTION button to display the Set-Up Menu.

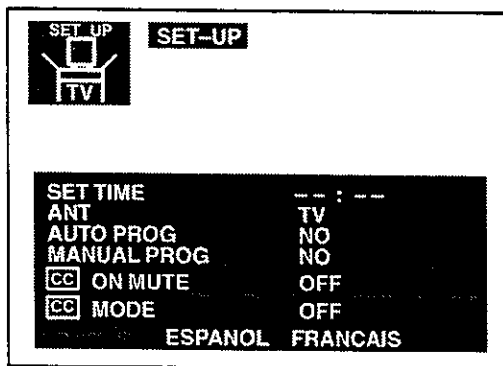

4. Press the CH DOWN button to highlight CC ON MUTE.
5. Press the VOL RIGHT button to select OFF, C1, or C2 Mode.

Recommended Set-Up:

- Place CC ON MUTE into the C1 Mode.
- Press the CH DOWN button to select CC MODE.
- Press the VOL RIGHT button to select OFF.

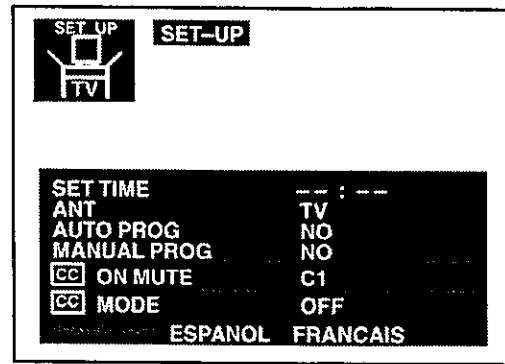

6. Press the ACTION button twice to exit the Set-Up Menu.
7. Press the MUTE button when the program being viewed is broadcast with Closed Caption to activate. Press again to deactivate.

CC Mode

This Receiver has a built-in decoder that provides a visual depiction (of audio portion) of a television program. This visual depiction is in the form of text across the screen (white or colored letters on a black background). It allows the viewer to read the dialogue of a television program or other information.

1. Press the ACTION button to display the Main Menu.
2. Press the CH UP/DOWN and VOL LEFT/RIGHT buttons to select the Set Up Icon.
3. Press the ACTION button to display the Set-Up Menu.



4. Press the CH DOWN button to highlight CC MODE.
5. Press the VOL RIGHT button to select OFF, C1, or C2.
 - OFF – Recommended mode when you do not wish to view Closed Caption.
 - C1 – For video related information that can be displayed (up to four (4) lines of script strategically placed on the television screen so that it does not obstruct relevant parts of the picture). Script can be in any language.
 - C2 – Another mode used for video related information that can be displayed (up to four (4) lines of script, strategically placed on the television screen so that it does not obstruct relevant parts of the picture).
6. Press the ACTION button twice to exit Set-Up Menus.

Set-Up Features (cont.)

Located On Remote Control

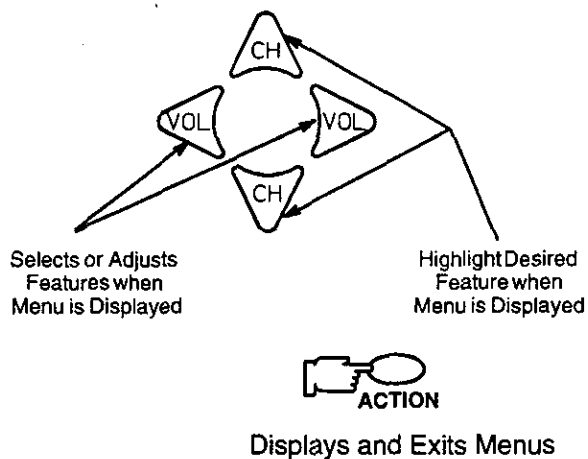

Trilingual Menu Selection

The Language Menu is factory set to ENGLISH. Follow these instructions to change the Language Menu to Spanish, French, and back to English.

1. Press the ACTION button to display the Main Menu.
2. Press the CH UP/DOWN and VOL LEFT/RIGHT buttons to highlight the SET UP Icon.
3. Press the ACTION button to display the Set-Up Menu.

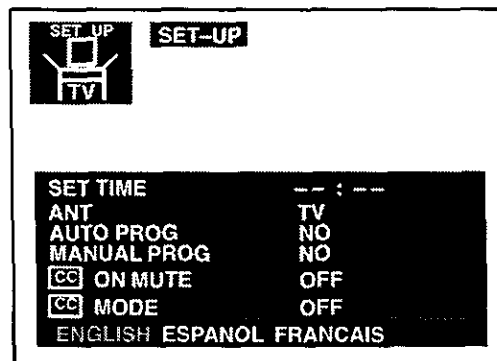

4. Press the CH UP/DOWN button to highlight ENGLISH ESPANOL FRANCAIS.
5. Press the VOL LEFT/RIGHT button to select ENGLISH, ESPANOL, or FRANCAIS.
6. Press the ACTION button twice to exit Menus.

Helpful Hints:

Language Menu does not affect Closed Caption transmitted information.

Care and Cleaning

Picture Tube (Turn set off)

Use a mild soap solution or window cleaner and a clean cloth. DO NOT USE ABRASIVE CLEANERS. Avoid excessive moisture, and always wipe dry.

Plastic Cabinets

Wipe the cabinet with a soft cloth dampened with water or a mild detergent solution and wipe dry with a soft clean cloth. Avoid excessive moisture. Do not use benzene, thinners, or other petroleum based cleaners.

Wood Cabinets

When dusting or polishing the cabinet, use a clean soft cloth and stroke straight with the grain. An occasional coat of furniture polish will help preserve the finish. Do not use benzene, thinners or other petroleum based cleaners. Do not place objects made of plastic or rubber directly on top of the cabinet. A chemical reaction could result causing permanent marring of the finish.

Remote Control Transmitter

To clean, wipe with a soft cloth slightly moistened with a mild detergent, and then wipe dry with a soft clean cloth. Do not use benzene, thinners or other petroleum based cleaners to clean the Remote Control Transmitter.

Programming The Universal Remote Control

VCR

Preferred Procedure – Code Known Programming Universal Remote Using Infra-Red Access Codes for VCRs

- Determine brand of VCR.
- Identify code(s) associated with the brand in the infra-red code index for VCRs (located in this manual).

Procedure

1. Place the Remote TV/CABLE switch into the TV position (Left).



2. Press and hold VCR POWER button down on Universal Remote.



3. Enter two digit code using numeric keypad (0 through 9 buttons). Release VCR Power button. The Universal Remote is now programmed.

Note: Some brands have multiple codes. Repeat procedure using each code listed until VCR responds correctly.

Alternate Procedure – Code Unknown Programming Universal Remote Using the “Sequence Method” for VCRs

- Confirm VCR is plugged in and operating properly, then turn OFF.

Procedure

1. Place the Remote TV/CABLE switch into the TV position (Left).



2. Press and hold the VCR POWER button down on Universal Remote.



3. Press VOL RIGHT button repeatedly. Check for the VCR to turn ON after each press. When the VCR turns ON, release VCR Power button. The proper infra-red code has now been accessed.

NOTES:

1. It may take several attempts before the correct code is found.
2. The VOL LEFT button can be used to return to a code that was accidentally passed by.
3. Some Remote Controls may have unique operating functions for some buttons. For Example: The POWER button may only turn the VCR OFF as opposed to both ON and OFF. It will then be necessary to modify the procedure. Turn the VCR ON and repeatedly press the VOL RIGHT button until the VCR turns OFF.

NOTE: When operating equipment (VCR or Cable Converter box) with the Universal Remote Control, the TV/CABLE Switch should be set to the same position where the Access Code was first programmed for the equipment. Otherwise, leave the switch in the TV position.

Cable Converter Box

Preferred Procedure – Code Known Programming Universal Remote Using Infrared Access Codes for Cable Television Converter Boxes

- Determine brand of Cable Television Converter box.
- Identify code(s) associated with the brand in the infra-red code index for Cable Television Converter boxes (located in this manual).

Procedure

1. Place the Remote TV/CABLE switch into the CABLE position (Right).



2. Press and hold the CABLE POWER button down on Universal Remote.



3. Enter two digit code using numeric keypad (0 through 9 buttons). Release CABLE Power button. The Universal Remote is now programmed. **Use the Remote CHANNEL UP/DOWN buttons for selecting Cable Converter Box channels.**

Note: Some brands have multiple codes. Repeat procedure using each code listed until Cable Television Converter box responds correctly.

Alternate Procedure – Code Unknown Programming Universal Remote Using the “Sequence Method” for Cable Television Converter Boxes

- Confirm Cable Television Converter box is plugged in and operating properly, then turn OFF.

Procedure

1. Place the Remote TV/CABLE switch into the CABLE position (Right).



2. Press and hold the CABLE POWER button down on Universal Remote.



3. Press VOL RIGHT button repeatedly. Check for the Cable Television Converter box to turn ON after each press. When the Cable Television Converter box turns ON, release Cable Power button. The proper infrared code has now been accessed.

NOTES:

- It may take several attempts before the correct code is found.
- The VOL LEFT button can be used to return to a code that was accidentally passed by.
- Some Remote Controls may have unique operating functions for some buttons. For Example: The POWER button may only turn the Cable Television Converter box OFF, as opposed to both ON and OFF. It will then be necessary to modify the procedure. Turn the Cable Television Converter box ON, and repeatedly press the VOL RIGHT button until the Cable Television Converter box turns OFF.

VCR and Cable Converter Box Infrared Codes Index

The Universal Infrared Remote Control is capable of operating many brands of VCRs and Cable Television Converter Boxes after entering the proper infrared code.

NOTE: The Universal Remote Control memory is limited. Some models of VCRs or Cable Television Converter Boxes may not operate. The Universal Remote Control is not designed to control all features that are available in all models.

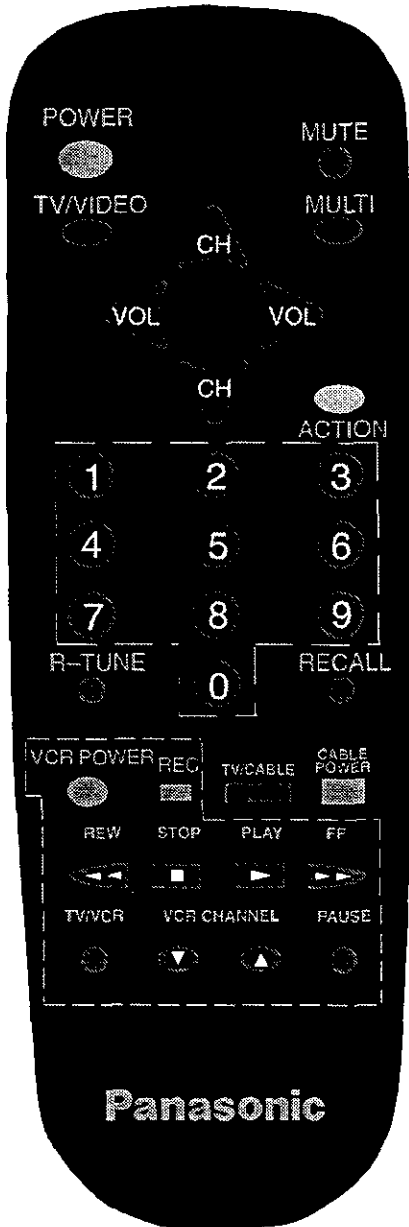

Infrared Code Index For VCRs

















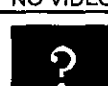

VCR Brand	Code(s)	VCR Brand	Code(s)
Audio Dynamics	14, 16	NEC	02, 14, 16, 30
Broksonic	10	Panasonic	00, 01
Canon	00, 01	Pentax	05
Capehart	01	Philco	00, 29
Citizen	09	Philips	00, 29
Craig	12	Pioneer	05
Curtis Mathes	00, 08, 15	Quasar	00, 01
DBX	14, 16	RCA	05, 07, 08, 28, 35
Emerson	10, 20, 34, 35, 36, 37	Realistic	00, 02, 06, 12, 15
Fisher	12, 18, 19	Samsung	07, 32
Funai	15	Sanyo	02, 12
GE	00, 07, 08, 32	Scott	04, 13, 33, 36
Goldstar	09	Sears	02, 05, 18, 19
Hitachi	05, 35, 36	Sharp	06, 24
Instant Replay	00	Sony	17, 26, 33, 34
JC Penney	00, 02, 05, 14, 16, 30	Sylvania	00, 29
JVC	02, 14, 16, 30	Symphonic	15
Kenwood	02, 14, 16, 30	Tashiko	09
Magnavox	00, 29	Tatung	30
Marantz	02, 14, 16, 29, 30	Teac	15, 30
Marta	09	Teknika	21
Memorex	00, 12	Toshiba	05, 13
MGA	04, 27	Vector Research	14, 16
Minolta	05	Video Concepts	14, 16
Mitsubishi	04, 27	Wards	06
Montgomery Ward	06	Yamaha	02, 14, 16, 30
Multitech	07, 15, 32	Zenith	11, 17

Infrared Code Index For Cable Television Converter Box

Brand of Cable-TV Box	Code(s)	Brand of Cable-TV Box	Code(s)
G.I.	04, 05, 15, 23, 24, 25, 30, 36	Pioneer	18, 20
Hamlin	12, 13, 34	RCA	27
Jerrold	04, 05, 15, 23, 24, 25, 30, 36	Regency	02
Macom	27	Scientific Atlantic	03, 22
Magnavox	19, 26, 28, 29, 32, 33, 40, 41	Sylvania	11
Oak	14, 16, 18	Texscan	10, 11
Oak Sigma	16	Tocom	17, 21
Panasonic	27, 39	Unika	31
Philips	19, 26, 28, 29, 32, 33, 40, 41	Viewstar	19, 26, 28, 29, 32, 33, 40, 41
		Zenith	01, 42

Troubleshooting Chart

Before you call for service, determine the symptoms and make a few simple checks shown below.

Symptoms		Check
Picture	Sound	
 SNOWY PICTURE	 NOISY SOUND	- ANTENNA LOCATION AND/OR CONNECTION
 MULTIPLE IMAGE	 NORMAL SOUND	- ANTENNA DIRECTION AND/OR LOCATION - ANTENNA LEAD-IN WIRE
 INTERFERENCE	 NOISY SOUND	- ELECTRICAL APPLIANCES, LIGHTS, CARS AND TRUCKS - DIATHERMY AND OTHER MEDICAL EQUIPMENT
 NORMAL PICTURE	 NO SOUND	- VOLUME CONTROL SETTING - MUTE CONTROL (IF APPLICABLE) - TRY ANOTHER CHANNEL - TV SPEAKERS SWITCH (IF APPLICABLE) IN THE OFF POSITION
 NO VIDEO	 NOISY SOUND	- TV OR CABLE TUNING MODE SET TO PROPER SETTING - ANTENNA INPUT CORRECT (IF APPLICABLE)
 NO PICTURE	 NO SOUND	- CHECK THAT AC POWER LINE IS PLUGGED INTO AC OUTLET - BRIGHTNESS AND AUDIO CONTROLS SET PROPERLY - TRY ANOTHER CHANNEL
 NO COLOR	 NORMAL SOUND	- COLOR CONTROL SETTINGS - TRY ANOTHER CHANNEL
 BLUE PICTURE	 NO SOUND	- RECEIVER IN VIDEO MODE WITH NO SIGNAL
 BLACK BOX IN PICTURE	 SOUND	- CC (CLOSED CAPTION) IN TEXT MODE - SELECT CAPTION OFF MODE TO ELIMINATE BLACK BOX

Should this unit turn ON momentarily and then turn OFF, or fail to operate, unplug the AC cord and contact your Authorized Servicer for repairs.

Power Loss

Prolonged power interruption causes the following features to reset to their factory preset state.

FEATURE	FACTORY PRESET STATE	FEATURE	FACTORY PRESET STATE
POWER	OFF	CLOCK	NOT SET
VOLUME	APPROX. -1/3	SLEEP TIMER	NO/OFF
CHANNEL	CH 03	TIMER	NO/OFF
PROGRAM MEMORY	UNPROGRAMMED	ANTENNA MODE	CABLE
VIDEO MENUS	NORMALIZED	TV/VIDEO	TV
STEREO/SAP/MONO	STEREO	TRILINGUAL MENU	ENGLISH

**Panasonic Sales Company,
Division of Matsushita Electric
of Puerto Rico Inc. ("PSC")**
Ave. 65 de Infanteria, Km 9.5
San Gabriel Industrial Park
Carolina, Puerto Rico 00985
Tel. (809) 750-4300
FAX. (809) 768-2910

**Matsushita Consumer Electronics
Company, Division of Matsushita
Electric Corporation of America**
One Panasonic Way
Secaucus, New Jersey 07094

Matsushita Electric of Canada Limited
5770 Ambler Drive
Mississauga, Ontario L4W 2T3
Canada