



Self-Cleaning Gas Range

Use & Care Guide

Cocina de gas con autolimpieza

Manual de uso y cuidado

Models, Modelos 665.72022 665.72024 665.72029
665.75022 665.75025 665.75029

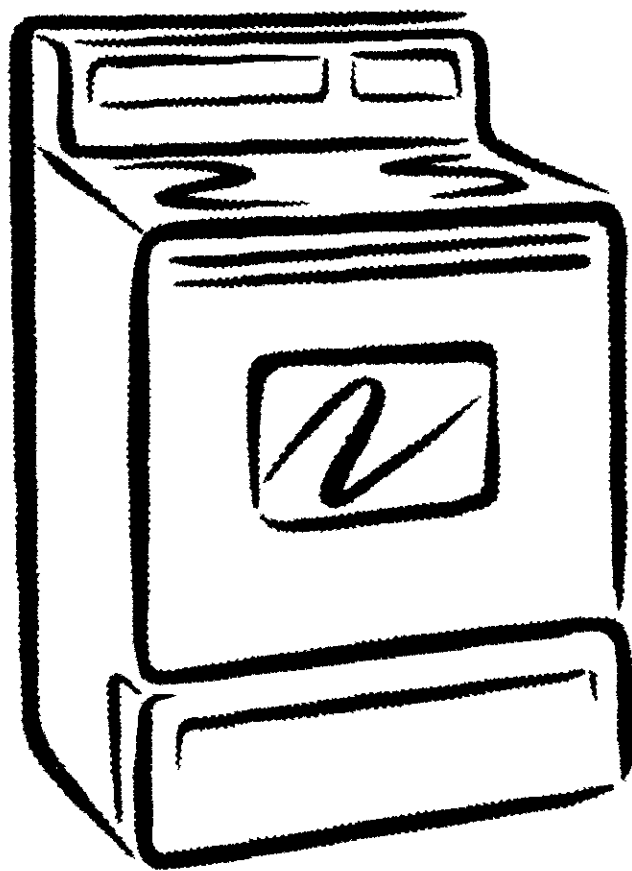

ENGLISH ESPAÑOL

TO THE INSTALLER: PLEASE LEAVE THIS INSTRUCTION BOOK WITH THE UNIT.
TO THE CONSUMER: PLEASE READ AND KEEP THIS BOOK FOR FUTURE REFERENCE.
PARA EL INSTALADOR: FAVOR DE DEJAR ESTE MANUAL DE INSTRUCCIONES CON LA UNIDAD.
PARA EL CONSUMIDOR: FAVOR DE LEER Y GUARDAR ESTE MANUAL PARA FUTURAS REFERENCIAS.

Super Capacity with ULTRABAKE™ System
Capacidad extra con el Sistema ULTRABAKE™

8274077

Sears Roebuck and Co., Hoffman Estates, IL 60179 U.S.A.

www.sears.com

TABLE OF CONTENTS

WE SERVICE WHAT WE SELL	3
WARRANTY	3
RANGE SAFETY	4
The Anti-Tip Bracket.....	5
PARTS AND FEATURES	6
COOKTOP USE	7
Control Knobs	7
Cooktop Lockout.....	7
Sealed Surface Burners	8
SURESIMMER™	9
Home Canning.....	9
Cookware	9
ELECTRONIC OVEN CONTROL	10
Display	10
Start/Enter	10
Off/Cancel.....	10
Clock.....	10
Tones.....	10
Fahrenheit and Celsius.....	11
Timer.....	11
Oven Lockout	11
Oven Temperature Control.....	11
OVEN USE	12
Aluminum Foil.....	12
Positioning Racks and Bakeware	12
STURDIGLIDE™ Oven Racks.....	12
Bakeware.....	13
Oven Vent	13
Baking and Roasting.....	13
Broiling.....	14
RECIPE RECALL™.....	15
Serve Warm Feature.....	15
Timed Oven Control	16
12-Hour Shut-Off.....	17
RANGE CARE	17
Self-Cleaning Cycle.....	17
General Cleaning	19
Oven Light	20
Oven Door	20
Storage Drawer.....	21
TROUBLESHOOTING	21

ÍNDICE

REPARAMOS LO QUE VENDEMOS	23
GARANTÍA	23
SEGURIDAD DE LA COCINA	24
El Soporte antivuelco.....	25
PIEZAS Y CARACTERÍSTICAS	26
USO DE LA SUPERFICIE DE COCCIÓN	27
Perillas de control	27
Bloqueo de la superficie de cocción.....	27
Quemadores exteriores sellados.....	28
SURESIMMER™	29
Enlatado casero.....	29
Utensilios de cocina	29
CONTROL ELECTRÓNICO DEL HORNO	30
Pantalla	30
Start/Enter (Inicio/Ingreso).....	30
Off/Cancel (Apagado/Anulado)	30
Reloj.....	30
Señales audibles.....	30
Fahrenheit y Centígrados	31
Temporizador.....	31
Bloqueo del horno	31
Control de temperatura del horno.....	31
USO DEL HORNO	32
Papel de aluminio	32
Posición de las parrillas y los utensilios para hornear	32
Parrillas del horno STURDIGLIDE™.....	32
Utensilios para hornear.....	33
Conducto de ventilación del horno	33
Cómo hornear y asar	33
Cómo asar	34
RECIPE RECALL™ (Repetición de recetas)	35
Característica "Servir caliente".....	36
Control temporizado del horno	37
Interruptor de 12 horas.....	38
CUIDADO DE LA COCINA	38
Ciclo de autolimpieza	38
Limpieza general.....	39
Luz del horno	40
Puerta del horno.....	40
Gaveta de almacenamiento	41
SOLUCIÓN DE PROBLEMAS	42

WE SERVICE WHAT WE SELL

Your purchase has added value because you can depend on Sears HomeCentral® for service. With over 12,000 trained repair specialists and access to over 4.2 million parts and accessories, we have the tools, parts, knowledge and skills to ensure our pledge: We Service What We Sell.

Sears Maintenance Agreements

Your Kenmore appliance is designed, manufactured and tested to provide years of dependable operation. Yet any major appliance may require service from time to time. The Sears Maintenance Agreement offers you an outstanding service program, affordably priced.

The Sears Maintenance Agreement

- Is your way to buy tomorrow's service at today's prices.
- Eliminates repair bills resulting from normal wear and tear.
- Provides non-technical and instructional assistance.
- Even if you don't need repairs, provides an annual Preventive Maintenance Check, at your request, to ensure that your appliance is in proper running condition.

Some limitations apply. For more information, call 1-800-827-6655.

WARRANTY

FULL ONE-YEAR WARRANTY ON ALL PARTS

For one year from the date of purchase, when this range is installed and operated according to instructions provided in the Installation Instructions and Use & Care Guide, Sears will repair this range, free of charge, if defective in material or workmanship.

WARRANTY RESTRICTION

If the range is subject to other than private family use, the above warranty coverage is effective for only 90 days.

WARRANTY SERVICE

WARRANTY SERVICE IS AVAILABLE BY CONTACTING THE NEAREST SEARS SERVICE CENTER IN THE UNITED STATES. This warranty applies only while the product is in use in the United States. This warranty gives you specific legal rights and you may also have other rights which vary from state to state.

For Sears warranty information in the United States call 1-800-469-4663.

**Sears, Roebuck and Co.
D/817WA, Hoffman Estates, IL 60179**

PRODUCT RECORD

In the space below, record your complete model number, serial number, and purchase date. You can find this information on the model and serial number label, located as shown in the Parts and Features section of this book. Have this information available to help you quickly obtain assistance or service when you contact Sears concerning your appliance.

Model number 665. _____

Serial number _____

Purchase date _____

Save these instructions and your sales receipt for future reference.

RANGE SAFETY

Your safety and the safety of others are very important.

We have provided many important safety messages in this manual and on your appliance. Always read and obey all safety messages.



This is the safety alert symbol.

This symbol alerts you to potential hazards that can kill or hurt you and others.

All safety messages will follow the safety alert symbol and either the word "DANGER" or "WARNING." These words mean:

⚠ DANGER

You can be killed or seriously injured if you don't immediately follow instructions.

⚠ WARNING

You can be killed or seriously injured if you don't follow instructions.

All safety messages will tell you what the potential hazard is, tell you how to reduce the chance of injury, and tell you what can happen if the instructions are not followed.

WARNING: If the information in this manual is not followed exactly, a fire or explosion may result causing property damage, personal injury or death.

- Do not store or use gasoline or other flammable vapors and liquids in the vicinity of this or any other appliance.
- **WHAT TO DO IF YOU SMELL GAS:**
 - Do not try to light any appliance.
 - Do not touch any electrical switch.
 - Do not use any phone in your building.
 - Immediately call your gas supplier from a neighbor's phone. Follow the gas supplier's instructions.
 - If you cannot reach your gas supplier, call the fire department.
- Installation and service must be performed by a qualified installer, service agency or the gas supplier.

The California Safe Drinking Water and Toxic Enforcement Act requires the Governor of California to publish a list of substances known to the State of California to cause cancer, birth defects, or other reproductive harm, and requires businesses to warn of potential exposure to such substances.

WARNING: This product contains a chemical known to the State of California to cause cancer, birth defects, or other reproductive harm.

This appliance can cause low-level exposure to some of the substances listed, including benzene, formaldehyde, carbon monoxide, toluene, and soot.

The Anti-Tip Bracket

The range will not tip during normal use. However, the range can tip if you apply too much force or weight to the open door without the anti-tip bracket fastened down properly.



⚠ WARNING

Tip Over Hazard

A child or adult can tip the range and be killed.

Connect anti-tip bracket to rear range foot.

Reconnect the anti-tip bracket, if the range is moved.

See the installation instructions for details.

Failure to follow these instructions can result in death or serious burns to children and adults.

Anti-Tip Bracket

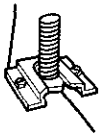

Range Foot

Making sure the anti-tip bracket is installed:

- Slide range forward.
- Look for the anti-tip bracket securely attached to floor.
- Slide range back so rear range foot is under anti-tip bracket.

IMPORTANT SAFETY INSTRUCTIONS

WARNING: To reduce the risk of fire, electrical shock, injury to persons, or damage when using the range, follow basic precautions, including the following:

■ **WARNING:** TO REDUCE THE RISK OF TIPPING OF THE RANGE, THE RANGE MUST BE SECURED BY PROPERLY INSTALLED ANTI-TIP DEVICES. TO CHECK IF THE DEVICES ARE INSTALLED PROPERLY, SLIDE RANGE FORWARD, LOOK FOR ANTI-TIP BRACKET SECURELY ATTACHED TO FLOOR, AND SLIDE RANGE BACK SO REAR RANGE FOOT IS UNDER ANTI-TIP BRACKET.

■ **CAUTION:** Do not store items of interest to children in cabinets above a range or on the backguard of a range – children climbing on the range to reach items could be seriously injured.

■ **Proper Installation** – The range, when installed, must be electrically grounded in accordance with local codes or, in the absence of local codes, with the *National Electrical Code, ANSI/NFPA 70*. Be sure the range is properly installed and grounded by a qualified technician.

■ This range is equipped with a three-prong grounding plug for your protection against shock hazard and should be plugged directly into a properly grounded receptacle. Do not cut or remove the grounding prong from this plug.

- Disconnect the electrical supply before servicing the appliance.
- Never Use the Range for Warming or Heating the Room.
- Injuries may result from the misuse of appliance doors or drawers such as stepping, leaning, or sitting on the doors or drawers.
- Maintenance – Keep range area clear and free from combustible materials, gasoline, and other flammable vapors and liquids.
- Storage in or on the Range – Flammable materials should not be stored in an oven or near surface units.
- Top burner flame size should be adjusted so it does not extend beyond the edge of the cooking utensil.

For self-cleaning ranges –

- Before Self-Cleaning the Oven – Remove broiler pan and other utensils. Wipe off all excessive spillage before initiating the cleaning cycle.

SAVE THESE INSTRUCTIONS

ENGLISH

PARTS AND FEATURES

This manual covers several different models. The range you have purchased may have some or all of the items listed. The locations and appearances of the features shown here may not match your model.

Control Panel

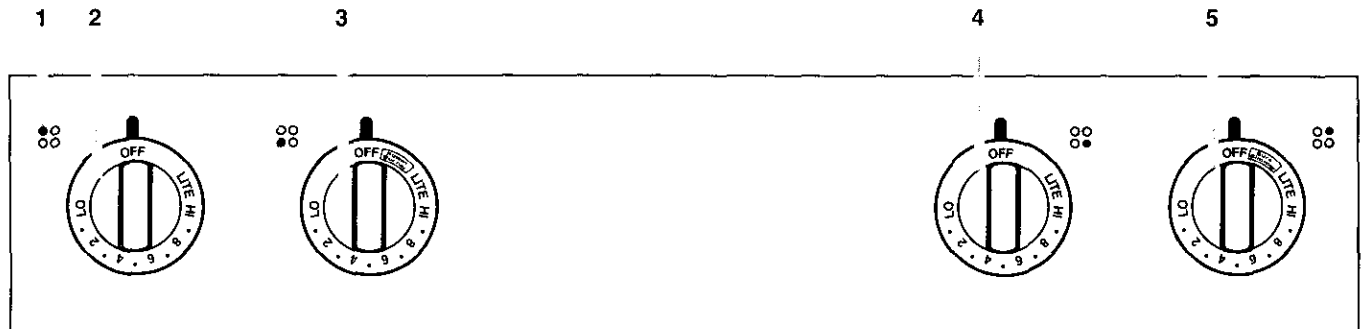

- 1. Surface Burner Indicator Light
- 2. Left Rear Control
- 3. Left Front Control (Power Burner)
- 4. Right Front Control
- 5. Right Rear Control (SURESIMMER™)

Range

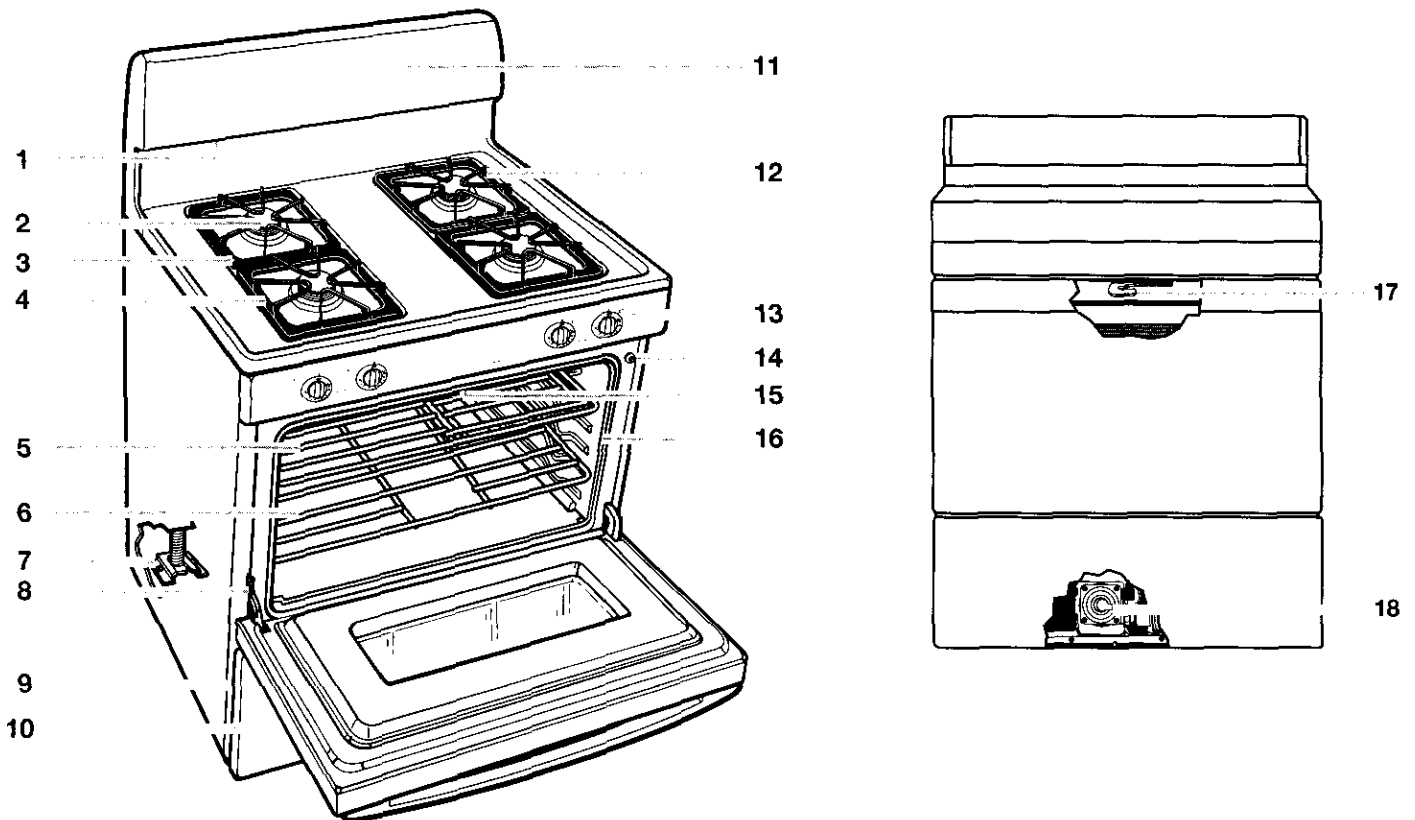

- 1. Oven Vent
- 2. Sealed Surface Burner
- 3. Burner Grate System
- 4. Power Burner
- 5. STURDIGLIDE™ Half Rack (with removable insert)
- 6. STURDIGLIDE Oven Rack (with integrated handle)
- 7. Anti-Tip Bracket
- 8. Door Stop clip
- 9. Model and Serial Number Plate (behind left side of storage drawer)
- 10. Storage Drawer
- 11. Electronic Oven Control
- 12. SURESIMMER Burner
- 13. Control Panel
- 14. Automatic Oven Light Switch
- 15. Broil Element (not shown)
- 16. Gasket
- 17. Self-Clean Latch
- 18. Gas Regulator

COOKTOP USE

Control Knobs

⚠ WARNING



Fire Hazard

Do not let the burner flame extend beyond the edge of the pan.

Turn off all controls when not cooking.

Failure to follow these instructions can result in death or fire.

Electric igniters automatically light the surface burners when control knobs are turned to LITE.

Before setting a control knob, place filled cookware on the grate. Do not operate a burner using empty cookware or while the grate is vacant.

To Set:

1. Push in and turn knob counterclockwise to LITE.
All four surface burners will click. Only the burner with the control knob turned to LITE will produce a flame.
2. Turn knob anywhere between HI and LO. Use the following chart as a guide when setting heat levels.

SETTING	RECOMMENDED USE
LITE	<ul style="list-style-type: none"> Light the burner.
HI	<ul style="list-style-type: none"> Start food cooking. Bring liquid to a boil.
Mid-range (between HI and LO)	<ul style="list-style-type: none"> Hold a rapid boil. Quickly brown or sear food. To fry chicken. Maintain a slow boil. Fry or sauté foods. Cook soups, sauces and gravies.
LO	<ul style="list-style-type: none"> Keep food warm. To simmer.
Power Burner (left front burner)	<ul style="list-style-type: none"> Provide highest heat setting
SURESIMMER™ (right rear burner)	<ul style="list-style-type: none"> Provide lowest simmer/heat setting. Melt chocolate or butter.

REMEMBER: When range is in use or during the Self-Cleaning cycle, the entire cooktop area may become hot.

Power Burner

The left front burner is designed to give ultra-high power when it is fully on. It can be used to rapidly bring liquid to a boil and to cook large quantities of food.

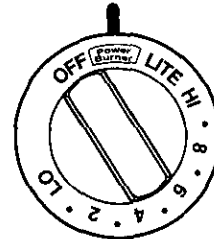

Cooktop Lockout

The Cooktop Lockout prevents unintended use of the surface burners. When the cooktop is locked out, the surface burners cannot be turned on by the control knobs.

The cooktop will remain locked after a power failure if it was locked before the power failure. If the product loses power, appliance will automatically go into the lockout position. The surface burners cannot be activated until power is restored and the Cooktop Lockout is disengaged.

To Lock/Unlock Cooktop:

Before using, turn all control knobs to OFF. Press and hold the TOP keypad for 5 seconds until a single tone and "Loc on" will appear on the display. After 5 seconds, "Loc on" will disappear from the display, and a picture of the cooktop will appear.

Repeat to unlock cooktop. "Loc OFF" will appear on the display for 5 seconds and the picture of the cooktop will disappear from the display.

SAMSUNG

Sealed Surface Burners

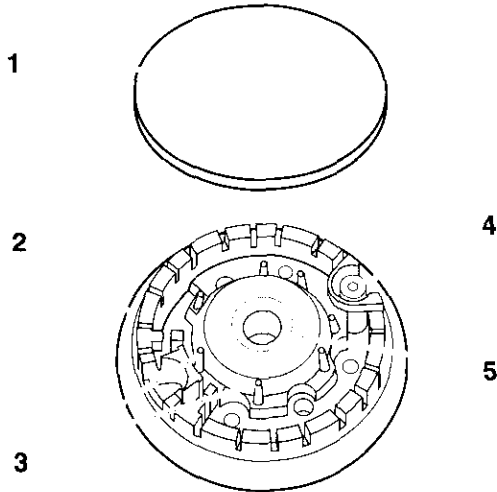

1. Burner cap
2. Burner base
3. Alignment pins
4. Ignitor
5. Gas tube opening

IMPORTANT: Do not obstruct the flow of combustion and ventilation air around the burner grate edges.

Burner cap: Always keep the burner cap in place when using a surface burner. A clean burner cap will help prevent poor ignition and uneven flames. Always clean the burner cap after a spill-over and routinely remove and clean the caps according to the "General Cleaning" section.

Gas tube opening: Gas must flow freely throughout the gas tube opening for the burner to light properly. **Keep this area free of soil and do not allow spills, food, cleaning agents or any other material to enter the gas tube opening.** Protect it from spill-overs by always using a burner cap.

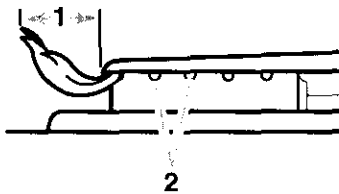

1. 1-1½" (25-38 mm)
2. Burner ports

Burner ports: Check burner flames occasionally for proper size and shape as shown below. A good flame is blue in color, not yellow. Keep this area free of soil and do not allow spills, food, cleaning agents or any other material to enter the burner ports.

To Clean:

IMPORTANT: Before cleaning, make sure all controls are off and the oven and cooktop are cool. Do not use oven cleaners, bleach or rust removers.

1. Remove the burner cap from the burner base and clean according to the "General Cleaning" section.
2. Clean the gas tube opening with a damp cloth.
3. Clean clogged burner ports with a straight pin as shown. Do not enlarge or distort the port. Do not use a wooden toothpick. If the burner needs to be adjusted, contact a trained repair specialist.

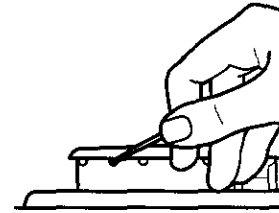

4. Replace the burner cap, making sure the alignment pins on the cap are properly aligned with the burner base.

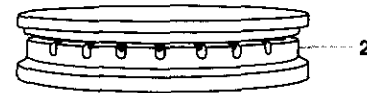

1. Incorrect
2. Correct

5. Turn on the burner. If the burner does not light, check cap alignment. If the burner still does not light, do not service the sealed burner yourself, contact a trained repair specialist.

SURESIMMER™

The SURESIMMER burner is an adjustable heat setting for more precise simmering and low temperature cooking. It is the right rear burner. When the SURESIMMER burner is not on, the right rear burner will function as usual.

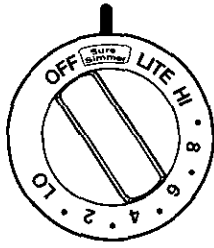

To Use:

1. Push the right rear knob in and turn counterclockwise to "SURESIMMER".
2. Push in and turn knob to OFF when finished.

Home Canning

When canning for long periods, alternate the use of surface cooking areas, elements or surface burners between batches. This allows time for the most recently used areas to cool.

- Center the canner on the grate or largest surface cooking area or element. Canners should not extend more than 1 in. (2.5 cm) outside the cooking area.
- Do not place canner on two surface cooking areas, elements or surface burners at the same time.
- On ceramic glass models, only use flat-bottomed canners.
- On coil element models, the installation of a Canning Unit Kit is recommended. If not installed, the life of the coil element will be shortened. See "Assistance or Service" for ordering instructions.
- For more information, contact your local U.S. Government Agricultural Department Extension Office. Companies who manufacture home canning products can also offer assistance.

Cookware

IMPORTANT: Never leave empty cookware on a hot surface cooking area, element or surface burner.

Ideal cookware should have a flat bottom, straight sides, a well-fitting lid and the material should be of medium-to-heavy thickness.

Cookware material is a factor in how quickly and evenly heat is transferred, which affects cooking results. A non-stick finish has the same characteristics as its base material. For example, aluminum cookware with a non-stick finish will take on the properties of aluminum.

Use the following chart as a guide for cookware material characteristics.

COOKWARE	CHARACTERISTICS
*Aluminum	<ul style="list-style-type: none">■ Heats quickly and evenly.■ Suitable for all types of cooking.■ Medium or heavy thickness is best for most cooking tasks.
Cast iron	<ul style="list-style-type: none">■ Heats slowly and evenly.■ Good for browning and frying.■ Maintains heat for slow cooking.■ Rough surfaces may scratch cooktop.
Ceramic or Ceramic glass	<ul style="list-style-type: none">■ Follow manufacturer's instructions.■ Rough surfaces may scratch cooktop.■ Heats slowly, but unevenly.■ Ideal results on low to medium heat settings.
*Copper	<ul style="list-style-type: none">■ Heats very quickly and evenly.
Earthenware	<ul style="list-style-type: none">■ Follow manufacturer's instructions.■ Use on low heat settings.
Porcelain enamel-on-steel or cast iron	<ul style="list-style-type: none">■ See stainless steel or cast iron.
Stainless steel	<ul style="list-style-type: none">■ Heats quickly, but unevenly.■ A core or base of aluminum or copper on stainless steel provides even heating.

*Aluminum and copper may be used as a core or base in cookware. When used as a base it can leave permanent marks on the cooktop or grates.

ELECTRONIC OVEN CONTROL

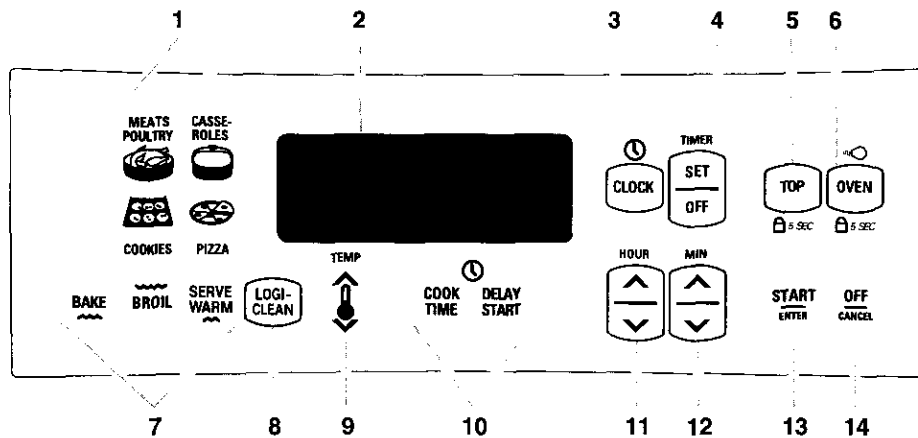

1. RECIPE RECALL™
2. Display
3. Clock
4. Timer
5. Cooktop Lockout

6. Oven Light/Oven Lockout
7. Oven Selector
8. LOGI-CLEAN™ Self-Clean
9. Temperature Setting
10. Timed Cooking

11. Hour
12. Minute
13. Start/Enter
14. Off/Cancel

Display

When power is first supplied to the appliance, make sure the surface burners are in the OFF position. Everything on the display will light up for 5 seconds. Then the time, "PF" and a picture of a cooktop will appear on the display.

Any other time "PF" and a picture of a cooktop appears, a power failure occurred. To remove "PF" and to reset the clock, press OFF/CANCEL.

When the oven is in use, this display shows time, temperature and what command pads have been pressed.

When the oven is not in use, the display will show the time of day.

Start/Enter

The START/ENTER pad begins any oven function except the Timer. If not pressed within 5 seconds after pressing a pad, "START?" will appear on the display as a reminder. If not pressed within 5 minutes after pressing a pad, the display will show the time of day and the programmed function will be cancelled.

Off/Cancel

The OFF/CANCEL pad stops any oven function except for the Clock, Timer and Cooktop or Oven Lockouts.

After pressing OFF/CANCEL, the display will show the time of day or, if the minute timer is also being used, the time remaining.

Clock

This is a 12 hour clock and does not show a.m. or p.m.

To Set:

1. Press CLOCK.
2. Press the HOUR/MIN "up" or "down" arrow pads until the correct time of day shows on the display.
3. Press CLOCK or START/ENTER.

Tones

Tones are audible signals, indicating the following:

One tone

- Valid pad press
- Oven is preheated
- Function has been entered

Three tones

- Invalid pad press

Four tones

- End-of-cycle
- Reminder, repeating each minute after the end-of-cycle tones

Error Tones

Error tones indicate a problem with the electronic oven control. An error code will appear in the display.

Tone Volume

The volume can be adjusted between high and low.

To Change: Press and hold DELAY START for 5 seconds. A short tone will sound and either "Snd HI" or "Snd Lo" will appear on the display. Press and hold DELAY START again for 5 seconds to change to desired setting.

To remove "Snd on", "Snd OFF", "rEP on", "Snd HI" or "Snd Lo" press any pad, and the time of day will appear on the display.

Reminder Tones

Reminder tones are four 1-second tones which indicate that the set time has expired for a timer or a timed oven control function.

Timer

To Turn Tones Off/On: Press and hold SET/OFF for 5 seconds. A short tone will sound and "rEP OFF" will appear on the display. Repeat to turn back on.

Timed Cooking

To Turn Tones Off/On: Press and hold COOK TIME. A short tone will sound and "Snd OFF" will appear on the display. Repeat to turn back on.

Fahrenheit and Celsius

The temperature is preset at Fahrenheit, but can be changed to Celsius.

To Change: Press and hold BROIL for 5 seconds. A short tone will sound and the temperatures displayed will switch to "C°". Repeat to change back to Fahrenheit.

Timer

The Timer can be set in minutes and seconds or hours and minutes and counts down the set time. The Timer does not start or stop the oven.

To Set:

1. Press TIMER SET.
2. Press the HOUR/MIN "up" or "down" arrow pads until the correct length of time shows on the display.
3. Press START/ENTER or TIMER SET.
The timer will begin counting down after the timer is started. The display will count down in hours and minutes if remaining time is one hour or more, and in minutes and seconds if remaining time is less than one hour.
When the set time ends four 1-second tones, if enabled, will sound, then reminder tones will sound every minute.
4. Press TIMER OFF anytime to cancel the Timer and/or stop reminder tones.

Oven Lockout

The Oven Lockout prevents unintended use of the control panel command keypads. The oven can only be locked out when the oven is not in use or the oven control has not been set.

The oven will remain locked out after a power failure if it was locked before the power failure.

To Lock/Unlock Oven:

Press and hold OVEN for 5 seconds. A single tone will sound and "Loc on" will appear on the display. After 5 seconds, "Loc on" will disappear from the display, and "Loc" and a picture of a lock will appear.

Three tones will sound when the oven is locked and any command pad other than CLOCK, TIMER, START/ENTER, OFF/CANCEL, TOP or OVEN has been pressed.

To unlock oven, press and hold OVEN for 5 seconds. "Loc OFF" will appear on the display and a picture of a lock will disappear from the display.

Oven Temperature Control

IMPORTANT: Do not use a thermometer to measure oven temperature because opening the oven door and element or burner cycling may give incorrect readings.

The oven provides accurate temperatures; however, it may cook faster or slower than your previous oven, so the temperature calibration can be adjusted. It can be changed in Fahrenheit or Celsius.

A minus sign means the oven will cook cooler by the adjustment amount. No sign means the oven will cook warmer by the adjustment amount. Use the following chart as a guide.

ADJUSTMENT °F (ADJUSTMENT °C)	COOKS FOOD
10°F (6°C)	...a little more
20°F (12°C)	...moderately more
30°F (18°C)	...much more
-10°F (-6°C)	...a little less
-20°F (-12°C)	...moderately less
-30°F (-18°C)	...much less

To Adjust Oven Temperature Calibration:

1. Press and hold BAKE for 5 seconds until the oven display shows the current calibration, for example, "0° CAL".
2. Press the TEMP "up" or "down" arrow pad to increase or to decrease the temperature in 10°F (6°C) amounts. The adjustment can be set between 30°F (18°C) and -30°F (-18°C).
3. Press START/ENTER.

OVEN USE

Aluminum Foil

IMPORTANT: Do not line the oven bottom with any type of foil, liners or cookware because permanent damage will occur to the oven bottom finish.

- Do not block or cover the oven bottom vents.
- Do not cover entire rack with foil because air must be able to move freely for best cooking results.
- To catch spills, place foil on rack below dish. Make sure foil is at least 1 in. (2.5 cm) larger than the dish and that it is turned up at the edges.

Positioning Racks and Bakeware

IMPORTANT: Never place food or bakeware directly on the oven door or bottom. Permanent damage will occur to the porcelain finish.

RACKS

Position racks before turning the oven on. Do not move racks with bakeware on them. Make sure racks are level. To move a rack, pull it out to the stop position, raise the front edge, then lift out. Use the following illustration and chart as a guide..

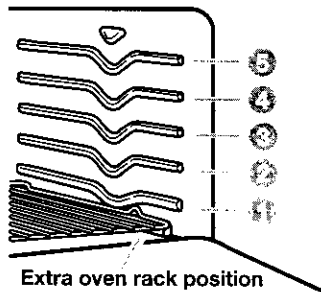

FOOD	RACK POSITION
Frozen pies, large roasts, turkeys, angel food cakes	1 or 2
Bundt cakes, most quick breads, yeast breads, casseroles, meats	2
Cookies, biscuits, muffins, cakes, non frozen pies	2 or 3
Extra large items	Extra oven rack

BAKEWARE

To cook food evenly, hot air must be able to circulate. Allow 2 in. (5 cm) of space around bakeware and oven walls. Use the following chart as a guide.

NUMBER OF PAN(S)	POSITION ON RACK
1	Center of rack.
2	Side by side or slightly staggered.
3 or 4	Opposite corners on each rack. Make sure that no bakeware piece is directly over another.

STURDICOIL™ Over Racks

Rack with Integrated Handle

The integrated handle area makes pulling out the rack easy. The opening is large enough for a potholder or oven mitt.

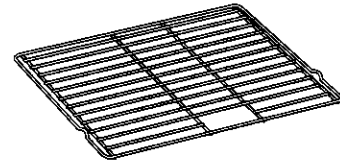

Half-Rack with Removable Insert

The half-rack with removable insert is a space maximizer. When the two are attached, they make a full rack. The insert can also be used on the counter for a cooling rack.

Do not place more than 25 pounds on the half-rack.

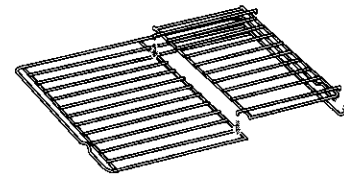

To Position Racks:

1. Place a full rack on position 1 or 2, and the half-rack on position 3 or 4.
2. Place large items on the right side of the full rack.
3. Place deeper, covered dishes on the left side of the full rack.
4. Place shallow dishes on the half-rack.
5. When finished cooking, carefully remove items.

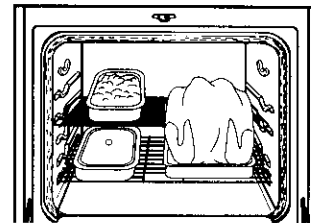

Bakeware

The bakeware material affects cooking results. Follow manufacturer's recommendations and use the bakeware size recommended in the recipe. Use the following chart as a guide.

BAKEWARE/ RESULTS	RECOMMENDATIONS
Light colored aluminum <ul style="list-style-type: none"> ■ Light golden crusts ■ Even browning 	<ul style="list-style-type: none"> ■ Use temperature and time recommended in recipe.
Dark aluminum and other bakeware with dark, dull and/or non-stick finish <ul style="list-style-type: none"> ■ Brown, crisp crusts 	<ul style="list-style-type: none"> ■ May need to reduce baking temperatures 25°F (15°C). ■ Use suggested baking time. ■ For pies, breads and casseroles, use temperature recommended in recipe. ■ Place rack in center of oven.
Insulated cookie sheets or baking pans <ul style="list-style-type: none"> ■ Little or no bottom browning 	<ul style="list-style-type: none"> ■ Place in the bottom third of oven. ■ May need to increase baking time.
Stainless steel <ul style="list-style-type: none"> ■ Light, golden crusts ■ Uneven browning 	<ul style="list-style-type: none"> ■ May need to increase baking time.
Stoneware <ul style="list-style-type: none"> ■ Crisp crusts 	<ul style="list-style-type: none"> ■ Follow manufacturer's instructions.
Ovenproof glassware, ceramic glass or ceramic <ul style="list-style-type: none"> ■ Brown, crisp crusts 	<ul style="list-style-type: none"> ■ May need to reduce baking temperatures 25°F (15°C).

Oven Vent

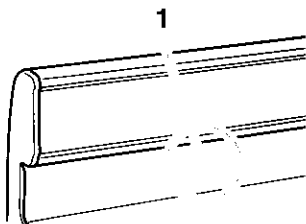

1. Oven Vent

The oven vent releases hot air and moisture from the oven, and should not be blocked or covered. Doing so will cause poor air circulation, affecting cooking and cleaning results. Never set plastics, paper or other items that could melt or burn near the oven vent.

Baking and Roasting

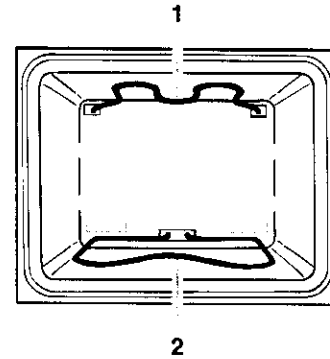

1. Broil element
2. Bake element

ULTRABAKE™ Temperature Management System

The ULTRABAKE system electronically regulates the oven heat levels during preheat and bake to maintain a precise temperature range for optimal cooking results. The bake and broil elements cycle on and off in intervals. This feature is automatically activated when the oven is in use.

If the oven door is opened during baking and roasting, the broil element will turn off immediately and the bake element will turn off in 2 minutes. They will come back on once the door is closed.

To Bake or Roast:

Before baking and roasting, position the racks according to the "Positioning Racks and Bakeware" section. When roasting, it is not necessary to wait for the oven to preheat before putting food in, unless recommended in the recipe.

1. Press BAKE.

Press the TEMP "up" or "down" arrow pad to enter a temperature other than 350°F (177°C). The bake range can be set between 170°F and 500°F (77°C and 260°C).

2. Press START/ENTER.

A preheat time will count down and "PrE HEAT" will appear on the oven display if the actual oven temperature is under 170°F (77°C).

When the actual oven temperature reaches 170°F (77°C), the timer will continue counting down. The temperature setting can be changed any time after pressing START/ENTER.

While the oven is in the preheat mode, the set temperature can be seen for 5 seconds by pressing BAKE.

When the set temperature is reached, if tones are enabled, one tone will sound.

3. Press OFF/CANCEL when finished cooking.

Broiling

- Use only the broiler pan and grid provided with the range. It is designed to drain juices and help prevent spatter and smoke.
- For proper draining, do not cover the grid with foil. The bottom of the pan may be lined with aluminum foil for easier cleaning.
- Trim excess fat to reduce spattering. Slit the remaining fat on the edges to prevent curling.
- Pull out oven rack to stop position before turning or removing food. Use tongs to turn food to avoid the loss of juices. Very thin cuts of fish, poultry or meat may not need to be turned.
- After broiling, remove the pan from the oven when removing the food. Drippings will bake on the pan if left in the heated oven, making cleaning more difficult.

Broiling uses direct radiant heat to cook food. Before broiling, position rack according to Broiling chart. It is not necessary to preheat the oven before putting food in unless recommended in the recipe. Position food on grid in the broiler pan, then place it in the center of the oven rack.

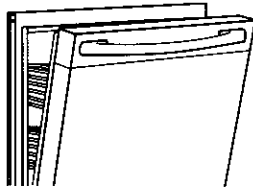

To Broil:

1. Open oven door to the broil stop position to ensure proper broiling temperature.
2. Press BROIL.
3. Press START/ENTER.
The temperature setting can be seen any time before or after pressing START/ENTER.
4. Press OFF/CANCEL when finished.

Precision Broiling

Changing the temperature when Precision Broiling allows more precise control when cooking. The lower the temperature, the slower the cooking. Thicker cuts and unevenly shaped pieces of meat, fish and poultry may cook better at lower broiling temperatures.

To Precision Broil:

1. Press BROIL.
2. Press the TEMP "down" arrow pad to lower the temperature in 5°F amounts. The broil range is 300°F to 500°F (149°C to 200°C).
3. Press START/ENTER.
4. Press OFF/CANCEL when finished.

Broiling chart

For best results, place food 3 in. (7 cm) or more from the broil element. Times are guidelines only and may need to be adjusted for individual tastes. Recommended rack positions are numbered from the bottom (1) to the top (5). For diagram, see the "Positioning Racks and Bakeware" section.

FOOD	RACK POSITION	TEMP	TOTAL MINUTES	
			Side 1	Side 2
Steak				
1 in. (2.5 cm) thick				
medium rare	4	HI	14-15	7-8
medium	4	HI	15-16	8-9
well done	4	HI	18-19	9-10
*Ground meat patties				
¾ in. (2 cm) thick	4	HI	13-14	6-7
well done				
Pork chops				
1 in. (2.5 cm) thick	4	HI	18-21	8-10
Ham slice				
[precooked] ½ in. (1.25 cm) thick	4	HI	8-10	4-5
Bacon	4	500°F (260°C)	8-9	1-2
Frankfurters	4	HI	6-7	3-4
Lamb chops				
1 in. (2.5 cm) thick	4	HI	15-17	8-9
Chicken				
bone-in pieces	3	HI	20-24	15-18
boneless	4	HI	12-16	11-16
Fish				
½ in. (.25 cm) thick	4	HI	8-10	4-5
1 in. (2.5 cm) thick	4	500°F (260°C)	13-15	10-13
* Place up to 9 patties, equally spaced, on broiler pan grid.				

RECIPE RECALL™

RECIPE RECALL makes cooking favorite foods faster and easier. The temperatures and times have been chosen to cover a variety of choices in each food category. Cooking times are adjustable for individual recipes and can be saved. Temperatures can be changed but not saved. When changed, the display will not show "PrEHEAT" while the oven is preheating.

If recipe recommends no preheat is needed, put food in oven.

Use the following chart as a guide when using RECIPE RECALL:

Keypad	Set Temperature	Preset Time
MEATS/ POULTRY* 3 lb. (48 oz.)	325°F (163°C)	1 hour
CASSEROLES* 2 qt. (4 pt.)	350°F (177°C)	45 minutes
COOKIES	375°F (191°C)	10 minutes
PIZZA	400°F (204°C)	20 minutes

*The MEATS/POULTRY and CASSEROLES functions do not have a programmed pre-heat. If your recipe suggests you pre-heat before cooking meats, poultry or casseroles, pre-heat using the BAKE function. Once the pre-heat temperature has been reached, cancel BAKE and select MEATS/POULTRY or CASSEROLES function.

To Use RECIPE RECALL:

1. Press one of the four keypads MEATS POULTRY, CASSEROLES, COOKIES or PIZZA.
2. Press START/ENTER.

The cook time can be changed after pressing START/ENTER, by pressing the HOUR/MIN pads. The oven will finish cooking with the new time.

When cook time ends, the oven will automatically shut off. "End" and COOK TIME will appear on the display. Four tones will sound, then four 1-second reminder tones will sound every minute after.

COOKIES and PIZZA keypads include a preheat. When the preheat ends, a single tone will sound and the cooking time will appear counting down on the display.

3. Press OFF/CANCEL or open the oven door to stop reminder tones and remove "End" from display. The time of day will appear on the display.

To Change Preset Cook Time:

The length of cooking time for each of the 4 keypads can be changed, and the range will store the new information for the next use.

1. Press one of the four keypads MEATS POULTRY, CASSEROLES, COOKIES or PIZZA.
2. Press the HOUR/MIN "up" or "down" arrow pads until the length of cooking time shows on the display.
3. Press same pad selected in step 1 to save the change for the next use.
A single tone will sound.
4. Press OFF/CANCEL if only changing the stored preset cook time. Press START/ENTER if proceeding to cook with new set cook time.

Serve Warm Feature

⚠ WARNING

Food Poisoning Hazard

Do not let food sit in oven more than one hour before or after cooking.

Doing so can result in food poisoning or sickness.

IMPORTANT: Food must be at serving temperature before placing it in the warmed oven. Food may be held up to one hour. Serve Warm allows hot cooked foods to stay warm before serving. It can also be used at the end of a timed cook.

To Use:

1. Press SERVE WARM.
2. Set the temperature (optional).
Press the TEMP "up" or "down" arrow pad to raise or lower the temperature in 5°F (3°C) amounts to set a temperature other than 150°F (66°C). The warm range is 100°F-200°F (38°C-93°C).
3. Press START/ENTER.
4. Press OFF/CANCEL when finished.

To Add to the End of a Set Cook Time:

1. Press BAKE.
2. Press COOK TIME.
3. Press the HOUR/MIN "up" or "down" arrow pads to set cook time.
4. Press SERVE WARM.
A one hour warm time will automatically be set.
5. Set the warm temperature (optional).
Press the TEMP "up" or "down" arrow pad to raise or lower the temperature in 5°F (3°C) amounts to set a temperature other than 150°F (66°C). The warm range is 100°F-200°F (38°C-93°C).
6. Press START/ENTER.
The display will show the cook time counting down. When cook time ends, the display will show a warming time.

When warming time ends, the oven will automatically shut off and "End" and COOK TIME will show on the display. Four tones will sound and then four 1-second reminder tones will sound every minute thereafter.
7. Press OFF/CANCEL or open the oven door to stop reminder tones and remove "End" from display. The time of day will return to the display.

To Add to the End of a Delay Start/Set Cook Time:

1. Press BAKE.
2. Set the temperature (optional).
Press the TEMP "up" or "down" arrow pad to set a temperature other than 350°F (177°C).
3. Press COOK TIME.
Press the HOUR/MIN "up" or "down" arrow pads to set cook time.
4. Press SERVE WARM.
A one hour warm time will automatically be set.
5. Set the warm temperature (optional).
Press the TEMP "up" or "down" arrow pad to raise or lower the temperature in 5°F (3°C) amounts to set a temperature other than 150°F (66°C). The warm range is 100°F-200°F (38°C-93°C).
6. Press START/ENTER.
The display will show the cook time counting down. When cook time ends, the display will show a warming time.

When warming time ends, the oven will automatically shut off and "End" and COOK TIME will show on the display. Four tones will sound and then four 1-second reminder tones will sound every minute thereafter.
7. Press OFF/CANCEL or open the oven door to stop reminder tones and remove "End" from display. The time of day will return to the display.

Timed Oven Control

⚠ WARNING

Food Poisoning Hazard

Do not let food sit in oven more than one hour before or after cooking.

Doing so can result in food poisoning or sickness.

The Timed Oven Control allows the oven to be set to turn on at a certain time of day, cook for a set length of time, and/or shut off automatically. Delay start should not be used for foods such as breads and cakes because they may not bake properly.

To Set a Cook Time:

Before setting, make sure the clock is set to the correct time of day. See "Clock" section.

1. Press BAKE.
Press the TEMP "up" or "down" arrow pad to set a temperature other than 350°F (177°C).
2. Press COOK TIME.
3. Press the HOUR/MIN "up" or "down" arrow pads to enter the length of time to cook.
4. Press START/ENTER.
The start time and stop time countdown will appear on the oven display. The display will count down the baking/roasting time in hours and minutes (if cook time is more than 1 hour), or in minutes and seconds (if cook time is less than 1 hour).

The temperature of time settings can be changed any time after pressing START/ENTER by repeating steps 1 and 3.

When the stop time is reached, the oven will shut off automatically and "End" and COOK TIME will appear on the oven display.

Four tones will sound, then four 1-second reminder tones will sound every minute thereafter.
5. Press OFF/CANCEL or open the oven door to remove "End" from display. The time of day will appear on the display.

To Set a Cook Time and Stop Time [Delay Start]:

1. Press **BAKE**.
Press the **TEMP** "up" or "down" arrow pad to set a temperature other than 350°F (177°C).
2. Press **COOK TIME**.
3. Press the **HOUR/MIN** "up" or "down" arrow pads to enter the length of time to cook.
4. Press **DELAY START**.
5. Press the **HOUR/MIN** "up" or "down" arrow pads to enter the time of day to start.
6. Press **START/ENTER**.
The start time is automatically calculated and displayed.
"DELAY" and the stop time will also appear on the oven display.
When the start time is reached, the oven will automatically turn on.
Press the **TEMP** "up" or "down" arrow pad to set a temperature other than 350°F (177°C).
Four tones will sound, then four 1-second reminder tones will sound every minute.
7. Press **OFF/CANCEL** or open the oven door to remove "End" from display. The time of day will appear on the display.

To Recall Programmed Timed Settings:

To Recall Set	Press	Displayed 5 Seconds
Cook Time	COOK TIME*	set length of cook time
Delay Start	DELAY START	set delay start time
Temperature	BAKE	set temperature

*If cook time has begun, when **DELAY START** is pressed, the display will show the time it started. When **COOK TIME** is pressed, the display will remove the seconds from the remaining countdown time.

To Change Programmed Timed Settings

To Change Set	Press	Setting Displayed
Cook Time	COOK TIME	Press HOUR/MIN "up/down" arrow Press START/ENTER
Delay Start*	DELAY START	Press HOUR/MIN "up/down" arrow Press START/ENTER
Temperature	BAKE	Press TEMP "up/down" arrow Press START/ENTER

*Cannot change the set delay start time once it has been reached.

12-Hour Shut-Off

The oven control is set to automatically shut the oven off 12 hours after the oven turns on. This will not interfere with any timed or delayed cook function.

The oven light will come on when the oven door is opened. To keep the light on continuously, turn the light on by pressing **OVEN**.

To Override:

For longer cooking periods that require oven usage longer than 12 hours, press and hold **CLOCK** for 5 seconds. A single tone will sound and "12H OFF" will appear on the display. The oven will remain on until turned off.

To Reset:

Press and hold **CLOCK** for 5 seconds. A single tone will sound and "12H on" will appear on the display.

RANGE CARE

Self-Cleaning Cycle

⚠ WARNING



Burn Hazard

Do not touch the oven during the Self-Cleaning cycle.

Keep children away from oven during Self-Cleaning cycle.

Do not use commercial oven cleaners in your oven.

Failure to follow these instructions can result in burns, or illness from inhaling dangerous fumes.

IMPORTANT: The health of some birds is extremely sensitive to the fumes given off during the Self-Cleaning cycle. Exposure to the fumes may result in death to certain birds. Always move birds to another closed and well ventilated room.

Self-clean the oven before it is heavily soiled. Heavy soil results in longer cleaning and more smoke.

Keep the kitchen well-ventilated during the Self-Cleaning cycle to help get rid of heat, odors, and smoke.

Do not block the oven vent(s) during the Self-Cleaning cycle. Air must be able to move freely. See "Oven Vent(s)" section.

Do not clean, rub, damage or move the oven door gasket. The door gasket is essential for a good seal.

Prepare Oven:

- Remove the broiler pan, grid, cookware and bakeware and, on some models, the temperature probe from the oven.
- Remove any foil from the oven because it may burn or melt, damaging the oven.
- Remove oven racks to keep them shiny and easy to slide. See "General Cleaning" for more information.
- Hand clean inside door edge and the 1½ in. (3.8 cm) area around the inside oven cavity frame, being careful not to move or bend the gasket. This area does not get hot enough during self-cleaning to remove soil. Do not let water, cleaner, etc. enter slots on door frame. Use a damp cloth to clean this area.
- Wipe out any loose soil to reduce smoke and avoid damage. At high temperatures, foods react with porcelain. Staining, etching, pitting or faint white spots can result. This will not affect cooking performance.

Prepare Cooktop and Storage Drawer:

- Remove plastic items from the cooktop because they may melt.
- Remove all items from the storage drawer.

How the Cycle Works

IMPORTANT: The heating and cooling of porcelain on steel in the oven may result in discoloring, loss of gloss, hairline cracks and popping sounds.

The LOGI-CLEAN™ Self-Cleaning cycle is a "one-touch" step that uses very high temperatures, burning soil to a powdery ash. "SEnS" setting will automatically determine the length of cleaning time. Maximum clean time is 4 hours 30 minutes and minimum is 2 hours.

The oven will automatically shut off once it is clean. The door will not unlock until the oven cools.

The soil level can be manually set to light, average or heavy soil levels by continuously pressing LOGI-CLEAN.

To Set:

- Press **twice** for **light** soils, and "SoilL" will appear on the display.
- Press **three** times for **average** soils, and "SoilA" will appear on the display.
- Press **four** times for **heavy** soils, and "SoilH" will appear on the display.

Once the oven has completely cooled, remove ash with a damp cloth.

The oven light will not work during the Self-Cleaning cycle.

To Self-Clean:

Before self-cleaning, make sure the door is closed completely or it will not lock and the cycle will not begin.

1. Press LOGI-CLEAN.
2. Press START/ENTER.

The oven door will lock in 6 seconds and "LOCKED", the start time and stop time will appear on the display. The door will not unlock until the oven cools. The cycle time includes a 30 minute cool down time

When the cycle is complete and the oven cools, "End" will appear on the display and "LOCKED" will disappear.

3. Press any pad to remove "End" or open the oven door.
4. Close door.

The time of day will appear on the display.

To Delay Start Self-Clean:

Before delay starting Self-Clean, make sure the clock is set to the correct time of day. See "Clock" section. Also, make sure the door is closed completely or it will not lock and the cycle will not begin.

1. Press LOGI-CLEAN.
2. Press DELAY START.

Press the HOUR/MIN "up" or "down" arrow pad to set time of day to start the Self-Cleaning cycle.

3. Press START/ENTER.

The start time is automatically calculated and displayed. The door will automatically lock and "LOCKED", "DELAY" and the stop time will also appear on the display.

When the start time is reached, the oven will automatically turn on.

When the cycle is complete and the oven cools, "End" will appear on the display and "LOCKED" will disappear.

4. Press any pad to remove "End" or open the oven door.
5. Close door.

The time of day will appear on the display.

To Stop Self-Clean any time:

Press OFF/CANCEL, and "cln", "ON", "cool" and "LOCKED" will appear on the display until the oven cools. Then "End" will appear and the door will unlock.

General Cleaning

IMPORTANT: Before cleaning, make sure all controls are off and the oven and cooktop are cool. Always follow label instructions on cleaning products.

Soap, water and a soft cloth or sponge are suggested first unless otherwise noted.

EXTERIOR PORCELAIN ENAMEL SURFACES (on some models)

Food spills containing acids, such as vinegar and tomato, should be cleaned as soon as the entire appliance is cool. These spills may affect the finish.

- Glass cleaner, mild liquid cleaner or non-abrasive scrubbing pad:

Gently clean around the model and serial number plate because scrubbing may remove numbers.

OVEN DOOR EXTERIOR

- Glass cleaner and paper towels or non-abrasive plastic scrubbing pad.

Apply glass cleaner to soft cloth or sponge, not directly on panel.

PORCELAIN-COATED GRATES AND CAPS

Food spills containing acids, such as vinegar and tomato, should be cleaned as soon as the cooktop, grates and caps are cool. These spills may affect the finish.

To avoid chipping, do not bang grates and caps against each other or hard surfaces such as cast iron cookware.

Do not reassemble caps on burners while wet.

Do not clean in the Self-Cleaning cycle.

- Non-abrasive plastic scrubbing pad and mildly abrasive cleanser:

Clean as soon as cooktop, grates and caps are cool.

- Dishwasher (grates only, not caps):

Use the most aggressive cycle.

SURFACE BURNERS

Sealed Burner models

See "Sealed Surface Burners" section.

Open Burner models

See "Open Burners" section.

COOKTOP CONTROLS

Do not use steel wool, abrasive cleansers or oven cleaner.

Do not soak.

When replacing knobs, make sure knobs are in the OFF position.

On some models, do not remove seals under knobs.

- Soap and water or dishwasher:

Pull knobs straight away from control panel to remove.

CONTROL PANEL

Do not use abrasive cleaners, steel-wool pads, gritty wash cloths or some paper towels. Damage may occur.

- Glass cleaner and soft cloth or sponge:

Apply glass cleaner to soft cloth or sponge, not directly on panel.

OVEN CAVITY

Do not use commercial oven cleaners.

Food spills should be cleaned when oven cools. At high temperatures, foods react with porcelain and staining, etching, pitting or faint white spots can result.

- Self-Cleaning cycle:

See "Self-Cleaning Cycle" first.

OVEN RACKS

- Self-Cleaning cycle:

See "Self-Cleaning Cycle" first. Racks will discolor and become harder to slide. After cleaning, a light coating of vegetable oil applied to the rack guides will help them slide.

- Steel wool pad

BROILER PAN AND GRID

Do not clean in the Self-Cleaning cycle.

- Mildly abrasive cleanser:

Scrub with wet scouring pad.

- Solution of ½ cup (125 mL) ammonia to 1 gallon (3.75 L) water:

Soak for 20 minutes, then scrub with scouring or steel wool pad.

- Oven cleaner:

Follow product label instructions.

Porcelain enamel only, not chrome

- Dishwasher

STORAGE DRAWER

Make sure drawer is cool and empty before cleaning.

For more information, see "Storage Drawer" section.

- Mild detergent

Oven Light

The oven light is a standard 40-watt appliance bulb. It will come on when the oven door is open. It will not work during the Self-Cleaning cycle. When the oven door is closed, press the OVEN pad to turn on and off.

Before replacing, make sure the oven and cooktop are cool and the control knobs are off.

To Replace:

1. Unplug range or disconnect power.
2. Turn the glass bulb cover in the back of the oven counterclockwise to remove.

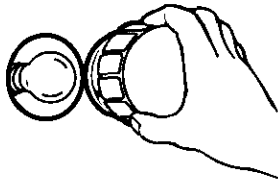

3. Turn bulb counterclockwise to remove from socket.
4. Replace bulb, then bulb cover by turning clockwise.
5. Plug in range or reconnect power.

Oven Door

For normal range use, it is not suggested to remove the oven door. However, if necessary, follow these instructions. The oven door is heavy.

Before Removing:

1. Use a putty knife or screwdriver and insert it at the bottom corner of the door stop clip.

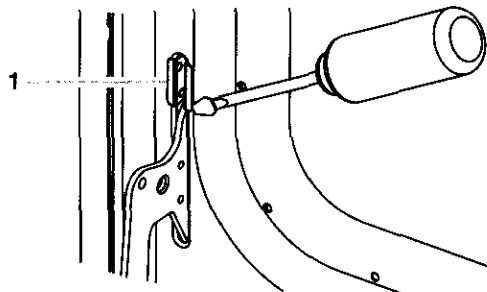

1. Door Stop Clip

2. Pry door stop clip free and remove from front frame hinge slot. Take care not to scratch finish.
3. Repeat procedure for other door stop clip.

To Remove:

1. Open the oven door. Insert door removal pins, included with your range, into both hinge hangers. Do not remove the pins while the door is removed from the range.

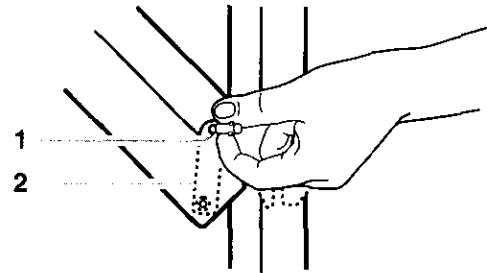

1. Removal Pins
2. Hinge Hangers

2. Carefully close the door until it rests against the door removal pins.
3. Grasp the door on the sides with your fingers on the front of the door and your thumbs on the inside surface.
4. Pull door straight up, then toward you. Hinge hangers will slide out of front frame hinge slot. Do not remove door removal pins until the door is replaced on the range.

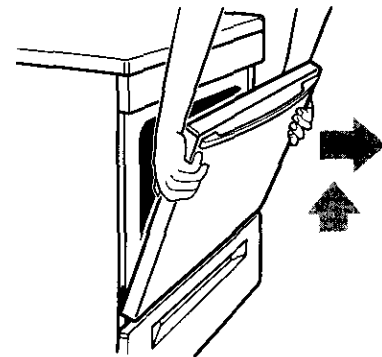

To Replace:

1. Grasp the door on the sides with your fingers on the front of the door and your thumbs on the inside surface.
2. Hold oven door so that the top edge of each hinge hanger is horizontal. Insert hinge hangers into the front frame hinge slots.
3. Tilt top of door toward range. Slide hinge hangers down onto front frame support pins. Make sure the hinge hangers are fully seated and engaged on the support pins.

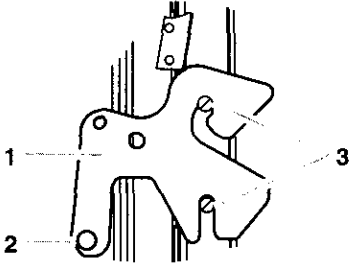

1. Hinge Hanger
2. Door Frame Hinge
3. Support Pins

4. Insert the door stop clip with the angular surface at the top of the frame hinge slot, then push in the bottom of the clip until flanges are flush with the front frame.

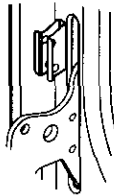

5. Open the door completely and remove the door removal pins. Save door removal pins for future use.
6. Close the door.

Storage Drawer

The storage drawer can be removed. Before removing, make sure drawer is cool and empty.

To Remove:

1. Pull drawer straight out to the first stop.
2. Lift up the back of the drawer and pull out.

To Replace:

1. Fit the ends of the drawer rails into the guides in the cavity.
2. Slide the drawer closed.

TROUBLESHOOTING

Try the solutions suggested here first in order to avoid the cost of an unnecessary service call.

Nothing will operate

- **Is the power outlet properly wired and polarized?**
Try another outlet to check for proper wiring and polarity.
- **Is the power supply cord unplugged?**
Plug into a grounded 3 prong outlet.
- **Has a household fuse been blown or has the circuit breaker been tripped?**
Replace the fuse or reset the circuit.
- **Is the main or regulator gas shutoff valve in the off position?**
See Installation Instructions.
- **Is the range properly connected to the gas supply?**
Contact a trained repair specialist or see Installation Instructions.

Surface burners will not operate

- **Is this the first time the surface burners have been used?**
Turn on any one of the surface burner knobs to release air from the gas lines.
- **On some models, is the Cooktop Lockout set?**
See "Cooktop Lockout" section.
- **Is the control knob set correctly?**
Push in knob before turning to a setting.
- **Are the burner ports clogged?**
On sealed burner models, see "Sealed Surface Burners" section.
On open burner models, see "Open Burners" section.

Surface burner flames are uneven, yellow and/or noisy

- **Are the burner ports clogged?**
On sealed burner models, see "Sealed Surface Burners" section.
On open burner models, see "Open Burners" section.
- **On models with caps, are the burner caps positioned properly?**
See "Sealed Surface Burners" section.
- **Is the burner damaged?**
On models with caps, look for a warped cap. If cap will spin freely on a flat surface, painted side down, the cap is warped. Switch cap with a different surface burner to check for further warping. Contact a trained repair specialist.
- **Is propane gas being used?**
The appliance may have been converted improperly. Contact a trained repair specialist.

Surface burner makes popping noises

- **Is the burner wet?**
Let it dry.

Excessive heat around cookware on cooktop

- **Is the cookware the proper size?**
Use cookware about the same size as the surface cooking area, element or surface burner. Cookware should not extend more than 1 in. (2.5 cm) outside the cooking area.

Oven will not operate

- **Is the power outlet properly wired and polarized?**
Try another outlet to check for proper wiring and polarity.
- **Is this the first time the oven has been used?**
Turn any one of the surface burner knobs on to release air from the gas lines.
- **Is the electronic oven control set correctly?**
See "Electronic Oven Control" section.
- **On some models, is the Oven Lockout set?**
See "Oven Lockout" section.

Oven makes muffled ticking noise when in use

- This is normal and occurs when the oven burner cycles on and off to hold the set oven temperature.

Oven burner lights, then goes out after 1 minute

- Press OFF/CANCEL, then wait 1 minute before trying again.
- **Is the power outlet properly wired and polarized?**
Try another outlet to check for proper wiring and polarity.

Oven burner flames are yellow or noisy

- **Is propane gas being used?**
The appliance may have been converted improperly. Contact a trained repair specialist.

Oven temperature too high or too low

- **Does the oven temperature calibration need adjustment?**
See "Oven Temperature Control" section.

Display shows messages

- **Is the display showing "PF"?**
There has been a power failure. Press OFF/CANCEL to clear the display. Reset the clock, if needed. See "Clock" section.
- **Is the display showing "F" followed by a number?**
Press OFF/CANCEL to clear the display. If an "F" code reappears, call for service.

Self-Cleaning Cycle will not operate

- **Is the oven door open?**
Close the oven door all the way.
- **Has START/ENTER been pressed?**
Press START/ENTER.
- **Has a delay start been set?**
See "Timed Cooking" section.

Cooktop cooking results not what expected

- **Is the proper cookware being used?**
See "Cookware" section.
- **Is the control knob set to the proper heat level?**
See "Control Knobs" section.
- **Is the appliance level?**
Level the appliance. See the Installation Instructions.

Baking results not what expected

- **Was the oven preheated?**
Wait for oven to preheat before placing food in oven.
- **Are the racks positioned properly?**
See "Positioning Racks and Bakeware" section.
- **Is there proper air circulation around bakeware?**
See "Positioning Racks and Bakeware" section.
- **Is the batter evenly distributed in the pan?**
Check to make sure batter is level in the pan.
- **Is the appliance level?**
Level the appliance. See the Installation Instructions.
- **Are baked items too brown on the bottom?**
Decrease oven temperature 15°F to 25°F (5°C to 15°C).
- **Are crust edges browning early?**
Use aluminum foil to cover the edge of the crust.

Slow baking or roasting

- **Was the oven preheated?**
Wait for oven to preheat before placing food in oven.
- **Is there proper air circulation around bakeware?**
See "Positioning Racks and Bakeware" section.
- **Is the proper length of time being used?**
Increase baking or roasting time.
- **Is the proper temperature set?**
Increase temperature 25°F (15°C).
- **Has the oven door been opened while cooking?**
Oven peeking releases oven heat and can result in longer cooking times.

Get it fixed, at your home or ours!

For repair of major brand appliances **in your own home...**
no matter who made it, no matter who sold it!

1-800-4-MY-HOME® Anytime, day or night
(1-800-469-4663)

www.sears.com

To bring in products such as vacuums, lawn equipment and electronics
for repair, call for the location of your nearest **Sears Parts & Repair Center**

1-800-488-1222 Anytime, day or night

www.sears.com

For the replacement parts, accessories and owner's manuals
that you need to do-it-yourself, call **Sears PartsDirectSM**!

1-800-366-PART 6 a.m. – 11 p.m. CST,
(1-800-366-7278) 7 days a week

www.sears.com/partsdirect

To purchase or inquire about a Sears Service Agreement:

1-800-827-6655

7 a.m. – 5 p.m. CST, Mon. – Sat.

Para pedir servicio de reparación a domicilio,
y para ordenar piezas con entrega a domicilio:

1-888-SU-HOGARSM
(1-888-784-6427)

Au Canada pour service en français:

1-877-LE-FOYERSM
(1-877-533-6937)

