

# Panasonic®

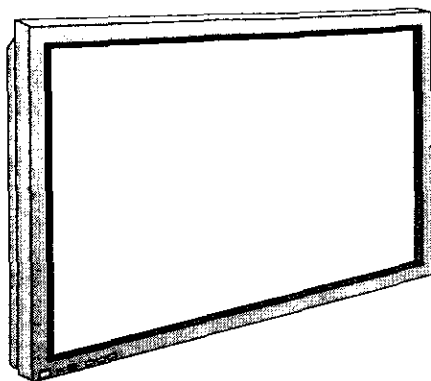

## Wide Plasma Display Operating Instructions

Model No.

# TH-42PW3



**For assistance, please call : 1-888-VIEW-PTV(843-9788)**

or send e-mail to : [consumerproducts@panasonic.com](mailto:consumerproducts@panasonic.com)

or visit us at [www.panasonic.co.jp/global/](http://www.panasonic.co.jp/global/)

(U.S.A)

**For assistance, please call : 787-750-4300**

(Puerto Rico)

**For assistance, please call : 1-800-561-5505**

or visit us at [www.panasonic.co.jp/global/](http://www.panasonic.co.jp/global/)

(Canada)

Before connecting, operating or adjusting this product, please read these instructions completely. Please keep this manual for future reference.

**English**

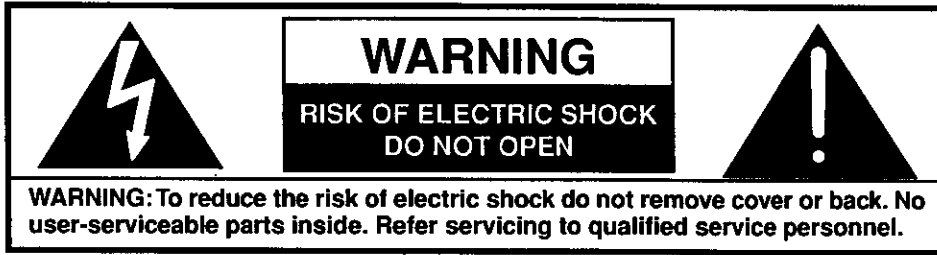

The lightning flash with arrow-head within a triangle is intended to tell the user that parts inside the product are a risk of electric shock to persons.



The exclamation point within a triangle is intended to tell the user that important operating and servicing instructions are in the papers with the appliance.

**WARNING:** To prevent damage which may result in fire or shock hazard, do not expose this appliance to rain or moisture.

**WARNING:** 1) To prevent electric shock, do not remove cover. No user serviceable parts inside. Refer servicing to qualified service personnel.  
2) Do not remove the grounding pin on the power plug. This apparatus is equipped with a three pin grounding-type power plug. This plug will only fit a grounding-type power outlet. This is a safety feature. If you are unable to insert the plug into the outlet, contact an electrician. Do not defeat the purpose of the grounding plug.

## Important Safety Instructions

### Read Instructions

All the safety and operating instructions shall be read before the appliance is operated.

### Retain Instructions

The safety and operating instructions shall be retained for future reference.

### Heed Warnings

All warnings on the appliance and in the operating instructions shall be adhered to.

### Follow Instructions

All operating and use instructions shall be followed.

### Attachments

Do not use attachments/accessories not recommended by the product manufacturer as they may cause hazards.

### Grounding or Polarization

This product may be equipped with either a polarized 2-wire AC line plug (a plug having one blade wider than the other) or a 3-wire grounding-type plug, a plug having a third (grounding) pin.

The 2-wire polarized plug will fit into the power outlet only one way. This is a safety feature. If you are unable to insert the plug fully into the outlet, try reversing the plug. If the plug shall still fail to fit, contact your electrician to replace your obsolete outlet. Do not defeat the safety purpose of the polarized plug. The 3-wire grounding-type plug will fit into a grounding type power outlet.

This is a safety feature. If you are unable to insert the plug into the outlet, contact your electrician to replace your obsolete outlet. Do not defeat the safety purpose of the grounding type plug.

### Accessories

Do not place this product on an unstable cart, stand, pedestal, bracket, or table. The product may fall, causing serious injury to a child or adult, and serious damage to the appliance. Use only with a cart, stand, pedestal, bracket, or table recommended by the manufacturer, or sold with the product.

An appliance and cart combination shall be moved with care. Quick stops, excessive force, and uneven surfaces may cause the appliance and cart combination to overturn.



# Important Safety Instructions

---

## Power Sources

This product shall be operated only from the type of power source indicated on the marking label. If you are not sure of the type of power supply to your home, consult your appliance dealer or local power company. Unplug this apparatus during lightning storms or when unused for a long period of time.

## Power-Cord Protection

Power-supply cords shall be routed so that they are not likely to be walked on or pinched by items placed upon or against them, paying particular attention to cords at plugs, convenience receptacles, and the point where they exit from the appliance.

## Overloading

Do not overload wall outlets and extension cords as this can result in a risk of fire or electric shock.

## Object and Liquid Entry

Never push objects of any kind into this product through openings as they may touch dangerous voltage points or short-out parts that could result in a fire or electric shock. Never spill liquid of any kind on the product.

## Servicing

Do not attempt to service this product yourself as opening or removing covers may expose you to dangerous voltage or other hazards. Refer all servicing to qualified service personnel.

## Replacement Parts

When replacement parts are required, be sure the service technician has used replacement parts specified by the manufacturer or have the same characteristics as the original part. Unauthorized substitutions may result in fire, electric shock or other hazards.

## Safety Check

Upon completion of any service or repairs to this product, ask the service technician to perform safety checks to determine that the product is in proper operating condition.

## Damage Requiring Service

Unplug this product from the wall outlet and refer servicing to qualified service personnel under the following conditions:

- a. When the power-supply cord or plug is damaged.
- b. If liquid has been spilled, or objects have fallen into the product.
- c. If the product does not operate normally by following the operating instructions. Adjust only those controls that are covered by the operating instructions as an improper adjustment of other controls may result in damage and will often require extensive work by a qualified technician to restore the product to its normal operation.
- d. If the product has been dropped or the cabinet has been damaged.
- e. When the product exhibits a distinct change in performance - this indicates a need for service.
- f. If the product has been exposed to rain or water.

## Cleaning

Unplug this product from the wall outlet before cleaning. Do not use liquid cleaners or aerosol cleaners. Use a damp cloth for cleaning.

## Water and Moisture

Do not use this product near water - for example, near a bath tub, wash bowl, kitchen sink, or laundry tub, in a wet basement, or near a swimming pool, and the like.

## Ventilation

Slots and openings in the cabinet are provided for ventilation and to ensure reliable operation of the product and to protect it from overheating, and these openings must not be blocked or covered. The openings shall never be blocked by placing the product on a bed, sofa, rug, or other similar surface. This product shall never be placed near or over a radiator or heat register. This product shall not be placed in a built-in installation such as a rack unless proper ventilation is provided or the manufacturer's instructions have been adhered to.

# *Dear Panasonic Customer*

*Welcome to the Panasonic family of customers. We hope that you will have many years of enjoyment from your new Wide Plasma Display.*

*To obtain maximum benefit from your set, please read these Instructions before making any adjustments, and retain them for future reference.*

*Retain your purchase receipt also, and note down the model number and serial number of your set in the space provided on the rear cover of these instructions.*

<b>For assistance, please call : 1-888-VIEW-PTV(843-9788)</b> or send e-mail to : <a href="mailto:consumerproducts@panasonic.com">consumerproducts@panasonic.com</a> or visit us at <a href="http://www.panasonic.co.jp/global/">www.panasonic.co.jp/global/</a> (U.S.A)
<b>For assistance, please call : 787-750-4300</b> (Puerto Rico)
<b>For assistance, please call : 1-800-561-5505</b> or visit us at <a href="http://www.panasonic.co.jp/global/">www.panasonic.co.jp/global/</a> (Canada)

## **Trademark Credits**

- VGA is a trademark of International Business Machines Corporation.
- Macintosh is a registered trademark of Apple Computer, USA.
- S-VGA is a registered trademark of the Video Electronics Standard Association.

Even if no special notation has been made of company or product trademarks, these trademarks have been fully respected.

# Table of Contents

<b>Important Safety Instructions</b> .....	2	<b>ASPECT Controls</b> .....	22
<b>FCC STATEMENT</b> .....	6	<b>Adjusting PICTURE POS./SIZE</b> .....	24
<b>Safety Precautions</b> .....	7	<b>SOUND Adjustment</b> .....	26
<b>Accessories</b> .....	9	<b>MUTE</b> .....	26
Accessories Supplied .....	9	<b>SURROUND Controls</b> .....	27
Optional Accessories .....	9	<b>PICTURE Adjustments</b> .....	28
<b>Remote Control Batteries</b> .....	10	<b>SET UP for Input Signals</b> .....	30
<b>Basic Controls</b> .....	11	<b>COMPONENT/RGB IN SELECT</b> .....	30
<b>Connections</b> .....	12	Adjusting unnatural video images	
How to connect the speakers .....	13	(3D Y/C FILTER) .....	30
How to connect the AV Input Terminals .....	13	<b>COLOR SYSTEM / Panasonic AUTO</b> .....	31
How to connect the TUNER Input Terminals .....	14	[SYNC] .....	32
How to connect the COMPONENT/RGB Input Terminals ....	15	[PULL IN RANGE] .....	32
How to connect the PC Input Terminals .....	16	[CLAMP POSITION] .....	32
How to connect the SERIAL Terminals .....	17	[H-FREQ. (kHz)/V-FREQ. (Hz)] .....	32
<b>Power ON/OFF and Input Signal Selection</b> .....	18	<b>Troubleshooting</b> .....	33
Power ON/OFF .....	18	<b>Specifications</b> .....	34
Select the Input Signal .....	19		
<b>On-Screen Menu Display from Remote Control</b> .....	20		
Selecting the On-Screen Menu Language .....	21		

# FCC STATEMENT

## FCC STATEMENT

This equipment has been tested and found to comply with the limits for a Class B digital device, pursuant to part 15 of the FCC Rules. These limits are designed to provide reasonable protection against harmful interference in a residential installation. This equipment generated, uses, and can radiate radio frequency energy and, if not installed and used in accordance with the instructions, may cause harmful interference to radio communications. However, there is no guarantee that interference will not occur in a particular installation. If this equipment does cause harmful interference to radio or television reception, which can be determined by turning the equipment off and on, the user is encouraged to try to correct the interference by one or more of the following measures:

- Reorient or relocate the receiving antenna.
- Increase the separation between the equipment and receiver.
- Connect the equipment into an outlet on a circuit different from that to which the receiver is connected.
- Consult the dealer or an experienced radio/TV technician for help.

### **FCC CAUTION:**

Pursuant to 47CFR, Part 15.21 of the FCC rules, any changes or modifications to this monitor not expressly approved by Matsushita Electric Corporation of America could cause harmful interference and would void the user's authority to operate this device.

### **FCC Declaration of Conformity**

Responsible Party:

Matsushita Electric Corporation of America  
One Panasonic Way Secaucus, NJ 07094  
1-800-528-8601

This device complies with Part 15 of the FCC Rules. Operation is subject to the following two conditions: (1) This device may not cause harmful interference, and (2) this device must accept any interference received, including interference that may cause undesired operation.

### **CANADIAN NOTICE:**

This Class B digital apparatus complies with Canadian ICES-003.

### **Attach the ferrite core:**

The ferrite cores provided as a supplied accessory must be used when connecting this Wide Plasma Display to video equipment. (see page 13 and 16)

# Safety Precautions

## **WARNING**

### **Set up**

**Do not place the Wide Plasma Display on sloped or unstable surfaces.**

- The Wide Plasma Display may fall off or tip over.

**Do not place any objects on top of the Wide Plasma Display.**

- If water spills onto the Wide Plasma Display or foreign objects get inside it, a short-circuit may occur which could result in fire or electric shock. If any foreign objects get inside the Wide Plasma Display, please consult an Authorized Service Center.

**Do not cover the ventilation holes.**

- Doing so may cause the Wide Plasma Display to overheat, which can cause fire or damage to the Wide Plasma Display.

**If using the pedestal (optional accessory), leave a space of 3 15/16" (10 cm) or more at the top, left and right, 2 3/8" (6 cm) or more at the bottom, and 2 3/4" (7 cm) or more at the rear. If using some other setting-up method, leave a space of 3 15/16" (10 cm) or more at the top, bottom, left and right, and 3/4" (1.9 cm) or more at the rear.**

### **AC Power Supply Cord**

**The Wide Plasma Display is designed to operate on 120 V AC, 50/60 Hz.**

**Securely insert the power cord plug as far as it will go.**

- If the plug is not fully inserted, heat may be generated which could cause fire. If the plug is damaged or the wall socket plate is loose, they should not be used.

**Do not handle the power cord plug with wet hands.**

- Doing so may cause electric shocks.

**Do not do anything that might damage the power cable. When disconnecting the power cable, hold the plug, not the cable.**

- Do not make any modifications, place heavy objects on, place near hot objects, heat, bend, twist or forcefully pull the power cable. Doing so may cause damages to the power cable which can cause fire or electric shock. If damage to the cable is suspected, have it repaired at an Authorized Service Center.

**If the Wide Plasma Display is not in use for a long period of time, unplug the power cord from the wall outlet.**

### **If problems occur during use**

**If a problem occurs (such as no picture or no sound), or if smoke or an abnormal odor is detected from the Wide Plasma Display, unplug the power cord immediately.**

- Continuous use of the Display under these conditions might cause fire or permanent damage to the unit. Have the Display evaluated at an Authorized Service Center. Services to the Display by any unauthorized personnel are strongly discouraged due to its high voltage dangerous nature.

**If water or foreign objects get inside the Wide Plasma Display, if the Wide Plasma Display is dropped, or if the cabinet becomes damaged, disconnect the power cord plug immediately.**

- A short may occur, which could cause fire. Contact an Authorized Service Center for any repairs that need to be made.

# Safety Precautions

---

## CAUTION

**This Wide Plasma Display is for use only with the following optional accessories. Use with any other type of optional accessories may cause instability which could result in the possibility of injury.**

(All of the following accessories are manufactured by Matsushita Electric Industrial Co., Ltd.)

- Speakers ..... TY-SP42PWD3W
- Pedestal ..... TY-ST42PT3-K
- Wall stand ..... TY-ST42PW1
- Wall-hanging bracket (angled) ..... TY-WK42PR1

Always be sure to ask a qualified technician to carry out set-up.

### When using the Wide Plasma Display

**Do not bring your hands, face or objects close to the ventilation holes of the Wide Plasma Display.**

- Top of Wide Plasma Display is usually very hot due to the high temperature of exhaust air being released through the ventilation holes. Burns or personal injuries can happen if any body parts are brought too close. Placing any object near the top of the display could also result in heat damages to the object as well as to the Display if its ventilation holes are blocked.

**Be sure to disconnect all cables before moving the Wide Plasma Display.**

- Moving the Display with its cables attached might damage the cables which, in turn, can cause fire or electric shock.

**Disconnect the power plug from the wall outlet as a safety precaution before carrying out any cleaning.**

- Electric shocks can result if this is not done.

**Clean the power cable regularly to prevent it from becoming dusty.**

- Built-up dust on the power cord plug can increase humidity which might damage the insulation and cause fire. Unplug the cord from the wall outlet and clean it with a dry cloth.

## Cleaning and maintenance

**The front of the display panel has been specially treated. Wipe the panel surface gently using only a cleaning cloth or a soft, lint-free cloth.**

- If the surface is particularly dirty, soak a soft, lint-free cloth in a weak detergent solution and then wring the cloth to remove excess liquid. Use this cloth to wipe the surface of the display panel, then wipe it evenly with a dry cloth, of the same type, until the surface is dry.
- Do not scratch or hit the surface of the panel with fingernails or other hard objects. Furthermore, avoid contact with volatile substances such as insect sprays, solvents and thinner, otherwise the quality of the surface may be adversely affected.

**If the cabinet becomes dirty, wipe it with a soft, dry cloth.**

- If the cabinet is particularly dirty, soak the cloth in a weak detergent solution and then wring the cloth dry. Use this cloth to wipe the cabinet, and then wipe it dry with a dry cloth.
- Do not allow any detergent to come into direct contact with the surface of the Wide Plasma Display. If water droplets get inside the unit, operating problems may result.
- Avoid contact with volatile substances such as insect sprays, solvents and thinner, otherwise the quality of the cabinet surface may be adversely affected or the coating may peel off. Furthermore, do not leave it for long periods in contact with articles made from rubber or PVC.

---

### Note:

Do not allow a still picture to be displayed for an extended period, as this can cause a permanent after-image to remain on the Wide Plasma Display.

Examples of still pictures include logos, video games, computer images, teletext and images displayed in 4:3 mode.

---



# Accessories

## Accessories Supplied

Check that you have the Accessories and items shown

Operating Instruction book

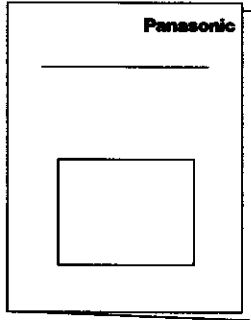

Remote Control Transmitter  
EUR646525

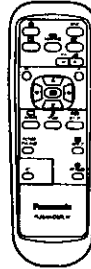

Batteries for the Remote  
Control Transmitter  
(AA(R6) Battery × 2)

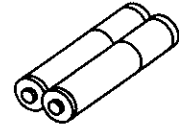

Warranty



RCA/BNC Adapter Plug



Ferrite core × 2  
KRCBC160928B

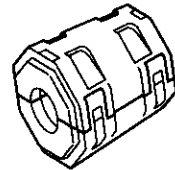

## Optional Accessories

● Speakers  
TY-SP42PWD3W

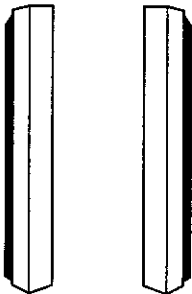

● Pedestal  
TY-ST42PT3-K



● Wall stand  
TY-ST42PW1

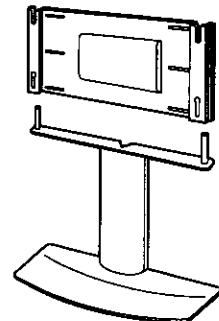

● Wall-hanging bracket  
(angled)  
TY-WK42PR1

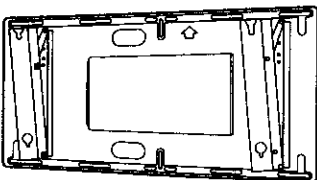

● Connecting Cable  
TY-SCP15C03  
49.2 ft (15 m)



# Remote Control Batteries

## Requires two AA batteries.

1. Turn the transmitter face down.  
Press and slide off the battery cover.
2. Install the batteries as shown in the battery compartment.  
(Polarity + or – must match the markings in the compartment).
3. Replace the cover and slide in reverse until the lock snaps.

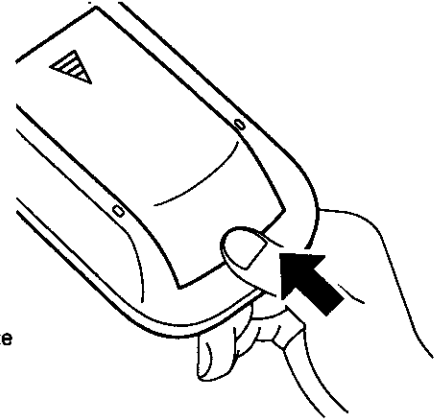
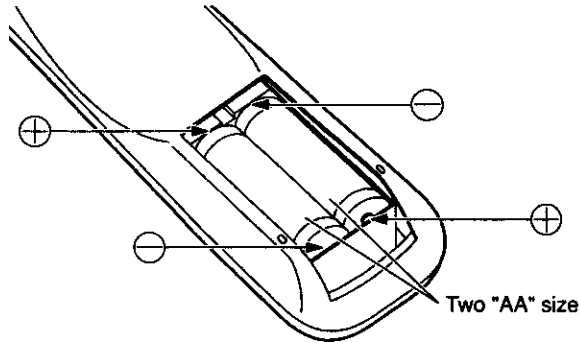
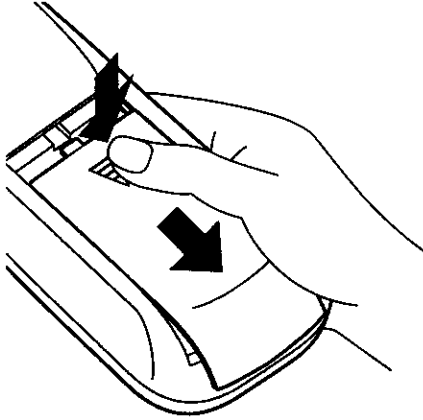

## Helpful Hint:

For frequent remote control users, replace old batteries with Alkaline batteries for longer life.

## ⚠ Precaution on battery use

Incorrect installation can cause battery leakage and corrosion that will damage the remote control transmitter.

### Observe the following precautions:

1. Batteries should always be replaced as a pair. Always use new batteries when replacing the old set.
2. Do not combine a used battery with a new one.
3. Do not mix battery types (example: "Zinc Carbon" with "Alkaline").
4. Do not attempt to charge, short-circuit, disassemble, heat or burn used batteries.
5. Battery replacement is necessary when the remote control acts sporadically or stops operating the Plasma Display.

# Basic Controls

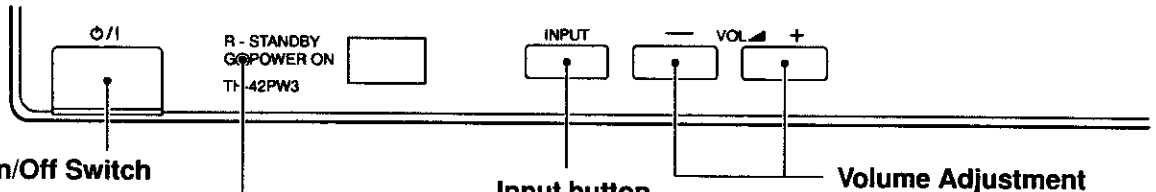

**Main Power On/Off Switch**

**Power Indicator**

The Power Indicator will light.

- Power-OFF .... Indicator not illuminated (The unit will still consume some power as long as the power cord is still inserted into the wall outlet.)
- Stand-by φ .... Red
- Power-ON ..... Green

**Input button**

**(VIDEO (S-VIDEO)/COMPONENT, RGB/PC Mode Selection)**

Push the "INPUT" button to select VIDEO(S-VIDEO)/COMPONENT or RGB/PC input signal modes sequentially.

**Volume Adjustment**

Push the Volume Up "+" or Down "-" button to increase or decrease the sound volume level.

## Stand-by (ON/OFF) button

The Wide Plasma Display must first be plugged into the wall outlet and turn on at the power switch (see page 18).

Push this button to turn the Wide Plasma Display ON, from STANDBY mode. Push it again to turn the Wide Plasma Display OFF to STANDBY mode.

## Status button

Push the "Status" button to display the current system status.

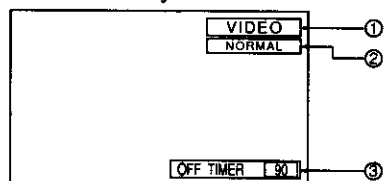

① VIDEO(S-VIDEO)/COMPONENT, RGB/PC mode

② Aspect mode (see page 22)

③ Off timer

The off timer indicator is displayed only when the off timer has been set.

## N button

(see page 25, 26, 28, 29)

## PICTURE button

(see page 28)

## PICTURE POS./SIZE button

(see page 24)

## PC button

Push the "PC" mode selection button to select the PC mode. This button is used to switch directly to PC mode.

## SURROUND button

(see page 27)

## Input button

**(VIDEO(S-VIDEO)/COMPONENT, RGB/PC Mode Selection)**

Press to select VIDEO(S-VIDEO)/COMPONENT or RGB/PC input signal modes sequentially. (see page 19)

**Sound mute On/Off** (see page 26)

## Volume Adjustment

Press the Volume Up "+" or Down "-" button to increase or decrease the sound volume level.

**R button** (see page 21, 24, 26, 30)

## ACTION button

Press to make selections

## POSITION buttons

**SET UP button** (see page 30)

**SOUND button** (see page 26)

## ASPECT button

Press to adjust the aspect. (see page 22)

## OFF TIMER button

The Wide Plasma Display may be preset to switch to stand-by after a fixed period. The setting changes to 30 minutes, 60 minutes, 90 minutes and 0 minutes (off timer cancelled) each time the button is pressed.

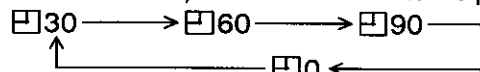

When three minutes remain, "Off timer 3" will flash. The off timer is cancelled if a power interruption occurs.

# Connections

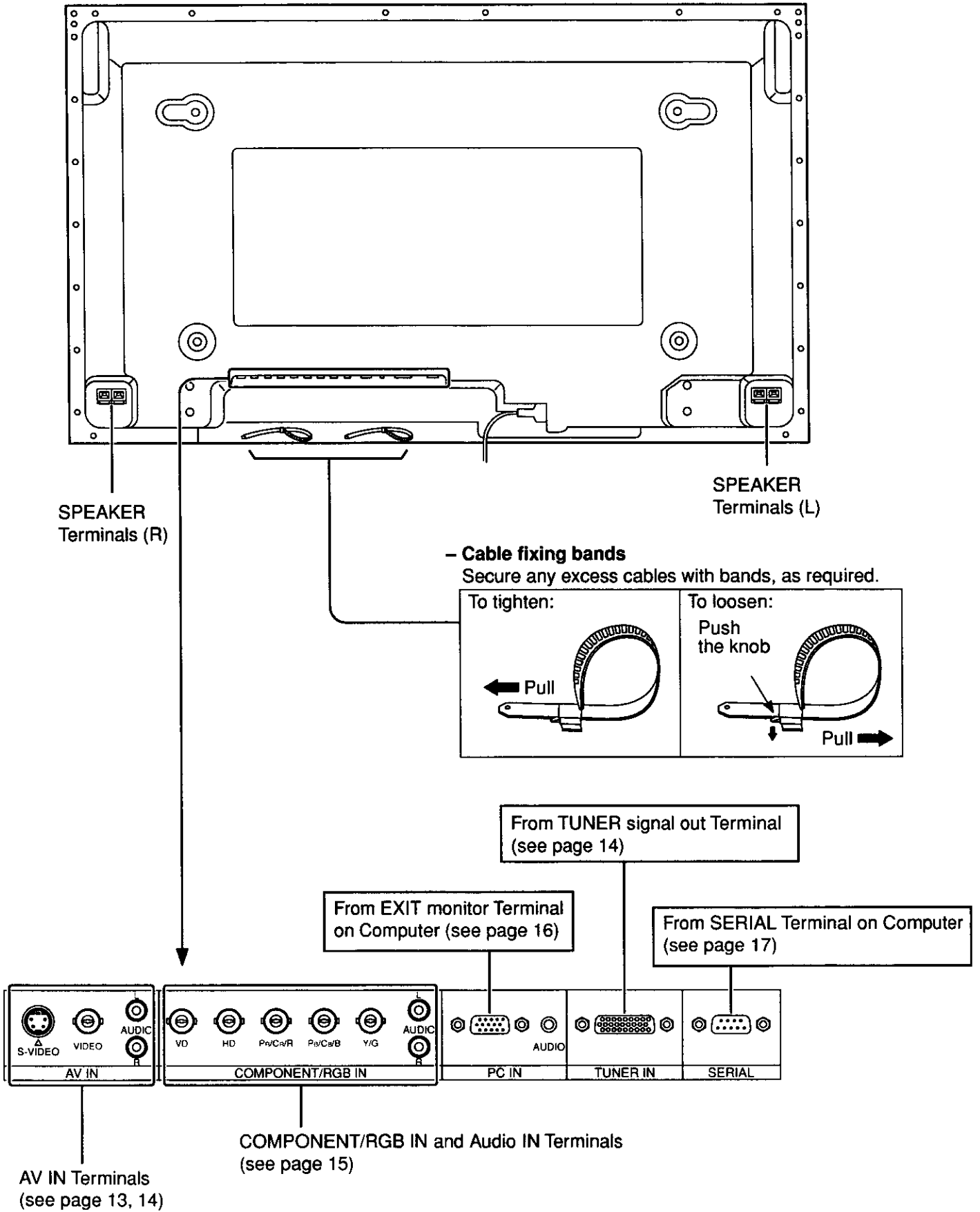

## How to connect the speakers

When connecting the speakers, be sure to use only the optional accessory speakers.  
Refer to the speaker's Installation Manual for details on speaker installation.

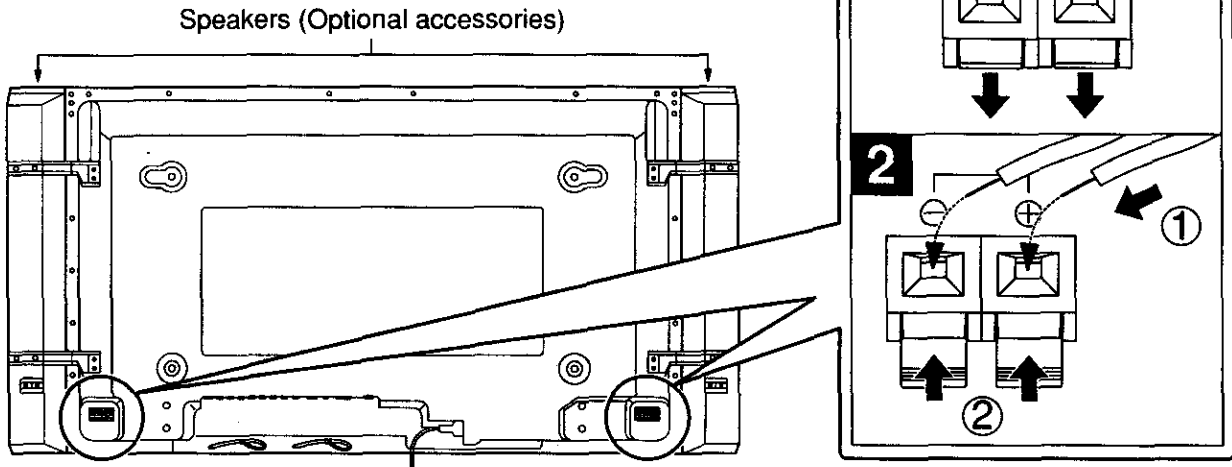

## How to connect the AV Input Terminals

Connect the signal source equipment (see pages 14 to 17).

(Example) When connecting an S-VIDEO VCR

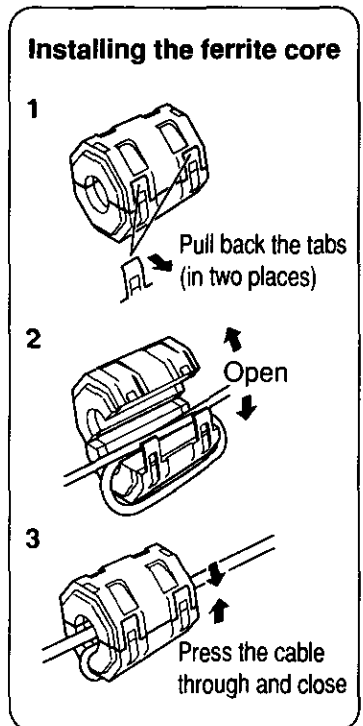
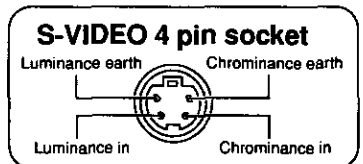
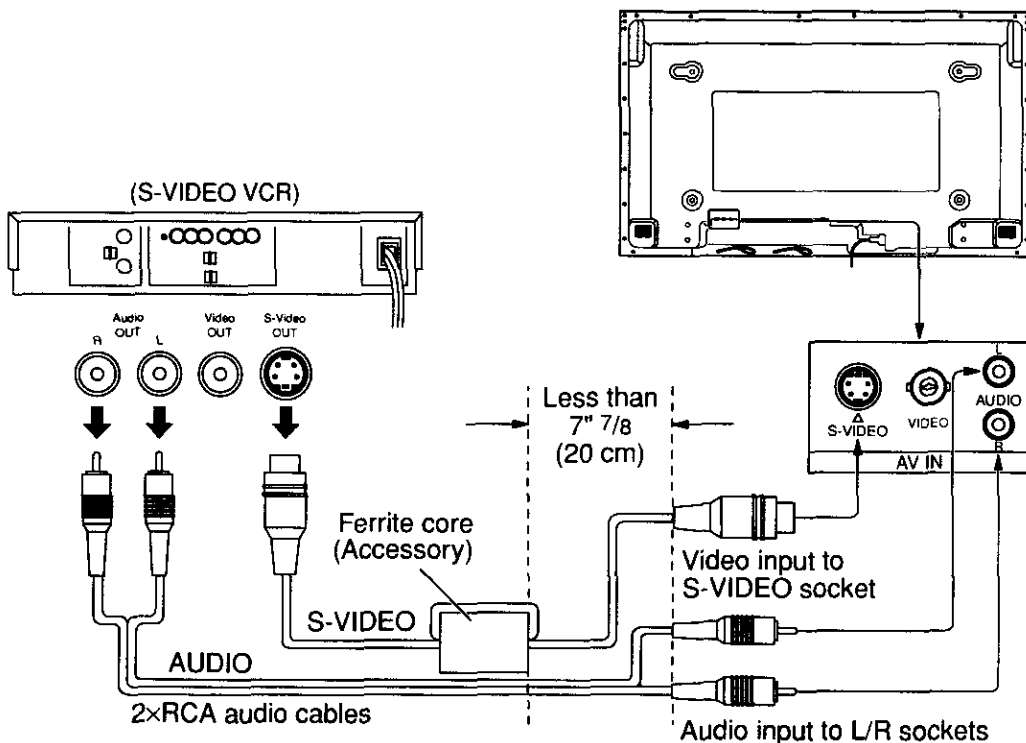

## How to connect the AV Input Terminals

### VIDEO signal connection

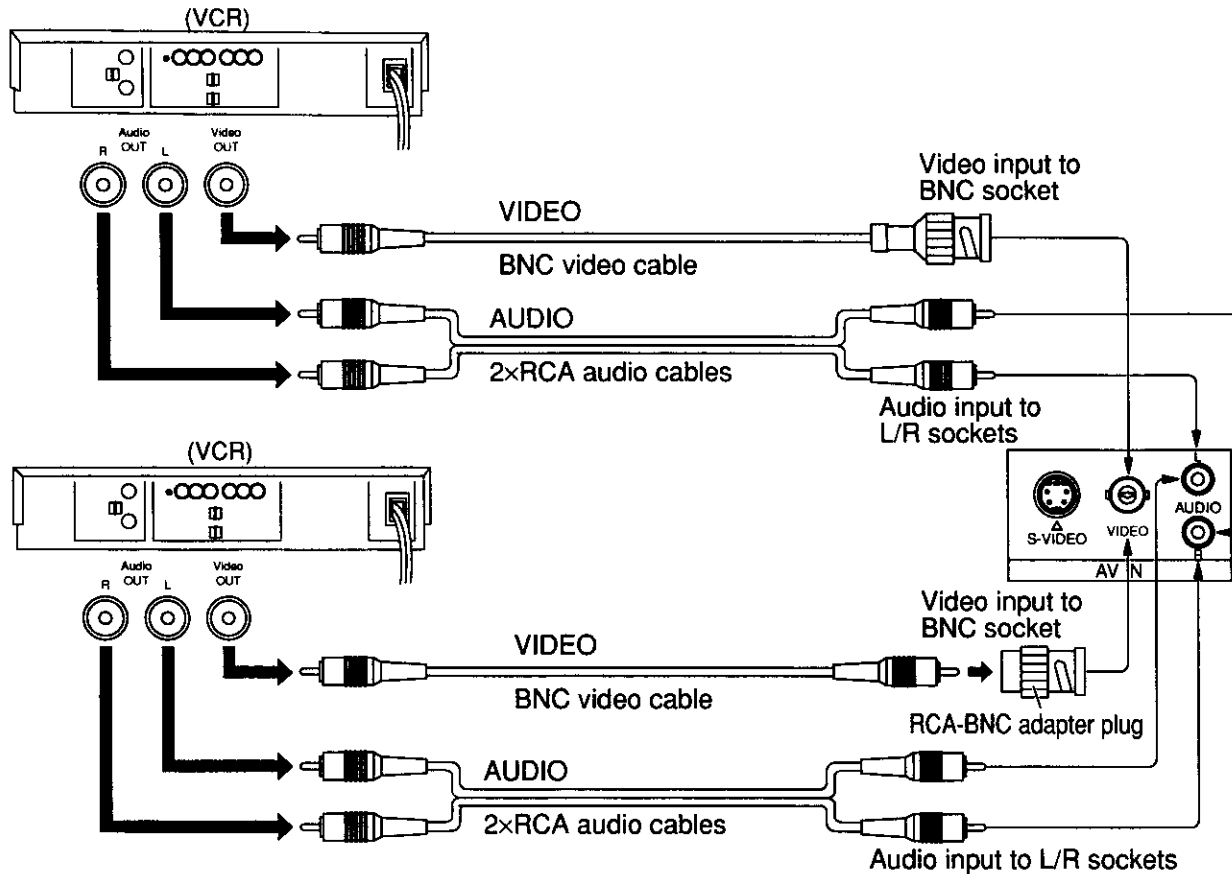

## How to connect the CONTROLLER TUNER Input Terminals

The CONTROLLER TUNER input terminal is reserved for use with future external compatible components.

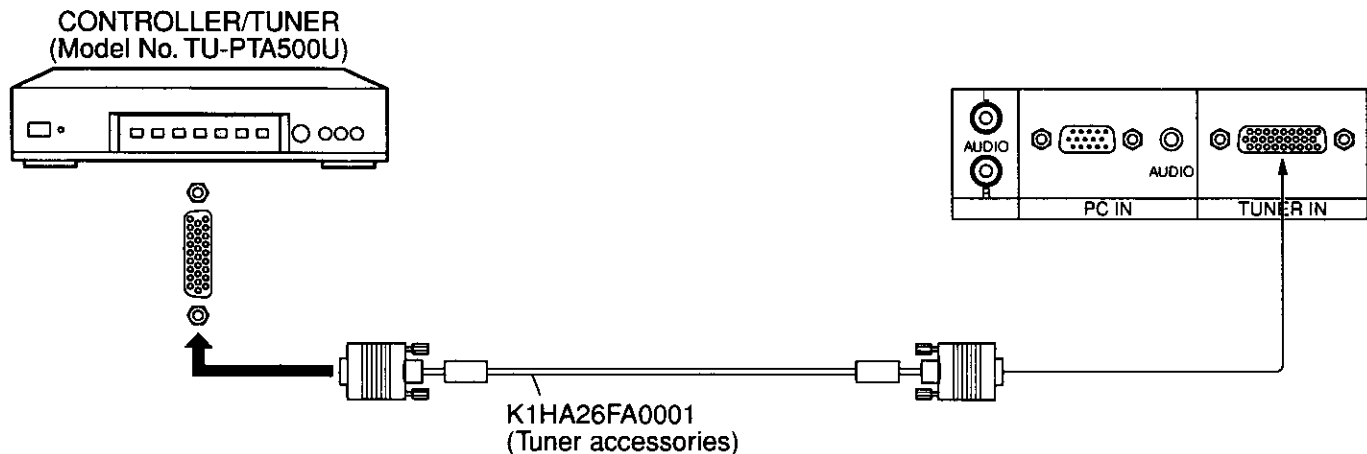

### Notes:

- (1) Additional equipment and cables shown are not supplied with this set.
- (2) When connecting video cables, priority is given to the S-VIDEO cable when the S-VIDEO input terminal and the video input terminal are connected at the same time.
- (3) Install the CONTROLLER/TUNER at least 5.7 inch (40 cm) away from the Wide Plasma Display to avoid interference.
- (4) Be sure the power to the Wide Plasma Display and CONTROLLER/TUNER is OFF before connecting cables.

# How to connect the COMPONENT/RGB Input Terminals

## Component signals (Y, Pb, Pr) connection

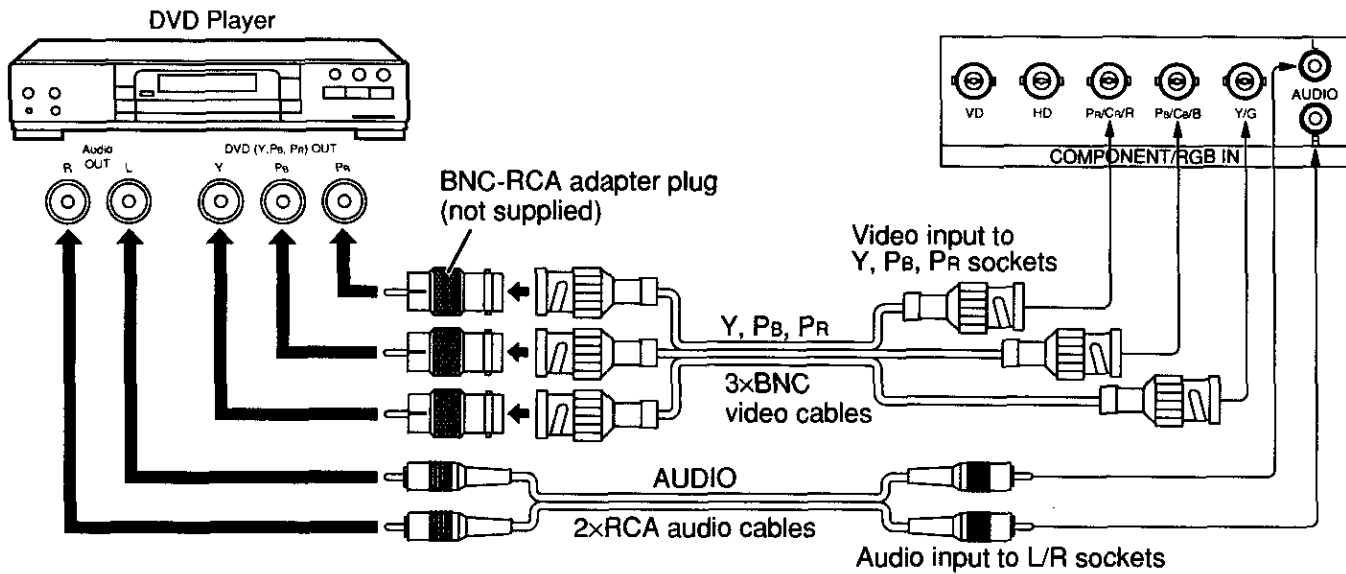

**Notes:**

- (1) Change the "COMPONENT/RGB-IN" setting in the "SET UP" menu to "Y/PB/PR". (see page 30, 32)
- (2) Additional equipment and cables shown are not supplied with this set.

## RGB signal (R, G, B, HD, VD) connection

Example of input signal source

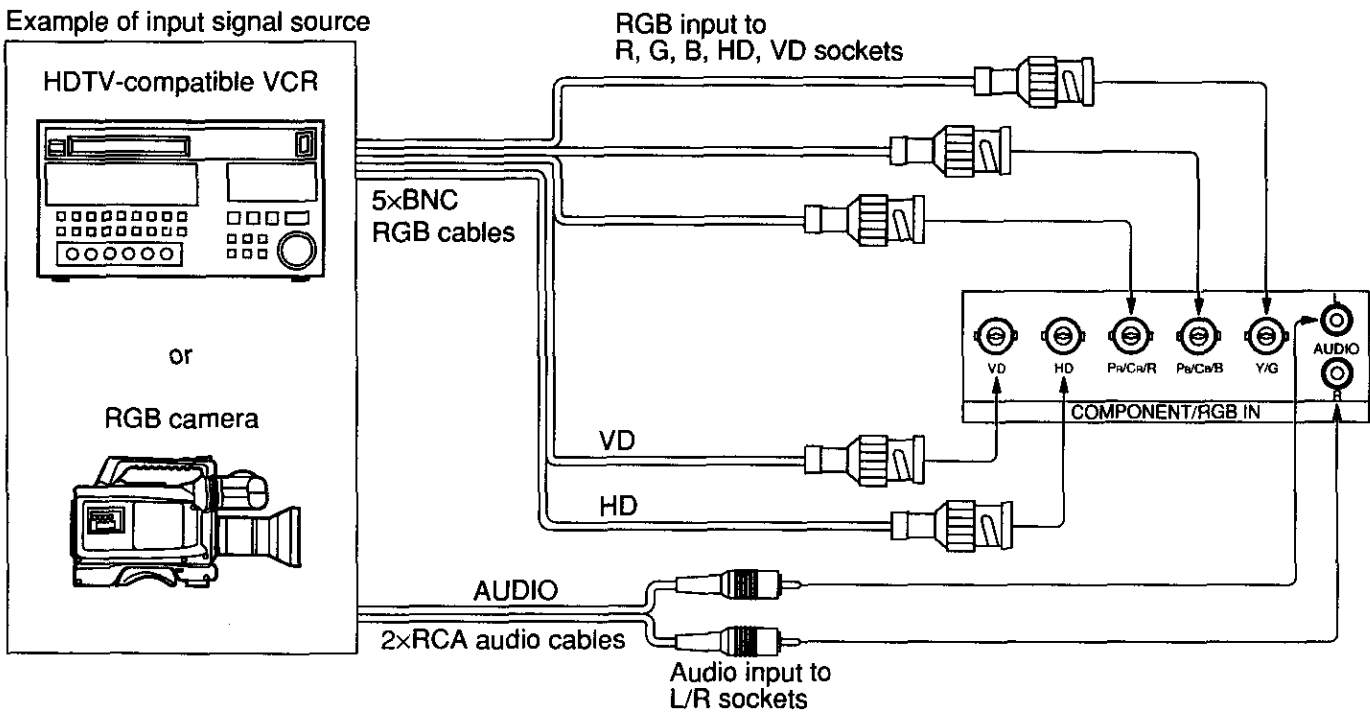

**Notes:**

- (1) Change the "COMPONENT/RGB-IN" setting in the "SET UP" menu to "RGB". (see page 30, 32)
- (2) Additional equipment and cables shown are not supplied with this set.

## How to connect the PC Input Terminals

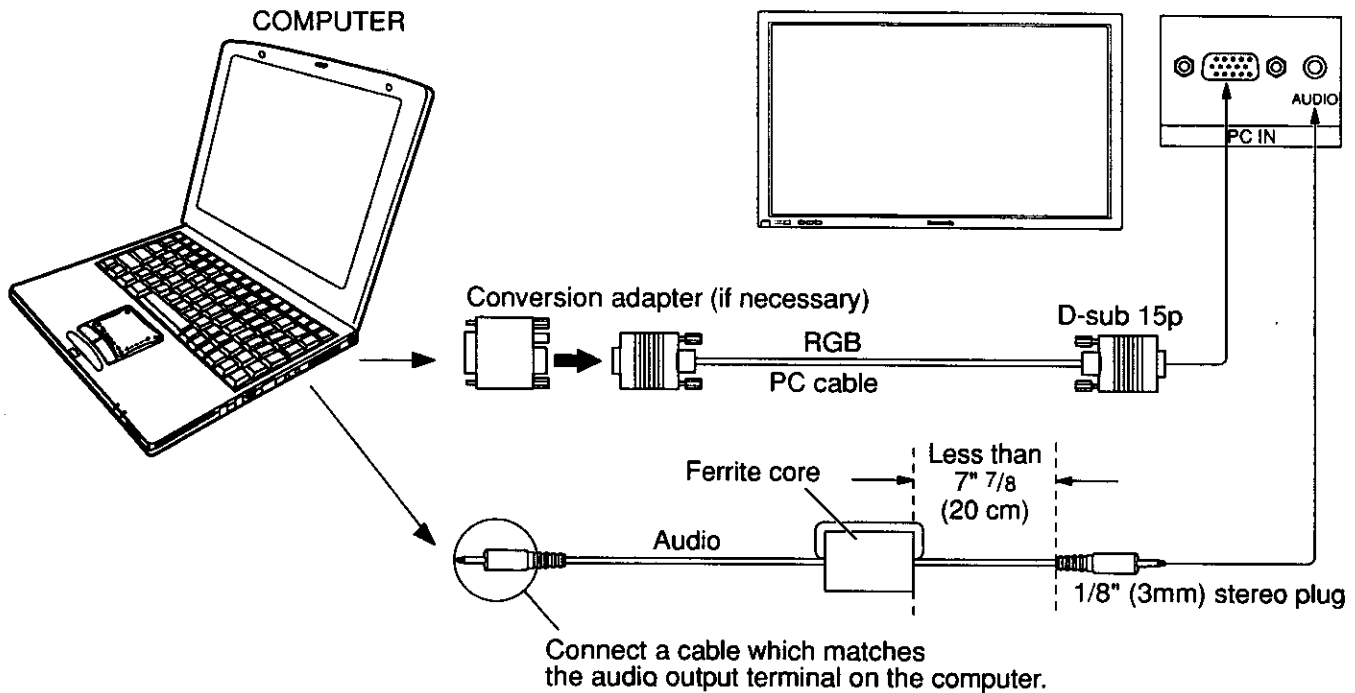

### Notes:

- (1) Computer signals which can be input are those with a horizontal scanning frequency of 15.5 to 110 kHz and vertical scanning frequency of 48 to 120 Hz. (However, signals cannot be displayed if signals exceeding 1200 lines will not be displayed properly.)
- (2) The display resolution is a maximum of 640 × 480 dots when the aspect mode is set to "NORMAL", and 852 × 480 dots when the aspect mode is set to "FULL". If the display resolution exceeds these maximums, it may not be possible to show fine detail with sufficient clarity.
- (3) The PC input terminals are DDC1/2B-compatible. If the computer being connected is not DDC1/2B-compatible, you will need to make setting changes to the computer at the time of connection.
- (4) Some PC models cannot be connected to the set.
- (5) An adapter is required to use the PC cable (D-sub 15P) to connect a Macintosh computer to the set.
- (6) There is no need to use an adapter for computers with DOS/V compatible D-sub 15P terminal.
- (7) The computer shown in the illustration is for example purposes only.
- (8) Additional equipment and cables shown are not supplied with this set.
- (9) Do not set the horizontal and vertical scanning frequencies for PC signals which are above or below the specified frequency range.

### Signal Names for D-sub 15P Connector

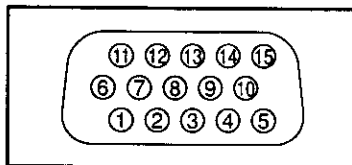

Pin layout for PC input terminal

Pin No.	Signal Name	Pin No.	Signal Name	Pin No.	Signal Name
①	R	⑥	GND (Ground)	⑪	GND (Ground)
②	G	⑦	GND (Ground)	⑫	SDA
③	B	⑧	GND (Ground)	⑬	HD/SYNC
④	GND (Ground)	⑨	NC (not connected)	⑭	VD
⑤	GND (Ground)	⑩	GND (Ground)	⑮	SCL



# How to connect the SERIAL Terminals

The SERIAL terminal is used when the Wide Plasma Display is controlled by a computer.

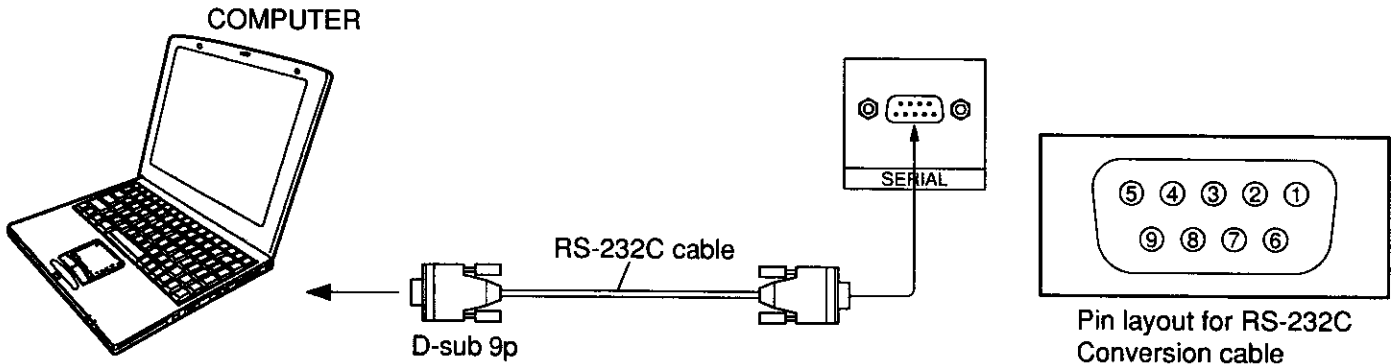

**Notes:**

- (1) Use the RS-232C cable to connect the computer to the Wide Plasma Display.
- (2) The computers shown is for example purposes only.
- (3) Additional equipment and cables shown are not supplied with this set.

The SERIAL terminal conforms to the RS-232C interface specification, so that the Wide Plasma Display can be controlled by a computer which is connected to this terminal.

The computer will require software which allows the sending and receiving of control data which satisfies the conditions given below. Use a computer application such as a programming language to software. Refer to the documentation for the computer application for details.

**Communication parameters**

Signal level	RS-232C compliant
Synchronization method	Asynchronous
Baud rate	9600 bps
Parity	None
Character length	8 bits
Stop bit	1 bit
X parameter	None
S parameter	None

RS-232C Conversion cable	
D-sub 9-pin female	Details
②	R X D
③	T X D
⑤	GND
④	Shorted
⑥	
⑦	Shorted
⑧	
① • ⑨	NC

**Basic format for control data**

The transmission of control data from the computer starts with a STX signal, followed by the command, the parameters, and lastly an ETX signal in that order. If there are no parameters, then the parameter signal does not need to be sent.

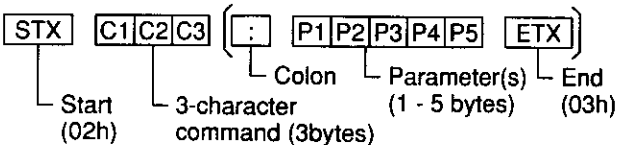

**Notes:**

- (1) If multiple commands are transmitted, be sure to wait for the response for the first command to come from this unit before sending the next command.
- (2) If an incorrect command is sent by mistake, this unit will send an "ER401" command back to the computer.

**Command**

Command	Parameter	Control details
PON	None	Power ON
POF	None	Power OFF
AUU	None	Volume increase
AUD	None	Volume decrease
AMT	None	Mute (toggle)
IIS	None	Input select (toggle)
	VID	AV Mode
	YP1	Component / RGB mode (processed as a Y/Pa/Pb or RGB signals as set by this unit)
DAM	RG1	PC mode
	None	Screen mode select (toggle)
	NORM	NORMAL (4:3)
	ZOOM	ZOOM
	FULL	FULL
	JUST	JUST
	SELF	Panasonic AUTO

# Power ON/OFF and Input Signal Selection

## Power ON/OFF

### Connecting the plug to the Wall Outlet

Push the POWER switch on the Wide Plasma Display to turn the set on POWER-ON

**Power Indicator: Green**

Example: The screen below is displayed for a while after the Wide Plasma Display is turned on. (setting condition is an example.)

When the POWER is turned on for the first time, the LANGUAGE selection screen is displayed.

From the second time on, language selection can be done from the setup menu. (see page 21)

Select the desired language using the ▲ and ▼ keys and press the store (■) button.

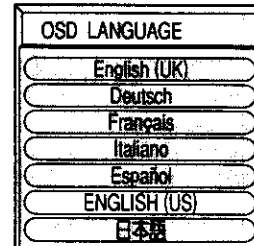

From the second time on, the screen shown below is displayed for a while (setting condition is an example).

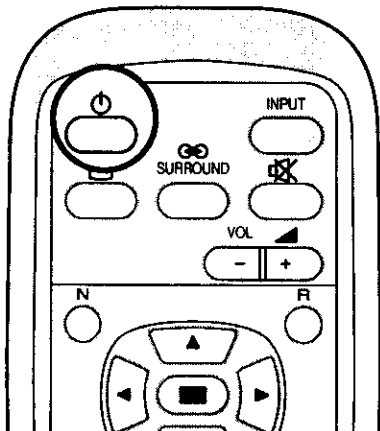
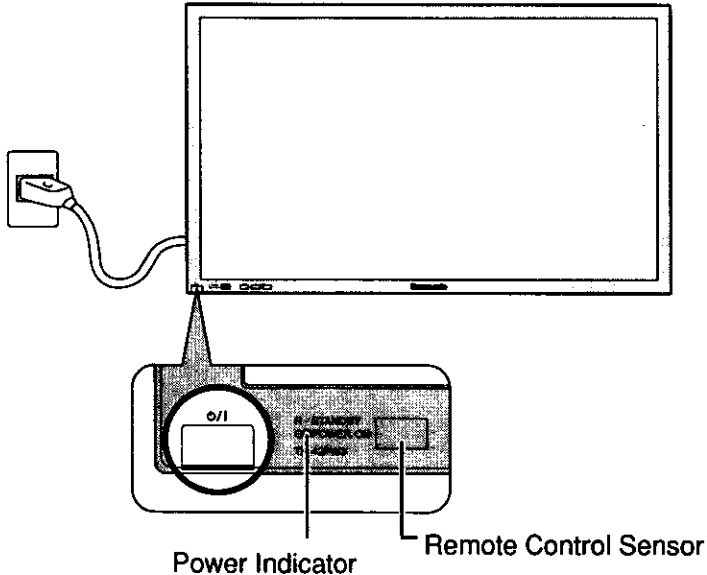
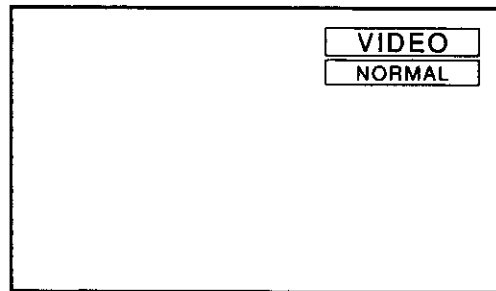

Press the ⏻ button on the remote control to turn the Wide Plasma Display off

**Power Indicator: Red (standby)**

Press the ⏻ button on the remote control to turn the Wide Plasma Display on

**Power Indicator: Green**

To turn the power for the Wide Plasma Display off, press the ⏻ switch on the Wide Plasma Display, when the Wide Plasma Display is on or in standby mode.

## Select the Input Signal

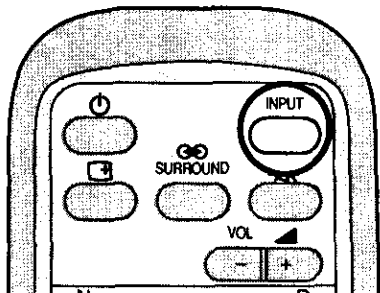
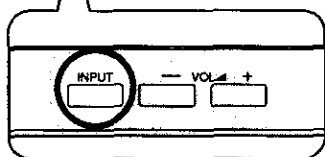
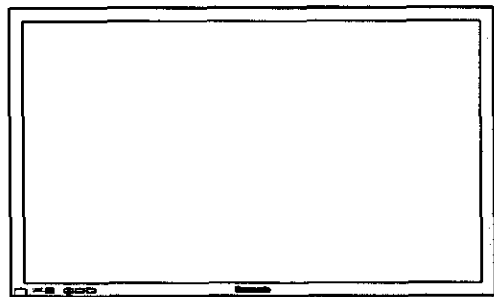

Press the INPUT button to select the input video signal desired from equipment such as a VCR which has been connected to the Wide Plasma Display.

Input signals will change as follows:

For COMPONENT INPUT (see page 30)



For RGB INPUT (see page 30)



# On-Screen Menu Display from Remote Control

To PICTURE adjust menu  
(see page 28)

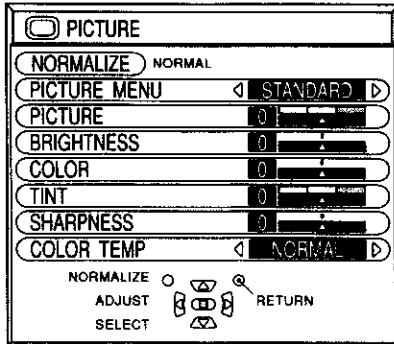

To SOUND adjust menu  
(see page 26)

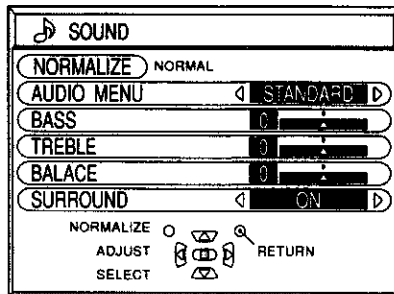

To PICTURE POS./SIZE adjust menu  
(see page 24)

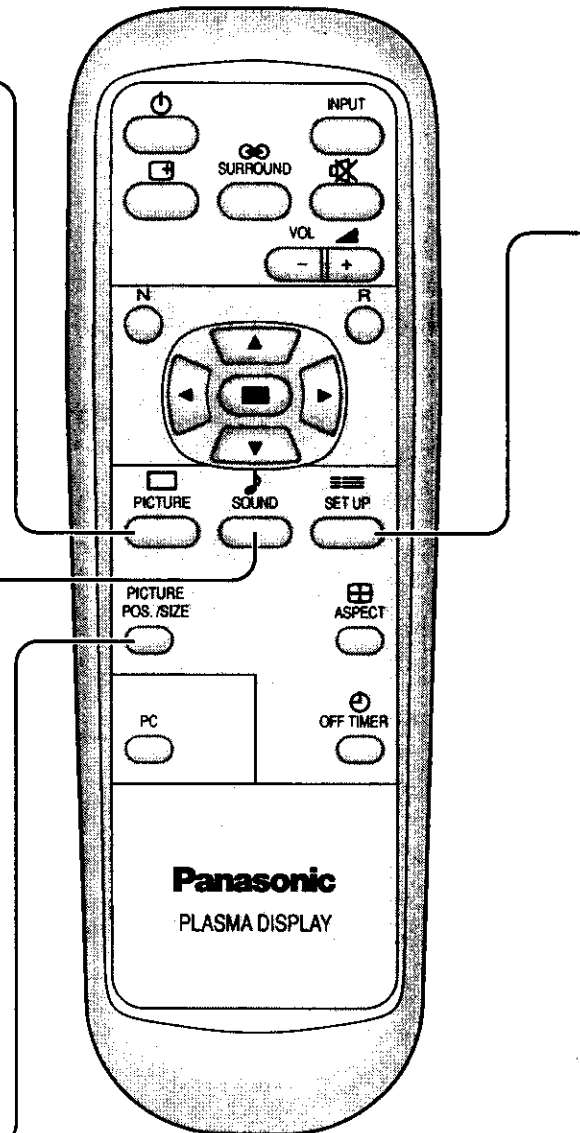
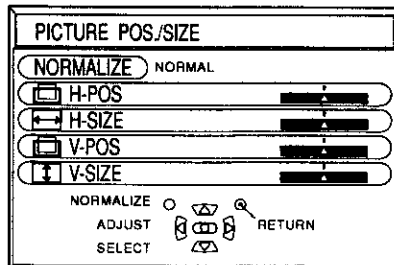

# On-Screen Menu Display from Remote Control

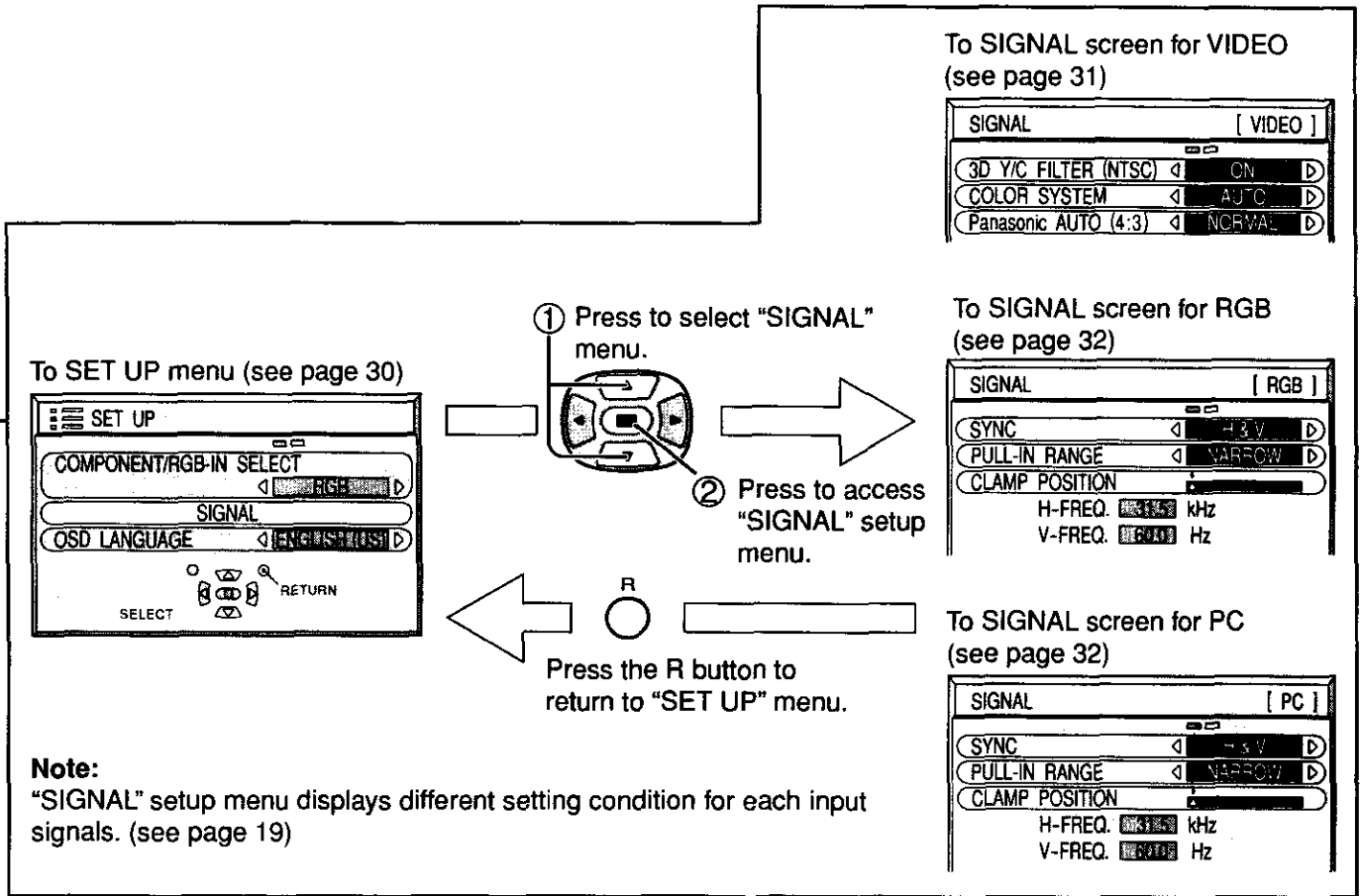

# Selecting the On-Screen Menu Language

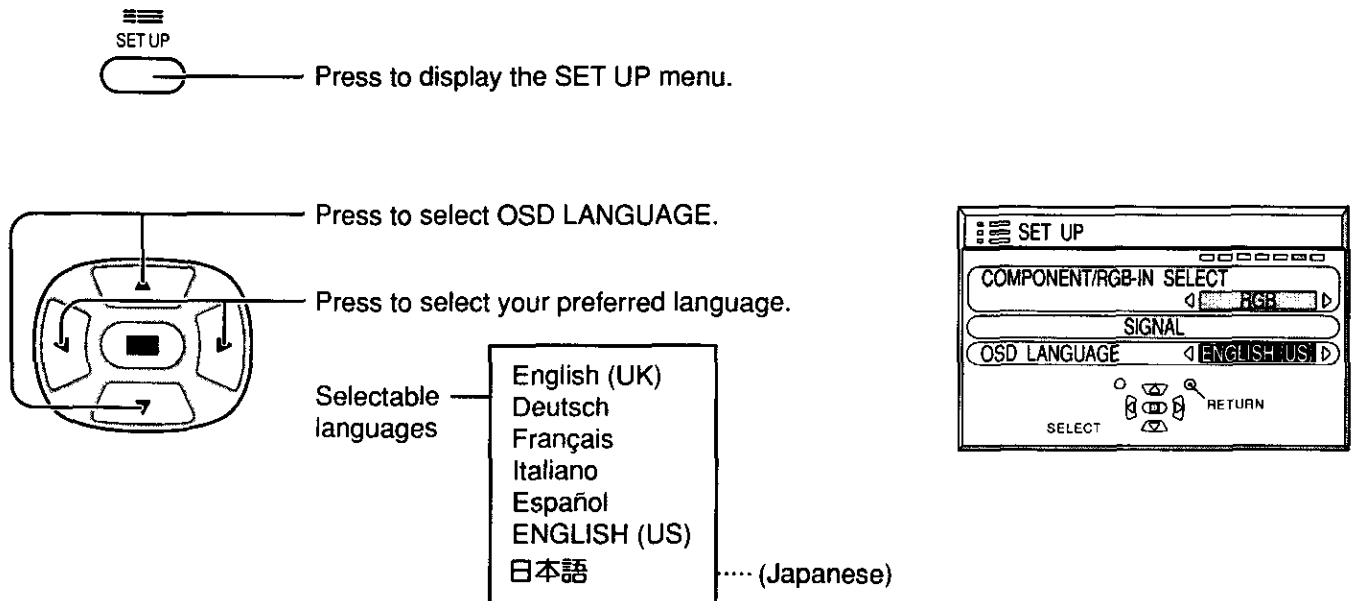

# ASPECT Controls

The Wide Plasma Display will allow you to enjoy viewing the picture at its maximum size, including wide screen cinema format picture.



## ASPECT button

The aspect mode changes each time the ASPECT button is pressed.

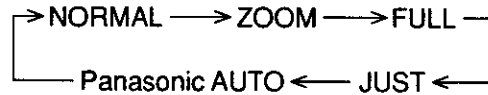

## Notes:

- (1) During RGB and PC input signal modes, the mode switches between "NORMAL" and "FULL" only.
- (2) For a 525p (480p) signal input during "COMPONENT" input signal mode, the mode switches between "ZOOM" and "FULL" only.
- (3) For a 1125i (1080i), 750p (720p) signal input during "COMPONENT" input signal mode, the mode is set to "FULL" mode, and switching is not possible.  
For a 525i (480i), 625i (575i) signal input during "Component" input signal mode, "Panasonic Auto" can not be selected.
- (4) The aspect mode is memorized separately for each input terminal (VIDEO, COMPONENT, RGB and PC).

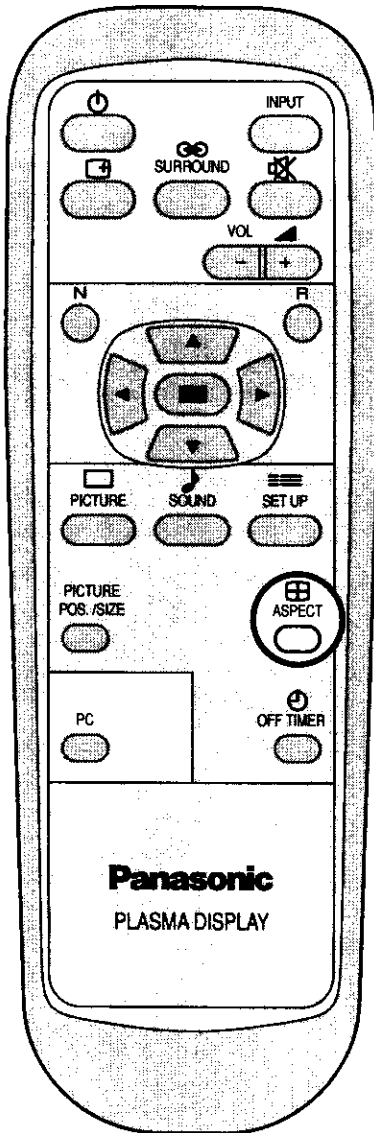

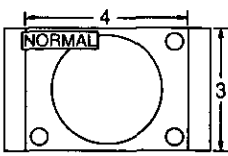
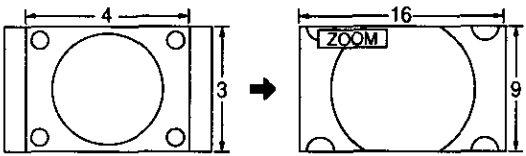
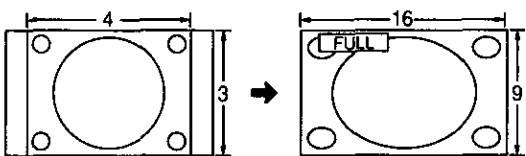
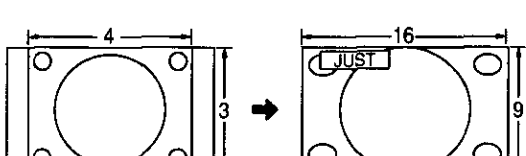
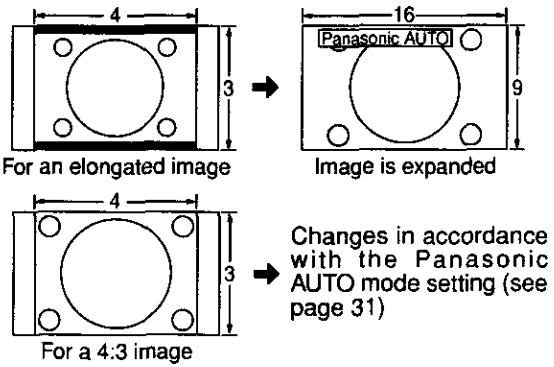

Mode	Picture	Explanation
NORMAL		<p>NORMAL will display a 4:3 picture at its standard 4:3 size.</p>
ZOOM		<p>ZOOM mode magnifies the central section of the picture.</p>
FULL		<p>FULL will display the picture at its maximum size but with slight elongation.</p>
JUST		<p>JUST mode will display a 4:3 picture at its maximum size but with aspect correction applied to the center of the screen so that elongation is only apparent at the left and right edges of the screen. The size of the picture will depend on the original signal.</p>
Panasonic AUTO	 <p>For an elongated image Image is expanded</p> <p>For a 4:3 image</p> <p>Changes in accordance with the Panasonic AUTO mode setting (see page 31)</p>	<p>The display will automatically become enlarged (depending on the picture source), allowing you to view the picture at its maximum size.</p> <p><b>Note:</b> Panasonic AUTO mode is designed to automatically adjust the aspect ratio to handle a mix of 16:9 and 4:3 program material. Certain 4:3 program material, such as stock market data screens, may occasionally cause the image size to change unexpectedly. When viewing such programs, it is recommended that the ASPECT be set to NORMAL.</p>

**Notes:**

- (1) Do not allow 4:3 mode to be displayed for an extended period, as this can cause a permanent after-image to remain on the Plasma Display Panel.
- (2) The S-VIDEO terminal on this set can detect specially encoded signals that are compatible with a wide screen monitor. When a full image from the S-VIDEO terminal of specially encoded video is detected by the set, the screen size is automatically set to FULL mode.

# Adjusting PICTURE POS./SIZE

## Adjusting screen

**1**  **ASPECT**  
 Press to select the screen mode to adjust (see page 23).

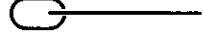
**2**  **PICTURE POS./SIZE**  
 Press to display the PICTURE POS./SIZE menu.

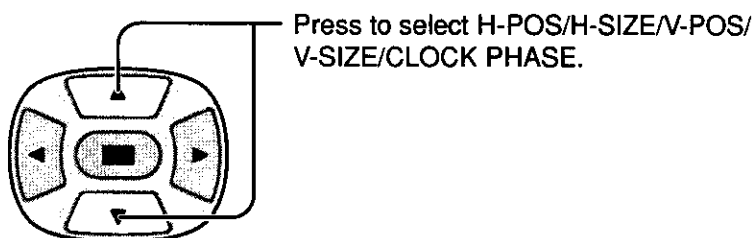

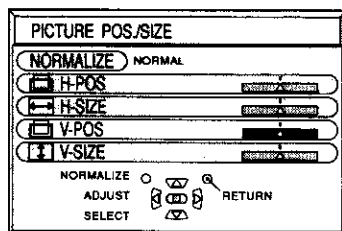

During "VIDEO" and "COMPONENT" input signal modes.

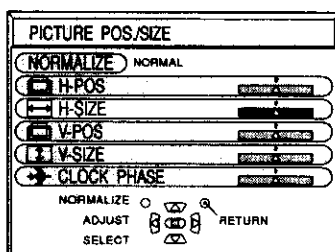

During "RGB" and "PC" input signal modes.

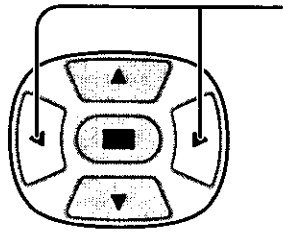

**3**  Press to adjust screen/position (see page 25).

 **R**  
 Press to exit adjust mode.

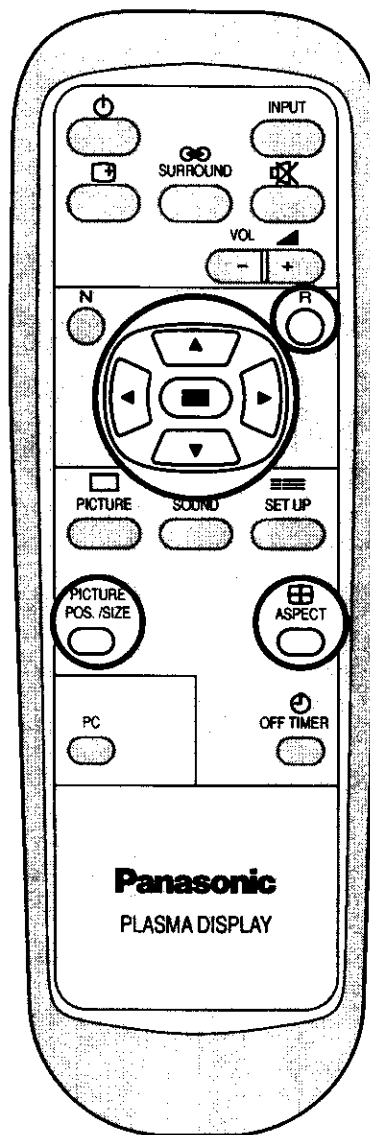

### Notes:

- (1) Adjustment details are memorized separately for different input signal formats (Adjustments for component signals are memorized for 525i (480i), 625i (575i), 525p (480p), 1125i (1080i) and 750p (720p) each, and RGB/PC signals are memorized for each frequency.)
- (2) If a "Cue" or "Rew" signal from a VCR or DVD player is received, the picture position will shift up or down. This picture position movement cannot be controlled by the PICTURE POS./SIZE function.

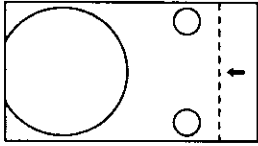
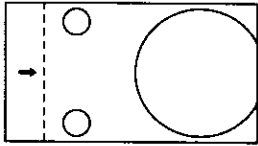
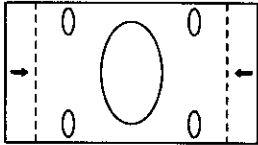
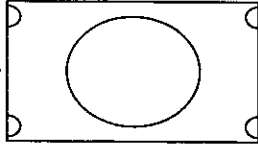
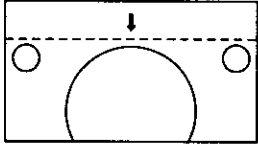
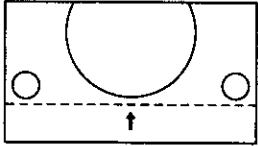
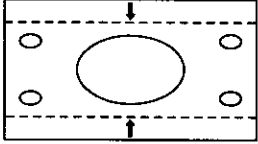
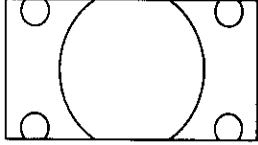

# Adjusting PICTURE POS./SIZE

<p><b>H-POS</b></p>	<p>When the Position Left "◀" button is pressed</p> 	<p>When the Position Right "▶" button is pressed</p> 
<p><b>H-SIZE</b></p>	<p>When the Position Left "◀" button is pressed</p> 	<p>When the Position Right "▶" button is pressed</p> 
<p><b>V-POS</b></p>	<p>When the Position Left "◀" button is pressed</p> 	<p>When the Position Right "▶" button is pressed</p> 
<p><b>V-SIZE</b></p>	<p>When the Position Left "◀" button is pressed</p> 	<p>When the Position Right "▶" button is pressed</p> 
<p><b>CLOCK PHASE (RGB/PC in Mode)</b></p>	<p>Flickering and distortion can be eliminated by using the Position Left "◀" or Right "▶" button to carry out adjustment.</p>	



## Helpful Hint ( / Normalization)

While the PICTURE POS./SIZE display is active, if either the N button on the remote control is pressed at any time or the  (ACTION button) is pressed during "NORMALIZE", then all adjustment values are returned to the factory settings.

# SOUND Adjustment

1 Press the SOUND button to display the SOUND menu.

2 Select to adjust each item.

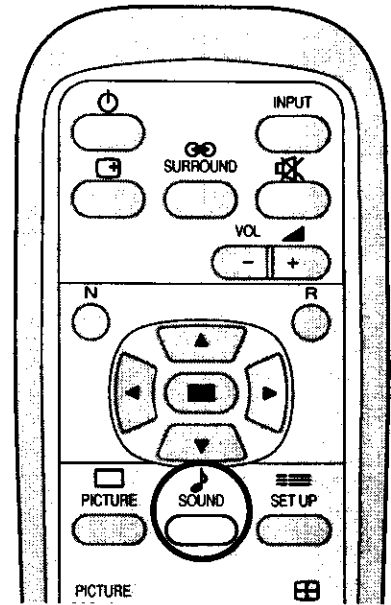
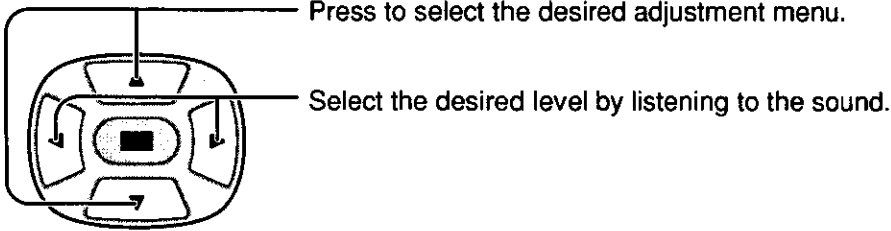

## BASS

Adjusts low sounds

## TREBLE

Adjusts high sounds

## BALANCE

Adjusts left and right volumes

**SURROUND** (see next page)

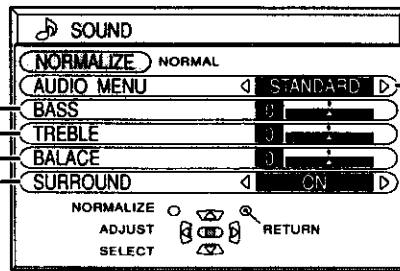

STANDARD

Emits the original sound.



AUTO

Automatically controls proper volume level.

• To end adjustments

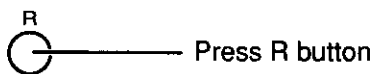

### Note:

Press the SURROUND button to directly turn the surround effect ON and OFF. (see page 27)

## Helpful Hint ( N / NORMALIZE Normalization)

While the "SOUND" menu is displayed, if either the N button on the remote control is pressed at any time or the ACTION button is pressed during "NORMALIZE", then all adjustment values are returned to the factory settings.

## Mute

Useful when answering the phone or receiving unexpected visitors.



Press this button to mute the sound.

Press again to reactivate sound. Sound is also reactivated when power is turned off or volume level is changed.

# SURROUND Controls



## SURROUND Button

The benefits of surround sound are enormous. You can be completely enveloped in sound; just as if you were at a concert hall or cinema.

The surround setting switches on and off each time the SURROUND button is pressed.

ON ← → OFF

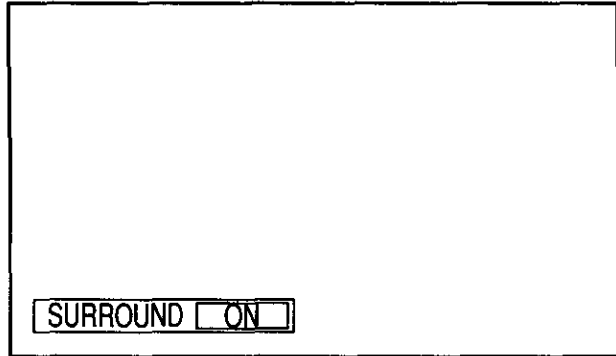

### Note:

The surround settings are memorized separately for each SOUND mode (AUTO, STANDARD).

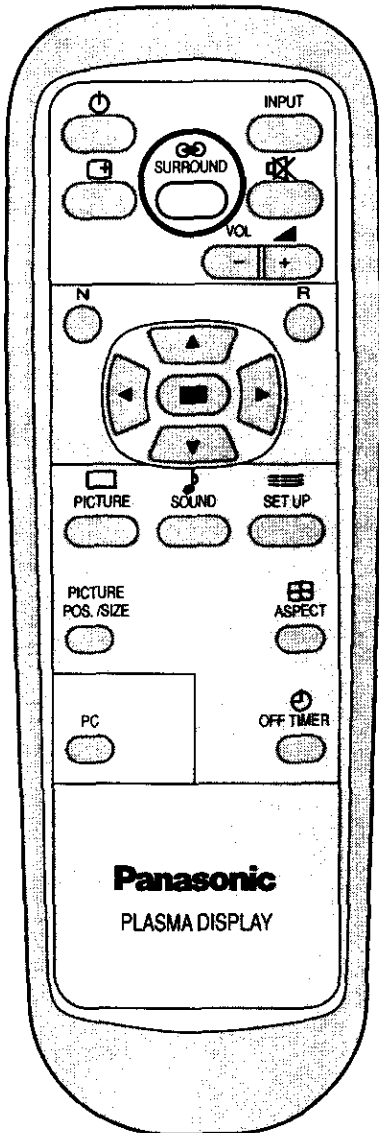

# PICTURE Adjustments

- 1**  Press the PICTURE button on the Remote Control to display the PICTURE menu.

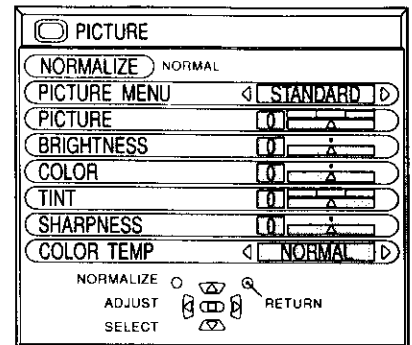

- 2** Select to adjust each item.

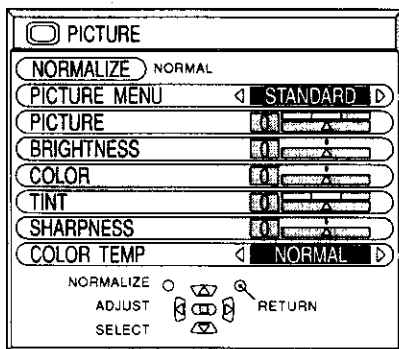
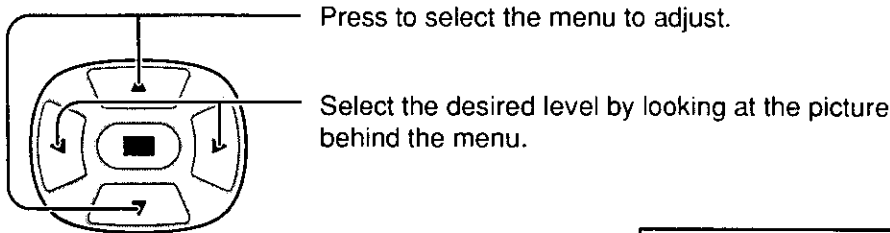

Press the left ◀ or right ▶ button to switch between modes.

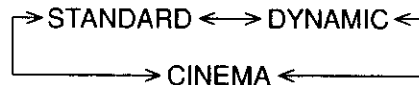

- STANDARD**  
For viewing in standard (evening lighting) environments. This menu selects the normal levels of BRIGHTNESS and PICTURE.
- DYNAMIC**  
For viewing in brighter environments. This menu selects higher than normal levels of BRIGHTNESS and PICTURE.
- CINEMA**  
Ideal for movies.  
• Can be selected for VIDEO/COMPONENT.

**Note:**  
(1) If you would like to change the picture and color of the selected PICTURE menu to something else, adjust using the items in the PICTURE menu. (see page 29)



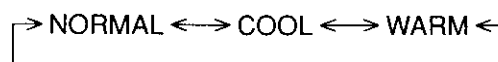







Press the left ◀ or right ▶ button to switch between modes.



## Helpful Hint ( / Normalization )

While the "PICTURE" menu is displayed, if either the N button on the remote control is pressed at any time or the  (ACTION button) is pressed during "NORMALIZE", then all adjustment values are returned to the factory settings.

## PICTURE Adjustments

Item	Effect	Adjustments
PICTURE	  Less      More	Selects the proper brightness and density for the room.
BRIGHTNESS	  Darker      Brighter	Adjusts for easier viewing of dark pictures such as night scenes and black hair.
COLOR	  Less      More	Adjusts slightly to a lighter color.
TINT (NTSC only)	  Reddish      Greenish	Adjust for nice skin color.
SHARPNESS	  Less      More	Displays a sharp image.

### Notes:

- (1) "COLOR", "TINT" and "SHARPNESS" settings cannot be adjusted for "RGB" and "PC" input signal modes.
- (2) You can change the level of each function (CONTRAST, BRIGHTNESS, COLOR, TINT, SHARPNESS) for each PICTURE menu.
- (3) The setting details for normal, dynamic and cinema respectively are memorized separately for each input mode (VIDEO, COMPONENT, RGB and PC).
- (4) The "TINT" setting can be adjusted for NTSC signal only.

### Note:

There is little change when PICTURE is increased with a bright picture or reduced with a dark picture.



## Helpful Hint ( / Normalization)

While the "PICTURE" menu is displayed, if either the N button on the remote control is pressed at any time or the  (ACTION button) is pressed during "NORMALIZE", then all adjustment values are returned to the factory settings.

# SET UP for Input Signals

## COMPONENT/RGB IN SELECT

Select to match the signals from the source connected to the COMPONENT/RGB input terminals.

Y, PB, PR signals ⇔ "COMPONENT"

R, G, B, HD, VD signals ⇔ "RGB"

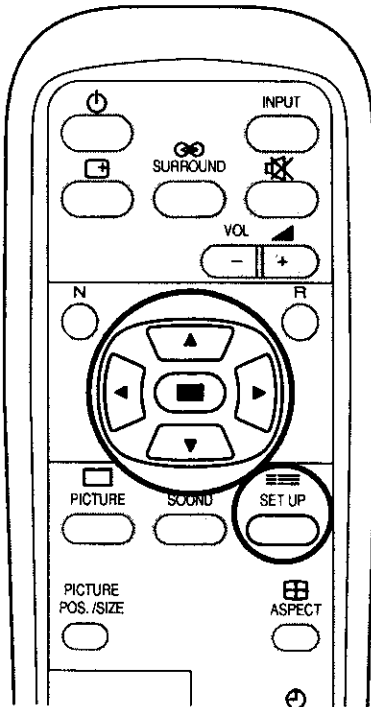

1



Press to display the SET UP menu screen.

2

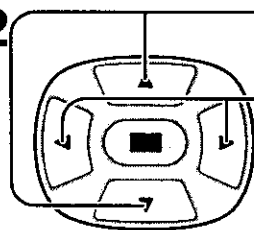

Press to select the "COMPONENT/RGB IN SELECT".

Press to select the desired mode.

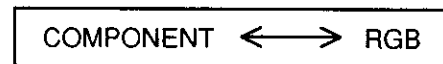
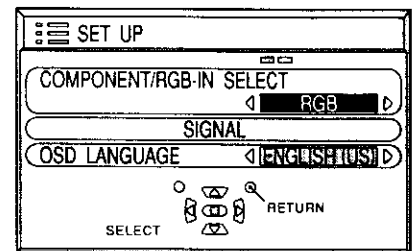

Press to exit from adjust mode.

## Adjusting unnatural video images (3D Y/C FILTER)

Select the SIGNAL from the "SET UP" menu during VIDEO (S-VIDEO) input signal mode. ("SIGNAL [VIDEO]" menu is displayed.)

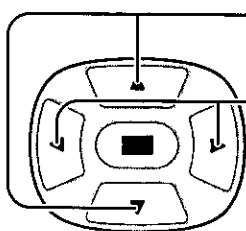

Press to select the "3D Y/C FILTER (NTSC)"

Press to set ON/OFF.



Press to exit from adjust mode.

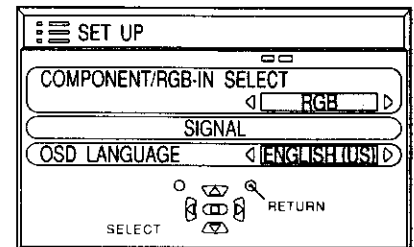

Press (store) button

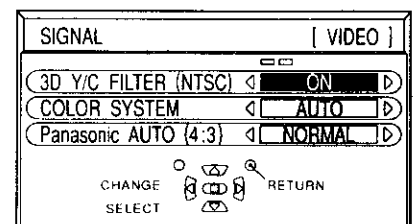

## COLOR SYSTEM / Panasonic AUTO

Select SIGNAL from the "SET UP" menu during VIDEO (S-VIDEO) input signal mode. ("SIGNAL [VIDEO]" menu is displayed.)

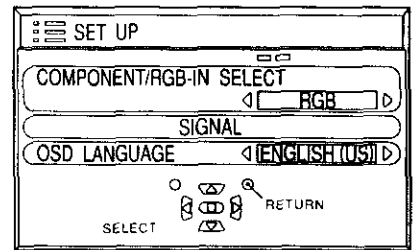
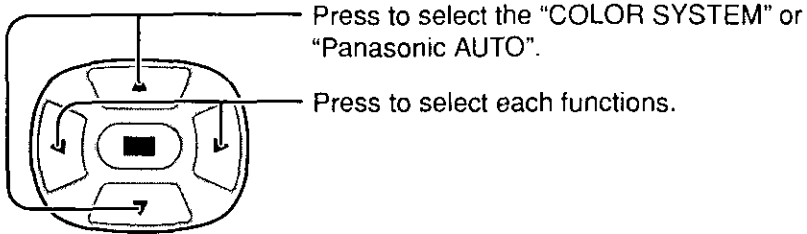

Press (store) button

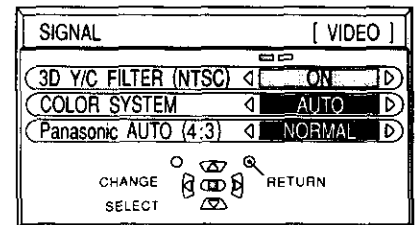

Mode	Function
Color system	Set the color system to match the input signal. If set to "AUTO", the color system is determined automatically. <div style="text-align: center;"> <span style="border: 1px solid black; padding: 2px;">                     → AUTO ↔ PAL ↔ SECAM ↔ M-NTSC ↔ NTSC ←                 </span> </div>
Panasonic AUTO (4:3)	Set to "NORMAL" to view 4:3 images in an unchanged format when Panasonic AUTO is selected. If you would like to view 4:3 images in "Just" format, set to "JUST".

# SET UP for Input Signals

Select SIGNAL from the "SET UP" menu during RGB or PC input signal mode.

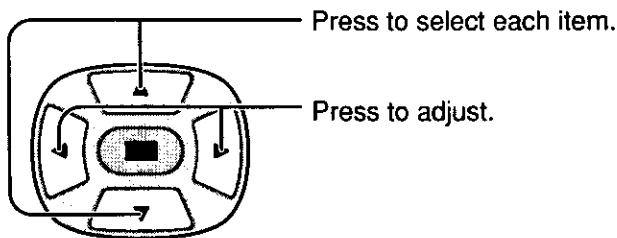

The following operation methods are the same for both the SIGNAL [RGB] and SIGNAL [PC].

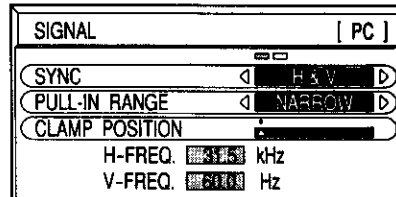
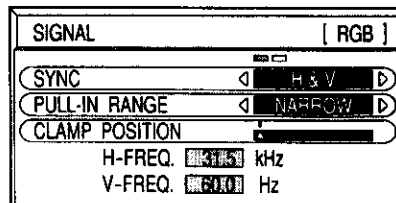

## SYNC

### Setting RGB sync signal setting:

Confirm that the input is set to RGB INPUT (this setting is valid only for RGB INPUT).

- H&V: The H and V sync signals are input from the HD/VD (BNC) connector.
- ON G: Uses a synchronized signal on the Video G signal, which is input from the G (BNC) connector.
- ON VIDEO: Compatible with the scart plug (Europe)  
The composite video signal input from the VIDEO input terminal is used by dividing the sync signals.

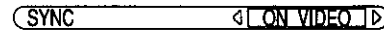
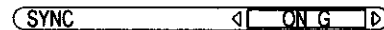
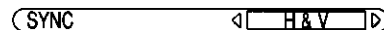

### Setting PC sync signal setting:

Confirm that the input is set to PC INPUT (this setting is valid only for PC INPUT).

- H&V: The H and V sync signals are input from the HD/VD (BNC) connector.
- ON G: Uses a synchronized signal on the Video G signal, which is input from the G (BNC) connector.

## PULL IN RANGE

Sets the width for different frequencies.

(This setting is the same for both SIGNAL [RGB] and SIGNAL [PC].)

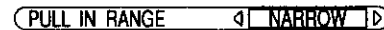

## CLAMP POSITION

Adjusts the clamp position.

The following operation methods are the same for "SIGNAL" menu during, RGB and PC input signal mode.

Normally, these adjustments are set to appropriate levels and, therefore, do not need to be altered.



## H-FREQ (kHz)/V-FREQ (Hz)

Displays the H (Horizontal)/V (Vertical) frequencies.

This display is valid only for RGB input and PC input.

Display range:



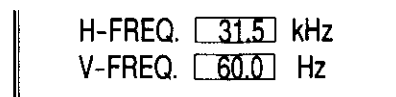





- Horizontal 15.5 - 110 kHz
- Vertical 48 - 120 Hz

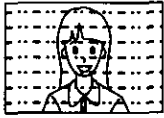

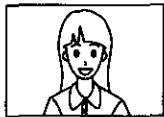
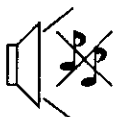

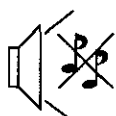
# Troubleshooting

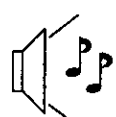
Before you call for service, determine the symptoms and make a few simple checks as shown below.

Symptoms		Checks
Picture	Sound	
 <p>Interface</p>	 <p>Noisy Sound</p>	Electrical Appliances Cars/Motorcycles Fluorescent light
 <p>Normal Picture</p>	 <p>No Sound</p>	Volume (Check whether the mute function has been activated on the remote control.)
 <p>No Picture</p>	 <p>No Sound</p>	Not plugged into AC outlet Not switched on PICTURE and BRIGHTNESS/Volume setting (Check by pushing the power switch or stand-by button on the remote control.)
 <p>No Picture</p>	 <p>Normal Sound</p>	If a signal with a non-applicable color system format, or frequency is input, only the input terminal indication is displayed.
 <p>No Color</p>	 <p>Normal Sound</p>	Color controls set at minimum level. Color system (see page 28, 29)

## Plasma Display panel

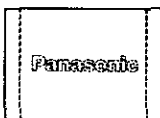
Symptoms	Check
 <p>Some parts of the screen do not light up</p>	The plasma display panel is manufactured using an extremely high level of precision technology, however, sometimes some parts of the screen may be missing picture elements or have luminous spots. This is not a malfunction.
 <p>After-images appear</p>	Do not allow a still picture to be displayed for an extended period, as this can cause a permanent after-image to remain on the Wide Plasma Display. Examples of still pictures include logos, video games, computer images, teletext and images displayed in 4:3 mode.

# Specifications

<b>TH-42PW3</b>	
<b>Power Source</b>	120 V AC, 50/60 Hz
<b>Power Consumption</b>	
Normal use	Max. Amps 4.0 A
Stand-by condition	1.9 W
Power off condition	0.7 W
<b>Plasma Display panel</b>	Drive method AC type 42-inch, 16:9 aspect ratio
Contrast Ratio	3000:1
Brightness Capability	(Panel only) 650 / m <sup>2</sup> (As a set) 400 / m <sup>2</sup>
<b>Screen size</b>	920 mm (W) × 518 mm (H) × 1056 mm (diagonal) No. of pixels 408,960 (852 (W) × 480 (H)) [2,556 × 480 dots]
<b>Operating condition</b>	
Temperature	34 °F - 104 °F (0 °C - 40 °C)
Humidity	20 % - 80 %
<b>Applicable signals</b>	
Color System	NTSC, PAL, PAL60, SECAM, Modified NTSC
Scanning format	525i (480i), 625i (575i), 525p (480p), 750p (720p), 1125i(1080i)
PC signals	VGA SVGA, XGA, SXGA, UXGA (compressed) Horizontal scanning frequency 15.5 - 110 kHz Vertical scanning frequency 48 - 120 Hz
<b>Connection terminals</b>	
AV	Video IN (BNC) 1.0 Vp-p S-VIDEO IN (MINI DIN 4PIN) Y: 1 Vp-p (75 Ω), C: 0.286 Vp-p (75 Ω) AUDIO IN (RCA PIN JACK × 2) 0.5 Vrms
COMPONENT/RGB	Y/G (BNC) 1.0 Vp-p/0.7 Vp-p Pb/B (BNC) ± 0.35 Vp-p/0.7 Vp-p Pr/R (BNC) ± 0.35 Vp-p/0.7 Vp-p HD ± 1.0 - 5.0 Vp-p VD ± 1.0 - 5.0 Vp-p AUDIO IN (RCA PIN JACK × 2) 0.5 Vrms
PC	(HIGH-DENSITY D-SUB 15PIN) R,G,B Video/0.7 Vp-p HD, VD/± 1.0 - 5.0 Vp-p AUDIO IN (M3.5 JACK) 0.5 Vrms
TUNER	OPTIONAL (HIGH-DENSITY D-SUB 26PIN)
SERIAL	EXTERNAL CONTROL TERMINAL (D-SUB9PIN) RS-232C COMPATIBLE
SPEAKERS (6 Ω)	16W [8 W + 8 W] (10 % THD) For TY-SP42PWD3W only

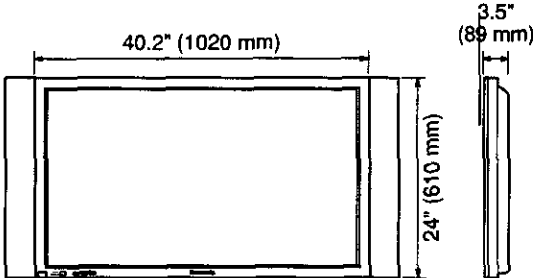
	<b>TH-42PW3</b>
<b>Accessories Supplied</b> Remote Control Transmitter Batteries RCA-BNC adapter plug Ferrite core	EUR646525 2 × AA Size TJS1A4270 KRCBC160928B
<b>Optional Supplied</b>	
Speakers	TY-SP42PWD3W
Pedestal	TY-ST42PT3-K
Wall stand	TY-ST42PW1
Wall-hanging bracket (angled)	TY-WK42PR1
Connecting Cables	TY-SCP15C03
<b>Dimensions (W × D × H)</b>	<p>40.2" (1020 mm) × 24" (610 mm) × 3.5" (89 mm)</p> 
<b>Weight (Mass)</b>	<p>approx. 65.0 lbs (main unit only) approx. 74.3 lbs (with speakers)</p>

**Note:**  
Design and specifications are subject to change without notice. Weight and dimensions shown are approximate.

**Customer' Record**

The model number and serial number of this product can be found on its rear panel. You should note this serial number in the space provided below and retain this book, plus your purchase receipt, as a permanent record of your purchase to aid in identification in the event of theft or loss, and for Warranty Service purposes.

Model Number      TH-42PW3

Serial Number \_\_\_\_\_

---

**Panasonic Consumer Electronics Company, Division of Matsushita Electric Corporation of America**  
One Panasonic Way Secaucus  
New Jersey 07094

**Panasonic Sales Company, Division of Matsushita Electric of Puerto Rico Inc. ("PSC")**  
Ave. 65 de Infanteria, Km 9.5  
San Gabriel Industrial Park,  
Carolina, Puerto Rico 00985

**Panasonic Canada Inc.**  
5770 Ambler Drive  
Mississauga, Ontario  
L4W 2T3