

# RCA

## USER'S GUIDE

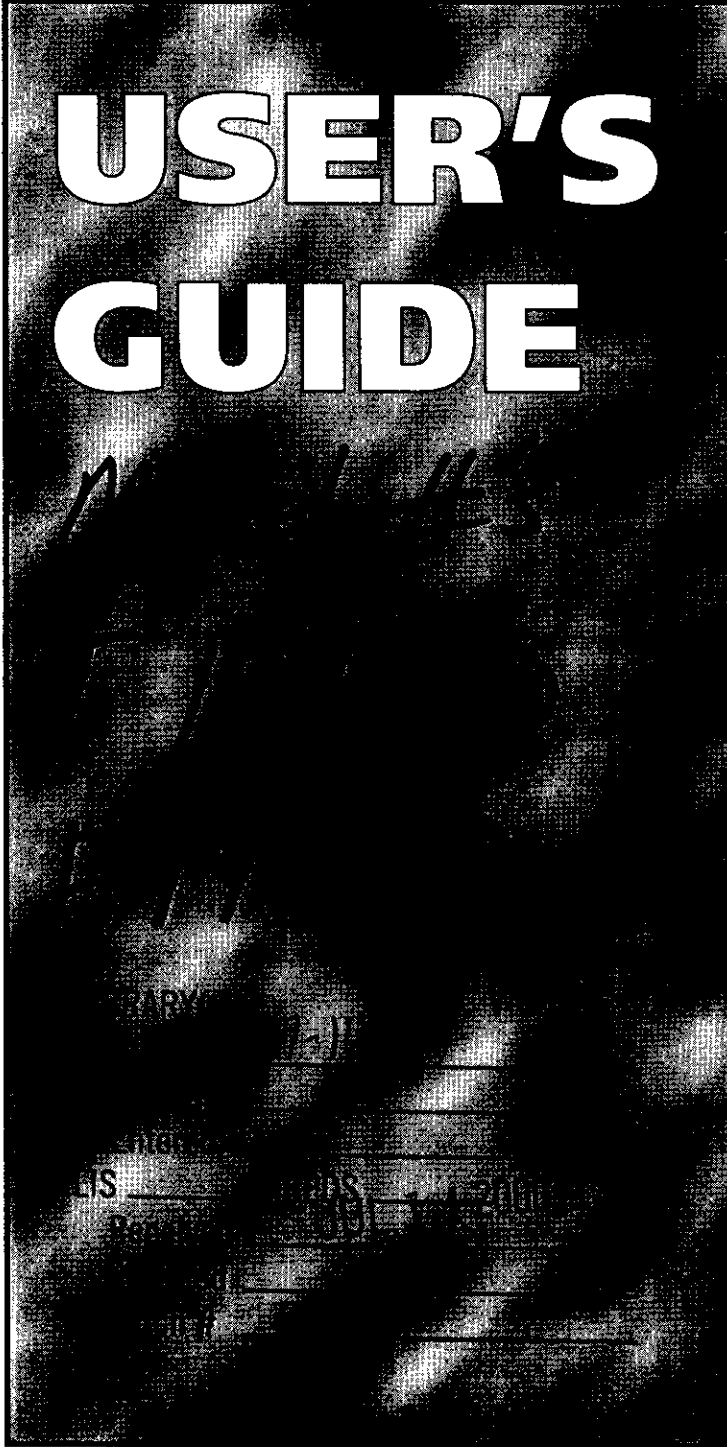

colortelevisioncolortelevisionco  
lortelevisioncolortelevisioncolo  
rtelevisioncolortelevisioncolort  
elevisioncolortelevisioncolortel  
elevisioncolortelevisioncolortelevis  
ioncolortelevisioncolortelevisi  
oncolortelevisioncolortelevisio  
colortelevisioncolortelevisio  
lortelevisio ntelevision  
ncolort television  
colort television  
colort television  
ioncol televis  
televi o  
ncolort elev  
isionco lort  
elevi sio  
nco lo



# IMPORTANT INFORMATION

## WARNING

To reduce the risk of fire or electric shock, do not expose this product to rain or moisture.

## WARNING

RISK OF ELECTRIC SHOCK  
DO NOT OPEN

To reduce the risk of electric shock, do not remove cover (or back). No user-serviceable parts inside. Refer servicing to qualified service personnel.



This symbol indicates "dangerous voltage" inside the product that presents a risk of electric shock or personal injury.



This symbol indicates important instructions accompanying the product.

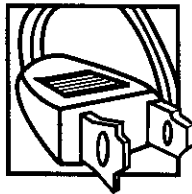

**Caution:** To prevent electric shock, match wide blade of plug to wide slot, fully insert.

**Attention:** Pour éviter les chocs électriques, introduire la lame la plus large de la fiche dans la borne correspondante de la prise et pousser jusqu'au fond.

Refer to the identification/rating label located on the back panel of your product for its proper operating voltage.

FCC Regulations state that unauthorized changes or modifications to this equipment may void the user's authority to operate it.

**If fixed (non-moving) images are left on the screen for long periods, they may be permanently imprinted on the picture tube. Such images include network logos, phone numbers, and video games. This damage is not covered by your warranty. Extended viewing of channels displaying these images should be avoided.**

**Cable TV Installer:** This reminder is provided to call your attention to Article 820-40 of the National Electrical Code (Section 54 of the Canadian Electrical Code, Part 1) which provides guidelines for proper grounding and, in particular, specifies that the cable ground shall be connected to the grounding system of the building as close to the point of cable entry as practical.

## Product Registration

Please fill out the product registration card and return it immediately. Returning the card allows us to contact you if needed.

Keep your sales receipt to obtain warranty parts and service and for proof of purchase. Attach it here and record the serial and model numbers in case you need them. The numbers are located on the back of the product.

Model No. \_\_\_\_\_

Serial No. \_\_\_\_\_

Purchase Date: \_\_\_\_\_

Dealer/Address/Phone: \_\_\_\_\_

# TABLE OF CONTENTS

<b>Setup and Connections .....</b>	<b>3</b>
Step 1: Unpack the TV .....	4
Step 2: Connect the TV .....	4
TV Only .....	4
The Basic Connection .....	5
Advanced Connections .....	6
Sample Connections .....	7
Step 3: Plug in the TV .....	8
Step 4: Place Batteries in the Remote .....	8
Step 5: Turn On the TV .....	8
Step 6: Set Up the TV .....	8
<b>Set-Up Menu .....</b>	<b>9</b>
Using Point and Select .....	10
Set-Up Menu .....	10
Select a Language for the Menus .....	11
Set Reception and Memorize Channels.....	12
Add or Delete Channels .....	13
Change the Input .....	14
<b>Remote Buttons and Front Panel .....</b>	<b>15</b>
Remote Buttons .....	16
Front Panel Controls and Jacks .....	17
<b>Menu Features .....</b>	<b>19</b>
Menus and Control Panels .....	20
Video Menu .....	20
Adjust a Video Setting .....	21
Return Video Settings to Factory Preset .....	22
Time Menu .....	22
Set the Clock .....	23
Set a Wake-Up Time .....	24
Set an Off Time .....	24
Set the Sleep Timer .....	25

# TABLE OF CONTENTS

Special Menu .....	26
Closed Captioning .....	27
CC on Mute .....	28
Power Restore .....	28
Select an Audio Mode .....	29
Turn on Parental Control .....	30
Change the Password .....	31
Setting TV Guidelines and Movie Ratings .....	32
Setting the TV Guidelines Ratings Limits .....	33
Setting the Movie Ratings Limits .....	34
Setting the No Rating Feature .....	35
Block the External Source Signal .....	35
Reference .....	37
Troubleshooting .....	38
Care and Cleaning .....	39
RCA TV Limited Warranty .....	40
Accessory Information .....	42
Index .....	45

# SETUP AND CONNECTIONS

## GETTING STARTED

This manual is designed to get you started quickly. The first four sections of the manual show you how to get your TV set up and connected and use all of the menus, features, and controls of your TV.

The reference section in the back of the book contains troubleshooting tips, care and cleaning instructions, accessory ordering information and your warranty.

Well... if your TV's out of the box, let's get started.

**1** SETUP AND CONNECTIONS



**2** SET-UP MENU



**3** REMOTE & FRONT PANEL



**4** MENU FEATURES



**5** REFERENCE

Check out the notes that have been added throughout the manual in these tip boxes. There are some important tips that will help you get the most from your TV.

# SETUP AND CONNECTIONS

## STEP 1: UNPACK THE TV

Make sure to locate the remote control.

## STEP 2: CONNECT THE TV

There are three types of connections outlined in this section:

- TV Only:** If you're only going to connect the TV to your home antenna or cable system.
- The Basic Connection:** If you're going to connect the TV to a VCR or satellite receiver.
- Advanced Connections:** If you're going to make multiple connections, hooking up the TV to a VCR and a satellite receiver.

Cable information and illustrations are given for each type of connection. Once you have completed your desired connection you may skip forward to Step 3.

### TV ONLY

This is a basic connection from an antenna or cable system to your TV. Connect the cable into the ANT (Antenna) jack as shown.

### Cables

You will use the following cable to make your connection:



**Coaxial Cable:** These cables carry audio and video signals to the TV from an antenna, cable, or cable box.

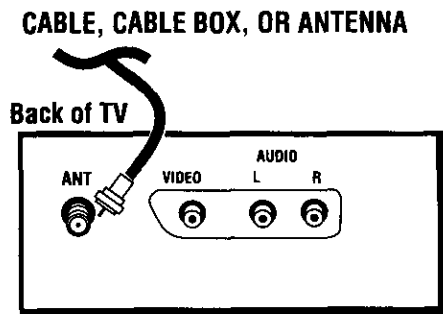

Once you have completed this connection you may go to Step 3.

### Important Stand Information

**CAUTION:** Choose the location for your TV carefully. Take precautions that the stand or other furniture on which the TV is placed is properly located (see Important Safeguards sheet) and of adequate size and strength to prevent the TV from accidentally being tipped over, pushed off, or pulled off. This could cause damage to the TV and/or personal injury.

### Before You Connect

Protect against power surges:

- Connect all components before plugging any power cords into the wall outlet.
- Turn off the TV and/or component before connecting or disconnecting any cables.
- Make sure all antennas and cables are properly grounded. Refer to the Important Safeguards sheet packed with your TV.

Please note that Model F19420 has one AUDIO jack. Model F19430 has stereo AUDIO jacks.

# SETUP AND CONNECTIONS

## THE BASIC CONNECTION

The basic connection below (TV and VCR) is the most common connection and is therefore used to illustrate a single component connection with your TV. For better sound and picture quality and multiple component connection information refer to the next section, *Advanced Connections*.

### Cables

You will use the following type of cable to make your connection:



**Coaxial Cables:** In this connection, two Coaxial Cables are used: one connects from an antenna, cable, or cable box to the VCR, and one connects from the VCR to the TV. These cables carry both audio and video signals.

### How to View the VCR

To watch the VCR in this connection tune TV to Channel 3 or 4.

#### CABLE, CABLE BOX, OR ANTENNA

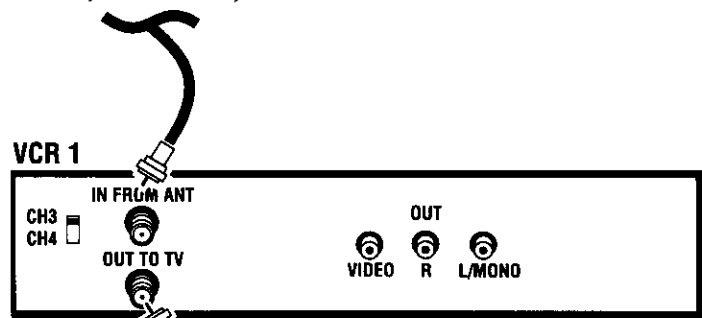

#### Back of TV

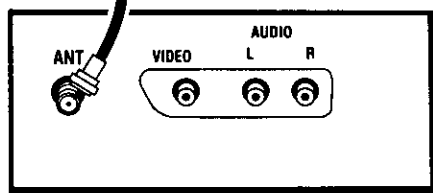

Please note that Model F19420 has one AUDIO jack. Model F19430 has stereo AUDIO jacks.

Once you have completed this connection you may skip to Step 3.

# SETUP AND CONNECTIONS

## ADVANCED CONNECTIONS

Advanced connections give you better sound and video by separating the audio and video signals and enabling you to connect multiple components.

This section describes the types of inputs available on the back of your TV and suggests ways you can use them for optimum performance.

### Back of the TV

The diagram below describes each of the back panel jacks. When connecting A/V cables, be sure to connect corresponding jacks (Video to Video and Audio to Audio). On Model F19430, be sure to connect Right Audio to Right Audio and Left Audio to Left Audio between stereo components).

Once you have made your connections, you will need to program the TV to tune to the video input channel in order to see and hear audio and video from a component such as a VCR or DVD player.

Please note that Model F19420 has one mono AUDIO jack. Model F19430 has stereo AUDIO jacks.

**VIDEO and AUDIO Inputs**

Connect any one of the following components:

- VCR
- Laserdisc Player
- Satellite Receiver
- Internet Access Device
- DVD Player

To view the component connected to the AUDIO and VIDEO jacks, use the INPUT button on the remote.

Note: if you plug a component into the front of the TV, the jacks on the back of the TV will not operate.

**VIDEO JACK:** Connect the Video jack of the component to the VIDEO IN jack of the TV.

**ANT (Antenna)**

Receives the signal from a cable, cable box, or off-air antenna. Also used for basic component connections.

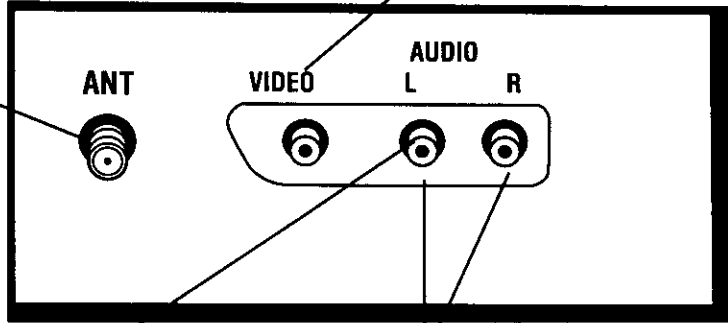

**Model F19420 AUDIO JACK:** Connect the Audio jack of the component to the AUDIO IN jack of the TV.

**Note:** If you are connecting a stereo component, you may need a y-adapter.

**Model F19430 AUDIO JACKS:** Be sure to connect the left Audio jack of the component to the Left AUDIO IN jack of the TV (next to VIDEO IN jack) and the Right Audio jack of the component to the Right AUDIO IN jack of the TV.

**Note:** If you are connecting a mono component, connect the Audio jack to the Left AUDIO jack of the TV.



# SETUP AND CONNECTIONS

## SAMPLE CONNECTIONS

The following are sample connection scenarios you may encounter when connecting components to your TV.

### Cables

You will use the following types of cables to make your connection:



**Coaxial Cables:** Carries the signal from the antenna or cable directly to the television or through a cable box, as needed by your cable system.



**Audio/Video Cables:** Carries audio and video from a component to the TV.

### TV and Stereo or Mono VCR

Compared to the Basic Connection, using Audio/Video cables will enhance the sound and picture quality from a component.

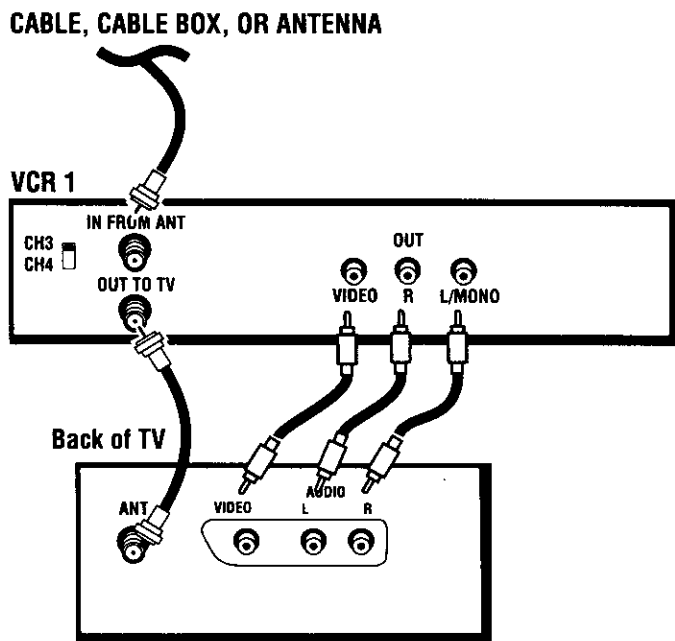

### Cautions:

#### Position cables to avoid audio hum or interference

- Insert all cables firmly into jacks.
- Place the audio/video cables to the sides of the TV's back panel instead of straight down the middle.
- Try not to coil any twin-lead cables and keep them away from the audio/video cables.

#### Protect your components from overheating

- Do not block ventilation holes in any of the components. Arrange the components so that air can circulate freely.
- Do not stack components.
- Allow adequate ventilation when placing your components in a stand.
- Place an amplifier on the top shelf of the stand so heated air rising from it will not flow around other components.

### How to View Your VCR

To watch the VCR in this connection, press INPUT to select the component connected to the AUDIO/VIDEO inputs.

Note: if you connect a component to the front jacks, the back jacks will be turned off.

Most Audio/Video cables are combined into one cable with three heads on each end.

We show individual cables in these sample connections. Either may be used, but you must be sure to connect Video to Video, Right to Right and Left to Left.

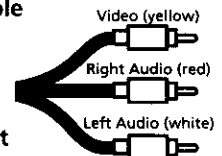

Please note that Model F19420 has one AUDIO jack. Model F19430 has stereo AUDIO jacks.

# SETUP AND CONNECTIONS

## TV, VCR and Satellite Receiver

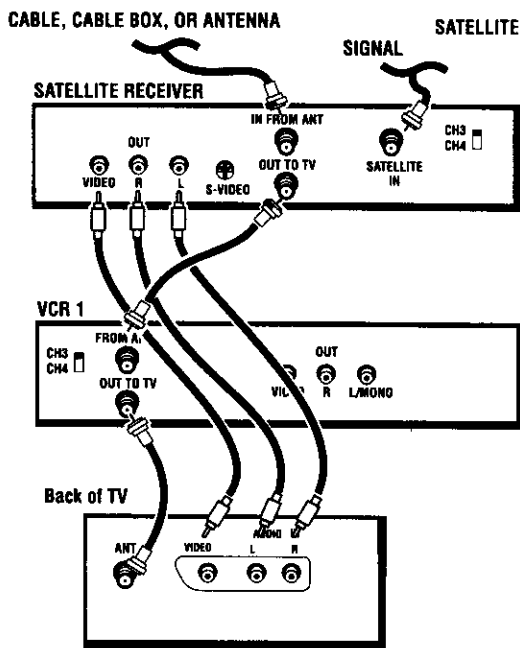

## How to View Your Components

To watch the satellite receiver in this connection, press INPUT to select the video input channel.

To watch the VCR in this connection, enter 03 to tune to the VCR channel.

Please note that Model F19420 has one AUDIO jack. Model F19430 has stereo AUDIO jacks.

## STEP 3: PLUG IN THE TV

Plug the end into the wall outlet, matching the wide blade of the plug with the wide slot in the outlet. Be sure to insert the plug completely.

## STEP 4: PLACE BATTERIES IN THE REMOTE

- Remove the battery compartment cover from the back of the remote.
- Insert fresh batteries. Make sure that the polarities (+ and -) are aligned correctly.
- Replace the cover.

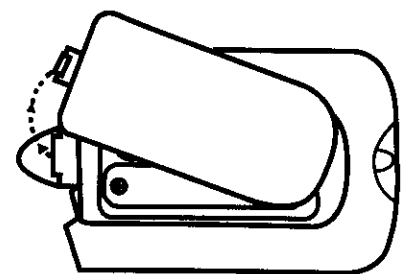

## STEP 5: TURN ON THE TV

Press POWER on the remote or TV.

## STEP 6: SET UP THE TV

Proceed to the next section to set up your TV for your personal preferences.

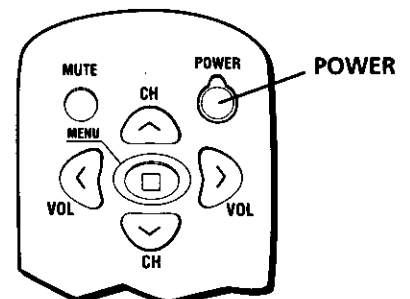

# SET-UP MENU

## SET-UP MENU

The Set-Up menu is used to configure the TV and set up the features for your personal preference:

- Select a menu language
- Search for available channels

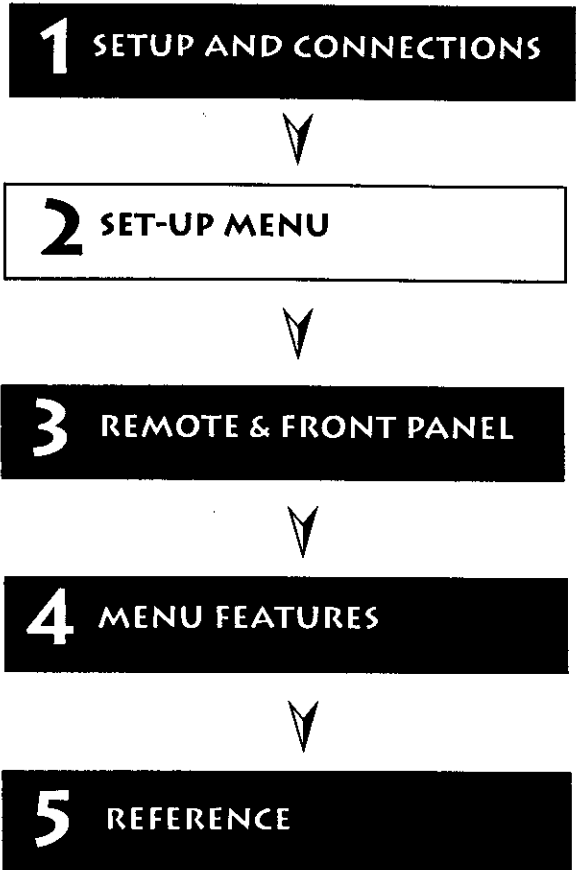

# SET-UP MENU

## USING POINT AND SELECT

You only need to know one rule to access on-screen menus and control panels: point and select. The point and select method has two steps.

1. **Point** to a menu item using the CH ^ or CH v buttons.
2. **Select** or change an item using the VOL > or VOL < buttons.

## SET-UP MENU

You can display the Set-Up menu by repeatedly pressing MENU.

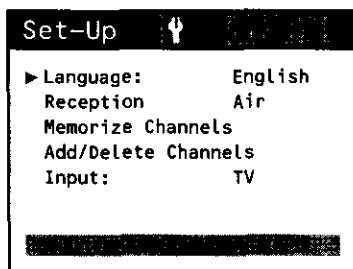

**Language** Lets you change the menu language to Spanish, French, or English.

**Reception** Set to tell your TV if you are connecting an antenna or cable-TV system.

**Memorize** Set to have your TV create a Channel List from the available channels.

**Add/Delete Channels** Lets you Add and Delete channels from your Channel List.

**Input** Selects the signal from the TV or a component attached to the AUDIO/VIDEO jacks.

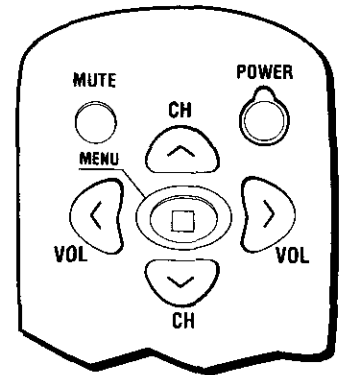

Point and Select Buttons  
(CH and VOL)

# SET-UP MENU

## SELECT A LANGUAGE FOR THE MENUS

1. Press MENU **twice** to display the Set-Up menu.

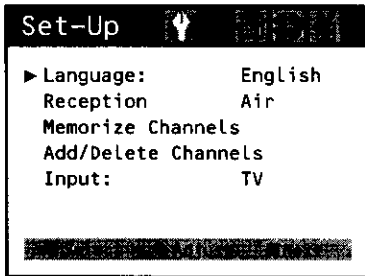

English

2. Press VOL > or VOL < to select English, Spanish, or French.

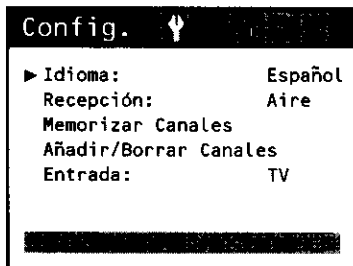

Spanish

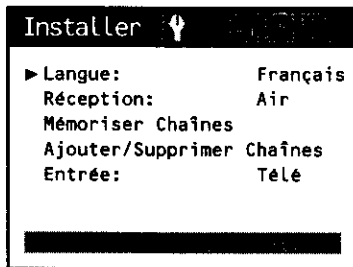

French

3. Repeatedly press MENU to remove the menu and return to normal TV viewing.

Repeatedly press MENU at any time to remove all displays from the screen and return to TV viewing.

# SET-UP MENU

## SET RECEPTION AND MEMORIZE CHANNELS

Use the Memorize Channels feature to have the TV search for all channels that are viewable through your antenna or cable-TV system. This is sometimes called "auto programming." Note that first you must set the Reception feature to Air or Cable.

1. Press MENU **twice** to display the Set-Up menu and use CH v to select Reception.

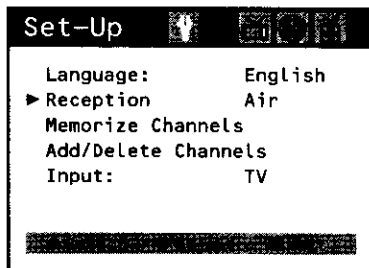

2. Use VOL > or VOL < to select Air or Cable.
  - Select Air if you have connected an antenna.
  - Select Cable if you have connected a cable-TV system.
3. Use CH v to select Memorize Channels.

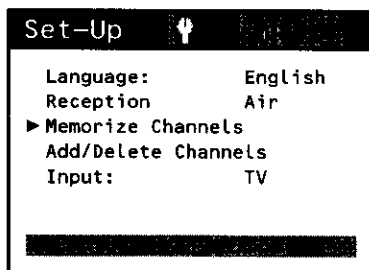

4. Press VOL > or VOL < to have the TV begin searching for available channels. The display gives you a progress report and tells you when it has finished.

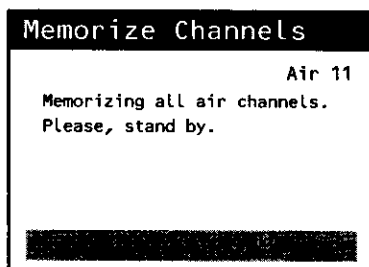

5. Press CH ^ or CH v to access the channels in the channel list. You can add or delete channels from the list. The channels can also be accessed using the number buttons on the remote.

**If you change your location or cable company, you will need to Memorize Channels again.**

# SET-UP MENU

## ADD OR DELETE CHANNELS

1. Select the channel you want to add or delete using the number buttons on the remote.
2. Press MENU **twice** to display the Set-Up menu and use CH v to select Add/Delete Channels.

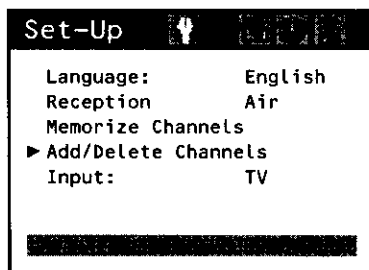

3. Press VOL > or VOL < to select the Add/Delete Channels feature. One of the menus below will appear depending on whether the selected channel is in the channel list.

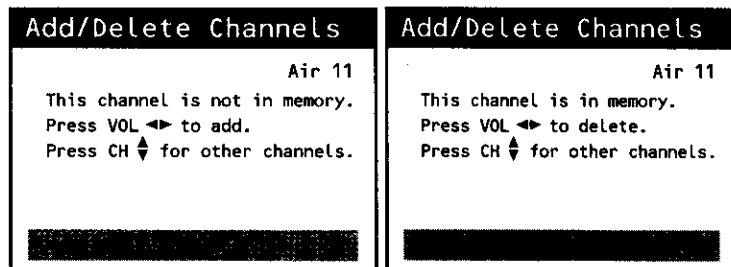

4. Use the VOL < or VOL > to add or delete the channel from the channel list.
5. If you want to add or delete another channel, use CH ^ or CH v to select it.
6. Press MENU to remove the menu and return to normal TV viewing.

# SET-UP MENU

## CHANGE THE INPUT

Use the Input feature to select the signal you want to view. Normally, your TV displays the signal coming from antenna or cable-TV system. To see the signal from a component connected to the AUDIO/VIDEO jacks of the TV, change the Input feature to Line.

1. Display the Set-Up menu and use CH  $\nabla$  to select Input.

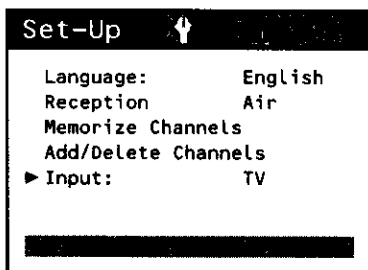

2. Use VOL 5 or 6 to select TV or Line.
  - Select TV if you want to see the signal from the antenna or cable-TV.
  - Select Line if you want to see the signal from a component connected to the AUDIO/VIDEO jacks on the TV.
3. When the Input feature is set to Line, you will see the signal from a component connected to the front AUDIO/VIDEO jacks.

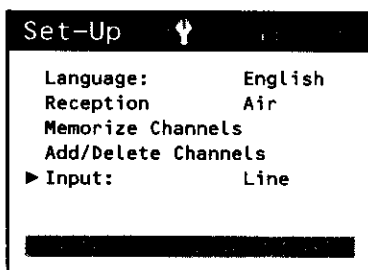

Note: if you want to see the signal from a component connected to the back AUDIO/VIDEO jacks, disconnect the component from the front jacks.

4. Press MENU to remove the menu and return to normal TV viewing.

Remember to set the Input feature to TV to see the signal from an antenna or cable-TV system.



# REMOTE AND FRONT PANEL

## REMOTE BUTTONS AND FRONT PANEL CONTROLS AND JACKS

### Remote Buttons

This section defines the functions of the remote buttons.

### Front Panel Controls and Jacks

This section defines the functions of the controls and jacks on the front panel.

**1** SETUP AND CONNECTIONS



**2** SET-UP MENU



**3** REMOTE & FRONT PANEL



**4** MENU FEATURES



**5** REFERENCE

# REMOTE AND FRONT PANEL

## REMOTE BUTTONS

The functions of the remote buttons are listed below in alphabetical order.

**CH ^ or CH v** Scans up or down through the current channel list. Press once to change the channel up or down; press and hold to continue changing channels.

Used to point to different items in the menu system.

**INFO** Brings up channel information.

**INPUT** Use to view the component connected to the AUDIO and VIDEO jacks on the front or back of the TV. If you plug a component into a jack on the front of the TV, the corresponding jack on the back of the TV will not operate.

**GO BACK** Returns you to the previous channel.

**MENU** Used to toggle through the menus.

**MUTE** Reduces the TV's volume to its minimum level. Press again to restore the volume.

**POWER** Turns the TV on and off.

**SLEEP** Used to program the TV to turn off after a certain time.

**VIDEO** Used to display the video features (Contrast, Brightness, Sharpness, Color and Tint) on the TV screen. Use VOL > and VOL < to adjust the feature when it is displayed on the TV screen.

**VOL < or VOL >** Decreases or increases the TV's volume.

When in the menu system, selects and changes highlighted items.

**(0-9) Number Buttons** Enters channel numbers.

To enter a two-digit channel, press the two digits.

To enter a three-digit channel, press the three digits.

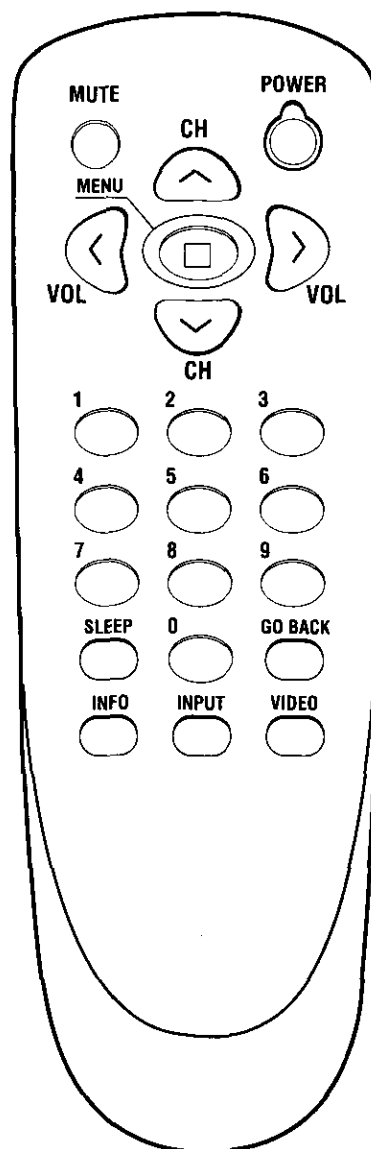

# REMOTE AND FRONT PANEL

## FRONT PANEL CONTROLS AND JACKS

You can use the front panel buttons and controls of your TV to operate many of the TV's features.

Other components, such as a camcorder or VCR, can be connected to the jacks on the front of the TV.

### Model F19420: AUDIO Jacks

Attach the Audio Out jack of another component to this jack. To view the component connected to this jack, use the INPUT button on the remote. If you plug a component into this jack on the front of the TV, the AUDIO jack on the back of the TV will not operate.

This jack is ideal for the temporary connection of a camcorder or video game system.

### Model F19430: AUDIO L(MONO) and R Jacks (GAMEPORT)

Attach the Left and Right Audio Out jacks of another component to the corresponding AUDIO L(MONO) or R jack. If your other component has only one Audio Out jack, attach it to the L(MONO) jack. To view the component connected to these jacks, use the INPUT button on the remote. If you plug a component into these jacks on the front of the TV, the AUDIO jacks on the back of the TV will not operate.

These jacks are ideal for the temporary connection of a camcorder or video game system.

**CH ^ or CH v Buttons** Scans up or down through the current channel list. Press once to change the channel up or down; press and hold to continue changing channels.

Used to point to different items in the menu system.

**Model F19420 Only: Headphone Jack** Attach a headphone to this jack for private listening.

**MENU Button** Used to toggle through the menus.

**POWER Button and Standby Indicator** Turns the TV on and off. The standby indicator lights when the power is turned off and the TV is in standby.

**Remote Sensor** Aim the remote at this sensor to operate the TV.

**VIDEO Jack** Attach the Video Out jack of another component to this jack. To view the component connected to this jack, use the INPUT button on the remote. If you plug a component into this jack on the front of the TV, the VIDEO jack on the back of the TV will not operate.

This jack is ideal for the temporary connection of a camcorder or video game system.

**VOL < or VOL >** Decreases or increases the TV's volume.

When in the menu system, selects and changes highlighted items.

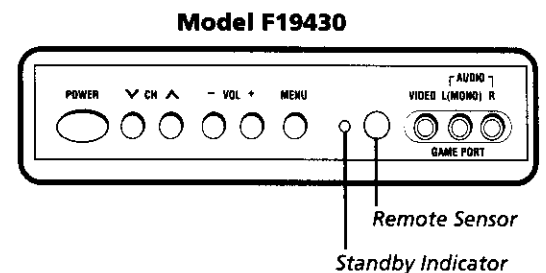
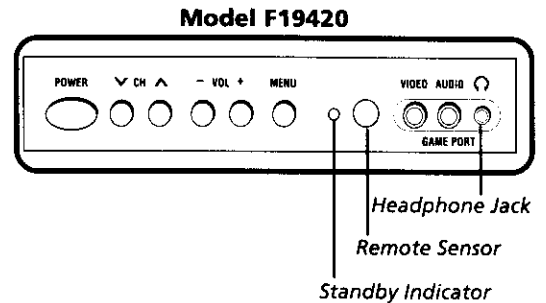

The front panel above shows a typical button layout. The exact look of the buttons may be different from those on the front of your TV.

Use of the front panel AUDIO/VIDEO jacks disables the jacks on the back of the TV.

**This page intentionally left blank.**

# MENU FEATURES

## MENU FEATURES

This section introduces you to the features and controls with which your TV is equipped. In this section, you will learn how to use:

- Video menu for adjusting Contrast, Sharpness, Brightness, Color, and Tint
- Time menu for setting the Time, Wake-Up Time, and Sleep Timer
- Special menu for selecting Closed Captions, activating Parental Controls (including V-Chip rating limits), and selecting Audio

**1** SETUP AND CONNECTIONS



**2** SET-UP MENU



**3** REMOTE & FRONT PANEL



**4** MENU FEATURES



**5** REFERENCE

# MENU FEATURES

## MENUS AND CONTROL PANELS

Using the buttons on both the remote and front panel enable you to access and make changes to the menus and control panels.

The following pages detail how to use the Video, Time, and Special menus and controls to customize the functions of your TV. The Set-Up menu features were described and explained under *Set-Up Menu*.

Press MENU to toggle through the menus. Press once to display the Video menu, twice to display the Set-Up menu, three times to display the Time menu, four times to display the Special menu, and five times to remove the menu and return to TV viewing.

- With the menu displayed, point to the feature with CH ^ or CH v and then select and/or adjust the feature with VOL < and VOL >.

### Exiting a menu

There are two ways to exit a menu:

- Press MENU repeatedly. The on-screen menus are cleared from the screen and you return to TV viewing.
- Wait ten seconds and the menus are automatically cleared from the screen.

## VIDEO MENU

You can access the Video menu features directly by pressing VIDEO on the remote or display the Video menu by pressing MENU on the remote.

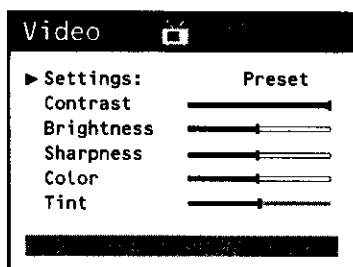

**Basic Video Controls** Displays the five slider controls for adjusting the way the picture looks and lets you reset the video to the factory settings.

**Settings: Preset and Custom** Lets you reset your custom video settings to the factory presets.

**Contrast** Adjusts the difference between the light and dark areas of the picture.

**Brightness** Adjusts the brightness of the picture.

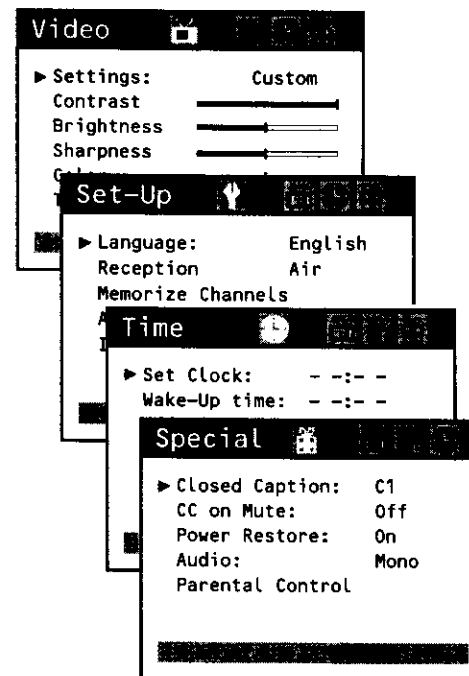

Please note that the Audio Mode feature is only available on Model F19430.

# MENU FEATURES

**Sharpness** Adjusts the crispness of edges in the picture.

**Color** Adjusts the richness of the color.

**Tint** Adjusts the balance between the red and green levels.

## ADJUST A VIDEO SETTING

1. Press MENU on the remote to display the Video menu and use CH  $\wedge$  or CH  $\vee$  to highlight Contrast.

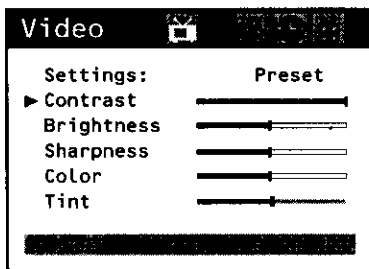

2. Use VOL > or VOL < to select Contrast and display the Contrast adjustment slider.

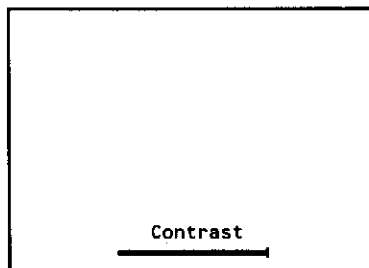

- Press VOL > to increase the Contrast.
  - Press VOL < to decrease the Contrast.
3. Press CH  $\wedge$  or CH  $\vee$  to display another Video adjustment slider and use VOL > or VOL < to adjust it.
  4. Press MENU to return to the Video menu or wait ten seconds for the slider to disappear from the TV screen. The TV will remember your settings.

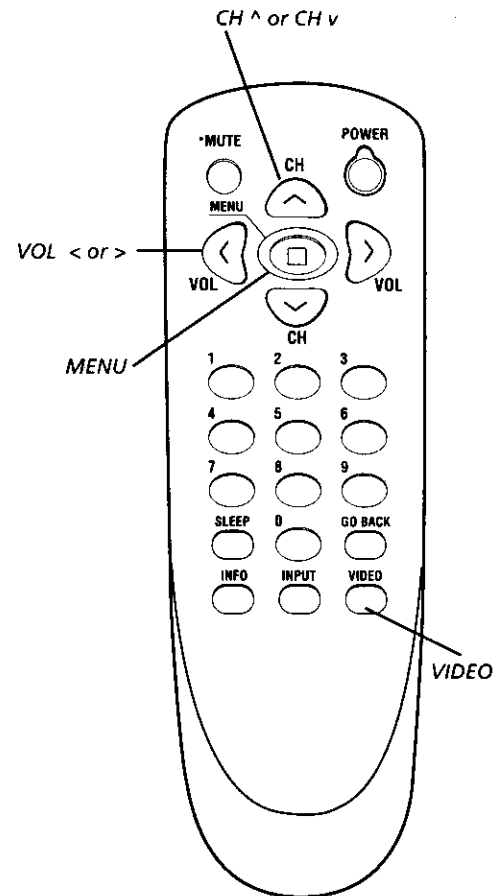

You can also press the VIDEO button on the remote to toggle through the Video menu adjustment sliders. When the slider appears on the screen, use VOL > or VOL < to adjust it or use CH  $\wedge$  or CH  $\vee$  to display another Video adjustment slider.

# MENU FEATURES

## RETURN VIDEO SETTINGS TO FACTORY PRESET

You can return the Video settings to the factory preset ones. Your custom settings will remain in memory.

1. Press MENU on the remote to display the Video menu.

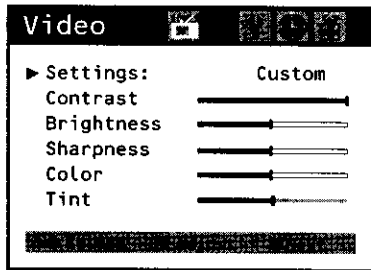

2. Use VOL > or VOL < to select Preset.

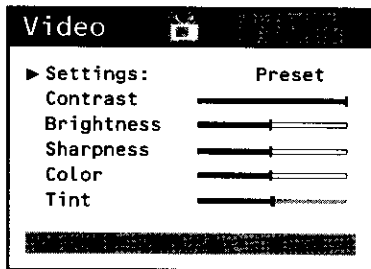

3. To return to your custom settings, press VOL > or VOL < again.

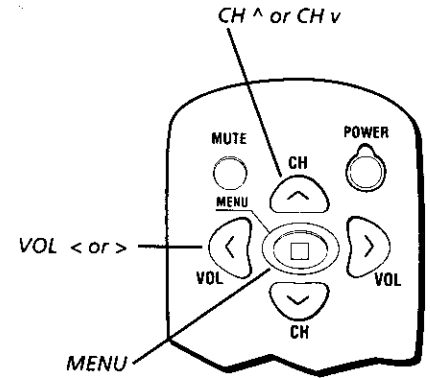

## TIME MENU

You can display the Time menu by repeatedly pressing MENU on the remote. You must set the current time including AM or PM to use the Wake-Up time or Off time feature.

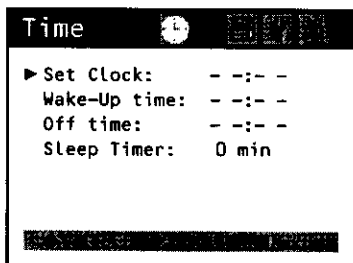

**Set Clock** Lets you enter the current time including AM or PM.

**Wake-Up Time** Lets you enter a time including AM or PM to have the TV turn itself on.



# MENU FEATURES

**Off Time** Lets you enter a specific time including AM or PM to have the TV automatically shut itself off.

**Sleep Timer** Displays a control panel that lets you select the amount of time you want to give the TV before it shuts itself off.

## SET THE CLOCK

1. Repeatedly press MENU on the remote to display the Time menu.

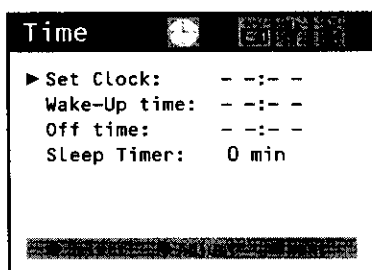

2. Press VOL > or VOL < to enter the current time including AM or PM.

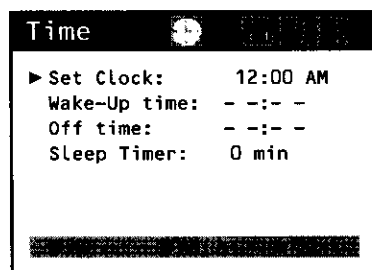

3. Press and hold VOL > or VOL < to quickly enter the current time including AM or PM.
4. Use CH ^ or CH v to select another time function or repeatedly press MENU to remove the Time menu from the TV screen.

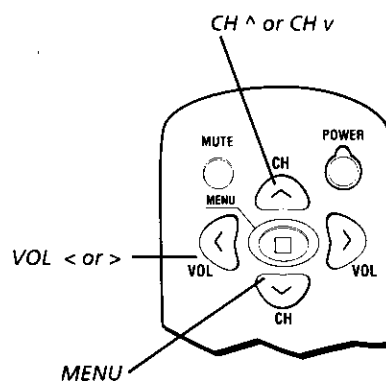

# MENU FEATURES

## SET A WAKE-UP TIME

You must set the current time including AM or PM to use the Wake-Up time feature. If you do not press one of the CH or VOL buttons within 15 minutes after the TV turns on with the Wake-Up timer, the TV will automatically turn off.

1. Repeatedly press MENU on the remote to display the Time menu. Press CH v to highlight Wake-Up time.

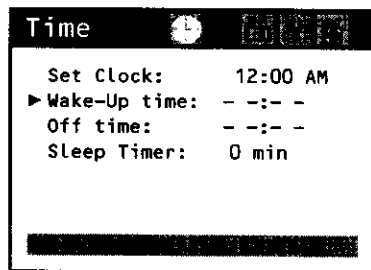

2. Press VOL > or VOL < to enter the time including AM or PM that you want the TV to turn itself on.

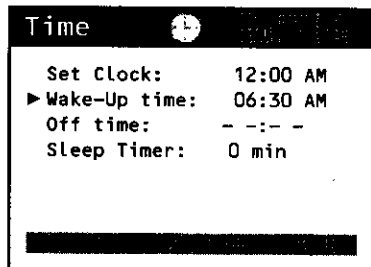

3. Press and hold VOL > or VOL < to quickly enter the Wake-Up time including AM or PM.
4. Use CH ^ or CH v to select another time function or repeatedly press MENU to remove the Time menu from the TV screen.

## To Cancel Wake-Up Time

1. Display the Time menu, select Wake-up Time and press and hold VOL > or VOL < until --:-- appears.

## SET AN OFF TIME

You must set the current time including AM or PM to use the Off time feature.

1. Repeatedly press MENU on the remote to display the Time menu. Press CH v to highlight Off time.

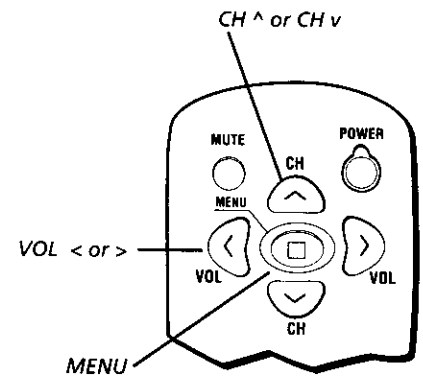

You must set the current time before using the Wake-up feature.

Press one of the CH or VOL buttons within 15 minutes after the TV turns on with the Wake-Up timer or the TV will automatically turn off.

# MENU FEATURES

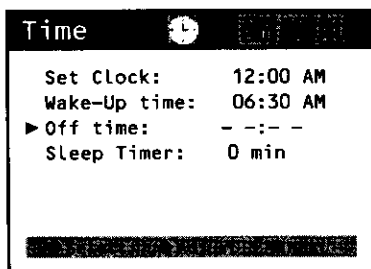

2. Press VOL > or VOL < to enter the time including AM or PM that you want the TV to turn itself off.

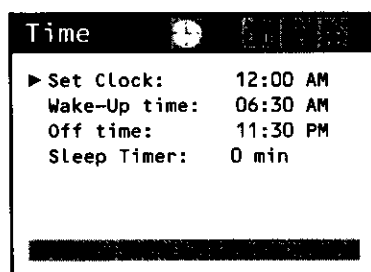

3. Press and hold VOL > or VOL < to quickly enter the Off time including AM or PM.
4. Use CH ^ or CH v to select another time function or repeatedly press MENU to remove the Time menu from the TV screen.

## To Cancel the Off Time

1. Display the Time menu, select Off Time and press and hold VOL > or VOL < until ---:-- appears.

## SET THE SLEEP TIMER

You can also set the Sleep Timer using the SLEEP button on the remote. Repeatedly press SLEEP to display the amount of time (15, 30, 45, 60, 90, or 120 minutes) that you want the TV to play before it turns itself on.

1. Repeatedly press MENU on the remote to display the Time menu. Press CH v to highlight Sleep Timer.

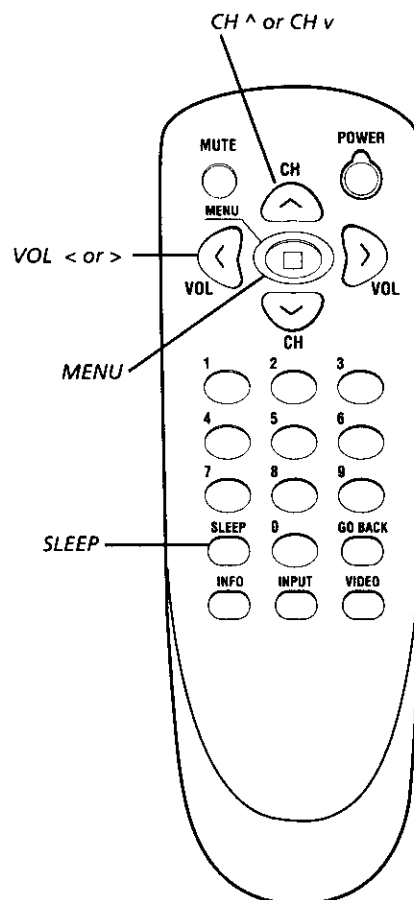
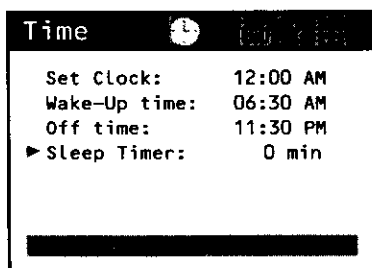

You must set the current time before using the Off Time feature.

You can also use the SLEEP button on the remote to set the Sleep Timer.

# MENU FEATURES

2. Press VOL > or VOL < to enter the amount of time (15, 30, 45, 60, 90, or 120 minutes) that you want the TV to play before it turns itself on.

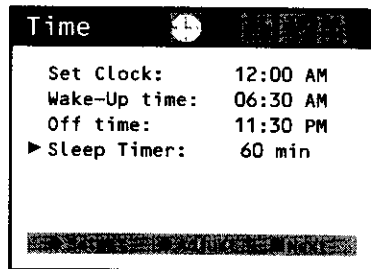

3. Use CH ^ or CH v to select another time function or press MENU to remove the Time menu from the TV screen.

## To Cancel the Sleep Timer

1. Turn off the TV, press SLEEP on the remote until 0 appears, or set the display on the Time menu to --:--.

## SPECIAL MENU

You can access the Special menu features by repeatedly pressing MENU on the remote to display the Special menu.

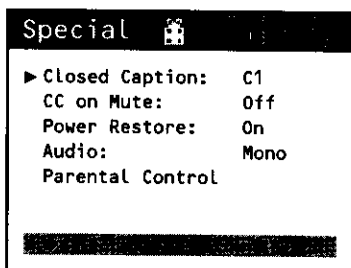

**Closed Caption** Lets you turn closed captioning on and select the type of closed caption you want to view.

**CC on Mute** Lets you turn closed captioning on and select the type of closed caption you want to view when you mute the TV.

**Power Restore** Allows you to plug your TV into an outlet that is controlled by a wall switch and turn the TV on and off using the wall switch.

**Audio (Model F19430 Only)** Allows you to select the type of audio processor.

**Parental Control** Lets you control the types of material watched using rating systems.

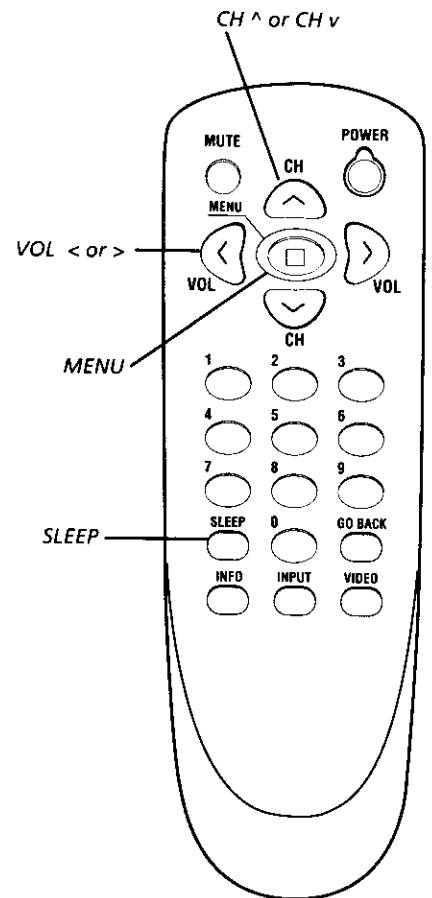

You can also use the SLEEP button on the remote to set the Sleep Timer.

# MENU FEATURES

## CLOSED CAPTIONING

Many programs are encoded with closed captioning information, which lets you display the audio portion of a program as text on the TV screen. Closed captioning is not available on all channels at all times. Only specific programs encoded with closed captioning information are applicable. The TV offers four types of Closed Captions, including two text modes.

Caption types follow the action on-screen providing words that follow the dialog, narration, and side effects. Text types provide information, such as news or weather.

1. Repeatedly press MENU on the remote to display the Special menu.

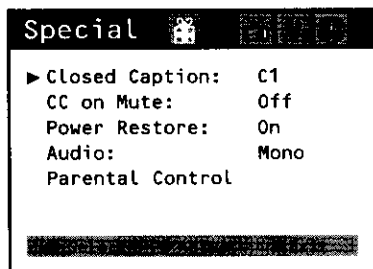

2. Use VOL > or VOL < to select the type of Closed Caption you want to display on the TV screen or turn Closed Caption off.

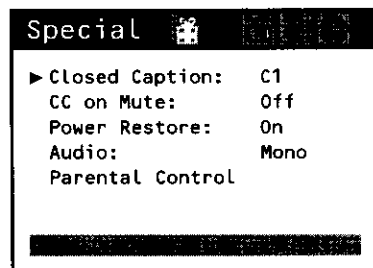

- Select C1 to view Captions (if available) providing words following the dialog, narration, and side effects of the action on screen.
  - Select C2 to view a different type of Caption (if available).
  - Select T1 to view Text (if available) providing information, such as news or weather.
  - Select T2 to view another type of Text (if available) providing information, such as news or weather.
  - Select Off to turn off any Closed Caption (Caption or Text).
3. Use CH ^ or CH v to select another Special feature or press MENU to remove the Special menu from the TV screen.

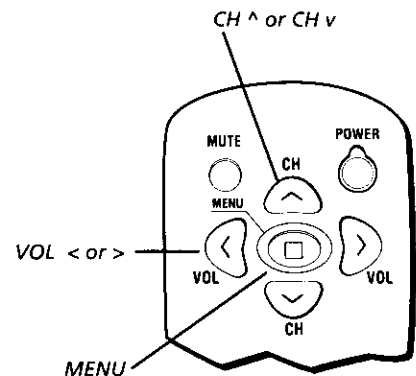

# MENU FEATURES

## CC ON MUTE

You can display a Closed Caption feature automatically when you press MUTE on the remote to mute the sound. The Closed Caption is automatically turned off when you press MUTE again to return to the normal sound level.

1. Repeatedly press MENU on the remote to display the Special menu. Press CH v to highlight CC on Mute.

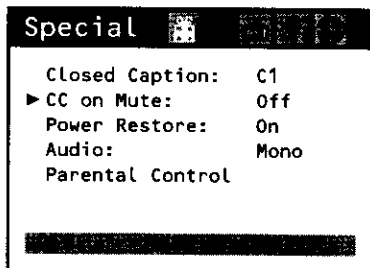

2. Use VOL > or VOL < to select the type of Closed Caption you want to display on the TV screen when you press MUTE on the remote.

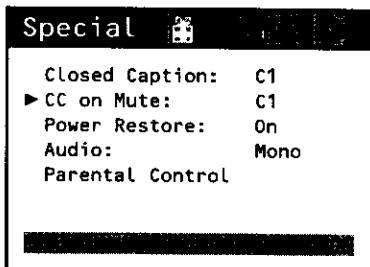

- Select C1 to view Captions (if available) providing words following the dialog, narration, and side effects of the on-screen action.
  - Select C2 to view a different type of Caption (if available).
  - Select Off to turn off any Closed Caption.
3. Use CH ^ or CH v to select another Special feature or press MENU to remove the Special menu from the TV screen.

## POWER RESTORE

This feature allows you to use a switchable wall outlet to turn your TV on or off. Just plug your TV in a wall outlet that is controlled by a wall switch. Set the Power Restore feature to ON in the menu. When you use the wall switch to turn on your TV, it will turn on and return to the settings it was in before you turned it off.

1. Repeatedly press MENU on the remote to display the Special menu. Press CH v to highlight Power Restore.

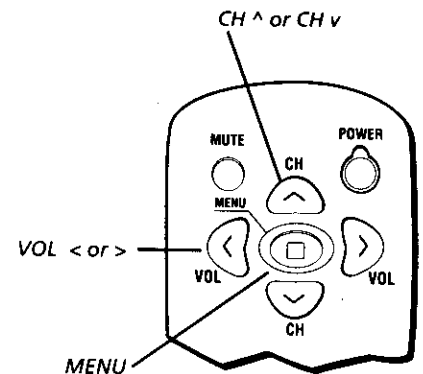

# MENU FEATURES

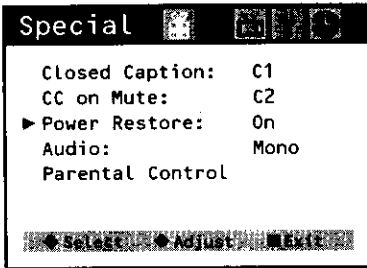

2. Use VOL > or VOL < to turn Power Restore On or Off.
3. Use CH ^ or CH v to select another Special feature or press MENU to remove the Special menu from the TV screen.

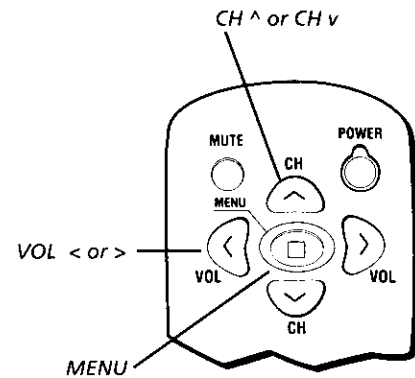

## SELECT AN AUDIO MODE (MODEL F19430 ONLY)

Lets you select the type of available audio modes, which control the way the sound comes through your speakers.

1. Repeatedly press MENU on the remote to display the Special menu. Press CH v to highlight Audio.

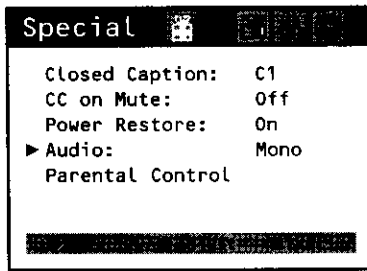

2. Use VOL > or VOL < to select the type of Audio that is available for your TV.
  - Select Mono to hear mono sound only. Use this setting when receiving broadcasts with weak stereo signals. MONO is displayed on the TV screen when you tune to a program that is broadcast in mono.
  - Select Stereo\* to split the incoming stereo audio signal into left and right channels. STEREO is displayed on the TV screen when you tune to a program that is broadcast in stereo.
  - Select Second Audio Program (SAP)\* to hear the program's audio in a second language (if available). SAP is displayed when you tune to a program that is broadcast with SAP. SAP audio is broadcast in mono. SAP is also used to broadcast a program's audio with descriptions of the video for the visually impaired.
3. Use CH ^ or CH v to select another Special feature or press MENU to remove the Special menu from the TV screen.

\* Stereo and Sap Audio features are only available for Model F19430.

# MENU FEATURES

## TURN ON PARENTAL CONTROL

The Parental Control feature allows you to program your TV so that children cannot see certain programs or channels.

The parental control feature comes turned "Off," so if you choose not to implement it, you can just ignore it.

When turned "on," the software reads a code that most broadcasters send with programs. That code tells the software the program's age-based rating (TV-MA, TV-14, etc.) and content themes (Violence (V), Adult Language (L), etc.). If you have blocked the rating and/or content themes that the program contains, you will receive the message, "This rating is blocked." when you turn to that particular channel.

Broadcasters are not required to provide content themes, so programs received with no content themes will only be blocked if you block their age-based rating.

You can also block out programs that have been given a rating of "Not Rated," and programs that are considered "unrated" because no code has been sent by the broadcaster.

1. Repeatedly press MENU on the remote to display the Special menu. Press CH v to highlight Parental Control.

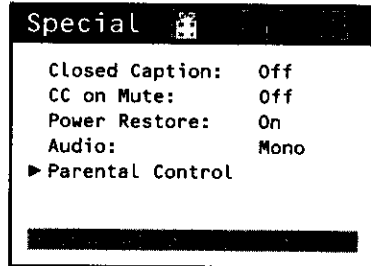

2. Press VOL > or VOL < to display the Parental Control menu.

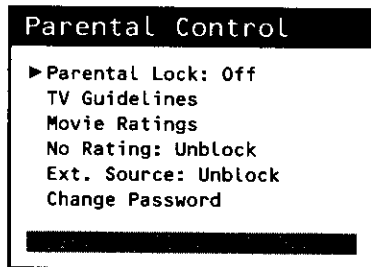

2. Press VOL > or VOL < to turn the Parental Lock feature On. The Enter a new Password screen will appear. Use the number buttons (0-9) to enter your password.

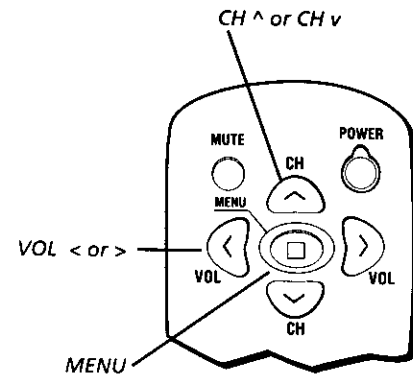



# MENU FEATURES

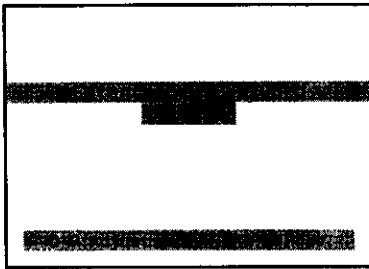

2. Enter your password again when the Repeat the Password screen appears.

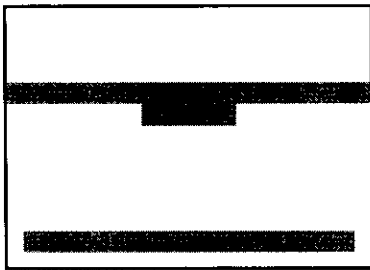

3. Make sure to remember your password. You will be required to enter the password the next time you want to check or change any Parental control setting.
4. Press CH ^ and CH v to select a different Parental Control feature or press MENU to return to the Special menu. Press again to remove the Special menu from the screen.

## Change the Password

If the Parental control has been activated, you will need to enter the current password to change the password.

1. Repeatedly press MENU on the remote to display the Special menu. Press CH v to highlight Parental Control and press CH v to highlight Change Password.

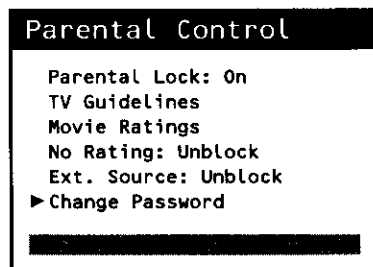

2. The Enter a New Password screen appears. Enter and repeat your new password.
3. Press CH ^ or CH v to select a different Parental Control feature or press MENU to return to the Special menu. Press again to remove the Special menu from the screen.

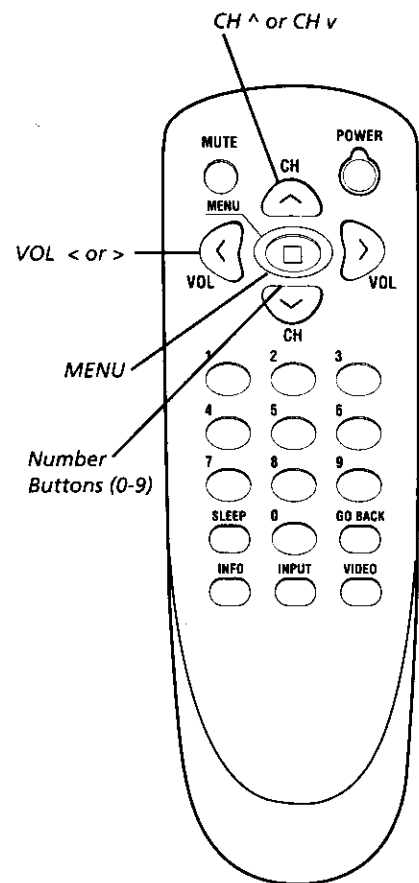

Be sure to remember the password you enter or you will not be able to review or change your Parental Control selections.

# MENU FEATURES

## Setting TV Guidelines and Movie Ratings

The first three choices in the Parental Controls menu involve software inside your TV (dubbed V-Chip) which allows you to block TV programs and movies based on violence, sex, or other content you may believe children should not view. In other words, it lets you program your TV so it will not display certain programs. Once you block programs, you or other adults are not limited to only parent-approved programs; you can unblock programs by entering a password.

When Parental Control is turned On, the software reads a code that most broadcasters send with programs. That code tells the software the program's age-based rating (TV-MA, TV-14, etc.) and content themes (Violence (V), Adult Language (L), etc.). If you have blocked the rating and/or content themes that the program contains, you will receive the message, "This rating is blocked." when you turn to that particular channel. Broadcasters are not required to provide content themes, so programs received with no content themes will only be blocked if you block their age-based rating. You can also block out programs that have been given a rating of "Not Rated," and programs that are considered "unrated" because no code has been sent by the broadcaster.

The TV age-based ratings and content themes you can block are listed in the table below.

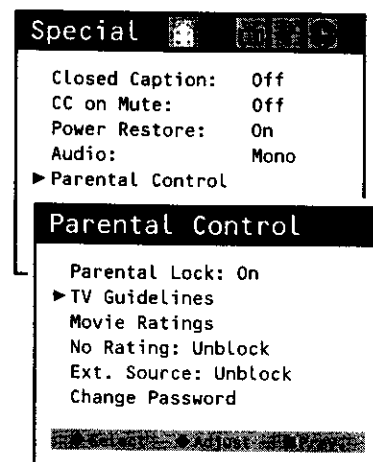

Age-Based Rating	Description and Content Themes for Age-Based Ratings
TV-MA	Mature Audience Only. Specifically designed to be viewed by adults and may be unsuitable for children under 17. It contains one or more of the following content themes: <b>crude indecent language (L), explicit sexual activity (S), or graphic violence (V).</b>
TV-14	Parents Strongly Cautioned. Contains some material that many parents would find unsuitable for children under 14. Parents are strongly urged to exercise greater care in monitoring this program and are cautioned against letting children under the age of 14 watch unattended. This program contains one or more of the following content themes: <b>intensely suggestive dialogue (D), strong coarse language (L), intense sexual situations (S), or intense violence (V).</b>
TV-PG	Parental Guidance Suggested. Contains material that parents may find unsuitable for younger children. Many parents may want to watch it with their younger children. The program contains one or more of the following content themes: <b>some suggestive dialogue (D), infrequent coarse language (L), some sexual situations (S), or moderate violence (V).</b>
TV-G	General Audience. Most parents would find this program suitable for all ages. It contains <b>little or no sexual dialogue (D), no strong language (L), or sexual situations (S), and little or no violence (V).</b>
TV-Y7	Directed to Children 7 years and older. Designed for children ages 7 and above. It may be more appropriate for children who have acquired the developmental skills needed to distinguish between make-believe and reality. Themes and elements in this program may include mild <b>fantasy violence (FV)</b> or comedic violence, or may frighten children under the age of 7.
TV-Y	All Children. Themes and elements in this program are designed for a young audience, including children from ages 2-6. It is not expected to frighten younger children.

# MENU FEATURES

## Setting the TV Guidelines Ratings Limits

The TV Rating Limit lets you decide what TV programs can and cannot be viewed. To set TV programming limits:

1. Repeatedly press MENU on the remote to display the Special menu. Press CH v to highlight Parental Control. Press VOL > or VOL < to display the Parental Control menu.

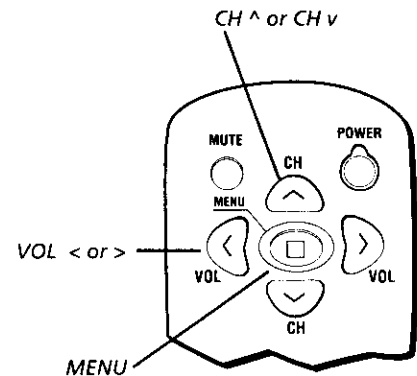
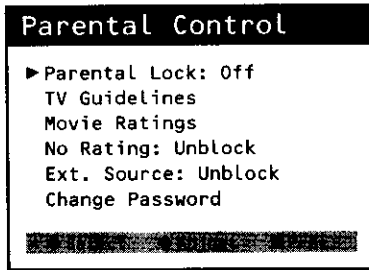

2. Press CH v to highlight TV Guidelines. Press VOL > or VOL < to display the TV Rating screen. Below is an example of where items are located within the Rating Limit screen.

**Rating Field**  
Lets you select from a list of age-based ratings you can block or view.

**Content Themes**  
Lists the content themes you can block or view.

**Content Status Fields**  
Lets you select which content themes to view for the selected rating, and whether the status of the content theme is currently blocked (✓) or not blocked (no ✓).

**Rating Settings Area**  
Lets you see the current block/unblocked state of age-based ratings and associated content. The Blocked settings are checked (✓) and the Unblock settings are not checked.

3. Press CH ^ or CH v to highlight the Rating you want to change. Press VOL > or VOL < to block (✓) or unblock (no ✓) the rating. When you select a channel that has a rating, the rating will appear on the screen. "This rating is blocked." appears on the screen when it has been blocked.
4. Press MENU to return to the Parental Control menu. Repeatedly press MENU to remove the menus from the screen.

# MENU FEATURES

## Setting the Movie Ratings Limits

You set movie rating limits by blocking movies rated above a specified level. If you only want your child to watch movies that have a PG rating and lower (in other words, movies rated PG and G), then you could automatically block out all other movies with higher ratings.

1. Repeatedly press MENU on the remote to display the Special menu. Press CH v to highlight Parental Control. Press VOL > or VOL < to display the Parental Control menu. Press CH v to highlight Movie Rating.

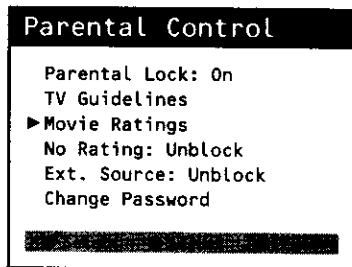

3. Press VOL > or VOL < to display the Movie Rating screen.

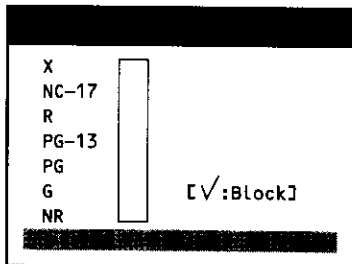

3. Press CH ^ or CH v to highlight the lowest Rating you want to block. Press VOL > or VOL < to block the rating and all of the ratings above the one you block. A check (√) appears next to the ratings you have blocked.

When you select a movie that has a rating, the rating will appear on the screen. "This rating is blocked." appears on the screen when it has been blocked.

4. Press MENU to return to the Parental Control menu. Repeatedly press MENU to remove the menus from the screen.

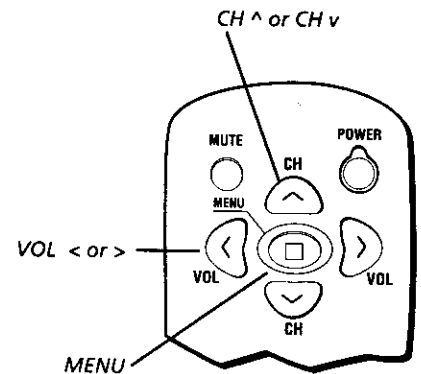

# MENU FEATURES

## Setting the No Rating Feature

This option lets you decide if you want programs that the TV recognizes as “unrated” to be viewed. Note that “unrated” TV programs may include news, sports, political, religious, local and weather programs, emergency bulletins, public announcements, and programs without ratings.

1. Repeatedly press MENU on the remote to display the Special menu. Press CH v to highlight Parental Control. Press VOL > or VOL < to display the Parental Control menu. Press CH v to highlight No Rating.

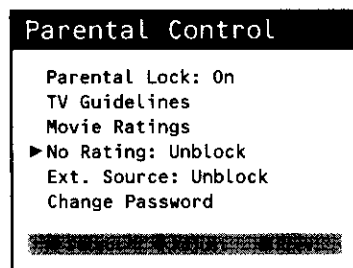

2. Press VOL > or VOL < to toggle between Unblock and Block.
  - Select Unblocked so all unrated programs are available.
  - Select Blocked so no unrated programs are available.
3. Press CH ^ or CH v to select a different Parental Control feature or press MENU to return to the Special menu. Press again to remove the Special menu from the screen.

## Block the External Source Signal

This option lets you decide if you want to block the signal from the component connected to the AUDIO/VIDEO jacks.

1. Repeatedly press MENU on the remote to display the Special menu. Press CH v to highlight Parental Control. Press VOL > or VOL < to display the Parental Control menu. Press CH v to highlight Ext. Source.

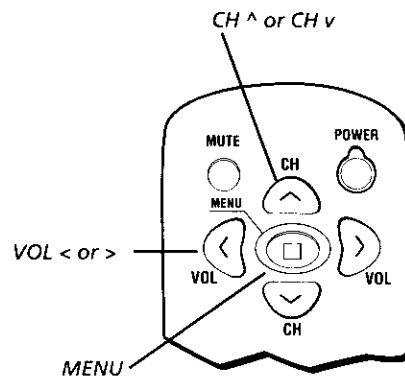
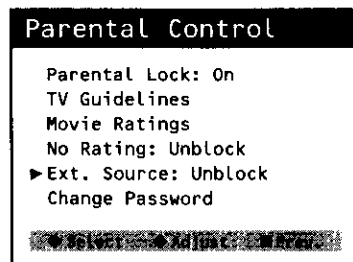

# MENU FEATURES

2. Press VOL > or VOL < to toggle between Unblock and Block.
  - Select Unblocked so the signal from an external source is available.
  - Select Blocked so the signal from an external source is blocked.
3. Press CH ^ or CH v to select a different Parental Control feature or press MENU to return to the Special menu. Press again to remove the Special menu from the screen.

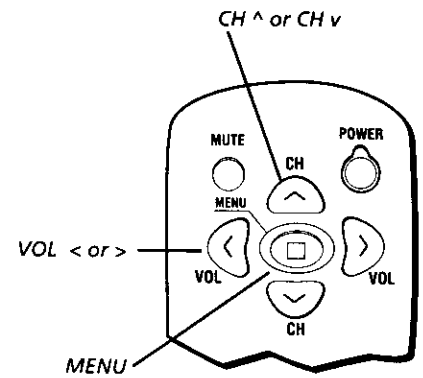

# REFERENCE

## REFERENCES

This section includes:

- Troubleshooting Guide
- Care and Cleaning
- RCA Limited Warranty
- Accessory Information
- Index

**1** SETUP AND CONNECTIONS



**2** SET-UP MENU



**3** REMOTE & FRONT PANEL



**4** MENU FEATURES



**5** REFERENCE

# REFERENCE

## TROUBLESHOOTING

Troubles sometimes are caused by simple “faults” that you can correct without the help of a service technician. If you experience any difficulty with your TV, check a few basic remedies before calling your service technician.

### TV will not turn on

- Check to make sure it is plugged in.
- Check the wall receptacle (or extension cord) to make sure it is “live” by plugging in something else.
- Maybe batteries in remote are weak, dead, or installed incorrectly. Try replacing batteries.
- Maybe remote control is not aimed at remote sensor.
- Try unplugging set for two minutes and then plug it back in and turn it on again.

### Problems with remote

- Maybe something is between the remote and the remote sensor.
- Maybe the remote is not aimed directly at the TV.
- Maybe batteries in remote are weak, dead, or installed incorrectly. Try replacing batteries.
- Remove batteries and hold number 1 for at least 60 seconds to drain the microprocessor inside the remote. Release number 1 and replace the batteries.

### Turns off while playing

- Off Time Feature or Sleep Timer in Time Menu may have been set.
- If TV turns on with Wake-Up feature in Time menu, you must press a CH or VOL button within 15 minutes or the TV will automatically turn off.
- Electronic protection circuit may have been activated because of a power surge. Wait 30 seconds and then turn on again. If this happens frequently, the voltage in your house may be abnormally high or low.
- Unplug. Wait two minutes. Plug in again.

### Blank screen

- Maybe the component connected to the input jacks is not turned on.
- Try another channel.

### No Sound or Noisy stereo reception (Model F19430 Only)

- May be a weak station.
- Maybe sound is muted. Try pressing volume up button to restore sound.
- Stereo signal may be weak. If you have a stereo TV, set the AUDIO feature in the Special menu to MONO.

### Menus appear in other language

- Different language may have been selected in Set-Up menu.



# REFERENCE

## Can't select certain channel

- Channel may be blocked or not approved in the Parental Controls menu.
- If using a VCR, check to make sure the TV/VCR button on the VCR is in the correct "mode."
- Maybe the Reception: Cable/Air setting is set to the wrong position. Check the Reception: Cable/Air setting in the Set-Up menu.

## No picture, no sound but TV is on

- Maybe a vacant channel is tuned.
- If watching VCR (connected only through antenna input), make sure TV is tuned to channel 3 or 4—the same as CH3/4 switch on VCR. Also check to make sure the TV/VCR button on the VCR is in the correct "mode."
- Maybe the Reception: Cable/Air setting is set to the wrong position. Check the Reception: Cable/Air setting in the Set-Up menu.

## Sound okay, picture poor

- Check antenna connections.
- Try adjusting sharpness function to improve weak signals.

## Black box appears on the screen

- Captioning may be turned on and set to a mode that is not available. Check the CC feature in the Special menu.

## CARE AND CLEANING

### **CAUTION: Turn OFF your TV before cleaning.**

You can clean the TV as required, using a soft lint-free cloth. Be sure to occasionally dust the ventilation slots in the cabinet to help assure adequate ventilation.

**The TV's screen may be cleaned with a soft, lint-free cloth as well. Take care not to scratch or mar the screen. If necessary, you may use a cloth dampened with warm water.**

**Never use strong cleaning agents, such as ammonia-based cleaners, or abrasive powder. These types of cleaners will damage the TV.**

While cleaning do not spray liquid directly on the screen, or allow liquid to run down the screen and inside the TV. Also, avoid placing drinks or vases with water on top of the TV. This could increase the risk of fire or shock hazard or damage to the TV.

**Caution:** If fixed (non-moving) images are left on the screen for long periods, they may be permanently imprinted on the picture tube. Such images include network logos, phone numbers, and video games. This damage is not covered by your warranty. Extended viewing of channels displaying these images should be avoided.

# REFERENCE

## RCA TV LIMITED WARRANTY

What your warranty covers:

- Any defect in materials or workmanship.

For how long after your purchase:

- 90 days for labor charges.
- One year for parts.
- Two years for the picture tubes.

The warranty period for rental units begins with the first rental or 45 days from date of shipment to the rental firm, whichever comes first.

What we will do:

- Pay any Authorized RCA Television Service Center the labor charges to repair your television.
- Pay any Authorized RCA Television Service Center for the new or, at our option, refurbished replacement parts and picture tubes required to repair your television.

How you get service:

- For screen sizes of 26" and smaller: Take your RCA television to any Authorized RCA Television Service Center and pick up when repairs are complete.
- For screen sizes larger than 26": Request home service from any Authorized RCA Television Service Center, provided that your television is located within the geographic territory covered by an Authorized RCA Television Service Center. If not, you must take your television to the Service Center location at your own expense, or pay for the cost the Service Center may charge to transport your television to and from your home.
- To identify your nearest Authorized RCA Television Service Center, ask your dealer, look in the Yellow Pages, or call 1-800-336-1900.
- Show the Authorized Service Center Representative your sales receipt or other evidence of purchase date or first rental.

What your warranty does not cover:

- Customer instruction. (Your Owner's Manual clearly describes how to install, adjust, and operate your television. Any additional information should be obtained from your dealer).
- Installation and related adjustments.
- Signal reception problems not caused by your television.
- Damage from misuse or neglect.
- Batteries.

# REFERENCE

- Customer replacement fuses.
- Images burned onto the screen.
- A television that has been modified or incorporated into other products or is used for institutional or other commercial purposes.
- A television purchased or serviced outside the U.S.A.
- Acts of God, such as but not limited to lightning damage.

## Product registration:

- Please complete and mail the Product Registration Card packed with your TV. It will make it easier to contact you should it ever be necessary. The return of the card is not required for warranty coverage.

## How state law relates to this warranty:

- This warranty gives you specific legal rights, and you also may have other rights that vary from state to state.

If you purchased your television outside the United States:

This warranty does not apply. Contact your dealer for warranty information.

**Service calls that do not involve defective materials or workmanship are not covered by this warranty. Costs of such service calls are the sole responsibility of the purchaser.**

# REFERENCE

## ACCESSORY INFORMATION

Antenna (or cable-TV) connections are made with either coaxial antenna cable or twin-lead cable. Coaxial cables are shielded so they are less susceptible to hum or interference from adjacent cables.

Most audio/video connections between components can be made with shielded audio and video cables that have RCA-type phono connectors.



Push-on Connector



Round 75-ohm coaxial cable

Screw-on Coaxial Connector



Flat 300-ohm twin-lead cable



Standard Audio/Video cable with RCA-type phono plugs (such as No. VH83)

### Color-Coded Jacks

The jacks on the TV's monitor panel are color-coded for ease of use. The video jacks are yellow, the right audio jacks are red, and the left audio jacks are white. When connecting components to each other, be sure that you always connect left outputs to left inputs and right outputs to right inputs. If a component has only one output (mono), connect it to the l/mono input jack.

To connect S-VHS (Super-VHS) components, an S-VHS video cable is required.



S-Video cable (such as No. VH913)

### Gold-Plated Jacks and Gold-Tipped Cables

Gold plating helps prevent oxidation of contacts which provides much less loss than conventional contacts. A complete line of gold-tipped cables is available to help you obtain optimum performance from your equipment.

The following accessories are available from most dealers and electronics supply stores in case you want to position your components farther apart or need additional cables.

### Antenna Cables



VH81 (3-ft)

VH82 (6-ft)



VH89 (6-ft)

**Screw-on Cable** attaches to the round antenna connectors (called 75-ohm F-type) on the back of your VCR or TV. The ends screw onto the connectors for a secure connection.

**Push-on Cable** attaches to the round antenna connectors (called 75-ohm F-type) on the back of your VCR or TV. Ends push on for a quick connection.

### Audio/Video Cables

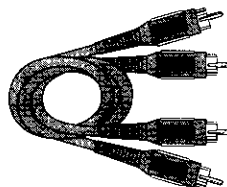

Gold-Tipped cable

VH83 (6-ft)

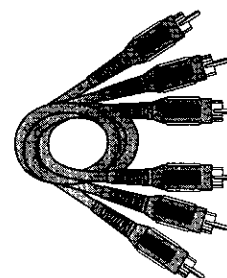

Gold-Tipped cable

VH84 (6-ft)

**Monaural VCR Dubbing Cable** Double cable that lets you connect the video and audio jacks of two VHS VCRs to duplicate tapes. Can also be used to connect a VCR to your TV. Cable is color-coded and shielded. Has RCA-type phono plugs on each end.

**Stereo VCR Dubbing Cable** Triple cable that lets you connect the VIDEO and AUDIO jacks of stereo components.



VH976 (6-ft)

VH913 (12-ft)

**S-Video Cable** has multi-pin connectors on each end for connecting S-Video components to your TV.

# REFERENCE



CRK211TA1

**Remote Control** This is the remote control that came packed with your TV. Replacements or spares can be ordered as needed.

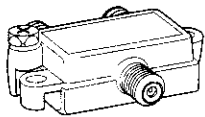

Splitter  
VH47

**2-way Signal Splitter** helps you connect to a second TV or VCR.

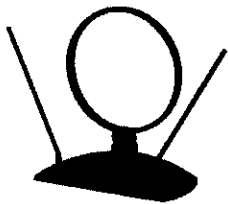

ANT200

**Amplified VHF/UHF/FM Antenna** allows you to easily switch from the antenna signal to cable or satellite easily without disconnecting antenna.

## Accessory Order Form

Description	Part No.	Price	Qty
Screw-on antenna cable (3-ft)	VH81	\$3.95	
Screw-on antenna cable (6-ft)	VH82	\$5.95	
Push-on antenna cable (6-ft)	VH89	\$5.95	
Monaural VCR Dubbing Cable (6-ft)	VH83	\$5.95	
Stereo VCR Dubbing Cable (6-ft)	VH84	\$9.95	
S-Video Cable (6-ft)	VH976	\$7.95	
S-Video Cable (12-ft)	VH913	\$14.95	
2-way Signal Splitter	VH47	\$3.95	
Amplified Antenna	ANT200	\$49.95	
Antenna Mixer	193984	\$11.15	
Remote Control (CRK211TA1)	212178	\$30.35	
Audio•Video Adapter	228449	\$4.45	

Total Merchandise .....	\$
Sales Tax .....	\$
We are required by law to collect the appropriate sales tax for each individual state, country, and locality to which the merchandise is being sent.	
Shipping and Handling .....	\$
Total Amount Enclosed .....	\$ 5.00
Use VISA, MasterCard, or Discover Card preferably.	\$
Money order or check must be in U.S. currency only.	
No COD or CASH.	



Detach Here

All accessories are subject to availability. Prices are subject to change without notice. Where applicable, we will ship a superseding model.

Please complete other side also

# REFERENCE

Charge your order on your VISA, MasterCard, or Discover Card by filling in below

## USE YOUR CREDIT CARD

**IMPORTANT:** Copy complete account number from your VISA card



My card expires:

**IMPORTANT:** Copy complete account number from your MasterCard



Copy Number  
above your  
name on  
MasterCard

My card  
expires:

**IMPORTANT:** Copy complete account number from your Discover Card



My card expires:

## AUTHORIZED SIGNATURE

(Credit card order will not be processed without signature)

Print or type your name and address clearly.



A complete and correct order will save you days of waiting.

Name: \_\_\_\_\_  
 Street: \_\_\_\_\_  
 \_\_\_\_\_ Apt: \_\_\_\_\_  
 City: \_\_\_\_\_  
 State: \_\_\_\_\_ Zip: \_\_\_\_\_  
 Daytime phone number: \_\_\_\_\_

Please make sure that both sides of this form have been filled out completely.

- Allow 4 weeks for delivery.
- All accessories are subject to availability.
- Prices are subject to change.

## Placing an Order

To place your order by phone, have your Visa, MasterCard or Discover Card ready and call the toll-free number listed below.

Use this number only to place an order for accessory items listed on this order form.

**1-800-338-0376**

To place your order by mail, detach and mail the completed order form with credit card information, money order or check in US currency (made payable to Thomson Consumer Electronics, Inc.) to the following address:

**Video Accessories  
PO Box 8419  
Ronks, PA 17573**

# INDEX

- A**
  - Accessories 42
  - Accessory order form 43
  - Add channels 13
  - Advanced connections 4, 6
  - Age-Based Ratings 32
  - ANT connector 6
  - AUDIO jacks 6
  - Audio modes 29
- B**
  - Back panel 6
  - Basic connection 4, 5
  - Batteries 8
  - Buttons on remote 16
- C**
  - Cable/Antenna 6
  - Cables 5, 7
    - Coaxial 4
  - Care and Cleaning 39
  - CC on Mute 28
  - CH <sup>^</sup> or CH <sub>v</sub> buttons 16, 17
  - Change the input 14
  - Channel list 12
  - Channel search 12
  - Channels, add or delete 13
  - Closed Captioning 27
  - Coaxial Cable 4, 5, 7
  - Connections 4
    - advanced 4, 6
    - basic 4, 5
    - TV and VCR 7
    - TV only 4
    - TV, VCR, and satellite receiver 8
  - Content Themes 32
  - Control panels 20
- D**
  - Delete channels 13
- E**
  - External source signal, block 35
- F**
  - Fixed images 39
  - Front panel
    - controls 17
    - jacks 17
- G**
  - Getting started 3
  - GO-BACK button 16
- I**
  - INFO button 16
  - INPUT button 6, 16
  - Input, change 14
- M**
  - Memorize channels 12
  - MENU button 16, 17, 20
  - Menu, exiting 20
  - Menu language 11
  - Menus, changing 20
  - Mono audio 29
  - Movie Ratings 32
  - Movie ratings limits 34
  - MUTE button 16
  - Mute, closed caption 28
- N**
  - No rating feature 35
  - Number buttons 16
- O**
  - Off time, set 24
  - Optional accessories 42
  - Order form, accessory 43
- P**
  - Parental control 30
  - Parental lock feature 30
  - Password 31
  - Password, change 31
  - Point and Select 10
  - POWER button 16, 17
  - Power restore feature 28
  - Problem solving 38
  - Product Registration Inside front cover
- R**
  - Rating limits 30
  - Reception: air or cable-TV 12
  - Remote
    - buttons 16
    - installing the batteries 8
  - Remote sensor 17
- S**
  - SAP audio 29
  - Second Audio Program (SAP) 29
  - Set a Wake-Up time 24
  - Set an Off time 24
  - Set the clock 23
  - Set the Sleep Timer 25
  - Set-Up menu 10
  - Setting TV guidelines 32
  - SLEEP button 16
  - Sleep Timer, set 25
  - Solving problems 38
  - Special menu 26
  - Standby indicator 17
  - Stereo audio 29
- T**
  - Time menu 22
  - Time, set 23
  - Tint 21
  - Troubleshooting 38
  - TV guidelines rating limits 33
  - TV only connection 4
- U**
  - Unpack the TV 4
- V**
  - V-Chip 32
    - age-based ratings 32
    - content themes 32
  - VIDEO
    - button 16
    - jacks 6, 17
  - Video menu 20
  - Video setting, adjust 21
  - VOL < or VOL > button 16, 17
- W**
  - Wake-Up time, set 24

---

Please do not send any products to the Indianapolis address listed in this manual or on the carton. This will only add delays in service for your product.

 **THOMSON CONSUMER ELECTRONICS**  
10330 North Meridian Street  
Indianapolis, IN 46290

©2000 Thomson Consumer Electronics, Inc.  
Trademark(s)® Registered  
Marca(s) Registrada(s)

Printed in USA  
**TOCOM 15600640**

**MODEL:**  
**F19420**  
**F19430**

**PUB: 15600640**