



LIBRARY:

Received _____

Copied _____

Entered _____

LIS _____ NRPDS _____

Received _____

Scanned _____

Batch # _____

JUN 06 2000



We bring good things to life.

SAFETY INFORMATION

WARNING

To reduce risk of fire or shock hazard, do not expose this product to rain or moisture.

WARNING

RISK OF ELECTRIC SHOCK
DO NOT OPEN

TO REDUCE THE RISK OF ELECTRIC SHOCK, DO NOT REMOVE COVER (OR BACK). NO USER SERVICEABLE PARTS INSIDE. REFER SERVICING TO QUALIFIED SERVICE PERSONNEL.



This symbol indicates important instructions accompanying the product.



This symbol indicates "dangerous voltage" inside the product that presents a risk of electric shock or personal injury.

Cautions

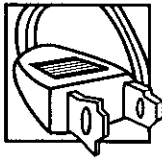

Caution: To prevent electric shock, match wide blade of plug to wide slot, fully insert.

Attention: Pour éviter les chocs électriques, introduire la lame la plus large de la fiche dans la borne correspondante de la prise et pousser jusqu'au fond.

Refer to the identification/rating label located on the back panel of your product for its proper operating voltage.

FCC Regulations state that unauthorized changes or modifications to this equipment may void the user's authority to operate it.

Cable TV Installer: This reminder is provided to call your attention to Article 820-40 of the National Electrical Code (Section 54 of the Canadian Electrical Code, Part 1) which provides guidelines for proper grounding and, in particular, specifies that the cable ground shall be connected to the grounding system of the building as close to the point of cable entry as practical.

Care and Cleaning:

Use a soft cloth or the dusting attachment of your vacuum cleaner to dust your VCR. Remove dust from the ventilation holes.

Plastic surfaces are easily scratched and can be marred by alcohol and various solvents. Avoid excessive use of oil-based furniture polishes since the materials used in the cabinet will accumulate more dust. A nonabrasive, antistatic cleaner/polisher is recommended.

Product Registration

Please fill out the product registration card and return it immediately. Returning the card allows us to contact you if needed.

Keep your sales receipt to obtain warranty parts and service and for proof of purchase. Attach it here and record the serial and model numbers in case you need them. The numbers are located on the back of the product.

Model No. VG4275

Serial No. _____

Purchase Date: _____

Dealer/Address/Phone: _____

VCR Plus+ and PlusCode are registered trademarks of Gemstar Development Corporation.
The VCR Plus+ system is manufactured under the license from Gemstar Development Corporation.

TABLE OF CONTENTS

First Things First	3
Use the QuickSet Guide for Initial Setup	5
Setting Up the VCR	7
Using Menus to Set Up Features	8
Language Selection	8
Cable Box Setup	9
VCR Channels List.....	10
Auto Channel Search	10
Changing the Signal Type	11
Adding or Removing Channels	11
Time and Date	12
Auto Clock Set Feature	12
Setting the Time Zone	12
Setting Daylight-Saving Time	13
Setting Time and Date Manually	13
VCR Plus+ System Channels	15
VCR Plus+ System Worksheet	16
Additional Set-Up Features.....	17
Remote VCR1/VCR2 Option	17
Auto Play	18
Auto TV/VCR.....	18
EnergySaver	19
Front Panel Brightness (VCR Display)	19
Preferred Tape Speed	19
Set Auto Repeat	19
VCR Basics	21
Remote Buttons	22
Component Buttons	22
VCR Function Buttons	22
TV Function Buttons	23
Playing a Tape	24
Recording	25
Recording	27
Recording Features	28
Express Recording (XPR)	28
Timer Recording	29
Timer Recording with VCR Plus+ System	30
Setting Up the Channel List	30
Using the VCR Plus+ System	30
Stopping a Timer Recording	32
Reviewing and Clearing Programs.....	32
Recording Broadcast Stereo TV or SAP (Second Audio Program)	32
Recording Audio Only	33
Copying and Editing Tapes	34

TABLE OF CONTENTS

Program the Remote	35
About Programming the Remote	36
Programming the Remote to Control a TV	36
Operating the TV	36
Other Features	39
Picture Search Options	40
Forward and Reverse Search	40
Slow Motion	40
Frame Advance	40
Index Search	41
Zero Search	41
Commercial Scan (SEARCH Button)	42
Tracking	42
Pro-Tect Plus™ Locking Feature	42
Time Counter	43
On-Screen Displays	43
Audio Setup Features	44
Reception	44
Tape Playback	45
Connections	47
Things to Know Before Connecting Components	47
Connecting Your VCR	48
Jacks and Cables	48
RF Jacks and Coaxial Cables (F-type)	48
Audio/Video Jacks and Cables (RCA-type)	48
Choosing a VCR Connection	49
Advantages of Audio/Video Connections	49
TV with RF Jack Only	50
TV with Audio/Video Jacks	51
TV with Audio/Video Jacks and Cable Box to Unscramble Pay Channels Only	52
Reference	53
Front Panel	54
Display Panel	55
Back Panel	56
How to Find Your TV's Video Input Channel	57
Troubleshooting Tips	58
Specifications	62
Cleaning the VCR	62
Limited Warranty	63
Index	64

FIRST THINGS FIRST

Welcome to your new VCR...

To help you get started using your VCR with as little reading as possible, we've put all the basic information needed in the first three sections.

To help you along, there's even a QuickSet feature the first time you turn on your VCR, which walks you through several setup steps at once.

Getting Started

Before this first step, though, learning about the time and date, your remote control's features, working with channels, and basic video tape operations are essential to get all you can out of the VCR. Once you are comfortable with these features, feel free to refer to other sections because they cover the more detailed information.

What Remains?

The final sections of this manual contain playback and recording information, a detailed connections section, and a reference section including troubleshooting tips, warranty information, and an index.

1 FIRST THINGS FIRST



2 SETTING UP THE VCR



3 VCR BASICS



4 RECORDING



5 PROGRAM THE REMOTE



6 OTHER FEATURES



7 CONNECTIONS



8 REFERENCE

READ ME!

These note boxes give you tips for your new video cassette recorder.

FIRST THINGS FIRST

Step 1: What's In the Box?

The following items come packed in the box:

- VCR
- Remote control
- RF coaxial cable

Step 2: Install Batteries in the Remote Control

Follow these steps whenever you need to install or change the batteries in your VCR's remote:

1. Remove the cover of the battery compartment.
2. Place the batteries into the remote's back panel. Match the positive (+) and negative (-) ends of each battery to the diagram inside the battery compartment.
3. Replace the cover.

Step 3: Connect the VCR

If you connect your VCR to your home antenna or cable system and then to your TV, use the VCR's ANT. IN and OUT TO TV jacks for a good signal as shown to the right.

If you have a TV with AUDIO/VIDEO jacks, use the jacks for a better connection. Refer to the section, *Connections*, toward the back of the manual, for additional connection options.

Step 4: Plug in the VCR

Your VCR's power cord has a plastic band strung through the blades. **Remove plastic band before plugging the cord into the power outlet.** To remove band, cut with a pair of scissors and pull it free of the blades. Once the plastic is removed, match the wide blade of the power cord to the wide slot in the AC outlet. Be sure to insert the plug completely.

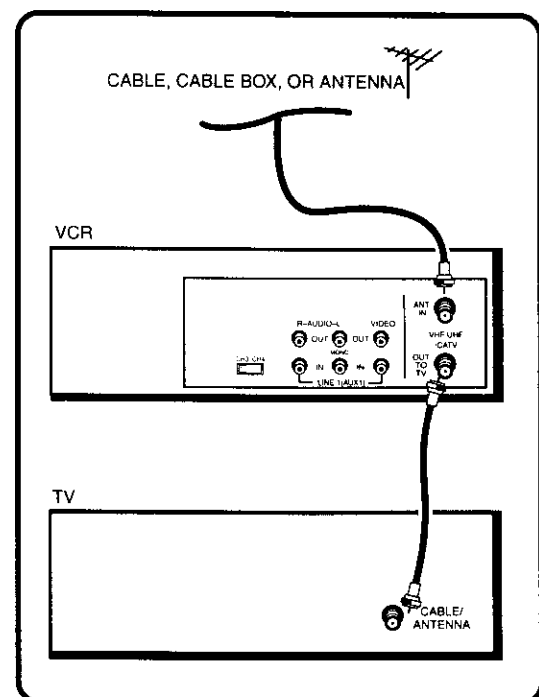
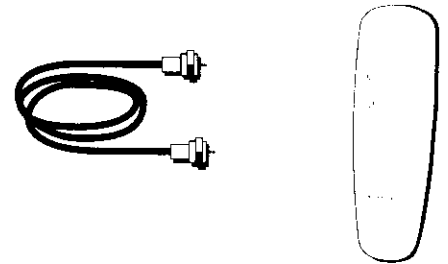

FIRST THINGS FIRST

Step 5: Tune the TV

Tune the TV to the VCR viewing channel. The VCR viewing channel is channel 3 or 4 or the TV's video input.

- If you connect your VCR using the ANT. IN and OUT TO TV jacks with RF coaxial cable, set the CH3 CH4 switch to channel 3 or channel 4 — the channel you want to use on your TV.
- If you connect your VCR using the AUDIO/VIDEO jacks with audio/video cables, select the TV's video input with the remote's TV and INPUT buttons to see the signal. See "How to Find Your TV's Video Input Channel" in the *References* section of this manual for more information about video line input.

Step 6: Turn on the VCR

Press POWER on the VCR's front panel or VCR on the remote to turn on the VCR. The first time you turn the VCR on, a menu screen appears. This is the start of an initial setup which helps you set different options for your VCR.

Step 7: Use the QuickSet Guide for Initial Setup

The first on-screen menu during the initial set up asks which language you prefer to use for your VCR. Use the remote control's number buttons to select options.

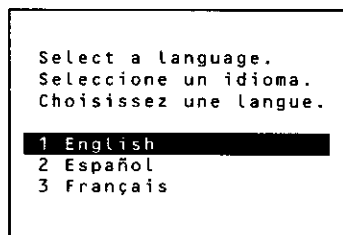

1. Press 1 for English, 2 for Español (Spanish), or 3 for Français (French).

The remaining menus throughout the set up will appear in the chosen language. Just follow the step-by-step questions until the setup is complete.

Continued on Next Page

VCR Viewing Channel

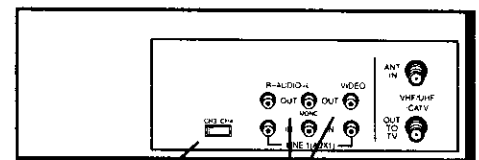

CH3 CH4 switch A/V input/output jacks

When using the ANT. IN and OUT TO TV jacks to connect the VCR, tune the TV to channel 3 or 4 (whichever isn't used for local broadcasting). The CH3 CH4 switch on the back of the VCR determines which TV channel is used to see the VCR's output. Use the same channel that the TV is tuned to.

When using the Audio/Video jacks to connect the VCR, tune the TV to its video input channel using the INPUT button on the VCR's remote control (make sure you have selected "TV" on the remote first).

For more information about the TV's video line input, see, "How to Find the TV's Video Input Channel" in the *Reference* section of this manual.

FIRST THINGS FIRST

If the menu does not appear:

- Make sure the TV is tuned to the same channel as the CH3 CH4 switch or its video input (see "How to Find Your TV's Video Input Channel" in the *References* section of this manual for more information).
- Make sure the VCR indicator is on in the VCR display if you connected your VCR using the ANT. IN and OUT TO TV jacks.
- Check your connections.

If you choose to set up your VCR options individually, then go to the next section.

Step 8: Accessing Menus On Screen

The MENU and number buttons on the remote let you access, select, and change your VCR's preferences. For example, to select a different preferred on-screen language than the one you selected during the initial set up, do the following:

1. Press MENU to display the VCR MAIN MENU.

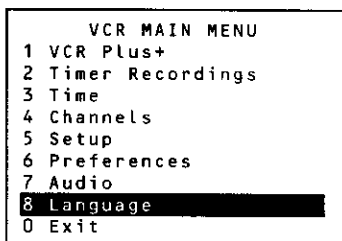

2. Press 8 to display the LANGUAGE menu.

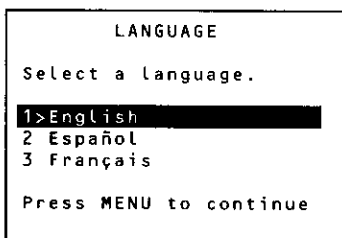

3. Press 1 for English, 2 for Español (Spanish), or 3 for Français (French).

All other on-screen menus are worked in similar ways using the remote control to follow on-screen instructions. See *Additional Set-Up Features* in the next section for detailed information about individual menus.

Maneuvering Menus

The up and down CHAN buttons on the remote control can be used to move the menu highlight bar and the MENU button on the remote will select the highlighted entry. Note that if you use the Channel up and down buttons on the VCR front panel, you will not be able to select the highlighted entry.

SETTING UP THE VCR

Additional Setup Features

Below is a list of features that need to be set up before using your VCR for the first time. Many of these menus are covered during the initial setup, but if you ever want to change a menu, refer to this section.

- Language
- Cable Box Set Up
- VCR Channels List (Auto Channel Search)
- Auto Clock (also sets time zone and Daylight-Saving Time)

- or -

- Manual Clock Set
- VCR Plus+ Channels List
- Remote VCR1/VCR2
- Auto Play*
- EnergySaver*
- Front Panel Brightness*
- Preferred Tape Speed*

1 FIRST THINGS FIRST



2 SETTING UP THE VCR



3 VCR BASICS



4 RECORDING



5 PROGRAM THE REMOTE



6 OTHER FEATURES



7 CONNECTIONS



8 REFERENCE

* Features which are NOT handled during the VCR's QuickSet initial setup and must be set manually.

SETTING UP THE VCR

Using Menus to Set Up Features

You can set up your VCR's features by using the remote control's buttons to enter your choices from on-screen instructions. Each menu item is explained in this section. For each numbered selection on the menus, use the same numbered button on the remote control to select it.

Language Selection

If you did not complete this step in the previous section using the initial setup, it is time to select your preferred language. Once this step is complete, all on-screen displays will appear in that language.

1. On your remote control, press the MENU button to display the VCR MAIN MENU.

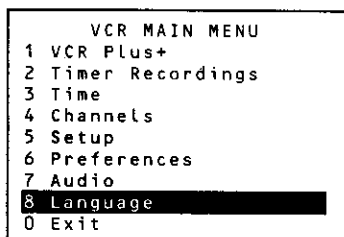

2. Press 8 to select the LANGUAGE menu.

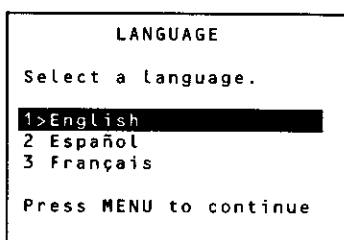

3. Press 1 for English, 2 for Español (Spanish), or 3 for Français (French). An arrow indicates the selection you've made. Once you have made your choice, press MENU on the remote to continue back to the VCR MAIN MENU.

Is Something Missing?

Not all the VCR screens will always be shown in this manual when explaining the features.

SETTING UP THE VCR

Cable Box Setup

This set up applies **only** when all channels are received through a cable box. In this case, the VCR will automatically enter the channel used to view cable box programming. Your VCR will use this channel for all future timer recordings.

1. Press MENU to display the VCR MAIN MENU.

```
VCR MAIN MENU
1 VCR Plus+
2 Timer Recordings
3 Time
4 Channels
5 Setup
6 Preferences
7 Audio
8 Language
0 Exit
```

2. Press 4 to display the CHANNELS menu.

```
CHANNELS
1 Auto Channel Search
2 Add/Remove Channels
3 Signal Type: CABLE
4 VCR Plus+ Channel List
5 Cable Box Setup
0 Exit
```

3. Press 5 to display CABLE BOX SETUP. Then select one of the three choices.

```
CABLE BOX SETUP
Do you use your cable
box to receive ALL
channels or only SOME
channels?
1 ALL channels
2 Only SOME channels
3 Cancel setup
```

4. If you selected ALL Channels, enter the output channel of your cable box (usually 03 or 04), or press the INPUT button on the VCR's remote to select the VCR's video input channel if you used the AUDIO/VIDEO jacks.

```
CABLE BOX SETUP
On what channel does
the VCR receive signals
from the cable box?
(usually 3, 4, or Video)
--
Enter 01-13 or INPUT
Press MENU to cancel
```

```
CABLE BOX SETUP
On what channel does
the VCR receive signals
from the cable box?
(usually 3, 4, or video)
04
Press CLEAR to correct
Press MENU to continue
```

Choosing the Right Setup for Your Cable Box

If you use your cable box to receive: **ALL channels**— enter two numbers for the output channel of your cable box or press INPUT if you connect your cable box with AUDIO/VIDEO jacks.

Only SOME channels— choose this option if you only use the cable box to unscramble premium channels.

Cancel setup will take you to a screen stating your VCR will not control the cable box channel during timer recordings.

Continued on Next Page

SETTING UP THE VCR

- Once you complete the setup, the VCR confirms that the VCR will now receive all signals on the designated channel.

```
CABLE BOX SETUP
.
The Cable Box Setup
is complete.

The VCR will NOT control
the cable box channel
during timer recordings.

Press MENU to continue
```

VCR Channels List

If you use a cable box for *all channels*, this step is not necessary. Your VCR may come with a channel list preset at the factory, but you may want to add or delete some channels depending on whether they are active.

Auto Channel Search

- Press MENU to display the VCR MAIN MENU.
- Press 4 to display the CHANNELS menu.

```
CHANNELS
1 Auto Channel Search
2 Add/Remove Channels
3 Signal Type: CABLE
4 VCR Plus+ Channel List
5 Cable Box Setup

0 Exit
```

- Press 1 to display the AUTO CHANNEL SEARCH menu.

```
AUTO CHANNEL SEARCH

What type of signal
are you using?

1 Cable TV
2 Antenna
3> Detect Automatically

0 Cancel
```

- Select one of the three AUTO CHANNEL SEARCH options. The current choice is highlighted with an arrow symbol at the left.
 - Cable TV* searches for cable stations broadcast from a single channel.
 - Antenna* searches for local broadcast stations on all channels.

SETTING UP THE VCR

- *Detect Automatically* makes this determination without assistance.

```
AUTO CHANNEL SEARCH

Now scanning channel 14

Press any key to cancel
```

The VCR scans for available channels which takes about one-to-two minutes. When the scan is complete, the VCR tunes to the lowest channel number available. At this point, pressing CHAN up or down on the VCR or remote control should only select the active channels.

Changing the Signal Type

1. Press MENU to display the VCR MAIN MENU.
2. Press 4 to display the CHANNELS menu.
3. Press 3 to change the Signal Type between CABLE and ANTENNA.

Adding or Removing Channels

You may want to add or remove channels after you Auto Channel Search, especially if some of the channels have weak signals or you don't want to watch them.

1. Press MENU to display the VCR MAIN MENU.
2. Press 4 to display the CHANNELS menu.
3. Press 2 to display the ADD/REMOVE CHANNELS screen. Use CHAN up or down or number buttons to go to the channels to be removed or added.

```
ADD/REMOVE CHANNELS

Channel 115
is presently ADDED

Press CLEAR to remove
Press MENU to exit
```

```
ADD/REMOVE CHANNELS

Channel 115
is presently REMOVED

Press INFO to add
Press MENU to exit
```

4. Follow the on-screen instructions to finish this set up.

Auto Channel Search

Use the Auto Channel Search feature to place all available channels in memory.

If you ever change cable or antenna signals, you may need to Auto Channel Search again.

Detect Automatically

A strong cable or antenna signal in your area may cause Auto Detect to mis-detect. If this should happen, select 1 or 2 for the system you have.

SETTING UP THE VCR

Time and Date

The VCR gives you two ways to set the time and date: the Auto Clock Feature or manually. The Auto Clock Feature enables the VCR to update the clock each time the VCR is turned off. Auto Clock is advantageous because it updates the time automatically.

Before setting the time and date, set the Auto DST (Daylight-Saving Time) feature to ON or OFF for your area.

Auto Clock Set Feature

The Auto Clock Set feature is set to ON at the factory. In the ON setting, the VCR looks for a channel carrying XDS (Extended Data Services) information. XDS updates the clock using the Coordinated Universal Time. There are certain steps that are required, such as Auto Channel Search, setting the Time Zone, and Daylight Saving feature before the Auto Clock feature works.

Setting the Time Zone

1. Press MENU on the remote to display the VCR MAIN MENU.

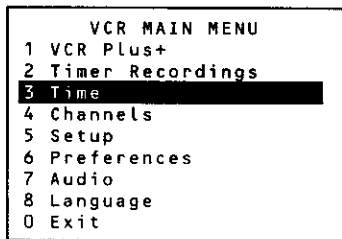

2. Press 3 to display TIME menu.

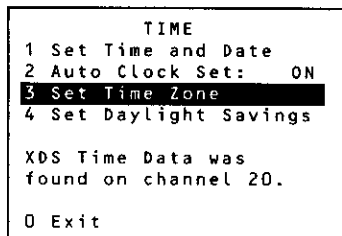

3. Press 3 again to display the SET TIME ZONE menu.

Selecting Channels

The Channel up and down buttons access those channels active in your VCR channel list.

You can still access channels not in the channel list by using the number buttons on the remote.

SETTING UP THE VCR

```
SET TIME ZONE
What is your Time Zone?
1 Eastern
2 Central
3 Mountain
4 Pacific
5 Alaska
6 Hawaii
7>Automatic
Press MENU to continue
```

4. Select the correct time zone.

If "Automatic" is selected as the time zone, the VCR sets the clock using the first Coordinated Universal Time information it finds in a broadcast signal. If the time is not correct, select another time zone or set the time and date through the menu system.

Setting Daylight-Saving Time

1. Press MENU to display the VCR MAIN MENU.
2. Press 3 to display the TIME menu.
3. Press 4 to display the SET DAYLIGHT SAVINGS menu.

```
SET DAYLIGHT SAVINGS
Does your area observe
Daylight Savings Time
from April to October?
1 Yes, DST is observed
2 No
3>Automatic
Press MENU to continue
```

4. Select one of the options.
 - DST is the acronym for Daylight Saving Time.
 - If you chose AUTOMATIC, the VCR sets the clock using the DST information broadcast in the signal (channel).

Setting Time and Date Manually

If the Auto Clock Set was unsuccessful, set the clock through the menu option. The Auto Clock Set feature is set to OFF automatically when you set the clock this way.

1. Press MENU to display the VCR MAIN MENU.

Continued on Next Page

Auto Clock Information

With a cable box, the VCR will not reset the clock after a power outage unless the cable box is turned on to the channel carrying the XDS signal.

If Auto Clock Set is unsuccessful, try tuning the VCR (or cable box) to a channel carrying the broadcast information (usually PBS), then turn the VCR off. If the time does not set within ten minutes, set the time and date manually through the menu.

Check your local cable system or TV stations for availability of channels with XDS.

SETTING UP THE VCR

```
VCR MAIN MENU
1 VCR Plus+
2 Timer Recordings
3 Time
4 Channels
5 Setup
6 Preferences
7 Audio
8 Language
0 Exit
```

2. Press 3 to display the TIME menu.

```
TIME
1 Set Time and Date
2 Auto Clock Set: ON
3 Set Time Zone
4 Set Daylight Savings

XDS Time Data was
found on channel 20.

0 Exit
```

3. Press 1 to display the SET TIME AND DATE menu.

```
SET TIME AND DATE

Time --:--
      (hh:mm)

Date --/--/--

Press MENU to cancel
```

4. Enter the data using the number buttons. Press 0 before single-digit numbers and follow the on-screen directions.

```
SET TIME AND DATE

Time 12:34 PM

Date 11/18/99 Thursday

Press CLEAR to correct
Press MENU to set
```

Spring Forward; Fall Back

In the Spring, Daylight Saving Time begins on the first Sunday in April. Because the clock automatically changes from 2:00 AM to 3:00 AM (forward one hour), remember to include the extra hour for timer recording falling within this time frame.

In the Autumn, Daylight Saving ends on the last Sunday in October. The VCR clock automatically changes from 2:00 AM to 1:00 AM (back one hour). Therefore, this can also affect timed recording length.

SETTING UP THE VCR

VCR Plus+® System Channels

Using the VCR Plus+ system makes programming timer recordings for cable or off-air antenna easier, but you have to put in a little time right now to set up a channel list. A worksheet and abbreviated codes for typical cable services in the U.S. and Canada are provided.

1. Press MENU to display the VCR MAIN MENU.

```
VCR MAIN MENU
1 VCR Plus+
2 Timer Recordings
3 Time
4 Channels
5 Setup
6 Preferences
7 Audio
8 Language
0 Exit
```

2. Press 4 to display the CHANNELS menu.

```
CHANNELS
1 Auto Channel Search
2 Add/Remove Channels
3 Signal Type: CABLE
4 VCR Plus+ Channel List
5 Cable Box Setup

0 Exit
```

3. Press 4 to display the VCR Plus+ Channel List screen.

```
VCR+ Channel My Channel
5 -- --
4 -- --
3 -> -> -> --
2 -- --
1 -- --

Use CH +/- to select
Press 0-9 to change
Press MENU to save
```

4. Enter the data following the on-screen directions using your worksheet (see next page).

```
VCR+ Channel My Channel
5 46
4 --
3 -> -> -> 23
2 --
1 --

Use CH +/- to select
Press 0-9 to change
Press MENU to save
```

Screen is for an example only.

Two-Digit VCR Plus+ System Channel Numbers for Cable TV (Canadian List)

35	American Movie Classics
39	Arts & Entertainment
57	Black Entertainment
54	Bravo
42	Cable News Network
45	Cinemax
98	Cinemax 2
37	The Discovery Channel
53	The Disney Channel
63	Entertainment Television
34	ESPN Sports Network
47	The Family Channel
33	Home Box Office
95	Home Box Office 2
96	Home Box Office 3
51	The Learning Channel
46	Lifetime
58	The Movie Channel
48	Music Television
49	The Nashville Network
38	Nickelodeon
64	Nostalgia Television
99	Quality Value Cable
41	Showtime
97	Showtime 2
59	Sports Channel
52	Turner Network Television
44	USA-Network
62	Video Hits 1
93	Viewer's Choice 1
94	Viewer's Choice 2
55	WGN Chicago
43	WTBS Atlanta
60	WWOR-New York

See next page for Canadian List

VCR Plus+ System Channel List

Refer to your local television list for a complete VCR Plus+ channel list for your viewing area or contact your cable company. Using the list may save you some time.

VCR Plus+ and PlusCode are registered trademarks of Gemstar Development Corporation.
The VCR Plus+ System is manufactured under the license from Gemstar Development Corporation.

SETTING UP THE VCR

VCR Plus+ System Worksheet

Broadcast or Cable-TV Station Name	VCR Plus+ Channel Number**	Channel Number You Receive the Station On*
HBO	33	
ESPN	34	

*Check your local or cable listing for the channel number you receive this station on.
 **Check your local listing for broadcast or VCR Plus+ channel number assigned.

Two-Digit VCR Plus+ System Channel Numbers for Cable TV (Canadian List)

- 67 Allarcom Pay Television/
Superchannel
- 44 Arts & Entertainment
- 72 Cable News Network-
Headline News
- 61 Cable News Network
- 70 Canadian Home Shopping
Network
- 56 Canal Famille
- 69 Cathay International
Television Inc.
- 68 Chinavision Canada Corp
- 60 Country Music Television
- 63 Family Channel
- 62 First Choice
- 96 First Choice Two
- 97 First Choice Three
- 99 First Choice Four
- 90 House of Commons
- 91 La Chaine Francaise
- 51 The Learning Channel
- 65 MeteoMedia/The Weather
Network
- 48 MuchMusic Network
- 55 MusiquePlus
- 52 Nashville Network
- 73 Newsworld/CBC
- 53 Le Reseau des Sports
- 43 The Sports Network
- 64 Super Ecran
- 37 Super Ecran B
- 98 Super Ecran C
- 66 Telatino Network
- 46 TV5 Montreal
- 92 Viewer's Choice 1
- 93 Viewer's Choice 2
- 94 Viewer's Choice 3
- 95 Viewer's Choice 4
- 71 Vision TV: Canada's
Faith Network
- 38 Youth TV, Canada Inc.

SETTING UP THE VCR

Additional Set-Up Features in the PREFERENCES Menu

The features in this section are all accessed through the PREFERENCES menu.

1. Press MENU to display the VCR MAIN MENU.

VCR MAIN MENU	
1	VCR Plus+
2	Timer Recordings
3	Time
4	Channels
5	Setup
6	Preferences
7	Audio
8	Language
0	Exit

2. Press 6 to display the PREFERENCES menu.

PREFERENCES	
1	Remote Control: VCR1
2	Auto Play: ON
3	Auto TV/VCR: ON
4	EnergySaver: 2:00
5	Front Panel: AUTO
6	Tape Speed: SLP
7	Set Auto Repeat
0	Exit

Now you are ready to select an item from the menu to set up.

Remote VCR1/VCR2 Option

If you own a compatible GE, RCA, or PROSCAN remote that has a VCR2, VCR2•LD, or VCR2•DVD button, this feature allows you to set this VCR to respond to that button.

Press 1 to select the Remote Control item. Then press the VCR2, VCR2•LD, or VCR2•DVD button to change.

PREFERENCES	
(PRESS VCR2 TO CHANGE)	
2	Auto Play: ON
3	Auto TV/VCR: ON
4	EnergySaver: 2:00
5	Front Panel: AUTO
6	Tape Speed: SLP
7	Set Auto Repeat
0	Exit

PREFERENCES	
1	Remote Control: VCR2
2	Auto Play: ON
3	Auto TV/VCR: ON
4	EnergySaver: 2:00
5	Front Panel: AUTO
6	Tape Speed: SLP
7	Set Auto Repeat
0	Exit

Remote Control Option

Changing the remote option to VCR2 disables the remote that came with your VCR.

Continued on Next Page

SETTING UP THE VCR

The VCR will only respond to the compatible remote's VCR2, VCR2•LD, or VCR2•DVD button. If you change the remote setting to VCR2, the remote that came with your VCR will no longer control it.

Use the compatible remote to change the remote setting back to VCR1. Display the PREFERENCES menu, press 1, and then press VCR on the VCR's remote.

Auto Play

This feature allows the VCR to automatically start playing when you insert a tape with the safety tab removed. In the PREFERENCES menu, press 2 to switch between ON or OFF.

- Select ON if you want a tape with its safety tab removed to start playing automatically when the tape is inserted.
- Select OFF if you *do not* want a tape with its safety tab removed to start playing automatically.

Auto TV/VCR

This feature controls whether the TV/VCR switch changes automatically to the VCR mode. Press 3 to switch between ON and OFF.

- Select ON if you want the VCR to switch to the VCR mode when the VCR is turned on or a cassette is inserted. *This only applies if you connect the ANT. IN and OUT TO TV jacks of your VCR to your TV and watch your VCR on channel 3 or 4 of your TV.*
- Select OFF if you want the VCR to remain in the TV mode. This is useful if you watch your VCR on the TV's video input and you don't want your antenna/cable signal interrupted by the VCR. Refer to the *Connections* section, toward the back of the manual.

Auto Play

For a tape to be able to start playing automatically, it must have the safety tab removed. All rented movies and purchased movies should have this tab removed.

Auto TV/VCR

Pressing TV•VCR will still switch between the VCR and TV mode.
VCR mode: VCR indicator in the display panel lights.
TV mode: VCR indicator turns off.

SETTING UP THE VCR

EnergySaver

By default, this VCR automatically turns off after two hours of inactivity. In the PREFERENCES menu, press 4 to change the time delay, or to disable the feature.

- OFF: The VCR will remain turned on until you shut it off.
- 1:00, 2:00, or 3:00: The VCR turns off after one, two, or three hours of inactivity.

Thirty seconds before shutting off, the VCR will warn you with a screen reading, "The VCR will turn off in 30 seconds. Press any key to cancel."

If you use the VCR's tuner instead of your TV to tune channels, you may want to turn this feature off.

Front Panel Brightness (VCR Display)

The brightness level of the fluorescent display panel on the front of the VCR can be to be less or more bright. In the PREFERENCES menu, press 5 to switch between the options.

- AUTO brightens the display when the VCR is on and dims the display when the VCR is off.
- BRIGHT keeps the display bright.
- DIM keeps the display at a low brightness level.

Preferred Tape Speed

You can set the preferred tape speed between Standard Play (SP) and Super Long Play (SLP). In the PREFERENCES menu, press 6 to toggle between the options.

- SP sets the preferred recording speed to SP.
- SLP sets the preferred recording speed to SLP.

Set Auto Repeat

A tape can be set to play the same segment over and over in a repeating loop with the Set Auto Repeat feature. Set Auto Repeat uses the VCR's memory counter to determine the duration of the loop.

PREFERENCES	
1 Remote Control:	VCR1
2 Auto Play:	ON
3 Auto TV/VCR:	ON
4 EnergySaver:	2:00
5 Front Panel:	AUTO
6 Tape Speed:	SLP
7 Set Auto Repeat	
0 Exit	

The PREFERENCES menu allows access to settings for the remote control, energy saving mode, front panel brightness, and more.

Tape Speeds

SP (Standard Play)

Gives the best quality recording, but fewer programs can be recorded on the tape. Special effects such as pause, slow motion, picture search, and frame advance work well when you play back tapes recorded in this speed.

SLP (Super Long Play)

Gives three times the recording time of tapes recorded in SP. Special effects such as pause, slow motion, picture search, and frame advance work well when you play back tapes recorded in this speed.

	Recording Time		
Cassette	SP	SLP	
T-120	2 hr	6 hr	
T-160	2 hr/40 min	8 hr	

Continued on Next Page

SETTING UP THE VCR

The Set Auto Repeat dialog box will ask for a loop end time to be specified:

```
AUTO REPEAT
Set the Length of time
you want the tape to
play in a repeating loop
Loop from 0:00 to -:--
                    (h:mm)
Press MENU to exit
```

- The CLEAR key will erase all three numbers entered and move the cursor back to the first position (hours).
- The "Press CLEAR to turn off" message will appear only after the first number has been entered into the end time.
- Auto Repeat is set back to -:-- by resetting the dialog box, by cassette ejecting or insertion, by powering off the VCR, by power interruption, or by recording start.

When a duration time has been set:

- The VCR will automatically switch to rewind if the counter meets or goes past the Auto Repeat set duration.
- The VCR will automatically switch to playback during rewind if the counter equals or is less than 0:00.
- The Auto Repeat may be adjusted by setting the counter to 00:00. This can be done by pressing the CLEAR button while the tape counter is on screen or on the front panel display.
- The counter will not reset while rewinding in an Auto Repeat loop. Front Panel Brightness (VCR Display)

You can change the brightness level of the fluorescent display panel on the front of the VCR. Press 5 to switch between the options.

- AUTO brightens the display when the VCR is on and dims the display when the VCR is off.
- BRIGHT keeps the display bright.
- DIM keeps the display at a low brightness level.

VCR BASICS

Learn the Basics To Get You Started

These VCR basics should be enough for you to begin enjoying your VCR. Learning the remote control functions, playing a recorded tape, and recording a program should do just that.

This section shows you the basics of using your VCR. It discusses things like using the remote control, playing a tape, and recording programs.

1 FIRST THINGS FIRST



2 SETTING UP THE VCR



3 VCR BASICS



4 RECORDING



5 PROGRAM THE REMOTE



6 OTHER FEATURES



7 CONNECTIONS



8 REFERENCE

VCR Basics tells you what you need to know in order to watch a movie or tape your favorite show.

VCR BASICS

Remote Buttons

The remote control is capable of controlling your VCR and many brands of televisions. If you have a GE, RCA or PROSCAN TV, you may be able to control it without having to program the remote.

Component Buttons

ON•OFF Turns off VCR when remote is set to control the VCR. Also turns some compatible components on and off.

TV Turns on a compatible GE, RCA, or PROSCAN TV and sets the remote to control the TV. Also used with the ON•OFF button to turn on a different brand of TV (if programmed) and sets the remote to control the TV.

VCR Turns on a compatible GE, RCA, or PROSCAN VCR and sets the remote to control the VCR.

VCR Function Buttons

CHAN Up or Down Selects next higher or lower channel in the VCR's channel memory.

CLEAR Resets time counter to 0:00:00. Allows you to change entries when setting the clock or a timer recording.

F.ADV Lets you view one frame with each press of the button when tape is in pause.

FORWARD Fast forwards the tape when the VCR is stopped. Searches forward through a tape during playback. Starts slow motion during play-pause and increases slow-motion speed.

GO BACK Switches between two channels. Select one channel and then select another using the number buttons. Press GO BACK to switch between the two channels. In menu mode, press to go back to a previous menu.

INFO Shows the status displays on the TV screen.

INPUT Selects between the VCR's line input or tuner. Line input refers to the signal coming from the component connected to the AUDIO/VIDEO IN jacks on the back or front of the VCR.

MENU Brings up VCR MAIN MENU on the TV screen.

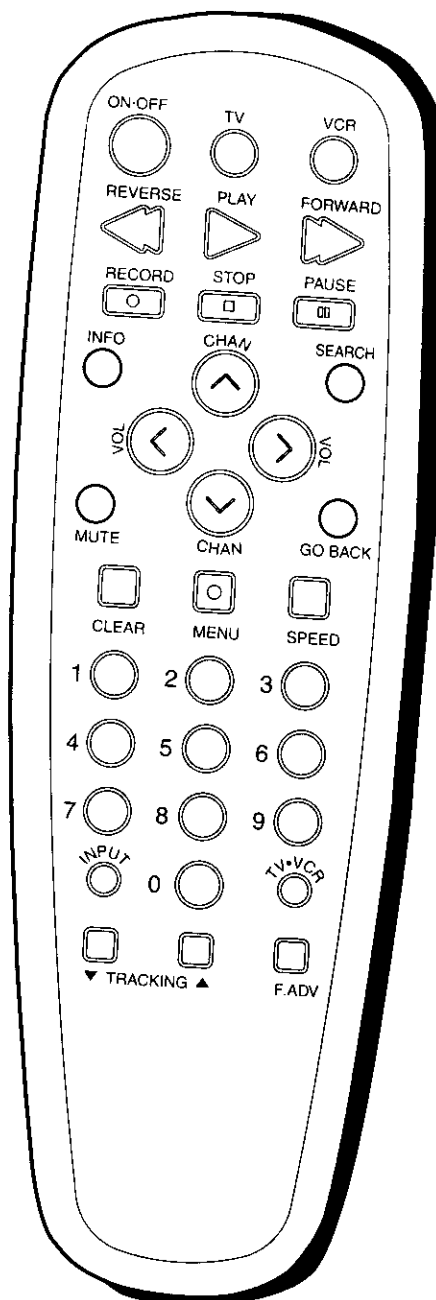

VCR BASICS

Numbers (0 through 9) Select a channel up to 99 by pressing two numbers. Select a cable channel over 99 by pressing and holding 1 until 1 -- appears on the screen. Then press the other two numbers.

PAUSE Pauses playback or recording. Press PAUSE again to return to playback or recording.

PLAY Plays a tape.

RECORD Starts VCR recording. Also used for Express recording.

REVERSE Rewinds the tape when the VCR is stopped. Searches backward through a tape during playback. Starts slow motion during play-pause and decreases slow-motion speed.

SEARCH Displays INDEX and Go-To Search menus on TV screen when VCR is stopped. Advances the tape 30 seconds of recorded material during playback. Each press advances the tape an additional 30 seconds up to five minutes.

SPEED Selects a recording speed (SP or SLP).

STOP Stops the current VCR function such as record, playback, rewind, or fast forward.

TRACKING Up or Down Lets you manually reduce the streaks that may appear on the picture during play, slow motion, or pause. Reduces picture "jitter" during stop-action playback.

TV•VCR Switches the picture signal so that it either comes from the VCR or cable/antenna system.

TV Function Buttons

CHAN Up or Down Selects next higher or lower channel in the TV's channel memory.

CLEAR Removes menus or status displays from the screen.

GO BACK Switches between two channels. Select one channel and then select another using the number buttons. Press GO BACK to switch between the two channels.

INFO Shows the TV's status displays on the TV screen.

INPUT Selects between the TV's input channel or tuner. Press to see the VCR signal if you connected your VCR using the AUDIO/VIDEO jacks.

TV Buttons

The TV buttons may not control all features of all models of GE, RCA, or PROSCAN TVs.

If you cannot get a picture on the TV screen, see, "How to Find Your TV's Video Input Channel" or "Troubleshooting," both of which are in the *Reference* section of this manual.

Continued on Next Page

VCR BASICS

MUTE Reduces volume to minimum level.

Numbers (0 through 9) Select a channel up to 99 by pressing two numbers. Select a cable channel over 99 by pressing and holding 1 until 1 -- appears on the screen. Then press the other two numbers.

ON•OFF Turns a compatible TV off and on.

VOL Up and Down Raises and lowers sound of TV.

Playing a Tape

1. Tune the TV to your VCR viewing channel (3, 4, or TV's video input- see "How to Find Your TV's Video Input Channel" in the *References* section of this manual for more about the video line input).
2. Insert a tape in the VCR.

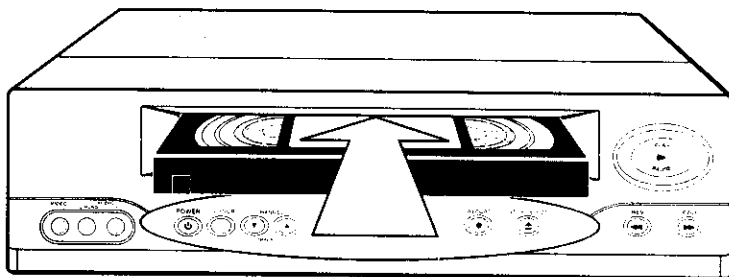

If the Auto Play feature is set to ON, the tape automatically begins playback (if the safety tab on the cassette is removed).

- Press FWD on the VCR (FORWARD on remote) or REV on the VCR (REVERSE on remote) to position the tape.
- Press PLAY PAUSE (if necessary) on the VCR (PLAY on remote) to begin tape play.
- Press PLAY PAUSE (PAUSE on remote) for stop action.
- Press TRACKING up or down to remove any streaks from the picture, if necessary.
- Press STOP•EJECT on VCR (STOP on remote) to stop playback.

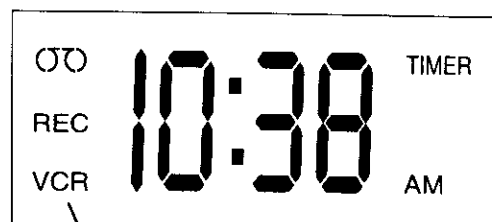

The VCR display indicates that the unit is in VCR mode, suitable to watch a tape.

Pause

If you pause, the VCR automatically switches from pause to stop after a few minutes to reduce tape wear.

Automatic Tracking

The VCR has automatic tracking which adjusts the picture when playing back a tape recorded on another VCR. Automatic tracking is turned on whenever a tape is inserted or the VCR's power is turned on.

VCR BASICS

Automatic Rewind

The VCR automatically rewinds the tape if it reaches the end of the tape during playback. While rewinding, you can press **POWER** on the VCR (**ON•OFF** on remote) and the VCR will turn off after rewinding.

Tape Eject

Press **STOP•EJECT** on the VCR (**STOP** on remote for a few seconds) when it is stopped to eject the tape. A tape can be ejected even when the VCR is off.

Recording

If you want to record something that you're watching, you can use basic recording. For more detailed information, refer to the "Recording" section starting on the next page.

1. Set the tape speed by pressing the **SPEED** button on the remote.
2. Press the **RECORD** button to begin recording.
3. Press **STOP** to stop recording.

If you just want to pause the recording for a short time (such as during a commercial), press **PAUSE** instead of **STOP**.

- For more information about in-depth recording features, refer to the next section.

Check the Safety Tab

No matter which recording option you use, you need to make sure there is a tape in the VCR, and that the tape's safety tab is in place. You cannot record on a tape with the safety tab removed.

If the safety tab is removed and you want to record over it, simply cover the hole with vinyl tape.



Safety Tab

Tape Speeds

SP (Standard Play)

Gives the best quality recording, but fewer programs can be recorded on the tape. Special effects such as pause, slow motion, picture search, and frame advance work well when you play back tapes recorded in this speed.

SLP (Super Long Play)

Gives three times the recording time of tapes recorded in SP. Special effects such as pause, slow motion, picture search, and frame advance work well when you play back tapes recorded in this speed.

Recording Time

<u>Cassette</u>	<u>SP</u>	<u>SLP</u>
T-120	2 hr	6 hr
T-160	2 hr/40 min	8 hr

RECORDING

Several Recording Options

Now that you've gone through the necessary steps to operate your VCR, it's time to explain the different recording features available to suit your needs including:

- Recording (explained in *VCR Basics* section)
- Express Recording
- Timer Recording
- Timer Recording with VCR Plus+ system
- Broadcast Stereo or Second Audio Program (SAP)
- Audio Only Recording
- Copying and Editing Tapes

1 FIRST THINGS FIRST



2 SETTING UP THE VCR



3 VCR BASICS



4 RECORDING



5 PROGRAM THE REMOTE



6 OTHER FEATURES



7 CONNECTIONS



8 REFERENCE

RECORDING

Recording Features

There are four ways to record programs:

- **Recording** press RECORD to start recording a program. (See *VCR Basics* section.)
- **Express Recording (XPR)** starts recording a program you are watching. You can then set the VCR to automatically stop recording after a designated period of time.
- **Timer Recording** programming the VCR to automatically start and stop recording at a predetermined time.
- **VCR Plus+ System** a timer program allowing the VCR to record just by entering a PlusCode programming number found in most TV guides.

Express Recording (XPR)

Use Express recording to quickly record the remaining portion of the program you are watching.

1. Set the tape speed by pressing the SPEED button on the remote control.
2. Press the RECORD button to begin recording.
3. Repeatedly press the RECORD button to set up the recording duration.

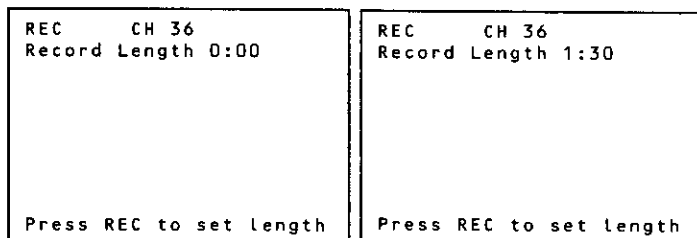

Each time you press the RECORD button, you increase the recording time (up to 4 hours).

The VCR continues to record for the amount of time you indicate, and then automatically turns off.

To stop an Express recording, press and hold STOP on the remote control for a few seconds.

Express Recording

Express recording is a great way to tape the last quarter of the game, or the last part of a movie when you have to leave.

RECORDING

Timer Recording

You can set up as many as eight timer recording programs.

1. Press MENU to display the VCR MAIN MENU.

```
VCR MAIN MENU
1 VCR Plus+
2 Timer Recordings
3 Time
4 Channels
5 Setup
6 Preferences
7 Audio
8 Language
0 Exit
```

2. Press 2 to display the TIMER RECORDINGS menu.

```
TIMER RECORDINGS
1 Create a New Program
2 Review Existing Progs.
3 Use VCR Plus+ Code

0 Exit
```

3. Select 1 to Create a New Program.

```
How often should this
program record?
1 One time
2 Daily (every day)
3 Weekdays (M-F)
4 Weekly (once per week)
0 Cancel
```

4. Select how often you want the program to record.

```
Program 1 (One time)
Channel  --
Start Time --:--
End Time  --:--
Start Date --/--/--
Tape Speed SLP

Press MENU to cancel
```

5. Enter the data for the program with the number buttons.

Timer Recording Information

The Clock must be set correctly.

Insert a tape with the safety tab in place and enough tape to record the program.

PROGRAMS OVERLAP appears if you have entered two programs where the times overlap.

The Timer indicator (TIMER) appears in the display when the VCR is turned off and a timer recording has been set. It flashes if there is no tape in the VCR.

When recording from a cable box or satellite receiver, turn it on and tune it to the channel you want to record before the recording is to begin. The VCR channel should be set to the cable box's output channel, usually Channel 3 or 4.

Continued on Next Page

RECORDING

The data includes the channel number (press INPUT to select the line input), start time, and end time (including AM or PM). The start date is automatically entered based on the VCR clock. The date and/or speed can be changed when flashing.

- Review the information to make sure it is correct, and then press MENU to save.

<pre> Program 1 (One Time) Channel 03 Cable Start Time 08:00 PM End Time 09:30 PM Start Date 11/16/00 Thu Tape Speed SLP Press CLEAR to correct Press MENU to save </pre>	<pre> Program 1 has been saved Remember to insert a recordable tape and turn the VCR off before the program start time. Remember to leave your cable box on and tuned to the desired channel </pre>
--	---

Timer Recording with VCR Plus+ System

You can use the VCR Plus+ system code numbers to simplify timer programming if you have cable TV and don't receive all channels through a cable box, or if you receive your TV signal off-air.

Setting Up the Channel List

If you did not set up the VCR Plus+ programming system channel list, you can do it now.

- Display the CHANNELS menu from the VCR MAIN MENU.
- Display the VCR Plus+ Channel List menu
- Go to, *Setting Up Your VCR*, if you need more information on setting up your VCR Plus+ programming system channel list.

```

VCR MAIN MENU
1 VCR Plus+
2 Timer Recordings
3 Time
4 Channels
5
6
7
8
0

CHANNELS
1 Auto Channel Search
2 Add/Remove Channels
3 Signal Type: CABLE
4 VCR Plus+ Channel List
5
0

VCR+ Channel My Channel
      5          46
      4          --
      3 -> -> -> 23
      2          --
      1          --

Use CH +/- to select
Press 0-9 to change
Press MENU to save
    
```

Using the VCR Plus+ System

- Press MENU to display the VCR MAIN MENU.

```

VCR MAIN MENU
1 VCR Plus+
2 Timer Recordings
3 Time
4 Channels
5 Setup
6 Preferences
7 Audio
8 Language
0 Exit
    
```

- Press 1 to display the VCR Plus+ system menu.

If you receive all channels through your cable box on Channel 3 or 4, you must use the regular Timer Recording method to record programs.

RECORDING

```
VCR PLUS+
Enter PlusCode Number
  (from TV listing)
  ..
Press MENU to cancel
```

3. Enter the PlusCode® programming number shown in your local television guide.

```
VCR PLUS+
Enter PlusCode Number
  (from TV listing)
  12876
Press CLEAR to correct
Press MENU when done
```

4. Press MENU to enter the VCR PlusCode system number.

```
How often should this
program record?
1 One time
2 Daily (every day)
3 Weekdays (M-F)
4 Weekly (once per week)
0 Cancel
```

5. Indicate how often you want the program to be recorded.

```
Program 1 (One time)
Channel   03 Cable
Start Time 08:00 PM
End Time  09:30 PM
Start Date 11/16/00 Thu
Tape Speed SLP
Press CLEAR to correct
Press MENU to save
```

6. Change the recording speed with the SPEED button on the remote or the program end time with the CLEAR button on the remote (if necessary).

Changing the end time comes in handy when you are recording a program, such as a sporting event, that may exceed the scheduled broadcast time.

7. Press MENU to save the program.

*PlusCode is a registered trademark of the Gemstar Development Corporation.
The VCR Plus+ system is manufactured under the license from Gemstar Development Corporation.*

VCR Plus+ System Recording

Clock must be set correctly.

Insert a tape with the safety tab in place and enough tape to record the program.

The Timer indicator (TIMER) appears in the display when you turn off the VCR and a timer recording has been set. It flashes if there is no tape in the VCR.

PROGRAMS OVERLAP appears if you have entered two programs where the times overlap.

UNRECOGNIZED NUMBER... PLEASE RE-ENTER appears when the VCR does not recognize the PlusCode programming system number.

Timer recordings will not be lost in the event of an extended power outage.

```
Program 1 has been saved
Remember to insert a
recordable tape and
turn the VCR off before
the program start time.
Remember to leave your
cable box on and tuned
to the desired channel
```

When a program is set to record, insert a recordable tape and turn off the power. "TIMER" is displayed on the VCR front panel when this is done correctly.

RECORDING

Stopping a Timer Recording

To stop or cancel a timer recording in progress (even an express recording):

- Press and hold the STOP button for three seconds.

Reviewing and Clearing Programs

To review programs that you have already set up:

1. Press 2 when the VCR MAIN MENU is displayed to display the TIMER RECORDINGS menu.

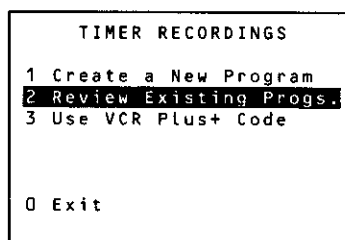

2. Press 2 to display the Review Existing Progs. screen.

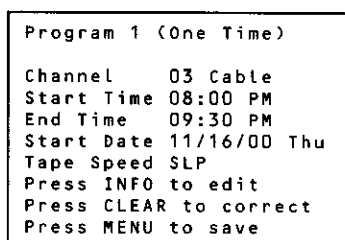

3. Press CLEAR to erase or MENU to see the next program.

Recording Broadcast Stereo TV or SAP (Second Audio Program)

Some TV programs are broadcast with stereo audio or SAP (Second Audio Program).

1. Turn on the TV and tune it to the VCR viewing channel (either 3, 4, or TV's video input).
2. Insert a tape with safety tab in place.
3. If your VCR viewing channel is 3 or 4, make sure the VCR indicator appears in the VCR's display panel. If not, press TV•VCR to turn it on.

RECORDING

4. Use the SPEED button on the remote to select a recording speed. The tape speed indicator appears on the TV screen.
5. Select the channel (or line input) to be recorded.
6. Set the Reception: STEREO/MONO/SAP feature to select the type of audio you want to record. See *Other Features* section.

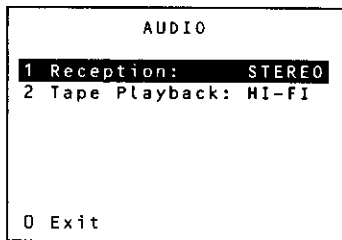

7. Press RECORD to start recording.
8. Press STOP when you are finished.

Recording Audio Only

You can record audio only from another audio source connected to the AUDIO IN (R and L) jacks on the front or back of the VCR.

1. Press the INPUT button on the remote to select the line input (L1 to record from the back jacks or L2 to record from the front jacks).

The VCR will record audio from the audio equipment connected to the AUDIO IN jacks.

2. Use SPEED on the remote to select the recording speed.
3. Start audio source playing and press RECORD to begin recording.
4. Press STOP when you are finished.

Playing Back Audio Only

To get stereo sound, connect the AUDIO OUT jacks of the VCR to the appropriate input on your amplifier or receiver. Do not use the phono input. Refer to your amplifier or receiver user's guide.

Recording audio only will erase anything that was previously recorded on the tape.

Audio Connection

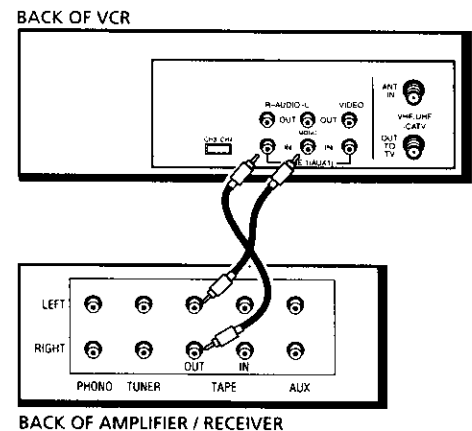

RECORDING

Using Two VCRs For Copying and Editing Tapes

Use one VCR as the *playback VCR* and the other as the *recording VCR*.

1. Connect the VCRs using the diagram at the right.
2. Turn on both VCRs and the connected TV.
3. Tune the TV to the VCR viewing channel (either 3, 4, or video line input - see "How to Find Your TV's Video Input Channel" in the *References* section of this manual for more information).
4. If using coaxial cables for the connection, tune the *recording VCR* to channel 3 or 4—the one used by the *playback VCR*.

If using audio/video cables, select the line input on the *recording VCR* (L1 for the jacks on the back of the VCR or L2 for the jacks on the front of the VCR).

5. Insert the tape to be copied into the *playback VCR*. Insert a blank tape with its safety tab in place into the *recording VCR*.
6. Using visual search, locate the segment to be copied on the *playback VCR*. Pause the tape at this location.
7. Press RECORD on the *recording VCR*, then PAUSE.
8. Press PAUSE on both VCRs to begin copying.
9. Press PAUSE on both VCRs to stop copying.
10. Repeat steps 6–9 to copy or edit additional segments.

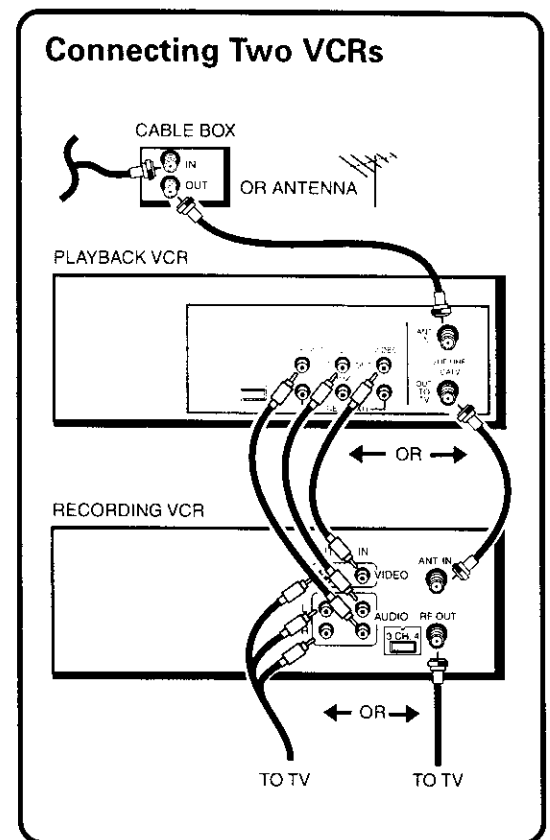

The VCRs used in this diagram may not match the two VCRs you use. Make sure to connect OUT to IN jacks and vice-versa.

Also, make sure to match up the types of jacks (R jacks are connected to R jacks, L to L, and VIDEO to VIDEO).

PROGRAM THE REMOTE

Control Your Television

The remote can be programmed to control a television.

It is programmed to control a GE, RCA, or PROSCAN TV. Other manufacturer's brands need to be programmed.

1 FIRST THINGS FIRST



2 SETTING UP THE VCR



3 VCR BASICS



4 RECORDING



5 PROGRAM THE REMOTE



6 OTHER FEATURES



7 CONNECTIONS



8 REFERENCE

PROGRAM THE REMOTE

About Programming the Remote

The remote can be programmed to control other brands of remote controllable TVs. It is already programmed to operate most GE, RCA, and PROSCAN televisions.

Programming the Remote to Control a TV

If the TV does not turn on when you press the TV button, the remote needs to be programmed.

Follow these steps to program the remote to control your particular TV:

1. Turn on the TV.
2. Find your TV brand and code number(s) on the code list on the next page.
3. Press and hold the TV button on the remote.
4. Enter the code from the code list.
5. Release TV, and then press CHAN up or down. If the TV responds to the remote commands, the remote is programmed.
6. If the TV does not respond, repeat these steps using the next code listed for your TV's brand.

Operating the TV

After you set up the remote, see which buttons operate your TV.

1. Point the remote at the TV, and press the TV button.
If the TV does not turn on, press the TV button and then press the ON•OFF button.
2. You may want to experiment to see which buttons operate your TV. Try pressing buttons, such as VOL and MUTE. See "TV Function Buttons" in the *VCR Basics* Section for details.

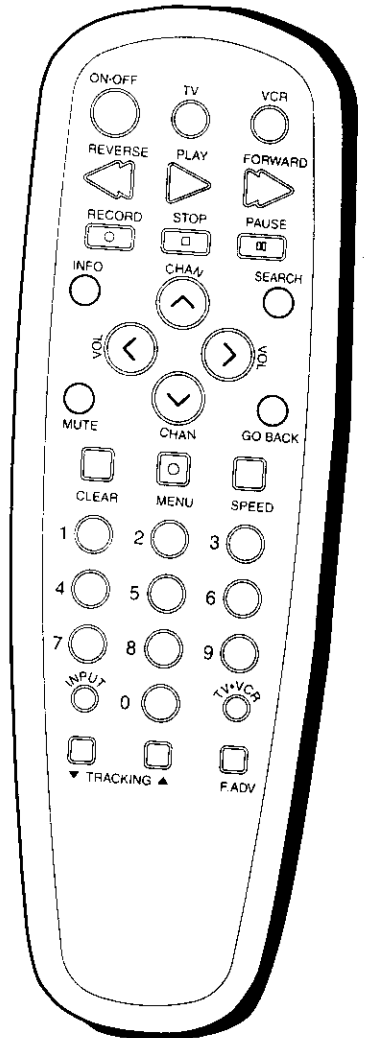

This remote may not operate all models of the brands that are shown.

Note the difference between the TV and VCR on-screen displays to see which one the remote is operating.

PROGRAM THE REMOTE

TV Codes

Akai	03	NAD	11, 35, 36
AOC	05, 06, 11	NEC	04, 05, 06, 11, 48
Candle	06, 07, 11	Panasonic	04, 24, 30, 45
Citizen	06, 07, 11, 12, 17, 52	Philco	04, 05, 07, 08, 11, 13, 30, 33, 34, 37, 38, 56
Colortyme	06, 11	Phillips	04, 06, 07, 08, 13, 30, 33, 37, 38, 39, 46, 47, 48
Concerto	06, 11	Pioneer	06, 11
Curtis Mathes	06, 09, 11, 12, 21, 52	Portland	05, 06, 11, 12
Daewoo	05, 06, 10, 11, 12	Proton	06, 08, 11
Daytron	11, 12, 16	Quasar	04, 24
Electrohome	03, 04, 06, 11, 13, 14	Radio Shack	06, 08, 11, 12, 17, 21, 49
Emerson	06, 08, 11, 12, 15, 16, 17, 18, 21	RCA	04, 05, 06, 11, 13, 50, 51
Envision	06, 11	Realistic	06, 08, 11, 12, 17, 21, 49
Fisher	19, 20, 21, 22	Sampo	06, 11, 12
GE	04, 06, 11, 14, 23, 24, 46	Samsung	05, 06, 08, 09, 11, 12, 13, 52
Goldstar	05, 06, 08, 11, 12, 13, 25	Sanyo	06, 19, 21, 22, 42, 53
Hallmark	06, 11	Sears	06, 11, 13, 18, 19, 20, 21, 22, 31, 35, 36, 54
Hitachi	06, 08, 11, 26, 27, 28, 29	Sharp	01, 06, 08, 11, 12, 15, 49, 55
Infinity	30	Sony	03
JC Penney	05, 06, 07, 11, 12, 14, 23, 24, 36, 46, 52	Soundesign	06, 07, 11, 17, 18
JBL	30	Sylvania	06, 07, 11, 13, 30, 33, 34, 37, 38, 39, 47, 56
Jensen	06, 11	Technics	24
JVC	08, 24, 27, 31, 32, 48	Techwood	06, 11, 24
Kawasho	03, 06, 11	Teknika	05, 06, 07, 08, 11, 12, 17, 18, 39, 44, 45, 52
Kenwood	06, 11, 13	TMK	06, 11
Loewe	30	Toshiba	21, 35, 36, 48, 52, 57
Luxman	06, 11	Universal	23, 46
LXI	11, 21, 30, 35, 36	Victor	31
Magnavox	06, 07, 11, 13, 30, 33, 34, 37, 38, 39, 40, 47, 48, 56	Wards	02, 05, 06, 11, 13, 16, 18, 23, 30, 33, 37, 38, 39, 44, 46, 47, 49, 56
Marantz	06, 11, 30	Yamaha	05, 06, 11, 13
MGA	05, 06, 11, 13, 14, 20, 41, 42	Zenith	06, 44, 58
Mitsubishi	05, 06, 11, 13, 14, 20, 41, 42, 43		
MTC	05, 06, 11, 52		

OTHER FEATURES

Features to Enhance VCR Operation

- Picture Search Options
- Commercial Scan
- Tracking
- Pro-Tect Plus™ Locking
- Time Counter
- On-Screen Displays
- Audio Reception
- Audio Playback

1 FIRST THINGS FIRST



2 SETTING UP THE VCR



3 VCR BASICS



4 RECORDING



5 PROGRAM THE REMOTE



6 OTHER FEATURES



7 CONNECTIONS



8 REFERENCE

OTHER FEATURES

Picture Search Options

The most basic way to search during playback is using the FORWARD or REVERSE button on the remote control. This section contains several other options available for searching a tape.

Forward and Reverse Search

You can search a tape during playback. Sound is turned off during picture search. Search works well for tapes recorded at the SP or SLP speed.

1. Press FORWARD to search forward or REVERSE to search in reverse.
2. Press FORWARD or REVERSE again or press PLAY to return to normal playback.

Slow Motion

You can view a tape during play or play-pause using slow motion. Slow motion works well for tapes recorded at the SP or SLP speed.

1. During playback, press PAUSE and then FORWARD or REVERSE to begin slow-motion playback.
2. Press FORWARD to increase or REVERSE to decrease the speed of the search.
3. Use TRACKING up or down to remove any streaks from the picture.
5. Press PLAY to return to normal playback. The VCR switches automatically from slow-motion playback to stop after a few minutes.

Frame Advance

Frame advance lets you view recorded action one frame after another during playback. Frame advance works well for tapes recorded at the SP or SLP speed.

- Pressing PAUSE “freezes” the action
- Pressing F.ADV repeatedly lets you view single frames of the action
- Pressing PAUSE or PLAY returns normal playback

OTHER FEATURES

Index Search

The VCR has a "VHS Index Search System" that automatically records an index mark on the tape every time you start a recording.

During playback you can locate the program you want to play by the number of index marks or by scanning. The VCR will search forward or reverse from the location you are on the tape.

To Search:

1. Press STOP.
2. Press SEARCH on the remote to display the INDEX SEARCH on-screen display.
3. If you want to search through a certain number of index marks, press two number buttons to enter the number of marks you want to search. Press CLEAR on the remote to correct an entry.
4. Press FORWARD to search forward or REVERSE to search in reverse. The VCR will locate your index mark and begin playback. If you did not enter a specific index number, the VCR will locate the next index mark and begin playback.
5. Press STOP to end index searching.

Some index marks may be missed by the VCR:

- A mark too close to your location on the tape
- The mark at the beginning of a recorded segment of five minutes or less
- The first index mark on the tape when you start at the beginning of the tape

Zero Search

The zero search feature enables the VCR to quickly return to a counter reading of 0:00:00 anywhere on the tape. This is especially convenient when you want to repeat a segment of the tape several times.

1. Go to the beginning of the program you wish to return to.
2. Press INFO **twice** to display the timer counter on the TV screen.

```
INDEX SEARCH
Press REV OR FWD
to begin scanning
OR
enter a specific
index number
--
Press SEARCH to exit
```

```
INDEX SEARCH
Searching for
index number 12...
Press STOP to cancel
```

```
INDEX SEARCH
Searching for
index marks...
Press STOP to cancel
```

Continued on Next Page

OTHER FEATURES

3. Press CLEAR to reset the counter to 0:00:00.
4. Continue playing the tape.
5. Press STOP.
6. Press SEARCH on the remote **twice** to display the ZERO SEARCH menu.
7. Press REVERSE to return to 0:00:00 on the tape.

Commercial Scan (SEARCH Button)

This is useful for skipping commercials or short program segments.

- Press SEARCH once during playback to advance the tape approximately 30 seconds of recorded material.
- Each press of the SEARCH button adds an additional 30 seconds up to five minutes.

Tracking

Your VCR has automatic tracking which removes the streaks or snow from the picture. Automatic tracking is activated when you insert a tape or turn on the VCR. Occasionally you may need to manually adjust tracking, especially if the tape was recorded on a different VCR. Just use the TRACKING buttons to remove the streaks or snow. You can also use tracking when you pause a tape to reduce jittering of the picture.

When you manually adjust the picture, automatic tracking is turned off. To turn automatic tracking back on, press both TRACKING buttons on the front of the VCR at the same time, or eject the tape and re-insert it. Tracking has no effect during recording – only playback.

Pro-Tect Plus™ Locking Feature

To disable the usage of the VCR, or to protect your timer recordings, you can lock the VCR so that the buttons on the VCR or remote won't work.

- **To Lock:** Press and hold the VCR button on the remote for approximately six seconds. "SAFE" will be displayed on the VCR's front panel when it is locked.

```
ZERO SEARCH
Current tape counter is
  2:17:25
Press REV to go to
  0:00:00
Press SEARCH to exit
```

```
ZERO SEARCH
Searching for
0:00:00
Press STOP to cancel
```

Locking Your VCR:

If a timer recording is programmed, make sure your VCR is turned off. Locking your VCR prevents the VCR from being accidentally turned on.

OTHER FEATURES

- **To Lock While a Timer Recording is in Progress:**
Press and hold the VCR button on the remote for approximately six seconds.
- **To Unlock:** Press and hold the VCR button on the remote for approximately six seconds.

Time Counter

The time counter shows the actual time it takes to record a program or play back a segment of a recorded tape. It helps locate the beginning or end of programs you taped. The time counter resets to 0:00:00 whenever the tape is ejected from the VCR.

For example, if you record a 30-minute program at the beginning of the tape and you want to go to the end of that program to begin another recording, you would:

1. Press INFO **twice** to display the time counter.
2. Press CLEAR to reset the time counter to 0:00:00.
3. Press FORWARD to forward the tape until the time counter reads 0:30:00.
4. Press STOP. This is the approximate end of the program.
(You may want to press PLAY to verify.) Now, you can begin recording at this spot.
5. Press INFO to remove the time counter from the screen and return to the normal display mode.

On-Screen Displays

The INFO button shows the status of the VCR (STOP, PLAY, RECORD, etc.), channel number, time counter, date, time, and tape speed on the TV screen. The date and time must be set before they can be displayed.

1. Press INFO to see the on-screen displays.
2. Press INFO again to have only the time counter remain on the screen.
3. Press INFO again to remove the time counter from the screen and return to the normal display mode.

Turning off the VCR also resets the displays.

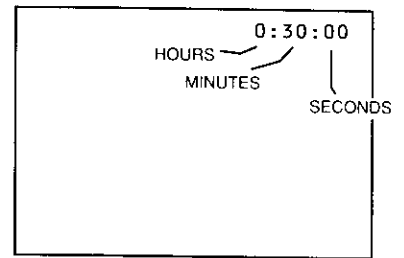

The timer counter's on-screen display lists hours, minutes and seconds of a segment of tape.

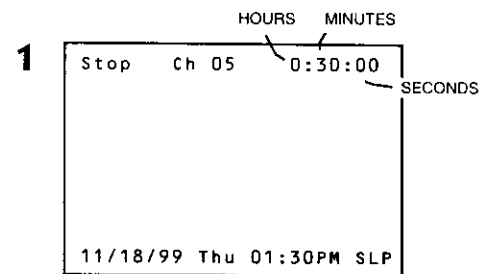

On-Screen Display (Times Out)

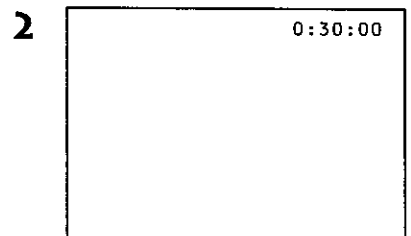

Time Counter Only (Does Not Time Out)

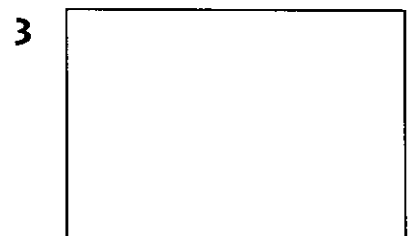

No Displays Will Appear (Useful for Dubbing)

OTHER FEATURES

Audio Setup Features

The audio setup features enhance your tape playback and recordings. The features in this section are accessed through the AUDIO menu and are shown in the displays below.

1. Press MENU to display the VCR MAIN MENU.

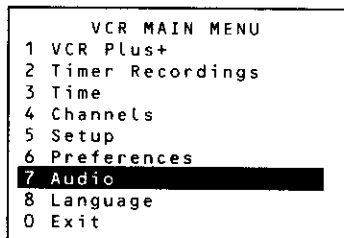

2. Press 7 to display AUDIO menu.

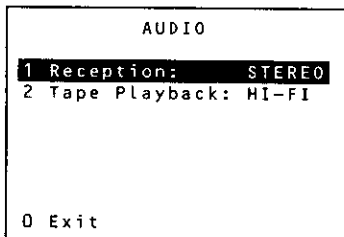

3. Select an item from the menu to set up.

Reception

Some TV programs are broadcast with stereo audio or a Second Audio Program (SAP) which offers a second language. The reception feature lets you select the type of audio you want to record. Press 1 to switch between Reception: STEREO, MONO, and SAP.

- Select STEREO for normal or stereo broadcast TV recording.
- Select MONO if the stereo signal is weak and the sound is too noisy.
- Select SAP to record a Second Audio Program instead of normal audio on both the Hi-Fi and linear tracks.

To receive Hi-Fi stereo sound, use audio-video cables with a compatible TV or receiver. Using only the OUT TO TV jack will not produce stereo sound.

OTHER FEATURES

Tape Playback

The VCR records the same audio on both Hi-Fi and linear tracks on the tape. Hi-Fi sound is recorded on a separate left and right stereo channels. Monaural sound is recorded on the linear track. Press 2 to switch between Tape Playback: HI-FI, LINEAR, and MIX.

To enjoy Hi-Fi sound, connect your VCR to a stereo television or amplifier/receiver using the audio/video jacks. The Tape Playback feature lets you select which audio you use during playback.

- Select HI-FI to play back sound recorded on the Hi-Fi track and for normal use.
- Select LINEAR to play back sound recorded on a linear monaural track, such as a Second Audio Program (SAP), or a dubbed voice.
- Select MIX to play back the sound recorded on both the linear and Hi-Fi tracks, sound-on-sound.

CONNECTIONS

Things to Know Before Connecting Components

Protect Your Components from Power Surges

- Connect all components before plugging any power cords into the wall outlet.
- Always turn off the TV and other components before you connect or disconnect any cables.

Position Cables Correctly to Avoid Audio Hum or Interference

- Insert all cable plugs firmly into their jacks.
- Place the audio/video cables to the sides of the TV's back panel instead of straight down the middle after you connect your components.
- Try not to coil any twin-lead cables and keep them away from the audio/video cables as much as possible.
- Make sure all antennas and cables are properly grounded. Refer to the Safety Tips sheet packed with your unit.

Protect Your Components from Overheating

- Do not block ventilation holes in any of the components. Arrange the components so that air can circulate freely.
- Do not stack components.
- Allow adequate ventilation when placing your components in a stand.
- Place an amplifier or satellite receiver on the top shelf of the stand so heated air rising from it will not flow around other components.

1 FIRST THINGS FIRST



2 SETTING UP THE VCR



3 VCR BASICS



4 RECORDING



5 PROGRAM THE REMOTE



6 OTHER FEATURES



7 CONNECTIONS



8 REFERENCE

CONNECTIONS

Connecting Your VCR

Refer to these pages to help you connect your VCR.

Jacks and Cables

RF Jacks and Coaxial Cables (F-type)

The RF jacks provide good picture and mono sound quality, and must be used if audio/video connections are not available for your TV.

These jacks are required for antenna or cable-TV connections. The RF jacks on the VCR are labeled ANT. IN and OUT TO TV. The coaxial cable supplied with your VCR is used to connect the VCR's OUT TO TV jack and your TV's antenna input.



RF Jack

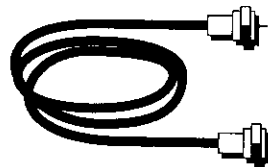

Audio/Video Jacks and Cables (RCA-type)

The AUDIO/VIDEO jacks provide very good picture quality and stereo sound, and can be used if your TV has audio/video input jacks.

These jacks are used for most audio/video connections between components. The VCR AUDIO/VIDEO jacks are color coded (yellow for video and red and white for audio). If your TV only has one input for audio (mono), you may need a Y-adaptor to hear sound from both channels of the VCR.



Audio/Video Jack

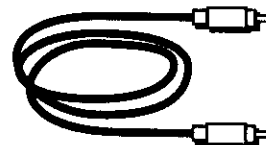

CONNECTIONS

Choosing a VCR Connection

There are several different ways to connect your VCR, depending on whether or not you have cable service, if you have a cable box to see this service, whether some of the cable channels are scrambled, and so on.

Three connections are described in this section and one of them should provide you with a VCR connection that works.

- TV with RF jack only
- TV with audio/video jacks
- TV with audio/video jacks and cable box to unscramble pay channels only

If you need to connect additional components not shown in the diagrams here (and are unsure of how to connect them), refer to the instruction manual that came with that particular component.

Advantages of Audio/Video Connections

Using a simple coaxial cable connection gives you good picture quality. If your television has audio/video jacks, I highly recommend using them to get even better picture quality and stereo sound when recording and playing back videotapes. These connections give you more convenient operation by not having to share the TV's antenna signal.

Don't Forget About the Auto TV/VCR Feature

The TV/VCR switch controls whether the picture signal is coming from the VCR or the TV.

Set the Auto TV/VCR feature to ON when you use only the RF ANT. IN and OUT TO TV connections and OFF when using the AUDIO/VIDEO OUT jacks—so your TV signal is not interrupted when the VCR is turned on.

CONNECTIONS

TV with RF Jack Only

This connection assumes:

- You are connecting antenna, cable, or cable box system.
- Your television has only an RF input jack.

This connection provides:

- Mono sound playback from VCR.
- Record one channel while watching another (except when using a cable box for all channels).

To use this connection, you must have:

- (1) coaxial cable for cable or antenna connection;
- (2) for cable box.

To connect:

1. Connect cables as shown.
2. Return to *First Things First*, then follow the steps.

Using This Connection

Tune your TV to channel 3 or 4, whichever one you selected with the CH3 CH4 switch on the back of the VCR.

Auto TV/VCR Setting:

- Set the Auto TV/VCR feature to ON.

To play a tape:

1. Insert a tape.
2. If necessary, press PLAY.

To record one program and watch another:

1. Begin recording a program using one of the recording features.
2. Press the TV•VCR button and select a different channel on the TV.

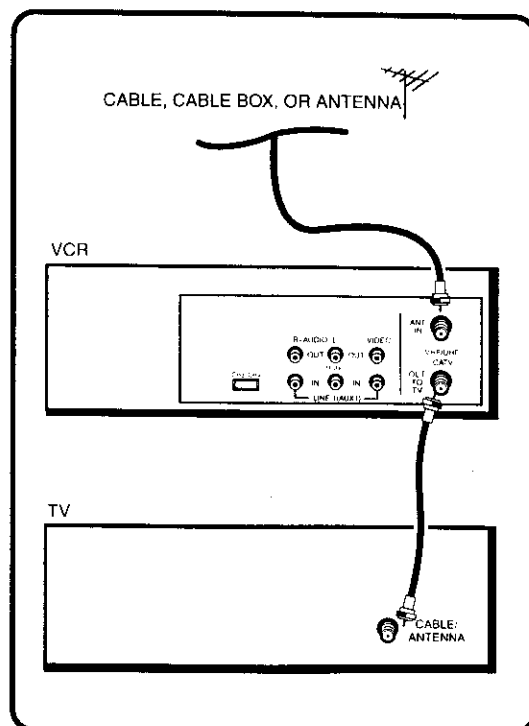

CONNECTIONS

TV with Audio/Video Jacks

This connection assumes:

- You are connecting an antenna, cable, or cable box system.
- Your television has audio/video jacks.

This connection provides:

- Stereo sound playback from VCR.
- Record one channel while watching another (except when using a cable box for all channels).

To use this connection, you must have:

- (1) coaxial cable for cable/antenna connection; (2) for cable box
- (3) audio/video cables

To connect:

1. Connect cables as shown.
2. Return to *First Things First*, then follow the steps.

Using This Connection

Tune your TV to its video input channel. Use of TV•VCR button is not required.

Auto TV/VCR Setting:

- Set the Auto TV/VCR feature to OFF.

To play a tape:

1. Insert a tape.
2. If necessary, press PLAY.

To record one program and watch another:

1. Begin recording a program using one of the recording features.
2. Select a different channel on the TV.

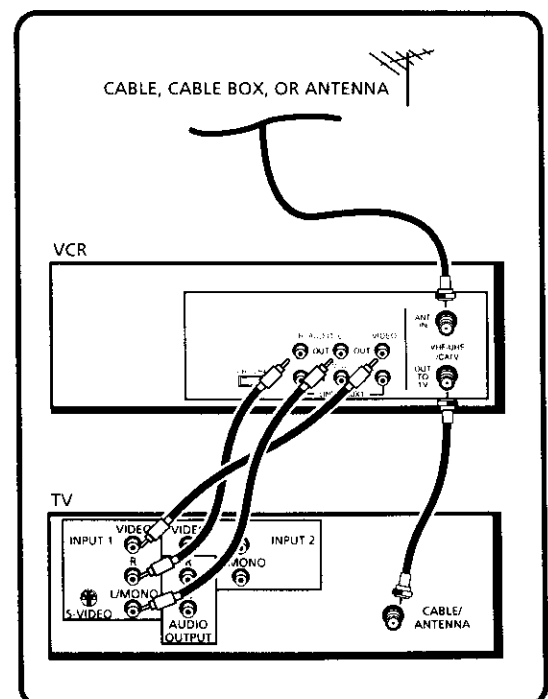

CONNECTIONS

TV with Audio/Video Jacks and Cable Box to Unscramble Pay Channels Only

This connection assumes:

- You are using a cable box only to unscramble premium channels.
- Your TV has audio/video input jacks.

This connection provides:

- Stereo sound playback from VCR.
- Recording a scrambled or unscrambled channel through the cable box while watching an unscrambled channel.

To use this connection, you must have:

- (3) coaxial cables
- (3) audio/video cables
- (1) splitter

To connect:

1. Connect cables as shown.
2. Return to *First Things First*, then follow the steps.

Using This Connection

Tune your TV to its video input channel. Use of TV•VCR button is not required.

Auto TV/VCR Setting:

- Set the Auto TV/VCR feature to OFF.

To play a tape:

1. Insert a tape.
2. If necessary, press PLAY.

To record a scrambled or unscrambled program and watch another unscrambled program:

1. Begin recording a scrambled or unscrambled program through the cable box using one of the recording features.
2. Select an unscrambled channel on the TV.

All scrambled channels must be viewed through the VCR.

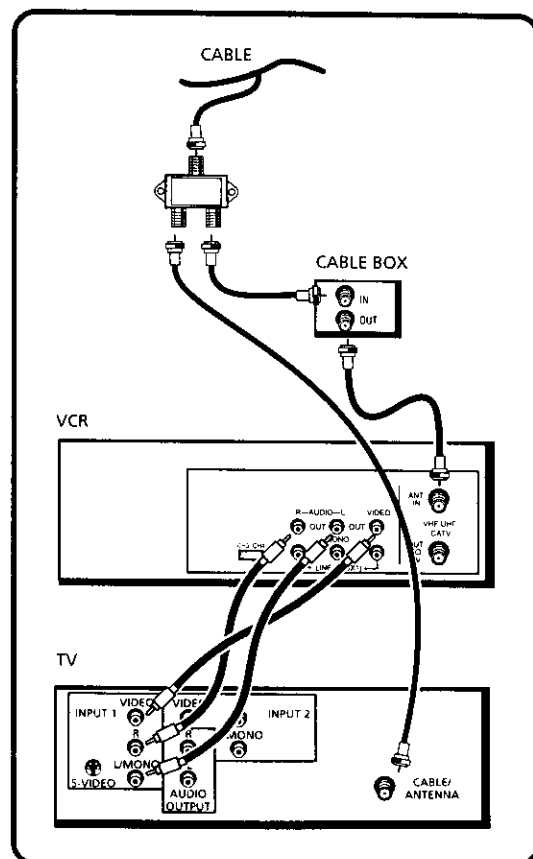

APPENDIX: REFERENCE

Detailed Help and Information

This section gives you some additional information about the VCR, including a description of the unit's controls and display.

You also will find a *Troubleshooting Tips* section in this Appendix, which might help to resolve some of those simple problems.

Finally, this section contains your warranty information.

1 FIRST THINGS FIRST



2 SETTING UP THE VCR



3 VCR BASICS



4 RECORDING



5 PROGRAM THE REMOTE



6 OTHER FEATURES



7 CONNECTIONS



8 REFERENCE

APPENDIX: REFERENCE

Front Panel

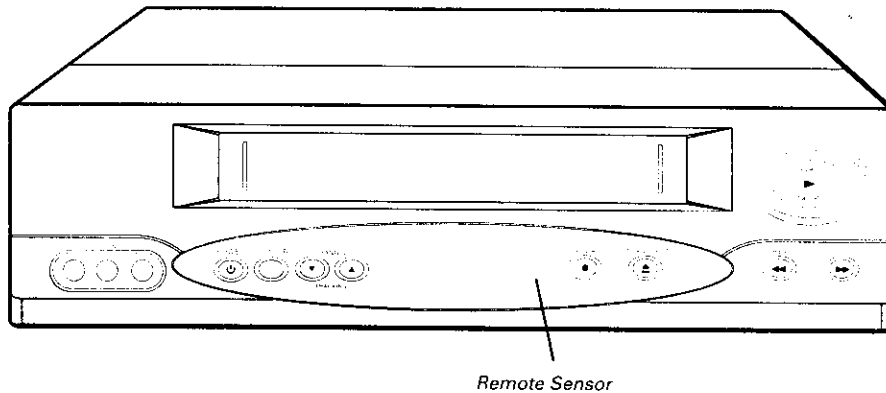

CHANNEL TRACKING Up or Down Selects next higher or lower channel in the VCR's channel memory. Adjusts tracking when a tape is playing. Press both together to re-center tracking.

FWD Forwards the tape when the VCR is stopped. Searches the picture forward during playback. Starts slow motion during play-pause and increases slow-motion speed.

PLAY PAUSE Plays a tape. Pauses action for viewing during playback. Pauses recording to prevent recording of unwanted scenes.

POWER Turns the VCR on or off.

RECORD Starts VCR recording. Used for express recording.

Remote Sensor Receives signals from the remote control. Aim the remote at this sensor.

REV Rewinds the tape when the VCR is stopped. Searches the picture in reverse during playback. Starts slow motion during play-pause and decreases slow-motion speed.

STOP-EJECT Stops the normal functions such as record, playback, rewind, fast-forward, or pause. Ejects the tape when the VCR is stopped.

VIDEO/AUDIO (LEFT MONO and RIGHT) INPUT jacks Receives signals from another component, like a VCR or camcorder, when it is connected to these jacks. Use INPUT on the VCR's remote to select L2 to record from these jacks.

TV-VCR Switches the picture signal so that it either comes from the VCR or the cable/antenna system.

APPENDIX: REFERENCE

Display Panel

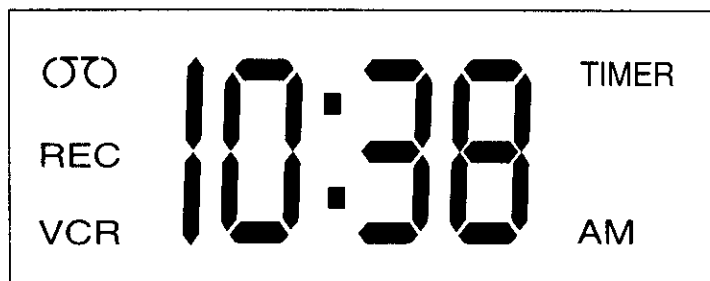

REC Indicator (REC) Lights up and replaces the time display when the VCR is recording.

Time, Channel Number, Line Input Indicator (L1 or L2), Tape Speed Indicator, or Status Indicator

Channel Number or Line Input Indicator The channel number appears when the VCR is tuned to a channel. The line indicator (L1 or L2) appears when the VCR's line input is selected. Select L1 to record from the jacks on the back of the VCR or select L2 to record from the jacks on the front of the VCR.

Status Indicators Show what the VCR is doing.

- **EJEC** (Eject) Cassette ejected
- **FF** Fast forwarding
- **HI** VCR turned on and **BYE** VCR turned off
- **PLAY** In playback
- **REC** Recording and **RECP** For record-pause mode
- **REW** Rewinding
- **R0:00–R4:00** Express recording in progress (zero to four hours in half-hour increments)
- **SAFE** ProTect Plus feature turned on
- **SCH** and **SCH-** Forward or reverse search
- **SLW** In slow playback
- **STILL** Play-pause
- **STOP** Tape is stopped

Tape Inserted indicator (⊗) Appears on the front panel display any time a videocassette is inserted into the VCR. This icon will flash if a timer recording has been set, power turned off on the VCR, but no tape inserted.

Tape Speed Indicator (SP and SLP) Press SPEED on the remote control to change.

Time The current time appears. Only an AM indicator appears with the time. There is no indicator for PM.

TIMER Lights during express recording and when VCR is set for a timer recording and then powered off.

VCR Indicator (Applies only if the VCR Viewing Channel is 3 or 4). Press the TV•VCR button to turn on or off.

- VCR indicator on: TV is viewing signals from the VCR.
- VCR indicator off: TV is viewing signals from an antenna, satellite or cable system.

APPENDIX: REFERENCE

Back Panel

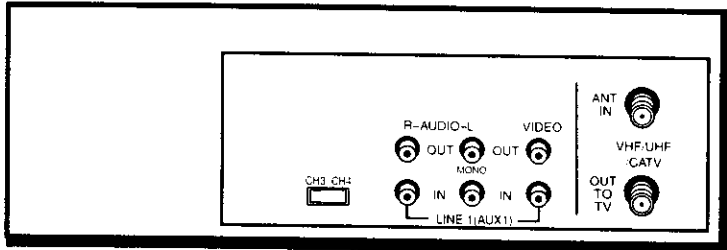

CH3 CH4 switch Selects the VCR signal channel. This is the channel the TV must tune to in order to see the VCR's images. Necessary if connecting the VCR using one of the basic hookups.

AUDIO (L and R) and VIDEO IN Jacks Receives signals from another component (like a VCR or camcorder) when it is connected to the VCR with these jacks. Use INPUT on the VCR's remote control to select L1 (Line Input). Hi-Fi or mono signals as well as video can be recorded when the external device is connected to the VCR with these jacks.

AUDIO (L and R) and VIDEO OUT Jacks Sends signals from VCR to another component (like a TV or VCR) when connected to a TV using these jacks.

ANT IN jack Receives a signal through a coaxial cable from an antenna or cable system when attached with this jack.

OUT TO TV jack Passes a broadcast signal to a TV when connected using the coaxial cable supplied.

APPENDIX: REFERENCE

How to Find Your TV's Video Input Channel

You need to tune your TV to the Video Input Channel if you are using the VCR's AUDIO/VIDEO OUT jacks to connect to the TV's AUDIO/VIDEO INPUT jacks. You must select this "channel" before you can see the VCR's menus, the cable or antenna reception, and the content that's on a tape.

The video channel on TVs varies for different brands and different models. Below are some steps to try:

- If your TV brand is GE, RCA, or PROSCAN, press the TV button on the remote control that came with the VCR. Then press the INPUT button on the remote.
- If you have another brand of TV, consult the section, *Program the Remote*, to see if the VCR's remote control can be set to control your TV. If so, follow the step above.

If those options do not work, try the following ideas. You might access the Video Input Channel by:

- pressing a button on the remote (see table below)
- selecting the channel from the TV's menu system (see table below)
- tuning directly to the channel by selecting a specific channel number (see table below)
- going through all the channels in the channel list by pressing the channel up or down buttons on the TV.

Some common scenarios are listed in the Video Input Channel Variations table that follows:

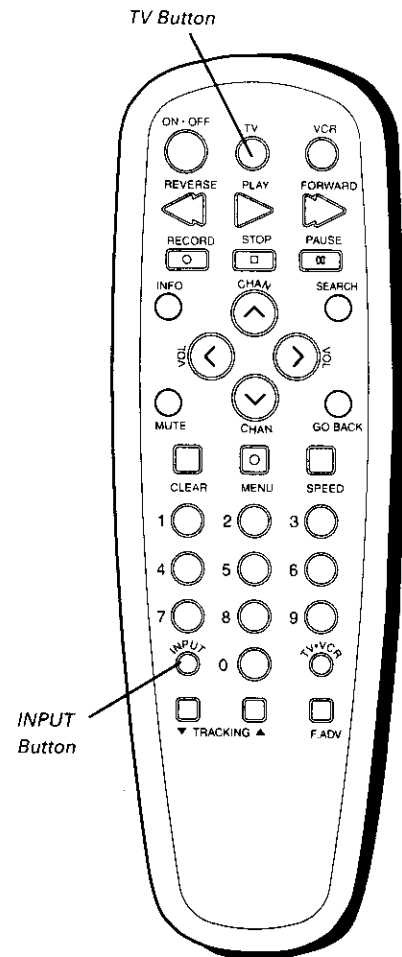

Video Input Channel Variations

Button/Switch on the TV	Button on the TV Remote	Channel Number
VIDEO	VID 1	00
SIGNAL	LINE	90
VID 1	VID	91
VID 2	VIDEO	92
S-VID	S-VID	93
S-VIDEO	INPUT	VID 1
	S-VIDEO	VID 2
	SOURCE	
	AUX	

APPENDIX: REFERENCE

Troubleshooting Tips

No power

- Check to make sure it is plugged into an operating outlet.
- Check to make sure your connections are correct.

VCR does not respond to remote

- Check to make sure there are no objects between the VCR and remote.
- The batteries may need changing.
- Make sure the Remote VCR1/VCR2 setting is set to VCR1 so the remote that came packed with your VCR can operate it.

Poor or no picture for normal TV viewing

- Check to make sure the VCR indicator is off.
- Check to make sure the TV is switched to an active channel.
- Check to make sure the antenna connections are secure and correct.

Snowy or no picture during playback

- Press TV•VCR to turn VCR indicator on.
- Check TV channel selected (3 or 4) to make sure it matches the channel selected with CH3 CH4 switch on back of VCR.
- Check to make sure the TV's fine tuning is correct for the channel you have selected.
- Check video cable connections between VCR and TV monitor.
- Check to make sure the TV monitor is set to video input. See "How to Find Your TV's Video Input Channel" in this section of the manual for details.
- Try another tape.
- Some snow/streaks are normal during search, stop action, frame advance, and slow-motion playback.

Streaks in picture during normal playback

- Press one of the TRACKING buttons to move streaks up or down for the best picture.
- Check to make sure the tape is of good quality and not worn out.

Time counter not working or time counter not working in search modes

- The time counter does not advance during unrecorded portions of tape. When an unrecorded segment of tape is encountered, the time counter will hold its count until recorded material is detected again.
- A minus (-) will appear in front of the time if you rewind the tape farther back than a counter reading of 0:00:00.
- The time counter disappears during search; this is normal.

APPENDIX: REFERENCE

Will not record or play

- Check to make sure there is a tape in the VCR.
- Try ejecting and reinserting the cassette.
- Check to make sure the tape is not broken.
- Check to make sure the VCR is not in pause mode. Press PAUSE or PLAY to return to normal playback.
- Check the ProTect Plus™ feature.

“SAFE” displays when a button is pressed on the remote control or VCR

- The “SAFE” indicator displays when the ProTect Plus™ Locking feature is activated or when a button on the remote or VCR is pressed and ProTect Plus is activated.

Rewind does not operate

- Check to make sure the tape is not already rewound.

VCR Plus+ system or timer recording not made or wrong program recorded

- Check to make sure the correct VCR Plus+ system code is entered.
- Check to make sure the cable box or satellite receiver was turned on when recording was to begin.
- Check to make sure the program was entered correctly (wrong channel or times).
- Power interruption. Reset the clock.
- Check to see if time and date are correct – including AM/PM.
- Check to make sure the program did not exceed the tape’s length or the tape was not rewound beforehand.
- Check to make sure the VCR was turned off at the time recording was to start.
- Check to make sure there was a tape in the VCR and the cassette’s safety tab was intact.
- VCR ejects cassette when the end of the tape is reached during a timer recording.
- Check to make sure VCR Plus+ system setup was completed correctly.

Will not record

- Check to make sure the safety tab is intact.
- Check to make sure the VCR is not in the line mode. Press INPUT on the remote.

APPENDIX: REFERENCE

Internal clock shows incorrect time or date

- Power interruption. Make sure cable box or VCR is tuned to channel carrying the XDS information.
- Check to make sure the clock is set accurately (check AM/PM and date).
- Check Daylight-Saving setting. The clock may have adjusted for daylight-saving time.

Time did not adjust for daylight-saving time

- Check to make sure daylight-saving feature is set correctly.

VCR makes noise when stopped

- VCR is removing tape from heads. This is normal. The head cylinder inside the VCR will continue to rotate for a few minutes after you put the VCR in the stop mode.

Will not Auto Channel Search active channels correctly

- Check to make sure the antenna connections are secure and correct.
- Check to make sure the Signal Type: CABLE/ANTENNA feature is set correctly.
- If Detect Automatically was selected for the Signal Type in the AUTO CHANNEL SEARCH menu, try using either CABLE TV or ANTENNA instead.
- May not be necessary if using a cable box for all channels. Contact your local cable company for more information.

Tape plays back in slow motion

- Press PLAY to return to normal playback.

Cannot select channels over 69

- Cable channels over 69 can only be selected if Signal Type: CABLE/ANTENNA feature is set to CABLE.

Cassette with safety tab removed does not start to play automatically

- Check to make sure the Auto Play ON/OFF feature is set to ON.

“--:--” lights on the front panel display

- Clock is not set.

Time counter disappears during searching

- This is normal.

On-screen menus appear in English, French, or Spanish

- Check LANGUAGE feature.

APPENDIX: REFERENCE

No stereo sound during playback

- Check to make sure the Tape Playback feature is set to HI-FI to hear stereo sound during playback. The tape you are playing must be recorded in Hi-Fi in order to use the HI-FI feature.
- Must use the AUDIO/VIDEO jacks on the back of the VCR to hear stereo sound.

Stereo audio too noisy

- Stereo signal is weak. Set Reception: STEREO/SAP/MONO feature to MONO.
- Press one of the TRACKING up or down buttons to minimize the noise.

APPENDIX: REFERENCE

Specifications

Format:	VHS
Record/Playback System:	Video: 4-head Audio: Stereo record/playback system
Video Signal System:	EIA standard: NTSC color
Antenna:	75-ohm external VHF/UHF combined antenna terminal
Tuner:	USA: 181 channels capability* (125 cable channels) Canada: 178 channels capability* (122 cable channels)
Type:	AutoProgramming frequency synthesis
Power Requirement:	120V AC, 60 Hz
Power Consumption:	15 watts
Dimensions:	3.7 inches high (94 mm) 14.2 inches wide (360 mm) 10.6 inches deep (270 mm)
Weight:	7.1 pounds (3.2 kg)
Storage Temperature Range:	- 22°F to +149°F (-30°C to +65°C)
Operating Temperature Range:	+41°F to +104°F (+5°C to +40°C)

*Check your cable company's compatibility requirements.

Cleaning the VCR

Use a soft cloth or dusting attachment of your vacuum cleaner to dust your VCR. Remove dust from the ventilation holes of the cabinet.

Plastic surfaces are easily scratched and can be marred by alcohol and various solvents. Avoid excessive use of oil-based furniture polishes since the materials used in the cabinet will accumulate more dust. We recommend using a nonabrasive, antistatic cleaner and polisher.

Specifications are subject to change.

APPENDIX: REFERENCE

Limited Warranty

What your warranty covers:

- Any defect in materials or workmanship.

For how long after your purchase:

- Ninety days for labor charges.
- One year for parts.

The warranty period for rental units begins with the first rental or 45 days from date of shipment to the rental firm, whichever comes first.

What we will do:

- Pay any Authorized GE VCR Service Center the labor charges to repair your VCR.
- Pay any Authorized GE VCR Service Center for the new or, at our option, refurbished replacement parts required to repair your VCR.

How you get service:

- Take your VCR to any Authorized GE VCR Service Center. To identify your nearest Authorized GE VCR Service Center, ask your dealer, look in the Yellow Pages, or call 1-800-447-1700.
- Show the Authorized Service Center Representative your evidence or purchase date or first rental.
- Pick up your VCR when repairs are completed.

What your warranty does not cover:

- Customer instruction. (Your Owner's Manual clearly describes how to install, adjust, and operate your VCR. Any additional information should be obtained from your Dealer.)
- Installation and related adjustments.
- Signal reception problems not caused by your VCR.
- Damage from misuse or neglect.
- Cleaning of video/audio heads.
- Batteries.
- A VCR that has been modified or incorporated into other products or is used for institutional or other commercial purposes.
- A VCR purchased or serviced outside the USA.
- Acts of God, such as but not limited to lightning damage.

Product Registration:

- Please complete and mail the Product Registration Card packed with your VCR. It will make it easier to contact you should it ever be necessary. The return of the card is not required for warranty coverage.

How state law relates to this warranty:

- This warranty gives you specific legal rights and you also may have other rights that vary from state to state.

If you purchased your VCR outside the United States:

- This warranty does not apply. Contact your dealer for warranty information.

INDEX

A

- Accessories
 - included 4
- ADD/REMOVE CHANNELS screen 11
- Adding/removing channels 11
- ANT. IN and OUT TO TV jacks 4, 5, 6, 48, 56
- Audio
 - playing back 33
 - recording 33
- AUDIO menu 44
- Audio reception feature 44
- Audio setup features 44
- Audio/video cables 47, 49, 52
- AUDIO/VIDEO jacks
 - 4, 5, 9, 22, 33, 48, 51, 56
- Auto channel search 10
- Auto clock feature 12
- Auto play feature 18, 24
- Auto TV/VCR feature 18
- Automatic rewind 25
- Automatic tracking 24

B

- Back panel 56
- Batteries
 - installing in the remote 4
- Broadcast stereo recording (SAP) 32
- Remote 22
- Buttons, remote 22

C

- Cable box setup 9
- Cables, positioning 47
- Cables, types of 48
- CH3 CH4 switch 6, 50
- CHAN buttons 11, 22, 23, 36
- Channel List 30
- Channel, VCR viewing 5
- CHANNEL•TRACKING button 54

Channels

- adding/removing 11
- detecting automatically 10
- VCR list 10
- CHANNELS menu 9, 10, 11, 15, 30
- Choosing a VCR connection 49
- Cleaning the VCR 62
- CLEAR button 22, 23, 31, 32, 41, 42, 43
- Clearing programs 32
- Commercial scan 42
- Component buttons 22
- Connecting components 47
- Connecting your VCR 4, 48
- Connections 47
 - audio/video cables 49
 - TV with audio/video jacks 51
 - TV with RF jack only 50
 - unscrambling pay channels 52
- Contents 1
- Copying and editing tapes 34

D

- Date and time 12
- Daylight-saving time 13, 14
- Display panel 55
- Displays, on screen 43

E

- Eject the tape 25
- Express recording (XPR) 28

F

- F.ADV button 22, 40
- Forward and reverse search 40
- FORWARD button 22, 24, 40, 43
- Frame advance 40
- Front panel 54
- Front panel brightness 19, 20
- FWD button 24, 54

INDEX

G

GO BACK button 22, 23

I

Included accessories 4

Index search 41

INFO button 22, 23, 41, 43

Initial setup 5, 8

INPUT button

5, 9, 22, 23, 30, 33, 54, 56, 57

J

Jacks, types of 48

L

Language feature 8

LANGUAGE menu 6, 8

Line indicators (L1 and L2) 33, 54, 56

Locking feature 42

M

MENU button

6, 8, 9, 11, 12, 13, 15, 17, 22, 29, 30, 31,
32, 44

MUTE button 24, 36

N

Number buttons 6, 14, 23, 24

O

ON•OFF button 22, 24, 25, 36

On-screen displays 43

OUT (TO TV) jack 18

Overheating 47

P

Panel brightness 19

PAUSE button 23, 24, 25, 34, 40

Picture search options 40

PLAY button 23, 24, 40, 43, 50, 51, 52

PLAY•PAUSE button 24, 54

Playing a tape 24

Plugging in the VCR 4

POWER button 5, 25, 54

Power surges 47

PREFERENCES menu 17, 18, 19

Preferred tape speed 19

ProTect plus™ locking feature 42

Problem solving 58

Programming the remote 35

to operate TVs 36

PROGRAMS OVERLAP message 29, 31

R

REC indicator 55

Reception feature 44

Reception: STEREO/MONO/SAP feature 33, 44

RECORD button 23, 25, 28, 33, 34, 54

Record protect tab 25

Recording 25

audio only 33

basic 25

broadcast stereo TV 32

copying and editing tapes 34

express (XPR) 28

features 28

options 27

SAP 32

timer 29

types of 28

VCR plus+ 30

XPR (Express) 28

Remote

component buttons 22

installing batteries 4

sensor 54

TV function buttons 23

Continued on Next Page

INDEX

Remote VCR1/VCR2 option 17
Removing/adding channels 11
REV button 24, 54
REVERSE button 23, 40, 42
Review Existing Progs. screen 32
Reviewing programs 32
Rewind, automatic 25

S

Safety tab 24, 25
Search
 commercial scan 42
 forward and reverse 40
 frame advance 40
 index 41
 slow-motion 40
 zero 41
SEARCH button 23, 41, 42
Second Audio Program (SAP), recording 32
Sensor, remote 54
SET DAYLIGHT SAVINGS menu 13
SET TIME AND DATE menu 14
SET TIME ZONE menu 12
Setup
 audio 44
 cable box 9
 channels list 10
 initial 5
 language 8
 time and date 12
 time and date manually 13
 using menus 8
 using PREFERENCES menu 17
Signal type 11
Signal type, changing 11
Slow-motion search 40
SLP (tape speed) 19, 25
Solving problems 58

SP (tape speed) 19, 25
Specifications 62
SPEED button 23, 25, 28, 31, 33
Status indicators
 BYE 55
 EJEC (Eject) 55
 FF 55
 HI 55
 PLAY 55
 R0:30 55
 REC 55
 REW 55
 SAFE 55
 SCH and SCH- 55
 STOP 55
STOP button 23, 25, 28, 32, 33, 41, 42, 43
STOP•EJECT button 25, 54

T

Table of contents 1
Tape eject 25
Tape playback 45
Tape Playback/HI-FI/ LINEAR/MIX 45
Tape, playing 24
Tape speed 19, 25
Time and date 12
Time counter 43
Time display 55
TIME menu 12, 13, 14
Time zone 12
TIMER indicator 29, 31, 55
Timer recording 28
 stopping 32
TIMER RECORDINGS menu 29, 32
Tips, troubleshooting 58
Tracking 42
TRACKING buttons 23, 24, 40
Troubleshooting tips 58

INDEX

TV button 5, 22, 36, 57
TV codes 37
TV function buttons 23
TV, programming the remote to control 36
TV•VCR button 23, 32, 50, 51, 52, 54, 55
TV's video input channel 57

V

VCR back panel 56
VCR button 5, 22
VCR channel list 10
VCR, cleaning 62
VCR display panel 55
VCR front panel 54
VCR indicator 6, 32, 55
VCR MAIN MENU
 6, 8, 9, 10, 11, 12, 13, 15, 17, 29, 30,
 32, 44
VCR Plus+ 15
 channel list 15
 Channel List screen 15
 programming system 28
 system menu 30
 worksheet for channels 16
VCR viewing channel 5
VHS index search system 41
VOL buttons 24, 36

W

Warranty 63
Warranty, limited 63

X

XPR (express recording) 28

Y

Y-adaptor 48

Z

Zero search 41

If your VCR needs service, please contact your dealer or the nearest Service center from the yellow pages. Please do not send any products to the Indianapolis address listed in this manual or on the carton. This will only add delays in service for your product.

 **THOMSON CONSUMER ELECTRONICS**
10330 North Meridian Street
Indianapolis, IN 46290

©1999 Thomson Consumer Electronics, Inc.
Trademark(s)® Registered
Marca(s) Registrada(s)
Printed in Korea
TOCOM 1553011A

MODEL #:
VG4275
1553011A



As an ENERGY STAR® Partner, Thomson Consumer Electronics has determined that this product or product model meets the ENERGY STAR® guidelines for energy efficiency.