

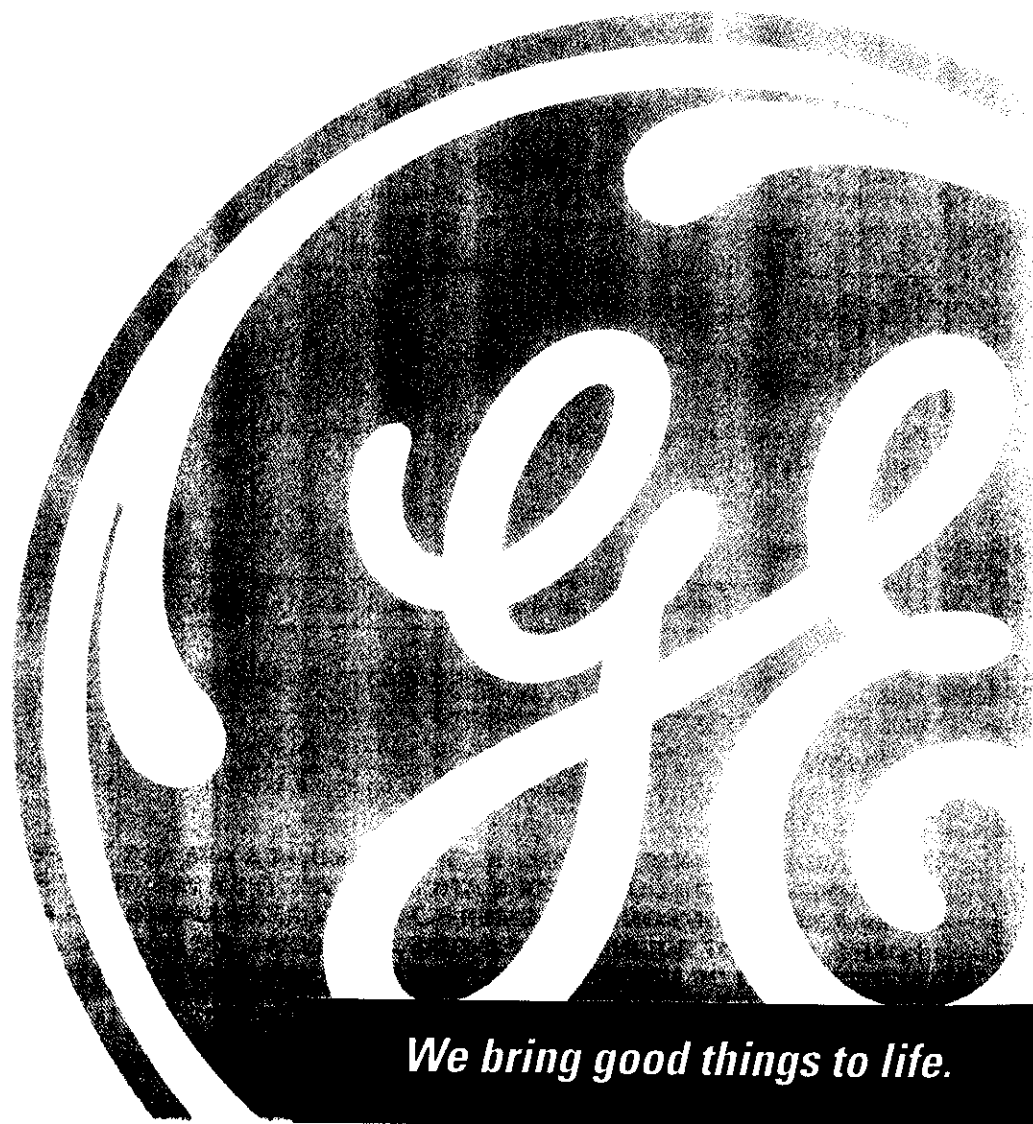

Television User's Guide



GUIDE *plus*
RESEARCH

We bring good things to life.

Important Information

WARNING

To reduce the risk of fire or electric shock, do not expose this TV to rain or moisture.

WARNING

RISK OF ELECTRIC SHOCK. DO NOT OPEN.

To reduce the risk of electric shock, do not remove cover (or back). No user serviceable parts inside. Refer servicing to qualified service personnel.



This symbol indicates "dangerous voltage" inside the product that presents a risk of electric shock or personal injury.



This symbol indicates important instructions accompanying the product.

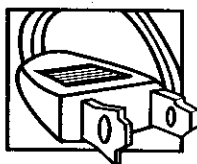

Caution: To prevent electric shock, match wide blade of plug to wide slot, fully insert.

Attention: Pour éviter les chocs électriques, introduire la lame la plus large de la fiche dans la borne correspondante de la prise et pousser jusqu'au fond.

Refer to the identification/rating label located on the back panel of your product for its proper operating voltage.

FCC Regulations state that unauthorized changes or modifications to this equipment may void the user's authority to operate it.

If fixed (non-moving) images are left on the screen for long periods, they may be permanently imprinted on the picture tube. Such images include network logos, phone numbers, and video games. This damage is not covered by your warranty. Extended viewing of channels displaying these images should be avoided.

Cable TV Installer: This reminder is provided to call your attention to Article 820-40 of the National Electrical Code (Section 54 of the Canadian Electrical Code, Part 1) which provides guidelines for proper grounding and, in particular, specifies that the cable ground shall be connected to the grounding system of the building as close to the point of cable entry as practical.

Product Registration

Please fill out the product registration card and return it immediately. Returning the card allows us to contact you if needed.

Keep your sales receipt to obtain warranty parts and service and for proof of purchase. Attach it here and record the serial and model numbers in case you need them. The numbers are located on the back of the television.

Model No. _____

Serial No. _____

Purchase Date: _____

Dealer/Address/Phone: _____

G-LINK, VCR Plus+, C³, PlusCode, GUIDE Plus+, and GUIDE Plus+ Gold are trademarks of Gemstar Development Corporation.

The VCR Plus+ and GUIDE Plus+ systems are manufactured under license from Gemstar Development Corporation and VCR Index Systems B.V. respectively.

GEMSTAR AND THOMSON CONSUMER ELECTRONICS ARE NOT IN ANY WAY LIABLE FOR THE ACCURACY OF THE PROGRAM SCHEDULE INFORMATION PROVIDED BY THE GUIDE PLUS+ SYSTEM. IN NO EVENT SHALL GEMSTAR OR THOMSON CONSUMER ELECTRONICS BE LIABLE FOR ANY AMOUNT REPRESENTING LOSS OF PROFITS, LOSS OF BUSINESS, OR INDIRECT, SPECIAL, OR CONSEQUENTIAL DAMAGES IN CONNECTION WITH THE PROVISION OR USE OF ANY INFORMATION, EQUIPMENT, OR SERVICES RELATING TO THE GUIDE PLUS+ SYSTEM.

VCR required for recording.

Key Features Overview

Your TV is equipped with features that will add to your TV viewing experience. The following information summarizes a few of these features. Chapter 3 provides more information about the rest of the TV's features and how to use them.

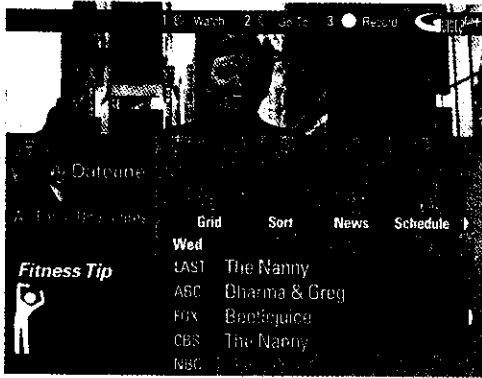

On-screen Program Guide

Description: The GUIDE Plus+ system is an on-screen interactive list of programs and information that is built into your TV. You can scroll through the guide to see what's on and tune directly to that program from the guide. You can also browse programs by category with the sort feature.

When you access the *News* feature, MSNBC will appear in your video window if it's available through your TV.

One-Touch VCR Recording is another benefit of the GUIDE Plus+ system. You don't have to remember to program your VCR or use the menus in your VCR to set up a recording.

Requirements:

- Remove the Demo Pin from the G-LINK jack.
- Complete the on-screen interactive setup. You'll find detailed instructions in Chapter 1.
- One-Touch VCR Recording: You must connect the G-LINK cable to the TV and place one of the wands in front of the remote sensor on the VCR.
- If you have a cable box, connect the G-LINK cable to the TV and place one of the wands in front of the remote sensor on the cable box.

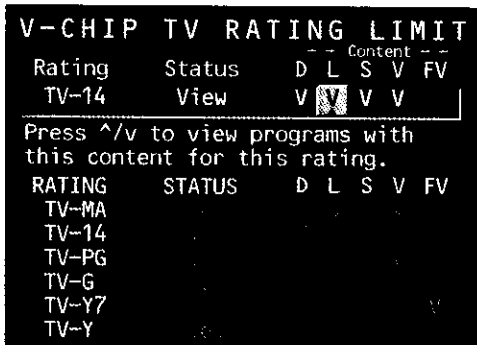

V-Chip: Parental Controls

Description: You can block programs and movies by content, age-based ratings, and/or movie ratings.

Requirements:

- Set up the *Parental Controls* menu in the TV's main menu (Chapter 3 has details).
- The broadcasters must use the rating system when they send the program to your TV in order for your TV to block the program.

Introduction

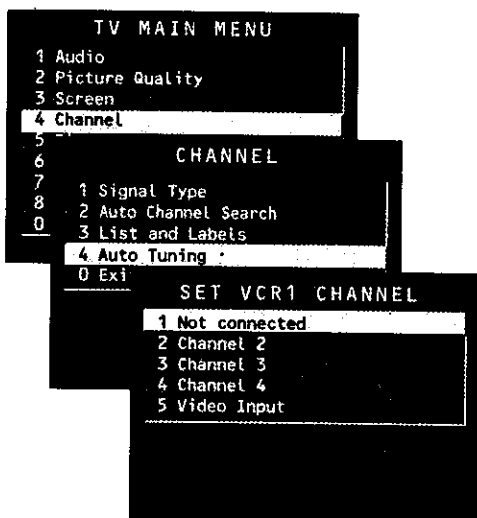

Auto Tuning

Description: Allows you to set up the TV to automatically tune to a specific channel when you press a certain component (VCR, DVD Player, etc.) button on the remote.

Requirements: Set up *Auto Tuning* in the TV's menu system. (Chapter 3 has details).

Introduction: Key Features Overview	1
On-screen Program Guide	1
V-Chip: Parental Controls	1
Auto Tuning	2
Chapter 1: Connections & Setup	3
Things to Consider Before You Connect	6
Protect Against Power Surges	6
Protect Components from Overheating	6
Position Cables Properly to Avoid Audio Interference	6
Important Stand and Base Safety Information	6
Use Indirect Light	6
Connection Pictures	6
Demo Pin	6
Choose Your Connection	7
Connection: TV + VCR	8
Connection: TV Only	9
Connection: TV + VCR + Satellite Receiver	11
Jacks on the Back of Your TV	12
Why You Should Connect This G-LINK Cable	13
How to Find the Remote Sensor	13
Placing the G-LINK Wands	13
Complete the Interactive Setup	15
What to Expect	20
Next Steps	20
Chapter 2: Using the Remote Control	21
The Buttons on the Remote Control	22
Using the WHO-INPUT Button	23
Programming the Remote to Operate Other Components	24
Find Out If You Need to Program the Remote	24
How to Program the Remote	24
How to Use the Remote After You've Programmed It	25
Chapter 3: Using the TV's Features	27
About the GUIDE Plus+ System	28
Downloading Data	28
Getting In & Out of the GUIDE Plus+ System	29
The GUIDE Plus+ System Menus	29
Grid Guide	29
Sort	31
News	32
Schedule	32
Messages	33
Setup	34
Channels	34
How to Get More Information About an Advertisement or a Program	35

Table of Contents

GUIDE Plus+ Menu Items	35
Channel Banner	36
Why You Should Use the Auto Tuning Feature	36
Parental Controls and V-Chip	38
How V-Chip Works	38
V-Chip TV Rating Limit	39
Blocking Specific Content Themes	42
Viewing Specific Content Themes	43
V-Chip Movie Rating Limit	43
V-Chip Unrated Program Block	45
Channel Block	45
Front Panel Block	45
Lock/Unlock Parental Controls	46
Chapter 4: Using the TV's Menu System	47
How to Use Your TV's Menu System	48
Audio Menu	49
Picture Quality Menu	50
Screen Menu	50
Using Closed Captioning	51
Channel Menu	52
Time Menu	52
Chapter 5: Other Information	53
Troubleshooting	54
Troubleshooting	55
Troubleshooting	56
Care and Cleaning	57
Front Panel of the TV	57
TV Limited Warranty	58
Index	61

Connections & Setup

Chapter Overview:

- **Things to Consider Before You Connect**
- **Choose Your Connection**
- **Connections**
- **Why You Should Connect This G-LINK Cable**
- **Plug in the TV**
- **Put Batteries in the Remote**
- **How to Use the Remote Control to Complete the Interactive Setup**
- **Turn on the TV**
- **Complete the Interactive Setup**

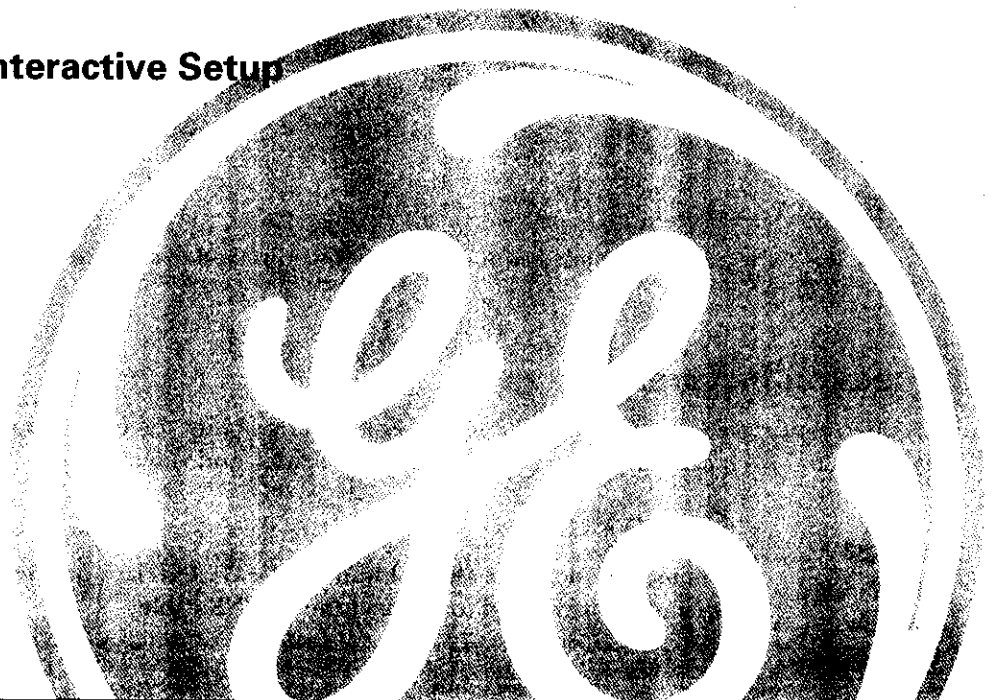

Things to Consider Before You Connect

Protect Against Power Surges

- Connect all components before you plug any of their power cords into the wall outlet.
- Turn off the TV and/or component before you connect or disconnect any cables.
- Make sure all antennas and cables are properly grounded. Refer to the Important Safeguards sheet packed with your TV.

Protect Components from Overheating

- Don't block ventilation holes on any of the components. Arrange the components so that air can circulate freely.
- Don't stack components.
- When you place components in a stand, make sure you allow adequate ventilation.
- If you connect an audio receiver or amplifier, place it on the top shelf so the heated air from it won't flow around other components.

Position Cables Properly to Avoid Audio Interference

- Insert each cable firmly into the designated jack.
- If you place components above the TV, route all cables down the side of the back of the TV instead of straight down the middle of the back of the TV.
- If your antenna uses 300-ohm twin lead cables, do not coil the cables. Also, keep the twin lead cables away from audio/video cables.

Important Stand and Base Safety Information

Choose the location for your TV carefully. Place the TV on a stand or base that is of adequate size and strength to prevent the TV from being accidentally tipped over, pushed off, or pulled off. This could cause personal injury and/or damage the TV. Refer to the Important Safeguards sheet packed with your TV.

Use Indirect Light

Don't place the TV where sunlight or room lighting will be directed toward the screen. Use soft or indirect lighting.

Connection Pictures

Audio/video cables are usually bundled together. For better visibility, the connection pictures in this book show each cable separately (audio left, audio right, and video).



Demo Pin

You must remove the Demo Pin from the G-LINK jack on the back of your TV in order for your TV to operate properly and to connect the G-LINK cable.

Choose Your Connection

There are several ways to connect your TV. Please use the following chart to determine which connection is best for you. Proceed to the appropriate page and connect your TV.

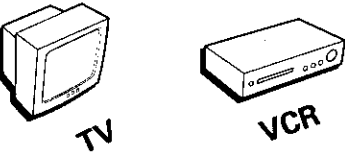
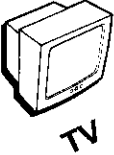
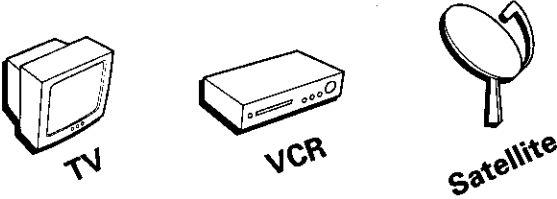
Components	Cables Needed	Connection Title	Go to...
	Coaxial Audio/video G-LINK cable	TV + VCR	page 8
	Coaxial	TV Only	page 9
	Coaxial Audio/video S-Video (optional) G-LINK cable	TV + VCR + Satellite Receiver	pages 10-11

Cables Needed to Connect Components to Your TV

The pictures below are the cables needed for the connections represented in this book.

Notes: Audio/Video cables (A/V cables for short) are usually sold as a bundled set, but the connection pictures in this book show each cable separately for better visibility.

Please locate the G-LINK cable (provided) when you're getting ready to set up your TV. You need to connect this cable to your TV, and to your VCR and/or cable box in order for all of the features of the program guide to work properly.



G-LINK cable

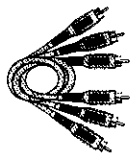

Audio/Video cables



Coaxial cable



S-Video cable

Connections & Setup

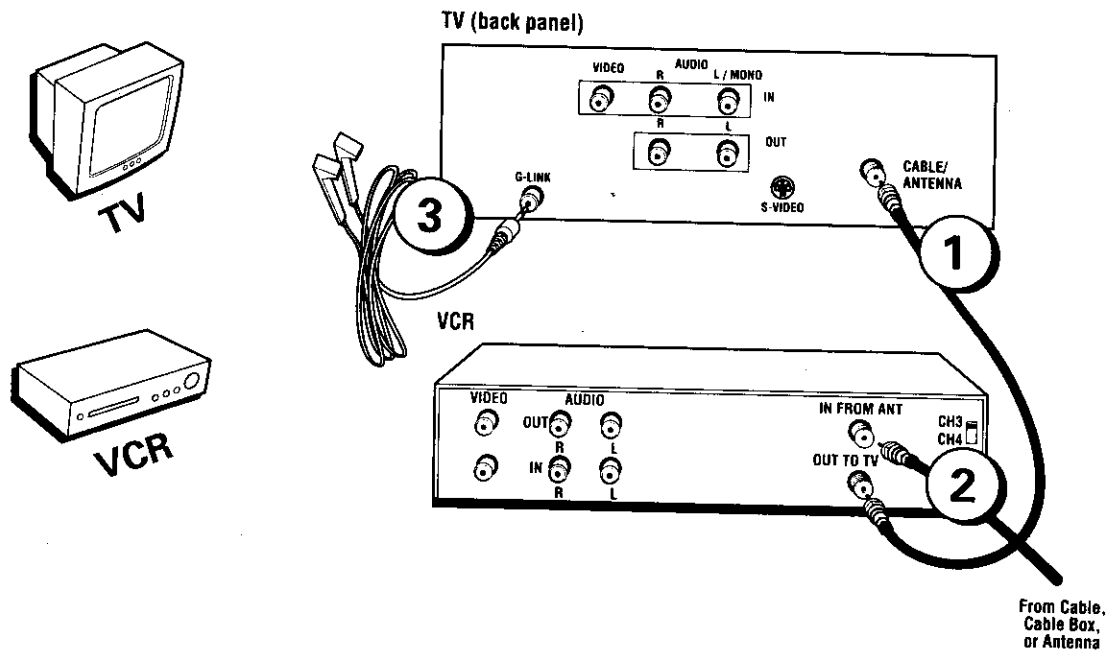

Connection: TV + VCR

1. Connect your TV to your VCR

Connect a coaxial cable to the CABLE/ANTENNA jack on your TV and to the Output Jack on your VCR (sometimes labeled OUT TO TV).

2. Connect cable or antenna to your VCR

Connect the coaxial cable from your cable outlet, cable box, or antenna to the Input Jack on your VCR (sometimes labeled IN FROM ANTENNA or IN FROM ANT).

3. Connect the G-LINK cable to the TV

A. If you haven't already done so, remove the Demo Pin from the G-LINK jack.

B. Connect the G-LINK cable to the G-LINK jack on the TV. Next step, place one of the wands of the G-LINK cable to work with your VCR (instructions are on p. 13).

Go to page 13

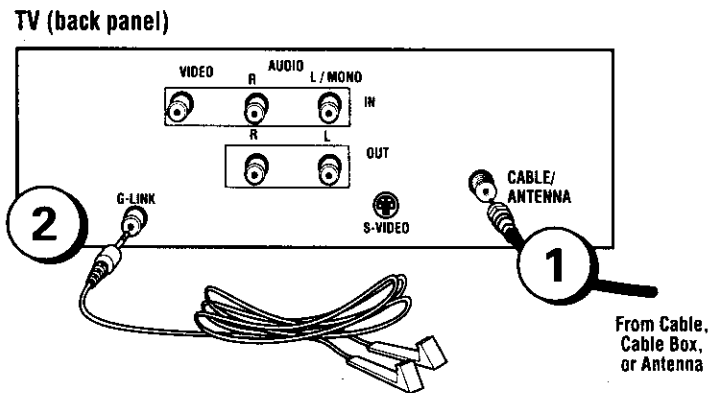
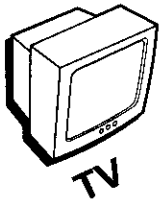

Connection: TV Only

1. Connect the TV to your cable or antenna

Connect the coaxial cable from your cable or antenna to the CABLE/ANTENNA jack on the back of your TV.

Go to page 14

2. If you're connecting a cable box, connect the G-LINK cable

A. If you haven't already done so, remove the Demo Pin from the G-LINK jack.

B. Connect the G-LINK cable to the G-LINK jack on the TV. Next step, place the wands of the G-LINK cable to the cable box (instructions are on p. 13).

Go to page 13

Connections & Setup

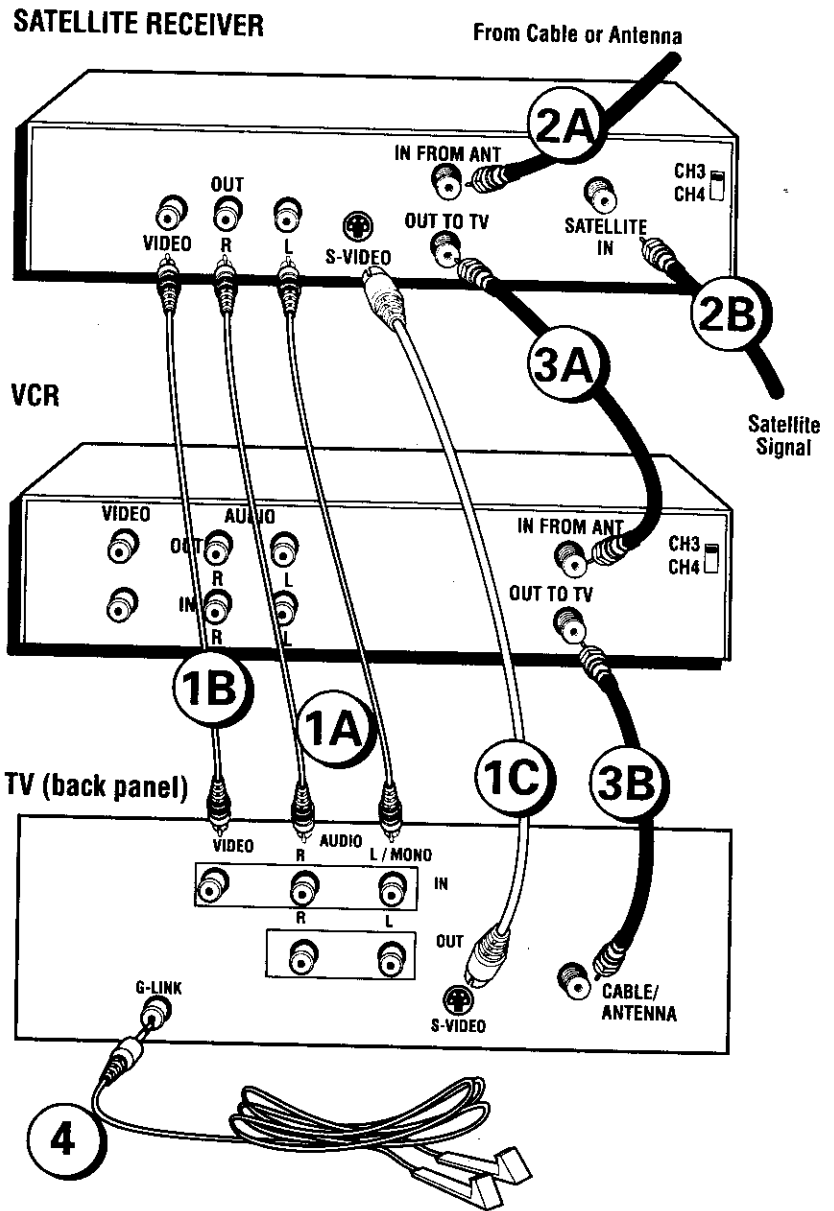
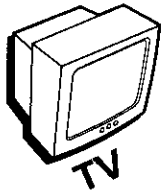
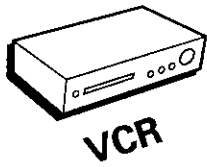
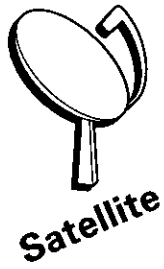

Connection: TV + VCR + Satellite Receiver

1. **Connect your Satellite Receiver to your TV**
 - A. Connect the audio/video cables. Connect the audio cables (white and red) to the AUDIO IN jacks on the back of the TV (R and L/MONO) and to the Audio Output Jacks on the Satellite Receiver.
 - B. Connect the video cable (yellow) to the VIDEO IN jack on the back of the TV and to the Video Output Jack on the satellite receiver.
 - C. Connect S-Video cable (optional). Connect an S-Video cable to the S-VIDEO jack on the TV and to the S-VIDEO jack on the satellite receiver. (An S-Video cable provides better picture quality than a regular video cable, but it is optional.)
2. **Connect coaxial cables to the Satellite Receiver**
 - A. Connect the coaxial cable from your cable outlet, cable box, or antenna to the Input Jack on your satellite receiver (sometimes labeled IN FROM ANT).
 - B. Connect the coaxial cable from your satellite dish antenna to the Input Jack on your satellite receiver (sometimes labeled SATELLITE IN).
3. **Connect the Satellite Receiver to the VCR and to the TV**
 - A. Connect a coaxial cable to the Output Jack (sometimes labeled OUT TO TV) on the satellite receiver and to the Input Jack on the VCR (sometimes labeled IN FROM ANT).
 - B. Connect a coaxial cable to the Output Jack on the VCR (sometimes labeled OUT TO TV) and to the CABLE/ANTENNA jack on the TV.
4. **Connect G-LINK cable**
 - A. If you haven't done so, remove the Demo Pin from the G-LINK jack.
 - B. Connect the G-LINK cable to the G-LINK jack on the TV. Next step, place one of the wands of the G-LINK cable to work with your VCR (instructions are on p. 13).

Go to page 13

Connections & Setup

Jacks on the Back of Your TV

If you are connecting many components, please consult the manual that came with each component for connection instructions. The picture of your TV's back panel describes the jacks on the back of your TV and what types of components that you can connect to these jacks.

When connecting, make sure you connect Output jacks to Input jacks, Video to Video, Right Audio to Right Audio, etc.

Audio and Video Input Jacks: AUDIO R and L/MONO and VIDEO

Connect any of the following components:

- DVD Player
- Laserdisc Player
- Internet Access Device
- Satellite Receiver
- VCR

To watch the content from the component that's connected to the VIDEO Input Jack, press the WHO • INPUT button on the remote (the TV switches to the correct channel).

Audio Output Jacks: R and L OUT

Connect audio cables to these jacks and to an amplifier or audio receiver for improved sound quality.

TV
(back panel)

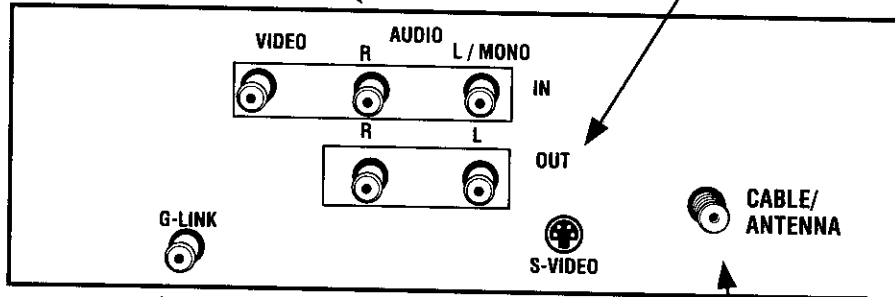

G-LINK Jack

Connect the end of the G-LINK cable (provided) to this jack. The G-LINK cable enables the TV's Guide Plus+ system to interact with the cable box and/or the VCR. A picture of the G-LINK cable is on page 7.

S-VIDEO Jack

Connecting an S-Video cable is optional. S-Video provides better picture quality than a regular video cable.

CABLE/ANTENNA Jack

Connect the coaxial cable from the VCR's Output jack to this jack. If you're not connecting a VCR, connect a coaxial cable that carries the signal from the antenna, cable, or cable box to the CABLE/ANTENNA jack.

Why You Should Connect This G-LINK Cable

The G-LINK cable enables the GUIDE Plus+ system (the on-screen interactive program guide) to work with your VCR and/or cable box.

Cable Box – If your TV is connected to a cable box you must connect the G-LINK cable to receive TV program listings for your area, and to tune directly to a channel when the program guide is on your TV screen.

VCR – If your TV is connected to a VCR and you don't connect the G-LINK cable, one-touch VCR recording won't work. The other features of the guide will work properly.

How to Find the Remote Sensor

You have to place the G-LINK wands in front of the remote sensor on the VCR and/or cable box. Some cable boxes and VCRs have the remote sensor labeled on the unit. If the remote sensor isn't labeled on your VCR and/or cable box, you need to use the remote control that came with the VCR and/or cable box to locate the sensor.

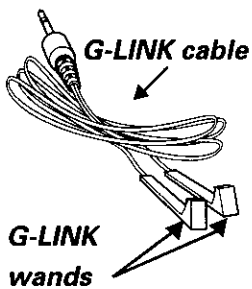

1. Turn off the VCR and/or cable box.
2. Hold the remote control (**not** the one that came with your TV, but the one that came with the cable box and/or VCR to which you're attaching the G-LINK cable) so that it is touching the front of the component.
3. Slowly move the remote control across the front of the component (VCR or cable box) while you press the power button on and off. You must press and release the power button each time you move the remote (holding down the button won't work).

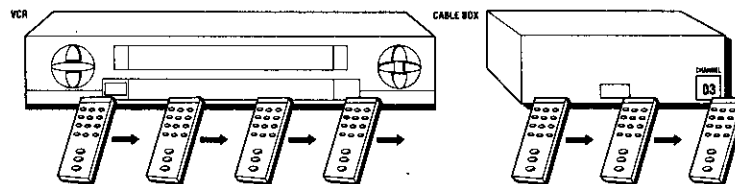

4. When the component turns on, you've located the remote sensor.

Placing the G-LINK Wands

Place the G-LINK wands in front of the remote sensor on your VCR and/or cable box approximately one inch away from the remote sensor (see instructions below).

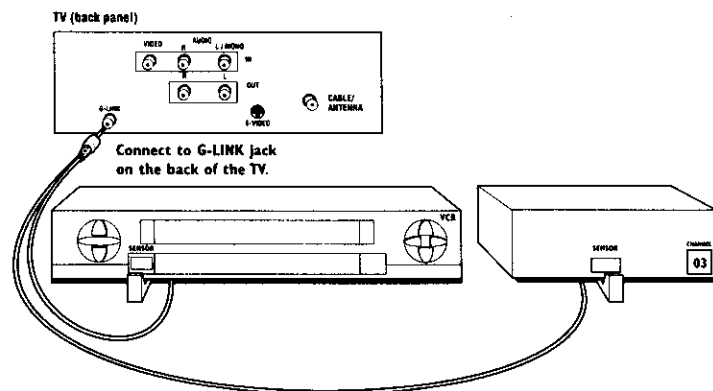

Tip

If you don't have both a cable box and a VCR connected to your TV, just coil the cable of the extra G-LINK wand with a twist tie and leave it behind the TV.

Plug in the TV

Plug the end of the power cord into the wall outlet. Match the wide blade of the plug with the wide slot in the outlet. Insert the plug completely into the outlet.

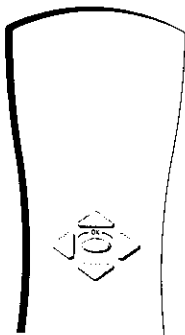
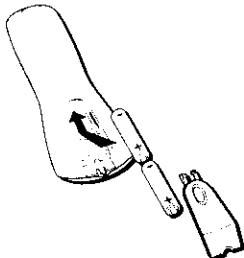

Use the arrow buttons and the OK button to move through the menu system.

Put Batteries in the Remote

1. Remove the battery compartment cover on the remote.
2. Insert new batteries. Match the polarities (+ and -) on the batteries with the diagram on the remote.
3. Put the battery compartment cover back on the remote.

How to Use the Remote Control to Complete the Interactive Setup

The technical term is “Navigation” – how you move through the on-screen menus. The theory is the same throughout the menu screens: highlight your choice and select it.

To highlight a menu item, press the arrow buttons on the remote to highlight one of the items listed on the screen. Use the up or down arrow button to move up or down. Use the right or left arrow button to move right or left.

To select the item that you’ve highlighted, press OK.

Note: Highlighted means that the menu item stands out from other menu items on the list (appears darker, brighter, or a different color).

Turn on the TV

Press the TV button on the remote control or the POWER button on the TV (the first screen of the Interactive Setup appears). The menu screens “time out” after a period of time if you don’t make a selection. The tips in this section tell you how to access the Setup menu screens manually.

Note: Pressing the TV button not only turns on the TV, but puts the remote into TV mode. “TV mode” means that the buttons on the remote control operate the TV’s functions.

Complete the Interactive Setup

Tip

To access the setup menus manually, press **MENU** and choose **Setup**.

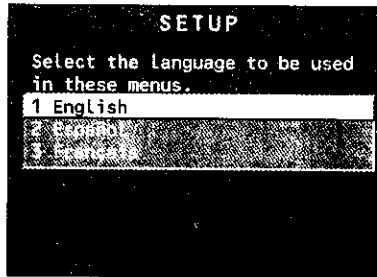

The menu system in your TV allows the TV's features to work properly. In this book, we call it the "interactive setup" because the TV asks you questions, you answer, and the TV makes the appropriate adjustments. The first time you turn on your TV, the setup screens appear automatically.

Set the Menu Language

The first part of the *SETUP* asks you to select your preferred language for the menu system.

1. Highlight your preferred language for the menu system.
2. Press **OK** to select that language.

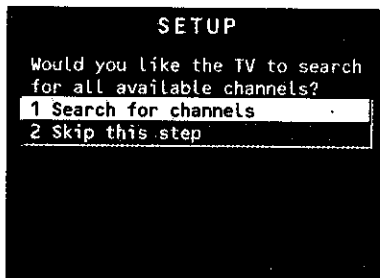

Complete Auto Channel Search

The next part of the *SETUP* asks you if you want the TV to search for all channels viewable through your antenna or cable TV system. This is sometimes called "auto programming."

1. Press **OK** to tell the TV to begin searching for channels. A progress report appears on the screen.
2. When the screen on the TV tells you the search is complete, press **OK** (the first **GUIDE Plus+** screen appears).

Note: If you skip Auto Channel Search now, you can access it later through the Channel menu. See Chapter 3 for more details.

The GUIDE Plus+ System Setup

The **GUIDE Plus+** system is an on-screen interactive program guide that lists what shows are on TV in your area. In order to receive program listings, you need to complete the following steps.

The **G-LINK** cable must be connected to the back of your TV, and the wands must be placed underneath your cable box and/or VCR in order for the **GUIDE Plus+** system to work (go back to p. 13 for details).

1. You should see a screen displaying the features of the **Guide Plus+** system. Press **OK** to continue.
2. The next screen asks you to locate setup materials and hardware. Once you have done this, press **OK** to continue.

Tip

If you move to a new zip or postal code, or if any of your information changes, you need to access the setup screens from the TV's main menu—press **MENU**, choose **GUIDE Plus+ Menu**, and choose **GUIDE Plus+ Setup**.

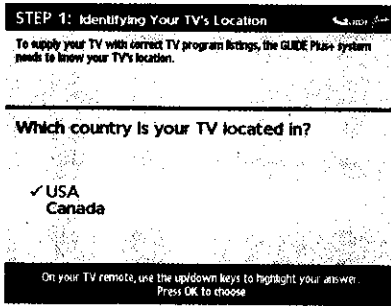

Step 1: Identifying Your TV's Location

1. If your country is highlighted, press OK on the remote control.

If your country isn't highlighted, press the up or down arrow button on the remote control to highlight your country and press OK.

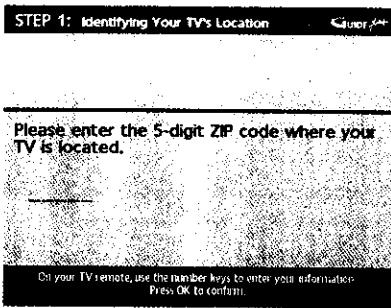

2. Use the number buttons on your remote to enter your zip code. Press OK when you're finished.

Note: If your postal code contains letters, press the up and down arrow buttons on your remote to enter letters, and press the right arrow button to go to the next space. The left arrow button moves you to the left.

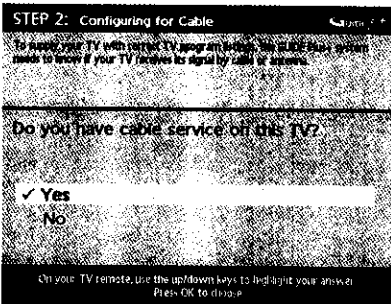

Step 2: Configuring for Cable

The next series of screens asks you about your cable setup. To supply your TV with the correct TV program listings, the GUIDE Plus+ system needs to know if your TV is connected to cable.

1. If your TV is connected to cable, highlight *Yes* and press OK.

If your TV isn't connected to cable, highlight *No* and press OK (*STEP 3: Configuring for a VCR* appears).

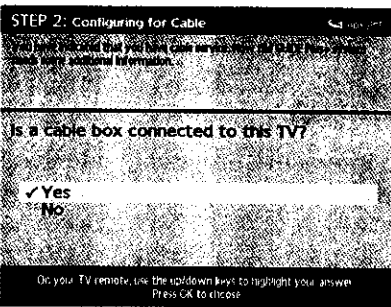

2. If you have a cable box connected to this TV, highlight *Yes* and press OK on your remote control.

Note: The next series of screens is very important because the GUIDE Plus+ system must find the correct cable box information in order to receive the correct TV program listings.

If you don't have a cable box connected to this TV, highlight *No* and press OK (*STEP 3: Configuring for a VCR* appears).

Tip

If you're not sure which channel is the cable box's output channel, consult the book that came with your cable box or contact your cable company.

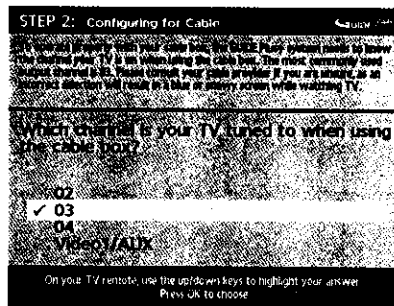

3. Highlight the channel to which you have to tune your TV in order to see cable programming, and press OK (a screen appears reminding you to connect your G-LINK cable to your TV and cable box).

Notes: Channel 03 is the most common.

Choose Video1/AUX if your cable box is connected to your TV with audio/video cables instead of a coaxial cable. Go to page 7 for pictures of these cables.

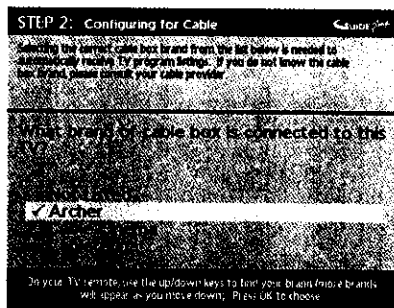

4. Highlight your brand of cable box, and press OK.
If your brand isn't listed, highlight *Not Listed* and press OK.

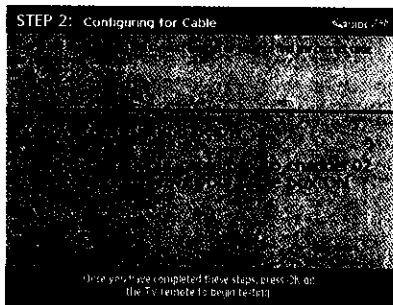

5. Make sure your cable box is on.
Tune the cable box to channel 02 (use the remote control that came with your cable box, or press the channel buttons on the cable box).
Press OK (the GUIDE Plus+ system starts testing codes).

Important Note: *When code testing is in progress, don't touch your TV, VCR, cable box or any of the remote controls for these products.*

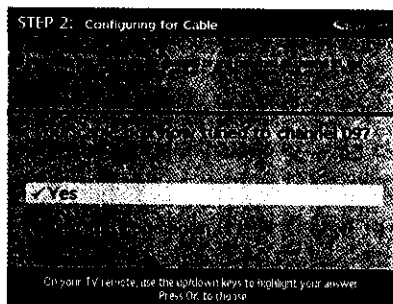

6. Look at your cable box. If it is still on and changed to channel 09, the test was successful. Highlight *Yes*, and press OK (*STEP 3: Configuring for a VCR appears*).

If your cable box didn't change to channel 09 or turned itself off, you have two choices: *No* and *Test this code again*.

Test this code again: If you think the TV, the cable box, or any of the remote controls might have been touched or bumped during the test, highlight *Test this code again* and press OK (the GUIDE Plus+ system runs the same set of codes).

No: If you don't think the test was interrupted, highlight *No* and press OK (GUIDE Plus+ system tests the next code).

Repeat the previous instructions until the TV finds the correct cable box code. Follow the instructions on the screen.

Note: *If the TV can't find your cable box code, a troubleshooting checklist appears. Carefully review each checklist and follow the instructions on the screen.*

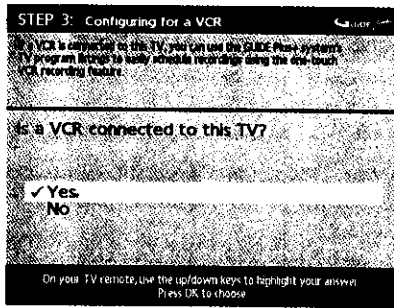

Step 3: Configuring for a VCR

1. If your TV is connected to a VCR, press OK.

If it is not, highlight *No* and press OK (A screen will appear reminding you to connect your G-LINK cable to your TV and VCR.).

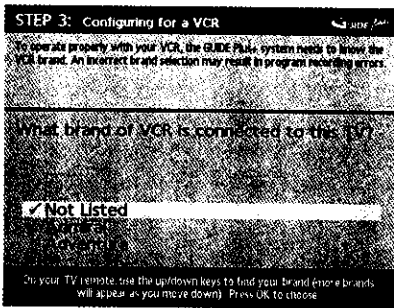

2. Use the up and down arrow buttons to highlight the brand of your VCR that is connected to the TV and press OK.

If your brand isn't listed, highlight *Not Listed* and press OK.

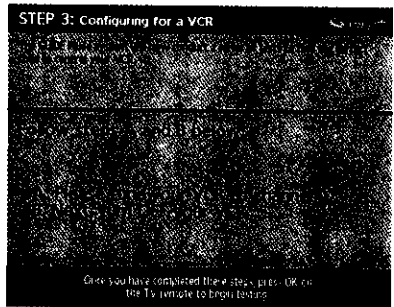

3. Tune your VCR to channel 02. Next, turn OFF your VCR. When you complete these steps, press OK to begin testing.

Important Note: When code testing is in progress, don't touch your TV, VCR, or any of the remote controls for these products.

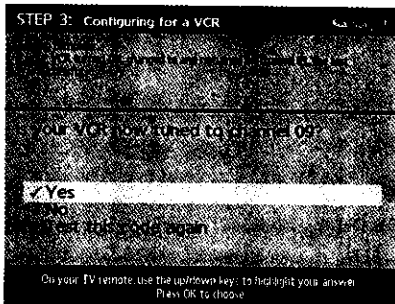

4. Look at the front display of your VCR. If your VCR turned on automatically and changed to channel 09, the test was successful. Highlight *Yes* and press OK.

If your VCR didn't change to channel 09, you can either choose *No* or *Test this code again*.

If you think your TV or remotes might have been touched during the test, tune your VCR to channel 02, turn off your VCR and highlight *Test this code again*.

If you don't think the test was interrupted, highlight *No*. Tune your VCR to channel 02 and turn off your VCR. Press OK (the GUIDE Plus+ system starts testing another set of codes.)

Keep following the previous instructions until the VCR finds the correct code.

Tip

Leave your cable box turned ON to download program information.

Leave your VCR turned OFF to record programs.

Note: If the GUIDE Plus+ system can't locate the correct code for the VCR, a list of troubleshooting instructions appears to help you before you try again.

- Try VCR configuration again: repeat VCR setup.
- Test alternate codes: tests selected brands and if this fails, the test continues with all codes in the system.
- Skip this step: the GUIDE Plus+ system won't be able to automatically schedule programs to record on your VCR.

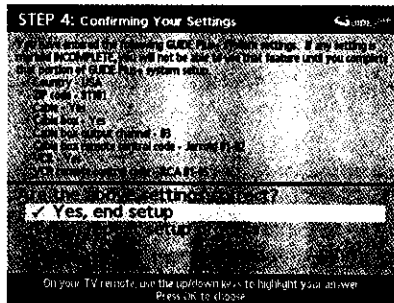

Step 4: Confirming Your Settings

1. Check to make sure all settings are complete and correct. If all settings are complete, highlight *Yes, end setup* and press OK. If your cable box and/or VCR code testing failed, you should see *INCOMPLETE* where the cable box and VCR codes are listed. Once setup is complete, additional screens appear.

If any settings are incomplete or incorrect, highlight *No, repeat setup process* and press OK. Follow the instructions on the screen.

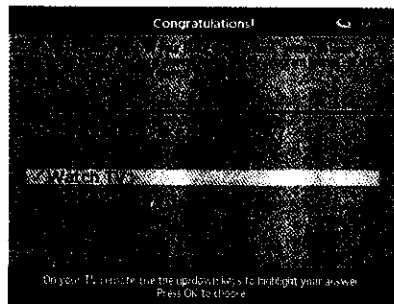

2. You can choose to view a demo of the GUIDE Plus+ features, which may take a few minutes to load. If you don't want to see the demo right now, press OK to watch TV.

What to Expect

The next time you turn on your TV, the GUIDE Plus+ system will appear on the screen. The following examples explain what you might see:

- If all of the program information has been sent to your TV, the GUIDE Plus+ system appears with all of your TV program listings.
- If the program information hasn't been sent to your TV yet, an outline of the GUIDE (without TV program listings) will appear on the screen. Program information is usually sent to your TV at night.
- If the TV detected that you have multiple cable companies in your area, *STEP 5: Choosing Your Channel Lineup* appears.

Features of the GUIDE Plus+ system are explained in Chapter 3.

To clear the guide from your screen, press CLEAR or GUIDE on the remote control.

Next Steps

Now that you've finished the Interactive Setup, you're ready to watch TV. This might be a good time to program your remote control. The remote control that came with this TV can be programmed to operate other components. Go to the next chapter to find out how to program your remote.

Using the Remote Control

Chapter Overview:

- **The Buttons on the Remote Control**
- **Programming the Remote to Operate Other Components**
- **How To Use the Remote After You've Programmed It**
- **Code List**

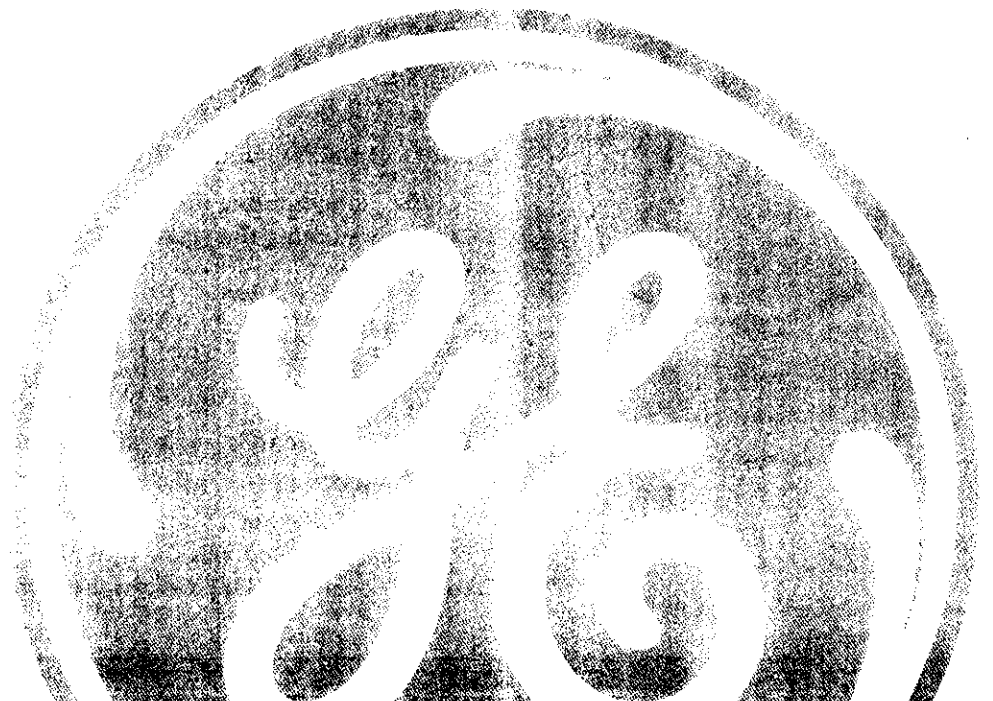

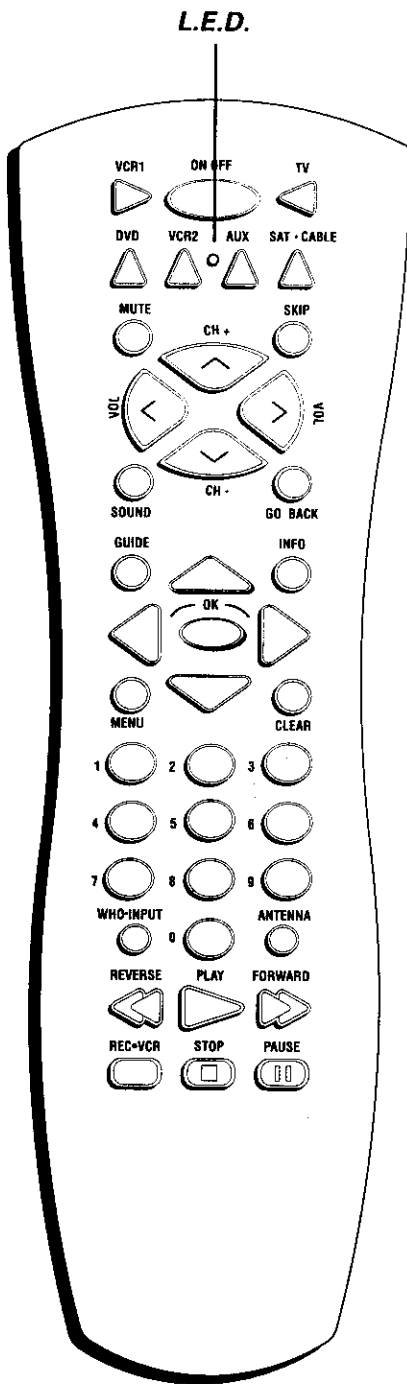

The Buttons on the Remote Control

0-9 (Number buttons) Enter channel numbers and time settings directly through the remote control.

To enter a two-digit channel, press the two digits. To enter a three-digit channel, press and hold the first digit for two seconds until two dashes appear to the right of the number, then add the second two. Example: to tune to channel 123, press and hold 1 for two seconds, press 2, then press 3.

Arrow buttons (up, down, left, right) Press the arrow buttons to move through the on-screen menu system.

ANTENNA Functions as TV/VCR button in VCR mode and TV/receiver button in SAT•CABLE mode.

AUX (auxiliary) Puts the remote in auxiliary mode to operate the component you've programmed the remote to operate with this button. You can program this button to control a cable box, most RCA, GE and PROSCAN audio components, a laserdisc player, or a VCR. If you set up the Auto Tuning feature (Chapter 3), pressing the AUX button automatically tunes the TV to the correct channel.

CH (up and down) buttons Scan up or down through the current channel list. Press once to change the channel up or down; press and hold to continue changing channels.

CLEAR Removes any menu or display from the screen and returns you to TV viewing.

DVD Puts the remote in DVD mode. If you set up the Auto.Tuning feature (Chapter 3), pressing the DVD button automatically tunes the TV to the correct channel.

FORWARD If you're operating a VCR or DVD Player with the remote control, press FORWARD to advance a disc or videotape.

GO BACK Returns you to the previous channel.

GUIDE Press GUIDE to make the GUIDE Plus+ system appear on the screen; press GUIDE again to remove it from the screen.

INFO Displays channel information.

L.E.D. (light-emitting diode) The little light on the remote that lights when you are programming the remote. It also lights when you press a valid button on the remote.

MENU Displays the TV's Main menu. You can also press and hold for 2 seconds to display the GUIDE Plus+ system.

MUTE Lowers the volume to its minimum level. Press again to restore volume.

OK When a menu is on the screen, press OK to select the item that is highlighted.

ON•OFF Turns the TV on and off. When the remote is in another mode (VCR, DVD, Satellite, etc.) and the remote is programmed to operate that component, you can press ON•OFF to turn the component on and off.

Tip

To turn off all the RCA, GE, and PROSCAN components that are connected to the TV, press ON•OFF twice within two seconds.

This feature only works with most RCA, GE and PROSCAN products.

PAUSE If you're operating a VCR or DVD Player with the remote control, press PAUSE when the disc or videotape is playing to pause playback.

PLAY If you're operating a VCR or DVD Player, plays the disc or videotape.

REC•VCR+ When the GUIDE Plus+ program guide is on the screen, press REC•VCR+ to program your VCR to record a program. If the remote is in VCR mode, press REC•VCR+ to start recording.

REVERSE If you're operating a VCR or DVD Player with the remote control, press REVERSE to go backwards on a disc or videotape.

SAT•CABLE Puts the remote in SAT•CABLE mode. If you set up the Auto Tuning feature (Chapter 3), pressing the SAT•CABLE button automatically tunes the TV to the correct channel.

SKIP If you press this button before you change the channel, the TV waits 30 seconds and automatically goes back to the original channel. Each time you press SKIP, you add 30 seconds (i.e., if you press SKIP two times before you change the channel, the TV waits 60 seconds and automatically turns back to the original channel).

SOUND Displays the *AUDIO PROCESSOR* menu.

STOP If you're operating a VCR or DVD Player, stops playing the disc or videotape.

TV Turns on the TV and puts the remote in TV mode. Also displays channel information.

VCR1 Puts the remote in VCR mode. If you set up the Auto Tuning feature (Chapter 3), pressing the VCR1 button automatically tunes the TV to the correct channel.

VCR2 Puts the remote in VCR mode. If you set up the Auto Tuning feature (Chapter 3), pressing the VCR2 button automatically tunes the TV to the correct channel.

VOL (up and down) buttons Decrease or increase the TV's volume.

WHO•INPUT In TV mode, press WHO•INPUT to toggle through the available Video Input channels (VID/SVID and the current channel). In SAT mode, press to select available channel lists.

Using the WHO•INPUT Button

Use the WHO•INPUT button to toggle through the available input sources (VID and the current channel) and view the content from the component you have connected to the TV.

1. Press TV to place the remote in TV mode. Make sure that the content from the component is turned ON.
2. Press WHO•INPUT to tune to the available input source and view the component.
3. Press WHO•INPUT again to tune back to the channel you were previously watching.

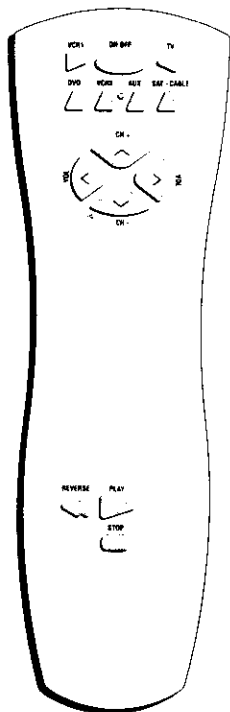

You'll use these buttons when you program the remote to operate another component.

The remote may not operate all models of all brands.

Tip

To stop the automatic code search without programming any components, press and hold CLEAR until the light on the remote turns off.

Programming the Remote to Operate Other Components

The universal remote control can be programmed to operate most brands of remote controllable VCRs, satellite receivers and cable boxes. The remote is already programmed to operate most RCA, GE and PROSCAN TVs, VCRs, DVD players, laserdisc players and satellite receivers.

Find Out If You Need to Program the Remote

To determine whether the universal remote needs to be programmed, turn a component ON, such as a VCR, point the remote at the VCR, and press the VCR1 button. Then press ON•OFF or channel up or channel down to see if the VCR responds to the remote commands. If not, the remote needs to be programmed.

How to Program the Remote

There are two ways to program the remote control: automatic code search and direct entry. Instructions for both ways follow.

Using Automatic Code Search

1. Turn on the component you want the remote to operate (VCR, DVD Player, etc.)
2. Press and hold the component button on the remote control that corresponds to the component you want the remote to operate (VCR1, DVD, etc.). While you hold down the component button, press and hold ON•OFF (when the red light on the remote turns on, release both buttons).
3. Press PLAY (the red light on the remote, located below the ON•OFF button, starts flashing).

The remote is searching the first set of component codes (there are 20 sets of codes). If the component you want to operate doesn't turn off automatically after 5 seconds, press PLAY again (the red light starts flashing again as the remote searches through the next set of codes).

Continue pressing PLAY until the component turns off.

Note: If the component doesn't turn off after you've pressed the PLAY button 20 times, the component can't be programmed.

4. Press REVERSE, wait 2 seconds. Repeat this step until the component turns back on.
5. To finish, press and hold the STOP button until the red light on the remote turns off.

Using Direct Entry

1. Turn on the component you want the remote to operate.
2. Look up the brand and code number(s) for the component on the code list on page 26.
3. Press and hold the component button that corresponds to the component you want the remote to operate (VCR1, DVD, etc.)
4. Enter the code from the code list.
5. Release the component button.
6. Press ON•OFF to see if the component responds to the remote commands. If it doesn't, try pressing the component button and then ON•OFF again.
7. If you get no response, repeat these steps using the next code listed for your brand until the component responds to the remote commands.

How to Use the Remote After You've Programmed It

Tip

The buttons might operate differently for other components, especially when you're using another component's menu system.

Once the remote has been programmed successfully, you are ready to use it to control your components. To operate the component:

1. Press the component button (TV, VCR1, VCR2, DVD, AUX, or SAT•CABLE) to set the remote to operate the component.
2. Press ON•OFF to turn the component ON or OFF.
3. Use the remote buttons that apply to that component.

Note: If you keep pressing buttons and nothing happens, the remote is probably in the wrong mode. You must press the component button that matches the component you want to operate (i.e., if you want to operate the VCR, press VCR1 on the remote control to put the remote in VCR mode.)

Code List

VCR

Admiral	2131
Adventura	2026
Aiko	2027
Aiwa	2002, 2026
Akai	2003, 2004, 2005, 2007, 2008, 2111, 2112, 2113
American High	2021
Asha	2013
Audio Dynamics	2009, 2010
Audiovox	2014
Bell & Howell	2011
Beaumont	2013
Broksonic	2012, 2025
Calix	2014
Candle	2013, 2014, 2015, 2016, 2017, 2018, 2019
Canon	2021, 2022, 2114
Capehart	2020, 2110
Carver	2062
CCE	2027, 2061
Citizen	2013, 2014, 2015, 2016, 2017, 2018, 2019, 2027
Colortyme	2009
Colt	2061
Craig	2013, 2014, 2023, 2061
Curtis-Mathes	2000, 2002, 2009, 2013, 2016, 2018, 2021, 2022, 2024, 2115
Cybernex	2013
Daewoo	2015, 2017, 2019, 2025, 2026, 2027, 2028, 2110
Daytron	2110
Dbx	2009, 2010
Dimensia	2000
Dynatech	2002, 2026
Electrohome	2014, 2029
Electrohome	2014
Emerson	2002, 2012, 2014, 2015, 2021, 2024, 2025, 2026, 2029, 2030, 2032, 2033, 2034, 2035, 2036, 2037, 2038, 2039, 2040, 2041, 2042, 2044, 2045, 2047, 2065, 2105, 2113, 2116, 2117, 2130
Fisher	2011, 2023, 2048, 2049, 2050, 2051, 2052, 2118
Fuji	2021, 2119
Funai	2002, 2026
Garrard	2026
GE	2000, 2001, 2013, 2021, 2022, 2053, 2115, 2120
Goldstar	2009, 2014, 2018, 2054, 2121
Gradiente	2026
Harley Davidson	2026
Harman Kardon	2009
Harwood	2061
Headquarter	2011
Hitachi	2002, 2055, 2056, 2057, 2107, 2111, 2120, 2122
HI-Q	2023
Instant Replay	2021
JCL	2021
JC Penney	2009, 2010, 2011, 2013, 2014, 2021, 2022, 2055, 2056, 2058, 2059, 2060, 2107, 2118
Jensen	2055, 2056, 2111
JVC	2009, 2010, 2011, 2018, 2058, 2111, 2123
Kenwood	2009, 2010, 2011, 2016, 2018, 2058, 2111, 2123
KLH	2061
Kodak	2014, 2021
Lloyd	2002, 2026
Logik	2061
LXI	2014
Magnavox	2021, 2022, 2062, 2063, 2104, 2108, 2124
Magnin	2013
Marantz	2009, 2010, 2011, 2016, 2018, 2021, 2058, 2062, 2064
Marta	2014
Masushita	2021
MEI	2021
Memorex	2002, 2011, 2013, 2014, 2021, 2023, 2026, 2104, 2131
MGA	2029, 2065, 2113
MGN Technology	2013
Midland	2053
Minolta	2055, 2056, 2107
Mitsubishi	2029, 2055, 2056, 2065, 2066, 2067, 2069, 2070, 2071, 2072, 2073, 2074, 2106, 2113, 2123
Montgomery Ward	2075, 2131
Motorola	2021, 2131
MTC	2002, 2013, 2026
Multitech	2002, 2013, 2016, 2026, 2053, 2061
NEC	2009, 2010, 2011, 2016, 2018, 2058, 2064, 2076, 2078, 2079, 2111, 2123
Nikko	2014
Noblex	2013

Olympus	2021
Optimus	2014, 2131
Optonica	2096
Orion	2035
Panasonic	2021, 2022, 2109, 2125, 2126, 2127
Pentax	2016, 2055, 2056, 2107, 2120
Penrex Research	2018
Philco	2021, 2022, 2062, 2063
Philips	2021, 2062, 2096, 2124
Pilot	2014
Pioneer	2010, 2055, 2080, 2081, 2123
Portland	2016, 2017, 2019, 2110
ProScan	2000, 2001
Protec	2061
Pulsar	2104
Quarter	2011
Quasar	2021, 2022, 2125
RCA	2000, 2001, 2003, 2013, 2021, 2055, 2056, 2082, 2083, 2084, 2085, 2086, 2087, 2088, 2089, 2090, 2091, 2107, 2115, 2120, 2125
Radioshack/Realistic	2002, 2011, 2013, 2014, 2021, 2022, 2023, 2026, 2029, 2049, 2050, 2096, 2131
Radix	2014
Randex	2014
Ricoh	2014
Rinco	2128
Samsung	2005, 2013, 2015, 2033, 2053, 2112
Sanky	2131, 2104
Sansui	2010, 2092, 2111, 2123
Sanyo	2011, 2013, 2023
Scott	2012, 2015, 2025, 2032, 2035, 2038, 2065, 2093, 2116
Sears	2011, 2014, 2021, 2023, 2048, 2049, 2050, 2051, 2055, 2056, 2107, 2118
Sharp	2002, 2017, 2029, 2094, 2095, 2096, 2131
Shintom	2004, 2056, 2061, 2098
Shogun	2013
Signature	2002, 2131
Singer	2021, 2061, 2128
Sony	2002, 2004, 2098, 2099, 2119, 2128
STS	2021, 2107
Sylvania	2002, 2021, 2022, 2026, 2062, 2063, 2065, 2124
Symphonic	2002, 2026
Tandy	2002, 2011
Tashiko	2014
Tatung	2058, 2111
TEAC	2002, 2026, 2058, 2085, 2111
Technics	2021, 2109
Teknika	2002, 2014, 2021, 2026, 2100, 2129
TMK	2013, 2024, 2047
Toshiba	2015, 2049, 2051, 2055, 2065, 2093, 2116
ToteVision	2013, 2014
Unitech	2013
Vector Research	2009, 2010, 2015, 2016
Victor	2010
Video Concepts	2009, 2010, 2015, 2016, 2113
Videosonic	2013
Wards	2002, 2013, 2014, 2015, 2021, 2023, 2026, 2029, 2055, 2056, 2061, 2096, 2101, 2102, 2103, 2107, 2116, 2131
XR-1000	2021, 2026, 2061
Yamaha	2009, 2010, 2011, 2018, 2058, 2111
Zenith	2004, 2098, 2104, 2119, 2128

Movie Time	5002, 5027, 5028
NSC	5002, 5027, 5028
Oak	5002, 5016, 5029
Panasonic	5048, 5052
Paragon	5026
Philips	5011, 5012, 5013, 5019, 5025, 5030, 5031, 5032
Pioneer	5033, 5034
Pulsar	5026
RCA	5047, 5049, 5052
Realistic	5009, 5049
Regal	5022, 5035
Regency	5017
Rembrandt	5003
Rinco	5026
Samsung	5014, 5034
Scientific Atlanta	5006, 5036, 5037, 5038
Signal	5014, 5018
Signature	5003
St. Marx	5014
Sprucer	5052
Starcom	5007, 5018, 5053
Stargate	5014, 5018
Starquest	5018
Tandy	5040
Televue	5014
Tocom	5004, 5023, 5041
Toshiba	5026
Tusa	5018
TV86	5027
Unika	5008, 5009, 5011
United Artists	5002
United Cable	5053
Universal	5008, 5009, 5010, 5011
Videoway	5044
Viewstar	5015, 5025, 5027, 5040
Zenith	5026, 5050, 5051

Satellite Receivers

Chapparal	5056, 5057
Drake	5058, 5059
GE	5000
General Instruments	5060, 5061, 5062
Panasonic	5075
Primestar	5076
ProScan	5000
RCA	5000
Realistic	5063
Sony	5072
STSI	5064
STS2	5065
STS3	5066
STS4	5067
Toshiba	5068
Toshiba	5073
Uniden	5069

Cable Boxes

ABC	5002, 5003, 5004, 5005, 5006, 5007, 5053
Antronix	5008, 5009
Archer	5008, 5009, 5010, 5011
Cabletenna	5008
Cableview	5008
Century	5011
Citizen	5011
Colour Voice	5012, 5013
Comtronics	5014, 5015
Contec	5016
Eastern	5017
Garrard	5011
GC Electronics	5009
Gemini	5018, 5019, 5049
General Instrument	5003
Hamlin	5020, 5021, 5022, 5035, 5045
Hitachi	5003
Hytex	5002
Jasco	5011
Jerrold	5003, 5005, 5007, 5018, 5023, 5024, 5046, 5053
Magnavox	5025
Memorex	5026

Using the TV's Features

Chapter Overview:

- All About the GUIDE Plus+ System
- The Channel Banner
- Auto Tuning
- Parental Controls and V-Chip



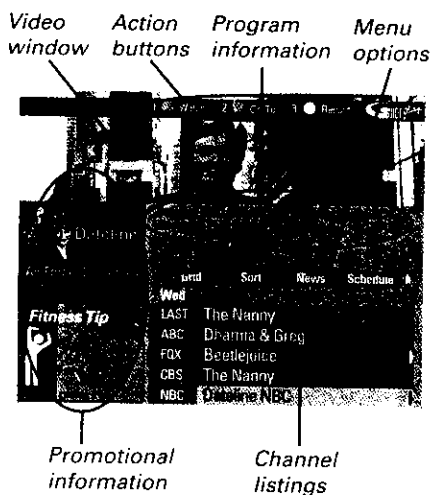

About the GUIDE Plus+ System

The GUIDE Plus+ system is an interactive on-screen program guide that lists TV schedules for your area and allows your TV direct control of a cable box and/or VCR. You must first set up the GUIDE Plus+ Menu system in order to view this on-screen program guide (see Chapter 1 for details). Press GUIDE to bring up the GUIDE Plus+ system.

There are six sections of the GUIDE Plus+ system:

- A row of Action buttons at the top of the screen (1, 2 and 3)
- Program information
- A row of menu options (Grid, Sort, News, Schedule, Messages, Channels, Setup)
- Channel listings
- Promotional information
- Video window

Note: The GUIDE Plus+ system screens illustrated in this book are representations of what you are likely to see. Not all channels, programs, and GUIDE Plus+ information depicted will be available in your area.

New features and options can be downloaded to the GUIDE Plus+ system, so these too are subject to change.

Tip

Since the program information provided by the GUIDE Plus+ system is based on your locale, you will need to run Setup again if you move to a different zip or postal code.

Downloading Data

The GUIDE Plus+ system is not available until it completes its first download of program listings. When the power is turned off, the TV locates a "host channel" that carries GUIDE Plus+ system data containing program schedule and channel lineup information. A channel lineup is the list of stations and their respective channels.

To ensure that your first download of data is complete, you should leave your TV off overnight. Downloads occur several times a day. The TV must be turned off for GUIDE Plus+ system data to download.

If the TV loses power or is unplugged, GUIDE Plus+ system program listings may be lost. When power is restored, make sure the setup information is still correct. The GUIDE Plus+ system will receive updated program information during the next scheduled download.

Channel Lineup

If more than one cable company services your area, you may be prompted with *STEP 5: Choosing Your Channel Lineup* after the first GUIDE Plus+ system download. You will need to identify your cable company by selecting the correct channel numbers for the stations in question.

- Use the up and down arrow buttons to change the channel group and press OK when the correct channel group is highlighted.

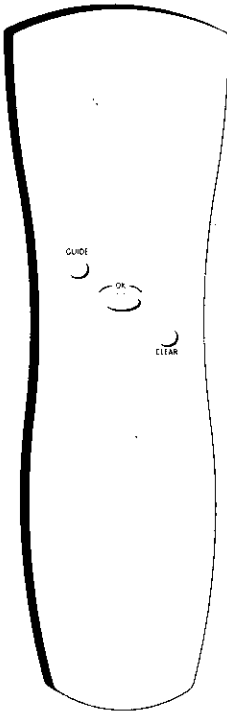

Press **GUIDE** on the remote control to see the **GUIDE Plus+ system**. To remove the program guide from the screen, press **OK**, **GUIDE**, or **CLEAR**.

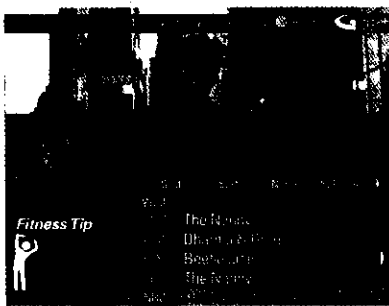

Getting In & Out of the GUIDE Plus+ System

To enter the GUIDE Plus+ system:

- Press **GUIDE** on the remote.
- Press and hold **MENU** for 2 seconds on the front panel.

To exit the GUIDE Plus+ system:

- Highlight a program and press **OK** to exit the GUIDE Plus+ system and tune to the channel.
- Press **GUIDE** to exit the GUIDE Plus+ system and tune to the channel displayed in the video window.
- Press **CLEAR** to exit the GUIDE Plus+ system and return to the original channel.

The GUIDE Plus+ System Menus

The GUIDE Plus+ system offers seven different options on the Menu bar: *Grid*, *Sort*, *News*, *Schedule*, *Messages*, *Channels* and *Setup*. To access the Menu bar:

1. Press **GUIDE** to access the GUIDE Plus+ system.
2. Press **MENU** or use the up and down arrow buttons to select the Menu bar (the Grid Guide appears by default).
3. Use the left and right arrow buttons to access other menus.
4. Press **OK**, or **MENU**, or use the down arrow button to see the menu options.

Grid Guide

The Grid Guide appears each time you enter the GUIDE Plus+ system. It displays the current programming for each channel. The current program is displayed in the video window.

- Press the up and down arrow buttons on the remote to browse channel listings and the channel up and down buttons to page through the listings. Use the right and left arrow buttons to browse future program listings.
- To tune to a channel, highlight the program you want to view in the channel listing and press **OK**. Press **CLEAR** to exit the GUIDE Plus+ system and return to the original channel. Press **GUIDE** to exit the GUIDE Plus+ system and tune to the channel in the video window.

Then use the Grid Guide Action Buttons as described next.

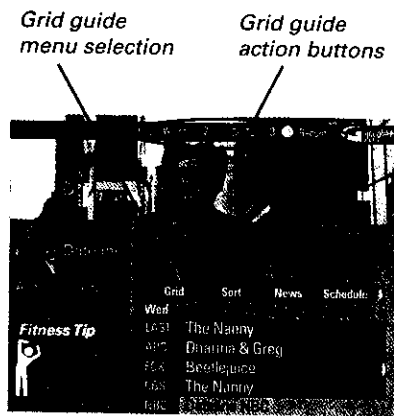

Grid Guide Action Buttons

Action buttons will change according to where you are in the GUIDE Plus+ system. Be sure to look at the action bar before pressing the command numbers.

When highlighting the program, the following Action buttons appear:

- **Watch** Press 1 on the remote to place a timer in the Schedule for the TV to turn on and tune to the program highlighted in the channel listing. When the TV turns on, the GUIDE Plus+ system will automatically appear with the scheduled program highlighted and tuned in the video window.
- **Go To** Press 2 on the remote to bring up the direct dial box and enter the number of the channel you want. Press OK to highlight the channel and current program in the channel listing of the Grid Guide. Press OK to tune to the highlighted channel. If the video window is unlocked, it will automatically tune to the channel.
- **Record** Press 3 on the remote to place a timer in the Schedule for the VCR to record the program highlighted in the channel listing.

If you have a cable box, changing channels on the TV will not cause the cable box channel to change while recording.

Record will only appear if you have set up the GUIDE Plus+ system and specified your VCR type.

The program information window will display a confirmation when you have successfully scheduled a program to watch or record.

Note: If you have selected two programs to watch or record which begin at the same time or overlap, you will receive a timer conflict message. You must choose between the two programs.



When highlighting the Channel names (the left column on the channel listing), the following Action buttons appear:

- **Lock/Unlock** Press 1 to lock or unlock the video window to either stay at one channel as you browse the GUIDE Plus+ system (lock) or change as you browse through different channels (unlock).
- **Go To** Press 2 on the remote to bring up the direct dial box and enter the number of the channel you want. Press OK to highlight the channel and current program in the channel listing of the Grid Guide. If the video window is locked, press OK to tune to the highlighted channel. If the video window is unlocked, it will automatically tune to that channel.

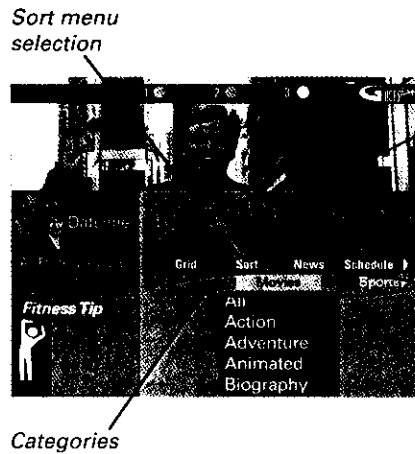

Sort

The *Sort* menu lets you browse programs by category. The channel to which you are currently tuned is displayed in the video window.

To Sort:

1. If the GUIDE Plus+ system isn't on your screen, press **GUIDE** on your remote control.
2. Press **MENU** on the remote to select the Menu bar.
3. Use the arrows to highlight *Sort*. When *Sort* is highlighted for the first time, the *Movies* category is displayed. Thereafter, the last category used becomes the default. A listing of subcategories is displayed below the category name. Use the left and right arrows to highlight other categories.
4. Use the up and down arrow buttons to highlight a subcategory. For example, highlight *All* and press **OK** (the GUIDE Plus+ system sorts the programs).
5. Press the up and down arrow buttons to review the list one program at a time. Press the channel up and down to review the list one page at a time.
6. Select **MENU** to return to the menu bar, or press **GUIDE** or **CLEAR** to exit the GUIDE Plus+ system.

Then use the Sort Menu Action Buttons as described next.



Sort Menu Action Buttons

When viewing the results of a Sort, the following Action buttons appear:

- **Watch** Press 1 on the remote to place a timer in the Schedule, and then follow the on-line help for further options. Placing a timer in the Schedule will cause the TV to turn on and tune to the program highlighted in the Channel listing at the predetermined time.
- **Record** Press 3 on the remote to set the VCR to record the program highlighted in the channel listing. If you have a cable box, changing TV channels will not cause the cable box channel to change while recording.

The program information window will display a confirmation when you have successfully scheduled a program to watch or record.

Note: If you have selected two programs to watch or record which begin at the same time or overlap, you will receive a timer conflict message. You must choose between the two programs.

Note: Be sure that during the GUIDE Plus+ system setup you specified that you have a VCR. If you didn't, the RECORD option will not be available.

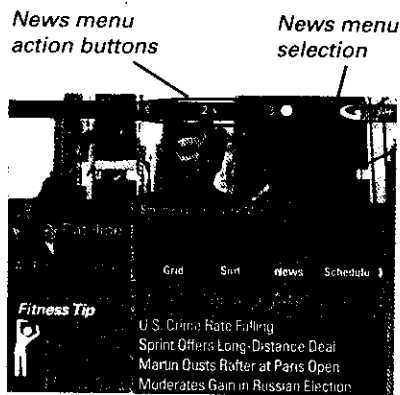

News

The *News* menu lets you browse current news stories by headline.

1. If the GUIDE Plus+ system isn't on your screen, press **GUIDE** on your remote control.
2. Press **MENU** on the remote control to select the menu bar.
3. Use the arrows to highlight *News* (if MSNBC is available on your TV, it will appear in the video window).
4. Use the up and down arrows to highlight a story.
 - Use the up and down arrows to browse the list one story at a time.
 - Use the channel up and down to browse through the list one page at a time.
5. Press the right arrow button to see full text.
6. If there are multiple pages of text, press the right or left arrow button to page forward or back through the pages of text. Press the down arrow to view the next story.
7. Select **MENU** to return to the Menu bar, or press **GUIDE** or **CLEAR** on the remote to exit the GUIDE Plus+ system.

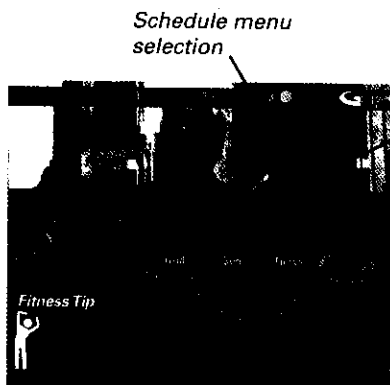

Schedule

The *Schedule* menu lets you alter timers for either viewing or recording programs. The GUIDE Plus+ system allows one-touch VCR recording if you have connected the G-LINK cable to your VCR. See Chapter 1 for more details on connecting the G-LINK cable.

To schedule a program to watch or record:

1. If the GUIDE Plus+ system isn't on your screen, press **GUIDE** on your remote control.
2. Press **MENU** on the remote to select the Menu bar.
3. Highlight a program within the channel listing.
4. Select *Watch* or *Record* from the Action buttons bar. The timer is then automatically logged into the *Schedule* menu.
5. If you select *Record*, make sure to place a blank tape in the VCR and turn it off.

Note: If you have a cable box connected to your TV and VCR, tune your VCR to the cable box output channel prior to turning off the VCR.

The program information window will display a confirmation when you have successfully scheduled a program to watch or record.

Note: If you have selected two programs to watch or record which begin at the same time or overlap, you will receive a timer conflict message. You must choose between the two programs.

To remove or change the frequency (daily, once, or weekly) of a scheduled event, access the *Schedule* menu from the Menu bar.

1. Press **GUIDE** to bring up the **GUIDE Plus+** system.
2. Press **MENU** on the remote to select the **Menu bar**.
3. Use the arrows to highlight the *Schedule* menu selection.
4. Use the up and down arrows to highlight the program you want to edit.

Then use the *Schedule Menu Action Buttons* as described next.



Schedule Menu Action Buttons

When viewing the *Schedule* menu the following Action buttons appear:

- **Remove** Highlight the *Watch* or *Record* timer you wish to remove from the schedule and press **1** on the remote.
- **Change** Highlight the *Watch* or *Record* timer you wish to change and press **3** on the remote to toggle the frequency between the following choices:
 - DAILY* records the same program each day Monday through Friday.
 - ONCE* records only on that day.
 - WEEKLY* records the program each week at the same time.

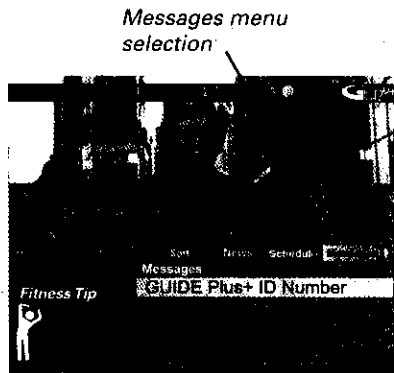

Messages

Occasionally you will receive messages regarding your **GUIDE Plus+** system, as well as special programming information. You can access these messages from the *Messages* menu on the Menu bar.

To read messages:

1. If the **GUIDE Plus+** system isn't on your screen, press **GUIDE** on your remote control.
2. Press **MENU** on the remote to select the **Menu bar**.
3. Use the arrows to highlight the *Messages* menu selection.
4. Highlight the message you want to read by using the up and down arrow buttons.
5. Press **INFO** to display the full text of the message. If the text continues beyond the screen, press **INFO** to view the next page of text. Once you have reached the end of the message, press **INFO** to close the expanded information and return to the *Messages* screen.

Then use the *Messages Menu Action Button* as described next.



Messages Menu Action Button

When viewing the *Messages* menu the following Action button appears:

- **Remove** Highlight the message you want to delete and press **1** on the remote.

Using the TV's Features

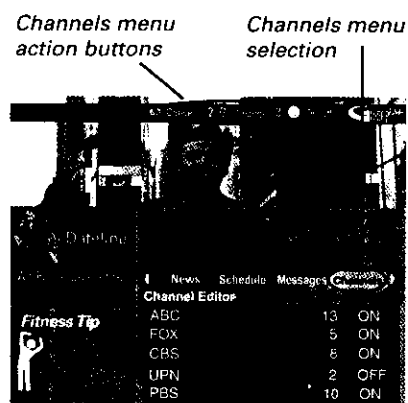

Channels

You can customize the channel listing by enabling or disabling the display of certain channels. For instance, you may disable channels that you never watch. You can restore disabled channels at a later point in time.

1. If the Guide Plus+ system isn't on your screen, press **GUIDE** on your remote control.
2. Press **MENU** to select the Menu bar.
3. Use the right and left arrows to highlight the *Channels* menu selection.
4. Use the up and down arrows to select a channel.

Then use the Channels Menu Action Buttons as described next.



Channels Menu Action Buttons

While browsing the *Channels* menu, the following Action buttons appear:

- **Cancel** Press 1 on the remote to cancel any changes you made since entering the *Channels* Menu.
- **Change** Press 2 on the remote to change the channel number for the highlighted channel line.
- **On/Off** Press 3 on the remote to toggle the state of the channel between *On* and *Off*.

Setup

The *Setup* menu allows you to access the GUIDE Plus+ system setup information. To access the Setup option:

1. If the Guide Plus+ system isn't on your screen, press **GUIDE** on your remote control.
2. Press **MENU** to select the Menu Bar.
3. Use the right arrow to highlight the *Setup* menu selection.
4. Use the up and down arrows to select *Change system settings*, *Review options*, or *View demo*.
 - **Change system settings** Confirms the settings you completed in the GUIDE Plus+ system setup are correct.
 - **Review options** Displays the GUIDE Plus+ auto display options.
 - On** Automatically displays the GUIDE Plus+ system when you press the **ON•OFF** button on the remote control.
 - Off** Disables the GUIDE Plus+ system from being displayed when you press the **ON•OFF** button on the remote control.
 - **View demo** Runs the GUIDE Plus+ system demonstration.

Note: If you have not completed your GUIDE Plus+ system setup, these options will not be available. A screen will prompt you to complete your setup.

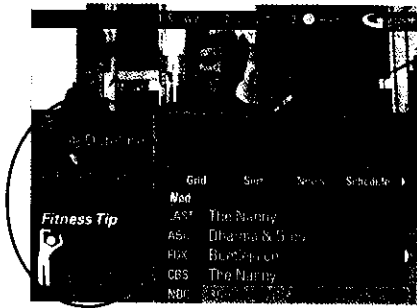

Promotional information

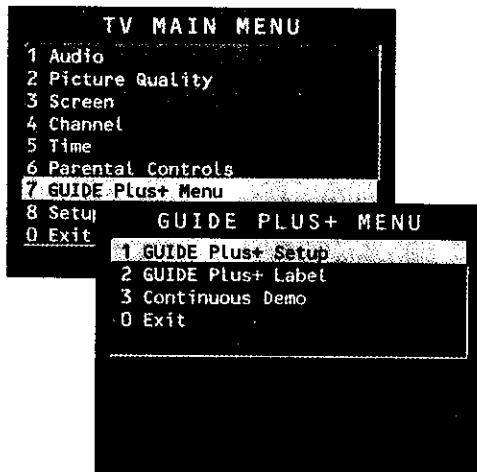

How to Get More Information About an Advertisement or a Program

To find out more information about a program, advertisement or special, use the left arrow button to highlight the channel listing or promotional information box.

Requesting more information about a particular show displays the PlusCode programming number and the *Shows on Next* for that channel.

Press the INFO button to exit the expanded information screen.

GUIDE Plus+ Menu Items

The *GUIDE Plus+ Menu* gives you access to features in the GUIDE Plus+ system. To access the *GUIDE Plus+ Menu*:

1. Press MENU on the remote.
2. Highlight *GUIDE Plus+ Menu* and press OK.

Each menu and the sub-menus are listed below:

GUIDE Plus+ Setup Displays the GUIDE Plus+ system setup screen.

Change system settings Confirms the settings you completed in the GUIDE Plus+ system setup are correct.

Review options Displays GUIDE Plus+ system auto display options.

View demo Runs the GUIDE Plus+ system demonstration.

GUIDE Plus+ Label Displays the GUIDE Plus+ label menu.

On Displays the station name when you change channels.

Off The station name isn't displayed when you change channels.

Continuous Demo Runs the GUIDE Plus+ demonstration until it is turned off. To stop the demonstration, you must turn off the TV.



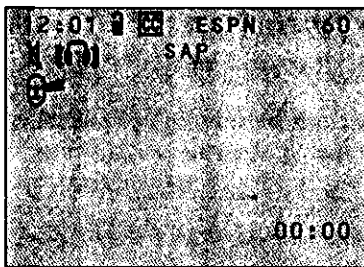

Note: If you have not completed your GUIDE Plus+ system setup, these options will not be available. A screen will prompt you to complete your setup.



Sample displays on a Channel Banner.

Channel Banner

There are several indicators that might appear when you press the TV or INFO buttons on the remote. This display is called the Channel Banner. The following list describes the items on the Channel Banner screen (left to right and top to bottom).

- 12:01** Displays the current time.
-  The lock is displayed to indicate when Parental Controls are locked or unlocked.
-  Displayed when Closed Captioning is available on the current channel.
- ESPN** Displays the label assigned to the current channel.
- 60** Displays the current channel or input channel.
-  Mute is displayed when you mute the audio.
-  Stereo is displayed when the current channel is broadcasting in Stereo.
- SAP** Displayed when the current channel is broadcasting SAP (Second Audio Program) information.
-  Displayed when the Sleep Timer has been set.
- 00:00** Displayed to count down time left on the commercial skip (SKIP) timer.

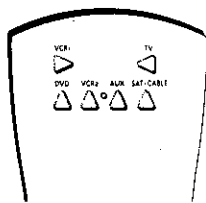

With the auto tuning feature, you can set up the TV to tune to the channel you need to watch by pressing that component's button.

Why You Should Use the Auto Tuning Feature

The auto-tuning feature automatically tunes the TV to the correct channel for different components you have connected to your TV (like a VCR, DVD Player, etc.) When you set up auto tuning in the menu system you don't have to remember to change your TV to channel 3, for example, when you want to watch the tape in your VCR.

How to Set Up the Auto Tuning Feature

The way you set up the auto tuning feature in the TV's menu corresponds to the component buttons on the remote and the way you have each component connected to your TV. When you set auto tuning, you're telling the TV what channel to tune to when you press the VCR1, VCR2, DVD, or SAT•CABLE button on the remote control.

1. Press MENU (the *TV MAIN MENU* appears).
2. Highlight *Channel* and press OK on your remote control.

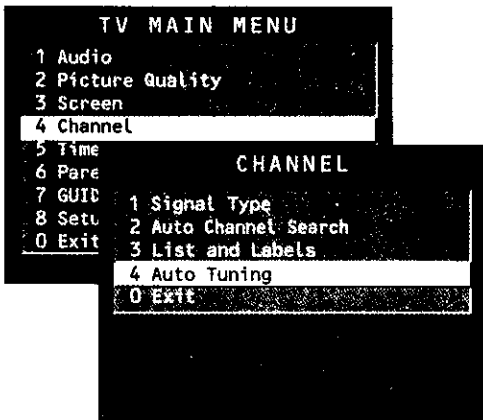

3. Highlight *Auto Tuning* and press OK.
4. Choose which channel you would like to set:

Set VCR 1 Channel Displays a list that lets you set up the channel that the TV tunes to when you press the VCR1 button on the remote.

Set VCR 2 Channel Displays a list that lets you set up the channel that the TV tunes to when you press the VCR2 button.

Set DVD Channel Displays a list that lets you select the channel that the TV tunes to when you press the DVD button.

Set SAT/CABLE Channel Displays a list that lets you set up the channel that the TV tunes to when you press SAT•CABLE.

5. Highlight the choice that matches the way you have the component connected to this TV, and press OK.

The choices and a brief explanation follow:

Not connected Choose this if you don't have this particular component connected to the TV, or if you don't want the TV to automatically tune to the correct channel when you're using this component.

Channel 2 (SAT/CABLE only) Component (satellite or cable box) is connected to the CABLE/ANTENNA jack on the back of the TV, and you want the TV to tune to channel 2 when you press the SAT•CABLE button on the remote. Reminder: make sure the component's Channel 2/3/4 switch is set to channel 2. Usually this switch is on the back of the component.

Channel 3 Component is connected to the CABLE/ANTENNA jack on the back of the TV, and you want the TV to tune to channel 3 when you press the corresponding button on the remote. Reminder: make sure the component's Channel 3/4 switch is set to channel 3.

Channel 4 Component is connected to the CABLE/ANTENNA jack on the back of the TV, and you want the TV to tune to channel 4 when you press the corresponding button on the remote. Reminder: make sure the component's Channel 3/4 switch is set to channel 4.

Video Input Component is connected to the VIDEO jack on the back of the TV and you want the TV to tune to VID (SVID if you used an S-Video cable) Input Channel when you press the component button.

Note: You should choose this for your VCR if you connected it to the TV with audio/video cables.

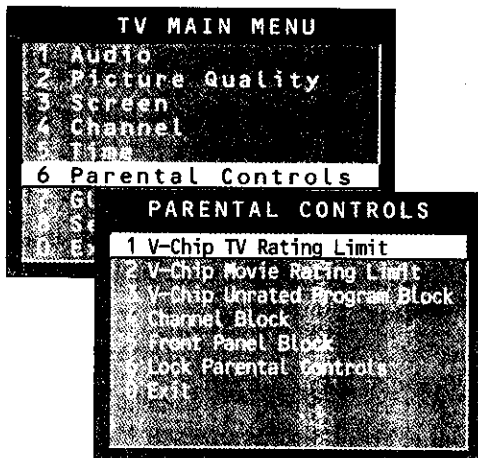

Parental Controls and V-Chip

The *Parental Controls* menu allows you to program your TV so that children cannot see certain programs, channels, or use the front panel controls. The first three choices in the *Parental Controls* menu involve software inside your TV (referred to as V-Chip) which allows you to block TV programs and movies based on violence, sex, or other content you may believe children should not view. In other words, it lets you program your TV so it won't display certain programs.

Once you block programs, you or other adults can unblock programs by entering a password.

By default, the software inside your TV is turned "off," so if you don't want to use this feature, you can just ignore it.

How V-Chip Works

When turned "on," the V-Chip software reads a code that most broadcasters send with programs. That code tells the software the program's age-based rating (TV-MA, TV-14, etc.) and content themes [(Violence (V), Adult Language (L), etc.)]. If you have blocked the rating and/or content themes that the program contains, you will receive the message, "This channel is not approved for viewing," when you tune to that particular channel.

Broadcasters are not required to provide content themes, so programs received with no content themes will only be blocked if you block their age-based rating. You can also block out programs that have been given a rating of "Not Rated," and programs that are considered "unrated" because no code has been sent by the broadcaster. The TV age-based ratings and content themes you can block are listed in the following table.

Age-Based Rating	Description and Content Themes for Age-Based Ratings
TV-MA	Mature Audience Only. Specifically designed to be viewed by adults and may be unsuitable for children under 17. It contains one or more of the following content themes: crude indecent language (L), explicit sexual activity (S), or graphic violence (V).
TV-14	Parents Strongly Cautioned. Contains some material that many parents would find unsuitable for children under 14. Parents are strongly urged to exercise greater care in monitoring this program and are cautioned against letting children under the age of 14 watch unattended. This program contains one or more of the following content themes: intensely suggestive dialogue (D), strong coarse language (L), intense sexual situations (S), or intense violence (V).
TV-PG	Parental Guidance Suggested. Contains material that parents may find unsuitable for younger children. Many parents may want to watch it with their younger children. The program contains one or more of the following content themes: some suggestive dialogue (D), infrequent coarse language (L), some sexual situations (S), or moderate violence (V).
TV-G	General Audience. Most parents would find this program suitable for all ages. It contains little or no sexual dialogue (D) or situations (S), no strong language (L), and little or no violence (V).
TV-Y7	Directed to Children 7 years and older. Designed for children ages 7 and above. It may be more appropriate for children who have acquired the developmental skills needed to distinguish between make-believe and reality. Themes and elements in this program may include mild fantasy violence (FV) or comedic violence, or may frighten children under the age of 7.
TV-Y	All Children. Themes and elements in this program are designed for a young audience, including children from ages 2-6. It is not expected to frighten younger children.

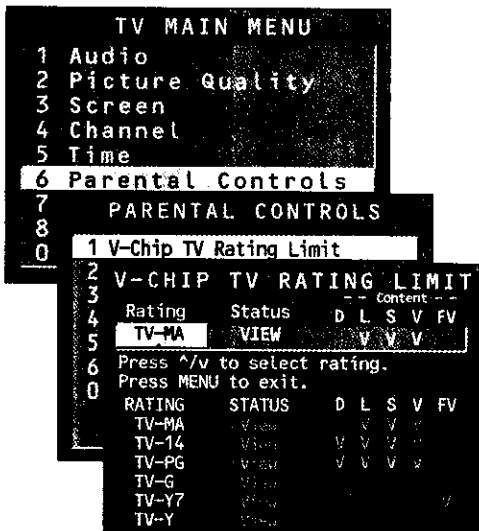

V-Chip TV Rating Limit

The *V-Chip TV Rating Limit* lets you decide which TV programs can and cannot be viewed.

To set TV programming limits:

1. Choose *Parental Controls* from the Main menu. If *Parental Controls* have previously been locked, you must enter your password. If they are not locked, you will get a message reminding you that your limits will not be effective until you lock *Parental Controls*.
2. Press MENU to continue.
3. Highlight and select *V-Chip TV Rating Limit*.
4. Once you get to the *V-Chip TV Rating Limit* screen, use the arrow buttons and OK on your remote to change the status of a TV program rating or content theme from *View* to *Block*.

The following sections give you more details about how to change the status of TV program limits.

Using the TV's Features

The V-Chip Rating Limit Screen

The following is an example of where items are located within the Rating Limit screen.

Rating Status Field

Lets you select whether the status of the age-based rating limit to the left is View or Block.

Content Themes

Lists the content themes you can block or view.

Rating Field

Lets you select from a list of age-based ratings you can block or view.

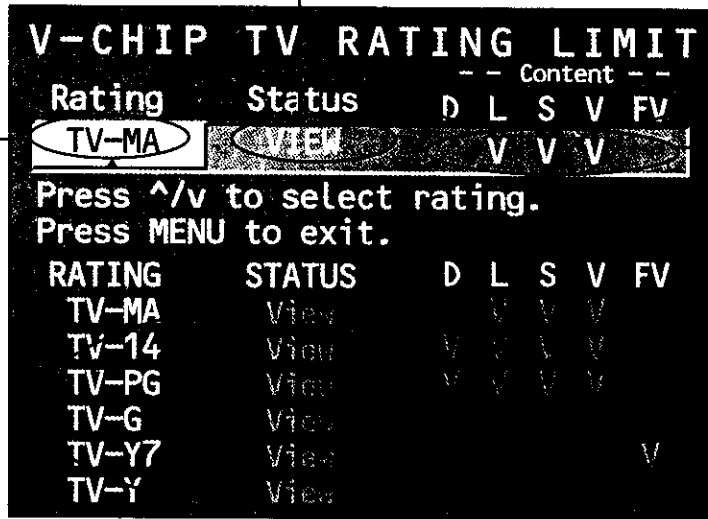

Content Status Fields

Lets you select which content themes to view for the selected rating, and whether the status of the content theme is currently View (V) or Block (B).

Rating Settings Area

Lets you see the current block/view state of age-based ratings and associated content. The View (V) settings are coded in green, and the Block (B) settings are coded in red.

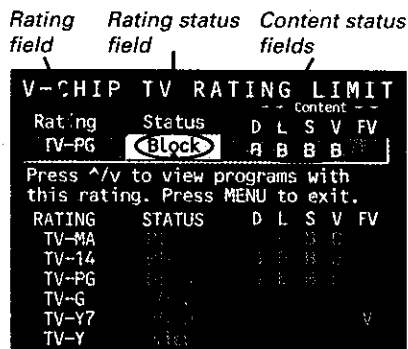

Blocking Age-Based Ratings

You can automatically block all program ratings above a specified age-based rating level. For example, if you only want your child to watch programs that have a TV-G rating and lower (in other words, you want the child to watch TV-G, TV-Y7, and TV-Y), then you need to block out other programming with higher ratings.

To block programs with higher ratings:

1. First, determine the lowest level rating you don't want the child to watch (see chart of age-based ratings on next page).

Tip

When you change the status of a rating to Block, the system will automatically block higher ratings and all corresponding content themes.

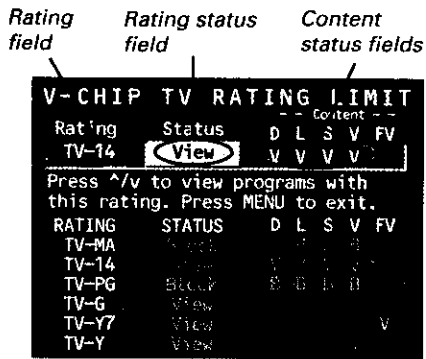

2. Press the left and right arrow buttons to highlight the *Rating* field.
3. Press the up and down arrow buttons on the remote to scroll through the age-based rating limits. Keep scrolling until the rating corresponding with the lowest rating you do not want the child to watch appears on the screen.

In the example discussed above, you would scroll through the *Rating* field until TV-PG appears, since the highest rating you want the child to watch is TV-G.

4. Press the right arrow button to move the yellow highlight to the *Status* field.
5. Press the up or down arrow button to toggle between *View* and *Block*. The status for the rating listed to the left and all higher ratings automatically changes to *Block* (and *B*).
6. Press OK on the remote to return to the menu or exit the screen when you are finished.
7. Select *Lock Parental Controls* from the *Parental Controls* menu. Enter a password, and if you have not already set your password, you will be prompted to enter it again to confirm.

Hierarchy of Age-Based Ratings	
TV-MA	Mature Audience Only
TV-14	Parents Strongly Cautioned
TV-PG	Parental Guidance Suggested
TV-G	General Audience
TV-Y7	Directed to Children 7 years and older
TV-Y	All Children

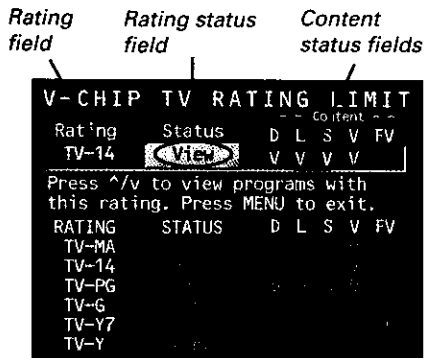

Viewing Age-Based Ratings

After you block age-based ratings, you have the option of changing some of the ratings back to *View*.

1. Determine which blocked rating you want to view.
2. Use the up and down arrow buttons to select the rating with a status of *Block*.
3. Press the right arrow button to move the yellow highlight to the rating status field.
4. Press the up button to select *View*.

Note: The content status fields corresponding to the unblocked rating become *View* as well. They and the age-based rating status are the only fields that automatically change back to *View* when you complete this process.

Note: You must remember to lock Parental Controls for rating limits to take effect.

Using the TV's Features

Content Themes	
D	Sexually explicit dialogue
L	Adult language
S	Sexual situations
V	Violence
FV	Fantasy Violence
TV-Y	All Children

Blocking Specific Content Themes

You can block programs based on their content. (Content is represented by the D, L, S, V, FV and TV-Y on your screen. See the beginning of this section for details.) When you block a content theme for a particular rating, you automatically block that content theme for higher rated programs as well.

For example, if you do not want your child to watch programs that have adult language (L) rated TV-PG or higher, then you could block out all programming TV-PG and above containing adult language.

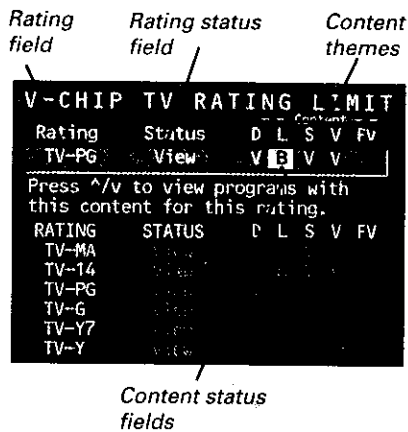

To block program content:

1. Determine the lowest level of content you don't want the child to watch.
2. Use the up and down arrow buttons on the remote to scroll through the age-based ratings until the rating that corresponds with the lowest content you do not want the child to watch appears. (In the example above, you would scroll through the ratings until the TV-PG rating appeared.)
3. Press the right arrow button to move the highlight to the field corresponding with the content theme you wish to block out.
4. Press the up or down arrow button to change content status from V to B. All higher ratings' content theme will automatically change to B.
5. Press OK to return to the menu or exit the screen.

Note: Broadcasters are not required to provide content themes or age-based ratings. Programs received with no content themes will only be blocked if you block their age-based rating.

Note: You must remember to lock Parental Controls for rating limits to take effect.

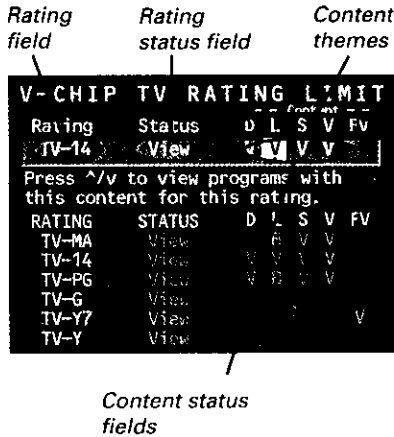

Viewing Specific Content Themes

If you block specific content themes, you have the option of going back and changing some of the content themes back to (V) View.

1. Determine the content themes you want to change to (V) View.
2. Use the up and down arrow buttons to scroll through the age-based ratings until the rating whose content theme you want to change to View appears.
3. Press the right arrow button to move the yellow highlight to a particular content theme status, such as the B under language (L) corresponding with TV-14.
4. Press the up or down arrow button to change its status back to V. Your child would then be able to watch programs with TV-14 adult language content, but not programs with TV-PG or TV-MA language content.

Note: Only the content theme status corresponding to TV-14 (L) language changes to (V) View. Higher rated content themes, such as that for TV-MA language, do not change.

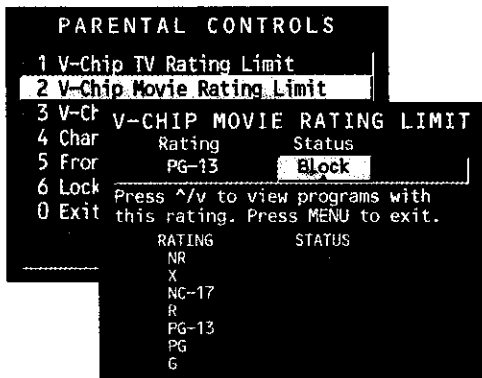

V-Chip Movie Rating Limit

You set movie rating limits by blocking movies rated above a specified level. How to block movie ratings and view movie ratings is explained in the next two sections.

To access the *V-CHIP MOVIE RATING LIMIT* menu:

1. Press MENU on the remote control (the TV MAIN MENU appears).
2. Select Parental Controls (press 6).
3. Select V-Chip Movie Rating Limit (press 2).

Using the TV's Features

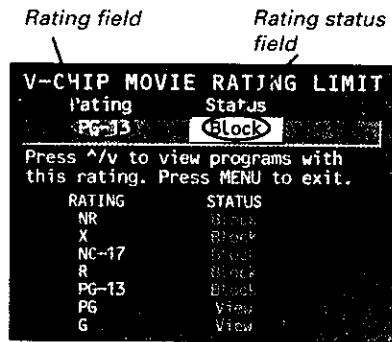

Blocking Movie Ratings

If you only want your child to watch movies that have a PG rating and lower (in other words, movies rated PG and G), then you could automatically block out all other movies with higher ratings.

To block movies:

1. Highlight the *Rating* field and press the up and down arrow buttons to find the rating that is the lowest rating you don't want the child to watch. (In the example above, you would highlight the rating status button corresponding to PG-13, since the highest rating you want the child to watch is PG.)
2. Press the right arrow button to highlight the rating *Status* field. Press the up and down arrow buttons to change the button from *View* to *Block*. All higher ratings automatically change to *Block*.
3. Press OK to return to the menu or exit the screen.
4. If Parental Controls are not locked, you must lock them so the movie rating limits will take effect.

Note: Some movies may be given a Not Rated (NR) rating. After blocking movie ratings, you must set NR to View separately to view NR movies.

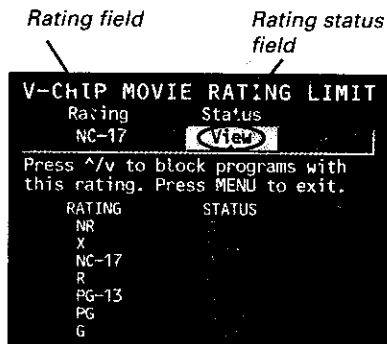

Viewing Movie Ratings

After you block movie ratings, you have the option of changing some of the rating status buttons back to *View*.

1. Highlight the *Rating* field and press the up and down arrow buttons to find the rating you want to view.
2. Press the right arrow button to highlight the rating *Status* field. Press the up and down arrows to change the button from *Block* to *View*.

For example, if movies with a rating of PG-13 and higher are blocked, you can change the rating status corresponding with NC-17. Your child would then be able to watch all movies with a G, PG, and NC-17 Rating.

3. Press OK to exit the screen, and be sure parental controls are locked.

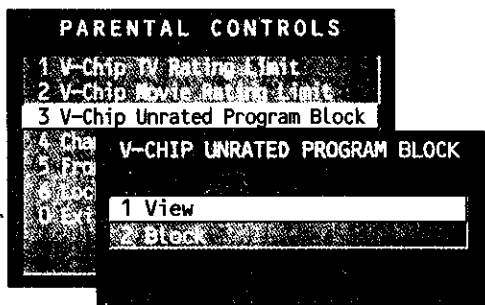

V-Chip Unrated Program Block

Selecting this option lets you decide if programs that the V-Chip recognizes as “unrated” can be viewed. Note that “unrated” TV programs may include news, sports, political, religious, local and weather programs, emergency bulletins, public announcements, and programs without ratings.

View All unrated programs are available.

Block All unrated programs are not available.

Note: You must remember to lock Parental Controls for rating limits to take effect.

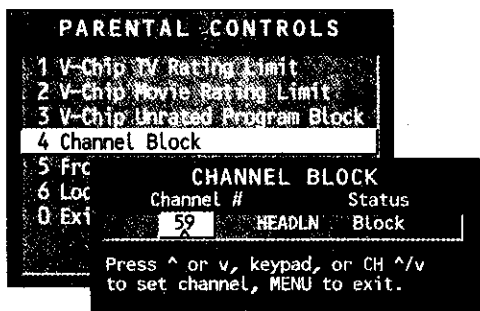

Channel Block

Selecting this option lets you decide what channels can be viewed.

View Makes the selected channel viewable.

Block The front panel and remote control CH (channel) buttons will tune only to channels that you have marked as *View*. The remote will still tune to the blocked channel if you use the digits to access the channel, but the channel will be blocked.

Don't forget to lock parental controls after you change the status of *Channel Block*. If you do not, the channel block will not take effect.

Note: If you have a digital cable box channels 126-999 can be blocked but will not be removable from your scan list.

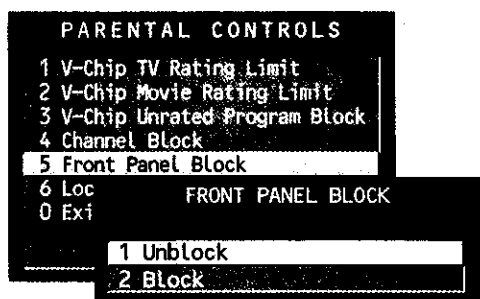

Front Panel Block

Selecting this option lets you block (disable) or unblock (enable) the TV's front panel. The remote still tunes to any channel. *Front Panel Block* can:

- Keep children from watching TV when the parent is not present.
- Keep young children from playing with the buttons.

(When using this as a Parental Control method, you should remove access to any remote that is capable of operating the television while you have the front panel blocked.)

Don't forget to lock parental controls after you change the status. If you do not, the front panel block will not take effect.

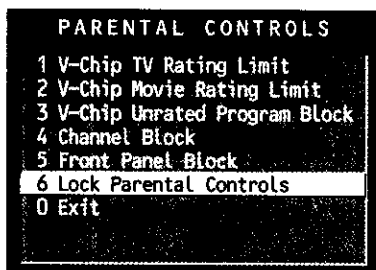

Lock/Unlock Parental Controls

Selecting this option lets you lock and unlock parental controls settings using a password.

If you do not lock parental controls, none of the settings for V-Chip, Channel Block, or Front Panel Block will take effect.

If you forget your password, simultaneously press and hold MENU on the television and volume down on the remote for 3 seconds. Nothing appears on the screen, Parental Controls simply unlock and you can re-enter a password via *Lock Parental Controls*.

Using the TV's Menu System

Chapter Overview:

- **How to Use the Different Types of Menus**
- **Audio Menu**
- **Picture Quality Menu**
- **Screen Menu**
- **Channel Menu**
- **Time Menu**



Using the TV's Menu System

How to Use Your TV's Menu System

You use the buttons on the remote or the front of your TV to access the menu system and make changes to the settings.

The following pages explain how to use the different types of menus to adjust the features of your TV.

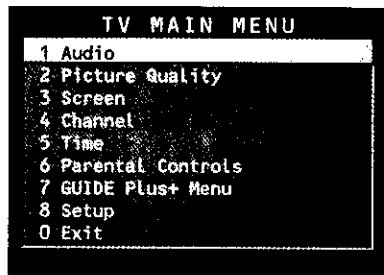

Tip

Feel free to explore the menu system. If you're ever unsure where you are in the menu system, or you're just plain tired of exploring, press CLEAR to remove the menus from the screen and start over again.

Menus

The first menu is called the Main menu. Press MENU on the remote or on the front panel to bring up the Main menu. Note that holding MENU for 2 seconds displays the GUIDE Plus+ system.

Menus take you to another menu or a control panel. There are two ways to select a choice in a menu:

- Use your arrow buttons on your remote control to highlight your choice, and press OK.
- Press a number button on the remote. For example, in the Main menu press 3 to go straight to the *Screen* menu.

Exiting a menu

There are three ways to exit a menu:

- Highlight *Exit* and press OK.
- Press 0 on the remote.
- Press CLEAR. The on-screen displays are cleared from the screen and you return to TV viewing.

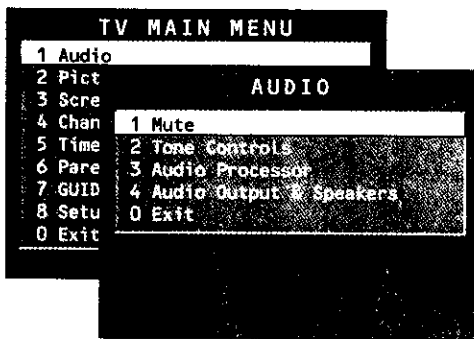

Audio Menu

Mute Press OK to reduce the TV's volume to its minimum level. Press OK again to restore the volume.

Tone Controls Displays the slider controls for adjusting the TV's treble, bass and balance.

Audio Processor Displays a choice list of available audio modes, which control the way the sound comes through your speakers. You can also access the *AUDIO PROCESSOR* menu by pressing the SOUND button on the remote.

Mono Plays the sound in mono only. Use this setting when receiving broadcasts with weak stereo signals.

Stereo Splits the incoming stereo audio signal into left and right channels. Most TV programs and recorded materials have stereo audio. The word *STEREO* appears on the TV when you tune to a program that is broadcast in stereo.

Expanded Stereo Electronically "widens" sound from stereo broadcasts, stereo VCRs, digital satellite systems, DVD players, and LaserDisc players for a fuller, more spacious sound.

Sound Logic™ Stereo Reduces the annoying blasts in volume during commercial breaks, and also amplifies softer sounds in program material. Eliminates the need to constantly adjust volume control.

Second Audio Program (SAP) Plays the program's audio in a second language, if one is available. The word *SAP* appears on the TV when you tune to a program that is broadcast with SAP information. SAP audio is broadcast in mono. SAP is also used to broadcast a program's audio with descriptions of the video for the visually impaired.

Audio Output & Speakers Displays a choice list that lets you turn the TV's internal speakers on or off, and set the audio outputs to fixed-level or variable control level.

Variable Output, Speakers On This setting turns the TV's speakers on and allows variable output from the TV's audio output jacks.

Variable Output, Speakers Off This setting turns the TV's speakers off and allows variable output from the TV's audio output jacks.

Fixed Output, Speakers Off This setting turns the TV's speakers off and allows fixed output from the TV's audio output jacks to an external component such as a surround sound amplifier. With *Fixed Output On*, the TV's volume control, tone controls, and mute are disabled.

Using the TV's Menu System

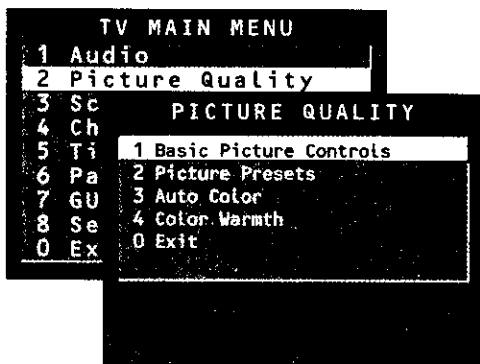

Picture Quality Menu

Basic Picture Controls Displays the five slider controls for adjusting the way the picture looks.

Contrast Adjusts the difference between the light and dark areas of the picture.

Color Adjusts the richness of the color.

Tint Adjusts the balance between the red and green levels.

Black Level Adjusts the brightness of the picture.

Sharpness Adjusts the crispness of the edges in the picture.

When exiting this menu, the *Save Personal Picture Preset* choice list will appear. You can choose either *Yes* or *No*. If you save the settings as a Personal Picture Preset, the TV will store the settings so you can re-select them quickly if someone changes the settings.

Picture Presets Displays a choice list that lets you select one of three preset picture settings: *Bright Lighting*, *Normal Lighting*, *Soft Lighting* or *Personal Picture Preset*. Choose the setting that is best for your viewing environment.

Auto Color Displays a choice list that lets you turn on the feature that automatically corrects the color of the picture. (This is especially useful for tracking realistic flesh tone colors as you switch from channel to channel.) Choose *On* or *Off*, depending on your preference.

Color Warmth Displays a choice list that lets you set one of three automatic color adjustments: *Cool* for a more blue palette of picture colors; *Normal*; and *Warm* for a more red palette of picture colors. The warm setting corresponds to the NTSC standard of 6500 K.

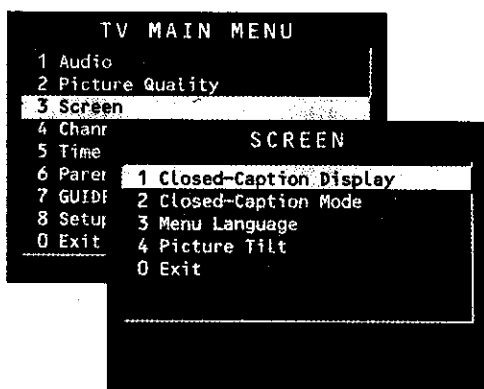

Screen Menu

Closed-Caption Display Displays a choice list that lets you choose the way closed captioning information is shown on the screen.

Off Always No captioning information is displayed.

On Always Captioning information is shown always, when available.

On When Sound is Muted Captioning information is shown, when available, whenever the TV's sound is muted. (To mute the sound, press the MUTE button.) The captioning information is not displayed when the sound is not muted.

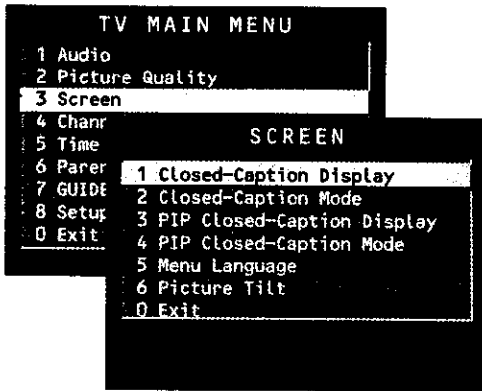

Closed-Caption Mode Displays a choice list that lets you choose which captioning mode is used for displaying captioning information.

Menu Language Displays a choice list that lets you select your preferred language for the menus: *English, Spanish* or *French*.

Picture Tilt (Direct View TV 31" or above) Your TV has an extra large picture tube that makes it vulnerable to the effects of the Earth's magnetic field. You may need to adjust the picture tilt.

Using Closed Captioning

Many programs are encoded with closed-captioning information, which lets you display the audio portion of a program as text on the TV screen.

Closed captioning is not available on all channels at all times. Only specific programs encoded with closed-captioning information are applicable. When a program is closed captioned, the letters *CC* are displayed in the channel banner. See Chapter 3 for more information about the channel banner.

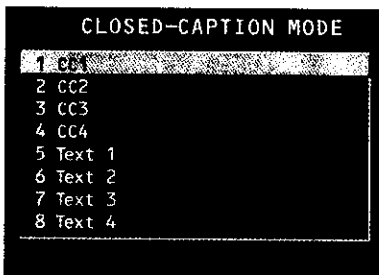

Tip

If you don't know which Closed-Caption mode to use, select CC1. CC1 is probably the mode that is used in your area. CC2, CC3, and CC4 are reserved for foreign languages, but are rarely used at this time.

Closed-Caption Modes

The TV offers eight closed-captioned modes, including four text modes.

To set the *Closed-Caption Mode*.

1. Select *Screen* from the Main menu.
2. Highlight *Closed-Caption Mode* and press OK (the *Closed-Caption Mode* appears).
3. Highlight your choice and press OK (the *Screen* menu appears again).

Note: The Text modes cover nearly half of the picture on the screen to display the closed-captioned text. Most broadcasters use the CC mode, which displays a few lines of captions at a time.

Turning off Closed-Caption

1. Select *Screen* from the Main menu.
2. Press OK to select *Closed-Caption Display*.
3. Highlight *Off Always* and press OK. The closed captioning is turned off and you go back to the *Screen* menu.

Using the TV's Menu System

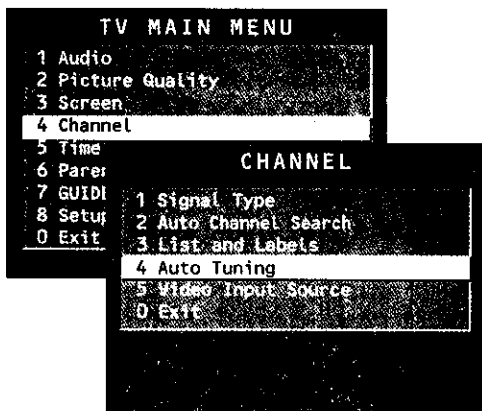

Tip

To enter a number greater than 99, press and hold "1" to enter the hundreds digit, then press the two remaining numbers.

Channel Menu

Signal Type Displays a choice list that lets you select the current antenna type. This option does not appear when the GUIDE Plus+ system is set up.

UHF/VHF Antenna Choose this if you are currently using an off-air antenna for TV signals.

Cable TV Choose this if you are currently using cable or a cable box for TV signals.

Auto Channel Search Tells the TV to search automatically for all the channels available through the antenna input. When the TV finds an active channel, it places it in the Normal channel list; inactive channels (weak stations or channels with no signal at all) will be removed from the channel list. If you are using a cable box and have set up the GUIDE Plus+ system, this option does not appear.

List and Labels Displays a control panel that lets you edit your Normal channel list and choose a six-character label for each channel. Follow the on-screen directions to enter your channels and other information.

Channel # Use the up and down arrows to scroll up and down through the channels available via your antenna. You can enter the channel number directly using the number buttons.

Normal List Only the channels included in the Normal list are available when you scan up and down using channel up and down. Use the up and down arrow buttons to indicate whether the channel number indicated is included (*Yes*) or is not included (*No*) in the Normal channel list.

Channel Label Use the up and down arrow buttons to enter a six-character label for each channel. Hold the button down to scroll quickly through the characters. The TV can store up to 27 labels in memory.

Auto Tuning Displays a choice list that lets you set up the TV to automatically tune to the correct input channel when you press a component button (VCR1, DVD, VCR2, or SAT•CABLE) on the remote. Go to Chapter 3 for details about the Auto Tuning feature.

Video Input Source Lets you select whether or not you have used the S-VIDEO jack to connect a component. If you're using the S-VIDEO, select *S-Video Input*. If you're not, select *Video Input*.

Time Menu

Sleep Timer Displays a control panel that lets you select the amount of time you want to give the TV before it shuts itself off.

Schedule Displays a control panel that lets you set up a schedule for turning the TV on and off automatically. Reminder: you must turn the schedule On. The on-screen directions guide you through the steps needed to set the schedule.

Set Time Displays a control panel that lets you enter the current time. The on-screen directions guide you through the steps needed to set the time. If your GUIDE Plus+ system is set up, it will automatically update your time and this option will not appear.

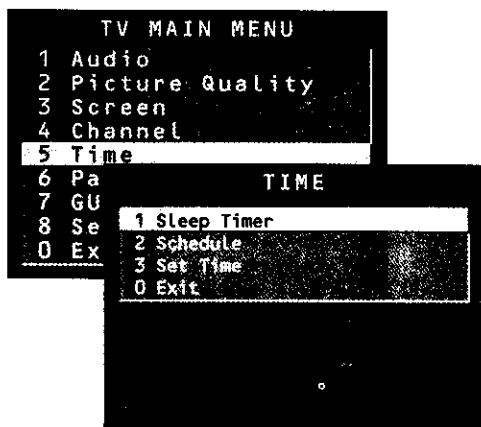

Other Information

Chapter Overview:

- Troubleshooting
- Care and Cleaning
- Front Panel Buttons
- Limited Warranty
- Accessory Order Form
- Index



Troubleshooting

Most problems you encounter with your TV you can correct by consulting the Troubleshooting list that follows.

TV Problems

TV won't turn on

- Press the TV button.
- Make sure the TV is plugged in.
- Check the wall receptacle (or extension cord) to make sure it is "live" by plugging in something else.
- Something might be wrong with your remote control. Press the POWER button on the front of the TV. If the TV turns on, check the remote control solutions on p. 56.
- The front panel controls may be locked (disabled). Use the remote control to unlock the front panel controls by selecting the *Front Panel Block* in the *Parental Controls* menu and choosing *View*.

Buttons don't work

- If you're using the remote control, press the TV button first to make sure the remote is in TV mode.
- The front panel controls may be locked (disabled). Use the remote control to unlock the front panel controls by selecting the *Front Panel Block* in the *Parental Controls* menu and choosing *View*.
- Unplug the TV for two minutes and then plug it back in. Turn the TV on and try again.

TV turns off while playing

- *Scheduled Off* function may have been activated. Go to p. 52 for instructions.
- Electronic protection circuit may have been activated because of a power surge. Wait 30 seconds and then turn the TV on again. If this happens frequently, the voltage in your house may be abnormally high or low.

TV turns on unexpectedly

- *Scheduled On* or *Watch* from the GUIDE Plus+ system may have been activated. Go to p. 32 for instructions.

Blank screen

- Make sure the component connected to the TV is turned on.
- Try another channel.

When I turn on the TV, an icon is moving across the screen

- Make sure you have removed the Demo Pin from the G-LINK jack on the back of your TV.

No sound, picture okay

- Maybe sound is muted. Press the volume up button to restore sound.
- Maybe speakers are turned off. Check the *Audio Output* and *Speakers* control panel in the *Audio* menu. Go to p. 49 for detailed instructions.
- If using S-VIDEO cables to connect a component, remember to also connect the component's left and right Audio Output Jacks to the TV's left and right INPUT Jacks (AUDIO R and L/MONO).

Troubleshooting

Can't select certain channel

- Channel may be blocked or not approved in the *Parental Controls* menu.
- If using a VCR, make sure the TV/VCR button on the VCR is in the correct mode (press the TV/VCR button on your VCR).

Noisy stereo reception

- The station might be weak. Press the SOUND button on your remote control to change from stereo to mono.

No picture, no sound but TV is on

- Maybe the cable/air setting is set to the wrong position. Select *GUIDE Plus+ Menu* from the Main menu, select the *Setup* option, and provide the correct information on the following screens. Go to pages 16-17 for detailed instructions.
- The channel might be empty — change channels.
- If you're watching your VCR and it's connected with coaxial cable to the CABLE/ANTENNA jack, tune the TV to channel 3 or 4 (whichever channel is selected on the 3/4 switch on the back of your VCR). Also check to make sure the TV/VCR button on the VCR is in the correct mode (press the TV/VCR button on your VCR).

Sound okay, picture poor

- Check antenna connections. Make sure all of the cables are firmly connected to the jacks.
- Try adjusting sharpness function to improve weak signals. Go to page 50 for more instructions.

Black box appears on the screen

- Closed-captioning might be on. Check the *Closed-Caption Display* control panel in the *Screen* menu. Go to page 50-51 for more instructions.

Every time I turn on the TV, the Guide is on the screen

- The GUIDE Plus+ system automatically appears on the screen when you use the remote control to turn it on. To turn off this feature, press GUIDE on your remote control (the guide appears), and then press MENU (the menu options bar is highlighted). Press the right arrow button to highlight *Setup*. Choose *Review* and select *Off*.

GUIDE Plus+ System Problems

GUIDE Plus+ setup won't switch to channel 9 for VCR and/or channel 02 cable box

- Make sure you have removed the Demo Pin from the G-LINK jack. Check to see if the G-LINK wands are positioned correctly in front of components' remote sensors.
- GUIDE Plus+ system control of cable box is slower than direct control of the box itself. Keep this in mind when changing channels.
- You may have an incorrect GUIDE Plus+ Channel Map. The guide may get out of sync with the cable provider. Use the *GUIDE Plus+ Setup* in the *GUIDE Plus+ Menu* to change the zip code to 99999. Turn the TV off for 10 minutes. Use Setup again to change the zip code back to the correct value. If asked, be sure to select the correct channel lineup from the on-screen list.

Other Information

GUIDE Plus+ System Problems (continued)

Program information doesn't download

- Review your set-up information and make sure it's correct. Press MENU on the remote and select *GUIDE Plus+ Setup*. Go to page 16 for detailed instructions about the GUIDE Plus+ Setup menus.
- The TV must be off to download information. Leave your TV off overnight, for at least 10 hours, to receive the initial download for your area.
- If you're using a cable box, leave it on so you can receive program information.

Scheduled Watch or Record doesn't occur

- Check Schedule for timer conflicts. Go to page 32 for instructions.
- Make sure the wands of the G-LINK cable are placed in front of the remote sensor(s) on the component(s).
- Make sure your VCR is turned off during the time you've scheduled to record a program because the system turns the VCR on when it starts recording (if it's already on when recording starts, the system will turn it off).
- Make sure there is a tape in the VCR and that the VCR is connected properly.
- Be sure that you set up the VCR in the *GUIDE Plus+ Setup* menus. If you don't complete the *Configuring for a VCR* steps successfully, the Record option won't be available. Go to p. 18 for detailed instructions.
- If a cable box is attached to your TV, make sure you set it up correctly in the *GUIDE Plus+ Setup* menus. Go to page 16-17 for detailed instructions.

The Remote Control Doesn't Work

- Something might be between the remote and the remote sensor on the component. Make sure there is a clear path.
- Maybe the remote isn't aimed directly at the component (TV or VCR) that you're trying to operate.
- Maybe remote is not in TV Mode. Press the TV button so remote will control TV.
- Maybe batteries in remote are weak, dead or installed incorrectly. Put new batteries in the remote. (Note, if you remove the batteries, you may have to reprogram the remote to operate other components.)
- You might need to drain the remote's microprocessor: remove batteries and press the number 1 button for at least 60 seconds. Release the 1 button, replace the batteries, and (if necessary) program the remote again.

Problems with V-Chip/Parental Controls

The rating limits don't work

- You must lock the settings. Go to the *TV MAIN MENU* (press MENU on your remote), select *Parental Controls* (press 6 on your remote), select *Lock Parental Controls* (press 6 on your remote).

I don't remember my password and I want to unlock the TV

- If you forget your password, simultaneously press and hold MENU on the television and volume down on the remote for 3 seconds. Nothing appears on the screen, Parental Controls simply unlock and you can re-enter a password via *Lock Parental Controls*.

The V-Chip won't let me watch a program even though it's not rated as violent.

- Maybe the movie was given an NR (Not Rated) status. After you block movie ratings, you must set NR to *View* separately in order to view movies with an NR rating.

Care and Cleaning

CAUTION: Turn OFF your TV before cleaning.

You can clean the TV as required, using a soft lint-free cloth. Be sure to occasionally dust the ventilation slots in the cabinet to help assure adequate ventilation.

The TV's screen may be cleaned with a soft, lint-free cloth as well. Take care not to scratch or mar the screen. If necessary, you may use a cloth dampened with warm water.

Never use strong cleaning agents, such as ammonia-based cleaners, or abrasive powder. These types of cleaners will damage the TV.

While cleaning do not spray liquid directly on the screen, or allow liquid to run down the screen and inside the TV. Also, avoid placing drinks or vases with water on top of the TV. This could increase the risk of fire or shock hazard or damage to the TV.

Caution: If fixed (non-moving) images are left on the screen for long periods, they may be permanently imprinted on the picture tube. Such images include network logos, phone numbers, and video games. This damage is not covered by your warranty. Extended viewing of channels displaying these images should be avoided.

Front Panel Buttons

If you can't find your remote control you can use the buttons on your TV to operate many of the TV's features.

MENU Brings up the TV MAIN MENU. When in the menu system, it selects highlighted items. Also returns you to the previous menu. Press MENU and CH+ simultaneously to access the GUIDE Plus+ system.

CH - Scans down through the current channel list. When you're using the TV's menu system, it acts like the arrow down button on the remote control.

CH + Scans up through the channel list. When you're using the TV's menu system, it acts like the arrow up button on the remote control. Press CH+ and MENU simultaneously to access the GUIDE Plus+ system.

VOL - Decreases the volume. When you're using the TV's menu system, it acts like the left arrow button on the remote control.

VOL + Increases the volume. When you're using the TV's menu system, it acts like the right arrow button on the remote control.

POWER Turns the TV on and off.

Other Information

GE TV Limited Warranty

What your warranty covers:

- Any defect in materials or workmanship.

For how long after your purchase:

- 90 days for labor charges.
- One year for parts.
- Two years for the picture tubes.

The warranty period for rental units begins with the first rental or 45 days from date of shipment to the rental firm, whichever comes first.

What we will do:

- Pay any Authorized GE Television Service Center the labor charges to repair your television.
- Pay any Authorized GE Television Service Center for the new or, at our option, refurbished replacement parts and picture tubes required to repair your television.

How you get service:

- For screen sizes of 26" and smaller: Take your GE television to any Authorized GE Television Service Center and pick up when repairs are complete.
- For screen sizes larger than 26": Request home or pick up, repair, and return service from any Authorized GE Television Service Center, provided that your television is located within the geographic territory covered by an Authorized GE Television Service Center. If not, you must take your television to the Service Center location at your own expense, or pay for the cost the Service Center may charge to transport your television to and from your home.
- To identify your nearest Authorized GE Television Service Center, ask your dealer, look in the Yellow Pages, or call 1-800-447-1700.
- Show the Authorized Service Center Representative your sales receipt or other evidence of purchase date or first rental.

What your warranty does not cover:

- Customer instruction. (Your Owner's Manual clearly describes how to install, adjust, and operate your television. Any additional information should be obtained from your dealer).
- Installation and related adjustments.
- Signal reception problems not caused by your television.
- Damage from misuse or neglect.
- Batteries.
- Customer replacement fuses.
- Images burned onto the screen.
- A television that has been modified or incorporated into other products or is used for institutional or other commercial purposes.
- A television purchased or serviced outside the U.S.A.
- Acts of God, such as but not limited to lightning damage.

Product registration:

- Please complete and mail the Product Registration Card packed with your TV. It will make it easier to contact you should it ever be necessary. The return of the card is not required for warranty coverage.

How state law relates to this warranty:

- This warranty gives you specific legal rights, and you also may have other rights that vary from state to state.

If you purchased your television outside the United States:

- This warranty does not apply. Contact your dealer for warranty information.

Service calls which do not involve defective materials or workmanship are not covered by this warranty. Costs of such service calls are the sole responsibility of the purchaser.



VH81 (3-ft)

VH82 (6-ft)

Screw-on Cable attaches to the round antenna connectors (called 75-ohm F-type) on the back of your VCR or TV. The ends screw onto the connectors for a secure connection.



VH89 (6-ft)

Push-on Cable attaches to the round antenna connectors (called 75-ohm F-type) on the back of your VCR or TV. Ends push on for a quick connection.

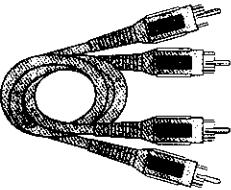

Gold-Tipped cable

VH83 (6-ft)

Monaural VCR Dubbing Cable Double cable that lets you connect the video and audio jacks of two VHS VCRs to duplicate tapes. Can also be used to connect a VCR to your TV. Cable is color-coded and shielded. Has RCA-type phono plugs on each end.

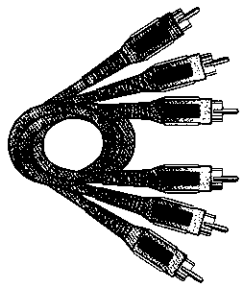

Gold-Tipped cable

VH84 (6-ft)

Stereo VCR Dubbing Cable Triple cable that lets you connect the VIDEO and AUDIO jacks of stereo components.



VH976 (6-ft)

VH913 (12-ft)

S-Video Cable has multi-pin connectors on each end for connecting S-Video components to your TV.

Accessory Order Form

Description	Part No.	Price	Qty
Screw-on antenna cable (3-ft)	VH81	\$3.95	
Screw-on antenna cable (6-ft)	VH82	\$5.95	
Push-on antenna cable (6-ft)	VH89	\$5.95	
Monaural VCR Dubbing Cable (6-ft)	VH83	\$5.95	
Stereo VCR Dubbing Cable (6-ft)	VH84	\$9.95	
S-Video Cable (6-ft)	VH976	\$7.95	
S-Video Cable (12-ft)	VH913	\$14.95	
2-way Signal Splitter	VH47	\$3.95	
Amplified Antenna	ANT200	\$49.95	
Antenna Mixer (not shown)	193984	\$11.15	
Remote Control (CRK76TG1)	242523	\$30.35	
Audio-Video Adapter (not shown)	228449	\$4.45	

Prices are subject to change without notice.

Total Merchandise \$ _____

Sales Tax \$ _____

We are required by law to collect the appropriate sales tax for each individual state, country, and locality to which the merchandise is being sent.

Shipping and Handling \$ 5.00

Total Amount Enclosed \$ _____

Use VISA, MasterCard, or Discover Card preferably.

Money order or check must be in U.S. currency only.

No COD or CASH.



All accessories are subject to availability. Where applicable, we will ship a superseding model.

Please complete other side also

Continued on next page.....

Other Information

Charge your order on your VISA, MasterCard, or Discover Card by filling in below

USE YOUR CREDIT CARD

IMPORTANT: Copy complete account number from your VISA card



My card expires:

IMPORTANT: Copy complete account number from your MasterCard



Copy Number above your name on MasterCard My card expires:

IMPORTANT: Copy complete account number from your Discover Card



My card expires:

AUTHORIZED SIGNATURE
 (Credit card order will not be processed without signature)

Print or type your name and address clearly.



A complete and correct order will save you days of waiting.

Name: _____

Street: _____

_____ Apt: _____

City: _____

State: _____ Zip: _____

Daytime phone number: _____

Please make sure that both sides of this form have been filled out completely.

- Allow 4 weeks for delivery.
- All accessories are subject to availability.
- Prices are subject to change.

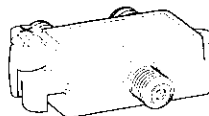

Splitter VH47

2-way Signal Splitter

Helps you connect a second TV or VCR.

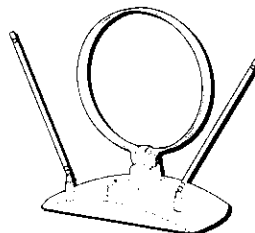

ANT200

Amplified Antenna

Allows you to quickly switch from the antenna signal to the cable or satellite signal without disconnecting the antenna.

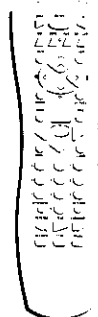

CRK76TG1

Remote Control

This is the remote control that came packed with your TV. Replacements or spares can be ordered as needed.

To Order

To place your order by phone, have your Visa, MasterCard or Discover Card ready and call the toll-free number listed below.

Use this number only to place an order for accessory items listed on this order form.

1-800-338-0376

To place your order by mail, detach and mail the completed order form with credit card information, money order or check in US currency (made payable to Thomson Consumer Electronics, Inc.) to the following address:

Video Accessories
PO Box 8419
Ronks, PA 17573



A

Age-Based Ratings, 39
ANTENNA button, 22
 Arrow buttons, 22
Audio
 Menu, 50
 Output Volume & Speakers, 49
 Processor, 49
AUDIO IN jacks, 11
AUDIO R jack, 12
 Audio/Video cable, 7
Auto
 Channel Search, 15, 52
 Color, 50
 Tuning, 52
 DVD Channel, 37
 SAT/Cable Channel, 37
 VCR1 Channel, 37
 VCR2 Channel, 37
 Auto tuning, 36
AUX (auxiliary) button, 22

B

Batteries for the remote, 14
Black Level, 50
Block
 Age-Based Ratings, 40
 Channel, 45
 Front Panel, 45
 Movie Ratings, 44
 Specific Content Themes, 42
 V-Chip Unrated Program, 45

Buttons

front of TV, 57
 remote control, 22

C

Cable Box, code list, 26
CABLE/ANTENNA jack,
 8, 9, 11, 12
Cables
 audio/video, 7
 coaxial, 7
 G-LINK, 7
 S-Video, 7
CC (Closed Captioning), 51
CH + button, 22, 57
CH - button, 22, 57
Channel
 Banner, 36
 Block, 45
 Labels, 52
 Lineup, 28
 Map, 28
 Menu, 52
 Search, 15
 Channel 2, 37
 Channel 3, 37
 Channels menu, 34
CLEAR button, 22
Closed Caption
 Display, 50
 Mode, 51
 Coaxial cable, 7

Code list

Cable Box, 26
 Satellite Receiver, 26
 VCR, 26
 Color Warmth, 50
Connections
 TV + VCR, 8
 TV+VCR+Satellite Receiver, 11
 Content Themes, 39
 Contrast, 50

D

Demo Pin, 6, 8, 9, 11
DVD button, 22
DVD Channel, 37

F

Finding the sensor, 13
Fixed
 Images, 57
 Output, speakers off, 49
FORWARD button, 22
Front Panel
 Block, 45

G

G-LINK
 cable, 7
 connecting, 13
GO BACK button, 22
 Grid Guide, 29, 30
GUIDE button, 22
GUIDE Plus+ system
 Channel Lineup, 28
 Channels, 35
 Downloading Information, 28
 Setup, 15
 Guide Plus+ system, 15, 20

I

INFO button, 22
INPUT 1, 37
 Interactive setup, 15

J

Jacks on the TV, 12

L

L.E.D. button, 22
L/MONO jack, 12
 Labels, 52
 Language, 51
 Languages, 15
 Locating remote sensor, 13
 Lock, Parental Controls, 46

M

Memory, 52
MENU button, 22, 57
Menus
 Audio, 49
 Channel, 52
GUIDE Plus+
 Channels, 34
 Grid, 29
 initial setup, 15
 Messages, 33
 News, 32
 Schedule, 32
 Sort, 31
GUIDE Plus+ Menu, 35
 Language, 51
 Parental Controls, 38
 Picture Quality, 50
 Screen, 50
 Setup, 15
 Time, 52
 Mono, 49
 Mute, 49
MUTE button, 22

N

News menu, 32
 Normal List, 52
 Number buttons, 22

O

OK button, 22
ON*OFF button, 22

P

Parental Controls
 Locking, Unlocking, 46
 menu, 38
PAUSE button, 23
Picture
 Presets, 50
 Quality Menu, 50
 Tilt, 51
PLAY button, 23
POWER button, 57
Program guide
 after setup, 20

R

R and L OUT jacks, 12
 R and L/MONO jacks, 12
Rating Limits
 movies, 43
 TV, 39
REC*VCR+ button, 23
 Remote, batteries, 14
 Remote sensor, 13
REVERSE button, 23

S

S-VIDEO
 cable, 7
 jack, 11, 12

SAP, 49
SAT*CABLE button, 23
SAT/Cable Channel, 37
Satellite Receiver
 code list, 26
 connecting, 11
 Schedule menu, 32
 Schedule time, 52
 Screen menu, 50
Second Audio Program (SAP), 49
Set
 DVD Channel, 37
 SAT/CABLE Channel, 37
 Time, 52
 VCR1 Channel, 37
 VCR2 Channel, 37
Setup
 GUIDE Plus+ system menus, 15
 menu, 34
 Sharpness, 50
 Signal Type, 52
SKIP button, 23
 Sleep Timer, 36, 52
 Sort menu, 31
SOUND button, 23
 Stereo, 49
STOP button, 23

T

Time
 Current, 36
 Menu, 52
 Tint, 50
 Tone Controls, 49
 Troubleshooting, 54
TV button, 23

U

UHF/VHF Antenna, 52
 Unlock, Parental Controls, 46

V

V-Chip, 38
 Age-Based Ratings, 38
 Blocking Movies, 43
 Content Themes, 38
Variable Output, Speakers On, Off,
 49
VCR
 1 Channel, 37
 2 Channel, 37
 code list, 26
 connecting, 8
VCR1 button, 23
VCR2 button, 23
VIDEO IN jack, 11, 12
VOL+ button, 23, 57
VOL- button, 23, 57

W

Warranty, 58
WHO*INPUT button, 23

LIBRARY: _____
 Received _____
 Copied _____
 Entered _____
 LIS _____ NRPDS _____
 Received **JUN 26 2000**
 Scanned _____
 Batch # _____

Please do not send any products to the Indianapolis address listed in this manual or on the carton. This will only add delays in service for your product.

THOMSON CONSUMER ELECTRONICS
 10330 North Meridian Street
 Indianapolis, IN 46290

©2000 Thomson Consumer Electronics, Inc.
 Trademark(s)® Registered
 Marca(s) Registrada(s)
 Printed in USA

TOCOM 1540730A MODEL #:
31GT740
1540730A

The following materials were used in printing this publication:



60%
RECYCLED PAPER
 MINIMUM 20% POST CONSUMER

