

Panasonic

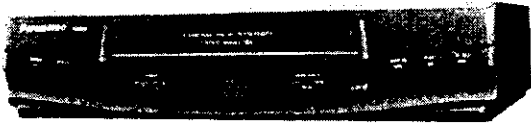

Omnivision **VHS**

Video Cassette Recorder Operating Instructions Model No. **PV-V4530S**



Basic Operation

Advanced Operation

For Your Information

Please read these instructions carefully before attempting to connect, operate or adjust this product. Please save this manual.

Spanish Quick Use Guide is included. (Guía para rápida consulta en español está incluida.)

Quick Use Guide is on the back cover.

As an **ENERGY STAR**® Partner, Matsushita Electric Corporation of America has determined that this product or product model meets the **ENERGY STAR**® guidelines for energy efficiency.



Important Safeguards and Precautions

FOR YOUR SAFETY, READ AND RETAIN ALL SAFETY AND OPERATING INSTRUCTIONS. HEED ALL WARNINGS IN THE MANUAL AND ON THE UNIT

INSTALLATION

1 POWER SOURCE CAUTION

Operate only from a power source indicated on the unit or in this manual. If necessary, have your Electric Utility Service Company or Video Products Dealer verify the power source in your home.

2 POLARIZED OR GROUNDING PLUG

As a safety feature, this Video product comes with either a polarized power cord plug (one blade is wider than the other) or a three-wire grounding type plug.

POLARIZED PLUG CAUTION

This plug will only fit into an outlet one way. If you cannot fully insert the plug, try reversing it. If it still will not fit, have an electrician install the proper wall outlet. Do not defeat the safety feature by tampering with the plug.

GROUNDING PLUG CAUTION

This plug will only fit into a three-hole grounding outlet. If necessary, have an electrician install the proper outlet. Do not defeat the safety feature by tampering with the plug.

3 POWER CORD

Make sure power cords are routed so that they are not likely to have anything rest on them, roll over them, or be in the way of walking traffic. If an extension cord is used, make sure it also has either a polarized or grounded plug and that the cords can be securely connected. Frayed cords, damaged plugs, and damaged or cracked wire insulation are hazardous and should be replaced by a qualified service technician. Overloaded outlets and extension cords are fire hazards and should be avoided.

4 DO NOT BLOCK VENTILATION HOLES

Ventilation openings in the cabinet release heat generated during operation. If they are blocked, heat build-up inside the unit can cause failures that may result in a fire hazard or heat damage to cassettes.

For protection, follow these rules:

- Never cover ventilation slots or the unit while in use, or operate the unit when placed on a bed, sofa, rug, or other soft surface.
- Avoid built-in installation, such as a book case or rack, unless proper ventilation is provided.

5 AVOID EXTREMELY HOT LOCATIONS OR SUDDEN TEMPERATURE CHANGES

Do not place the unit over or near any kind of heater or regulator, in direct sunlight, inside a closed vehicle, etc. Do not move the unit suddenly between areas of extreme temperature variation. If the unit is suddenly moved from a cold place to a warm place, moisture may condense in the unit and on the tape.

6 TO AVOID PERSONAL INJURY

- Do not place unsecured equipment on a sloping surface.
- Do not place this unit on any support that is not firm, level, and adequately strong. The unit could fall causing serious injury to a child or adult and damage to the unit.
- An appliance and cart combination should be moved with care. Quick stops, excessive force, and uneven surfaces may cause the appliance and cart combination to overturn.
- Carefully follow all operating instructions and use the manufacturer's recommended accessories when operating this unit or connecting it to any other equipment.



Safety Precautions

Warning: To prevent fire or shock hazard, do not expose this equipment to rain or moisture.

CAUTION: To prevent electric shock, match wide blade of plug to wide slot, fully insert.

Attention: Pour éviter les chocs électriques, introduire la lame la plus large de la fiche dans la borne correspondante de la prise et pousser jusqu'au fond.

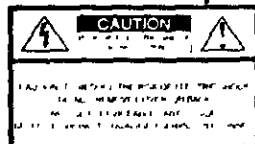

This symbol warns the user that uninsulated voltage within the unit may have sufficient magnitude to cause electric shock. Therefore, it is dangerous to make any kind of contact with any inside part of this unit.



This symbol alerts the user that important literature concerning the operation and maintenance of this unit has been included. Therefore, it should be read carefully in order to avoid any problems.

OUTDOOR ANTENNA INSTALLATION

1 SAFE ANTENNA AND CABLE CONNECTION

If an outside antenna or cable system is connected to the equipment, be sure the antenna or cable system is grounded so as to provide some protection against built up static charges and voltage surges. Section 810 of the National Electrical Code (ANSI/NFPA 70) (in Canada, part 1 of the Canadian Electrical Code) provides information with respect to proper grounding of the mast and supporting structure, grounding of the lead-in wire to an antenna discharge unit, size of grounding conductors, location of antenna discharge unit, connection to grounding electrodes and requirements for the grounding electrode.

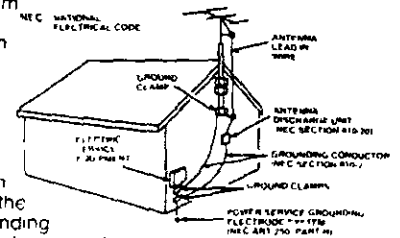

2 KEEP ANTENNA CLEAR OF HIGH VOLTAGE POWER LINES OR CIRCUITS

An outside antenna system should be located well away from power lines, electric light or power circuits and where it will never come into contact with these power sources if it should happen to fall. When installing an outside antenna, extreme care should be taken to avoid touching power lines, circuits or other power sources as this could be fatal. Because of the hazards involved, antenna installation should be left to a professional.

USING THE VIDEO UNIT

If the unit has been in storage or moved to a new location, refer first to the INSTALLATION section of these safeguards.

1 KEEP THIS VIDEO UNIT AWAY FROM WATER OR MOISTURE OF ANY KIND.

2 **IF EQUIPMENT IS EXPOSED TO RAIN, MOISTURE, OR STRONG IMPACT.** unplug the unit and have it inspected by a qualified service technician before use.

3 DURING AN ELECTRICAL STORM

During a lightning storm, whether indoors or outdoors, or before leaving the unit unused for extended periods of time, disconnect all equipment from the power source as well as the antenna and cable system.

4 WHEN THE UNIT IS PLUGGED IN

- Never expose the unit to rain or water. **DO NOT OPERATE** if liquid has been spilled into the unit. Immediately unplug the unit, and have it inspected by a service technician. Fire and shock hazards can result from electrical shorts caused by liquid contact inside.
- Never drop or push any object through openings in the unit. Some internal parts carry hazardous voltages and contact can cause electric shock or fire hazard.
- Avoid placing the unit directly above or below your TV set as this may cause electrical interference. Keep all magnets away from electronic equipment.

5 USING ACCESSORIES

Use only accessories recommended by the manufacturer to avoid risk of fire, shock, or other hazards.

6 CLEANING THE UNIT

Unplug the unit. Then, use a clean, dry, chemically untreated cloth to gently remove dust or debris. **DO NOT USE** cleaning fluids, aerosols, or forced air that could over-spray or seep into the unit and cause electrical shock. Any substance such as wax, adhesive tape, etc. may mar the cabinet surface. Exposure to greasy, humid, or dusty areas may adversely affect internal parts.

SERVICE

1 DO NOT SERVICE THIS PRODUCT YOURSELF

If, after carefully following the detailed operating instructions, this Video product does not operate properly, do not attempt to open or remove covers, or make any adjustments not described in the manual. Unplug the unit and contact a qualified service technician.

2 IF REPLACEMENT PARTS ARE REQUIRED

Make sure the service technician uses only parts specified by the manufacturer or those having the same safety characteristics as the original parts. The use of unauthorized substitutes may result in fire, electric shock, or other hazards.

3 HAVE THE SERVICE TECHNICIAN PERFORM A SAFETY CHECK

After any service or repairs to the unit, request the service technician to conduct a thorough safety check as described in the manufacturer's service literature to insure that the video unit is in safe operating condition.

Table of Contents

Use
Now!

Important Safeguards and Precautions	2
Accessories	4
Loading the Batteries	4
Basic Connections (Antenna, VCR, TV)	4, 5
One Time VCR Setup (Language, VCR's Output Channel, Channel, Clock) ..	6, 7
Playback a Tape (Still picture, Frame by Frame picture, Slow Motion)	8
Record On a Tape	9
• One Touch Recording	9

Basic Operation

Enjoy
more!

Advanced Connections (Cable/DSS)	10
Copying Your Tapes (Dubbing)	11
Timer Recording	12, 13
• Timer Recording	12
Using VCR Buttons	12
• Review, Replace or Clear Program Contents	13
Timer Recording Using VCR Plus+® System	14 ~ 17
• Choose your connection type ..	14
• Cable Box Setup	15
• VCR Plus+ System Channel Setup ..	16
• VCR Plus+ System Programming ..	17
Multi-Brand Control Feature	18, 19
Tape Operation (Search System)	20 ~ 23
• Program End Search	20
• Index Scan	21
• Auto Operation Functions	21
• Direct Access	22
• Repeat Play	23
• Zero Search	23
• Commercial Skip	23
MTS Broadcast/ VHS Hi-Fi Stereo System	24, 25
• Stereo/SAP/Mono Broadcast ..	24
• Select Audio Mode	25
Special VCR Features	26, 27
• Tape Position Display	26
• Remote Warning ON/OFF	26
• VCR Lock	26
• Weak Signal Display ON/OFF ..	27
• Auto Shut-Off	27
• Shuttle Variable Speed Search ..	27

Advanced Operation

Other
Information!

Reset Language, Channels, Clock, VCR's Output Channel ...	28, 29
VCR & Cassette Information	30, 31
• Reset All VCR Memory Functions ...	30
• DST (Daylight Saving Time)	30
• Prevent Accidental Tape Erasure ..	30
• Record/Playback Time	30
• Head Cleaning	31
• Cleaning the VCR	31
• Specifications	31
• Features for a Quality Picture ..	31
On Screen Displays (OSD)	32
• Function & Channel Display	32
• VCR Status & Clock Display ...	32
• Blank Tape/ No Video Signal Indication	32
• Warning and Instruction Displays ..	32
Before Requesting Service	33
Warranty	34, 35
Spanish (Español) Quick Use Guide	36, 37
Location of Controls	38, 39
Quick Use Guide (Playback, Recording)	Back Cover

For Your Information

Before Using

Congratulations

on your purchase of one of the most sophisticated and reliable products on the market today. Used properly, it will bring you and your family years of enjoyment. Please fill in the information below. The serial number is on the tag located on the back of your VCR.

- Date of Purchase _____
- Dealer Purchased From _____
- Dealer Address _____
- Dealer Phone No. _____
- Model No. _____
- Serial No. _____

Accessories

Remote Control
LSSQ0231

Batteries 2 "AA"

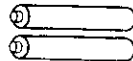

RF Coaxial Cable
VJAS0196

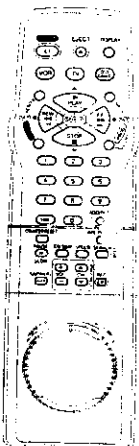

Loading the Batteries

- 1) Open the cover.
- 2) Insert the batteries as marked.
- 3) Close the cover.

Battery replacement caution

- Do not mix old and new batteries.
- Do not mix alkaline with manganese batteries.

Basic Connection

If your TV has AUDIO and VIDEO IN terminals, connect them to VCR for higher quality picture and sound. You can enjoy stereo sound even if your TV is not stereo by connecting a stereo amplifier to the VCR.

Connect VCR and TV with an AV Cable (not supplied) or a RF Coaxial Cable (supplied) as shown in the figure below.

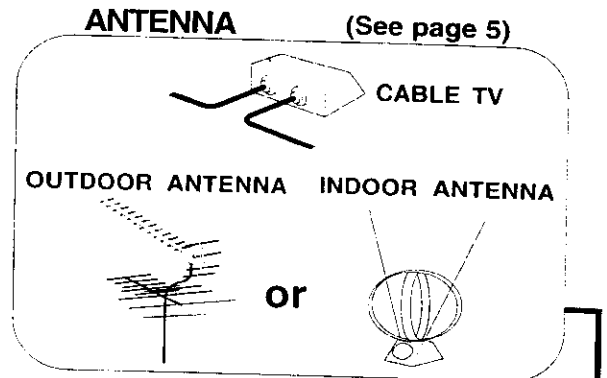

VCR

- 1) Disconnect antenna or cable from TV and connect to VCR.

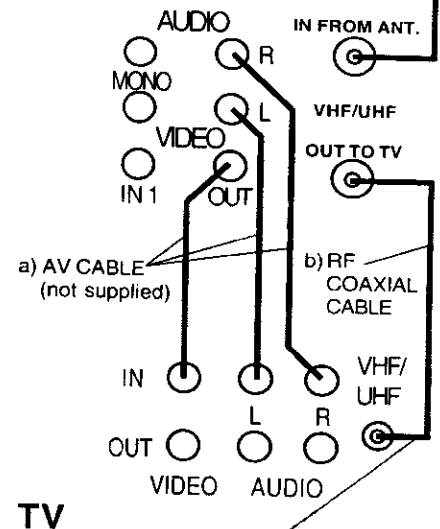

TV

- 2) Connect VCR to TV with RF Coaxial Cable.

Notes

- 1) While connection b) (above) is sufficient, connection a) offers better sound and picture (especially with this model, you can enjoy Hi-Fi STEREO sound).
- 2) For both connections a) and b) proceed as follows:
 - To use VCR : VCR Power on, set TV to VIDEO.
 - To watch TV : VCR Power off, select channel on.
- 3) Set VCR Output to channel 3 or 4 (not an active station). (See page 6.)
Use the L Audio OUT jack for proper sound reproduction when connecting to a monaural TV.

WARNING

When using "Nut type" RF coaxial cables, tighten with fingers only. Overtightening may damage terminals.

1 Between ANT. and VCR

■ Case 1: Twin Lead Cable Only

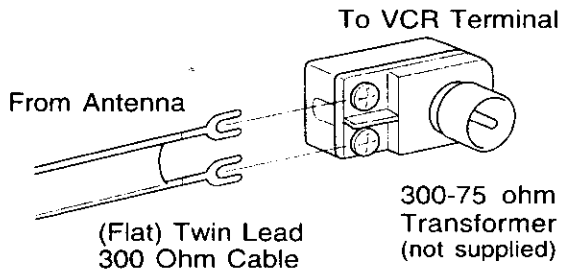

■ Case 2: Twin Lead & Coaxial Cables

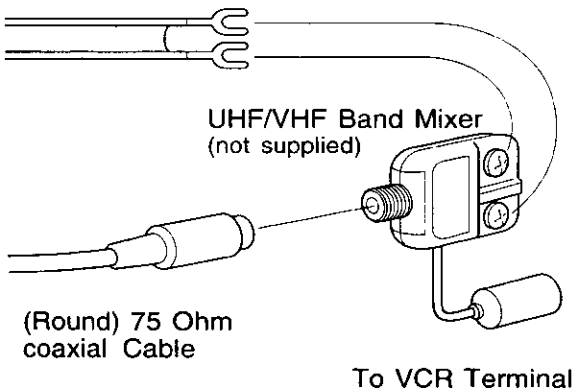

■ Case 3: Two Twin Lead Cables

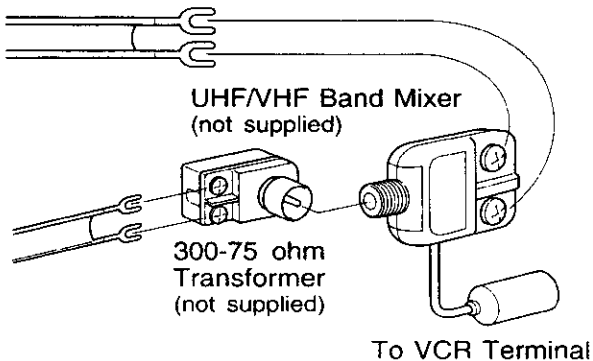

- If your TV has both post and plug-type VHF terminals, the post connection is recommended to minimize signal loss.

2 Between VCR and TV

■ Case 1: Screw & Plug Type Terminal

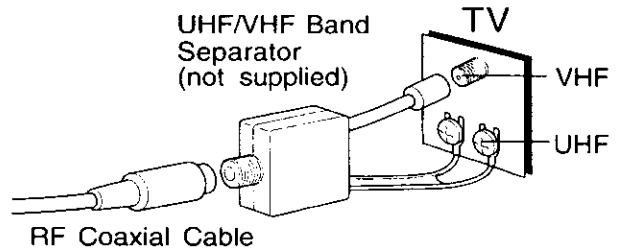

■ Case 2: Screw Type Terminal

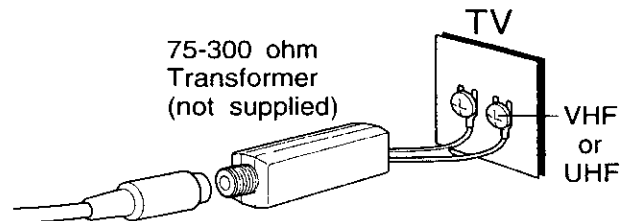

■ Case 3: Double Screw Type Terminal

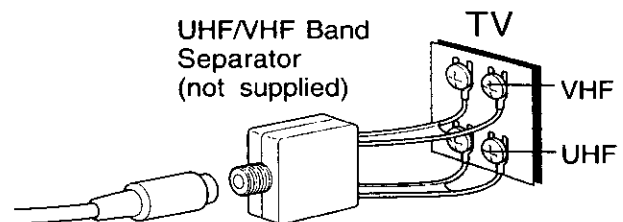

■ Case 4: Complex TV Terminal TERMINALS ON BACK OF TV SET

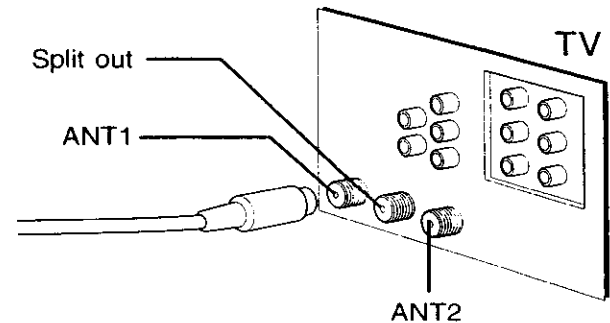

- Connect to one of the ANT terminals and select the same antenna number on the TV.

Note to CABLE system installer:
This reminder is provided to call the CABLE system installer's attention to Article 820-40 of the NEC in USA (and to the Canadian Electrical Code in Canada) that provides guidelines for proper grounding and, in particular, specifies that the cable ground shall be connected to the grounding system of the building, as close to the point of cable entry as practical.

FCC Warning: Any unauthorized changes or modifications to this equipment would void the user's authority to operate.

One Time VCR Setup

When VCR is turned on the first time, setup mode is entered automatically.

Process of Setup



1



Turn the TV and VCR on.

Press POWER*.

Set TV Channel to CH 3.

- If using AV Cable connection, set TV to Video instead of channel. (See connection a) on page 4.)

2

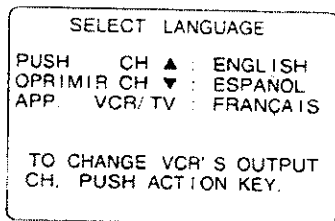

Press ACTION

IF YOU PUSH ACTION KEY, VCR'S OUTPUT CH SWITCHES TO CH 4.

Press ACTION

PLEASE TUNE YOUR TV TO CH 4.

After 3 seconds

Display SELECT LANGUAGE.

This display appears for first time setup only.

Select the language.

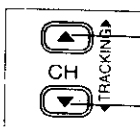

for English

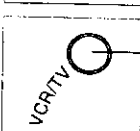

for Spanish (ESPAÑOL)

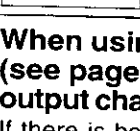

for French (FRANÇAIS)

When using connection b) (see page 4), tune TV to VCR's output channel.

If there is beat or noise on CH3, change VCR's output channel to CH4 by pressing ACTION twice.

- Always tune TV to this channel to monitor the VCR.
- If you used audio/video jack connection, tune the TV to its video input.
- If wrong language is set, do "Reset All VCR Memory" Functions" steps on page 30.

3

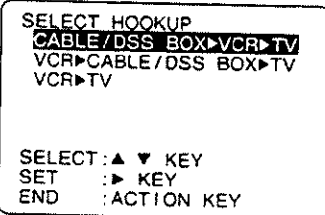

Select hookup.

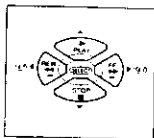

- 1) Press ▲▼ to select.
- 2) Press ► to set.

- If you selected "CABLE/ DSS BOX ► VCR ► TV," continue with step 4 and only the cable box output channel will be placed in memory. If not, go to step 6.

4

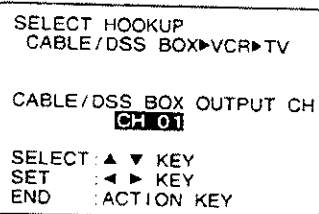

Select cable box or DSS receiver output channel.

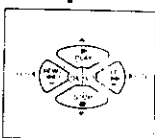

- 1) Press ▲▼ to select.
- 2) Press ► to enter.

- If necessary, refer to cable box manual.
- If you used Audio/ Video jack connection to cable box, set "VIDEO OUT".

5

Turn on cable box and set it to PBS channel in your time zone.

- If you use DSS receiver, it must be turned off.

6

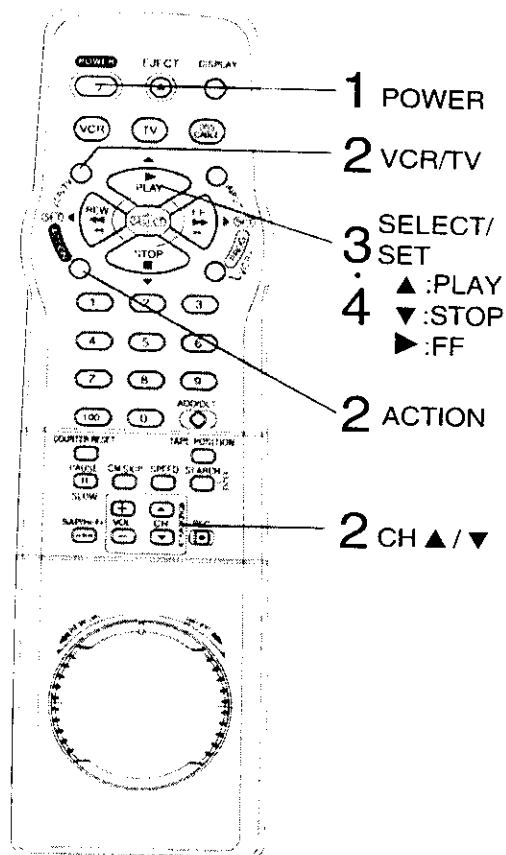

***Important:** If the remote control POWER, ACTION, PROG/VCR+, CH▲/▼, NUMBERED keys, INPUT, SEARCH or ADD/DLT button does not work when pressed, press the VCR button on the remote and try the button again.

6

CHANNEL/CLOCK AUTO SET

CONNECT ANTENNA CABLE AND IF YOU USE A CABLE BOX, TUNE IT TO YOUR LOCAL PBS CH THEN...

PLEASE PUSH CH UP KEY

Start Channel Auto Set and Clock Auto Set.

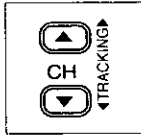

Press CH ▲.

CH AUTO SET PROCEEDING

AUTO CLOCK SET PROCEEDING

IMPORTANT NOTE FOR AUTO CLOCK SET

- Auto clock set is performed the first time the VCR is turned off each day. If used, a cable box must be left on and tuned to the PBS channel at the time VCR power is turned off if you want auto clock set to be done.
- If used, a DSS receiver must be turned off for auto clock set.
- If Cable Box or DSS receiver is connected to VCR via Audio/Video jacks, an RF coaxial cable must also be connected for auto clock set and channel auto set features to work.

Case 1 (Setup completed)

1/ 4/2000 TUE 12:00PM
DST: ON
SETTING : CH 02
AUTO CLOCK SET COMPLETED
END : PUSH CH UP KEY

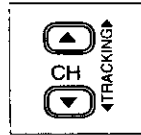

Press CH ▲ to exit.

- If your area observes DST (daylight saving time), but the time is incorrect; do the "Time Zone Adjust" steps on page 29.

Case 2 (Setup incomplete)

AUTO CLOCK SET IS INCOMPLETE
PUSH ACTION TO SET CLOCK

Clock Setup incomplete. Set the clock manually.



1) Press ACTION.

SET CLOCK
1/ 4/2000 TUE 12:00PM
DST: ON
SELECT MONTH
SELECT: ▲ ▼ KEY
SET : ► KEY
END : ACTION KEY

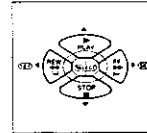

2) Press ▲▼ to select month.

3) Press ► to set.

- Likewise, set date, year, time, DST (Daylight Saving Time).

To Make Corrections, repeatedly press ◀▶ to move to error, then correct.

SET CLOCK
1/ 4/2000 TUE 12:00PM
DST: ON
SET COMPLETED
SET : ◀▶ KEY
START : ACTION KEY



4) Press ACTION. (Clock starts.)

- To exit this mode, press ACTION again.

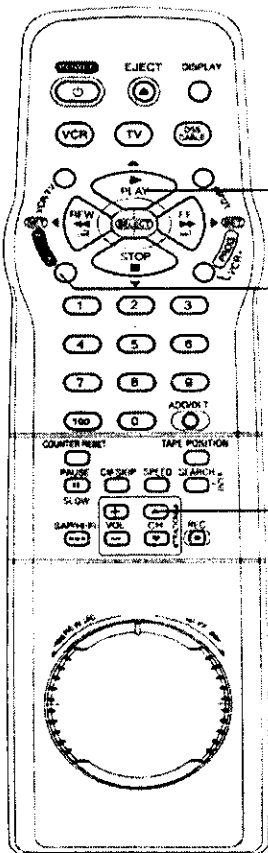

SELECT/SET
▲ :PLAY
▼ :STOP
◀ :REW
▶ :FF
ACTION

CH ▲

Notes

- VCR calendar is accurately maintained to Dec. 31, 2096 11:59PM.
- Channel auto set selects normal TV or Cable channels depending on your VCR hookup.
- To reset Language, Channels, Clock or VCR's Output Channel see pages 28 and 29.

Using ▲▼◀▶ keys

You can also operate the menu screen using VCR buttons.

When menu screens are displayed, the PLAY, STOP, REWIND, and FF buttons on the VCR and remote function as ▲▼◀▶ only with no tape inserted.

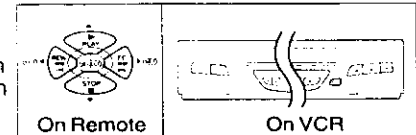

To display menu using VCR buttons, press CH ▲ and CH ▼ together.

▲ : PLAY ◀ : REW
▼ : STOP ▶ : FF

To exit the menu, repeat above.

Playback a Tape

Check list before you begin.

- All connections are made.
- TV and VCR are plugged in.
- TV is turned on and tuned to CH3, 4 or Video.
- Remote is in VCR mode.

1 Insert a cassette.

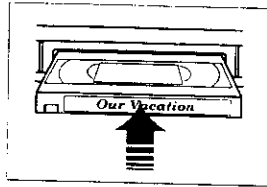

- VCR power comes on and "VCR" appears on Multi Function Display.

2 Press PLAY.



- Or, if cassette has no record tab (see page 30), auto playback begins.

■ **To Find a Particular Scene**

Forward Search --> Press FF. (To release, press PLAY or FF.)

Reverse Search --> Press REW. (To release, press PLAY or REW.)

■ **For Still (Freeze) picture --> Press PAUSE/SLOW.**
(To release, press PLAY.)

■ **For Frame by Frame picture --> Press PAUSE/SLOW in Still mode.**
(To release, press PLAY.)

■ **For Slow Motion --> Press and hold PAUSE/SLOW in Still mode.** (To release, press PLAY.)

Notes

- These features work best in SP or SLP mode.
- The sound will be muted.
- To reduce picture noise, see "Manual Tracking Control" on page 31.
- After the VCR is in Still or Slow mode for 3 minutes, it will switch to Stop mode automatically to protect the tape and the video head.

■ **To stop --> Press STOP.**

■ **To rewind tape --> Press REW in Stop mode.**

■ **To fast forward tape --> Press FF in Stop mode.**

■ **To eject tape --> Press EJECT on the remote or STOP/ EJECT on the VCR.**

Playback using VCR controls

1 Insert a cassette.

2 Press PLAY.

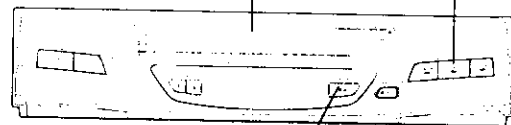

■ Press to stop and/ or eject tape.

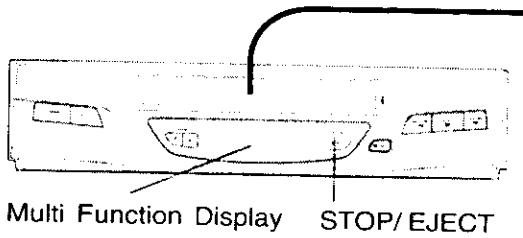

Multi Function Display STOP/EJECT

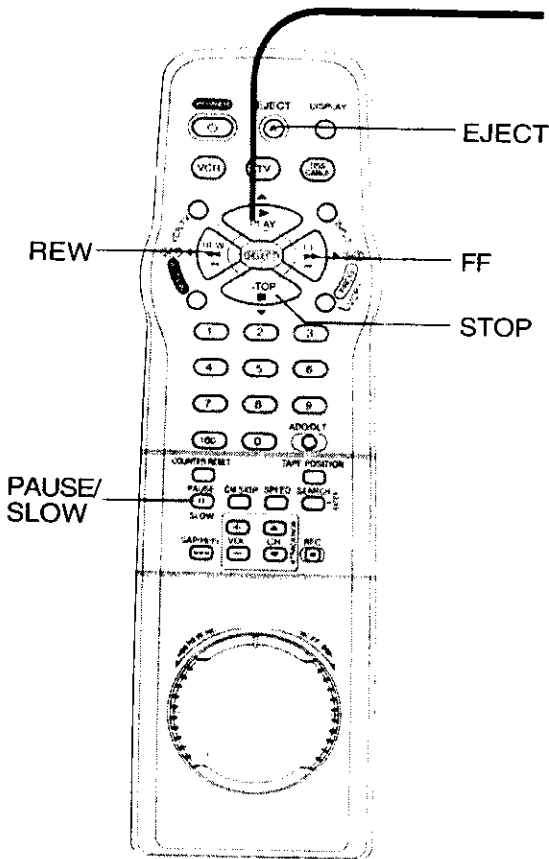

Note

● **To prevent tape jam**

Inspect your cassette tapes and remove any loose or peeling labels.

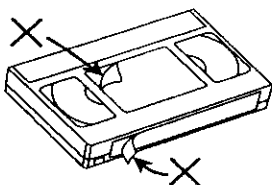

Record On a Tape

***Important:** If the remote control POWER, ACTION, PROG/VCR+, CH ▲/▼, NUMBERED keys, INPUT, SEARCH or ADD/DLT button does not work when pressed, press the VCR button on the remote and try the button again.

Check list before you begin.

- All connections are made.
- TV is turned on and tuned to CH3 or 4 or Video.
- Cassette record tab is in place.
- Remote in VCR mode.

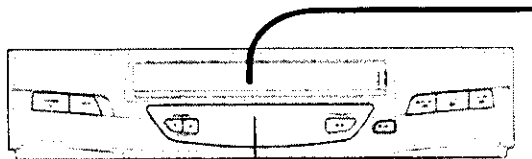

Multi Function Display

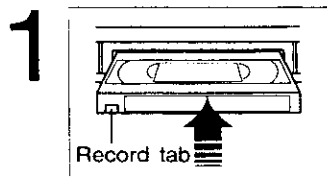

Insert a cassette.

- VCR power comes on and "VCR" appears on Multi Function Display.

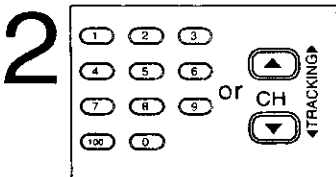

Select Channel.

Press CH ▲ / ▼* or NUMBERED keys.

- To select "LINE," see page 11.
- To select channels over 100, first press 100 key, then enter remaining two digits.

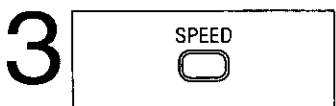

Select Recording speed.

(See page 30.)
Press SPEED.

- SP = Standard Play
- LP = Long Play
- SLP = Super Long Play
- Selected speed is displayed on TV screen and Multi Function Display.



Start Recording.

Press REC.

- To edit out unwanted portions, press PAUSE/SLOW to pause and to resume recording.

■ **To stop --> Press STOP.**

■ **One Touch Recording**

Press REC repeatedly to set the recording length (30 min. ~ 4 hours).

- The VCR turns itself off at the preset time.

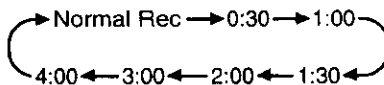

■ **Record One Program While Watching Another**

Press VCR/TV--> "VCR" disappears on Multi Function Display --> Select Channel at the TV.

■ **Selecting Channel at the VCR** (You cannot view another channel during recording.)

Press VCR/TV--> "VCR" appears on Multi Function Display --> Select Channel at the VCR (applies to connection b) only, see page 4).

Note

After the VCR has been in Pause mode for 5 minutes, it will stop automatically to protect the tape and the video head.

This video recorder, equipped with the HQ (High Quality) System, is compatible with existing VHS equipment. Only use those tapes with the **VHS** mark. It is recommended that only cassette tapes that have been tested and inspected for use in 2, 4, 6, and 8 hour VCR machines be used.

Record using VCR controls

- 2 Select Channel.
- 1 Insert a cassette.
- 4 Start Recording.

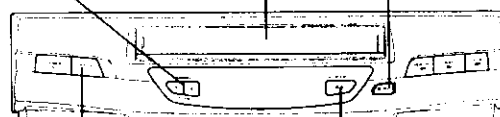

VCR/ TV

■ Press to stop.

Advanced Connections

Be sure to tune TV to VCR output channel. (The same one you set on screen of TV: CH3 or CH4.)

All connections on these pages are made with 75 Ohm coaxial cables.

CATV Connection

■ With a Cable Box (Cable Box → VCR)

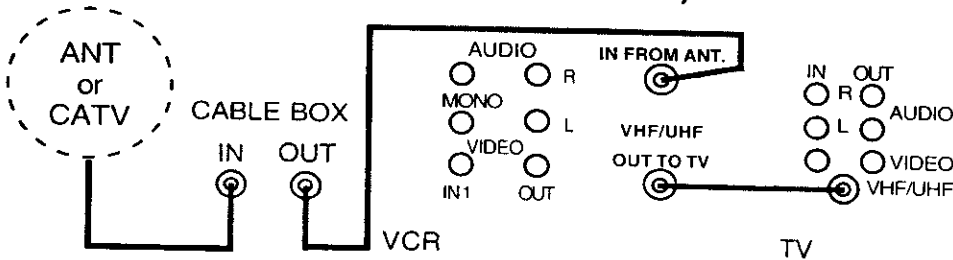

You Can

- record or view any (including scrambled) channel.
- use VCR Remote Control to select channels using Multi-brand control feature.

You Cannot

- view channel other than the one selected for any type of recording.
- do a Timer recording of a channel unless you select it at the cable box.

■ With a Cable Box (VCR → Cable Box)

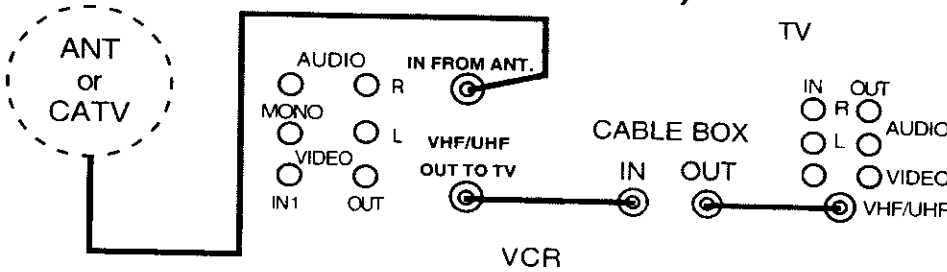

- view any (including scrambled) channel.
- use VCR Remote Control to select channels without using Multi-brand control feature.

- record scrambled channels.

■ With Two Cable Boxes

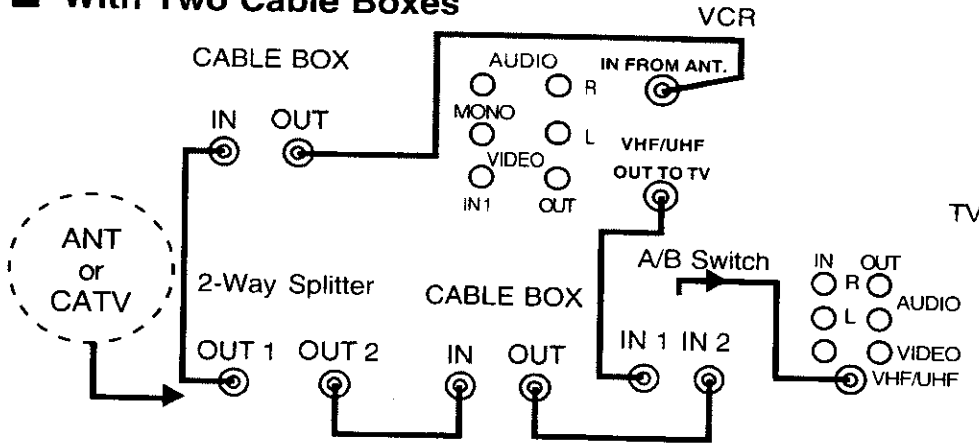

- record and view both scrambled and unscrambled channels if additional equipment is added. This connection requires: two converter boxes, an A/B switch, and a 2-way splitter.

- view channel other than the one selected for any type of recording.
- do a Timer recording of a channel unless you select it at the cable box.

DSS Connection

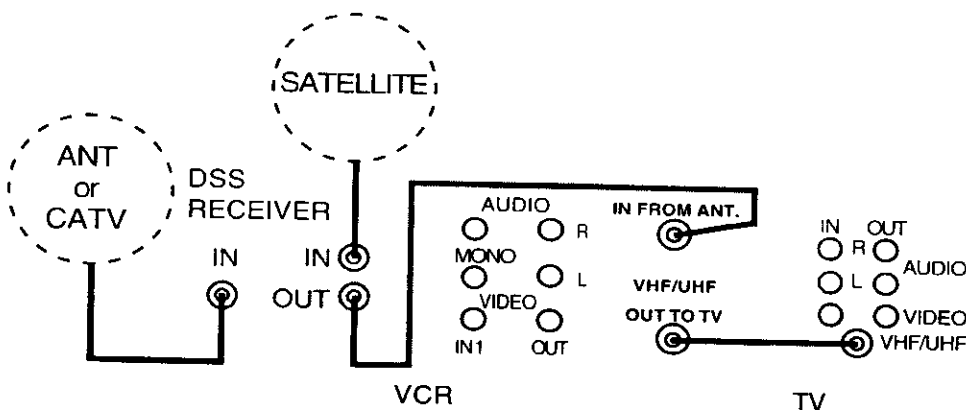

- record and view any (including scrambled) channel.

- use your VCR Remote Control to select channels using Multi-brand control feature.

- view channel other than the one selected for any type of recording.

- do a Timer recording of a channel unless you select it at the DSS box.

NOTE:
DSS receiver must be turned off to view cable box or antenna programs.

Copying Your Tapes (Dubbing)

Connections you'll need to make.

Playing (Source) VCR

Recording (Editing) VCR

TV for Monitoring

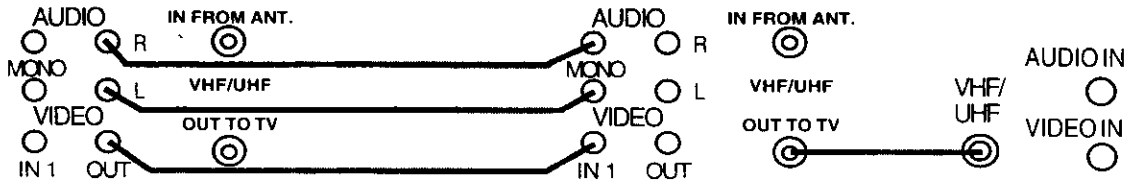

Playing (Source) VCR

Recording (Editing) VCR

1  **Insert pre-recorded tape.**

 **Insert blank tape with record tab.**

2  **Select LINE mode.** Press INPUT. (See "Selecting the Input Mode" below.)

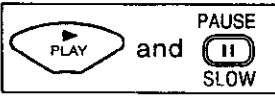
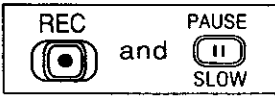
3  **Put in Standby mode.** Press PLAY, then PAUSE/SLOW at starting point.  **Put in Standby mode.** Press REC, then PAUSE/SLOW immediately.

4  **Start dubbing.** Press PLAY.  **Start dubbing.** Press PAUSE/SLOW.

5  **Stop dubbing.** Press STOP.  **Stop dubbing.** Press STOP.

■ To Monitor Dubbing on Your TV

■ Selecting the Input Mode

- 1 Turn your TV on and tune to the Recording VCR channel (CH3 or CH4).
- 2 Set the VCR/ TV Selector on the Recording VCR to "VCR."

- Method 1: Press INPUT.
Channel Number <--> LINE
- Method 2: Press CH ▲ / ▼.
Display will change as below.

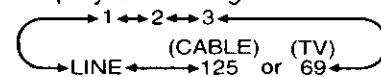

Note Dubbing tapes protected with Copy Guard will have poor quality results.

- "L" lights in Multi-Function Display (about 4 sec.) when LINE is selected.

Caution: Unauthorized exchanging and/or copying of copyrighted recordings may be copyright infringement.

Timer Recording

You can set up to 8 programs to be recorded while you are away.

1



Display SET PROGRAM.

Press PROG/VCR+.*

Or to display Program screen from the Menu.

- 1) Press ACTION to display Menu.
 - 2) Press ▲▼ and ► to select and set SET UP FEATURE.
 - 3) Press ► to display Program screen.
 - 4) Go to step 3.
- * You may also use VCR buttons. See the bottom right.



Check list before you begin.

- All connections are made. (See pages 4-5.)
- TV and VCR are plugged in and turned on.
- VCR/TV selector is set to "VCR."
- Clock is set to correct time.
- Record tab in place. (See page 30.)
- Remote in VCR mode.

2

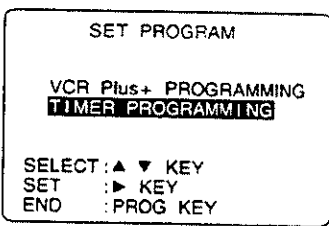

Display Program screen.

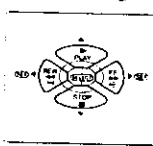

1) Press ▲▼ to select TIMER PROGRAMMING.

2) Press ► to display.

- If a program is already in memory, press ▲▼ and ► to select an unused program number.

- You cannot use the VCR buttons when on "SET PROGRAM" screen.

3

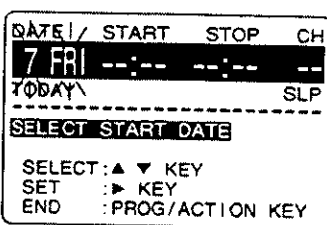

Set the recording DATE.

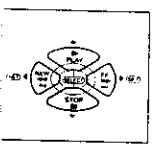

- 1) Press ▲▼ to select.
 - 2) Press ► or ◀ to set.
- 1-31 = One time
 - DAILY = MON-FRI
 - WEEKLY = Same time once a Week

Example
 Today — 7 — 8-9.....31 — 1-2.....6
 SELECT ▲/▼ Selection Order DAILY
 WEEKLY (SAT) WEEKLY (MON) WEEKLY (SUN)

Repeat step 3 to set: start time, stop time Channel (or LINE for outside source), tape speed (SP, LP, SLP).

4

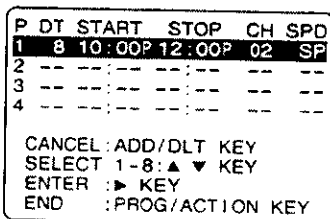

End the program.

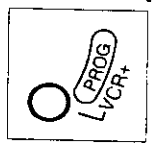

- 1) Press PROG/VCR+ (or ACTION).

To Enter More Programs

Press ▲▼ to select, and ► to display a blank program number. Then repeat step 3.

- 2) Press PROG/VCR+ (or ACTION) again to exit.

5



Multi Function Display

Set the timer.

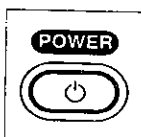

Press POWER off.

- When recording programs via a cable box, make sure the cable box is left ON and tuned to the desired channel.

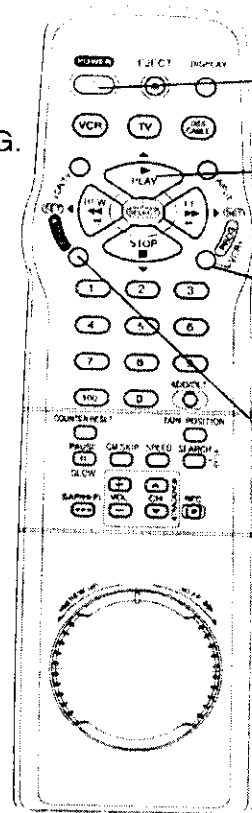

- 5 POWER
- SELECT/SET
- 1 ▲:PLAY
- 2 ▼:STOP
- 4 ◀:REW
- ▶:FF
- 1 PROG/VCR+
- 4
- 1 ACTION
- 4

Timer Recording Using VCR Buttons.

Using ▲▼◀▶ keys

You can also operate the menu screen using VCR buttons.

When menu screens are displayed, the PLAY, STOP, REWIND, and FF buttons on the VCR and remote function as ▲▼◀▶ only with no tape inserted.

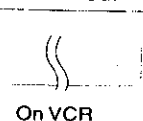
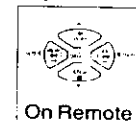

- ▲ : PLAY
- ▼ : STOP
- ◀ : REW
- ▶ : FF

To display menu using VCR buttons, press CH ▲ and CH ▼ together. To exit the menu, repeat above.

***Important:** If the remote control POWER, ACTION, PROG/VCR+, CH▲/▼, NUMBERED keys, INPUT, SEARCH or ADD/DLT button does not work when pressed, press the VCR button on the remote and try the button again.

Review, Replace or Clear Program Contents:

(Recording is not in progress)

1 Repeat steps 1~2 on page 12.

2

P	DT	START	STOP	CH	SPD
1	DAY	9:00A	12:00A	08	SP
2	8	10:00P	12:00P	02	SP
3	10	8:00P	9:00P	10	SP
4	SU	9:00P	10:00P	L	LP

CANCEL : ADD/DLT KEY
 SELECT 1-8 : ▲ ▼ KEY
 ENTER : ► KEY
 END : PROG/ACTION KEY

Select program.

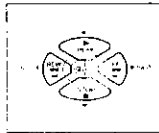

1) Press ▲▼ to select number.

3 To Replace program...

DATE	START	STOP	CH
8 SAT	10:00P	12:00P	125
TODAY			SP

SELECT START DATE

SELECT : ▲ ▼ KEY
 SET : ◀ ▶ KEY
 END : PROG/ACTION KEY

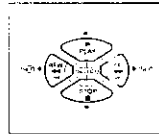

1) Press ► to display.
 2) Press ▲▼◀▶ to set new program contents.

or

To Clear program...

P	DT	START	STOP	CH	SPD
1					
2	8	10:00P	12:00P	02	SP
3	10	8:00P	9:00P	10	SP
4	SU	9:00P	10:00P	L	LP

SELECT 1-8 : ▲ ▼ KEY
 ENTER : ► KEY
 END : PROG/ACTION KEY

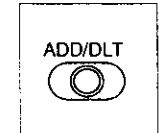

1) Press ADD/DLT to clear.

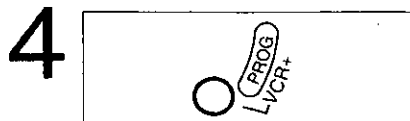

End the program.

- 1) Press PROG/VCR+ (or ACTION) .
- If there are programs, press POWER off.

Important notes when using a DSS receiver

- When recording programs via a DSS receiver, the DSS receiver must be left on.
- When recording programs via an antenna or cable, the DSS receiver must be turned off.

To cancel Timer Recording (Recording is in progress)

Press POWER and then STOP within 10 seconds to cancel the Timer recording. (The TIMER indicator goes out on Multi Function Display.)

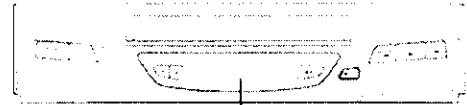

Multi Function Display

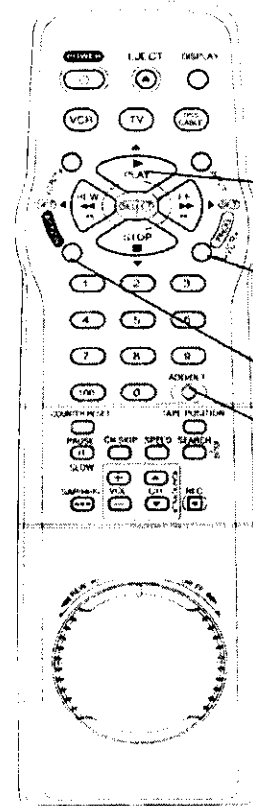

- SELECT/SET
- 2 ▲ :PLAY
 ▼ :STOP
 3 ◀ :REW
 ▶ :FF
- 4 PROG/VCR+
- 4 ACTION
- 3 ADD/DELETE

Timer Recording

Timer Recording Using VCR Plus+® System

VCR Plus+ System is ...

a feature that allows you to set most items of a timer recording by simply entering a special code number (PlusCode programming number) found in TV GUIDE and selected newspaper TV listings.

Process of Recording



Find the type of connection you use from the following diagrams and proceed to the page number indicated to begin set up.

■ Cable box → VCR → TV connection

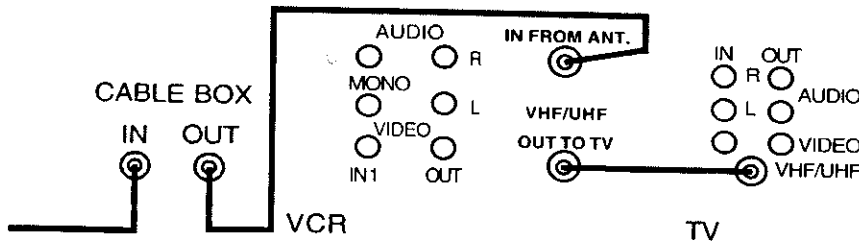

■ DSS box → VCR → TV connection

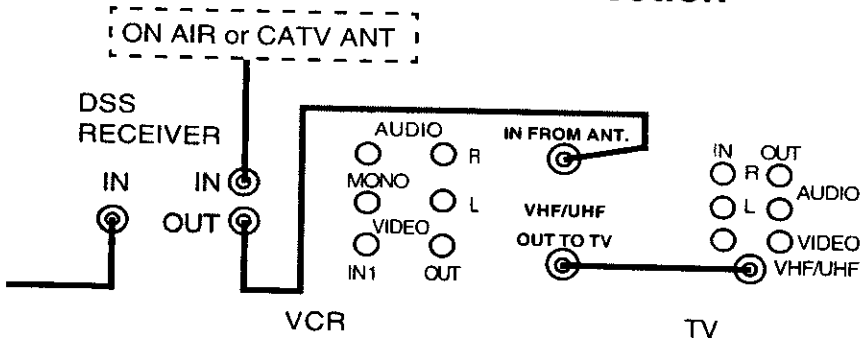

■ VCR → TV connection

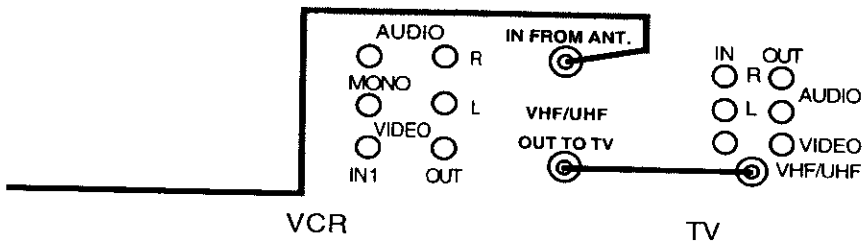

■ VCR → Cable box → TV connection

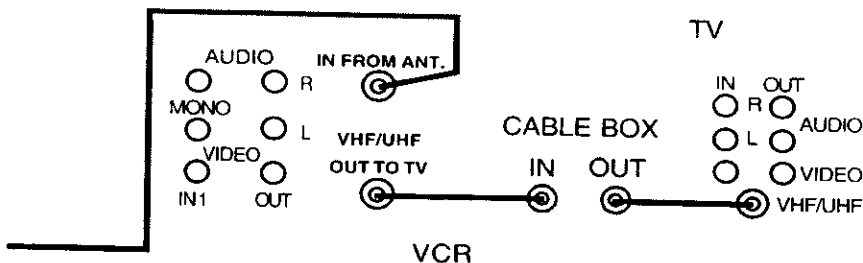

Setup on page

15

Programming on page

17

Setup on page

16

***Important:** If the remote control POWER, ACTION, PROG/VCR+, CH▲/▼, NUMBERED keys, INPUT, SEARCH or ADD/DLT button does not work when pressed, press the VCR button on the remote and try the button again.

Cable Box Setup

Process of Recording

Connection → **Setup** → Programming

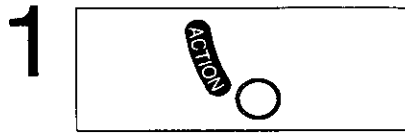

Display MENU.
Press ACTION.*

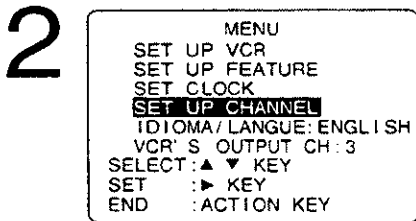

Select SET UP CHANNEL.

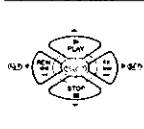

- 1) Press ▲▼ to select.
- 2) Press ► to display.

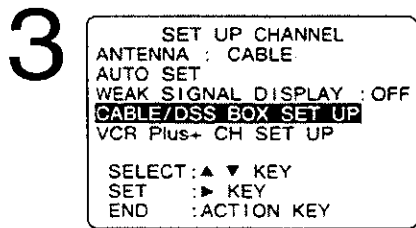

Select CABLE/DSS BOX SET UP.

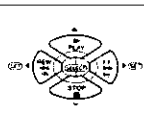

- 1) Press ▲▼ to select.
- 2) Press ► to display.

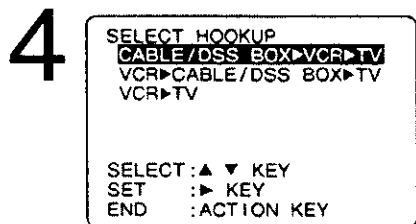

Select your hookup method.

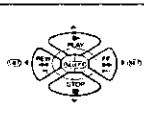

- 1) Press ▲▼ to select.
- 2) Press ► to set.

- If CABLE/DSS BOX ► VCR ► TV, go to step 5.
- If other, press ACTION three times and go to page 16.

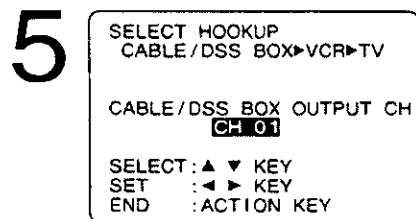

Select cable box or DSS receiver output channel.

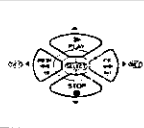

- 1) Press ▲▼ to select.
- 2) Press ► to enter.

- If necessary, refer to your Cable Box/DSS manual.
- If you are using Audio/Video jack connections, select and set "VIDEO OUT" as output channel.

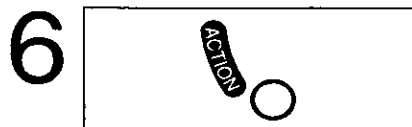

End setup.
Press ACTION twice.

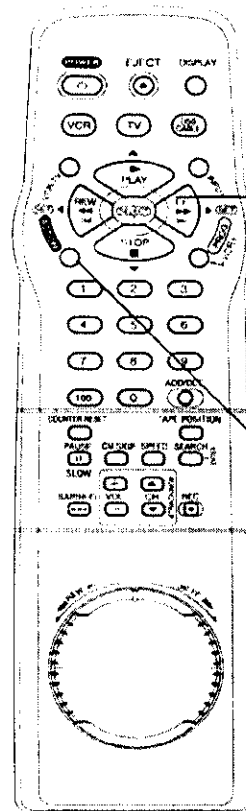

2 SELECT/SET
5 ▲:PLAY
▼:STOP
▶:FF

1 ACTION
6

Timer Recording Using VCR Plus+ System

VCR Plus+ and PlusCode are registered trademarks of Gemstar Development Corporation. The VCR Plus+ system is manufactured under license from Gemstar Development Corporation.

Timer Recording Using VCR Plus+® System (continued)

It is necessary to program the VCR with local channel information for proper VCR Plus+ System operation.

Process of Recording



VCR Plus+ System Channel Setup

• At first, do Channel Setup Preparations below right.

1  **Display MENU.**
Press ACTION.*

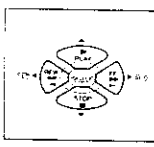
2  **Select SET UP CHANNEL.**

MENU
SET UP VCR
SET UP FEATURE
SET CLOCK
SET UP CHANNEL
IDTOMA/LANGUE: ENGLISH
VCR'S OUTPUT CH: 3
SELECT: ▲ ▼ KEY
SET : ► KEY
END : ACTION KEY

1) Press ▲▼ to select.
2) Press ► to display.

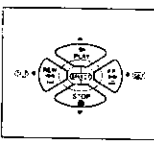
3  **Select VCR Plus+ CHANNEL SETUP.**

SET UP CHANNEL
ANTENNA : CABLE
AUTO SET
WEAK SIGNAL DISPLAY : OFF
CABLE/DSS BOX SET UP
VCR Plus+ CH SET UP
SELECT: ▲ ▼ KEY
SET : ► KEY
END : ACTION KEY

1) Press ▲▼ to select.
2) Press ► to display.

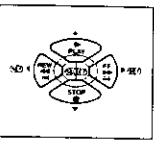
4  **Enter VCR Plus+ channels.**

VCR Plus+ CH SET UP
GUIDE CH CABLE CH
► 01 --
 02 --

SELECT: ▲ ▼ KEY
SET : ► KEY
END : ACTION KEY

1) Press ► to move cursor to right column.
2) Press ▲▼ to change CABLE CH number.
3) Press ◀ to set.
4) Press ▲▼ to scroll up/down GUIDE CH column.

VCR Plus+ CH SET UP
GUIDE CH CABLE CH
► 01 15
 02 --

SELECT: ▲ ▼ KEY
SET : ► KEY
END : ACTION KEY

• Repeat step 4 until list is complete.

To Make Corrections, press ▲▼ and ► to move to error, then ▲▼ to change, or ADD/DLT to erase number.

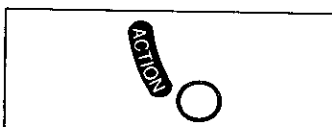
5  **End setup.**
Press ACTION three times.

Notes

- Make each entry within 5 minutes or the VCR will exit this mode.
- Once local channels have been programmed, they will stay in memory, even in the case of a power failure.

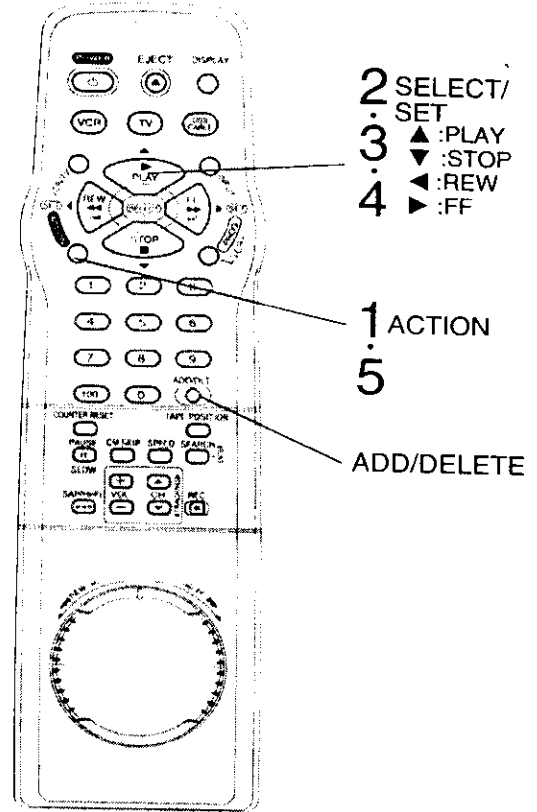

Channel Setup Preparations

In order to complete step 4 (at left), make a local channel list (see example below).

You will need the following:

- A line up of normal TV and/ or Cable stations and the channel number you receive them on.
- A list of Guide (VCR Plus+) channel numbers for the stations you receive found in TV Guide and selected newspapers.

- 1 Make a 3-column chart. In the left column, write the name of all the stations you receive.
- 2 In the middle column, write each station's Guide (VCR Plus+) number from TV Guide.
- 3 In the right column, write the channel number your TV receives the station on.

EXAMPLE ONLY

Broadcast or Cable Station Name	Assigned Guide (VCR Plus+) channel no.	Channel no. your TV receives the station on
HBO	33	15
Nickelodeon	38	20
CBS	04	04
FOX	11	

***Important:** If the remote control POWER, ACTION, PROG/VCR+, CH▲/▼, NUMBERED keys, INPUT, SEARCH or ADD/DLT button does not work when pressed, press the VCR button on the remote and try the button again.

Check list before you begin.

The clock is set.

VCR Plus+ System Setup is complete (see pages 14-16).

Process of Recording

Connection → Setup → **Programming**

VCR Plus+ System Programming

1  **Display SET PROGRAM.**
Press PROG/VCR+.*

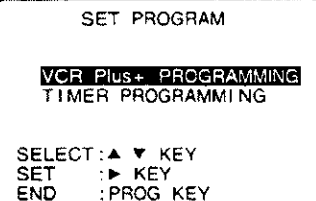
2  **Display VCR Plus+ screen.**

VCR Plus+ PROGRAMMING
TIMER PROGRAMMING

SELECT: ▲ ▼ KEY
SET : ► KEY
END : PROG KEY

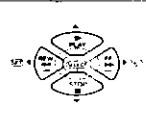
 1) Press ▲▼ to select.
2) Press ► to display.

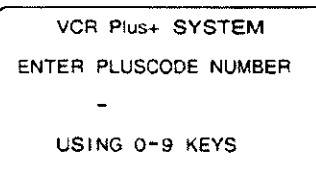
3  **Enter PlusCode programming number.**

VCR Plus+ SYSTEM
ENTER PLUSCODE NUMBER

USING 0-9 KEYS

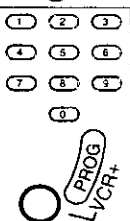
 1) Press Numbered keys.
2) Press PROG/VCR+ to lock in the program.

To Make Corrections, press ◀ repeatedly to delete the PlusCode programming number.

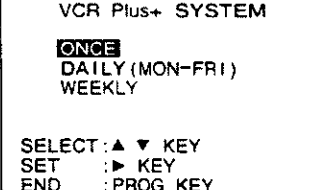
 **Enter record frequency.**

VCR Plus+ SYSTEM
ONCE
DAILY (MON-FRI)
WEEKLY

SELECT: ▲ ▼ KEY
SET : ► KEY
END : PROG KEY

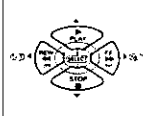
 1) Press ▲▼ to select.
2) Press ► to set.

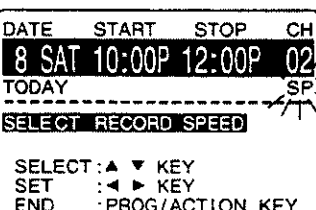
4  **Select record speed.**

DATE START STOP CH
8 SAT 10:00P 12:00P 02
TODAY SP

SELECT RECORD SPEED

SELECT: ▲ ▼ KEY
SET : ◀ ► KEY
END : PROG/ACTION KEY

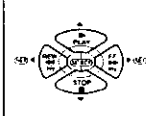
 1) Press ▲▼ to change.
2) Press ► to set.

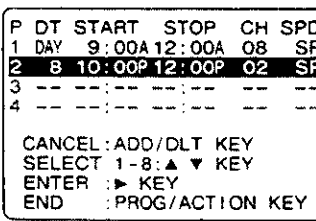
5  **End programming.**

P	DT	START	STOP	CH	SPD
1	DAY	9:00A	12:00A	08	SP
2	8	10:00P	12:00P	02	SP
3	-	-	-	-	-
4	-	-	-	-	-

CANCEL : ADD/DLT KEY
SELECT 1-8: ▲ ▼ KEY
ENTER : ► KEY
END : PROG/ACTION KEY

 1) Press PROG/VCR+ (or ACTION).
To cancel press ADD/DLT.
2) Press PROG/VCR+ (or ACTION) again to exit.

6  **Set timer.**
Press POWER off.



Multi Function Display

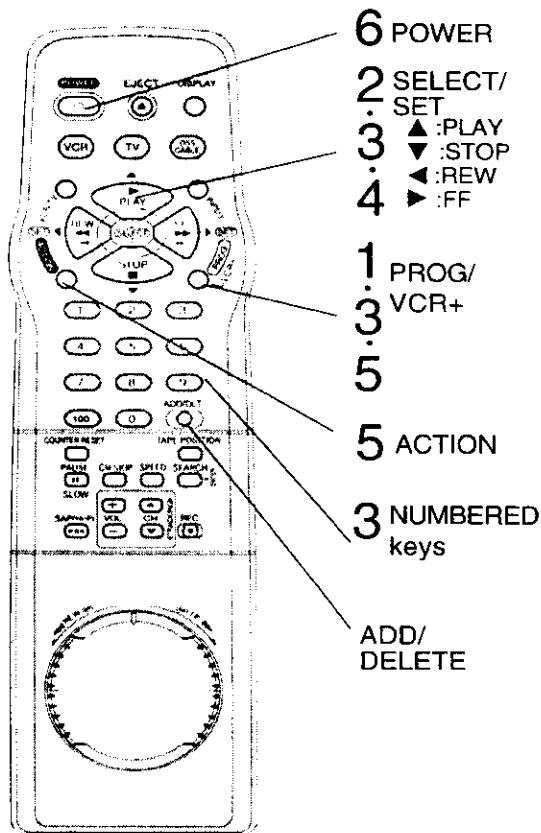

Timer Recording Using VCR Plus+ System

Use normal Timer Recording steps if:

- the PlusCode programming number for a program is not listed.
- you anticipate the program, such as a sporting event, to run over the scheduled stop time.

See page 13 to:

- cancel a timer recording in progress.
- replace program contents.
- review or clear program contents once set.

Important notes for DSS/Cable Box users

- When recording via DSS, the receiver, must be left on.
- When recording via cable or antenna, DSS receiver must be off.

Notes

- Avoid overlapping program times.
- VCR PlusCode programming numbers can not be used to program the VCR to record DSS and Cable Box channels.

Multi-Brand Control Feature

The Remote Control may be set up to control some TV or Cable/DSS Receiver functions.

Multi-Brand Control Setup

1 Find your TV, Cable or DSS Receiver Brand Code Number on following page.

2 Setup for TV

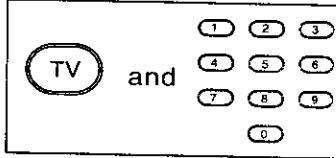

Set up remote.

Hold down TV and enter code with NUMBERED keys.

Setup for Cable or DSS

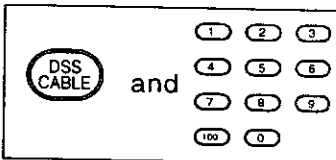

Hold down DSS/CABLE and enter code with NUMBERED keys.

- For code 100 or greater, press the 100 key first, then remaining digit. E.g. for 102, press 100, then press 0, and then press 2.

3

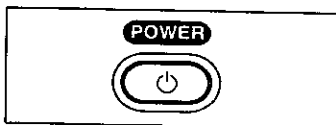

Confirm code entry.

Press POWER to turn selected unit on or off.

- See table below for list of controllable functions in each mode.

Notes

- Please repeat Multi-Brand Control setup after replacing remote control batteries.
- The remote control will not operate all TVs, Cable Boxes, and DSS receivers made by manufacturers listed. If you get no results, your particular brand cannot be controlled.

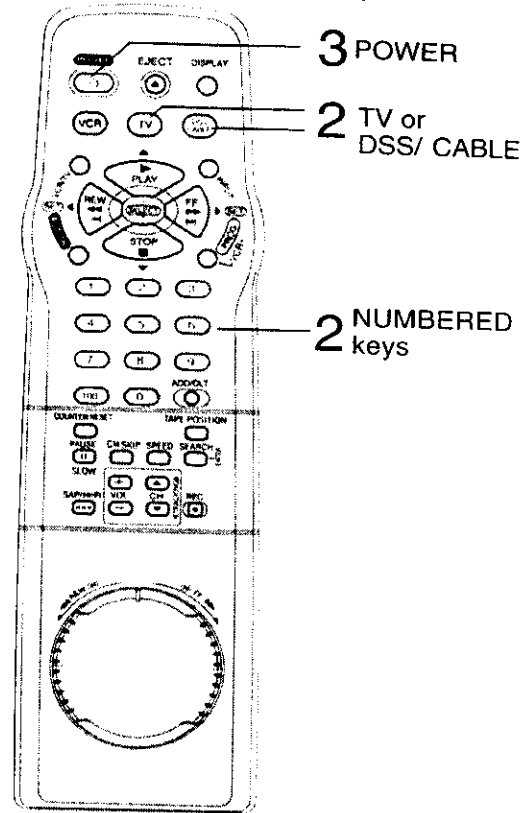

Using the Multi-Brand Control

After remote control is setup, you can select VCR, TV, or DSS/CABLE for the desired function.

Press **VCR** or **TV** or **DSS/CABLE** on the remote control.

This table shows which buttons are available for each mode.

Mode \ Available Buttons	VCR	TV	CABLE/ DSS
VCR	All Functions	VOL UP/DOWN	—
TV	VCR/TV, PLAY, STOP EJECT, SAP/Hi-Fi, DISPLAY, FF, REW, PAUSE/SLOW, REC, SPEED, COUNTER RESET, TAPE POSITION, CM SKIP	POWER, INPUT, NUMBERED keys, ENTER, CH UP/ DOWN, VOL UP/DOWN	—
CABLE/ DSS	VCR/TV, PLAY, STOP EJECT, SAP/Hi-Fi, DISPLAY, FF, REW, PAUSE/SLOW, REC, SPEED, COUNTER RESET, TAPE POSITION, CM SKIP	VOL UP/ DOWN	POWER, ENTER, NUMBERED keys (except 100key), CH UP/ DOWN

Note

In TV or DSS/ CABLE mode, it may be necessary to press ENTER after pressing NUMBERED keys for channel selection.

TV Brand Code Numbers

Panasonic	01, 02	Sylvania	05	JVC	11
Quasar	01, 02	Sharp	06, 07	Hitachi	12
RCA	03	Sony	08	Mitsubishi	07, 13
GE	03	Toshiba	09	Samsung	14
Zenith	04	Sanyo	10	Gold Star	15, 16, 17
Magnavox	05	Fisher	10		

Cable Box Brand Code Numbers

Archer	44, 06, 01, 120, 05, 63, 126	Oak Sigma	46, 11, 129, 101
Cableview	29, 09, 01, 63, 120, 44, 42, 30 52, 04, 124, 126	Panasonic	17, 16, 08, 87, 109
Citizen	44, 52, 30, 63, 42, 04, 124, 126	Philips	23, 24, 20, 13, 07, 50, 128, 129
Curtis	08, 09, 25, 61, 53, 87	Pioneer	06, 05, 12
Century	44, 51, 75, 59, 126	Pulsar	04, 42, 63, 44, 30, 52, 124, 126
Cabletenna	29, 09, 01, 63, 120, 44, 126	Quest	06, 05, 12
Cable Cinema	29, 09, 01, 63, 120, 44, 126	Radio Shack	44, 51, 75, 59, 126
Diamond	29, 09, 01, 63, 120, 44, 126	RCA	17, 16, 08, 87, 109
Eagle	62, 40, 22, 13, 58, 20, 26, 107	Realistic	44, 51, 75, 59, 126
Eastern	28, 29, 130	Recoton	44, 51, 75, 59, 126
Explorer	08, 09, 25, 61, 53, 87	Regal	41, 14, 15, 28, 102, 104, 103, 130
Gemini	30, 04, 124	Regency	28, 29, 130
General Electric	01, 57, 120	Rembrandt	44, 42, 63, 29, 01, 32, 39, 120, 126
General Instruments	01, 84, 83, 34, 03, 02, 04, 55, 65, 66, 67, 68, 120, 106, 121, 122, 115, 117, 118, 124	Samsung	42, 06, 32, 05, 40
Gerrard	44, 51, 75, 59	Scientific Atlanta	08, 09, 25, 61, 53, 87
GC Electronics	44, 42, 63, 29, 30, 52, 04, 124, 126	Sheritech	27
Hamlin	41, 14, 15, 28, 102, 104, 103, 130	Signal	26, 112
Hitachi	31	SL Marx	42, 06, 32, 40, 43, 44, 52, 63, 126
Jerrold	01, 84, 83, 34, 03, 02, 04, 55, 65, 66, 67, 68, 120, 106, 121, 122, 115, 117, 118, 124	Sprucer	17, 16, 08, 87, 109
Jasco	30, 04, 124	Standard Components	32, 39, 42, 44, 126
Macom	31	Stargate	04, 42, 32, 40, 63, 44, 30, 52, 06, 124, 126
Magnavox	26, 112	Sylvania	19, 18
Matsushita	17, 16, 08, 87, 109	Teknika	74, 35
Movietime	32, 39, 42, 44, 126, 38, 40	Telecaption	77, 127
Maestro	74, 35	Teleview	40, 19, 38, 32, 42, 06
NEC	40, 19, 38, 32	Texscan	19, 18
NSC	40, 19, 38, 32	Tocom	34, 33, 01, 42, 66, 120
Novavision	08, 09, 25, 61, 53, 87	Toshiba	36
Next Level	01, 84, 83, 34, 03, 02, 04, 55, 65, 66, 67, 68, 120, 106, 121, 122	Unika	44, 42, 63, 29, 01, 126, 120
Oak	46, 11, 129, 101	Universal	52, 43, 44, 63, 42, 126
		Viewstar	62, 40, 22, 13, 58, 20, 26, 107
		Videoway	07, 23, 50, 129
		Vidtek	64
		Zenith	07, 23, 50, 129

DSS Brand Code Numbers

Toshiba	90	Optimus	94, 95
Hitachi/ Hughes	91, 99	Panasonic	96
Primestar	92	ProScan	97
Drake	93	RCA	97
Magnavox	94, 95	Sony	98, 105
Uniden	94, 95		

Important Notes

- Due to changes in infra-red commands used by manufacturers, some brands have several codes. If your unit does not respond to the first code, please try the next one.
- Some TV, Cable Box and DSS Box brands require you to turn on the power manually.
- Not all functions listed may be controlled by this remote control.

Tape Operation

Search System

Each time a recording is made, an invisible index mark is placed on the tape. When timer recordings are made, program index and information are also included. These index marks can be used to access or scan recordings.

Program End Search

It is easy to locate the end of a recorded program allowing you to continue recording where you left off.

1



Display SELECT SEARCH MODE in Stop or Play mode.
Press SEARCH.*

2

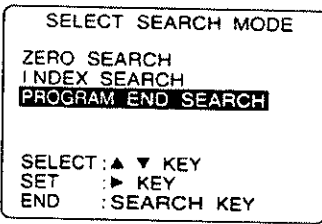

Select PROGRAM END SEARCH.

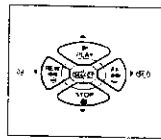

1) Press ▲▼ to select.
2) Press ► to start search.

Examples of Program End Search operation.

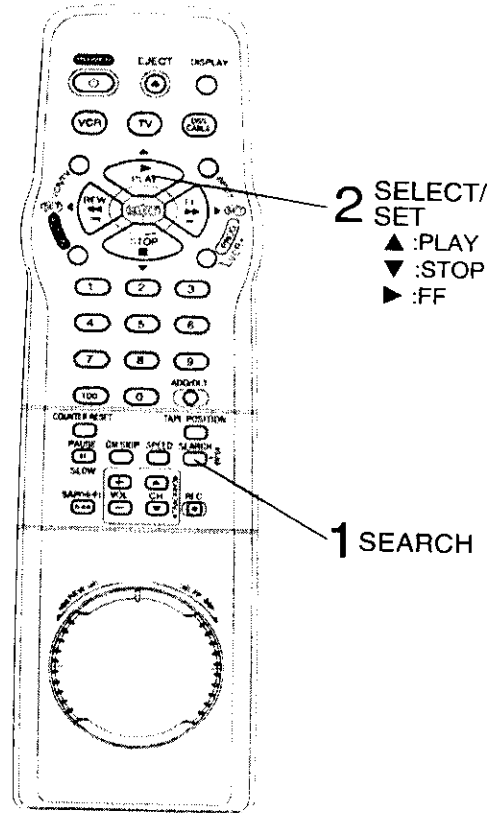
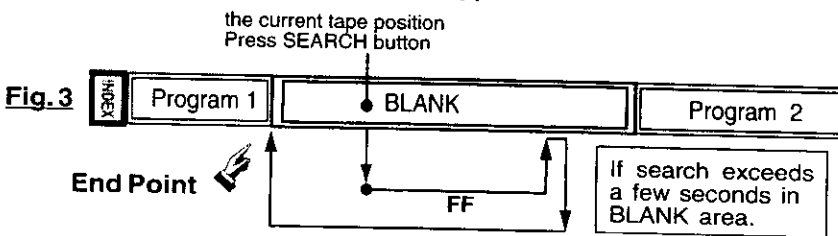
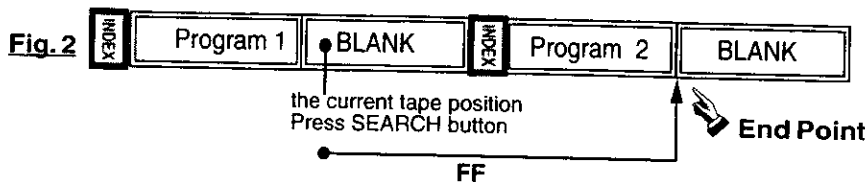
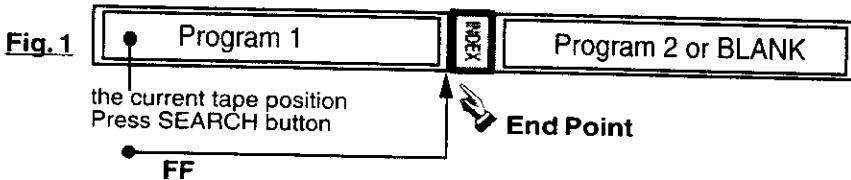

If Program End Point (↔) is found.

The search continues slightly beyond the end point, then search and reverse search and plays the last few seconds of the program and finally stops.

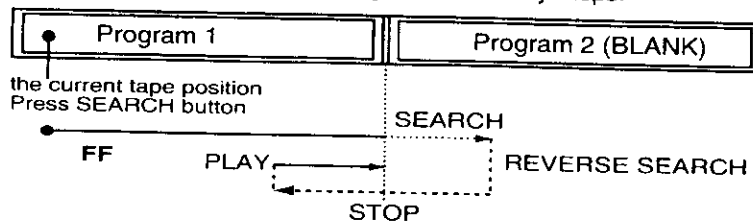

Notes

- If Program End Search is started very close to an index mark, one program may be skipped over.
- To cancel Program End Search, press PLAY or STOP.

***Important:** If the remote control POWER, ACTION, PROG/VCR+, CH▲/▼, NUMBERED keys, INPUT, SEARCH or ADD/HLT button does not work when pressed, press the VCR button on the remote and try the button again.

Index Scan (For normal and /or timer recordings)

In Play mode, the first 10 seconds of each recording can be scanned (forward or reverse).

1



Display SELECT SEARCH MODE in Stop or Play mode. Press SEARCH.*

2

SELECT SEARCH MODE
ZERO SEARCH
INDEX SEARCH
PROGRAM END SEARCH

SELECT : ▲ ▼ KEY
SET : ► KEY
END : SEARCH KEY

Select INDEX SEARCH.

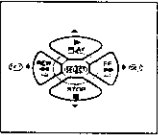

1) Press ▲▼ to select.
2) Press ► to display.

3

INDEX

Start scan.

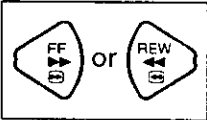

Press FF or REW.

4

AUTO INDEX SEARCH

Cancel scan, start playback.
Press PLAY.
• To stop, press STOP.

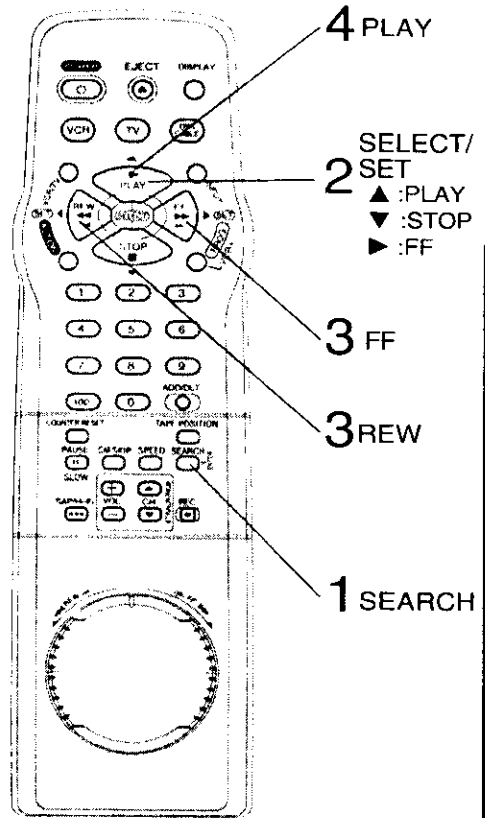
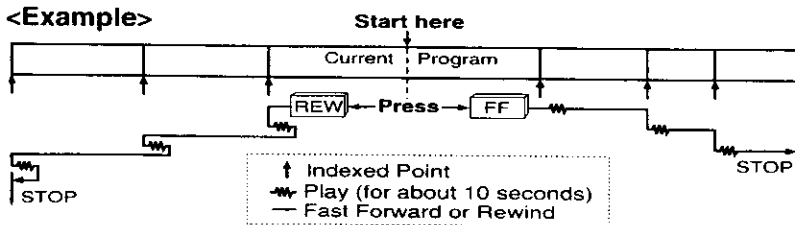
Tape Operation

Auto Operation Functions

Auto Playback

Insert tape --> Power turns on -->
--> Starts playback if record tab
(see page 30) is removed.

Auto Rewind

Playback
Manual Record } --> Tape end -->
Fast Forward } --> Rewinds (Auto)

Playback Auto Eject (Repeat Play is "OFF")

Playback --> Tape end --> Rewinds
-->Tape ejects (if without record tab)

Memory Rewind Off

Rewind --> Press POWER -->
-->Turns off after completed

Tape Operation (continued)

Direct Access (For normal and /or timer recordings)

Go directly to desired recording.

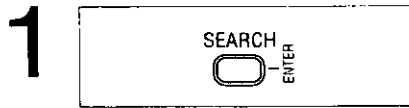

Display SELECT SEARCH MODE in Stop or Play mode. Press SEARCH.*

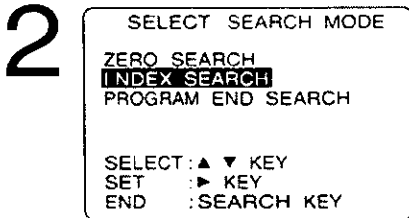

Select INDEX SEARCH.

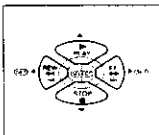

- 1) Press ▲▼ to select.
- 2) Press ► to display.

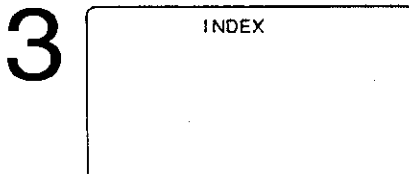

Select the recording number.

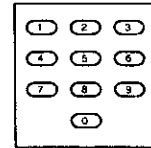

Press **NUMBERED** keys.

- To calculate number, see below.

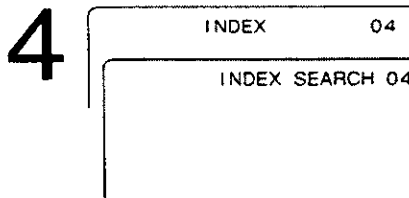

Start search.

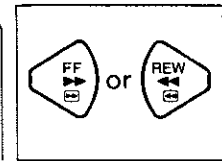

Press **FF** or **REW**.

- When search is finished, playback begins.

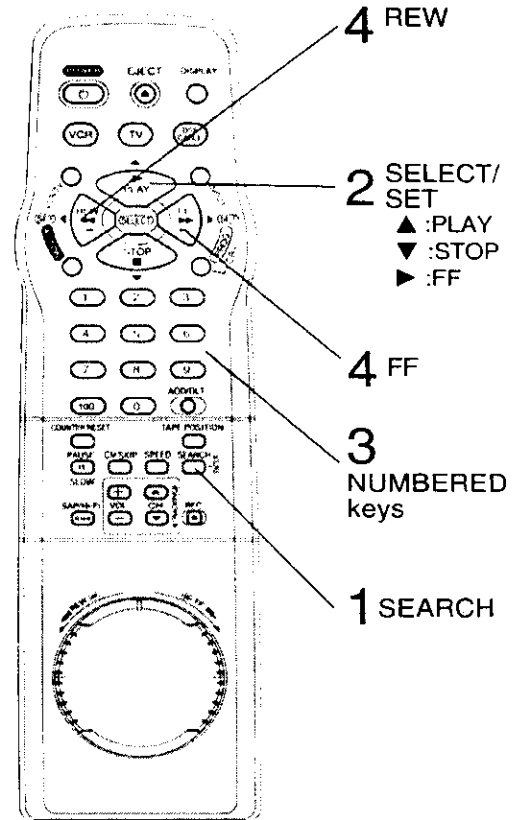

■ To Calculate Index Number

Example 1:

If you are watching recording 4 and you want to watch recording 2, enter 3 in step "3" and press REW.

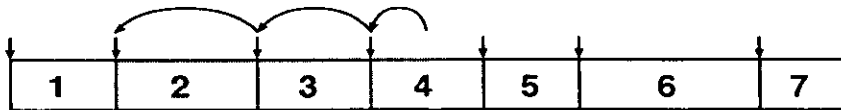

Example 2:

If you are watching recording 2 and you want to watch recording 6, enter 4 in step "3" and press FF.

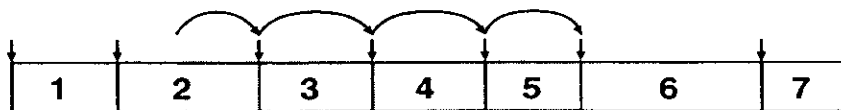

NOTE: ↓ indicates start points of each recording.

Notes

- Make each entry within 10 seconds, or the Index Search mode will be canceled.
- If Direct Access or Index Scan is started very close to an index mark, that index mark may not be counted in the search.

***Important:** If the remote control POWER, ACTION, PROG/VCR+, CH▲/▼, NUMBERED keys, INPUT, SEARCH or ADD/DLT button does not work when pressed, press the VCR button on the remote and try the button again.

Repeat Play

Set to playback a recording over and over.

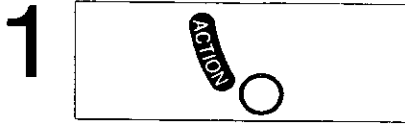

Display MENU.
Press ACTION.*

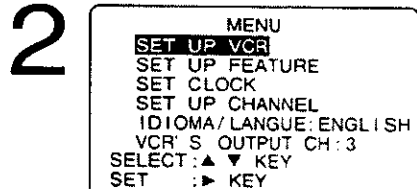

Display SET UP VCR.
1) Press ▲▼ to select.
2) Press ► to display.

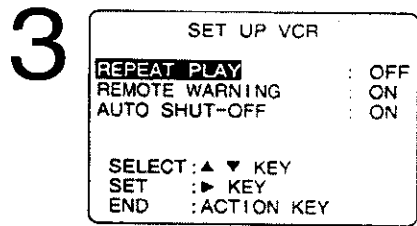

Set ON or OFF.
1) Press ▲▼ to select "REPEAT PLAY."
2) Press ► to set.

- Playback repeats when tape end is reached or unrecorded portion over 30 seconds is detected.

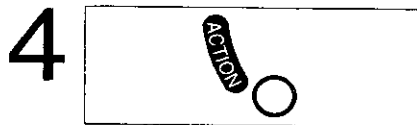

Return to normal screen.
Press ACTION twice.

Zero Search

To quickly return to specific tape counter location.

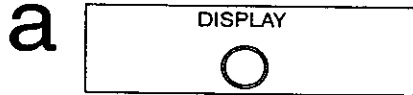

Display Counter.
Press DISPLAY during playback.

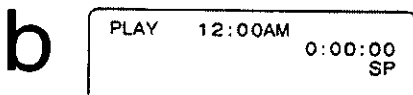

Reset to "0:00:00."
Press COUNTER RESET at the desired position.

c **Continue to record, playback etc.**

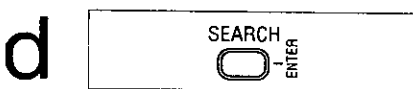

Display SELECT SEARCH MODE in Stop mode.
Press SEARCH.*

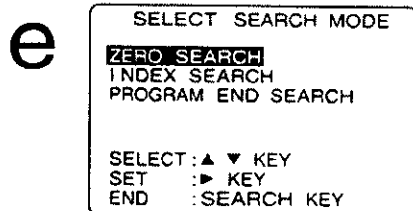

Start ZERO SEARCH.
1) Press ▲▼ to select.
2) Press ► to start.

- Unit will go into FF or REW mode and stop at the last point the Counter was set to 0:00:00.

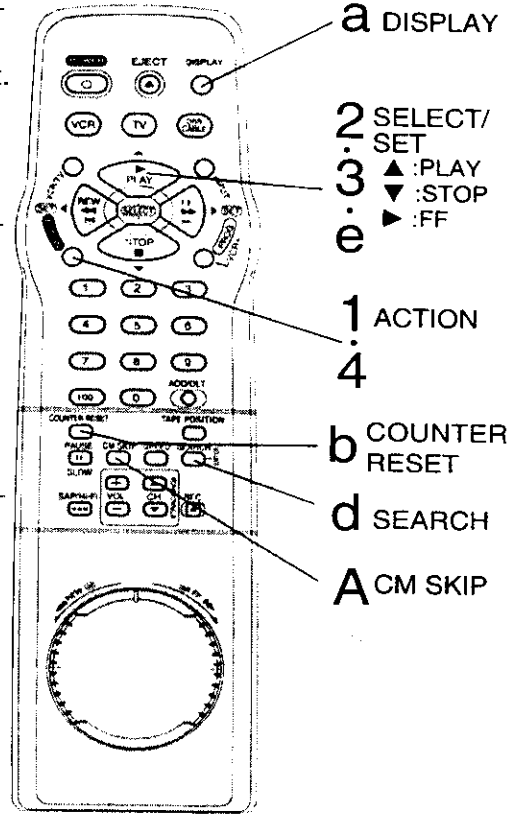

Tape Operation

Commercial Skip

VCR fast forwards (skips) over 1-3 minutes of recorded tape.

A Press CM SKIP in Play mode.

• The skip time can be changed by pressing CM SKIP button repeatedly as shown by the figure below.

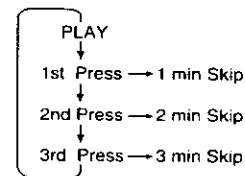

MTS Broadcast/VHS Hi-Fi Stereo System

✓ Check list before you begin.

- VCR is connected to a stereo TV, or a mono TV and an external stereo amp or receiver with speakers.
- VCR and other components are plugged in and turned on.

Connections to Make

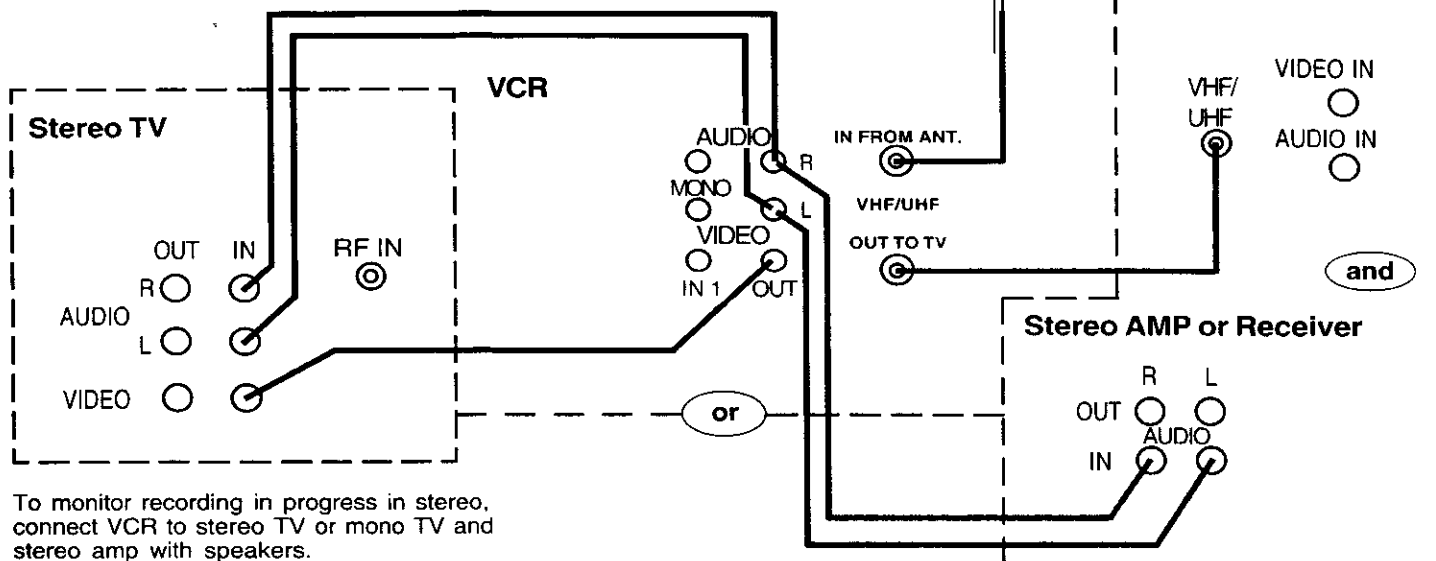

To monitor recording in progress in stereo, connect VCR to stereo TV or mono TV and stereo amp with speakers.

Receivable Broadcast Types

The following are possible audio broadcast types and on-screen displays. The signal being received is indicated with an "Ⓔ" mark while the selected audio mode is indicated with an arrow.

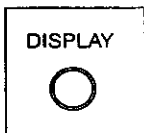

Display the broadcast signal being received. Press DISPLAY.

MTS Stereo and SAP broadcast

Multi-channel Television Sound Stereo (main language) and Secondary Audio Program (sub language) broadcasts are both being received simultaneously. Select STEREO or SAP audio mode.

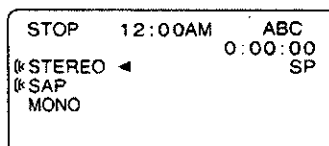

MTS Stereo broadcast

Multi-channel Television Sound Stereo broadcast. Select STEREO audio mode.

- If stereo broadcast is weak and display flickers, select MONO audio mode for possibly better results.

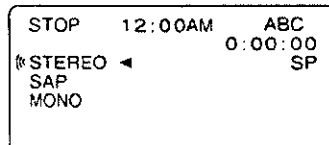

SAP broadcast

Secondary Audio Program (sub language) broadcast. Select SAP audio mode for the sub language.

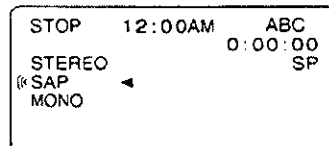

MONO broadcast

Normal monaural sound broadcast.

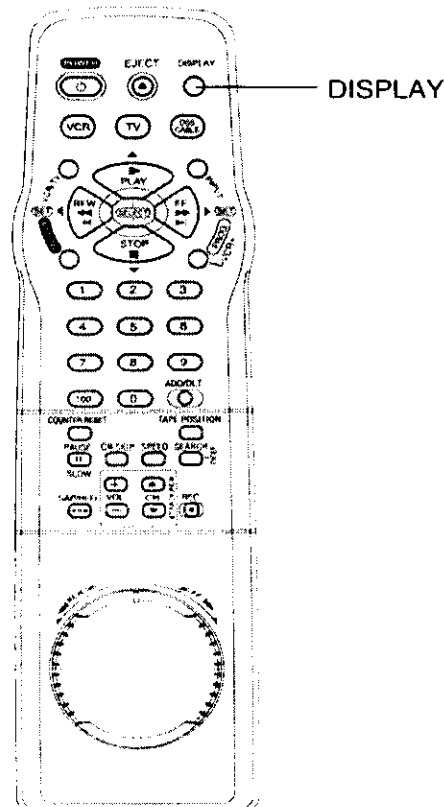
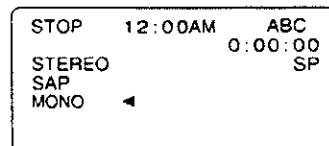

Equipped with dbx®-TV Noise Reduction for true MTS reproduction. dbx®-TV Noise Reduction is required for good stereo separation and audio fidelity. dbx® is a registered trademark, and is licensed by dbx® Technology Licensing.

When set to proper audio mode VCR can:

- 1) record/playback MTS stereo broadcasts (main language) in Hi-Fi stereo.
- 2) record/playback mono (main language) or SAP (sub language) broadcasts.
- 3) playback non Hi-Fi tapes in monaural.

- The selected broadcast sound is always recorded on the left and right Hi-Fi track as well as the normal monaural track. This means tapes can be played back on Hi-Fi and non-Hi-Fi VCRs.

Audio Mode for Recording

- 1**  **Display audio mode.**
Press SAP/ Hi-Fi.

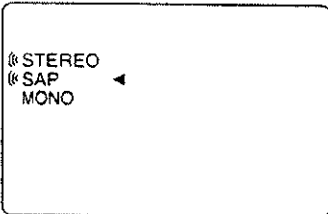
- 2**  **Select desired mode.**
Press SAP/ Hi-Fi repeatedly (each press within 5 seconds).
• Refer to "Receivable Broadcast Types" on page 24.

 - Arrow indicates selection.

- 3 Do a recording.**
See page 9.

Audio Mode for Playback

- a Start playback.**
See page 8.

- b**  **Display audio mode.**
Press SAP/ Hi-Fi.

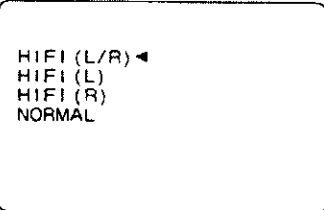
- c**  **Select desired mode.**
Press SAP/ Hi-Fi repeatedly (each press within 5 seconds).
• Select "HIFI(L/R)" or "HIFI(L)" or "HIFI(R)" to listen to stereo recordings in stereo sound. Select "NORMAL" for monaural sound.

 - Arrow indicates selection.

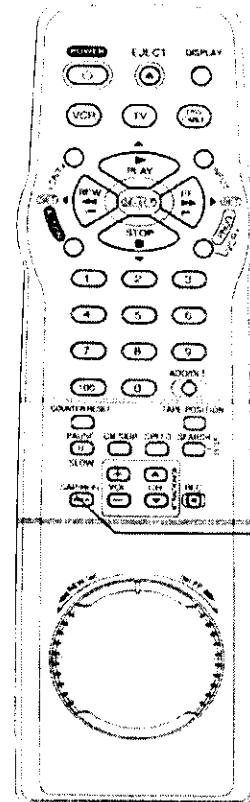

1. SAP/Hi-Fi
2.
3.

MTS Broadcast/VHS Hi-Fi Stereo System

Notes

- Only tapes recorded in Hi-Fi stereo will playback with true stereo sound. Standard stereo tapes will playback in monaural sound.
- To listen to Hi-Fi stereo playback, the VCR AUDIO (L/R) jacks must be connected to a stereo TV or an external stereo amp and speakers. (See page 24.)
- If tracking is adjusted during playback, Hi-Fi audio may revert to normal audio.
- Hi-Fi and normal audio playback volume level may differ.

Special VCR Features

Tape Position Display Feature

To find out the present tape position.

Tape position cannot be detected for VHS-C Cassette types and tapes of less than 60 minutes length.

1



Detect Tape Position.
Press TAPE POSITION.



- "DETECTING TAPE POSITION" only appears the first time a cassette is inserted.
- It takes several seconds for correct indication to appear.

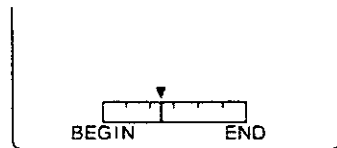

- The present tape position indication is displayed.

2



Return to normal screen.
Press TAPE POSITION.

Remote Warning ON/OFF Feature

If Multi-brand feature is used (page 18), and this feature is set to on, a warning appears whenever an invalid key is pressed in TV, DSS, or Cable mode.

a



Display MENU.
Press ACTION.*

b

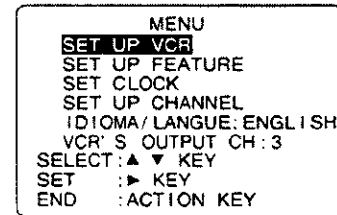

Display SET UP VCR.

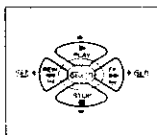

- 1) Press ▲▼ to select.
- 2) Press ► to display.

c

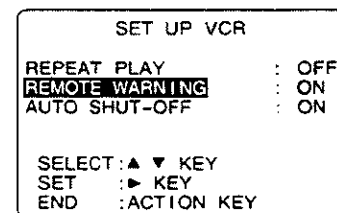

Set ON or OFF.

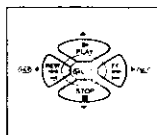

- 1) Press ▲▼ to select.
- 2) Press ► to set.

- "OFF" --> remote warning will not appear even if invalid key is pressed.

d



Return to normal screen.
Press ACTION twice.



Check list before you begin.

- All connections are made. (See pages 4-5.)
- VCR is plugged in.
- TV is turned on and tuned to CH3, 4 or Video.

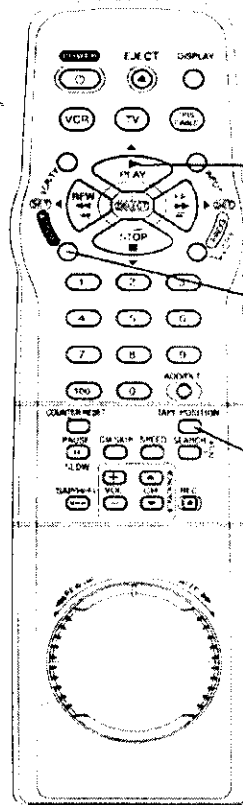

- b SELECT/SET
- c ▲:PLAY
▼:STOP
▶:FF
- a ACTION
- d
- 1 TAPE POSITION
- 2 POSITION

VCR Lock Feature

All operations are prohibited except timer recording and tape eject. Useful for families with small children.

A



Press REC in Stop mode.

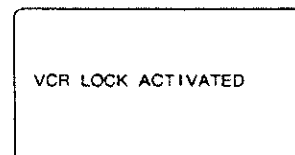

To turn on:
In Stop mode, hold down REC on the VCR without a cassette inserted for 7 seconds.

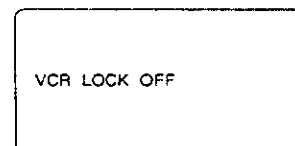

To turn off:
Repeat above.

- VCR Lock is canceled automatically after 24 hours if clock is set.

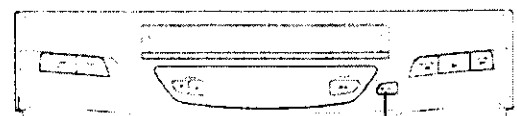

A REC

***Important:** If the remote control POWER, ACTION, PROG/VCR+, CH▲/▼, NUMBERED keys, INPUT, SEARCH or ADD/HLT button does not work when pressed, press the VCR button on the remote and try the button again.

Weak Signal Display ON/OFF Feature

When "ON" is selected, picture is displayed even when broadcast signal is weak or not present.

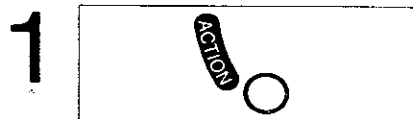

Display MENU.
Press ACTION.*

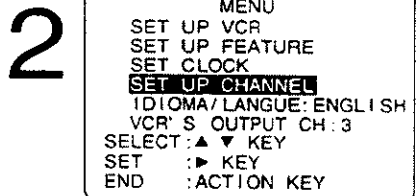

Display SET UP CHANNEL.

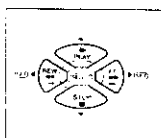

1) Press ▲▼ to select.
2) Press ► to display.

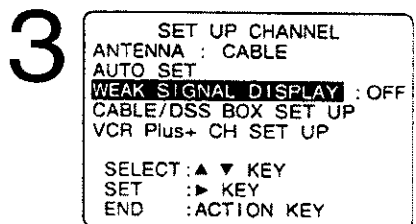

Set ON or OFF.

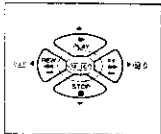

1) Press ▲▼ to select.
2) Press ► to set.

- ON --> Picture is displayed regardless of signal condition, and may not always be clearly visible.
- OFF --> Screen turns solid blue when signal is absent or weak.
- If VCR is connected to equipment which has blue back feature, selecting ON will have no effect on the other equipment.

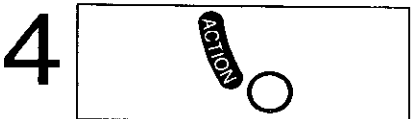

Return to normal screen.
Press ACTION twice.

Auto Shut-Off Feature

When "ON" is selected, VCR shuts itself off when playback of a blank portion of tape continues or no signal (except when LINE is selected) is detected for over 5 minutes.

a Repeat step "a" and "b" on page 26 to display SET UP VCR.

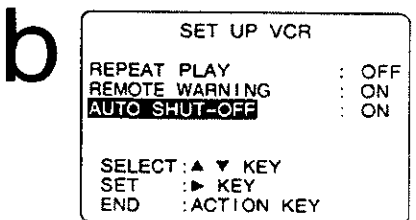

Set ON or OFF.

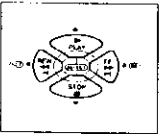

1) Press ▲▼ to select.
2) Press ► to set.

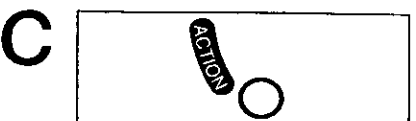

Return to normal screen.
Press ACTION twice.

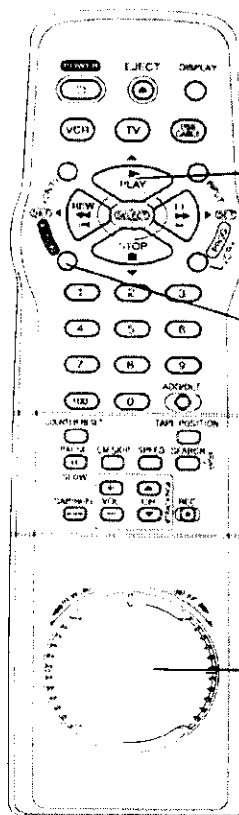

2 SELECT/SET
3 ▲:PLAY
▼:STOP
b ►:FF

1 ACTION
4
c

A SHUTTLE Ring

Special VCR Features

Shuttle Variable Speed Search

The SHUTTLE Ring allows you to smoothly control the tape speed during special effects playback in both forward or reverse.

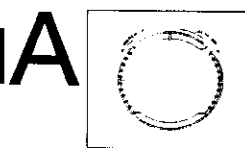

Place the forward or reverse search.

Turn SHUTTLE Ring while in Play or Still mode.

- The more you turn the Ring, the faster the search speed will be.

B Release the Shuttle mode.

Press a function button such as : PLAY, STOP, etc.

- The VCR performs the function of the button pressed.

Notes

- When the SHUTTLE Ring is turned more than half in Stop mode, normal Fast Forward or Rewind will begin.
- Some noise bars are normal during Shuttle operation.
- After 3 minutes in Still or Slow, the VCR will go into Stop mode.
- When the SHUTTLE Ring is released, the VCR goes into Still mode.

Reset Language, Channels, Clock, VCR's

1

```

MENU
SET UP VCR
SET UP FEATURE
SET CLOCK
SET UP CHANNEL
IDIOMA/LANGUE: ENGLISH
VCR'S OUTPUT CH: 3
SELECT: ▲ ▼ KEY
SET : ► KEY
END : ACTION KEY
    
```



Display MENU.
Press ACTION.*

2 ■ Language

- 1) Press ▲▼ to select language item.

```

MENU
SET UP VCR
SET UP FEATURE
SET CLOCK
SET UP CHANNEL
IDIOMA/LANGUE: ENGLISH
VCR'S OUTPUT CH: 3
SELECT: ▲ ▼ KEY
SET : ► KEY
END : ACTION KEY
    
```

- 2) Press ► repeatedly.

```

MENU
SET UP VCR
SET UP FEATURE
SET CLOCK
SET UP CHANNEL
IDIOMA/LANGUE: ENGLISH
VCR'S OUTPUT CH: 3
SELECT: ▲ ▼ KEY
SET : ► KEY
END : ACTION KEY
    
```

For English

```

MENU
PREPARAR VCR
FIJACION DE FUNCIONES
FIJAR RELOJ
FIJAR CANAL
LANGUE/LANGUAGE: ESPAÑOL
SALIDA DE VCR CANAL: 3
ELEGIR: ▲ ▼
FIJAR : ►
TERMINAR: ACTION
    
```

For Spanish

```

MENU
REGLAGE MAGNETOSCOPE
REGLAGE MAGNETO SUPPLEM
REGLAGE HORLOGE
REGLAGE CANAL
LANGUAGE/IDIOMA: FRANÇAIS
CA SORTIE: 3
SEL. : ▲ ▼
REGLER: ►
FIN : ACTION
    
```

For French

■ Channels

- 1) Press ▲▼ to select SET UP CHANNEL.

```

MENU
SET UP VCR
SET UP FEATURE
SET CLOCK
SET UP CHANNEL
IDIOMA/LANGUE: ENGLISH
VCR'S OUTPUT CH: 3
SELECT: ▲ ▼ KEY
SET : ► KEY
END : ACTION KEY
    
```

- 2) Press ►.

```

SET UP CHANNEL
ANTENNA : CABLE
AUTO SET
WEAK SIGNAL DISPLAY : OFF
CABLE/DSS BOX SET UP
VCR Plus+ CH SET UP

SELECT: ▲ ▼ KEY
SET : ► KEY
END : ACTION KEY
    
```

- 3) Press ▲▼ to select "ANTENNA," then press ► to set your antenna system (TV or CABLE).

- 4) Press ▲▼ to select "AUTO SET," then press ►.

- If you use a cable box, set it to the PBS channel in your time zone.

```

CHANNEL/CLOCK AUTO SET

CONNECT ANTENNA CABLE
AND IF YOU USE A CABLE
BOX, TUNE IT TO YOUR
LOCAL PBS CH THEN...

PLEASE PUSH CH UP KEY
    
```

(This screen appears only when auto clock is set.)

- 5) Press CH ▲.

- After Channel Auto Set is finished, Clock Auto Set will be performed.

■ Clock

- 1) Press ▲▼ to select SET CLOCK.

```

MENU
SET UP VCR
SET UP FEATURE
SET CLOCK
SET UP CHANNEL
IDIOMA/LANGUE: ENGLISH
VCR'S OUTPUT CH: 3
SELECT: ▲ ▼ KEY
SET : ► KEY
END : ACTION KEY
    
```

- 2) Press ►.

```

SET CLOCK

AUTO CLOCK SET
MANUAL
TIME ZONE ADJUST : 0

SELECT: ▲ ▼ KEY
SET : ► KEY
END : ACTION KEY
    
```

("TIME ZONE ADJUST" appears only when auto clock is set.)

- 3) Press ▲▼ to select MANUAL and press ►.

- For Auto Clock Set, select "AUTO CLOCK SET," then press CH ▲.

```

SET CLOCK // // //
1/ 4/2000 TUE 12:00PM
DST: ON \

SELECT HOUR

SELECT: ▲ ▼ KEY
SET : ◀ ▶ KEY
END : ACTION KEY
    
```

- 4) Press ▲▼ and ◀▶ to select and set the date, time, and DST (Daylight Saving Time).

- 5) Press ACTION twice to start the clock and exit this mode.

Output Channel

***Important:** If the remote control POWER, ACTION, PROG/VCR+, CH▲/▼, NUMBERED keys, INPUT, SEARCH or ADD/DLT button does not work when pressed, press the VCR button on the remote and try the button again.

Time Zone Adjust

(When Auto Clock is set only.)

- 1) Press ▲▼ to select SET CLOCK.

```

MENU
SET UP VCR
SET UP FEATURE
SET CLOCK
SET UP CHANNEL
IDIOMA/ LANGUE: ENGLISH
VCR' S OUTPUT CH: 3
SELECT: ▲ ▼ KEY
SET : ► KEY
END : ACTION KEY
    
```

- 2) Press ►.

```

SET CLOCK

AUTO CLOCK SET
MANUAL
TIME ZONE ADJUST : 0

SELECT: ▲ ▼ KEY
SET : ► KEY
END : ACTION KEY
    
```

- 3) Press ▲▼ to select TIME ZONE ADJUST and press ◀ or ▶ to subtract or add hour(s) as necessary.

```

SET CLOCK

AUTO CLOCK SET
MANUAL
TIME ZONE ADJUST : +1

SELECT: ▲ ▼ KEY
SET : ◀ KEY
END : ACTION KEY
    
```

- 4) Press ACTION twice.

- 5) Press POWER off to perform AUTO CLOCK SET.

- TIME ZONE ADJUST returns to "0" if clock is set manually.

VCR's Output Channel

- 1) Press ▲▼ to select VCR'S OUTPUT CH.

```

MENU
SET UP VCR
SET UP FEATURE
SET CLOCK
SET UP CHANNEL
IDIOMA/ LANGUE: ENGLISH
VCR' S OUTPUT CH: 3
SELECT: ▲ ▼ KEY
SET : ► KEY
END : ACTION KEY
    
```

- 2) Press ►.

```

IF YOU PUSH ACTION KEY,
VCR' S OUTPUT CH SWITCHES
TO CH 4.
    
```

- 3) Press ACTION.

```

PLEASE TUNE YOUR TV TO
CH 4.
    
```

After 3 seconds

```

MENU
SET UP VCR
SET UP FEATURE
SET CLOCK
SET UP CHANNEL
IDIOMA/ LANGUE: ENGLISH
VCR' S OUTPUT CH: 4
SELECT: ▲ ▼ KEY
SET : ► KEY
END : ACTION KEY
    
```

- To Make Corrections, repeat step 1) ~ 3).

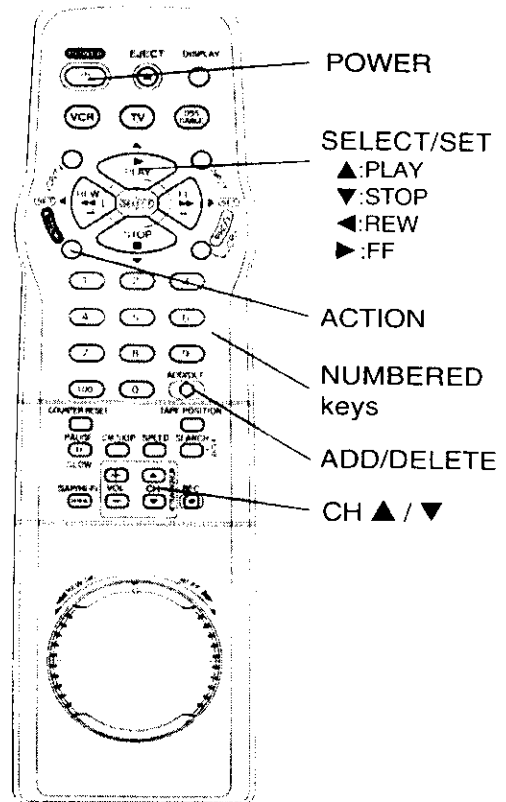

Add or Delete a Channel

To add channel:

Select channel with NUMBERED keys and press ADD/DLT.

```

CHANNEL 08 ADDED
    
```

To delete channel:

Select channel with CH ▲ / ▼ or NUMBERED keys and press ADD/DLT.

```

CHANNEL 08 DELETED
    
```

Reset Language, Channels, Clock,
VCR's Output Channel

VCR & Cassette Information

Reset All VCR Memory Functions

Use when moving VCR to new location, or if a mistake was made in the One Time VCR Setup section.

- Make sure a tape is not inserted in the VCR.

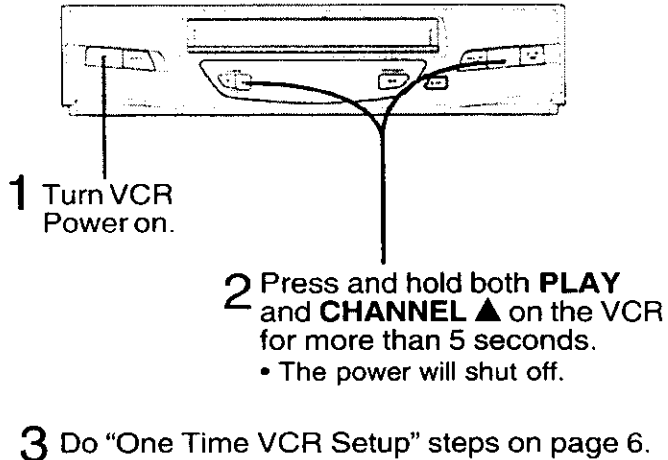

Prevent Accidental Tape Erasure

Break off the tab to prevent recording.

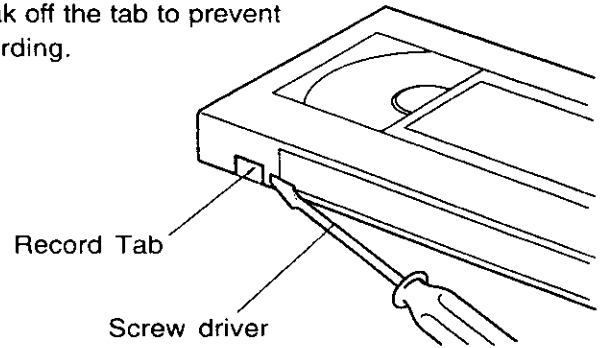

To record again

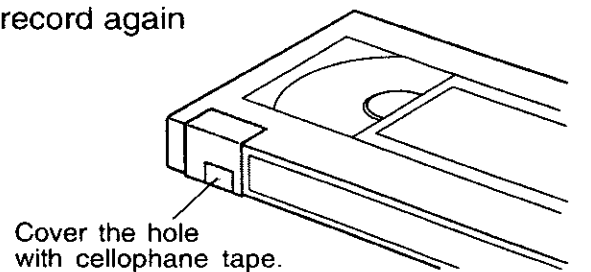

DST (Daylight Saving Time)

VCR auto adjusts clock for DST. (Page 7.)

Spring (First Sunday in April)

DST:ON --> sets clock ahead one hour.

Autumn (Last Sunday in October)

DST:ON --> Turns clock back one hour.

- If your area does not observe Daylight Saving Time, select DST:OFF.
- Keep these time changes in mind when programming the VCR for timer recordings.

Record/Playback Time

Only use tapes with the **VHS** mark in this unit.

Tape Speed Setting	Type of Video Cassette		
	T60	T120	T160
SP (Standard Play)	1 Hour	2 Hours	2 Hours 40 Minutes
LP (Long Play)	2 Hours	4 Hours	5 Hours 20 Minutes
SLP (Super Long Play)	3 Hours	6 Hours	8 Hours

Head Cleaning

Playing older or damaged tapes may eventually cause video heads to become clogged.

Video Head Clog Sensor

During playback, this screen appears if clogging is detected. To remove screen, press PLAY on the remote or VCR.

VIDEO HEADS MAY
NEED CLEANING
PLEASE INSERT HEAD
CLEANING CASSETTE
OR REFER TO MANUAL

END PLAY KEY

- Use "dry" type head cleaning cassette only. (Part No. NV-TCL30PT is recommended.)

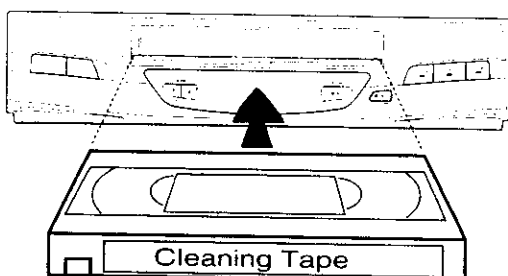

- Follow cleaning tape instructions carefully. Excessive use of tape can shorten head life.
- If head clog symptoms persist, contact your nearest Factory Service Center or authorized Service Center.

Cleaning the VCR

Use a soft cloth or dusting attachment of a vacuum cleaner to remove dust from the ventilation holes on the back sides and bottom of the cabinet.

Plastic surfaces are easily scratched and can be marred by alcohol and various solvents. Avoid excessive use of oil-based furniture polishes since the materials used in the cabinet will accumulate more dust. We recommend using a nonabrasive, antistatic cleaner and polisher.

Specifications

Power Source:	120 V AC, 60 Hz
Power Consumption:	<u>Power On</u> Approx. 23 watts <u>Power Off</u> Approx. 3.3 watts
Video Signal:	EIA Standard NTSC color
Video Recording System:	4 rotary heads helical scanning system
Audio Track:	1 track (Normal) 2 channel (Hi-Fi Audio Sound)
Tuner:	
Broadcast Channels:	VHF 2~13, UHF 14~69
CABLE Channels:	Midband A through I (14~22) Superband J through W (23~36) Hyperband AA~EEE (37~64) Lowband A-5~A-1 (95~99) Special CABLE channel 5 A (01) Ultraband 65~94, 100~125
Operating Temperature:	5 °C~40 °C (41 °F~104 °F)
Operating Humidity:	10 %~75 %
Weight:	3.0 kg (6.6 lbs).
Dimensions:	380 (W) x 93 (H) x 250 (D) mm 14-15/16" (W) x 3-11/16" (H) x 9-3/4" (D)

Note: Designs and specifications are subject to change without notice.

Features for a Quality Picture

Digital Auto Picture

Automatically controls the video output signal for less noise depending on the tape condition.

Digital Auto Tracking

Continuously analyzes the signal and adjusts for optimum picture quality.

Manual Tracking Control (to reduce picture noise)

Use during Playback and Slow Motion mode to reduce picture noise. Press CH (TRACKING) ▲ / ▼ buttons on the remote control or on the VCR until the picture clears up. To return to Auto Tracking, press POWER off, then on again a few seconds later.

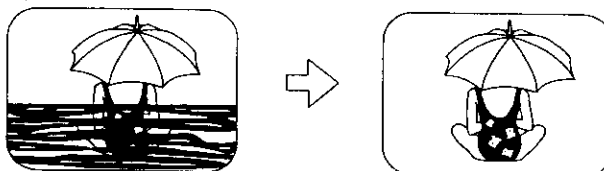

V-Lock Control (to reduce picture jitter)

In Still mode, CH (TRACKING) ▲ / ▼ buttons operate as a V-Lock control.

On-Screen Displays (OSD)

Function & Channel Display

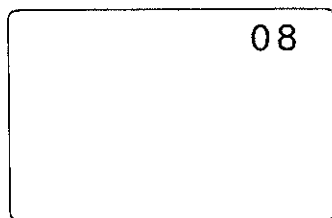

When a function button is pressed, e.g. PLAY, or you change channels, a 4 second display appears first in large and then small characters.

Blank Tape/ No Video Signal Indication

Whenever a blank section of a tape comes up in Play mode, or when the selected channel has no broadcast signal with the Weak Signal Display Feature (page 27) set to OFF, the TV screen will turn solid blue.

VCR Status & Clock Display

To display or remove the overlay at right.

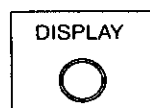

Press DISPLAY.

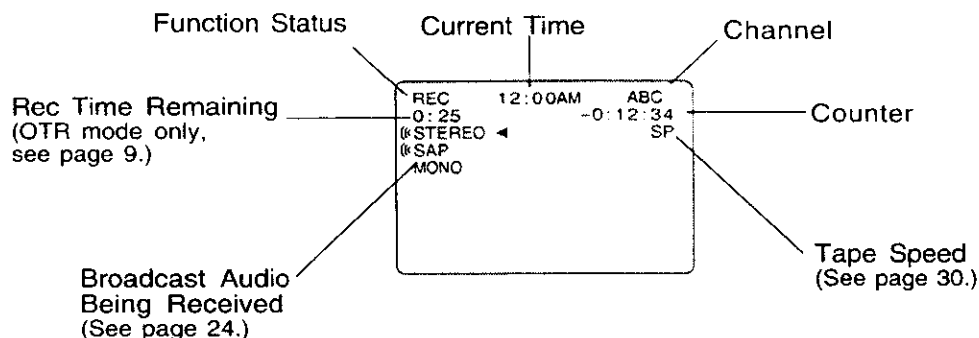

Warning and Instruction Displays

These displays will alert you of a missed operation or provide further instructions.

OSD	Caution	Pg	OSD	Caution	Pg
NO CH FOUND PLEASE CHECK ANTENNA CABLE CONNECTION THEN PUSH VCR CH UP KEY AGAIN	If no active channels are found for CHANNEL MEMORY...	6	TO CANCEL TIMER REC PUSH POWER THEN STOP KEY	If you press POWER or STOP during a Timer Recording... (visible in VCR mode only)	12
PLEASE SET CLOCK BEFORE PROGRAMMING	If you attempt to set or review a Timer Recording and the Clock is not set...	12	VIDEO HEADS MAY NEED CLEANING PLEASE INSERT HEAD CLEANING CASSETTE OR REFER TO MANUAL END: PLAY KEY	If head cleaning becomes necessary while playing back a tape...	31
TURN VCR OFF FOR TIMER RECORDING	After a Timer Program has been set...	12	VCR LOCK ACTIVATED	If you press a function button other than STOP/EJECT or POWER while the VCR is in VCR Lock mode...	26
CHECK CASSETTE RECORD TAB	If you press REC on the remote control or VCR, and a cassette is inserted with no record tab...	30	REMOTE CONTROL IS SET TO CABLE/DSS MODE USE VCR : VCR KEY USE TV : TV KEY	If you press any invalid keys on the remote while in CABLE/DSS mode...	18 19 26
NO CASSETTE PLEASE INSERT A CASSETTE	If you press PLAY, FF, REW, or REC on the remote control or VCR without a cassette inserted...	8 9	REMOTE CONTROL IS SET TO TV MODE USE VCR : VCR KEY USE CABLE/DSS : CABLE/DSS	If you press any invalid keys on the remote while in TV mode...	18 19 26

Before Requesting Service

Check the following points once again if you are having trouble with your VCR.

Power	Correction
No power...	<ul style="list-style-type: none"> • Completely insert Power Plug into an AC outlet. • Set POWER button to on. • Make sure power source is active.
Recording & Playback	Correction
TV program cannot be recorded...	<ul style="list-style-type: none"> • Check connections between VCR, external antenna, and TV. • Check hook up selection. (P.4-5) • Make sure your antenna system (CABLE or TV) is correctly set. (Channels [P.28]) • Make sure cassette record tab is intact. (P.30)
Timer recording cannot be performed...	<ul style="list-style-type: none"> • Confirm that clock is set to current time and date. • Make sure Cable/DSS box (if used) is left on and tuned to channel to be recorded. • Set recording start/stop times correctly. (P.12) • Make sure POWER button is set to off. (P.12,13) • Timer recording may not be performed or continued if a power interruption of more than 1 minute occurs before or during, a Timer Recording, even after power is restored.
There is no playback picture, or the playback picture is noisy or contains streaks...	<ul style="list-style-type: none"> • Select channel 3 or 4 on TV to match VCR output channel (3 or 4) (P.6) or select LINE. • Set VCR/TV selector to "VCR." • Adjust TRACKING control in either direction. (P.31) • Try Head Cleaning. (P.31)
Special effects playback, picture may contain some vertical jitter when using a TV with an Automatic Vertical Hold Control...	<ul style="list-style-type: none"> • Set TV's Vertical Hold Control to MANUAL, then adjust.
VCR cannot be controlled...	<ul style="list-style-type: none"> • Make sure VCR LOCK is set to off. (P.26) • Make sure remote is in proper mode.(P.18) • Make sure Timer Record is not in progress.
Remote Control	Correction
VCR cannot be remote controlled...	<ul style="list-style-type: none"> • Aim Remote Control directly at remote sensor on VCR. (P.38) • Avoid any object blocking signal path. • Check remote batteries. (P.4) • Make sure VCR LOCK is set to off. (P.26) • Exposing VCR remote sensor to direct fluorescent or outdoor light may cause signal interference.
ACTION and PROG/VCR+ buttons cannot be used...	<ul style="list-style-type: none"> • Press VCR button for VCR mode. (P.18) • Check remote batteries. (P.4)
Miscellaneous	Correction
Programs cannot be viewed on TV...	<ul style="list-style-type: none"> • Set VCR/TV selector to "TV." (P.9) • Make sure proper signal source is selected.
Video cassette cannot be inserted...	<ul style="list-style-type: none"> • Insert the cassette with window side up; record tab facing you. • Check if a tape is already in the unit.
Video cassette cannot be removed...	<ul style="list-style-type: none"> • Completely insert Power Plug into an AC outlet.
Video cassette ejects when a recording is started or the power is turned off for timer recording...	<ul style="list-style-type: none"> • Make sure cassette record tab is intact. (P.30)
In Stop mode, the motor (CYLINDER) continues to rotate...	<ul style="list-style-type: none"> • To enable Quick play mechanism, the cylinder will rotate for about 5 minutes. This reduces response time from Stop to Play mode and from Play to Rewind Search mode.
The top of the playback picture waves back and forth excessively...	<ul style="list-style-type: none"> • Because VCR playback signal is not as stable as off-the-air TV signal, top of TV screen may be bent or unstable during playback. Slowly turn TV horizontal Hold control to correct. If your TV has no horizontal Hold control or adjusting control is ineffective, contact your nearest TV service center.

Warranty

Panasonic Consumer Electronics Company,
Division of Matsushita Electric Corporation
of America,
One Panasonic Way
Secaucus, New Jersey 07094

Panasonic Sales Company,
Division of Matsushita Electric of Puerto Rico, Inc.
AVE. 65 de Infantería, Km. 9.5
San Gabriel Industrial Park
Carolina, Puerto Rico 00985

PANASONIC Video Products Limited Warranty

Panasonic Consumer Electronics Company or Panasonic Sales Company (collectively referred to as "the Warrantor") will repair this product with new or refurbished parts, free of charge, in the USA or Puerto Rico, in the event of a defect in materials or workmanship as follows (all time periods commence from the date of the original purchase):

<u>PRODUCT</u>	<u>PARTS</u>	<u>LABOR</u>
CAMCORDER	ONE (1) YEAR, EXCEPT CCD IMAGE SENSOR CCD IMAGE SENSOR - SIX (6) MONTHS	NINETY (90) DAYS NINETY (90) DAYS
VCR	ONE (1) YEAR	NINETY (90) DAYS
A/V MIXER	ONE (1) YEAR	NINETY (90) DAYS
MONITOR-VCR	ONE (1) YEAR, EXCEPT CRT CRT - TWO (2) YEARS	NINETY (90) DAYS CRT - NINETY (90) DAYS CUSTOMER PAYS ALL LABOR CHARGES AFTER 90 DAYS

Monitor-VCR In-home or carry-in Service: 22" (diagonal) CRT / LCD and Larger
Monitor-VCR Carry-in Service: 21" (diagonal) CRT / LCD and smaller

Batteries (if included) - New rechargeable batteries in exchange for defective rechargeable batteries for ten (10) days. Non-rechargeable batteries are not warranted.

Tape (if included) - New video cassette tape in exchange for a defective video cassette tape for five (5) days.

In-home, carry-in or mail-in service, as applicable, in the USA can be obtained during the warranty period by contacting a Panasonic Services Company (PASC) Factory Servicenter listed in the Service Directory. Or call toll free 1-800-211-PANA (7262), to locate an authorized PASC Servicenter. Carry-in or mail-in service in Puerto Rico can be obtained during the warranty period by calling the Panasonic Sales Company telephone number listed in the Servicenter Directory.

This warranty is extended only to the original purchaser. A purchase receipt or other proof of the date of the original purchase is required before warranty service is rendered.

This warranty only covers failures due to defects in materials and workmanship which occur during normal use and does not cover normal maintenance, including, but not limited to, video and audio head cleaning. The warranty does not cover damage which occurs in shipment, or failures which are caused by products not supplied by the warrantor, or failures which result from accident, misuse, abuse, neglect, mishandling, misapplication, alteration, modification, faulty installation, set-up adjustments, improper antenna, inadequate signal pickup, maladjustment of consumer controls, improper operation, power line surge, improper voltage supply, lightning damage, commercial use such as hotel, office, restaurant, or other business or rental use of the product, or service by anyone other than a PASC Factory Servicenter or a PASC authorized Servicenter, or damage that is attributable to acts of God.

LIMITS AND EXCLUSIONS

There are no express warranties except as listed above.

THE WARRANTOR SHALL NOT BE LIABLE FOR INCIDENTAL OR CONSEQUENTIAL DAMAGES (INCLUDING, WITHOUT LIMITATION, DAMAGE TO TAPES) RESULTING FROM THE USE OF THIS PRODUCTS, OR ARISING OUT OF ANY BREACH OF THE WARRANTY. ALL EXPRESS AND IMPLIED WARRANTIES, INCLUDING THE WARRANTIES OF MERCHANTABILITY AND FITNESS FOR PARTICULAR PURPOSE, ARE LIMITED TO THE APPLICABLE WARRANTY PERIOD SET FORTH ABOVE. Some states do not allow the exclusion or limitation of incidental or consequential damages, or limitations on how long an implied warranty lasts, so the above exclusions or limitations may not apply to you.

This warranty gives you specific legal rights and you may also have other rights which vary from state to state.

If a problem with this product develops during or after the warranty period, you may contact your dealer or Servicenter. If the problem is not handled to your satisfaction, then write to the Customer Satisfaction Center at the Panasonic Consumer Electronics Company address above.

SERVICE CALLS WHICH DO NOT INVOLVE DEFECTIVE MATERIALS OR WORKMANSHIP AS DETERMINED BY THE WARRANTOR, IN ITS SOLE DISCRETION, ARE NOT COVERED. COSTS OF SUCH SERVICE CALLS ARE THE RESPONSIBILITY OF THE PURCHASER.

warvid 10/20/97

Thank you for your purchase.

For service of this Panasonic product, please contact your local Sears Service Center.

To locate the closest Sears Service Center, call 1-800-488-1222.

Spanish Quick Use Guide/Guía para rápida consulta

Para ajustar el idioma, canal y reloj

1 Encienda el televisor y la videograbadora.

Presione POWER.

- Si se utiliza un cable de conexión AV, sitúe el TV en la posición Vídeo en lugar de en la posición canal. (Véase el punto a, en la página 4).

2

SELECT LANGUAGE
PUSH CH ▲ : ENGLISH
OPRIMIR CH ▼ : ESPAÑOL
APP. VCR/TV : FRANÇAIS

TO CHANGE VCR'S OUTPUT CH. PUSH ACTION KEY.

Presione ACTION

IF YOU PUSH ACTION KEY, VCR'S OUTPUT CH SWITCHES TO CH 4.

Presione ACTION

PLEASE TUNE YOUR TV TO CH 4.

Después de 3 segundos

Visualización de SELECCIÓN DE IDIOMA.

Esta visualización aparece sólo cuando realice la configuración por primera vez.

Seleccione el idioma.

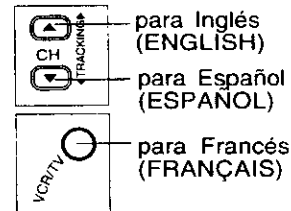

Si se utiliza la conexión b) (véase la página 4), sintonícelo en el canal de salida de VCR.

Si la imagen tiene oscilaciones o ruido cuando el equipo esté situado en VCR OUTPUT CH3, cambie a CH4 pulsando ACTION dos veces. Luego, sintonice el TV en el CH4.

- Sintonice siempre el TV a este canal para monitorizar la video grabadora.
- Si utilizó la conexión del conector audio/video, sintonice el TV a su entrada de video.
- Si se ajusta el idioma equivocado, realice los pasos de "Reajuste de todas las funciones de memoria de la video grabadora" en la página 30.

3

ELEGIR LA CONEXION
CABLE/DSS/VCR-TV
VCR-CABLE/DSS-TV
VCR-TV

ELEGIR: ▲ ▼
FIJAR: ►
TERMINAR: ACTION

- Si ud. ha elegido CABLE/ DSS ► VCR ► TV, continúe al paso 4 y sólo el canal de salida del cable será memorizado.
- Si no, vaya al paso 6.

Seleccione la conexión.

- 1) Presione ▲▼ para seleccionar.
- 2) Presione ► para ajustar.

4

ELEGIR LA CONEXION
CABLE/DSS/VCR-TV

SALIDA DEL CABLE/DSS
CA 01

ELEGIR: ▲ ▼
FIJAR: ►
TERMINAR: ACTION

- Si es necesario, consulte su manual de la caja de TV por cable.
- Si esta usando los terminales de audio/ video para su conexión para la caja de TV por cable, ajuste "SALIDA DE VIDEO".

Seleccione la caja de TV por cable o su receptor el canal de salida.

- 1) Presione ▲▼ para seleccionar.
- 2) Presione ► para fijar.

5 Encienda la caja de TV por cable y fije la caja de TV por cable al canal PBS de su zona.

6

FIJACION AUTO. (CA/RELOJ)

CONECTE EL CABLE DE LA ANTENA Y SI ESTA USANDO UNA CAJA DE TV POR CABLE SINTONICE AL CANAL PBS DE SU LOCAL LUEGO...

POR FAVOR OPRIMIR CH UP

Comience el ajuste automático de canales y el ajuste automático del reloj.

Presione CH ▲.

AUTOPROGRAMACION EN PROCESO

FIJACION AUTOMATICA DEL RELOJ EN PROCESO

Caso1 (Ajuste terminado)

1/ 4/2000 MAR 12:00PM
HORA VERANIEGA:ACT
CANAL FIJADO : CA 02
FIJACION AUTOMATICA COMPLETO
TERMINAR:OPRIMIR CH UP

Presione CH ▲ para salir.

Caso2 (Ajuste sin terminar)

FIJACION AUTOMATICA DEL RELOJ INCOMPLETO
OPRIMIR ACTION PARA FIJAR EL RELOJ

Caso2 El ajuste del reloj es incompleto.

Ajuste el reloj manualmente.

- 1) Presione ACTION.
- 2) Presione ▲▼ para seleccionar el mes.
- 3) Presione ► para ajustar.
 - De la misma manera, ajuste el día, el año, la hora y la hora de ahorro de energía (VERANO).
 - Para hacer correcciones, presione repetidamente ◀▶ para moverse hasta el error, luego corrijalo.
- 4) Presione ACTION. (El reloj se activa.)
 - Para salir de este modo, pulse la tecla ACTION nuevamente.

Ajustar de nuevo el reloj

1 Presione ACTION para exhiba el menú.

2

MENU
PREPARAR VCR
FIJACION DE FUNCIONES
FIJAR RELOJ
FIJAR CANAL
LANGUE/ LANGUAGE : ESPAÑOL
SALIDA DE VCR CANAL : 3
ELEGIR: ▲ ▼
FIJAR: ►
TERMINAR: ACTION

Presione ▲▼ para seleccionar "FIJAR RELOJ" y luego presione ►.

3

FIJAR RELOJ
FIJACION AUTOMATICA
MANUAL
AJUSTE ZONA HORA : 0
ELEGIR: ▲ ▼
FIJAR: ►
TERMINAR: ACTION

Presione ▲▼ para seleccionar "MANUAL" y luego presione ►.

4

FIJAR RELOJ
1/ 4/2000 MAR 12:00PM
VERANO:ACT
ELEGIR HORA
ELEGIR: ▲ ▼
FIJAR: ►
TERMINAR: ACTION

Presione ▲▼ y ◀▶ para seleccionar y ajustar la hora y la fecha.

5 Presione ACTION dos veces para que el reloj comience a funcionar y salir desde este modo.

Operaciones básicas para la reproducción

1 Inserte un casete.

- La videograbadora se enciende automáticamente.

2 Presione PLAY.

- O, si el casete no tuviera la lengüeta de grabación (véase la página 30), se inicia la reproducción automática.
- Para encontrar una escena en particular
Búsqueda hacia adelante ---> Presione FF.
Búsqueda hacia atrás ---> Presione REW.
- Para ver una imagen fija (congelada) --->
Presione PAUSE/SLOW.
- Para ver imágenes cuadro a cuadro --->
Presione PAUSE/SLOW en el modo de imagen fija.
- Para ver en cámara lenta ---> Mantenga pulsado el botón PAUSE/SLOW en el modo de imagen fija.
- Para parar ---> Presione STOP.
- Para rebobinar la cinta ---> Presione REW.
- Para hacer avanzar la cinta rápidamente --->
Presione FF
- Para expulsar la cinta ---> Presione STOP/EJECT en el videograbadora.

Operaciones básicas para la grabación

1 Inserte un casete.

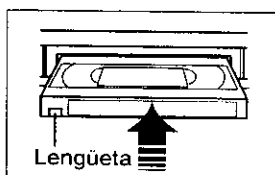

- La videograbadora se enciende automáticamente.

2 Seleccione el canal.

Presione CH ▲ / ▼ o las teclas numéricas correspondiente.

3 Seleccione la velocidad de grabación.

Presione SPEED.

- SP = Reproducción estándar,
- LP = Larga duración,
- SLP = Superlarga duración.

4 Comience la grabación.

Presione REC.

- Presione PAUSE/SLOW para hacer una pausa en la grabación en progreso.

- Para parar ---> Presione STOP.
- Grabación de un toque

Presione REC repetidamente para ajustar la hora de grabación (30 min - 4 horas).

- La videograbadora termina la grabación a una hora programada.

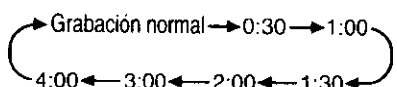

Programación fácil para la grabación con temporizador

1 Exhiba FIJAR PROGRAMACION.

Presione PROG/VCR+.

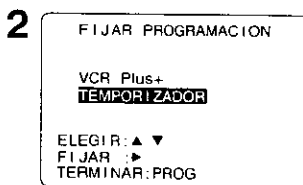

Exhiba "TEMPORIZADOR".

- 1) Presione ▲▼ para seleccionar.
- 2) Presione ► para exhibir.

- Si ya existe un programa en la memoria, presione ▲▼ y ► para seleccionar un número de programa sin usar.

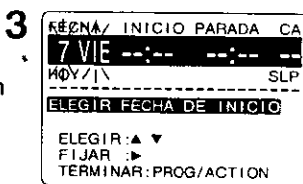

Ajuste la fecha de grabación.

- 1) Presione ▲▼ para seleccionar.
- 2) Presione ► o ◀ para ajustar.

- 1-31 = Grabación única
- DIARIO = a la misma hora de lunes a viernes
- SEMANA = a la misma hora una vez a la semana

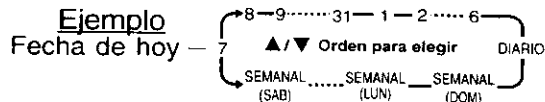

Repita el paso 3 para ajustar: hora de comienzo, hora de parada, canal (o LINEA para una fuente exterior), velocidad (SP, LP, SLP).

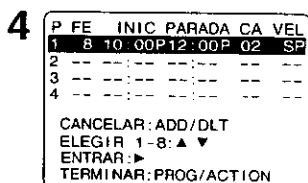

Termine el programa.

- 1) Presione PROG/VCR+ (o ACTION).

Para introducir más programas, presione ▲▼ y ► para seleccionar y ajustar el número de programa en blanco. Luego repita los pasos 3 y 4.

- 2) Presione PROG/VCR+ (o ACTION) para salir.



Pantalla multifuncional

Grabación con temporizador.

Presione POWER para apagar.

- Si la fuente de la grabación es una caja de TV por cable, asegúrese de que la caja de TV por cable esté encendida y esté sintonizada al canal que desea grabar.

Location of Controls

Remote control Buttons

EJECT

See page 8.

POWER

See page 6.

VCR mode

See page 18.

VCR/ TV

See page 9.

PLAY

See page 8.

SELECT UP

See page 7.

REWIND/ SEARCH

See page 8.

SET

See page 7.

ACTION

See page 28.

NUMBERED KEYS

See page 9.

COUNTER RESET

See page 23.

PAUSE/ SLOW

See page 8.

CM SKIP

See Page 23.

SAP/ Hi-Fi

See page 25.

VOLUME UP/ DOWN

See page 18.

SHUTTLE Ring

See page 27.

DISPLAY

See page 32.

TV mode

See page 18.

DSS/ CABLE mode

See page 18.

INPUT

See page 11.

FAST FORWARD/ SEARCH

See page 8.

SET

See page 7.

STOP

See page 8.

SELECT DOWN

See page 7.

PROGRAM/ VCR+

See pages 12, 13, 17.

ADD/ DELETE

See page 29.

TAPE POSITION

See page 26.

SEARCH/ ENTER

See pages 20-23.

SPEED

See page 9.

RECORD

See page 9.

CHANNEL UP/ DOWN

See page 9.

TRACKING/ V-LOCK

See page 31.

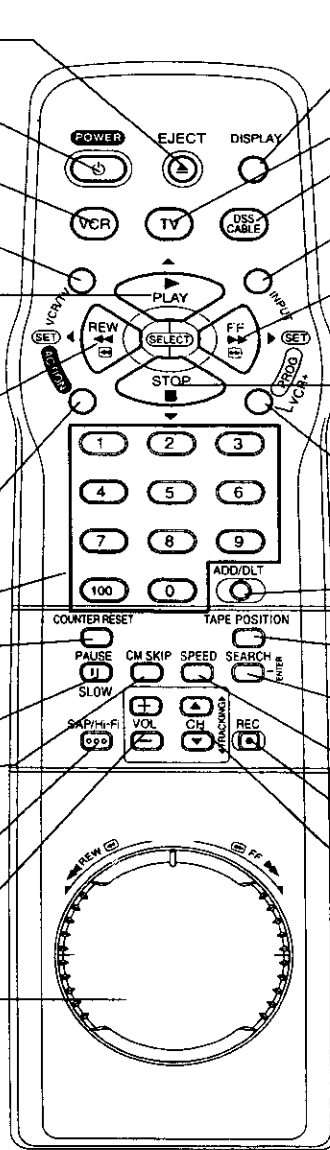

EJECT button: When EJECT is pressed, the tape is ejected from the Cassette Compartment.
If EJECT is pressed during recording, the VCR will not respond to the command.

Front View of the VCR

VCR/TV selector
See page 9.

Cassette Compartment
See page 8.

PLAY See page 8.

POWER
See page 6.

FAST FORWARD/ SEARCH
See page 8.

REWIND/ SEARCH
See page 8.

CHANNEL UP/ DOWN See page 9.

Remote Sensor

STOP/ EJECT See page 8.

RECORD
See page 9.

TRACKING/ V-LOCK See page 31.

ACTION/ PROG See page 7.

Multi Function Display

VCR Indicator

Lights when the VCR/TV selector is set to VCR.

Hi-Fi Indicator

Lights when Hi-Fi audio is monitored or play back.

Power Indicator

Lights when power is on.

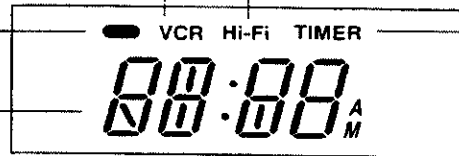

Timer Indicator

Lights when the VCR is set for a Timer Recording, or when a length is set for a normal recording (OTR). Flashes when a Timer Recording is set, but a tape has not been inserted into the VCR.

Clock/ Status/ Channel/ Speed Display

Displays the current time. Briefly displays VCR status when a function button is pressed. Briefly displays the channel number, or "L" when a channel or line input is selected. Briefly displays the recording speed when SPEED is pressed.

Rear View of the VCR

AC Power Plug

While plugged into an AC outlet, the VCR consumes 3.3 W of electrical power in off condition.

Audio Input Connector (L/R)

See page 11.

Video Input Connector

See page 11.

Audio Output Connector (L/R)

See pages 4, 11.

VHF/UHF Antenna Input Terminal

See pages 4, 10.

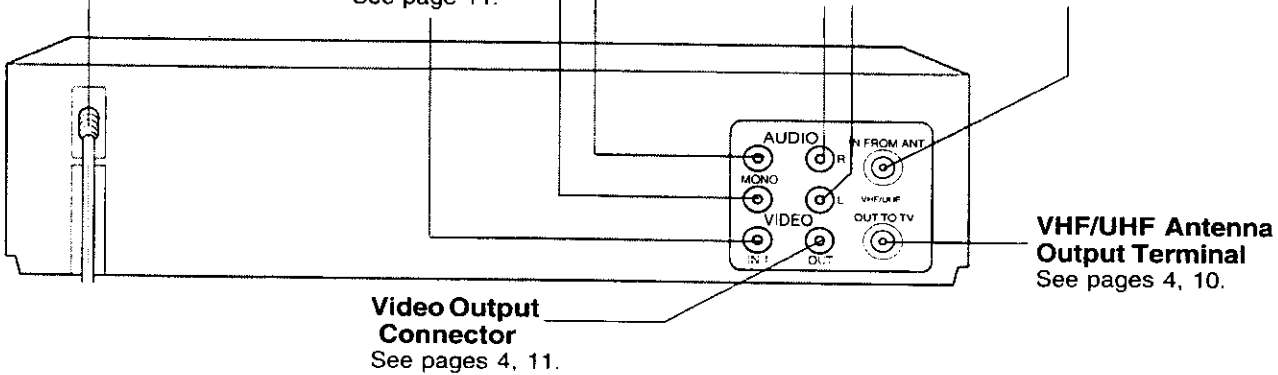

Video Output Connector

See pages 4, 11.

VHF/UHF Antenna Output Terminal

See pages 4, 10.

Quick Use Guide

1 Make all connections (page 4).

Connect VCR and TV with AV Cable (not supplied) or RF Coaxial Cable (supplied) as shown below. To use your TV as a VCR monitor, set the VIDEO/TV selector on the TV (Monitor/Receiver) to "VIDEO." Use the L Audio OUT jack for proper sound reproduction when connecting to a monaural TV.

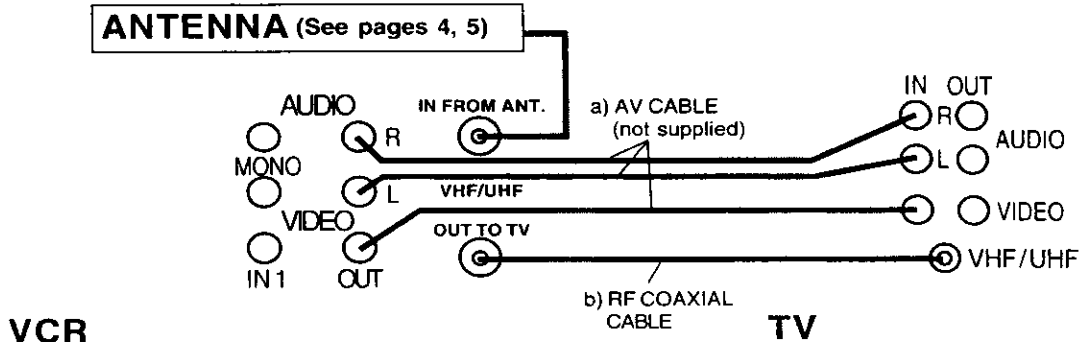

Notes

- 1) While connection b) (above) is sufficient, connection a) offers better sound and picture (especially with this model, you can enjoy Hi-Fi STEREO sound).
- 2) For both connections a) and b) proceed as follows:
 - To use VCR : VCR Power on, set TV to VIDEO.
 - To watch TV : VCR Power off, select channel on.
- 3) When using connection b) (see page 4), tune to VCR's output channel.
- 4) Set VCR Output to channel 3 or 4 (not an active station). (See page 6.)

Playback a Tape

2 Insert a tape.

Insert a tape

Press **PLAY**
(Starts playback)

- Or, if tape has no record tab, auto playback begins.

LIBRARY:
 Received _____
 Checked _____
 Entered _____
 LIS _____ NRPS _____

Record on a Tape

2 Do "One Time VCR Setup" on page 6.
 In order for the VCR to properly interface with your equipment, some setup is necessary.

3 Record on a Tape.

Insert a tape with Record Tab

Press **CH Up/Down**.
(Select Channel)

Press **SPEED**.
(Change speed)

Press **REC**.
(Starts Recording)

