

Panasonic®

Color Television Operating Instructions

CT-27D10

CT-32D10

CT-27D10U

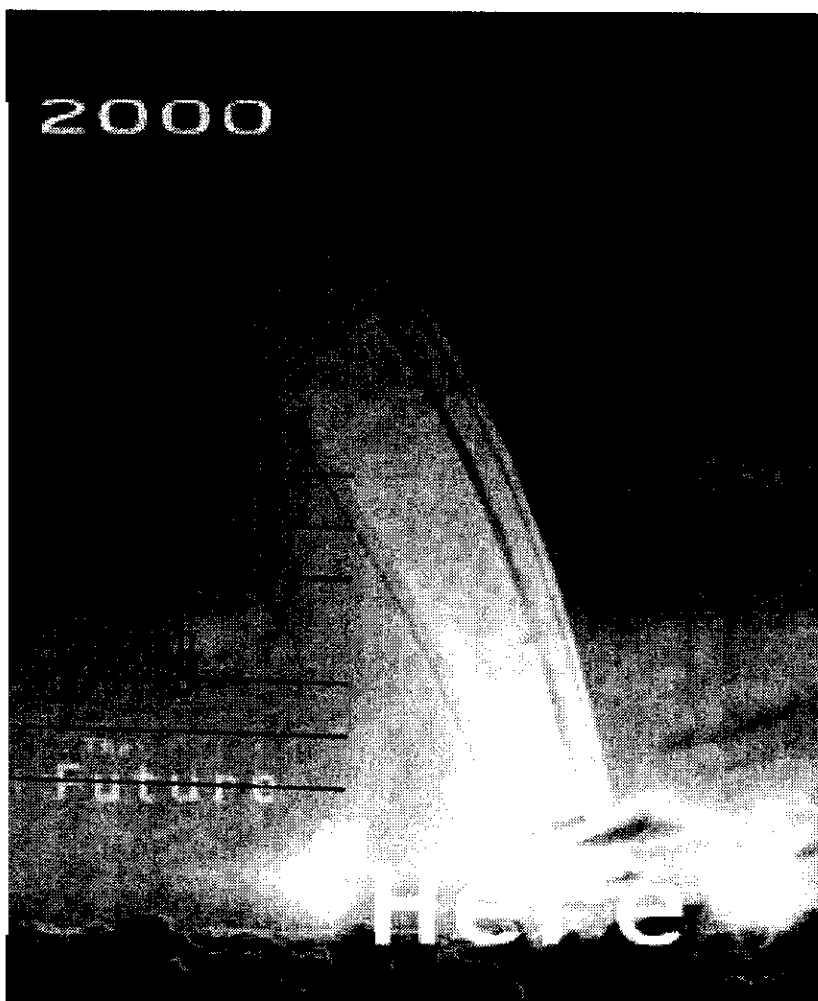

CT-32D10U



ISSUE 0

For assistance, please call: 1-800-211-PANA (7262) or
send e-mail to: consumerproducts@panasonic.com (USA only)

TQB2AA0331 00308
PRINTED IN USA

	WARNING RISK OF ELECTRIC SHOCK DO NOT OPEN	
WARNING: To reduce the risk of electric shock do not remove cover or back. No user-serviceable parts inside. Refer servicing to qualified service personnel.		



The lightning flash with arrow head within a triangle is intended to tell the user that parts inside the product are a risk of electric shock to persons.



The exclamation point within a triangle is intended to tell the user that important operating and servicing instructions are in the papers with the appliance.

WARNING: To prevent fire or shock hazard, do not expose this appliance to rain or moisture.

TABLE OF CONTENTS

Table of Contents

Congratulations3
 Customer Record3
 Care and Cleaning3
 Specifications3
Installation.....4
 Television Location.....4
 Optional Cable Connections.....4
 AC Power Supply Cord4
 Cable / Antenna Connection4
Optional Equipment Connections.....5
 VCR Connection.....5
 Amplifier Connection (To Audio Amp)5
Main Menu6
 ACTION Button7
 CH / VOL Buttons.....7
 Remote Control Guide.....7
Main Menu Feature Chart.....7
Special Features 10
 Menu Languages.....10
 Program Channels10
 Sleep Timer11
 Timer 1 and Timer 2.....11
 Other Adjustments (Picture)12
 Favorite Channels and Caption.....12
 Mode (Lock)13
Digital TV - Set-Top (DTV-STB) Connection..... 14
Glossary 15
Frequently Asked Questions About Digital TV 16
Troubleshooting Chart..... 17

Read these instructions completely before operating TV.

Contents are subject to change without notice or obligation.

Copyright 2000 by Matsushita Electric Corporation of America. All rights reserved.
Unauthorized copying and distribution is a violation of law.

Congratulations

Your new TV features a solid state chassis that is designed to give you many years of enjoyment. It was thoroughly tested and tuned at the factory for best performance.

Customer Record

The model and serial number of this product are located on the back of the TV. You should note the model and serial number in the space provided and retain as a permanent record of your purchase. This will aid in identification in the event of theft or loss. Product registration for U.S. customers is available at: www.prodreg.com/panasonic.

Model
Number

Serial
Number

Care and Cleaning

Screen (Turn TV Off)

- Use a mild soap solution or window cleaner with a soft clean cloth. DO NOT USE ABRASIVE CLEANERS.
- Avoid excessive moisture and wipe dry.

Note: Do not spray any type of cleaning fluid directly on the screen.

Cabinet and Remote Control

- For cabinets and remote control, use a soft cloth dampened with water or a mild detergent solution. Avoid excessive moisture and wipe dry.
- Do not use benzene, thinner or other petroleum based products.

Specifications

Power Source CT-27D10 (2.0A) CT-27D10U (2.0A) CT-32D10 (2.1A) CT-32D10U (2.1A)	120V AC, 60Hz
Channel Capability - 181	VHF-12; UHF-56; Cable-125
2 Video Input Jacks	1Vp-p, 75 Ohm, Phono Jack Type
4 Audio Input Jacks	500mV RMS 47K Ohm
1 Component Input (Y / P_B / P_R)	75 Ohm, Phono Jack Type
S-Video Input Jacks	S-Video (Y-C) Connector

Specifications are subject to change without notice or obligation.

INSTALLATION

Installation

Television Location

This unit is intended to be used with an optional stand or entertainment center. Consult your dealer for available options.

- Avoid excessive sunlight or bright lights, including reflections.
- Keep away from excessive heat or moisture. Inadequate ventilation may cause internal component failure.
- Fluorescent lighting may reduce remote control transmitting range.
- Keep away from magnetic equipment, including motors, fans and external speakers.

Optional Cable Connections

Shielded audio and video cables should be used between components. For best results:

- Use 75-ohm coaxial shielded cables.
- Use appropriate input and output connectors, that match your component connectors.
- Avoid long cables to minimize interference.

AC Power Supply Cord

CAUTION: TO PREVENT ELECTRIC SHOCK MATCH WIDE BLADE OF PLUG TO WIDE SLOT OF AC OUTLET AND FULLY INSERT. DO NOT USE A PLUG WITH A RECEPTACLE OR OTHER OUTLET UNLESS THE BLADE CAN BE FULLY INSERTED TO PREVENT BLADE EXPOSURE. FOR SOME MODELS THAT ARE NON-POLARIZED, THE USE OF AN AC ADAPTOR CONNECTOR MAY BE NECESSARY.



Polarized plug

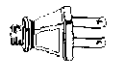

Non-Polarized plug

Cable / Antenna Connection

For proper reception, either a cable or antenna connection is required.

Cable Connection

Connect the cable supplied by your local cable company.

Note: A cable converter box may be required for proper reception. Check with your local cable company for compatibility requirements.

Incoming Cable from Cable Company





75 Ohm VHF/UHF on back of TV

Antenna Connections

- For proper reception of VHF/UHF channels, an external antenna is required. For best reception an outdoor antenna is recommended.
- Antenna Mode must be set to TV.

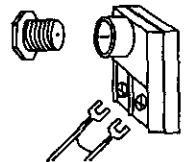
Incoming Cable from Home Antenna



 **Cable Preset**

Cable Mode is preset at the factory. Antenna users must change to Antenna Mode in the Setup Menu.

Optional Equipment Connections

VCR Connection

VCRs, video disc players, video game equipment, and DSS equipment can also be connected to the video inputs. See the optional equipment manual for more information.

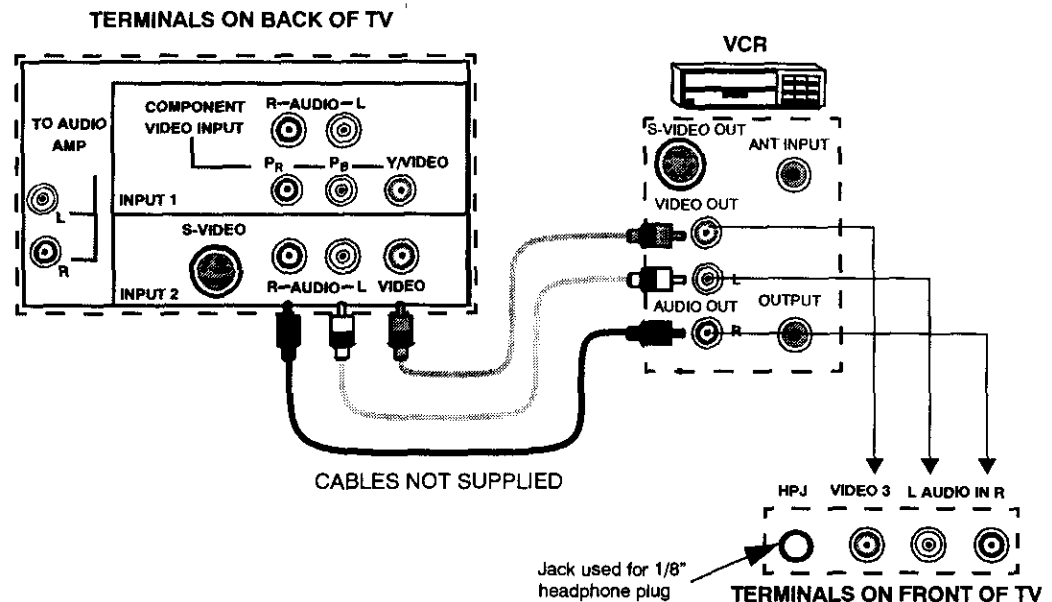

Procedure

1. Connect equipment as shown to front or rear Audio/Video input jacks.
- Note:* Front and rear Audio/Video connectors cannot be operated at the same time.
2. Select the Video mode by pressing TV/VIDEO button.
3. Operate optional equipment as instructed in equipment manual.

Amplifier Connection (To Audio Amp)

Connect to an external audio amplifier input for listening to a stereo system.

Note: TO AUDIO AMP terminals cannot be connected directly to external speakers.

Audio Adjustments

1. Select TV SPEAKERS ON from AUDIO menu.
2. Set amplifier volume to minimum.
3. Adjust TV volume to desired level.
4. Adjust amplifier volume to match the TV.
5. Select TV SPEAKERS OFF&VAO from AUDIO menu.
6. Volume, mute, bass, treble and balance are now controlled from the TV.

Note: In OFF&FAO the volume is controlled by the external amplifier.

MAIN MENU

Main Menu

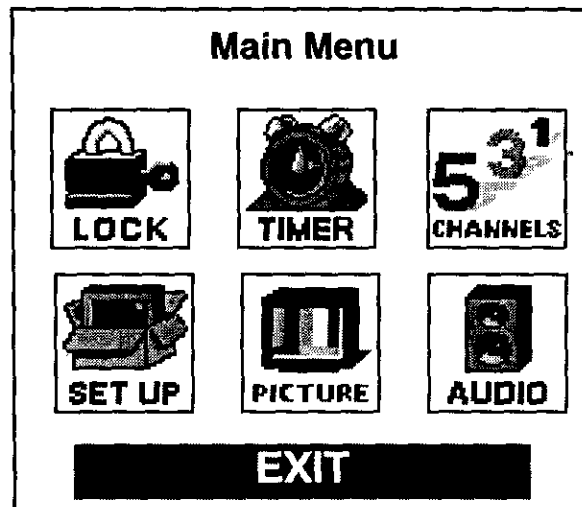

ACTION Button

Press the **ACTION** button to display the Main Menu and submenus. Press the **ACTION** button repeatedly to exit.

CH / VOL Buttons

Press the **CH** (channel) or **VOL** (volume) buttons to select an icon. Use the **CH** buttons to highlight the desired features. Use **VOL** buttons to select and adjust features.

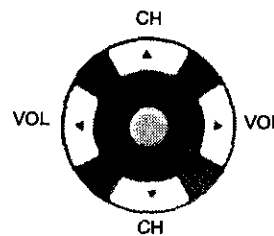

Remote ACTION / Navigation Button



Remote Control Guide



The **Remote Control Quick Reference Guide** is located within the package provided with this TV.

Main Menu Feature Chart

MENU	DESCRIPTION
	<p align="center">SET UP</p>
<p>LANGUAGES</p>	<p><input type="checkbox"/> Select English, Spanish, or French menu.</p>
<p>PROG. CHAN (Program Channels)</p>	<p><input type="checkbox"/> MODE - Select Cable or TV. See Installation section in manual.</p> <p><input type="checkbox"/> AUTO PROGRAM - Automatically program channels having a signal into memory.</p> <p><input type="checkbox"/> MANUAL PROGRAM - Manually add or delete channels from memory.</p>
<p>CC (Closed Captioning)</p>	<p><input type="checkbox"/> CC ON MUTE - Activate C1-C2 for Closed Captioning display when the remote MUTE button is pressed.</p> <p><input type="checkbox"/> CC MODE - Select C1 or C2 for Closed Captioning, program guides and other information.</p>
<p>OTHER ADJ.</p>	<p><input type="checkbox"/> AUTO POWER ON - Select SET to power up the TV at the same time as the Cable Box or other components or select OFF.</p>
	<p align="center">AUDIO</p>
<p>AUDIO ADJ. (Adjustments)</p>	<p><input type="checkbox"/> MODE - Select STEREO, SAP (Second Audio Program) or MONO. (Use MONO when stereo signal is weak.)</p> <p><input type="checkbox"/> BASS - Increase or decrease the bass response.</p> <p><input type="checkbox"/> TREBLE - Increase or decrease the treble response.</p> <p><input type="checkbox"/> BALANCE - Emphasize the left/right speaker volume.</p> <p><input type="checkbox"/> NORMAL - Reset BASS, TREBLE and BALANCE to factory default.</p>
<p>OTHER ADJ. (Adjustments)</p>	<p><input type="checkbox"/> AI SOUND - Automatically adjust volume to maintain a comfortable listening level. (AI sound is not available in VIDEO mode).</p>
<p>SURROUND</p>	<p><input type="checkbox"/> Enhances audio response when listening to stereo.</p>
<p>SPEAKERS</p>	<p><input type="checkbox"/> ON - TV speakers operate normally.</p> <p><input type="checkbox"/> OFF & VAO (Variable Audio Output) - TV speakers off - audio adjustable by TV.</p> <p><input type="checkbox"/> OFF & FAO (Fixed Audio Output) - TV speakers off - audio adjustable only by the external amplifier.</p>

MAIN MENU FEATURE CHART

Main Menu Feature Chart (Cont.)

MENU	DESCRIPTION
	TIMER
CLOCK SET	<input type="checkbox"/> Set the time and the day of the week. (Time will display onscreen after turning on the television, pressing the RECALL button or changing channels).
SLEEP	<input type="checkbox"/> Set timer to turn off TV in 30, 60 or 90 minutes. Select NO to turn timer off.
TIMER 1 TIMER 2	<input type="checkbox"/> Set one or both timers to automatically turn television on and off at selected times, on selected channels, and on selected days. (Clock must be set to use Timer features).
	PICTURE
VIDEO ADJ. (Adjustments)	<input type="checkbox"/> COLOR - Adjust desired color intensity. <input type="checkbox"/> TINT - Adjust natural flesh tones. <input type="checkbox"/> BRIGHTNESS - Adjust dark areas for crisp detail. <input type="checkbox"/> PICTURE - Adjust white areas of picture. <input type="checkbox"/> SHARPNESS - Adjust clarity of outline detail. <input type="checkbox"/> NORMAL - Reset all picture adjustments to factory default settings.
OTHER ADJ. (Adjustments)	<input type="checkbox"/> COLOR TEMP - Adjust white balance to COOL (blue), WARM (red) or NORMAL..
	CHANNELS
FAVORITES	<input type="checkbox"/> CHANNEL SCAN - Select FAV (16 favorites) or ALL channels to scan channels using the up/down CH buttons.
CAPTION	<input type="checkbox"/> MANUAL CAPTION - Enter channel numbers and captions manually. <input type="checkbox"/> INPUT LABEL - Label video connections for onscreen display of optional equipment.

Main Menu Feature Chart (Cont.)

MENU	DESCRIPTION
 <p>LOCK</p>	<p>LOCK</p>
<p>MODE</p>	<p><input type="checkbox"/> Lock All Channels or Game with a secret code.</p> <p><i>Note: For more information about Block Programs, see the V-CHIP Parental Lock manual provided with the TV package.</i></p>
<p>HOW LONG?</p>	<p><input type="checkbox"/> Select the period of time (12, 24, 48 hours or ALWAYS) for your option to be locked.</p>

SPECIAL FEATURES

Special Features

SET UP

Menu Languages

In SET UP Menu, select IDIOMA / LANGUE to change menu language to ENGLISH, ESPAÑOL (Spanish), or FRANÇAIS (French).

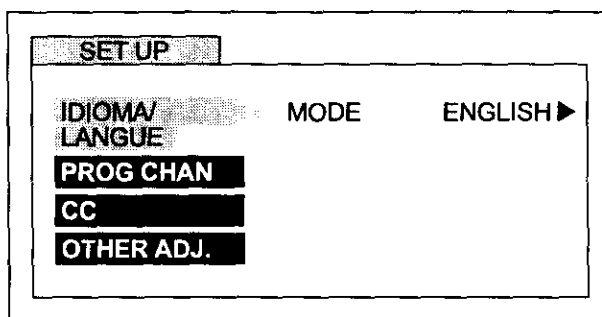

Prog Chan (Program Channels)

In SET UP menu under PROG CHAN select:

- MODE to select TV (antenna) or CABLE mode depending on the signal source.
- AUTO PROGRAM to automatically program all channels with a signal.
- MANUAL PROGRAM to manually add or delete channels.

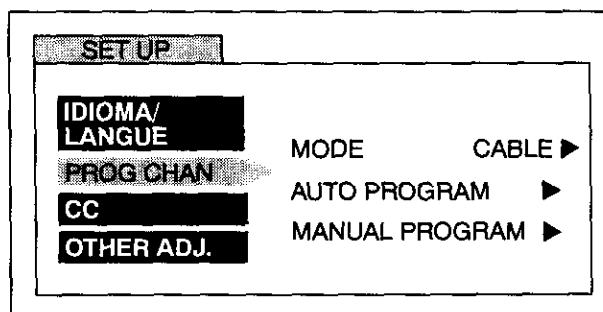

TIMER

Sleep

In **TIMER** menu, select **SLEEP** to turn TV off in 30, 60 or 90 minutes. Select **NO** to turn off timer.

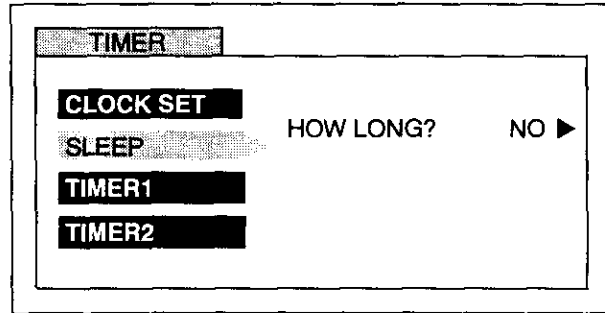

Timer 1 and Timer 2

In **TIMER** menu, select one or both timers to turn the television on and off at selected times, on selected channels, and on selected days.

Note: *TIME must be entered in CLOCK SET to operate TIMER features.*

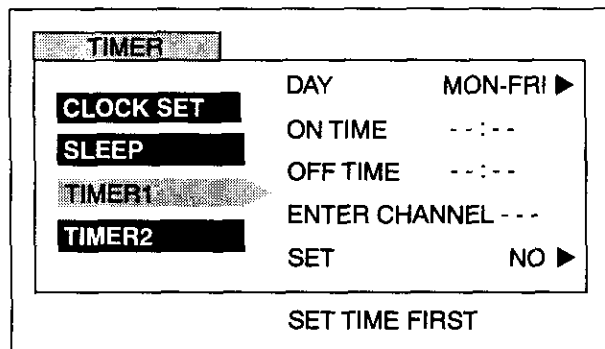

Turn Off After 90 Minutes

The TV automatically turns OFF after 90 minutes when turned on by the **TIMER**. If the **OFF** time is selected or if a key is pressed, the automatic OFF after 90 minutes will be cancelled.



TIMER Activation

The **TIMER** is active when the TV is OFF or ON. The TV will switch to the selected channel at the selected time set in the **TIMER**.

SPECIAL FEATURES

PICTURE

Other Adjustments

In Picture menu under OTHER ADJ. select:

- COLOR TEMP to increase and decrease WARM (red) and COOL (blue) colors to suit personal preferences

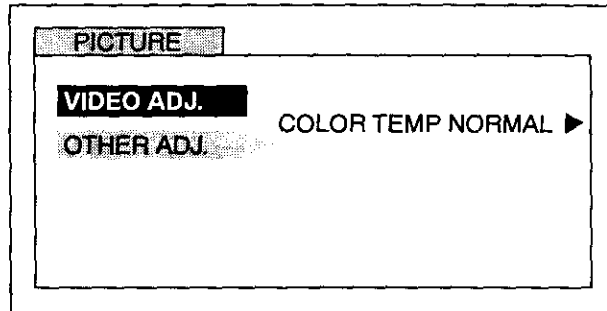

CHANNELS

Favorites

In CHANNELS menu under FAVORITES select:

- CHANNEL SCAN FAV to enter up to 16 favorite channels.
- CHANNEL SCAN ALL to scan all channels when using the CH up/down buttons.

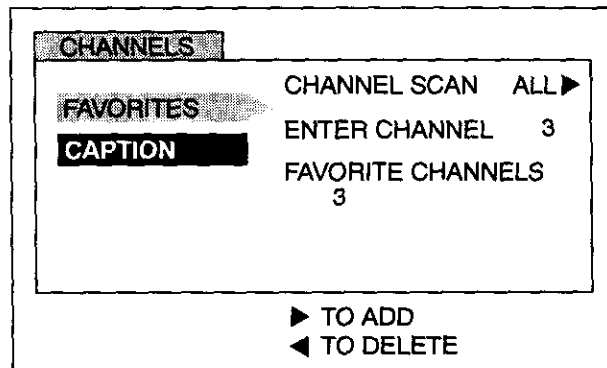

Caption

In CHANNELS menu under CAPTION select:

- MANUAL CAPTION to enter numbers and captions manually.
- INPUT LABEL to label video input connections for onscreen display.

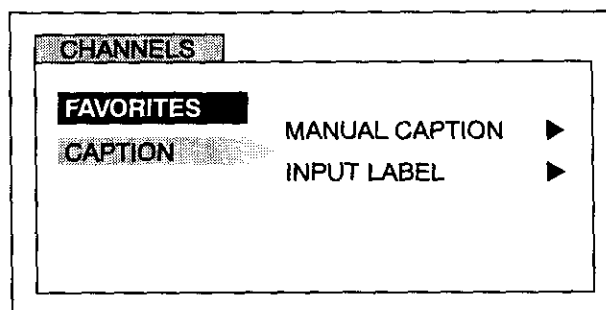

LOCK

MODE

To use LOCK options:

- ENTER CODE FIRST - Use the numeric keypad to enter a four-digit secret code. After entering your secret code for the first time, the onscreen display will change to CHANGE CODE.

Note: Use a code that is easy to remember or record it in a safe place.

In MODE submenu select:

- LOCK SET to choose:
 - OFF - To turn lock function off.
 - ALL - To lock all channels and video inputs.
 - CHANNEL - To lock up to four channels of your choice.
 - GAME - To lock channels 3, 4 and video inputs.
- BLOCK PROGRAMS^{*} - To use Block Programs Ratings.
- CHANGE CODE - Use numeric keypad to change your four-digit secret code.

Note: If in CHANGE CODE you enter a different code from the one used previously, the new code becomes the controlling code.

Press the **ACTION** button to return to submenu, then select HOW LONG to choose the period of time you want your option to be locked (12, 24, 48 hours or ALWAYS).

Note: Be cautious when selecting ALWAYS. If ALWAYS is selected, and you forget your secret code, the television must be serviced by a qualified technician in order to clear the LOCK setup.

Press the **ACTION** button to return to submenu, and to exit menus.

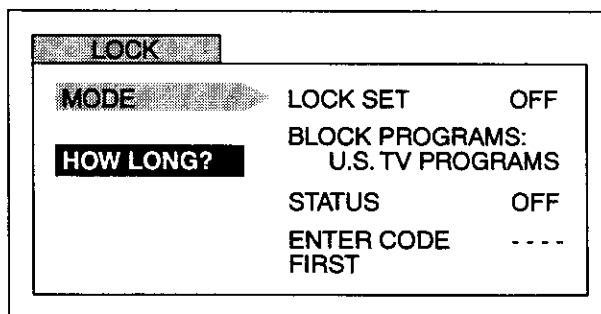

Note: If GAME, CHANNEL or ALL is selected, and if a blocked channel or video input is selected, the message PG (Parent Guard) displays in the upper right corner of the television screen

Unlock LOCK SET by reentering the same four-digit secret code and selecting OFF.

***For more information about Block Programs, see the V-CHIP Parental Lock manual provided with the TV package.**

DIGITAL TV - SET-TOP BOX (DTV-STB) CONNECTION

Digital TV - Set-Top Box (DTV-STB) Connection

Use this diagram to connect the Panasonic DTV-STB (Digital TV-Set-Top Box) to the back of your TV.

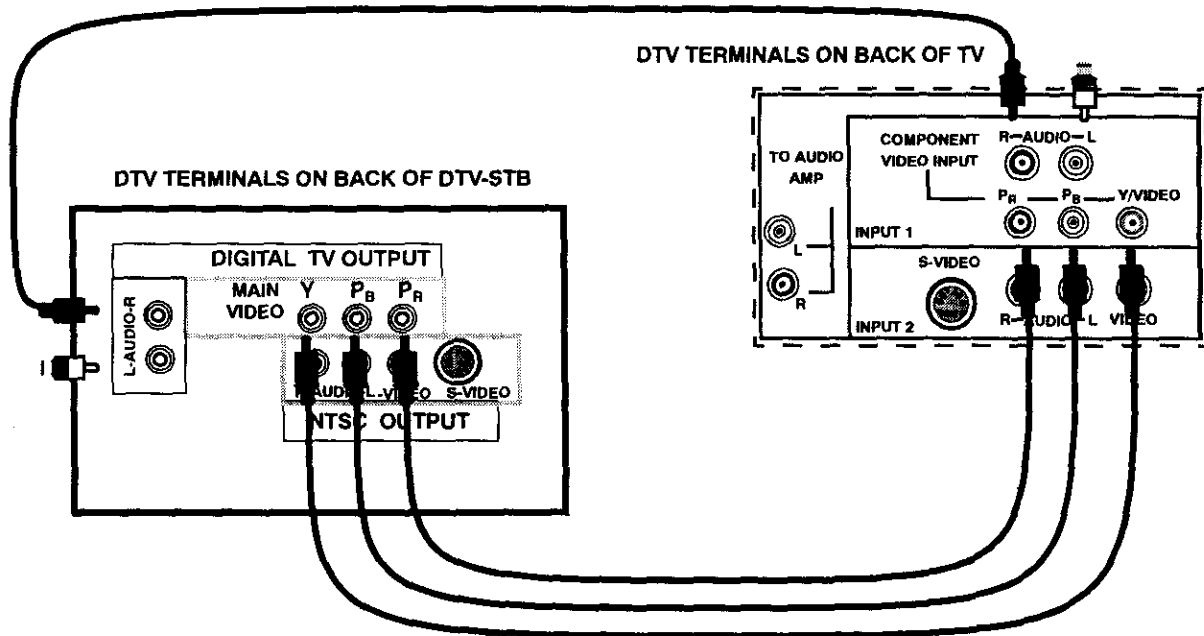

Note: There are three video inputs, Y, P_B, and P_R. Separate component color inputs provide luminance and color separation. Use the L (left) and R (right) audio inputs.

Glossary

Digital Television

Digital Television (DTV) broadcasts are now available in 10 major U.S. markets. Broadcasts are in both high definition (HDTV) and standard definition (SDTV). The HDTV signal formats are 1080i (interlaced scan) and 720p (progressive scan). SDTV signal formats are 480i and 480p.

SDTV-Compatible (480p/480i)

SDTV-compatible TV models process and display the standard definition output with the use of a Panasonic DTV-STB at 480 lines, interlaced or progressive scan. When DTV programming is available, you can view it in the standard format, either 4:3 aspect ratio or 16:9 aspect ratio.

DTV Compatibility

This TV is capable of displaying only the 480p/480i SDTV signal using the Panasonic DTV-STB. In order to view DTV programming, the STB must be connected to the TV component video inputs (Y, P_B, P_R) and audio inputs and in DTV mode. A DTV signal must be available in your area and the DTV-STB must be tuned to the proper channel.

Progressive Scan

Progressive scan de-interlaces the incoming signal and progressively scans the image. This allows you to sit very close to the TV and not see the thin black horizontal scan lines (venetian blind effect) associated with an interlaced picture.

FREQUENTLY ASKED QUESTIONS ABOUT DIGITAL TV

Frequently Asked Questions About Digital TV

What is digital TV (DTV)?

In April 1997, the FCC (Federal Communications Commission) announced that by 2006, all television broadcasting will be digital. Digital TV broadcasting delivers crystal-clear pictures, approaching the quality of 35mm movies and CD (compact disc) sound. Digital broadcasts include both High Definition Television (HDTV) and Standard Definition Television (SDTV). Broadcasters may choose their own broadcast formats.

HDTV (High Definition Television)

One form of digital broadcasting is HDTV, which provides the highest resolution picture. Besides incredible picture, the sound is available in the 5.1 channel surround sound.

SDTV (Standard Definition Television)

Another form of digital broadcasting is SDTV, which provides lower resolution, but still presents a very sharp, clear picture. Lower resolution allows broadcasters to transmit more than one program per channel.

When will TV stations start broadcasting digital signals?

Television stations are required to continue broadcasting regular TV signals alongside the digital signals until 2006. Cable TV and satellite TV are not affected by this FCC ruling.

All stations are required to become digital by 2006. This will be an evolutionary process. According to the FCC, digital broadcasting must be available in the top ten markets, covering 30% of households by May 1999. By the end of 1999, digital broadcasting must be available in the top 30 markets, covering 50% of households.

Will I be able to adapt my current TV to receive digital broadcasts?

Manufacturers will offer a digital TV set-top box (DTV-STB) which will allow current televisions to display digitally broadcast programs. The picture and sound quality will be about the same as small dish digital satellite systems today.

Conventional televisions (non-digital televisions) will not be able to display the HDTV resolution quality or sound.



















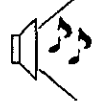

What digital formats will broadcasters use?

There are presently four DTV formats: 1080i (interlaced), 720p (progressive), 480i and 480p. The higher numbers indicate a higher resolution picture.

In an interlaced picture, the odd numbered lines (picture information) are scanned first creating field 1 and then the even numbered lines are scanned, creating field 2. The two fields are then interlaced to provide the entire image (one frame). This process happens in 1/30th of a second and is invisible to the human eye. In progressive scanning, all lines in the entire frame are scanned sequentially in 1/60th of a second. Broadcasters may choose to transmit different levels of resolution throughout the day, broadcasting day programs in SDTV and night sports and movies in HDTV.

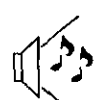
Troubleshooting Chart

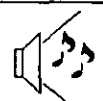
Before calling for service, determine the symptoms and follow suggested solutions.

AUDIO	VIDEO	Solutions
 Noisy Audio	 Snowy Video	Adjust Antenna Location and Connection
 Noisy Audio	 Multiple Image	Adjust Antenna Location and Connection Check Antenna Lead-in Wire
 Noisy Audio	 Interference	Move TV from Electrical Appliances, Lights, Vehicles, and Medical Equipment
 No Audio	 Normal Video	Increase Volume Check Mute Check TV SPEAKERS on/off Change Channel
 Noisy Audio	 No Video with Snow	Set TV or Cable Mode Properly Check Antenna Cables
 No Audio	 No Video / No PIP	Check Power Cord is Plugged into Active Outlet Adjust Brightness and Audio Controls Change Channel Check Cable Connections Program the Remote Control Again Check Second Video Source Operation
 Normal Audio	 No Color	Adjust Color Settings Change Channel
 Wrong Audio	 Normal Video	Check Audio Is Set To Stereo Or Mono, Not SAP
 Normal Audio	 Black Box on Screen	Change CC (Closed Captioning) from Text Mode
 Normal Audio	 Normal Video	Replace Remote Control Batteries
Intermittent Remote Control Operation		

NOTES

NOTES

**Panasonic Consumer Electronics Company,
Division of Matsushita
Electric Corporation of America**
One Panasonic Way
Secaucus, New Jersey 07094
www.panasonic.com
(800) 222-4213

Panasonic de Mexico, S.A. de C.V.
Amores No. 1120
Col. Del Valle C.P. 03100
México, D.F.
Tel. (915 ó 015) 488-1000
Fax (915 ó 015) 575-6763, 575-6765

**Panasonic Sales Company,
Division of Matsushita Electric
of Puerto Rico Inc. ("PSC")**
Ave. 65 de Infantería, Km 9.5
San Gabriel Industrial Park
Carolina, Puerto Rico 00985
Tel. (787) 750-4300
Fax (787) 768-2910