

JVC[®]

COLOR TELEVISION USER'S GUIDE

***For models:
AV-36150
AV-36120
AV-32150
AV-32120
AV-32115
AV-27150***

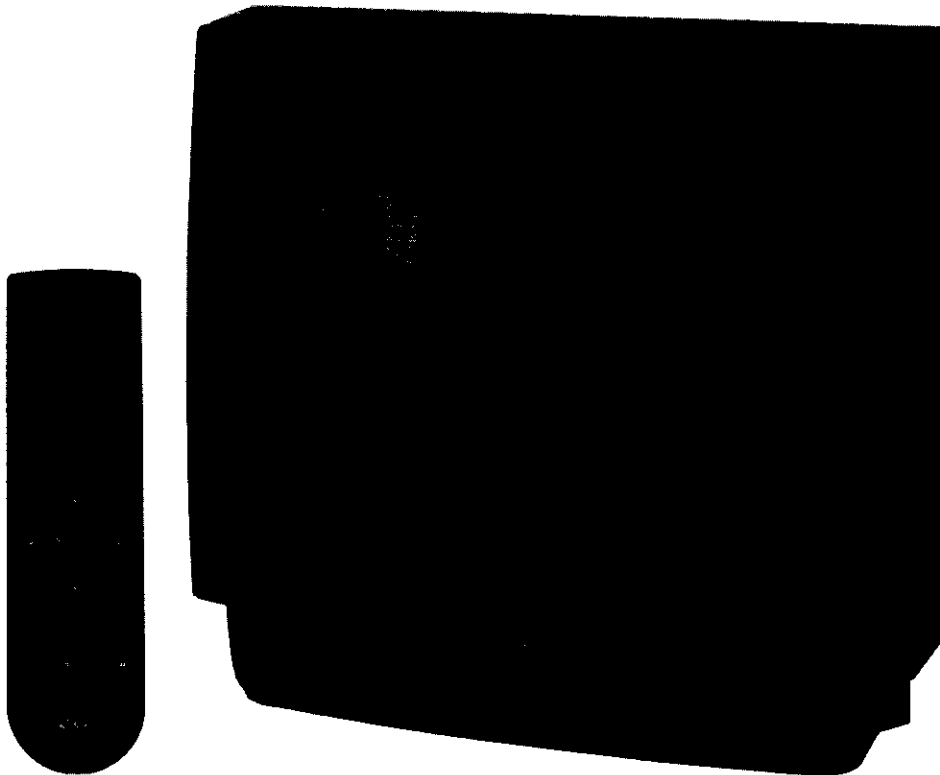

Illustration of AV-27150 and RM-C382

IMPORTANT NOTE TO THE CUSTOMER

In the spaces below, enter the model and serial number for your television (located at the rear of the television cabinet).
Staple your sales receipt or invoice to the inside cover of this guide.
Keep this user's guide in a convenient place for future reference.
Keep the carton and original packaging for future use.

Serial Number

Model Number

IMPORTANT SAFETY PRECAUTIONS

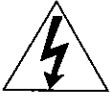

CAUTION
RISK OF ELECTRIC SHOCK
DO NOT OPEN



CAUTION: To reduce the risk of electric shock.
Do not remove cover (or back).
No user serviceable parts inside.
Refer servicing to qualified service personnel.

 The lightning flash with arrowhead symbol, within an equilateral triangle is intended to alert the user to the presence of uninsulated "dangerous voltage" within the product's enclosure that may be of sufficient magnitude to constitute a risk of electric shock to persons.

 The exclamation point within an equilateral triangle is intended to alert the user to the presence of important operating and maintenance (servicing) instructions in the literature accompanying the appliance.

WARNING: TO PREVENT FIRE OR SHOCK HAZARDS, DO NOT EXPOSE THIS TV SET TO RAIN OR MOISTURE.

CAUTION: TO INSURE PERSONAL SAFETY, OBSERVE THE FOLLOWING RULES REGARDING THE USE OF THIS UNIT.

1. Operate only from the power source specified on the unit.
2. Avoid damaging the AC plug and power cord.
3. Avoid Improper installation and never position the unit where good ventilation is unattainable.
4. Do not allow objects or liquid into the cabinet openings.
5. In the event of trouble, unplug the unit and call a service technician. Do not attempt to repair it yourself or remove the rear cover.

Changes or modifications not approved by JVC could void the warranty.

* When you don't use this TV set for a long period of time, be sure to disconnect both the power plug from the AC outlet and antenna for your safety.

* To prevent electric shock do not use this polarized plug with an extension cord, receptacle or other outlet unless the blades can be fully inserted to prevent blade exposure.

IMPORTANT SAFEGUARDS

CAUTION:

Please read and retain for your safety.

Electrical energy can perform many useful functions. This TV set has been engineered and manufactured to assure your personal safety. But *improper use can result in potential electrical shock or fire hazards.* In order not to defeat the safeguards incorporated in this TV set, observe the following basic rules for its installation, use and servicing.

And also follow all warnings and instructions marked on your TV set.

INSTALLATION

- 1 Your TV set is equipped with a polarized AC line plug (one blade of the plug is wider than the other).

(POLARIZED-TYPE)



This safety feature allows the plug to fit into the power outlet only one way. Should you be unable to insert the plug fully into the outlet, try reversing the plug.

Should it still fail to fit, contact your electrician.

- 2 Operate the TV set only from a power source as indicated on the TV set or refer to the operating instructions for this information. If you are not sure of the type of power supply to your home, consult your TV set dealer or local power company. For battery operation, refer to the operating instructions.
- 3 Overloaded AC outlets and extension cords are dangerous, and so are frayed power cords and broken plugs. They may result in a shock or fire hazard. Call your service technician for replacement.
- 4 Do not allow anything to rest on or roll over the power cord, and do not place the TV set where power cord is subject to traffic or abuse. This may result in a shock or fire hazard.
- 5 Do not use this TV set near water — for example, near a bathtub, washbowl, kitchen sink, or laundry tub, in a wet basement, or near swimming pool, etc.

- 6** If an outside antenna is connected to the TV set, be sure the antenna system is grounded so as to provide some protection against voltage surges and built-up static charges. Section 810 of the National Electrical Code provides information with respect to proper grounding of the mast and supporting structure, grounding of the lead-in wire to an antenna discharge unit, size of grounding conductors, location of antenna discharge unit, connection requirements for the grounding electrode.
- 7** An outside antenna system should not be located in the vicinity of overhead power lines or other electric light or power circuits, or where it can fall into such power lines or circuits. When installing an outside antenna system, extreme care should be taken to keep from touching such power lines or circuits as contact with them might be fatal.

EXAMPLE OF ANTENNA GROUNDING AS PER NATIONAL ELECTRICAL CODE

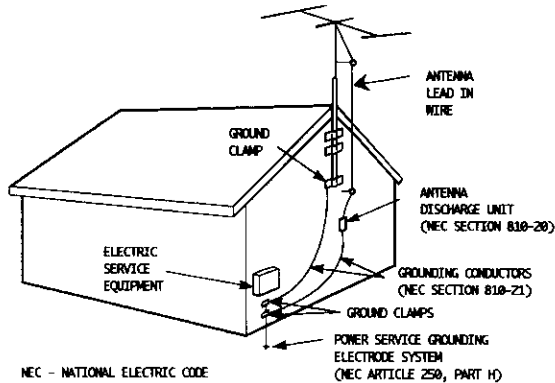

- 8** TV sets are provided with ventilation openings in the cabinet to allow heat generated during operation to be released. Therefore:
- Never block the bottom ventilation slots of a portable TV set by placing it on a bed, sofa, rug, etc.
 - Never place a TV set in a "built-in" enclosure unless proper ventilation is provided.
 - Never cover the openings with a cloth or other material.
 - Never place the TV set near or over a radiator or heat register.
- 9** To avoid personal injury:
- Do not place a TV set on a sloping shelf unless properly secured.
 - Use only a cart or stand recommended by the TV set manufacturer.
 - Do not try to roll a cart with small casters across thresholds or deep pile carpets.
 - Wall or shelf mounting should follow the manufacturer's instructions, and should use a mounting kit approved by the manufacturer.

USE

- 10** Caution children about dropping or pushing objects into the TV set through cabinet openings. Some internal parts carry hazardous voltages and contact can result in a fire or electrical shock.
- 11** Unplug the TV set from the wall outlet before cleaning. Do not use liquid or an aerosol cleaner.
- 12** Never add accessories to a TV set that has not been designed for this purpose. Such additions may result in a hazard.

- 13** For added protection of the TV set during a lightning storm or when the TV set is to be left unattended for an extended period of time, unplug it from the wall outlet and disconnect the antenna. This will prevent damage to product due to lightning storms or power line surges.
- 14** A TV set and cart combination should be moved with care. Quick stops, excessive force, and uneven surfaces may cause the TV set and cart combination to overturn.



SERVICE

- 15** Unplug this TV set from the wall outlet and refer servicing to qualified service personnel under the following conditions:
- A. When the power cord or plug is damaged or frayed.
 - B. If liquid has been spilled into the TV set.
 - C. If the TV set has been exposed to rain or water.
 - D. If the TV set does not operate normally by following the operating instructions. Adjust only those controls that are covered in the operating instructions as improper adjustment of other controls may result in damage and will often require extensive work by a qualified technician to restore the TV set to normal operation.
 - E. If the TV set has been dropped or damaged in any way.
 - F. When the TV set exhibits a distinct change in performance — this indicates a need for service.
- 16** Do not attempt to service this TV set yourself as opening or removing covers may expose you to dangerous voltage or other hazards. Refer all servicing to qualified service personnel.
- 17** When replacement parts are required, have the service technician verify in writing that the replacement parts he uses have the same safety characteristics as the original parts. Use of manufacturer's specified replacement parts can prevent fire, shock, or other hazards.
- 18** Upon completion of any service or repairs to this TV set, please ask the service technician to perform the safety check described in the manufacturer's service literature.
- 19** When a TV set reaches the end of its useful life, improper disposal could result in a picture tube implosion. Ask a qualified service technician to dispose of the TV set.
- 20** Note to CATV system installer.
This reminder is provided to call the CATV system installer's attention to Article 820-40 of the NEC that provides guidelines for proper grounding and, in particular, specifies that the cable ground shall be connected to the grounding system of the building, as close to the point of cable entry as practical.

WELCOME!

Congratulations on your new television purchase! We thank you for choosing JVC.

We know you are anxious to start watching your new television, but before you operate it, please read this guide and then keep it handy for future reference. After all you just bought a great TV with a lot of terrific features, you should know what each feature is and how to use it properly!

Please note, as you read through this guide there are illustrations of select models for your reference. There are several models covered in this guide and therefore each illustration may not be of the specific model you own. Be sure to look for the similar feature on your TV.

Again, congratulations and thank you for choosing JVC! Enjoy!

TABLE OF CONTENTS

CONNECTIONS

Connections Checklist	5
Front Panel Diagrams	5
Rear Panel Diagrams	5
Cable and VCR Connections	6
S-Video Connections	6
Connecting to a Camcorder	8
Connecting to External Amplifier	8
Connecting to JVC AV Compu Link Capable Components	9

GETTING STARTED

Remote Controls	10
Power	11
Adjusting Volume	11
Changing Channels	11
Remote Programming	12
CATV & Satellite Codes	12
VCR Codes	13

MENU FUNCTIONS

Using the Menu	14
Plug In Menu	
<i>Introduction</i>	15
<i>Language</i>	15
<i>Auto Tuner Setup</i>	15
<i>Set Clock</i>	16
<i>Auto (XDS)</i>	16
<i>Manual</i>	16
<i>Finish</i>	16
Channel Summary	17
V-Chip	18
<i>Set Lock Code</i>	21
Picture Settings	
<i>Tint</i>	22
<i>Color</i>	22
<i>Picture</i>	22
<i>Bright</i>	22
<i>Detail</i>	22
<i>Noise Muting</i>	22
<i>Set Video Status</i>	22

Menu Functions (Continued)

Sound Settings	
<i>Bass</i>	23
<i>Treble</i>	23
<i>Balance</i>	23
<i>MTS (Multi-channel TV Sound)</i>	23
<i>Some Sound Advice</i>	23
General Items	
<i>On/Off Timer</i>	24
<i>TV Speaker</i>	25
<i>Audio Out</i>	25
<i>Closed Caption</i>	25

BUTTON FUNCTIONS

Menu	26
Exit	26
Display	26
Video Status	26
Sleep Timer	26
Input	26
Hyper Surround	27
Muting	27
Number Buttons - 10 Key Pad	27
100+	27
Return+	27
VCR Buttons	27
PIP (Picture-In-Picture)	
<i>Introduction</i>	28
<i>On/Move</i>	28
<i>Freeze</i>	28
<i>Swap</i>	28
<i>Channel +/-</i>	28
<i>Source</i>	28

APPENDICES

Troubleshooting	29
Limited Warranty	30
Authorized Service Centers	31
Specifications	Back Cover

CONNECTIONS CHECKLIST - READ ME FIRST

The Connections Checklist section of this guide is a list of ideas to keep in mind while you setup your new TV. It is designed to help us not-so-technically-minded individuals make our connections properly. If you read this section and still can't identify the plugs, connectors and components you have, please ask someone for help in making your connections.

- 1) **Always refer to the connection instructions** in the user's guide for your components first. The manufacturer will provide the most detailed information about their products.
- 2) **Know your jacks and plugs** - most are color coded:
 - Yellow plugs are Video connections
 - Red plugs are Right Audio connections
 - White (or black) plugs are Left Audio (or Mono) connections. If your VCR is mono-sound, it will have only a white or black plug, no second red one.
- 3) **Perform one connection at a time.** If you have several accessories to connect, make sure each connection is correct by checking to see that it works properly before trying the next connection.
- 4) **Unplug the power cord** during each connection.
- 5) **Follow the In and Out Concept.** Remember In and Out - the Output jack from one device will go to the Input jack of the other. Read the jack panels, they are all labeled.
- 6) **The AV Compu Link Cable** is supplied with certain JVC devices. If you have a JVC Compu Link VCR or other piece of equipment, but don't have an AV Compu Link cable, contact your local JVC dealer.

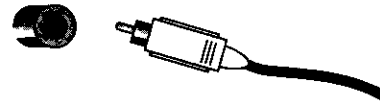

AV Input Plug



RF Connectors



S-Video Plug



AV Compu Link Cable

Front/Rear Panel Diagrams

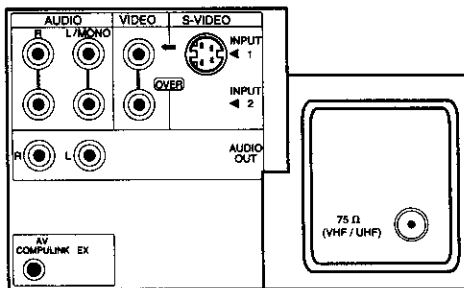

Rear Panel - All models except AV-32115

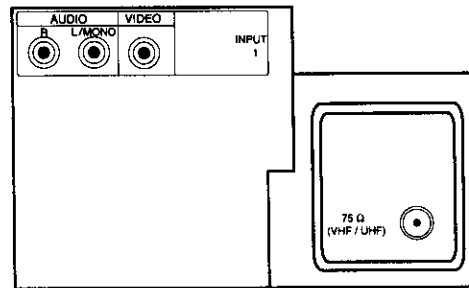

Rear Panel - AV-32115 Only

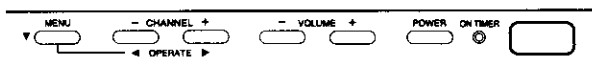

Front Panel - 36 inch models

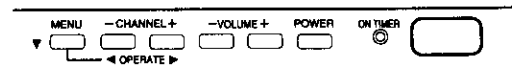

Front Panel - All models except AV-36150 and AV-36120

6

Connections

Cable and VCR Connections

There are three basic types of antenna or cable connections:

- If you have an antenna or have a cable system that does not require the use of a cable box to select channels, please refer to **Diagram #1**.
- If you have a cable system that requires the use of a cable box to access **all** the channels, please refer to **Diagram #2**.
- If you have a cable system that requires the use of a cable box to access **certain** premium channels, but not "basic" cable channels, please refer to **Diagram #3**.
- For instructions on connecting a VCR only, please see the Quick Setup Guide.
- For instructions on using Picture In Picture (PIP), please see page 28.

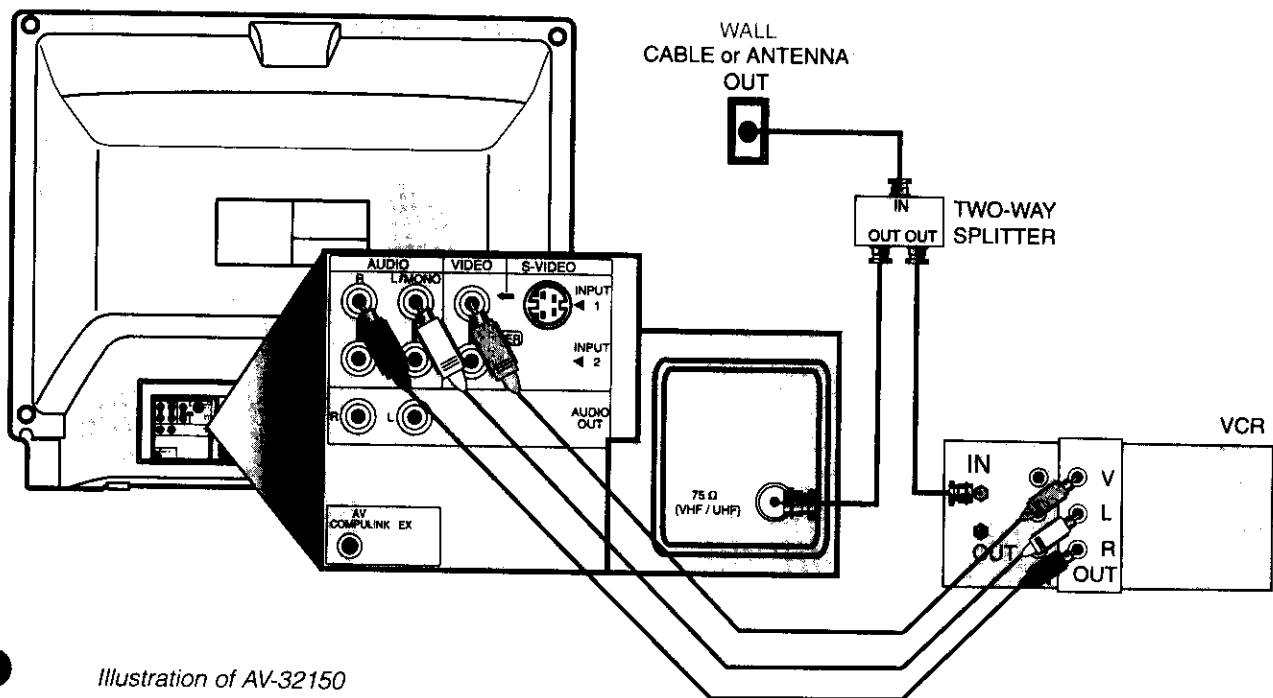

1

Illustration of AV-32150

- 1) Connect the antenna or cable TV wire from the wall outlet, in to the RF Input of the two-way splitter.
 - 2) Connect an RF cable from the one of the RF Outputs on the splitter, in to the RF Input on the back of the VCR.
 - 3) Connect an RF cable from the other the RF Output on the splitter, in to the RF Input on the back of the TV.
 - 4) Connect the yellow video cable out from the VCR's Video Output, in to the TV's Video Input jack.
 - 5) Connect the white audio cable out from the VCR's Left Audio Output, in to the TV's Left Audio Input Jack.
 - 6) Connect the red audio cable out from the VCR's Right Audio Output, in to the TV's Right Audio Input jack.
- If your VCR is a mono sound unit, it will have only one Audio Out jack. Connect it to the TV's Left Audio Input.
 - Please consult your VCR's owner's manual for more information on its operation.

S-Video Connections

You may also choose to connect video devices (VCR, Camcorders, etc) by using an S-Video Cable. S-Video may be substituted in any of the connections diagrams included here. To use S-Video:

- 1) Plug an S-Video cable out from the video device and in to the TV's S-Video Input.

Keep the audio connections the same as shown in the diagrams.

- AV-32115 has no S-Video input.

Audio/Video Connections — Continued

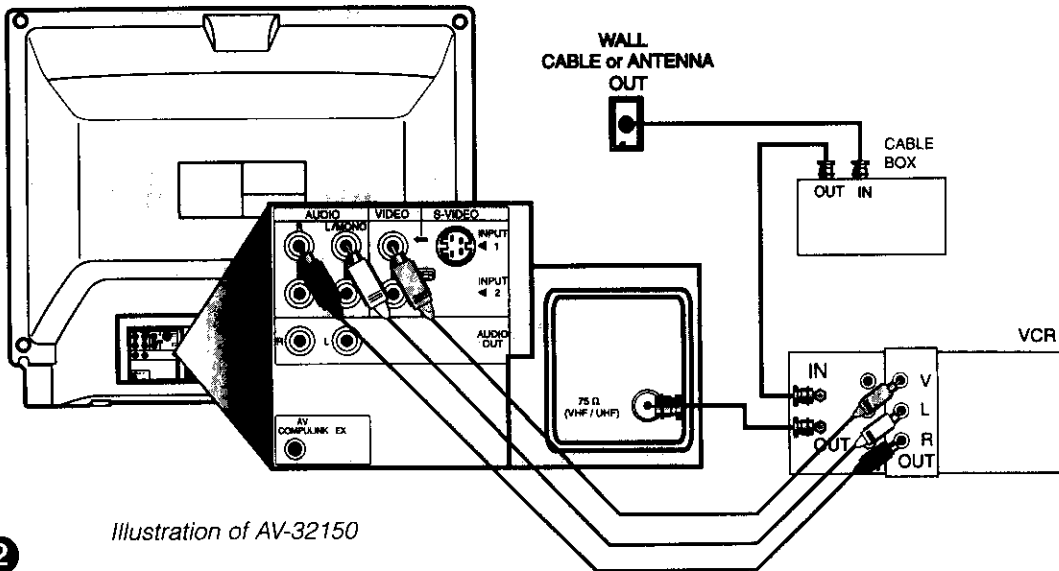

Illustration of AV-32150

2

- 1) Connect the antenna or cable TV wire from the wall outlet, in to the RF Input of the cable box.
- 2) Connect an RF cable from the cable box RF Output, in to the RF Input on the back of the VCR.
- 3) Connect an RF cable from the RF Output on the VCR, in to the RF Input on the back of the TV.
- 4) Connect the yellow video cable out from the VCR's Video Output, in to the TV's Video Input jack.
- 5) Connect the white audio cable out from the VCR's Left Audio Output, in to the TV's Left Audio Input Jack.
- 6) Connect the red audio cable out from the VCR's Right Audio Output, in to the TV's Right Audio Input jack.

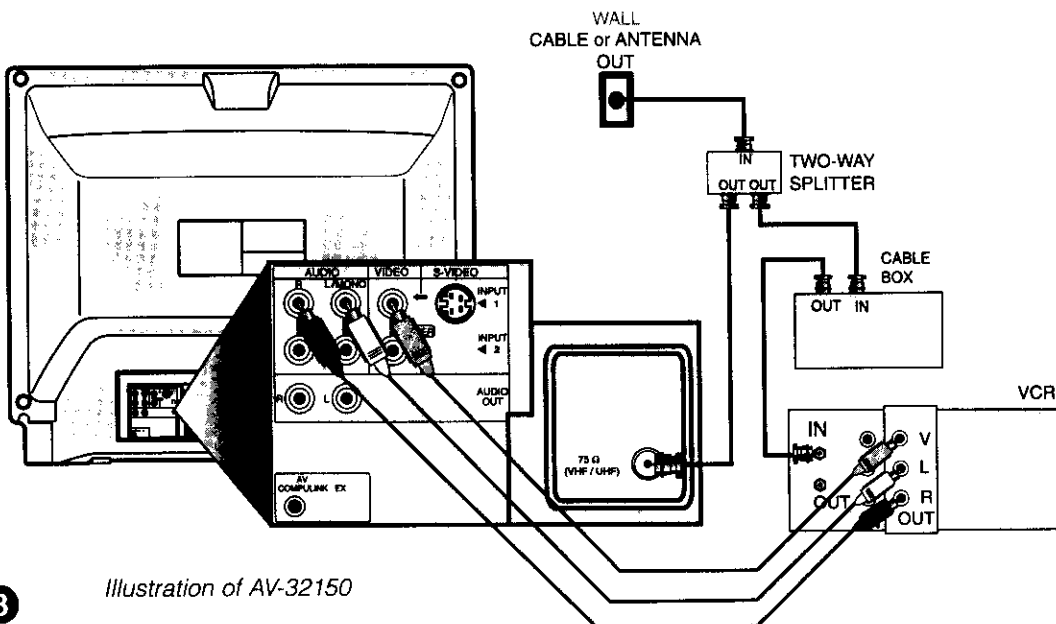

Illustration of AV-32150

3

- 1) Connect the antenna or cable TV wire from the wall outlet, in to the RF Input of the two-way splitter.
- 2) Connect an RF cable from the one of the RF Outputs on the splitter, in to the cable box RF Input.
- 3) Connect an RF cable from the Cable Box Output, in to the VCR RF Input.
- 4) Connect an RF cable from the other the RF Output on the splitter, in to the RF Input on the back of the TV.
- 5) Connect the yellow video cable out from the VCR's Video Output, in to the TV's Video Input jack.
- 6) Connect the white audio cable out from the VCR's Left Audio Output, in to the TV's Left Audio Input Jack.
- 7) Connect the red audio cable out from the VCR's Right Audio Output, in to the TV's Right Audio Input jack.

8

Connections

Connecting to a Camcorder

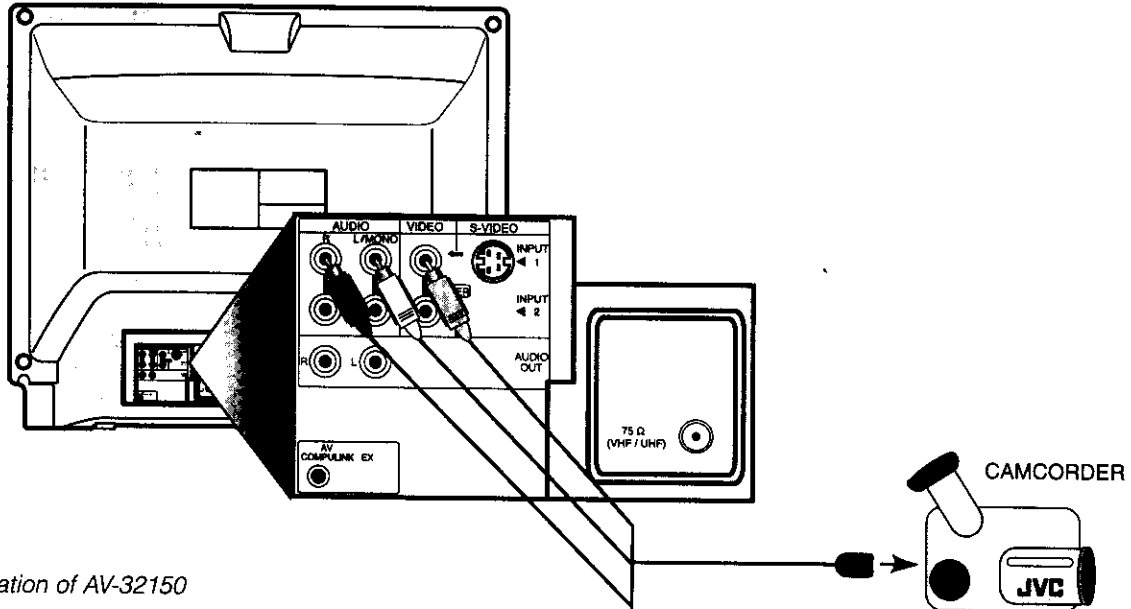

Illustration of AV-32150

- 1) Connect the white audio cable from the Camcorder's Left Audio Output jack to the TV's Left Audio Input jack.
- 2) If you have a stereo Camcorder, connect the red audio cable from the Camcorder's Right Audio Output jack to the TV's Right Audio Input jack.
- 3) Connect a yellow video cable from the Camcorder's Video Output to the TV's Video Input jack.

Connecting to an External Amplifier

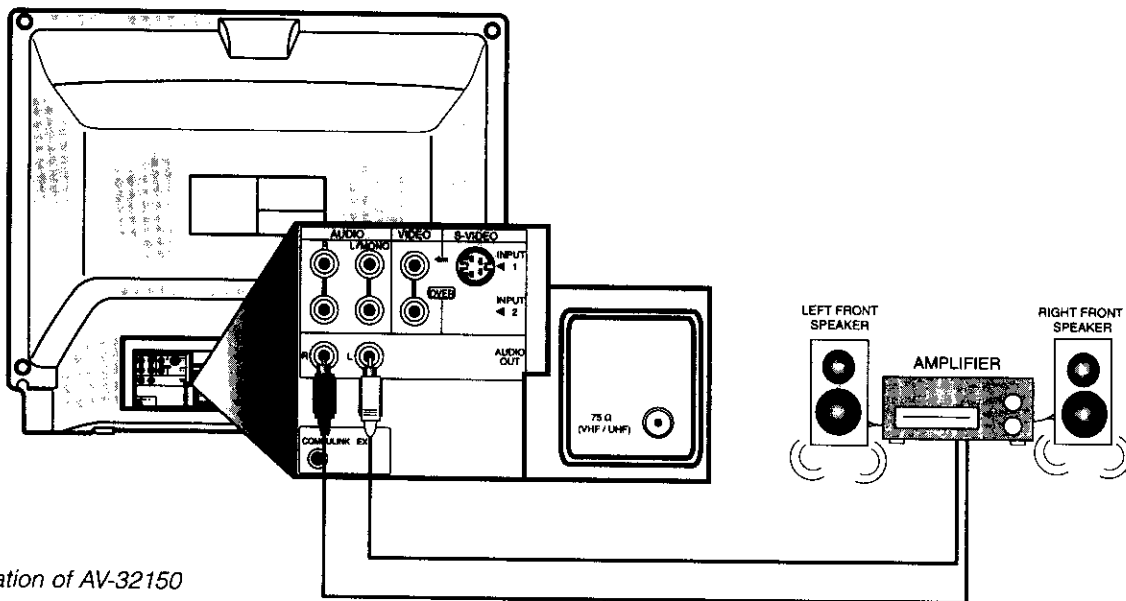

Illustration of AV-32150

- 1) Connect the white audio cable from the TV's Left Audio Output jack to the Amplifier's Left Audio Input jack.
 - 2) Connect the red audio cable from the TV's Right Audio Output jack to the Amplifier's Right Audio Input jack.
- See also 'TV Speaker' and 'Audio Out' on page 25 for more information on using external speakers.
 - Function not available on model AV-32115.

Connecting to JVC AV Compu Link Capable Components (All models except AV-32115)

JVC's AV Compu Link feature makes playing video tapes totally automatic. Simply insert a pre-recorded tape* into your JVC-brand VCR and the VCR will automatically turn on and begin playback. At the same time, using the AV Compu Link, the VCR sends a signal to the television telling it to turn on and switch to the proper video input to watch a video tape.

- The AV Compu Link cable may be included with the JVC AV Compu Link accessory you wish to connect. If it is not, contact an authorized JVC Service Center for part # EWP 805-012.
- AV Compu Link can only be used with JVC-brand products.

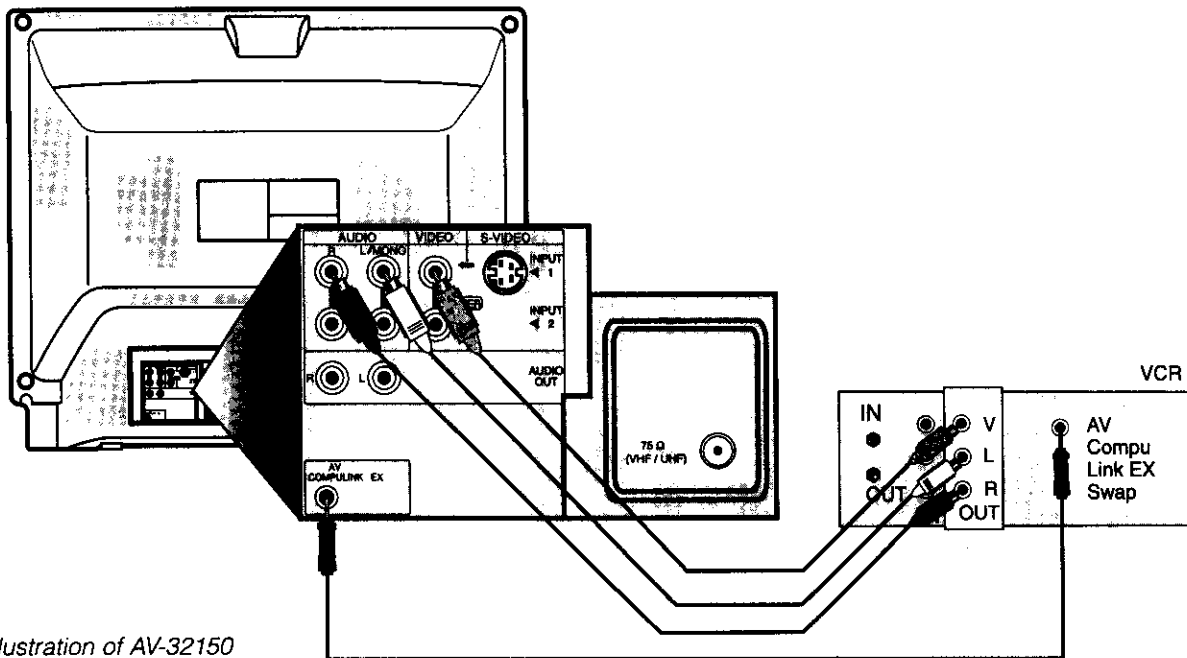

Illustration of AV-32150

To Connect: Plug one end of the AV Compu Link cable into the AV Compu Link input on your VCR or other Compu Link device. Plug the other end of the AV Compu Link cable into the AV Compu Link input at the rear of the television.

NOTES:

- * In order for the VCR playback to begin automatically, the recording tabs must be removed from the VHS tape. If the tab is in place, automatic switching will occur when you push the VCR's PLAY button.
- The AV Compu Link cable has a male 3.5 mm (mono) plug on each end.
- If your JVC-brand VCR has "A Code/B Code Remote Control Switching" (see your VCR's instruction book), using VCR A Code will switch the TV to Video Input 1. If you use Input 1 for video input from your cable box, use VCR B Code to select the TV Video Input 2.
- To connect a JVC HiFi receiver or amplifier for a completely automated home theater, see the HiFi's connection instructions for detailed connection information.
- AV COMPU LINK EX is compatible with the following receivers: RX-664V, RX-665V, RX-668VBK, RX-774V, RX-788VBK, RX-884V, RX-888VBK, RX-1024V, RX-1028VBK, and later receiver models.

Getting Started

REMOTE CONTROLS

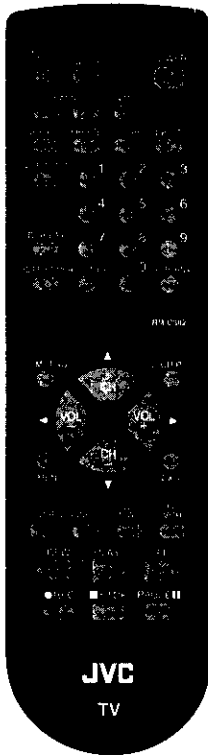

RM-C382

AV-36150 • AV-32150
AV-27150

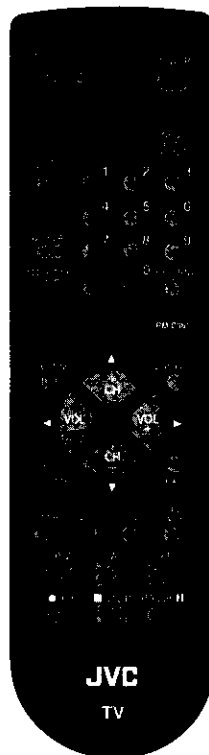

RM-C381

AV-36120 • AV-32120

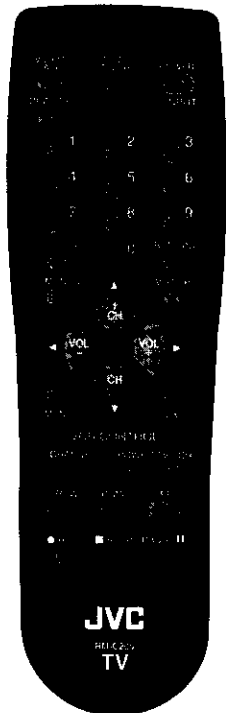

RM-C205

AV-32115

Changing the Batteries

Be sure to use only size AA batteries.

- 1** Raise the latch on the remote's back cover or push down on the back cover and slide towards the bottom to remove it.
- 2** Insert two AA batteries (supplied), carefully noting the "+" and "-" markings on the batteries and on the remote control. To avoid a potential short circuit, insert the "-" end first.
- 3** When batteries are installed, snap the back cover into place.

- If the remote control acts erratically, replace the batteries. Typical battery life is six months to one year.
- We recommend using alkaline batteries for longer battery life.

When you change the batteries, try to complete the task within three minutes. If you take longer than three minutes, the remote control codes for your VCR and/or Cable Box may have to be reset (page 12-13).

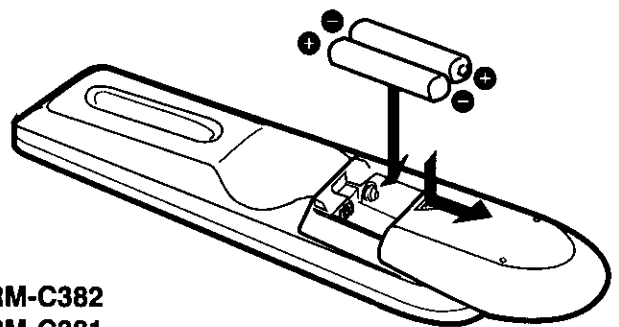

**RM-C382
RM-C381**

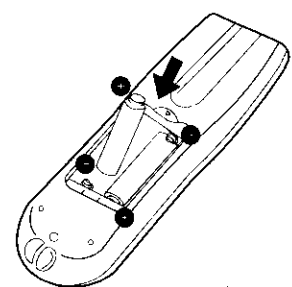
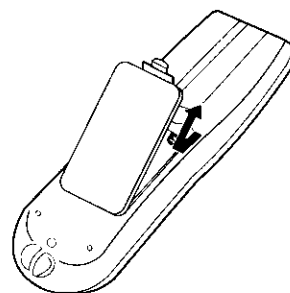

RM-C205

POWER

- Press the POWER button on the remote control or the front panel of the TV. The ON TIMER lamp will glow red.
- Make sure the TV/CATV switch on the remote is set to TV (RM-C381 and RM-C382 only). Move the switch to CATV only if you plan to operate a cable box. On the CATV setting the remote will only operate the cable box functions.
- To turn the power off, press the Power button again. The ON TIMER lamp will go out.
- The ON TIMER lamp will glow red when the On/Off Timer is set (page 24), even when the TV power is off.

ADJUSTING VOLUME

To control the volume level, use the VOLUME+/- buttons on the remote control or on the TV's front panel. Use the VOLUME - button to lower the volume. Press the VOLUME+ button to raise the volume.

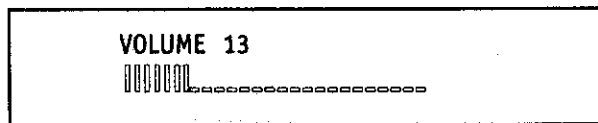

Press the MUTING button to instantly turn the volume to zero. Press MUTING again to return to the previous volume level.

CHANGING CHANNELS

1 10 key direct access

To move directly to a specific channel, press that channel's numbers on the remote's 10 key pad. For single-digit channel numbers, press "0" then the channel number. For channels above 100, press the 100+ button, then the remaining two digits on the 10 key pad.

2 CHANNEL +/- BUTTON

To scan through the channels, press either the CHANNEL + or CHANNEL - button. You will move through the channels in numerical order.

- After you operate the Auto Tuner Setup (page 15), all of the empty channels will be removed from scanning. When you scan you will only receive clear, active channels.

Hyperscan

With JVC's Hyperscan feature you can zip through the channels at a rate of five per second. To use Hyperscan, press and hold either the CHANNEL+ or CHANNEL- buttons. After the first few channels scan at normal speed, the rest will move by at five per second. To scan at normal speed, press and release the CHANNEL+/- button.

3 Regular Return

Press and release the RETURN+ button to return to the previous channel viewed. For example, select a channel, then select another channel using the 10 key pad buttons. You can now flip back and forth between these two channels by pressing RETURN+.

4 RETURN+

With RETURN+ you can program your TV to always return to a specific channel. Press and hold down the RETURN+ button for three seconds. The message, "RETURN CHANNEL PROGRAMMED!" will appear on-screen. Now when you scan through the channels, pressing RETURN+ will bring you back to your programmed channel.

To cancel the RETURN+ channel, press and hold the RETURN+ button for three seconds. The message "RETURN CHANNEL CANCELLED!" will appear on-screen.

- Pressing any number key or turning off the TV will also cancel the RETURN+ channel.

Setting the CATV & VCR Codes

You can program your remote to operate your cable box or satellite receiver by using the instructions and codes listed below. If the equipment does not respond to any of the codes listed below or to the code search function, use the remote control supplied by the manufacturer.

Cable Box or Satellite setup (All models except AV-32115)

The remote control is programmed with CATV and/or Satellite codes for power on, power off, channel up, channel down, and 10 key operation.

- 1) Find the CATV/Satellite brand from the list of codes shown below.
 - 2) Slide the 2-way selector switch to "CATV".
 - 3) Press and hold down the DISPLAY button.
 - 4) With the DISPLAY button held down, enter the first code number listed using the 10 key pad.
 - 5) Release the DISPLAY button.
 - 6) Confirm the operation of the Cable Box/Satellite receiver.
- If your CATV or Satellite box does not respond to the first code, try the others listed. If it does not respond to any code, try the Search Codes Function at the bottom of the page.

CABLE BOXES	CODES	CABLE BOXES	CODES	DIGITAL SATELLITE SYSTEMS	CODES
ABC	024	Puser	032	Echostar	100
Archer	032, 025	RCA	061, 070	G.E.	106
Cableview	051, 032	Realistic	032	Gradiente	112
Citizen	022, 051	Regal	058, 064, 040, 041, 042, 045, 068	Hitachi	104, 111
Curtis	058, 059	Regency	034	HNS (Hughes)	104
Diamond	024, 032, 025	Rembrandt	037, 032, 051, 038	Panasonic	105
Eagle	029	Samsung	051	Philips	102, 103
Eastern	034	Scientific Atlanta	057, 058, 059	Primestar	108
GC Brand	032, 051	SLMark	051, 047	RCA	106, 109, 110
Gemini	022, 043	Sprucer	051, 056	Sony	107
General Instrument	065, 024, 025, 026, 027, 020, 021, 022, 057, 023	Stargate	032, 051	Toshiba	101
Hamlin	040, 041, 042, 045	Telecaption	067	Uniden	102, 103
Hitachi	049, 024	Television	047, 051		
Jerrold	065, 024, 025, 026, 027, 020, 021, 022, 057, 023	Texscan	044		
Macom	049, 050, 051, 054	Tocom	035, 036, 066		
Magnavox	033	Toshiba	050		
Memorex	030	Unika	032, 025		
Movietime	032, 051	Universal	022, 032		
Oak	039, 037, 048	Videoway	052		
Panasonic	055, 056, 060	Viewstar	029, 030		
Paragon	063	Zenith	063, 046		
Philips	028, 029, 030, 052, 053, 031, 069	Zenith/Drake Satellite	046		
Pioneer	047, 062				
Pulsar	051, 032				

Search Codes Function:

- 1) Slide the 2-Way Mode Selector switch to CATV.
- 2) Press the TV POWER and RETURN+ buttons. Hold for at least three seconds and release.
- 3) Press TV POWER, see if the CATV or Satellite box responds.
- 4) If there was a response, press RETURN+. The operating codes are now set. If there was no response, repeat Step 3. If you repeat Step 3 64 times without a response, use the remote control which came with the equipment.

VCR setup

The remote control is programmed with VCR codes for power on, power off, play, stop, fast-forward, rewind, channel up, and channel down operation.

- 1) Find the VCR brand from the list of codes shown below.
 - 2) Slide the 2-way selector switch to "TV".
 - 3) Press and hold down the DISPLAY button.
 - 4) With the DISPLAY button held down, enter the first code number listed with the 10 key pad.
 - 5) Release the DISPLAY button.
 - 6) Confirm the operation of the VCR.
- If your VCR does not respond to the first code, try the others listed. If it does not respond to any code, try the Search Codes Function at the bottom of the page.
 - To record, hold down the REC button on the remote and press PLAY.
 - Some manufacturer's VCR's may not respond to the TV/VCR button, even if other buttons work properly.
 - **AV-32115 Users:** The model RM-C205 remote control can only be used with JVC-brand VCR's

VCRs	CODES	VCRs	CODES	VCRs	CODES
Admiral	035	Magnavox	031, 023, 024, 086	Samsung	037, 060, 062, 033, 089
Aiwa	027, 032	Marantz	003, 004, 005	Sansui	003, 026, 020, 052
Akai	029, 072, 073, 074	Marta	064	Sanyo	063, 067, 091, 071
Audio Dynamic	003, 005	Memorex	024, 067	Scott	059, 060, 062, 067, 038, 040,
Bell & Howell	063, 071	MGA	038, 040, 047, 048, 041, 042		047, 048, 026, 020
Broksonic	020, 026	Minolta	058, 045	Sears	063, 064, 065, 066, 058, 000,
Canon	023, 025	Mitsubishi	038, 040, 047, 048, 041, 042,		001
CCE	043		078, 090	Shintom	075
Citizen	064	Multitech	047, 027, 062	Sharp	035, 036, 080, 088
Craig	063, 029, 064	NEC	003, 004, 005, 000	Signature 2000	027, 035
Curtis Mathes	045, 024, 027, 093	Olympic	024, 023	Singer	075
Daewoo	043, 059, 024, 092	Optimus	028, 021, 035, 064	Sony	028, 029, 030, 053, 054, 055
DBX	003, 004, 005	Orion	026, 020	SV2000	027
Dimensia	045	Panasonic	023, 024, 021, 022	Sylvania	031, 023, 024, 027
Emerson	043, 026, 077, 061, 025, 042,	Penney	024, 058, 045, 063, 003, 004,	Symphonic	027, 081
	020, 076		005, 093	Tashiro	064
Fisher	063, 066, 067, 065, 071	Pentax	058, 005, 045, 093	Tatung	003, 004, 005
Funai	027, 026, 020, 000	Philco	031, 024, 027, 023, 026, 020,	Teac	003, 004, 027, 005
GE	033, 045, 024, 093		043	Technics	021, 022, 023, 024
Go Video	037, 051, 049, 050, 089	Philips	031, 023, 024, 086	Teknika	024, 027, 070
Goldstar	064	Pioneer	023	Toshiba	059, 046, 079
Gradiente	083, 084, 081, 000, 001	Proscan	045, 058, 023, 024, 031, 046,	Vector Research	005
Hitachi	023, 045, 058, 027, 081, 093		059, 060, 033, 087, 093	Wards	035, 036, 067, 044, 064
Instant Replay	024, 023	Quasar	021, 022, 023, 024	Yamaha	063, 003, 004, 005
Jensen	003	Radio Shack	033, 024, 063, 036, 067, 040,	Zenith	044, 082, 064
JVC	000, 001, 002, 003, 004, 005		027		
Kenwood	003, 004, 064, 005	RCA	033, 045, 058, 023, 024, 031,		
LXI	027, 064, 058, 065, 066, 063,		046, 059, 060, 083, 085, 087,		
	067		093		
		Realistic	024, 063, 036, 067, 040, 027		

Search Codes Function:

- 1) Slide the 2-Way Mode Selector switch to TV.
- 2) Press the VCR POWER and RETURN+ buttons. Hold for at least three seconds and release.
- 3) Press VCR POWER, see if the VCR responds.
- 4) If there was a response, press RETURN+. The operating codes are now set. If there was no response, repeat Step 3. If you repeat Step 3 74 times without a response, use the manufacturers remote control which came with the VCR.

Using this Guide

Certain symbols are used throughout this guide to help you learn about the features of your new television. The ones you will see most frequently are:

- ▲▼ Up and Down arrows mean press the CHANNEL UP or CHANNEL DOWN buttons. Pressing the UP or DOWN buttons let you:
 - Move vertically in a main menu screen
 - Move through a submenu screen
 - Move to the next letter, number, or other choice in a submenu
 - Back up to correct an error
 - Scan through TV channels (when not in a menu screen)

- ◀▶ Left and right arrows mean press the VOLUME LEFT or VOLUME RIGHT buttons to:
 - Select a highlighted menu item
 - Select an item in a submenu
 - Select numbers in certain menu options
 - Turn the volume up or down (when not in a menu screen)

 The "Press Button" icon means you should press the button named on your remote control. (Button names appear in SMALL CAPITAL LETTERS.)

 The 'Helping Hand' points to the highlighted or selected item in a menu.

The Onscreen Menus:

To bring up the onscreen menu, press the MENU button on the remote control. The item that appears in yellow is the one currently selected.

The "Plug In Menu" will appear the first time the TV is plugged in. If you use the Menu button on the TV's front panel instead of the remote, an additional menu screen showing channel number and input will appear between menu 1 and 2.

Note: Menus shown in this book are illustrations, not exact replications of the television's onscreen displays.

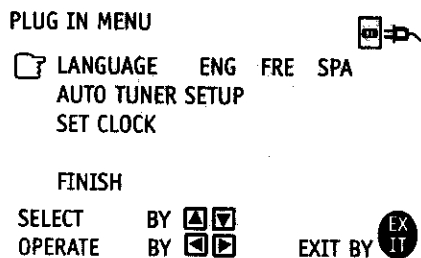

1 Initial Setup Items

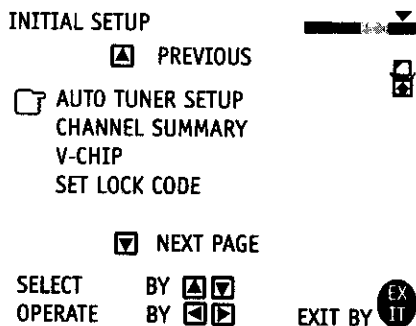

2 Picture Settings

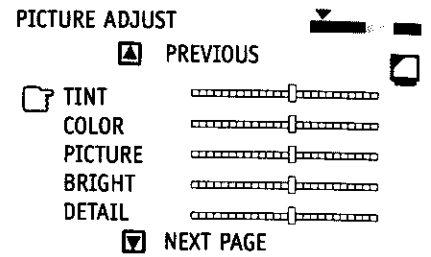

3

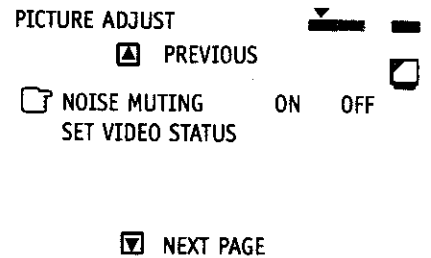

4

Sound Settings

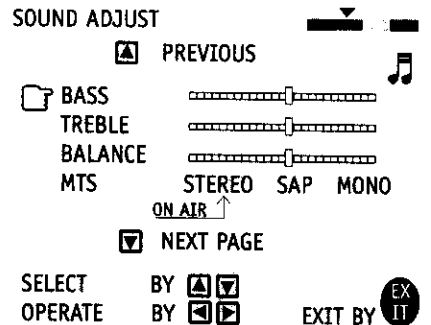

5

General Items

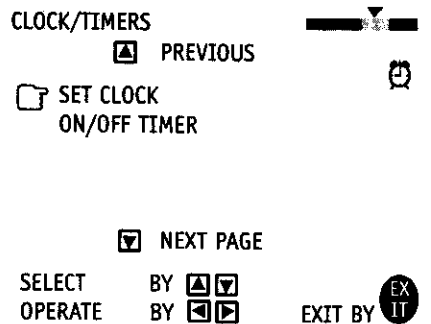

6

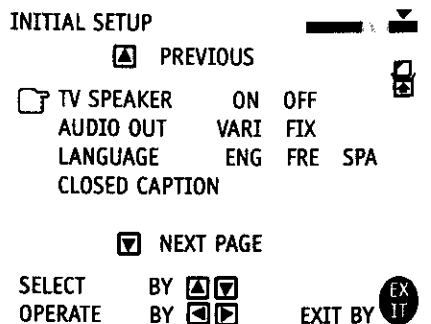

Introduction

The Plug In Menu comes up automatically when you first turn on the TV after plugging it in. The Plug In Menu helps you to get your TV ready to use by letting you set your preferences for:

- The Language in which you want the on screen menus to appear,
- The Auto Tuner Setup of which channels you wish to receive,
- Setting the TV's clock to the correct time so your timer functions will work properly.

Descriptions of each of the Plug In Menu features appear on this page and the next. We recommend you complete the Plug In Menu setup first so your TV is set up just the way you want right away.

Language

You can choose to view your onscreen menus in three languages: English, Spanish, or French.



Press the MENU button



To LANGUAGE

LANGUAGE	ENG	FRE	SPA
----------	-----	-----	-----



To choose a language

→ ENGLISH ←	← FRENCH →	← SPANISH →
-------------	------------	-------------



EXIT when finished

Auto Tuner Setup

In Auto Tuner Setup, the TV automatically scans through all available channels, memorizing the active ones and skipping over blank ones or channels with weak signals. This means when you scan (using the CHANNEL +/- buttons) you will receive only clear, active channels.



Press the MENU button



To AUTO TUNER SETUP



To operate

TUNER MODE	:	CABLE	AIR
START			



To choose CABLE or AIR



To move to START



To start Auto Tuner Setup

<p>NOW PROGRAMMING !</p> <p>▶▶ [] ▶▶</p> <p>48</p>

Programming will take approximately 1 to 2 minutes.

PROGRAMMING OVER!

- Noise Muting will not work during Auto Tuner Setup.

NOTES:

If you exit the Plug In Menu, or wish to change your preferences later, all the Plug In Menu options can be found in the regular on screen menus.

Set Clock

Before you use any of your TV's timer functions, you must first set the clock. You may precisely set your clock using the XDS time signal broadcast by most Public Broadcasting stations. To set the clock using the XDS signal:



Enter the channel number of your local PBS station.



Press MENU



To Set Clock



To operate



To AUTO

MODE	AUTO	MANUAL
TIME ZONE	EASTERN	
D.S.T.	ON	OFF
FINISH		



To TIME ZONE



To select your time zone

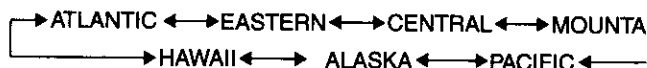

To move to Daylight Savings Time (D.S.T.)



To turn D.S.T. ON or OFF



To FINISH



To save settings and exit

- If you do not have a PBS station in your local area, you will have to set the clock manually. See 'Set Clock - Manual' at the top of the next column for instructions.

- The Daylight Savings Time feature automatically adjusts your TV's clock for Daylight Savings. The clock will move forward one hour at 2:00 am on the first Sunday in April. The clock will move back one hour at 2:00 am on the last Sunday in October.

Set Clock - Manual

To set your clock manually (without using the XDS signal), choose MANUAL from the Set Clock menu and follow the steps below.

MODE	AUTO	MANUAL
TIME	--:-- --	
START CLOCK		



To move to the hour



To set the hour



To move to minutes



To set the minutes



To move to START CLOCK



To start clock and exit

THANK YOU !!

Finish

Once you have the items in the Plug In Menu set to your personal preferences, move to the Finish option to save your settings.



To FINISH



To save settings and exit

- You can change the preferences you set in the Plug In Menu at any time using the regular JVC on screen menu system.

NOTES:

- Auto Clock Set is not available on model AV-32115.
- You will have to reset the clock after a power interruption of 90 seconds or longer.
- You must set the clock before operating any timer functions.

Channel Summary

Channel Summary allows you to customize the line-up of channels received by your TV. You can add or delete channels from the line-up or prevent any unauthorized viewers from watching any of all 181 channels.



Press the MENU button



To CHANNEL SUMMARY



To operate

The Channel Summary screen (below) will now be displayed with the channels set to scan marked with a "✓". You can delete channels from the scan by removing the "✓". If any channels were missed during Auto Tuner Setup and you wish to add them, you may by placing a "✓" next to the channel number.

CHNO	SCAN		CHNO	SCAN	
01			06	✓	
02	✓		07		
03	✓		08		
04	✓		09	✓	
05	✓		10	✓	



To the SCAN column



To include or delete from scan



EXIT when finished

Channel Summary - Lock



To CHANNEL SUMMARY



To operate

CHNO	SCAN		CHNO	SCAN	
01	✓		06	✓	
02	✓		07		
03	✓		08		
04	✓		09	✓	
05	✓		10	✓	



To the Lock Column



ZERO to lock or unlock that channel



EXIT when finished

Channel Guard Message

When a viewer attempts to watch a guarded channel, the following message appears:

THIS CHANNEL IS LOCKED BY
CHANNEL GUARD.
PLEASE ENTER LOCK CODE BY
10 KEY PAD TO UNLOCK IT.

NO. - - - -

To watch a channel that you have locked, enter the Lock Code using the 10 key pad (see "Set Lock Code" - page 21).

If the wrong code is entered, this message will flash on the screen:

INVALID LOCK CODE !

The channel cannot be accessed until the correct code is entered.

- Once a channel has been unlocked, it will remain unlocked until the television is turned off.

NOTES:

Some cable systems experience interference from radio frequencies on cable Channel 95. You may delete this channel from your scan by removing the "✓" next to it on the Channel Summary screen.

V-Chip

Your TV is equipped with V-Chip technology which enables TV Parental Guideline and Movie (MPAA) Guideline controls. V-Chip technology allows you to program your TV to receive, or not to receive, programs based on content according to the guidelines. Programs which exceed the ratings limits you set will be blocked.

When a viewer attempts to watch a blocked channel, this message appears:

THIS PROGRAMMING EXCEEDS
YOUR RATING LIMITS.
PLEASE ENTER LOCK CODE BY
10 KEY PAD TO UNLOCK IT.
NO. - - - -

To watch a blocked channel, enter the lock code (page 21) using the 10 key pad.

To set up the TV Parental Guideline Ratings:



Press the MENU button



To V-CHIP



To operate (Lock icon will appear)



Press ZERO to access the V-Chip menu

V-CHIP ON OFF
SET US TV RATINGS
SET MOVIE RATINGS

UNRATED VIEW BLOCK
FINISH



To turn V-Chip ON or OFF



To move to SET US TV RATINGS



To Operate (see page 19 for details)

	TV MA	TV 14	TV PG	TV G	TV Y7	TV Y
V/FV	—	—	—	—	—	—
S	—	—	—	—	—	—
L	—	—	—	—	—	—
D	—	—	—	—	—	—
	FINISH					

Viewing Guidelines

- V/FV is for VIOLENCE/FANTASY VIOLENCE
- S stands for SEXUAL CONTENT
- L stands for strong LANGUAGE
- D stands for suggestive DIALOG

U.S. PARENTAL RATING SYSTEMS

Programs with the following Ratings are appropriate for Children.

- TV Y is Appropriate for All Children.**
Programs are created for very young viewers and should be suitable for all ages, including children ages 2 - 6.
- TV Y7 is for Older Children.**
Most parents would find such programs suitable for children 7 and above. They may contain some mild fantasy violence or comedic violence, which children should be able to discern from reality.

Programs with the following Ratings are designed for the entire audience.

- TV G stands for General Audience.**
Most parents would find these programs suitable for all age groups. They contain little or no violence, no strong language, and little or no sexual dialog or situations.
- TV PG Parental Guidance Suggested.**
May contain some, but not much, strong language, limited violence, and some suggestive sexual dialog or situations. It is recommended that parents watch these programs first, or with their children.
- TV 14 Parents Strongly Cautioned.**
Programs contain some material that may be unsuitable for children under the age of 14 including possible intense violence, sexual situations, strong coarse language, or intensely suggestive dialog. Parents are cautioned against unattended viewing by children under 14.
- TV MA Mature Audiences Only.**
These programs are specifically for adults and may be unsuitable for anyone under 17 years of age. TV MA programs may have extensive V, S, L, or D.





Directions to Block Viewing:

Line up the cursor in the column (TV PG, TV G, etc.) with the content row (V/FV, S, etc.) and press the ▲ or ▼ to move the cursor to the correct location. Press ◀ or ▶ to turn the locking feature on or off. An item is locked if the  icon appears instead of a "—".

For example. To block viewing of all TV 14 shows:

Move the cursor to the top row of that column and add a lock icon. Once you've put a lock on the top row, everything in that column is automatically locked.

- ▲▼ To the TV 14 Column
- ◀▶ To turn on the lock

	TV MA	TV 14	TV PG	TV G	TV Y7	TV Y
V/FV	—		—	—	—	—
S	—		—	—	—	—
L	—		—	—	—	—
D	—		—	—	—	—
FINISH						



- ▲▼ To FINISH
- ◀▶ To save settings and exit

- If you want to change the setup, move the cursor to the top column and change the lock icon to "—". You may then select individual categories to block.

Special Note about Ratings

Some programs are not broadcast with a ratings signal. Therefore, even if you setup V-Chip ratings limits, these programs will not be blocked. Parents are cautioned to preview the contents of these programs or movies.

Directions to set up Movie Ratings:

-  Press the MENU button
- ▲▼ To V-CHIP
- ◀▶ To operate (Lock icon  appears)
-  Press ZERO to access V-Chip setup options
- ▲▼ To SET MOVIE RATINGS
- ◀▶ To enter movies menu

X	TV 17	R	PG-13	PG	G	NR
—	—	—	—	—	—	—
FINISH						

NR - Not Rated.

This is a film which has no rating. In many cases these films were imported from countries which do not use the MPAA ratings system. Other NR films may be from amateur producers who didn't intend to have their film widely released.

NR (Not Rated) Programming may contain all types of programming including children's programming, foreign programs, or adult material.

G – General Audience.

In the opinion of the review board, these films contain nothing in the way of sexual content, violence, or language that would be unsuitable for audiences of any age.

PG – Parental Guidance.

Parental Guidance means the movie may contain some contents such as mild violence, some brief nudity, and strong language. The contents are not deemed intense.

PG-13 – Parents Strongly Cautioned.

Parents with children under 13 are cautioned that the content of movies with this rating may include more explicit sexual, language, and violence content than movies rated PG.

NOTE (For Canadian Viewers):

V-Chip function is based on specifications for the United States and therefore may not work properly in Canada.

❑ R Restricted.

These films contain material that is explicit in nature and is not recommended for unsupervised children under the age of 17.

❑ NC-17 No One Under 17.

These movies contain content which most parents would feel is too adult for their children to view. Content can consist of strong language, nudity, violence, and suggestive or explicit subject matter.

❑ X No One under 18.

Inappropriate material for anyone under 18.

Directions to Block Movie Viewing:

To block viewers from any or all of these ratings categories, press the ▲ or ▼ to move the cursor to the correct location. Press the ◀ or ▶ buttons to turn the locking feature on or off. An item is blocked if the  icon appears instead of a "—".

For example, to block viewing of X and NC-17 rated from shows:

▲▼ To the X Column

◀▶ To turn on the lock

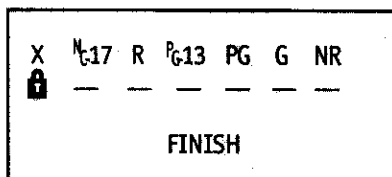

▲▼ To the NC-17 Column

◀▶ To turn on the lock

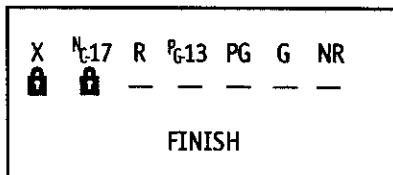

▲▼ To FINISH

◀▶ To save settings and exit

Notes About Unrated Programs:

Unrated programming refers to any programming which does not contain a rating signal. Programming on television stations which do not broadcast rating signals will be placed in the "Unrated Programming" category.

Examples of Unrated programs:

Emergency Bulletins
Locally Originated Programming
News
Political Programs
Public Service Announcements
Religious Programs
Sports
Weather
Some Commercials

- TV programs or movies that do not have rating signals will be blocked if the Unrated Category is set to BLOCK.

Directions to Block Unrated Programs:

You can block programs that are not rated.



Press the MENU button



To V-CHIP



To operate (Lock icon  appears)



Press ZERO to access V-Chip setup options



To UNRATED

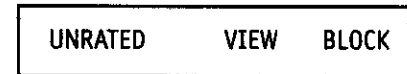

To VIEW or BLOCK



Press EXIT when done

NOTES:

- In order for V-Chip settings to take effect, **V-Chip settings must be turned ON in the V-Chip menu (page 18).**
- You can automatically unblock all of your restrictions by turning V-Chip settings OFF in the V-Chip menu (page 18).
- You can always unblock a restriction by re-entering the V-Chip menu and removing the lock icon.

Accessing V-Chip Information:

To access Rating information about a certain program, press the V-CHIP button while viewing that program. A display like this will appear:



If you decide you want to block this category of viewing, press "0" while the above screen is visible, and all programs from that category will be blocked.

Example 1:

If you want to set your V-Chip settings to block all programming above TV PG:

Press ZERO when TV-PG is displayed

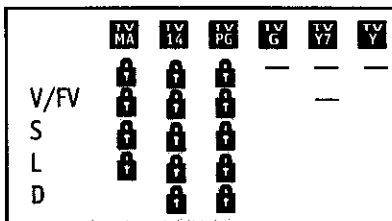

All Programming above TV PG will be blocked.

Example 2:

If you want to set your V-Chip settings to block all programming above a current setting such as TV PG-V (with violence):

Press ZERO when TV-PG - V is displayed

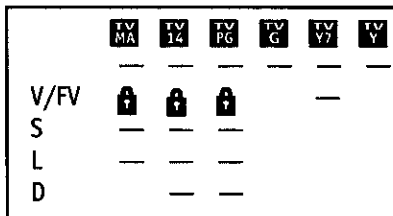

All Programming above TV PG with Violence will be blocked!

Continued...

- For Children's programming you can block TV-Y7 and Y programs by Pressing "0" when Y is displayed during a program. Programming for audiences other than children's audiences will not be affected.

Set Lock Code

Channel Guard and V-Chip settings are protected by a four-digit Lock Code. Your TV comes pre-set with a Lock Code of "0000". You may change the code to any four-digit number you wish. To change the Lock Code, follow the steps below.

- Press the MENU button
- To SET LOCK CODE
- To operate



The padlock icon will appear

Press ZERO to access the Lock Code



The first digit will be highlighted

- To select the number
- To move to the next digit

Continue to follow these directions for all four numbers

- To FINISH
- To save your settings and exit

Continued...

NOTES:

- After a power interruption you must reset the Lock Code.
- Write your Lock Code number down and keep it hidden from potential viewers.
- If you forget the Lock Code, a new code may be set using the steps listed above.

Tint

Tint allows you to adjust the levels of red and green in your TV picture.

- ▲▼ To TINT
- ▶ To increase the levels of green
- ◀ To increase the levels of red
- ▲▼ To move to the next setting

Color

The color function lets you make all the colors in the TV picture appear either more vivid or subtle.

- ▲▼ To COLOR
- ▶ To make the colors more vivid
- ◀ To make the colors more subdued
- ▲▼ To move to the next setting

Picture

Picture allows you to adjust the levels of black and white on the TV screen, giving you a darker or brighter picture overall.

- ▲▼ To PICTURE
- ▶ To increase the level of contrast
- ◀ To decrease the level of contrast
- ▲▼ To move to the next setting

Bright

You can adjust the overall brightness of the TV picture with the Bright control.

- ▲▼ To BRIGHT
- ▶ To lighten the picture
- ◀ To darken the picture
- ▲▼ To move to the next setting

Detail

The Detail feature adjusts the level of fine detail displayed in the picture.

- ▲▼ To DETAIL
- ▶ To make the picture sharper (more details)
- ◀ To make the picture smoother (less detail)
- ▲▼ To move to the next setting

Noise Muting

This feature inserts a blank blue screen over channels which are not broadcasting or are too weak to be received clearly.



Press the MENU button

- ▲▼ To NOISE MUTING
- ◀▶ To turn Noise Muting ON or OFF

- Noise Muting will not work during Auto Tuner Setup or when you operate Channel Summary.

Set Video Status

With Set Video Status, you can save your own set of picture quality adjustments as "Choice" and have access to them at the touch of a button.



Press the MENU button

- ▲▼ To SET VIDEO STATUS
- ◀▶ To operate

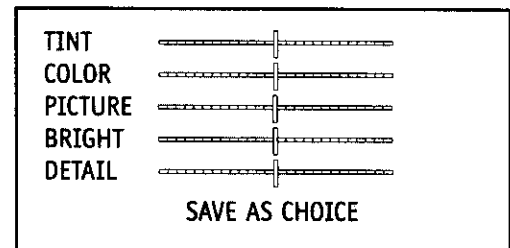

- ◀▶ To set the TINT levels
 - ▲▼ To move to the next option
- Repeat these steps until all levels are set.

- ▲▼ To SAVE AS CHOICE
- ◀▶ To save settings and exit

- You must use SAVE AS CHOICE to exit the Set Video Status menu, otherwise your preferences will not be saved.
- You can access your "Choice" settings at any time by pressing the VIDEO STATUS button on the remote control.

NOTES:

The setting screen will disappear if you do not make any adjustments or move to the next setting in approximately three seconds. Any changes you have made to picture settings up to that point will be stored. You can exit the Picture Settings menu at any time by pressing the EXIT button on the remote control.

Bass

You can increase or decrease the level of low-frequency sound in the TV's audio with the Bass adjustment.



Press the MENU button



To BASS



To increase the bass



To decrease the bass



To move to the next setting

Treble

Use Treble to adjust the level of high-frequency sound in your TV's audio.



Press the MENU button



To TREBLE



To increase the treble



To decrease the treble



To move to the next setting

Balance

Adjust the level of sound between the TV's two speakers with the Balance setting.



Press the MENU button



To BALANCE



To shift the balance towards the right speaker



To shift the balance towards the left speaker



To move to the next setting

MTS (Multi-Channel Television Sound)

MTS technology allows several audio signals to be broadcast at once, giving you a choice in what you wish to hear with a TV program. In addition to mono or stereo sound, an MTS broadcast may also include a Second Audio Program (SAP).



Press the MENU button



To MTS

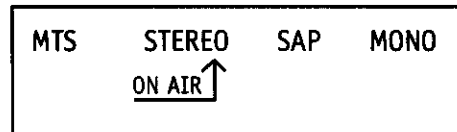

Select the mode

(The ON AIR arrow tells you if a broadcast is in Stereo and/or contains an SAP).

- Keep the TV in STEREO mode to get the best sound quality. The sound will work in STEREO mode even if a certain broadcast is in MONO sound only.
- Choose the MONO setting to reduce excessive noise on a certain channel or broadcast.
- Selecting SAP will allow you to hear an alternative soundtrack, if one is available.

Some Sound Advice

You can tell if a program is broadcast in **stereo** by the position of the ON AIR arrow in the MTS menu screen. Unfortunately, while many programs are originally broadcast in stereo, some cable companies may "squash" the transmission to mono sound because they have only mono equipment. If you are connected to a cable system, the sound quality is determined by the cable company. If they broadcast only in mono, you will receive only mono sound, even if the program was aired in stereo.

Fortunately, most stereo programs are broadcast by the major television networks. If you connect an antenna to your TV instead of cable and set the tuner mode in Auto Tuner Setup to "Air" instead of "Cable" you will be able to pick up stereo broadcasts in their original stereo format

NOTES:

You can leave the Sound Settings menu at any time by pressing the EXIT button on the remote control.

On/Off Timer

The On/Off timer lets you program your television to turn itself on or off. You can use it as an alarm to wake up, to help you remember important programs, or as a decoy when you're not home.



Press the MENU button



To ON/OFF TIMER



To operate (begins with ON TIME)

ON TIME	7:00 PM
OFF TIME	10:00 PM
CHANNEL	02
MODE	ONCE EVERYDAY
ON/OFF TIMER	YES NO
FINISH	



To set the hour (AM/PM) you want the TV to turn on



To move to minutes



To set the minutes



To accept ON TIME and move to OFF TIME (the time the TV will turn off). Set the OFF TIME the same way as ON TIME



To accept OFF TIME and move to CHANNEL



To select channel



To move to MODE



Choose ONCE or EVERYDAY



To ON/OFF TIMER



Choose YES to accept the timer setting, choose NO if you don't wish to accept



To FINISH



To save settings

Timer Note for PIP Models:

If the television is on when a timed event is about to start a Timer Preview window will appear. The Timer Preview window will appear in the lower right corner of the screen seven seconds before the timer is programmed to begin. When the timer activates, the Preview picture will become the main picture.

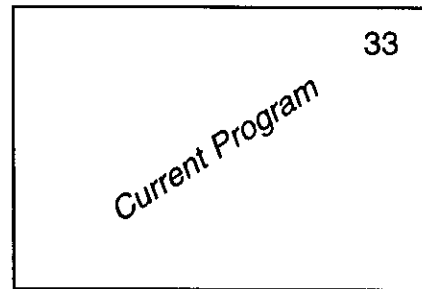

Seven seconds before Timer Activates....

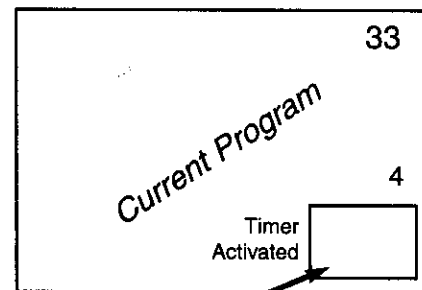

(Preview of ON/OFF Timed Program)

Seven seconds later...

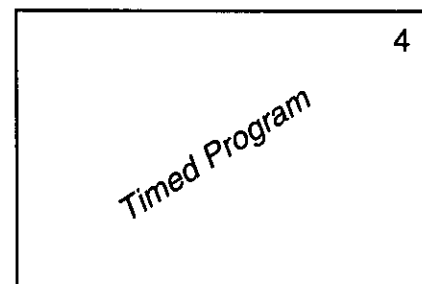

Timer Activates

NOTES:

- **On/Off Timer** cannot be set to locked or guarded channels. In order for the On/Off Timer to work, the clock must be set. After a power interruption Timer settings must be reset.
- PIP Models include AV-36150, AV-32150, and AV-27150.

TV Speaker

If your TV is connected to a stereo system, you can turn off the TV speakers and listen to the audio through your stereo.



Press the MENU button

▲▼ To TV SPEAKER



◀▶ To turn the TV's speakers ON or OFF



EXIT when finished

- Before you turn the TV Speaker setting from OFF to ON, **make sure that the TV volume level is low!** If the TV volume is set too high, the sound level will be extremely loud.
- After a power interruption, the TV Speaker settings will return to "ON".

Audio Out

If your television is connected to an external speaker source, Audio Out gives you the option of controlling the volume level with your TV's remote control.



Press the MENU button

▲▼ To AUDIO OUT

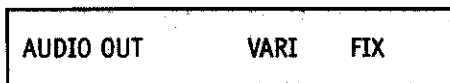

◀▶ To VARI or FIX

VARI: Lets you adjust the volume of the external speakers using the VOLUME +/- buttons on your TV's remote control.

FIX: The volume of the external speakers is adjusted using the audio device's remote control.

Closed Caption

Use this function to display the Closed Captioning text onscreen (when included in a broadcast).



Press the MENU button

▲▼ To CLOSED CAPTION

◀▶ To operate

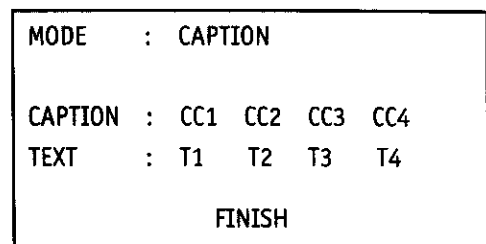

◀▶ To select CAPTION, TEXT, or OFF

▲▼ To move to CAPTION or TEXT

◀▶ To select a caption (CC1 to CC4) or text (T1 to T4) channel

▲▼ To FINISH

◀▶ To save settings and exit

NOTES:

Closed Captions subtitles are usually found on caption channel CC1. Some programs may include additional text information which is usually found on text channel T1. The other channels are available for future use.

Closed captioning may not work correctly if the signal being received is weak or if you are playing a video tape.

Most broadcasts containing Closed Captioning will display a notice at the start of the program.

External Speakers: When using external speakers or amplifiers, shut off the TV Speakers (see 'TV Speakers') above. TV Speaker and Audio Out are available on all models except AV-32115.

Menu

The MENU button allows you to access JVC's onscreen menu system. Press MENU to activate the onscreen menu system.

- See individual topics (like "Sound Settings") for specific information on using menus.

Exit

Press the EXIT button to leave a menu screen or to turn off the PIP feature (page 28).

Display

The Display screen shows the current status of timers and inputs.



Press the DISPLAY button

07	
NOW	12:20 PM
SLEEP TIMER	OFF
ON/OFF TIMER	EVERYDAY
ON TIME	7:00 PM
OFF TIME	10:00 PM

- The channel or AV input (Channel 07)
- The current time (12:20 pm)
- Sleep Timer status/minutes remaining (The Sleep Timer is off)
- On/Off Timer status (Set to turn on everyday at 7:00 PM, off at 10:00 PM)
- Each Press of the DISPLAY button changes the display mode:

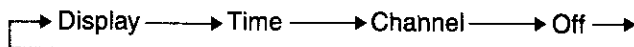

Display - Full screen shown above

Time - Shows the current time only

Channel - Shows the current channel

Off - Turns Display off

- You may also turn off the Display at any step by pressing EXIT.

Video Status

The VIDEO STATUS button gives you a choice of three TV picture display settings, including a display of your own preferences.

Standard - Resets the picture display to the factory settings.

Choice - Displays the setting levels you specified on the "Set Video Status" Menu (see page 22).

Theater - Gives a rich, film-like look to video.



Press the VIDEO STATUS button



Sleep Timer

The Sleep Timer can turn the TV off for you after you fall asleep. Program it to work in intervals of 15 minutes, for a total time of up to 180 minutes.



Press the SLEEP TIMER button

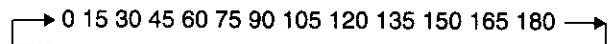

Sleep Timer Message

20 seconds before the automatic shutoff, this message will appear:

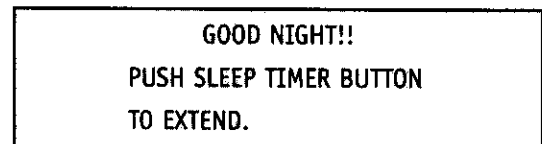

You then have 20 seconds to press the Sleep Timer button to delay the shutoff for another 15 minutes.

Input

Selects the input source: TV (cable or antenna input) or Video (VCR or other video device). All models except AV-32115:



INPUT

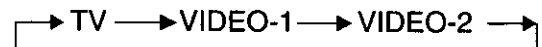

AV-32115 Users:

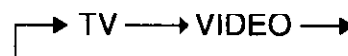

NOTES:

Please note that if the Clock, Sleep Timer or On/Off Timer are not set, the Display screen will show: "Clock Not Set", "Sleep Timer OFF", and "On/Off Timer Off" respectively.

Hyper Surround

Creates a deep, three-dimensional sound effect by channeling the audio through the TV's front-firing speakers. Press the *HYPERSURROUND* button to turn the effect on or off.

HYPERSURROUND ON OFF

- Hyper Surround is available on all models except AV-32115.

Muting

The *MUTING* button instantly turns the volume down completely when you press it.

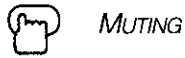

The volume level will instantly go to zero.

- To restore the volume to its previous level, press *MUTING* again.

Number Buttons - 10 Key Pad

To move directly to a specific channel, enter the channel number with the number buttons on the remote. For example, to move to Channel 7:

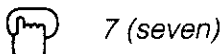
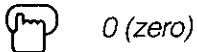

100+ Button

Use the *100+* button to directly access channels above Channel 99. For example to move to channel 124:

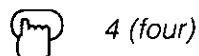
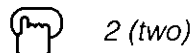
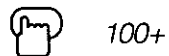

Return+

The *RETURN+* button has two functions:

Return - Returns to the channel viewed just before the channel currently onscreen.

Return+ - Lets you program a specific channel to return to while scanning through the channels.



RETURN+ and hold for three seconds

RETURN CHANNEL
PROGRAMMED !

Scan using the *Channel+/-* buttons



RETURN+

You will return to your programmed channel.

- To cancel your *Return+* channel, press and hold the *RETURN+* button for three seconds. The message "RETURN CHANNEL CANCELLED!" will appear.
- *Return+* works only with *CHANNEL+/-*. Pressing any number key will cancel *Return+*.
- *Return+* does not effect the PIP channel.
- For more information on *Return* and *Return+*, turn to page 11.

VCR Buttons

You can use this remote control to operate the basic functions of your VCR. These functions include: play, record, rewind, fast-forward, stop, pause, channel scan, TV / VCR, power on, and power off.

- The remote is preset with the code 000 to control JVC-brand VCR's. For any other manufacturer's brand VCR, please see the code chart and instructions on page 13.

PIP (Picture-In-Picture)

PIP displays two separate pictures on screen. Your television has 2-Tuner PIP, meaning you can view pictures from two *different* channels simultaneously. A special set of PIP control buttons are located on the upper part of the remote control. Descriptions of each button appear on this page.

Note: PIP is available on the following models only: AV-36150, AV-32150, AV-27150.

ON/MOVE

Turn PIP on by pressing the ON/Move button.



(PIP) ON/MOVE

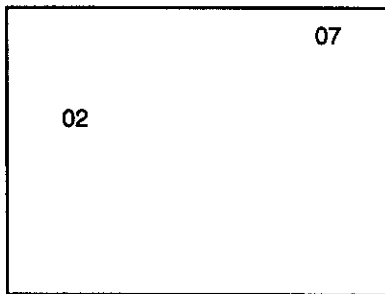

EXIT to turn PIP off

Once PIP is turned on, you can move the PIP window to any of the TV's main picture's four corners with the ON/Move button.



ON/MOVE

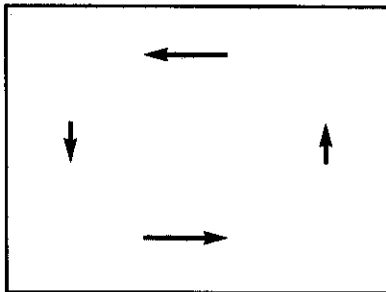

- Each press of ON/Move will shift the PIP window to a different corner.

FREEZE

Use the FREEZE button to lock a single, still image onto the PIP window.



FREEZE

- If PIP is off when FREEZE is pressed, a snapshot of the main screen is taken and placed in the PIP window.
- If PIP is on when FREEZE is pressed, the image in the window when the button was pressed is held.

SWAP

You can exchange the channel displayed on the main screen for the one shown in the PIP window by pressing SWAP.



SWAP

CHANNEL +/- For PIP

Like the main CHANNEL +/- buttons, CHANNEL +/- for PIP lets you scan through the channels in the PIP window.



CHANNEL +/-

- Direct channel selection with the 10 key pad for PIP is not possible.

SOURCE

You can select the signal source for the PIP window image.



SOURCE

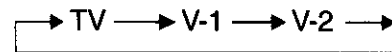

- If the PIP tuner does not have a signal, the PIP window will be blue.

NOTES:

- In order for PIP to work, the television must be set to "TV mode". If you play a videotape, your TV will switch to "VCR mode". The TV only sees one signal in VCR mode. In order to use PIP, press the TV/VCR button to return to TV Mode.
- The PIP window is $\frac{1}{9}$ the size of the full screen.
- PIP will not display blocked channels or programs. A blue screen will display instead.

PROBLEMS	CHECK
There is no power	<ul style="list-style-type: none"> • See if the power cord became unplugged. • Check for a blown fuse or circuit breaker or a power outage.
There is no picture or sound	<ul style="list-style-type: none"> • The antenna could be disconnected. • The input mode could be set improperly. See page 26. • The tuner (Auto Tuner Setup) could be set improperly. See page 15. • The TV station may be having difficulties. Check to see if other stations are working.
Remote control is not operating properly or at all	<ul style="list-style-type: none"> • Check to see that the batteries are still working and properly installed. • Make sure the remote has a clear sight path to the TV. • Check that the TV/CATV switch is in the proper position (RM-381/RM-382 only).
You cannot select a certain channel	<ul style="list-style-type: none"> • You may be too far from the TV. You must be within 23 feet (7 meters). • Make sure the channels have been programmed. See "Channel Summary", page 17. • Check to see if the channel is locked. See "Channel Summary - Lock" page 17.
The power turns off by itself	<ul style="list-style-type: none"> • Make sure the set did not become unplugged. • Perhaps the On/Off Timer is set. See page 24. • Check to see if the Sleep Timer was set. See page 26.
The clock is wrong	<ul style="list-style-type: none"> • The power was interrupted and the clock was not reset. See page 16.
The On Timer is blinking	<ul style="list-style-type: none"> • There is a problem with the TV. Unplug the set and call for service.
The color quality is poor	<ul style="list-style-type: none"> • Tint and Color may be improperly adjusted. See page 22. • The Video Status mode may be turned to the wrong setting. See page 26.
There are lines across the picture	<ul style="list-style-type: none"> • There could be interference from another electrical appliance, such as a computer, another TV or VCR. Move any such appliances further away from the TV.
The picture is spotted	<ul style="list-style-type: none"> • There could be interference from a high-wattage appliance, like a hairdryer or vacuum, operating nearby. Move the antenna away from the appliance or change to a coaxial cable connection which is less prone to interference.
There are double pictures (ghosts)	<ul style="list-style-type: none"> • A building or passing airplane can reflect the original signal and produce a second, slightly delayed one. Adjust your antenna position.
Picture is snowy (image noise)	<ul style="list-style-type: none"> • Your antenna may be damaged, disconnected or turned. Check the antenna connection page 6 and in your Quick Setup Guide. If the antenna is damaged, replace it.
Screen is 80% black	<ul style="list-style-type: none"> • The Closed Caption Text mode is on. Turn it off in the Closed Caption Menu, page 25.
Stereo or bilingual programs can't be heard	<ul style="list-style-type: none"> • Make sure the MTS settings are correct. See "MTS" on page 23.
There is no sound from the TV speakers	<ul style="list-style-type: none"> • The TV SPEAKER option may be turned off. See page 25.
Static electricity	<ul style="list-style-type: none"> • It is normal to feel static electricity if you brush or touch the screen.
You hear occasional crackling sounds	<ul style="list-style-type: none"> • It is normal for the TV to make crackling sounds when first turned on or off. Unless the sound or picture become abnormal, this is fine.

For Canadian model televisions, see separate sheets for Warranty/Garantie and JVC Authorized Service Centers in Canada.

JVC COMPANY OF AMERICA warrants this product and all parts thereof, except as set forth below ONLY TO THE ORIGINAL PURCHASER AT RETAIL to be FREE FROM DEFECTIVE MATERIALS AND WORKMANSHIP from the date of original retail purchase for the period shown below (the "Warranty Period") (PICTURE TUBE is covered for Two (2) years.)

Parts	Labor
1 YEAR	1 YEAR

THIS LIMITED WARRANTY IS VALID ONLY IN THE FIFTY (50) UNITED STATES, THE DISTRICT OF COLUMBIA AND COMMONWEALTH OF PUERTO RICO.

WHAT WE WILL DO:

If this product is found to be defective within the warranty period, JVC will repair or replace defective parts at no charge to the original owner. Such repair and replacement services shall be rendered by JVC during regular business hours at JVC authorized service centers. Parts used for replacement are warranted only for the remainder of this Warranty Period. All products and parts thereof may be brought to a JVC authorized service center on a carry-in basis. Televisions with a screen size of 25 inches and larger may be covered on an in-home basis where such service is available.

WHAT YOU MUST DO FOR WARRANTY SERVICE:

To determine if in-home service is available in your area, either contact the selling dealer (retailer) or call 1-800-537-5722 to locate the nearest JVC authorized service center. Service locations can also be obtained from our website <http://www.jvcservice.com>. In-home service, if available, will require clear access to the Television by the service representatives. If in-home service is not available, carry in service will be provided.

If service is not locally available, box the product carefully, preferably in its original carton, and ship, insured, with a copy of your bill of sale plus a letter of explanation of the problem to the nearest JVC Factory Service Center, the name and location which will be given to you by the toll free number.

If you have any questions concerning your JVC Product, please contact our Customer Relations Department.

WHAT IS NOT COVERED:

This limited warranty provided by JVC does not cover:

- 1) Products which have been subject to abuse, accident, alteration, modification, tampering, negligence, misuse, faulty installation, lack of reasonable care, or if repaired or serviced by anyone other than a service facility authorized by JVC to render such service, or if affixed to any attachment not provided with the products, or if the model or serial number has been altered, tampered with, defaced or removed;
- 2) Initial installation, installation and removal from "built-in" entertainment centers and other mounting systems;
- 3) Operational adjustments covered in the Owner's Manual, normal maintenance, video and audio head cleaning;
- 4) Damage that occurs in shipment, due to an act of God, and cosmetic damage;
- 5) Signal reception problems and failures due to line power surge;
- 6) Video Pick-up Tubes/CCD Image Sensor, Cartridge, Stylus (Needle) are covered for 90 days from the date of purchase;
- 7) Accessories;
- 8) Batteries (except that Rechargeable Batteries are covered for 90 days from date of purchase.)

There are no express warranties except as listed above.

THE DURATION OF ANY IMPLIED WARRANTIES, INCLUDING THE IMPLIED WARRANTY OF MERCHANTABILITY, IS LIMITED TO THE DURATION OF THE EXPRESS WARRANTY HEREIN.

JVC SHALL NOT BE LIABLE FOR THE LOSS OF USE OF THE PRODUCT, INCONVENIENCE, OR ANY OTHER DAMAGES, WHETHER DIRECT, INCIDENTAL OR CONSEQUENTIAL (INCLUDING, WITHOUT LIMITATION, DAMAGE TO TAPES, RECORDS OR DISCS) RESULTING FROM THE USE OF THIS PRODUCT, OR ARISING OUT OF ANY BREACH OF THIS WARRANTY, ALL EXPRESS AND IMPLIED WARRANTIES, INCLUDING THE WARRANTIES OF MERCHANTABILITY AND FITNESS FOR PARTICULAR PURPOSE, ARE LIMITED TO THE WARRANTY PERIOD SET FORTH ABOVE.

Some states do not allow the exclusion of incidental or consequential damages or limitations on how long the warranty lasts, so these exclusions or limitations may not apply to you. This warranty gives you specific legal rights and you may also have other rights which vary state to state.

JVC COMPANY OF AMERICA
 DIVISION OF JVC AMERICAS CORP.
<http://www.jvcservice.com>
 1700 Valley Road
 Wayne, New Jersey 07470

REFURBISHED PRODUCTS CARRY A SEPARATE WARRANTY. THIS WARRANTY DOES NOT APPLY FOR DETAILS OF REFURBISHED PRODUCT WARRANTY. PLEASE REFER TO THE REFURBISHED PRODUCT WARRANTY INFORMATION PACKAGED WITH EACH REFURBISHED PRODUCT.

For customer use:
 Enter below the Model No. and Serial No. which is located either on the rear, bottom or side of the cabinet.
 Retain this information for future reference.

Model No.: _____ Serial No.: _____
 Purchase Date: _____ Name Of Dealer: _____

Authorized Service Centers

31

QUALITY **JVC** SERVICE

HOW TO LOCATE YOUR JVC SERVICE CENTER

TOLL FREE: 1 (800) 537-5722

<http://www.jvcservice.com>

Dear Customer;

In order to receive the most satisfaction from your purchase, read the instruction booklet before operating the unit. In the event that repair is necessary, or for the address nearest your location, please refer to the factory service center list below or within the Continental United States, call 1-800-537-5722 for your authorized servicer. Remember to retain your Bill of Sale for Warranty Service.

— JVC

JVC SERVICE & ENGINEERING COMPANY OF AMERICA

DIVISION OF JVC AMERICAS CORP.

FACTORY SERVICE CENTER LOCATIONS

Dear customer;

In order to receive the most satisfaction from your purchase, read this guide before operating the unit, and before calling for service make sure you check the Troubleshooting pages at the end of this book. In the event that repair is necessary, or for the address nearest you, please refer to the factory service center list below, or within the continental United States, call the toll free number above for an authorized service center. Remember to retain your bill of sale for warranty service.

10 New Maple Avenue
Pine Brook, NJ 07058-9641
(973) 396-1000

1500 Lakes Parkway
Lawrenceville, GA 30243-5857
(770) 339-2582

705 Enterprise Street
Aurora, IL 60504-8149
(630) 851-7855

5665 Corporate Avenue
Cypress, CA 90630-0024
(714) 229-8011

2969 Mapunapuna Place
Honolulu, HI 96819-2040
(808) 833-5828

10700 Hammerly Suite 110
Houston, TX 77043
(713) 935-9331

13 Cummings Park
Woburn, MA 01801
(781) 376-9100

8192 State Road 84
Davie, FL 33324
(954) 472-1960

890 Dubuque Avenue
South San Francisco, CA 94080-1804
(650) 871-2666

Sophisticated electronic products may require occasional service. Just as quality is a keyword in the engineering and production of the wide array of JVC products, service is key to maintaining the high level of performance for which JVC is world famous. The JVC service and engineering organization stands behind our products.

NATIONAL HEADQUARTERS
JVC SERVICE & ENGINEERING COMPANY OF AMERICA
DIVISION OF JVC AMERICAS CORP.
1700 Valley Road
Wayne, New Jersey 07470

IF YOU SHIP THE PRODUCT

Pack your JVC unit in the original carton or one of equivalent size and strength. Enclose, with the unit, a letter stating the problem or symptom that exists and also a copy of the receipt or bill of sale you received when you purchased your JVC unit. Print your home return address on the outside and inside of the carton. Send to the appropriate JVC Factory Service Center as listed above.

Don't service it yourself

CAUTION

To prevent electrical shock, do not open the cabinet. No user serviceable parts inside. Refer to qualified service personnel.

ACCESSORIES

To purchase accessories for your JVC product, you may contact your local JVC Dealer. Or from the 48 Continental United States call toll free : 1 (800) 882-2345

Specifications

MODEL	AV-36150	AV-36120	AV-32150	AV-32120	AV-32115	AV-27150
Reception Format	NTSC, BTSC System (Multi-Channel Sound)					
Reception Range	VHF 2 to 13, UHF 14 to 69 Sub Mid, Mid, Super, Hyper and Ultra bands (181 channel frequency synthesizer system)					
Power Consumption	130W / 1.9A	125W / 1.8A	130W / 1.9A	125W / 1.8A	125W / 1.8A	120W / 1.7A
Power Source	AC120V, 60Hz					
Screen Size	36 inch / 90 cm measured diagonally full square		32 inch / 80 cm measured diagonally full square		27 inch / 68 cm measured diagonally full square	
Audio Output	3W + 3W					
Speakers (inch/cm)	3 1/4" x 4 3/4" / 8 x 12 oval		2" x 4 3/4" / 5 x 12 oval			
Antenna Terminal	75 ohms (VHF/UHF) (F-type connector)					
External Input Jacks	Video: 1 Vp-p, 75 ohms Audio: 500mVrms (-4dBs) high impedance					
S-Video Input Jacks	Y: 1Vp-p positive, 75 ohms (negative sync provided) C: 0.286 Vp-p (burst signal), 75 ohms				—	Y: 1Vp-p positive, 75 ohms C: 0.286 Vp-p, 75 ohms
Variable Audio Output (All models except AV-32115)	More than 0 to 1550 mVrms (+6 dBs) Low impedance (400 Hz when modulated 100%)					
AV Compu Link EX Jack	3.5 mm mini jack x 1				—	3.5 mm mini jack x 1
Dimensions (In) WxHxD (cm)	33 7/8" x 30 1/8" x 23 3/4" 86.0 x 76.5 x 60.3		30 1/4" x 26 1/4" x 21 1/2" 76.8 x 66.7 x 54.7		25 3/4" x 23 3/8" x 20 1/2" / 65.4 x 59.1 x 51.8	
Weight (lbs / kg)	149.2 / 67.8		112.2 / 51.0		79.9 / 36.3	
Accessories	Remote control unit / AA batteries x 2					

Specifications subject to change without notice.

JVC COMPANY OF AMERICA
Division of JVC Americas Corp.
1700 Valley Road
Wayne, New Jersey, 07470

JVC[®]

JVC CANADA, INC.
21 Finchdene Square
Scarborough, Ontario
Canada, M1X 1A7



LCT0572-001A-A
0100-TN-JII-JIM