

FM/AM Compact Disc Player

Operating Instructions _____

US

Owner's Record

The model and serial numbers are located on the bottom of the unit.
Record these numbers in the space provided below.
Refer to these numbers whenever you call upon your Sony dealer regarding this product.

Model No. _____ Serial No. _____

For installation and connections, see the supplied installation/connections manual.

***CDX-C7000X******CDX-C5000X******CDX-C5005***

Warning

This equipment has been tested and found to comply with the limits for a Class B digital device, pursuant to Part 15 of the FCC Rules. These limits are designed to provide reasonable protection against harmful interference in a residential installation. This equipment generates, uses, and can radiate radio frequency energy and, if not installed and used in accordance with the instructions, may cause harmful interference to radio communications. However, there is no guarantee that interference will not occur in a particular installation. If this equipment does cause harmful interference to radio or television reception, which can be determined by turning the equipment off and on, the user is encouraged to try to correct the interference by one or more of the following measures:

- Reorient or relocate the receiving antenna.
- Increase the separation between the equipment and receiver.
- Connect the equipment into an outlet on a circuit different from that to which the receiver is connected.
- Consult the dealer or an experienced radio/TV technician for help.

You are cautioned that any changes or modifications not expressly approved in this manual could void your authority to operate this equipment.

CAUTION

The use of optical instruments with this product will increase eye hazard.

Welcome !

Thank you for purchasing the Sony Compact Disc Player. This unit lets you enjoy a variety of features using the following controller accessories:

For the CDX-C7000X

Supplied accessory

Card remote commander RM-X91

Optional accessory

Rotary commander RM-X4S

For the CDX-C5000X/C5005

Optional accessories

Rotary commander RM-X4S

Card remote commander RM-X91

In addition to the CD playback and radio operations, you can expand your system by connecting optional CD/MD units*¹.

When you operate this unit or a connected optional CD unit with the CD TEXT function, the CD TEXT information will appear in the display when you play a CD TEXT disc*².

*¹ You can connect MD changers, CD changers, MD players, or CD players.

*² A CD TEXT disc is an audio CD that includes information such as the disc name, artist name and track names.

This information is recorded on the disc.

Precautions

- If your car was parked in direct sunlight resulting in a considerable rise in temperature inside the car, allow the unit to cool off before operating it.
- If no power is being supplied to the unit, check the connections first. If everything is in order, check the fuse.
- If your car is equipped with a power antenna, it will extend automatically while the unit is operating.
- Do not use the Custom file feature while driving, or perform any other function which could divert your attention from the road.

If you have any questions or problems concerning your unit that are not covered in this manual, please consult your nearest Sony dealer.

Moisture Condensation

On a rainy day or in a very damp area, moisture may condense on the lenses inside the unit. Should this occur, the unit will not operate properly. In such a case, remove the disc and wait for about an hour until the moisture has evaporated.

To maintain high quality sound

If you have drink holders near your audio equipment, be careful not to splash juice or other soft drinks onto the unit and CD. Sugary residues on the unit or CD may contaminate the lenses inside the unit, reduce the sound quality, or prevent sound reproduction altogether.

Notes on CDs

A dirty or defective disc may cause sound dropouts while playing. To enjoy optimum sound, handle the disc as follows. Handle the disc by its edge. To keep the disc clean, do not touch the surface.



Do not stick paper or tape on the disc.

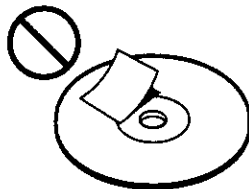

Do not expose the discs to direct sunlight or heat sources such as hot air-ducts, or leave them in a car parked in direct sunlight where there can be a considerable rise in temperature inside the car.

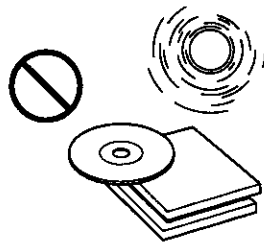

Before playing, clean the discs with an optional cleaning cloth. Wipe each disc from the center out.



Do not use solvents such as benzine, thinner, commercially available cleaners, or antistatic spray intended for analog discs.

Notes on discs

If you use the discs explained below, the sticky residue can cause the CD to stop spinning and may cause malfunction or ruin your discs.

Do not use second-hand or rental CDs that have a sticky residue on the surface (for example, from peeled-off stickers or from ink, or glue leaking from under the stickers).

There are paste residue. Ink is sticky.



Do not use rental CDs with old labels that are beginning to peel off.

Stickers that are beginning to peel away, leaving a sticky residue.

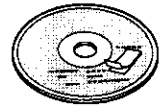

Do not use your CDs with labels or stickers attached.

Labels are attached.

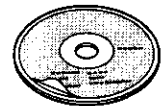

Notes on CD-R discs

- You can play CD-Rs (recordable CDs) on this unit. However depending on the conditions of the recording equipment or the CD-R disc itself, some CD-Rs cannot be played on this unit.
- You cannot play a CD-R that is not finalized (Finalization is necessary for a recorded CD-R disc to be played on the audio CD player).
- You cannot play CD-RWs (rewritable CDs) on this player.

When you play 8 cm (3 in.) CDs

Use the optional Sony compact disc single adaptor (CSA-8) to protect the CD player from damage.

Table of Contents

Location of controls	5
Getting Started	
Resetting the unit	7
Detaching the front panel	7
Turning the unit on/off	8
How to use the menu	8
Setting the clock	8
CD Player	
CD/MD Unit (optional)	
Listening to a CD	9
Playing tracks repeatedly	
— Repeat Play	11
Playing tracks in random order	
— Shuffle Play	11
Labeling a CD	
— Disc Memo*	12
Locating a disc by name	
— List-up*	13
Selecting specific tracks for playback	
— Bank*	14
* Functions available with optional CD/MD unit	
Radio	
Memorizing stations automatically	
— Best Tuning Memory (BTM)	15
Memorizing only the desired stations	15
Receiving the memorized stations	16
Storing the station names	
— Station Memo	17
Locating a station by name	
— List-up	18
Other Functions	
Labeling the rotary commander	18
Using the rotary commander	19
Adjusting the sound characteristics	20
Attenuating the sound	20
Changing the sound and display settings	21
Boosting the bass sound	
— D-bass	21
TV/Video (optional)	
Watching the TV	22
Watching a video	22
Memorizing TV channels automatically	22
Memorizing only the desired TV channels	22
Storing the TV channel names	23
Displaying the information stored on discs ...	23
Watching the TV or video while listening to a CD or MD	
— Simultaneous Play	23
Additional Information	
Maintenance	24
Dismounting the unit	25
Specifications	26
Troubleshooting guide	27

Location of controls

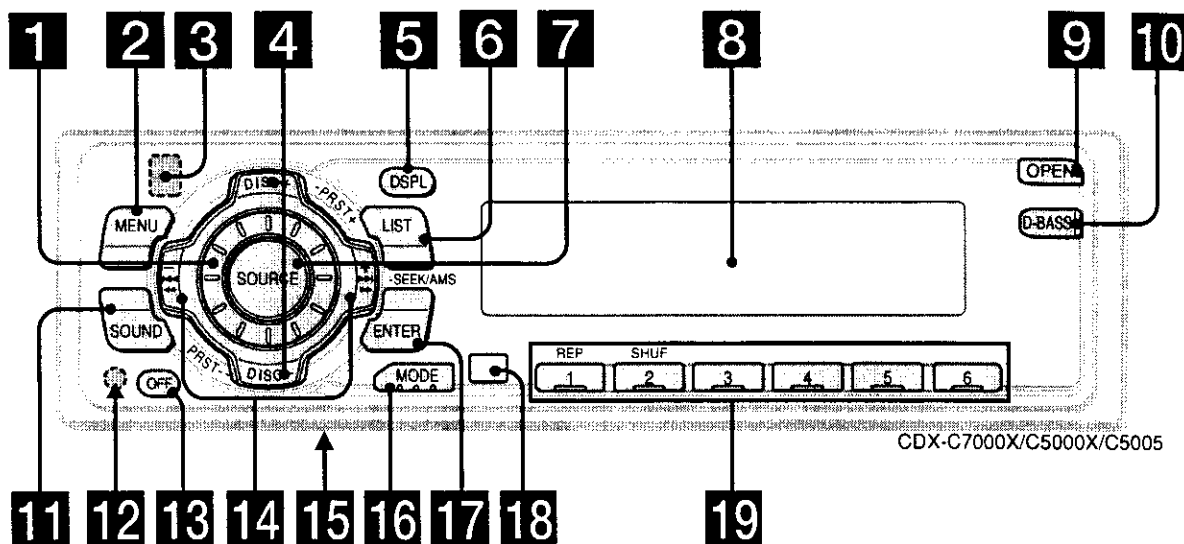

Refer to the pages listed for details.

- 1** Volume control dial
- 2** MENU button 8, 10, 12, 13, 14, 15, 16, 17, 21, 22, 24
- 3** \triangle (eject) button (located on the front side of the unit behind the front panel) 9
- 4** DISC/PRST +/- (cursor up/down) buttons 8, 10, 12, 13, 14, 15, 16, 17, 21, 22, 24
 During CD/MD playback:
 Disc change 11, 13
 During radio reception:
 Preset stations select 16, 18
 During TV reception:
 Band select 22
- 5** DSPL (display mode change) button 9, 10, 12, 17
- 6** LIST button 12, 17
 List-up 13, 18, 23
- 7** SOURCE (TUNER/CD/MD/TV) button 8, 9, 10, 13, 15, 16, 22, 24
- 8** Display window
- 9** OPEN button 7, 9, 25
- 10** D-BASS button 21
- 11** SOUND button 20
- 12** Reset button (located on the front side of the unit behind the front panel) 7
- 13** OFF button*¹ 7, 8, 9
- 14** SEEK/AMS -/+ (cursor left/right) buttons 8, 10, 12, 14, 16, 17, 20, 21, 24
 Automatic Music Sensor 10, 14
 Manual Search 10
 Seek 15, 16, 22
- 15** Frequency select switch (located on the bottom of the unit)*²
 The AM (FM) tuning interval is factory-set to the 10 k (200 k) position. Make sure that the 9 k (50 k) position is selected.
- 16** MODE button
 During CD or MD playback:
 CD/MD unit select 9, 13
 During radio reception:
 BAND select 15, 16
 During TV reception:
 Unit select 22
- 17** ENTER button 8, 10, 12, 13, 14, 15, 16, 17, 18, 21, 22, 24
- 18** Receptor for the card remote commander
- 19** Number buttons
 During radio reception:
 Preset number select 15, 16
 During CD/MD playback:
 ① REP 11
 ② SHUF 11
 During TV reception:
 Preset number select 22

*¹ **Warning when installing in a car without ACC (accessory) position on the ignition key switch**
 Be sure to press **OFF** on the unit for two seconds to turn off the clock display after turning off the engine. When you press **OFF** only momentarily, the clock display does not turn off and this causes battery wear.

*² CDX-C5005 only

Location of controls

Card remote commander RM-X91*

* Supplied only for the CDX-C7000X.

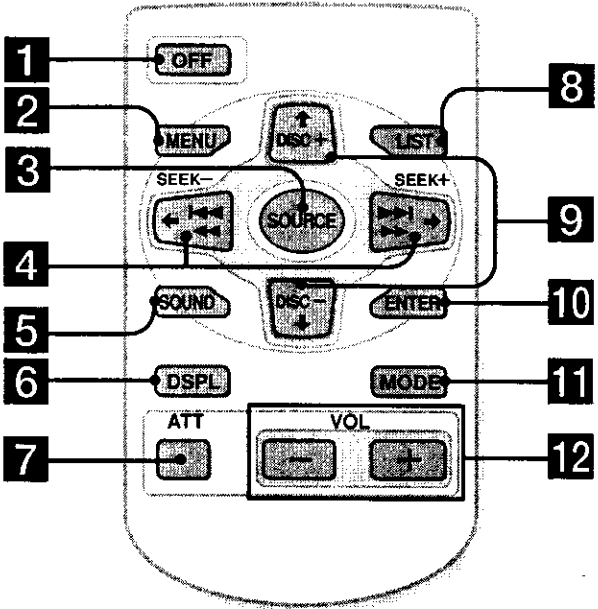

The corresponding buttons of the card remote commander control the same functions as those on this unit.

- 1 OFF button
- 2 MENU button
- 3 SOURCE button
- 4 SEEK/AMS buttons
- 5 SOUND button
- 6 DSPL button
- 7 ATT button
- 8 LIST button
- 9 DISC/PRST buttons
- 10 ENTER button
- 11 MODE button
- 12 VOL buttons

Replacing the lithium battery

When the battery becomes weak, the range of the card remote commander becomes shorter. Replace the battery with a new CR2025 lithium battery.

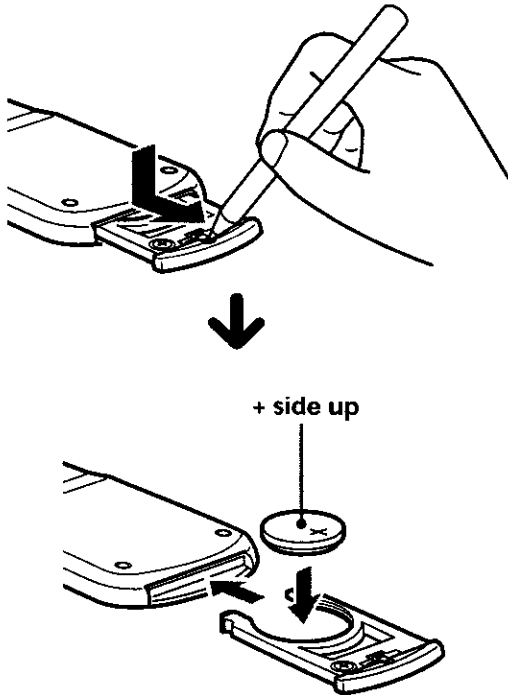

Notes on lithium battery

- Keep the lithium battery out of the reach of children. Should the battery be swallowed, immediately consult a doctor.
- Wipe the battery with a dry cloth to assure a good contact.
- Be sure to observe the correct polarity when installing the battery.
- Do not hold the battery with metallic tweezers, otherwise a short-circuit may occur.

WARNING

Battery may explode if mistreated.
Do not recharge, disassemble, or dispose of in fire.

Getting Started

Resetting the unit

Before operating the unit for the first time or after replacing the car battery, you must reset the unit

Remove the front panel and press the reset button with a pointed object, such as a ball-point pen

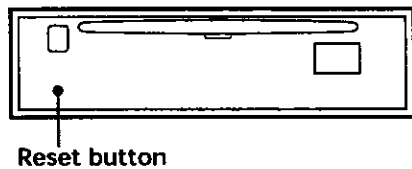

Note

Pressing the reset button will erase the clock setting and some memorized functions such as the station memo

Detaching the front panel

You can detach the front panel of this unit to protect the unit from being stolen.

- 1 Press **OFF**.
- 2 Press **OPEN**, then slide the front panel to the right side, and pull out the left side of the front panel.

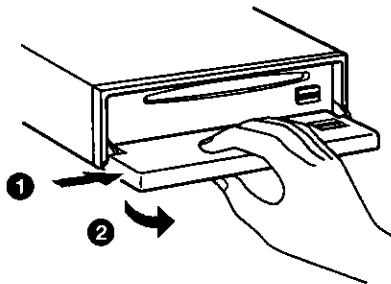

Notes

- Do not put anything on the inner surface of the front panel
- Be sure not to drop the panel when detaching it from the unit
- If you detach the panel while the unit is still turned on, the power will turn off automatically to prevent the speakers from being damaged
- When carrying the front panel with you, use the supplied front panel case

Attaching the front panel

Place the hole **A** in the front panel onto the spindle **B** on the unit as illustrated, then push the left side in

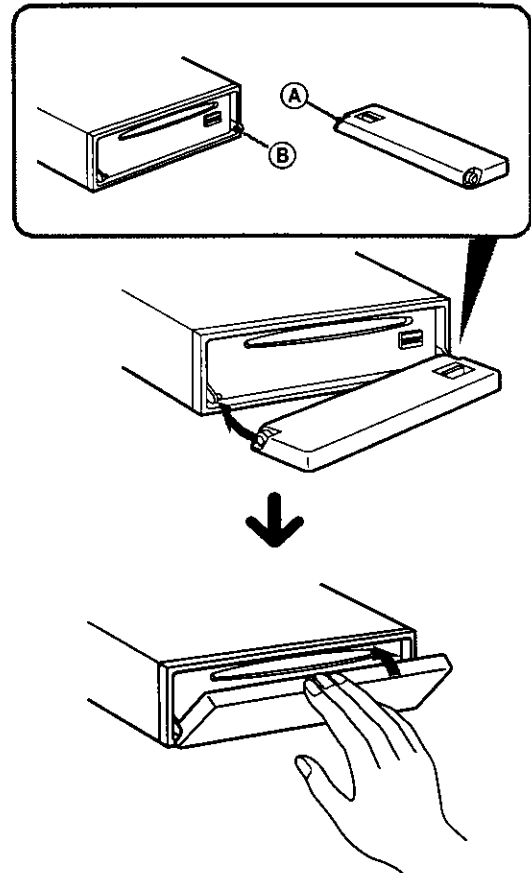

Notes

- Be careful not to attach the front panel upside down
- Do not press the front panel too hard against the unit when attaching it
- Do not press too hard or put excessive pressure on the display window of the front panel
- Do not expose the front panel to direct sunlight or heat sources such as hot air ducts, and do not leave it in a humid place. Never leave it on the dashboard of a car parked in direct sunlight or where there may be a considerable rise in temperature

Caution alarm

If you turn the ignition key switch to the OFF position without removing the front panel, the caution alarm will beep for a few seconds. If you connect an optional power amplifier and do not use the built-in amplifier, the beep sound will be deactivated.

Turning the unit on/off

Turning on the unit

Press **(SOURCE)** or insert a CD in the unit. For details on operation, refer to page 9 (CD/MD) and page 15 (radio).

Turning off the unit

Press **(OFF)** to stop CD/MD playback or FM/AM reception (the key illumination and display remain on).

Press **(OFF)** for two seconds to completely turn the unit off.

Note

If your car has no ACC position on the ignition key switch, be sure to turn the unit off by pressing **(OFF)** for two seconds to avoid car battery wear.

How to use the menu

This unit is operated by selecting items from a menu.

To select, first enter the menu mode and choose up/down ((+)/(-) of **(DISC/PRST)**), or choose left/right ((-)/(+) of **(SEEK/AMS)**).

(DISC/PRST)

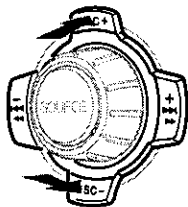

(+): to select upwards

(-): to select downwards

(SEEK/AMS)

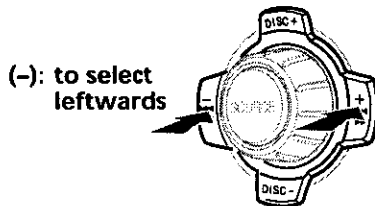

(-): to select leftwards

(+): to select rightwards

Setting the clock

The clock uses a 12-hour digital indication.

Example: To set the clock to 10:08

- 1 Press **(MENU)**, then press either side of **(DISC/PRST)** repeatedly until "CLOCK" appears.

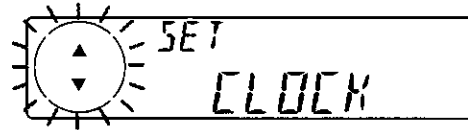

- 1 Press **(ENTER)**.

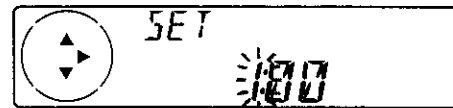

The hour indication flashes.

- 2 Press either side of **(DISC/PRST)** to set the hour.



- 3 Press the (+) side of **(SEEK/AMS)**.



The minute indication flashes.

- 4 Press either side of **(DISC/PRST)** to set the minute.



- 2 Press **(ENTER)**.



The clock starts.

After the clock setting is completed, the display returns to normal play mode.

Note

In the initial setting, the clock indication appears while the unit is turned off. When the D.INFO mode is set to ON, the time is always displayed (page 21).

CD Player CD/MD Unit (optional)

In addition to playing a CD with this unit alone, you can also control external CD/MD units

If you connect an optional CD unit with the CD TEXT function, the CD TEXT information will appear in the display when you play a CD TEXT disc

Listening to a CD

(with this unit only)

- 1 Press **OPEN** and insert the CD.

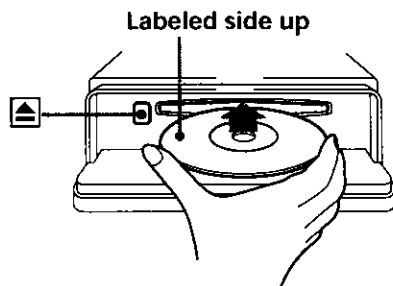

- 2 Close the front panel.
Playback starts automatically.

If a CD is already inserted, press **SOURCE** repeatedly until "CD" appears to start playback.

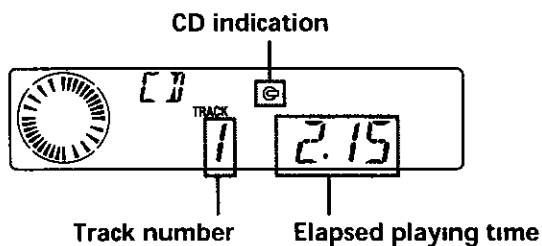

When the last track on the CD is over

The track number indication returns to "1," and playback restarts from the first track of the CD

To	Press
Stop playback	OFF
Eject the CD	OPEN then ▲

Playing a CD or MD (with an optional CD/MD unit)

- 1 Press **SOURCE** repeatedly to select "CD" or "MD."
- 2 Press **MODE** until the desired unit appears.
CD/MD playback starts

All the discs in the current CD/MD unit is played from the top

Changing the display item

Each time you press **DSPL** during MD, CD, or CD TEXT disc playback, the item changes as follows

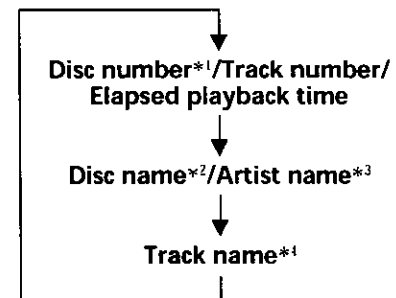

- *1 While an optional CD/MD unit is connected
- *2 If you have not labeled the CD or CD TEXT disc ("Labeling a CD" on page 12), or if there is no disc name prerecorded on the MD, "DISC" and "NO NAME" appear in the display
- *3 If you play a CD TEXT disc, the artist name appears in the display after the disc name (Only for CD TEXT discs with the artist name)
- *4 If the track name of a CD TEXT disc or MD is not prerecorded, "TRACK" and "NO NAME" appear in the display

After you select the desired item, the display will automatically change to the Motion Display mode after a few seconds. In the Motion Display mode, all the items are scrolled in the display one by one in order.

Note

If you use personalized labels, they will always take priority over the original CD TEXT information when such information is displayed.

Tip

The Motion Display mode can be turned off. (See "Changing the sound and display settings" on page 20.)

Automatically scrolling a disc name — Auto Scroll

If the disc name, artist name, or track name on an MD or a CD TEXT disc exceeds eight characters and the Auto Scroll function is on, information automatically scrolls across the display as follows:

- The disc name appears when the disc has changed (if the disc name is selected as the display item).
- The track name appears when the track has changed (if the track name is selected as the display item).
- The disc or track name appears depending on the setting when you press **(SOURCE)** to select an MD or CD TEXT disc.

If you press **(DSPL)** to change the display item, the disc or track name of the MD or CD TEXT disc is scrolled automatically whether you set the function on or off.

- 1 During playback, press **(MENU)**.
- 2 Press either side of **(DISC/PRST)** repeatedly until "A.SCRL-OFF" appears.
- 3 Press the (+) side of **(SEEK/AMS)** to select "A.SCRL-ON."
- 4 Press **(ENTER)**.

To cancel Auto Scroll, select "A.SCRL-OFF" in step 3.

Note

For some CD TEXT discs with very many characters, the following cases may happen:
— Some of the characters are not displayed.
— Auto Scroll does not work.

Locating a specific track — Automatic Music Sensor (AMS)

During playback, press either side of **(SEEK/AMS)** momentarily for each track you want to skip.

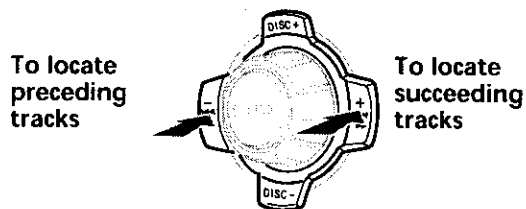

Locating a specific point in a track — Manual Search

During playback, press and hold either side of **(SEEK/AMS)**. Release when you have found the desired point.

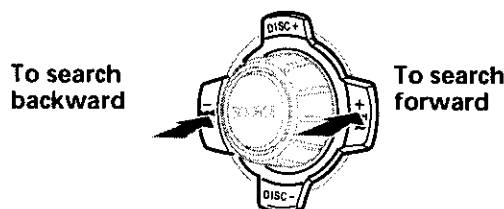

Note

If "LL LL" or "RR RR" appears in the display, you have reached the beginning or the end of the disc and you cannot go any further.

Locating a disc

— Disc Selection

When an optional CD/MD unit is connected, press either side of **(DISC/PRST)** to select the desired disc. The desired disc in the current optional CD/MD unit begins playback.

Playing tracks repeatedly

— Repeat Play

The CD in the main unit will automatically repeat itself when it reaches the end. As repeat play, you can select:

- REP-1 – to repeat a track.
- REP-2 – to repeat a disc in the optional CD/MD unit.

During playback, press **(1)** (REP) repeatedly until the desired setting appears in the display.

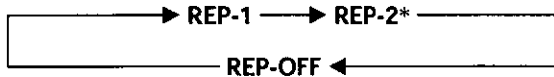

* "REP-2" is only available when you connect one or more optional CD units, or when you connect two or more optional MD units.

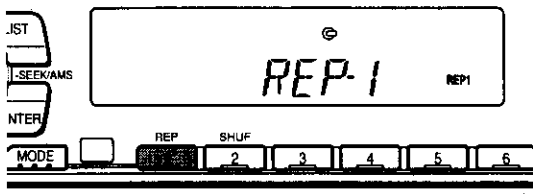

Repeat Play starts.

To return to normal play mode, select "REP-OFF."

Playing tracks in random order

— Shuffle Play

You can select:

- SHUF-1 – to play the tracks on the current disc in random order.
- SHUF-2 – to play the tracks in the current optional CD/MD unit in random order.
- SHUF-ALL – to play all the tracks in all the optional CD/MD units in random order.

During playback, press **(2)** (SHUF) repeatedly until the desired setting appears in the display.



* "SHUF-2" and "SHUF-ALL" are only available when you connect one or more optional CD units, or when you connect two or more optional MD units.

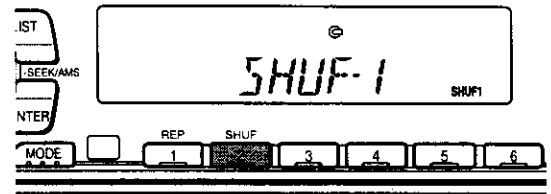

Shuffle Play starts.

To return to normal play mode, select "SHUF-OFF."

Labeling a CD — Disc Memo

(For a CD unit with the custom file function)

You can label each disc with a personalized name. You can enter up to eight characters for a disc. If you label a CD, you can locate the disc by name (page 13) and select the specific tracks for playback (page 14).

1 Start playing the disc you want to label.

2 Press **(MENU)**, then press either side of **(DISC/PRST)** repeatedly until "NAME EDIT" appears.

3 Press **(ENTER)**.

Name edit mode

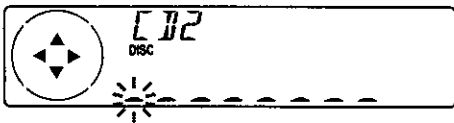

4 Enter the characters.

1 Press the (+) side of **(DISC/PRST)** repeatedly to select the desired characters.

(A → B → C → ... Z → 0 → 1 → 2 → ... 9 → + → - → * → / → \ → > → < → . → _)

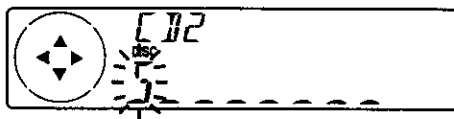

If you press the (-) side of **(DISC/PRST)** repeatedly, the characters will appear in reverse order.

If you want to put a blank space between characters, select "_" (under-bar).

2 Press the (+) side of **(SEEK/AMS)** after locating the desired character.

The next character flashes.

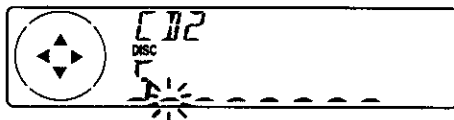

If you press the (-) side of **(SEEK/AMS)**, the previous character flashes.

3 Repeat steps **1** and **2** to enter the entire name.

5 To return to normal CD play mode, press **(ENTER)**.

Tips

- To erase or correct a name, enter "_" (under-bar) for each character.
- There is another way to start labeling a CD. Press **(LIST)** for two seconds instead of steps 2 and 3. You can also complete the operation by pressing **(LIST)** for two seconds instead of step 5.

Displaying the disc memo

Press **(DSPL)** during CD or CD TEXT disc playback.

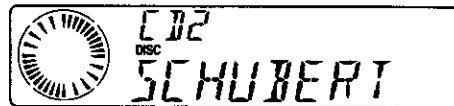

Each time you press **(DSPL)** during CD or CD TEXT disc playback, the item changes as follows:

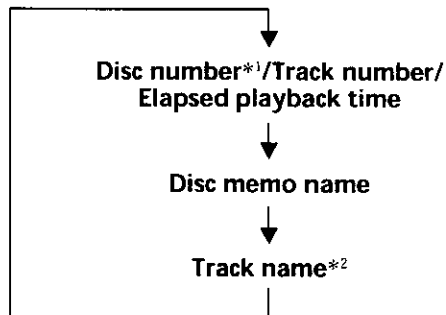

*1 While an optional CD unit is connected.

*2 If you connect an optional CD unit with the CD TEXT function, the CD TEXT information will appear in the display when you play a CD TEXT disc.

Note

Do not use the Custom file feature while driving, or perform any other function which could divert your attention from the road.

Erasing the disc memo

- 1 Press **(SOURCE)** repeatedly to select "CD."
- 2 Press **(MODE)** repeatedly to select the CD unit.
- 3 Press **(MENU)**, then press either side of **(DISC/PRST)** repeatedly until "NAME DEL" appears.
- 4 Press **(ENTER)**.
- 5 Press either side of **(DISC/PRST)** repeatedly to select the disc name you want to erase.
- 6 Press **(ENTER)** for two seconds.
The name is erased.
Repeat steps 5 and 6 if you want to erase other names.
- 7 Press **(MENU)** twice.
The unit returns to normal CD play mode.

Note

When a personalized label is erased, the original CD TEXT information will appear in the display.

Locating a disc by name

— List-up (For a CD unit with the custom file function or an MD unit)

You can use this function for discs that have been assigned a custom name. For more information on disc memo names, refer to "Labeling a CD" (page 12).

- 1 Press **(LIST)**.
The name assigned to the current disc appears in the display.

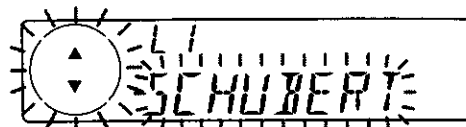

When you assign a disc memo name to a CD TEXT disc, it takes priority over the original CD TEXT information.

- 2 Press either side of **(DISC/PRST)** repeatedly until you find the desired disc.
- 3 Press **(ENTER)** to play the disc.

Notes

- After a disc name has been displayed for five seconds, the display returns to normal play mode.
- The track names are not displayed during MD or CD TEXT disc playback.
- If there are no discs in the magazine, "NO DISC" appears in the display.
- If a disc has not been assigned a custom file, "*****" appears in the display.
- Some letters cannot be displayed during MD or CD TEXT disc playback.
- If an optional TV system is connected, the disc memo name appears in the display of the TV system but not in the unit's display.

Selecting specific tracks for playback

— Bank

(For a CD unit with the custom file function)

If you label the disc, you can set the unit to skip or play the tracks of your choice.

1 Start playing the disc you want to label.

2 Press **(MENU)**, then press either side of **(DISC/PRST)** repeatedly until "BANK SEL" appears.

3 Press **(ENTER)**.

Bank edit mode



4 Label the tracks.

1 Press either side of **(SEEK/AMS)** repeatedly to select the track you want to label.

2 Press **(ENTER)** repeatedly to select "PLAY."

5 Repeat step 4 to set "PLAY" or "SKIP" for all the tracks.

6 Press **(MENU)** twice.

The unit returns to normal CD play mode.

Notes

- You can set "PLAY" and "SKIP" for up to 24 tracks.
- You cannot set "SKIP" for all the tracks on a CD.

Playing specific tracks only

You can select:

- "BANK-ON" — to play the tracks with the "PLAY" setting.
- "BANK-INV" (Inverse) — to play the tracks with the "SKIP" setting.

1 During playback, press **(MENU)**, then press either side of **(DISC/PRST)** repeatedly until "BANK-ON," "BANK-INV," or "BANK-OFF" appears.

2 Press the (+) side of **(SEEK/AMS)** repeatedly until the desired setting appears.



3 Press **(ENTER)**.

Playback starts from the track following the current one.

To return to normal play mode, select "BANK-OFF" in step 2.

Radio

Memorizing stations automatically

— Best Tuning Memory (BTM)

The unit selects the stations with the strongest signals and memorizes them in the order of their frequencies. You can store up to 6 stations on each band (FM1, FM2, FM3, AM1, and AM2).

Caution

When tuning in stations while driving, use Best Tuning Memory to prevent accidents.

- 1 Press **(SOURCE)** repeatedly to select the tuner.
Each time you press **(SOURCE)**, the source changes as follows

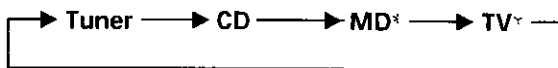

* If the corresponding optional equipment is not connected, these items will not appear.

- 2 Press **(MODE)** repeatedly to select the band.
Each time you press **(MODE)**, the band changes as follows

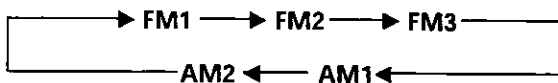

- 3 Press **(MENU)**, then press either side of **(DISC/PRST)** repeatedly until "BTM" appears.

- 4 Press **(ENTER)**.
The unit stores stations in the order of their frequencies on the number buttons.
A beep sounds when the setting is stored.

Notes

- The unit does not store stations with weak signals. If only a few stations can be received, some number buttons will retain their former setting.
- When a number is indicated in the display, the unit starts storing stations from the one currently displayed.
- If a CD is not in the unit, only the tuner band appears even if you press **(SOURCE)**.

Memorizing only the desired stations

You can preset up to 18 FM stations (6 each for FM1, FM2, and FM3), up to 12 AM stations (6 each for AM1 and AM2) in the order of your choice.

- 1 Press **(SOURCE)** repeatedly to select the tuner.
- 2 Press **(MODE)** repeatedly to select the band.
- 3 Press either side of **(SEEK/AMS)** to tune in the station that you want to store on the number button.
- 4 Press the desired number button (**1** to **6**) for two seconds until "MEM" appears.
The number button indication appears in the display.

Note

If you try to store another station on the same number button, the previously stored station will be erased.

Receiving the memorized stations

- 1 Press **(SOURCE)** repeatedly to select the tuner.
- 2 Press **(MODE)** repeatedly to select the band.
- 3 Press the number button (**(1)** to **(6)**) on which the desired station is stored.

Tip

Press either side of **(DISC/PRST)** to receive the stations in the order they are stored in the memory (Preset Search Function).

If you cannot tune in a preset station

Press either side of **(SEEK/AMS)** to search for the station (automatic tuning).

Scanning stops when the unit receives a station. Press either side of **(SEEK/AMS)** repeatedly until the desired station is received.

Note

If the automatic tuning stops too frequently, press **(MENU)**, then press either side of **(DISC/PRST)** repeatedly until "LOCAL" (local seek mode) is displayed. Then press the (+) side of **(SEEK/AMS)** to select "LOCAL-ON." Press **(ENTER)**.

Only the stations with relatively strong signals will be tuned in.

Tips

- When you select the "LOCAL-ON" setting, "L.SEEK" appears while the unit is searching for a station.
- If you know the frequency of the station you want to listen to, press and hold either side of **(SEEK/AMS)** until the desired frequency appears (manual tuning).

If FM stereo reception is poor

— Monaural Mode

- 1 During radio reception, press **(MENU)**, then press either side of **(DISC/PRST)** repeatedly until "MONO-OFF" appears.
- 2 Press the (+) side of **(SEEK/AMS)** until "MONO-ON" appears.
The sound improves, but becomes monaural ("ST" disappears).
- 3 Press **(ENTER)**.

To return to normal mode, select "MONO-OFF" in step 2.

Automatical reception frequency adjustment

— IF AUTO function

If interference occurs, the "IF AUTO" function of this unit will automatically avoid noise and narrow the reception frequency. In such cases, some FM stereo broadcasts may become monaural. If you would like to hear such broadcasts in stereo, manually switch to the "WIDE" setting.

- 1 During radio reception, press **(MENU)**, then press either side of **(DISC/PRST)** repeatedly until "IF AUTO" appears.
- 2 Press the (+) side of **(SEEK/AMS)** until "WIDE" appears.
- 3 Press **(ENTER)**.

Note

When you widen the frequency signal reception setting ("WIDE" mode), some interference may occur.

Storing the station names

— Station Memo

You can assign a name to each radio station and store it in memory. The name of the station currently tuned in appears in the display. You can assign a name of up to eight characters for a station.

Storing the station names

- 1 Tune in a station whose name you want to store.
- 2 Press **(MENU)**, then press either side of **(DISC/PRST)** repeatedly until "NAME EDIT" appears.

- 3 Press **(ENTER)**.



- 4 Enter the characters.

- 1 Press the (+) side of **(DISC/PRST)** repeatedly to select the desired characters.
(A → B → C → ... Z → 0 → 1 → 2 → ... 9 → + → - → * → / → \ → > → < → . → _)



If you press the (-) side of **(DISC/PRST)** repeatedly, the characters appear in the reverse order.

If you want to put a blank space between characters, select "_" (under-bar).

- 2 Press the (+) side of **(SEEK/AMS)** after locating the desired character.
The next character flashes.

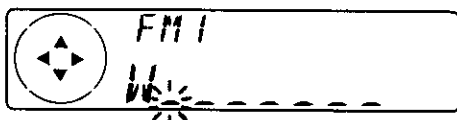

If you press the (-) side of **(SEEK/AMS)**, the previous character flashes.

- 3 Repeat steps 1 and 2 to enter the entire name.

- 5 To return to the normal radio reception, press **(ENTER)**.

Tips

- To erase or correct a name, enter "_" (under-bar) for each character.
- There is another way to start storing station names. Press **(LIST)** for two seconds instead of steps 2 and 3. You can also complete the operation by pressing **(LIST)** for two seconds instead of step 5.

Displaying the station name

Press **(DSPL)** during radio reception.

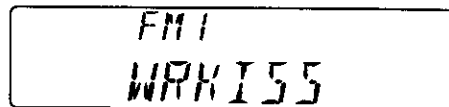

Each time you press **(DSPL)**, the item changes as follows:

Station name* ↔ Frequency

* If the station name of a station is not stored, "NO NAME" appears in the display for one second.

Erasing the station name

- 1 Tune in a station whose name you want to erase.
- 2 Press **(MENU)**, then press either side of **(DISC/PRST)** repeatedly until "NAME DEL" appears.
- 3 Press **(ENTER)**.
- 4 Press **(ENTER)** for two seconds.
The name is erased.
Repeat steps 1 through 4 if you want to erase other names.
- 5 Press **(MENU)** twice.
The unit returns to the normal radio reception mode.

Note

When you erase all of the station names, "NO NAME" appears in step 4.

Locating a station by name — List-up

- 1 Press **LIST** momentarily.
The name assigned to the station currently tuned appears in the display

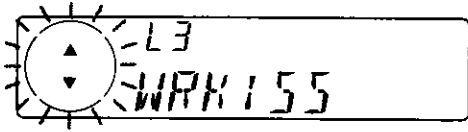

- 2 Press either side of **DISC/PRST** repeatedly until you find the desired station.
When no name is assigned to the selected station, the frequency appears in the display

- 3 Press **ENTER** to tune in the desired station.

Notes

- Once the station name or frequency has been displayed for five seconds, the display goes back to its normal mode
- When you connect a TV tuner, the list-up indication will not appear in the display of the unit

Other Functions

You can also control the unit with a rotary commander

Labeling the rotary commander

Depending on how you mount the rotary commander, attach the appropriate label as shown in the illustration below

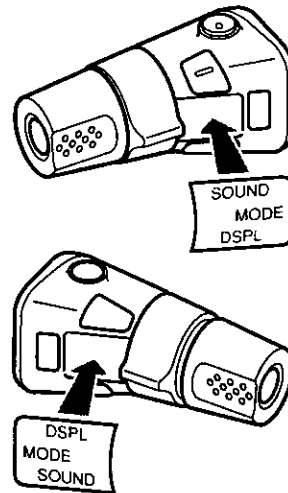

Using the rotary commander

The rotary commander works by pressing buttons and/or rotating controls. You can also control an optional CD/MD unit with the rotary commander.

By pressing buttons (the SOURCE and MODE buttons)

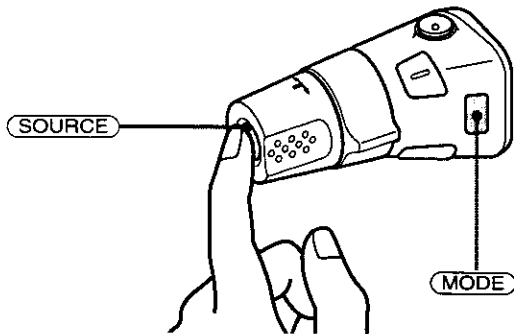

Each time you press **(SOURCE)**, the source changes as follows:

Tuner → CD → MD* → TV*

** If the corresponding optional equipment is not connected, these items will not appear.*

Pressing **(MODE)** changes the operation in the following ways:

- Tuner: FM1 → FM2 → FM3 → AM1 → AM2
- CD unit*: CD1 → CD2 → ...
- MD unit*: MD1 → MD2 → ...
- TV/Video*: TV1 → TV2 → AUX

** If the corresponding optional equipment is not connected, these items will not appear.*

By rotating the control (the SEEK/AMS control)

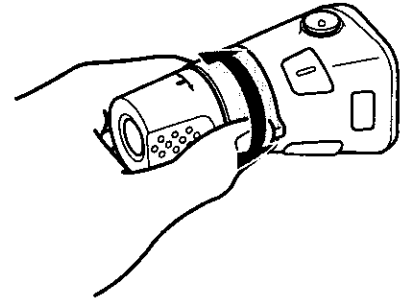

Rotate the control momentarily and release it to:

- Locate a specific track on a disc. Rotate and hold the control until you locate the specific point in a track, then release it to start playback.
- Tune in stations automatically. Rotate and hold the control to find a specific station.

By pushing in and rotating the control (the PRESET/DISC control)

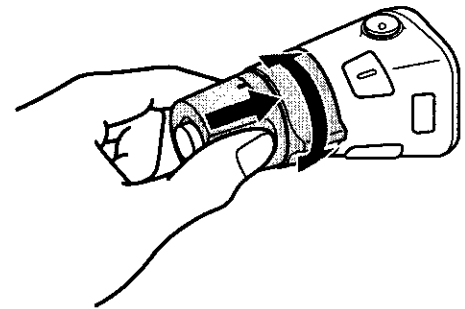

Push in and rotate the control to:

- Receive the stations memorized on the number buttons.
- Change the disc.

Other operations

Rotate the VOL control to adjust the volume.

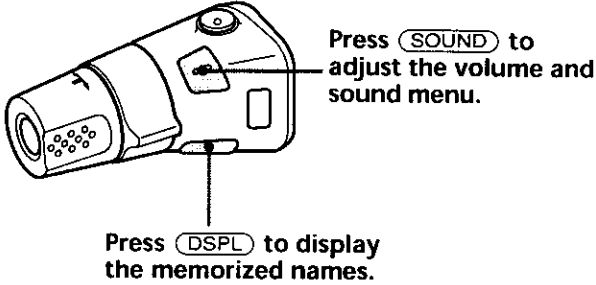
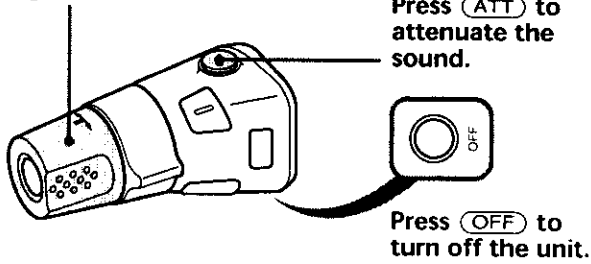

Tip

If your car has no ACC (accessory) position on the ignition key switch, be sure to press (OFF) for two seconds to turn off the clock indication after turning off the engine.

Changing the operative direction

The operative direction of controls is factory-set as shown below.

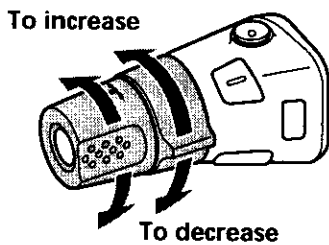

If you need to mount the rotary commander on the right hand side of the steering column, you can reverse the operative direction.

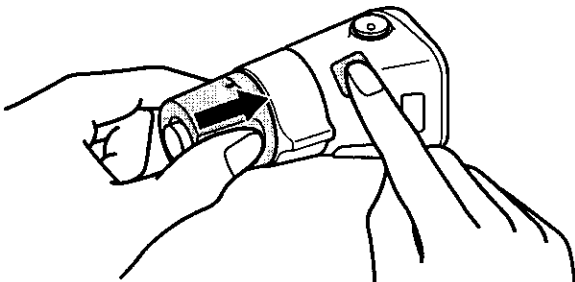

Press (SOUND) for two seconds while pushing the VOL control.

Tip

You can also change the operative direction of these controls with the unit (see "Changing the sound and display settings" on page 21).

Adjusting the sound characteristics

You can adjust the bass, treble, balance, and fader.

You can store the bass and treble levels independently for each source.

1 Select the item you want to adjust by pressing (SOUND) repeatedly.

Each time you press (SOUND), the item changes as follows:

BAS (bass) → TRE (treble) → BAL (left-right) → FAD (front-rear)

2 Adjust the selected item by pressing either side of (SEEK/AMS).

When adjusting with the rotary commander, press (SOUND) and rotate the VOL control.

Note

Adjust within three seconds after selecting the item.

Attenuating the sound

Press (ATT) on the rotary commander or card remote commander.

"ATT-ON" flashes momentarily.

To restore the previous volume level, press (ATT) again.

Tip

When the interface cable of a car telephone is connected to the ATT lead, the unit decreases the volume automatically when a telephone call comes in (Telephone ATT function).

Changing the sound and display settings

The following items can be set:

SET (setting)

- CLOCK (page 8)
- BEEP — to turn the beeps on or off.
- RM (Rotary Commander) — to change the operative direction of the controls of the rotary commander.
 - Select "NORM" to use the rotary commander as the factory-set position.
 - Select "REV" when you mount the rotary commander on the right side of the steering column.

DIS (display)

- D.INFO (Dual Information) — to display the clock and the play mode at the same time (ON).
- AMBER/GREEN*¹ — to change the illumination color to amber or green.
- M.DSPL (Motion Display) — to turn the motion display on or off.
- A.SCRL (Auto Scroll) (page 10)

P/M

- HPF (High pass filter for the pre-output)*² — to select the roll off frequency of the pre-output.
- SUB LPF (Low pass filter for the subwoofer output)*² — to select the roll off frequency of the subwoofer output.

*¹ CDX-C5005 only

*² CDX-C7000X only

Note

If you connect an optional power amplifier and do not use the built-in amplifier, the beep sound will be disabled.

1 Press **(MENU)**.

2 Press either side of **(DISC/PRST)** repeatedly until the desired item appears.

Each time you press the (-) side of **(DISC/PRST)**, the item changes as follows:

CLOCK → BEEP → RM → D.INFO → AMBER/GREEN*¹ → M.DSPL → A.SCRL*²

*¹ CDX-C5005 only

*² When no CD or MD is playing, this item will not appear.

Note

The displayed item will differ depending on the source.

Tip

You can easily switch among categories ("SET", "DIS", "P/M" (play mode), and "EDT" (edit mode)) by pressing either side of **(DISC/PRST)** for two seconds.

3 Press the (+) side of **(SEEK/AMS)** to select the desired setting (Example: ON or OFF) or press either side of **(SEEK/AMS)** repeatedly to select the frequency (Example: off, 80 Hz, 120 Hz).

4 Press **(ENTER)**.

After the mode setting is completed, the display returns to normal play mode.

Boosting the bass sound

— D-bass

You can enjoy a clear and powerful bass sound.

The D-bass function boosts the low and high frequency signal with a sharper curve than conventional bass boost.

You can hear the bass line more clearly even while the vocal volume remains the same. You can emphasize and adjust the bass sound easily with the D-BASS button.

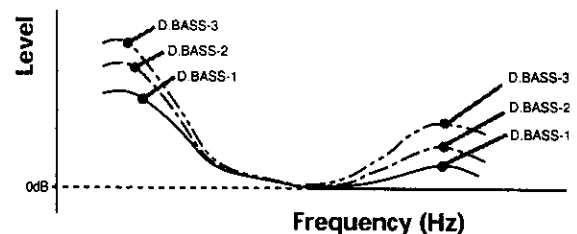

Adjusting the bass curve

Press **(D-BASS)** repeatedly until the desired bass level (1, 2, or 3) appears in the display.

To cancel, select "D.BASS-OFF."

Note

If the bass sound becomes distorted, select a less effective setting of "D.BASS" or adjust the volume.

TV/Video (optional)

You can connect an optional TV tuner and TV monitor to this unit.

Watching the TV

- 1 Press **(SOURCE)** repeatedly until "TV" appears.
- 2 Press either side of **(DISC/PRST)** repeatedly to select the desired TV band.

Watching a video

- 1 Press **(SOURCE)** repeatedly until "TV" appears.
- 2 Press **(MODE)** repeatedly to select "AUX."
Play the video

Notes

- The indication automatically switches to "VIDEO 1" soon after "AUX" is displayed
- "VIDEO 2" appears if the VIDEO 2 terminal of the TV monitor is selected

Memorizing TV channels automatically

The unit selects the TV channels with the strongest signals and memorizes them in the order of their frequency

Caution

When tuning in a station while driving, use Best Tuning Memory to prevent accidents

- 1 Press **(SOURCE)** repeatedly until "TV" appears.
- 2 Press **(MENU)**, then press either side of **(DISC/PRST)** until "AUTO MEM" appears.
- 3 Press **(ENTER)**.
The unit stores TV channels in the order of their frequencies on the number buttons. A beep sounds when the setting is stored.

Notes

- The unit does not store TV channels with weak signals. If only a few TV channels can be received, some number buttons will remain empty
- When a preset number is indicated in the display, the unit starts storing TV channels from the one currently displayed.

Memorizing only the desired TV channels

You can store up to 12 channels (6 each for TV1 and TV2) on the number buttons in the order of your choice

- 1 Press **(SOURCE)** repeatedly until "TV" appears.
- 2 Press either side of **(SEEK/AMS)** to tune in the TV channel you want to store on each number button.
- 3 Press and hold the desired number button (**①** to **⑥**) until you hear a beep sound.
The number button indication and "MEM" appear in the display

Note

If you try to store another channel on the same number button, the previously stored channel will be erased

Storing the TV channel names

Follow the steps in "Storing the station names" (page 17).

Displaying the TV or radio station names

Press **(LIST)** during TV or radio reception.

Example: When receiving the FM1 band

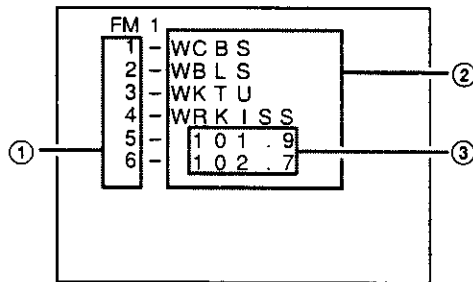

- ① Preset numbers
- ② Stored station names
- ③ Frequencies*

* If the name of a station is not stored, the frequency of that station will be displayed instead.

Notes

- It may take some time before all indications appear in the display.
- The TV channel does not appear during list display.
- The contents of the preset memory cannot be listed when the unit is in simultaneous play mode (page 23).

Turning off the display

During radio reception, press **(LIST)** again.

During TV reception, the list display on the TV monitor will automatically turn off after a few seconds.

Displaying the information stored on discs

Press **(LIST)** during CD/MD playback.

Example: When CD unit 1 is selected.

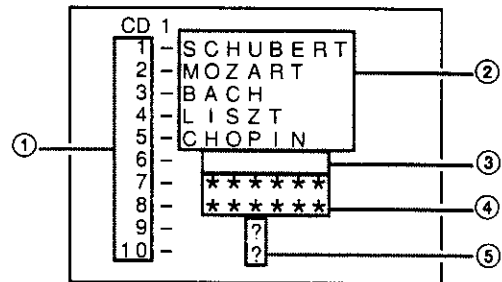

- ① Disc numbers
- ② Titles stored as custom files
- ③ No disc is loaded*¹
- ④ No stored titles*²
- ⑤ TOC information has not been identified yet*³

*¹ A blank space displayed next to a disc number represents empty slots in the disc magazine.

*² If a title is not registered in the custom file, "*****" is displayed.

*³ If the disc information has not yet been read by the unit, "?" is displayed.

Notes

- It may take some time before all indications appear in the display.
- The TV channel does not appear during list display.
- The contents of the preset memory cannot be listed when the unit is in the simultaneous play mode (page 23).

Turning off the display

Press **(LIST)** again.

Watching the TV or video while listening to a CD or MD — Simultaneous Play

The simultaneous play function does not work while you are listening to the radio.

Continue to next page →

1 Press **MENU**, then press either side of **DISC/PRST** repeatedly until "SML" appears.

2 Press **ENTER**.



3 Press the (-) side of **SEEK/AMS**.

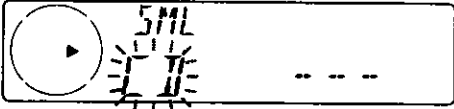

4 Press **SOURCE** repeatedly to select CD or MD.

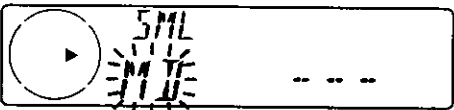

5 Press the (+) side of **SEEK/AMS**.



6 Press **SOURCE** repeatedly to select a TV or video.

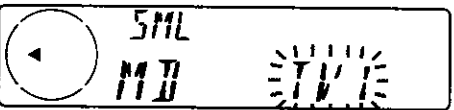

7 Press **ENTER**.
Simultaneous Play starts

If you are already watching the TV or video and want to listen to a CD or MD as well, follow the same steps

Returning to normal mode

To cancel the CD or MD, select "- - -" in step 3.

To cancel the TV or video, select "- - -" in step 5.

Note

If you press **EJECT** on a CD/MD unit while the unit is in simultaneous play mode, Simultaneous Play is canceled.

Additional Information

Maintenance

Fuse replacement

When replacing the fuse, be sure to use one matching the amperage rating stated on the original fuse. If the fuse blows, check the power connection and replace the fuse. If the fuse blows again after replacement, there may be an internal malfunction. In such a case, consult your nearest Sony dealer.

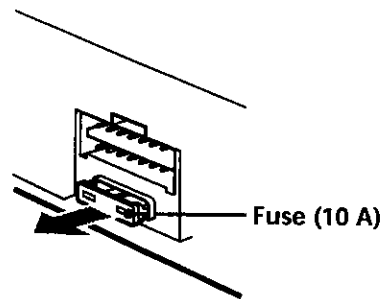

Warning

Never use a fuse with an amperage rating exceeding the one supplied with the unit as this could damage the unit.

Cleaning the connectors

The unit may not function properly if the connectors between the unit and the front panel are not clean. In order to prevent this, open the front panel by pressing (OPEN), then detach it and clean the connectors with a cotton swab dipped in alcohol. Do not apply too much force. Otherwise, the connectors may be damaged.

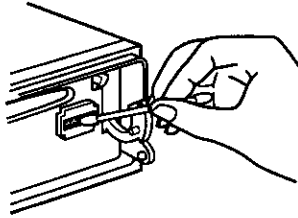

Main unit

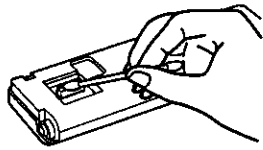

Back of the front panel

Notes

- For safety, turn off the engine before cleaning the connectors, and remove the key from the ignition switch.
- Never touch the connectors directly with your fingers or with any metal device.

Dismounting the unit

- 1 Press the clip inside the front cover with a thin screwdriver, and gently pry the front cover free.

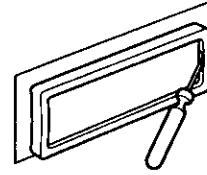

- 2 Repeat step 1 on the left side. The front cover is removed.

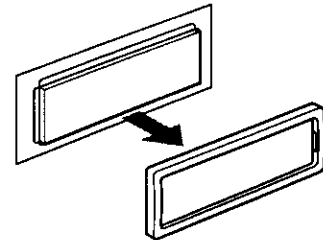

- 3 Use a thin screwdriver to push in the clip on the left side of the unit, then pull out the left side of the unit until the catch clears the mounting.

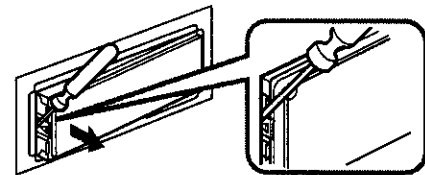

- 4 Repeat step 3 on the right side.

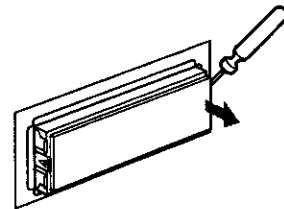

- 5 Slide the unit out of the mounting.

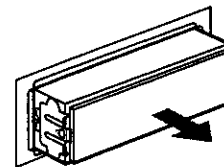

Specifications

AUDIO POWER SPECIFICATIONS

POWER OUTPUT AND TOTAL HARMONIC DISTORTION

19 watts per channel minimum continuous average power into 4 ohms, 4 channels driven from 20 Hz to 20 kHz with no more than 1% total harmonic distortion.

Other specifications

CD player section

System	Compact disc digital audio system
Signal-to-noise ratio	90 dB
Frequency response	10 - 20,000 Hz
Wow and flutter	Below measurable limit
Laser Diode Properties	
Material	GaAlAs
Wavelength	780 nm
Emission Duration	Continuous
Laser output power	Less than 44.6 μ W*

* This output is the value measured at a distance of 200 mm from the objective lens surface on the Optical Pick-up Block.

Tuner section

FM

Tuning range	CDX-C7000X/C5000X 87.5 - 107.9 kHz CDX-C5005 FM tuning interval: 50 kHz/200 kHz switchable 87.5 - 108 MHz (at 50 kHz step) 87.5 - 107.9 MHz (at 200 kHz step)
Antenna terminal	External antenna connector
Intermediate frequency	10.7 MHz/450 kHz
Usable sensitivity	8 dBf
Selectivity	75 dB at 400 kHz
Signal-to-noise ratio	66 dB (stereo), 72 dB (mono)
Harmonic distortion at 1 kHz	0.6 % (stereo), 0.3 % (mono)
Separation	35 dB at 1 kHz
Frequency response	30 - 15,000 Hz

AM

Tuning range	CDX-C7000X/C5000X 530 - 1,710 kHz CDX-C5005 AM tuning interval: 9 kHz/10 kHz switchable 531 - 1,602 kHz (at 9 kHz step) 530 - 1,710 kHz (at 10 kHz step)
Antenna terminal	External antenna connector
Intermediate frequency	10.7 MHz/450 kHz
Sensitivity	30 μ V

Power amplifier section

Outputs	Speaker outputs (sure seal connectors)
Speaker impedance	4 - 8 ohms
Maximum power output	50 W \times 4 (at 4 ohms)

General

Outputs	Audio outputs Power antenna relay control lead Power amplifier control lead Telephone ATT control lead
Tone controls	Bass \pm 9 dB at 100 Hz Treble \pm 9 dB at 10 kHz
Power requirements	12 V DC car battery (negative ground)
Dimensions	Approx. 178 \times 50 \times 183 mm (7 $\frac{1}{8}$ \times 2 \times 7 $\frac{1}{4}$ in.) (w/h/d)
Mounting dimensions	Approx. 182 \times 53 \times 162 mm (7 $\frac{1}{4}$ \times 2 $\frac{1}{8}$ \times 6 $\frac{1}{2}$ in.) (w/h/d)
Mass	Approx. 1.2 kg (2 lb. 10 oz.)
Supplied accessories	Parts for installation and connections (1 set) Front panel case (1) Card remote commander RM-X91 (CDX-C7000X only)
Optional accessories	Rotary commander RM-X4S Card remote commander RM-X91 BUS cable (supplied with an RCA pin cord) RC-61 (1 m), RC-62 (2 m)
Optional equipment	CD changer (10 discs) CDX-838, CDX-737, CDX-636 MD changer (6 discs) MDX-65 Other CD/MD changers with the Sony-BUS system Source selector XA-C30 TV tuner XT-40V, etc

Design and specifications are subject to change without notice.

Troubleshooting guide

The following checklist will help you remedy the problems you may encounter with your unit. Before going through the checklist below, check the connection and operating procedures.

General

Problem	Cause/Solution
No sound.	<ul style="list-style-type: none">• Cancel the ATT function.• Set the fader control to the center position for two-speaker system.• Rotate the dial clockwise to adjust the volume.
The contents of the memory have been erased.	<ul style="list-style-type: none">• The power cord or battery has been disconnected.• The reset button has been pressed. → Store again into the memory.
Indications do not appear in the display.	Remove the front panel and clean the connectors. See "Cleaning the connectors" (page 25) for details.
No beep sound.	<ul style="list-style-type: none">• The beep sound is cancelled (page 21).• If you connect an optional amplifier and do not use the built-in amplifier, the beep sound will be deactivated.

CD/MD playback

Problem	Cause/Solution
A disc cannot be loaded.	<ul style="list-style-type: none">• Another CD is already loaded.• The CD is forcibly inserted upside down or in the wrong way.
Playback does not begin.	Defective MD or dirty CD.
A disc is automatically ejected.	The ambient temperature exceeds 50 °C (122 °F).
CD will not be ejected.	You have closed the front panel or pushed the disc forcibly into the unit while the unit was ejecting the disc after you pressed ▲ . → Press the reset button.
The operation buttons do not function.	Press the reset button.
The sound skips due to vibration.	<ul style="list-style-type: none">• The unit is installed at an angle of more than 60 °.• The unit is not installed in a sturdy part of the car.
The sound skips.	A dirty or defective disc.
Cannot turn off the "-----" indication.	You cannot label CDs unless you connect a CD unit with the custom file function. → Press (LIST) for two seconds.

Radio reception

Problem	Cause/Solution
Preset tuning is not possible.	<ul style="list-style-type: none"> • Store the correct frequency in the memory. • The broadcast signal is too weak.
The stations cannot be received. The sound is hampered by noises.	Connect a power antenna control lead (blue) or accessory power supply lead (red) to the power supply lead of a car's antenna booster. (Only when your car has built-in FM/AM antenna in the rear/side glass.)
Automatic tuning is not possible.	The broadcast signal is too weak. → Use manual tuning.
The "ST" indication flashes.	<ul style="list-style-type: none"> • Tune in the frequency accurately. • The broadcast signal is too weak. → Set to the MONO mode (page 16).
Interference occurs during FM reception.	The WIDE mode is selected. → Set the IF mode to IF AUTO (page 16).

Error displays (when an optional CD/MD unit is connected)

The following indications will flash for about five seconds, and an alarm sound will be heard.

Display	Cause	Solution
NO MAG	The disc magazine is not inserted in the CD/MD unit.	Insert the magazine in the CD/MD unit.
NO DISC	No disc is inserted in the CD/MD unit.	Insert discs in the CD/MD unit.
NG DISCS	A CD/MD cannot play because of some problem.	Insert another CD/MD.
ERROR* ¹	A CD is dirty or inserted upside down.* ²	Clean or insert the CD correctly.
	An MD does not playback because of some problem.* ²	Insert another MD.
BLANK* ¹	No tracks have been recorded on an MD.* ²	Play an MD with recorded tracks on it.
RESET	The CD/MD unit cannot be operated because of some problem.	Press the reset button on the unit.
NO READY	The lid of the MD unit is open or the MDs are not inserted properly.	Close the lid or insert the MDs properly.
HI TEMP	The ambient temperature is more than 50 °C (122 °F).	Wait until the temperature goes down below 50 °C (122 °F).

*¹ When an error occurs during playback of an MD or CD, the disc number of the MD or CD does not appear in the display.

*² The disc number of the disc causing the error appears in the display.

If the above-mentioned solutions do not help improve the situation, consult your nearest Sony dealer.