

Compact Disc Player

Operating Instructions



CDP-CX225

WARNING

To prevent fire or shock hazard, do not expose the unit to rain or moisture.

To avoid electrical shock, do not open the cabinet. Refer servicing to qualified personnel only.

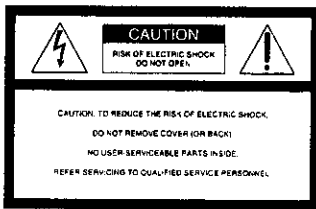

This symbol is intended to alert the user to the presence of uninsulated "dangerous voltage" within the product's enclosure that may be of sufficient magnitude to constitute a risk of electric shock to persons.



This symbol is intended to alert the user to the presence of important operating and maintenance (servicing) instructions in the literature accompanying the appliance.

INFORMATION

This equipment has been tested and found to comply with the limits for a Class B digital device, pursuant to Part 15 of the FCC Rules. These limits are designed to provide reasonable protection against harmful interference in a residential installation. This equipment generates, uses, and can radiate radio frequency energy and, if not installed and used in accordance with the instructions, may cause harmful interference to radio communications. However, there is no guarantee that interference will not occur in a particular installation. If this equipment does cause harmful interference to radio or television reception, which can be determined by turning the equipment off and on, the user is encouraged to try to correct the interference by one or more of the following measures:

- Reorient or relocate the receiving antenna.
- Increase the separation between the equipment and receiver.
- Connect the equipment into an outlet on a circuit different from that to which the receiver is connected.
- Consult the dealer or an experienced radio/TV technician for help.

CAUTION

You are cautioned that any changes or modification not expressly approved in this manual could void your authority to operate this equipment.

This equipment is intended for home entertainment purposes only. The warranty shall be invalidated if used in commercial environments, such as by disc jockeys, etc., even within the Warranty Period.

Owner's Record

The model and serial numbers are located at the rear of the unit. Record the serial number in the space provided below. Refer to them whenever you call upon your Sony dealer regarding this product.

Model No. CDP-CX225

Serial No. _____

Welcome!

Thank you for purchasing the Sony Compact Disc Player. Before operating the unit, please read this manual thoroughly and retain it for future reference.

About This Manual

The instructions in this manual are for model CDP-CX225.

Conventions

- Instructions in this manual describe the controls on the player. You can also use the controls on the remote if they have the same or similar names as those on the player.
- The following icons are used in this manual:



Indicates that you can do the task using the remote.



Indicates hints and tips for making the task easier.

TABLE OF CONTENTS

Getting Started

Unpacking	4
Hooking Up the System	4
Inserting CDs	6

Playing a CD

8

Playing CDs

Locating a Specific Disc	10
Specifying the Next Disc to Play	10
Locating a Specific Track or a Point in a Track	11
Playing Repeatedly	12
Playing in Random Order (Shuffle Play)	12
Creating Your Own Program (Program Play)	13
Playing Discs in a Group (Block Play)	15

Additional Information

Precautions	16
Notes on CDs	16
Troubleshooting	17
Specifications	17

Index

18

Unpacking

Check that you received the following items:

- Audio cord (1)
- Remote commander (remote) (1)
- Size AA (R6) batteries (2)
- CD booklet holders (2) and label (1)

💡 How to use the CD booklet holder

The CD booklet holder helps you locate the disc easily. After you have inserted discs into the player, you can put the CD booklet (which comes with a CD) into the supplied holder. Put two CD booklets facing back to back into a pocket. Stick the number label on each pocket, matching the number of the disc slot where you have inserted the disc. You can put up to 200 CD booklets into the holders.

Inserting batteries into the remote

You can control the player using the supplied remote. Insert two size AA (R6) batteries by matching the + and - on the batteries to the diagram inside the battery compartment.

Insert the negative (-) end first, then push in and down until the positive (+) end clicks into position.

When using the remote, point it at the remote sensor  on the player.

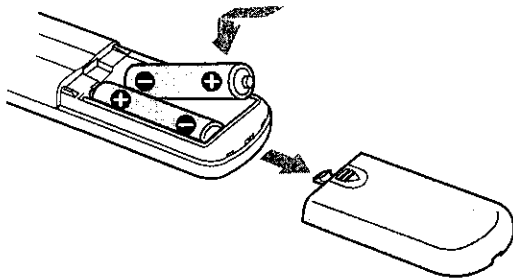

💡 When to replace batteries

With normal use, the batteries should last for about six months. When the remote no longer operates the player, replace all the batteries with new ones.

Notes

- Do not leave the remote near an extremely hot or humid place.
- Do not drop any foreign object into the remote casing, particularly when replacing the batteries.
- Do not expose the remote sensor to direct sunlight or lighting apparatuses. Doing so may cause a malfunction.
- If you do not use the remote for an extended period of time, remove the batteries to avoid possible damage from battery leakage and corrosion.

Hooking Up the System

Overview

This section describes how to hook up the CD player to an amplifier. Be sure to turn off the power of each component before making the connections.

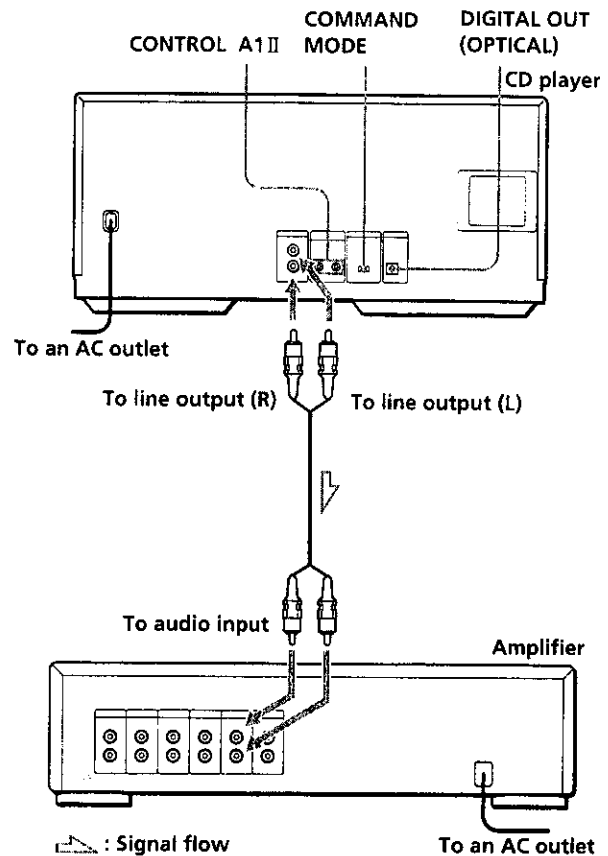

What cords will I need?

Audio cord (1) (supplied)

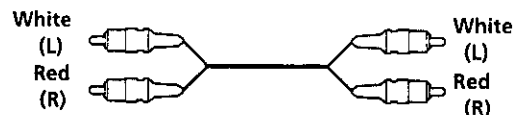

Hookups

When connecting the audio cord, be sure to match the color-coded cord to the appropriate jacks on the components: Red (right) to Red and White (left) to White. Be sure to make connections firmly to avoid hum and noise.

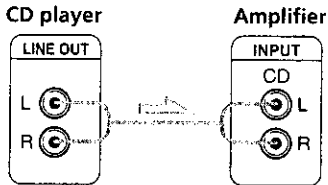

- **If you have a digital component such as a digital amplifier, D/A converter, DAT or MD**

Connect the component via the DIGITAL OUT (OPTICAL) connector using an optical cable (not supplied). Take off the cap and plug in the optical cable.

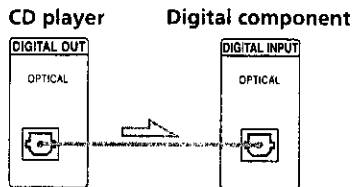
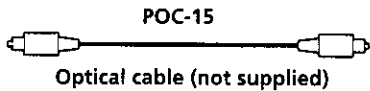

Note

When you connect via the DIGITAL OUT (OPTICAL) connector, noise may occur when you play CD software other than music, such as a CD-ROM.

- **If you have a Sony receiver (amplifier) equipped with the CONTROL A1 II jack**

Be sure to connect the player to the CD IN jacks on the receiver (amplifier). When making this connection, set the COMMAND MODE of the player to CD1 (see the illustration below). If you further connect the player and the receiver (amplifier) via the CONTROL A1 II jacks with the monaural (2P) mini-plug cord (not supplied), you can use the Auto Function feature between these components. For details, refer to the supplementary "CONTROL-A1 II Control System" instructions and the instructions supplied with the receiver (amplifier).

💡 When to use the COMMAND MODE selector

The COMMAND MODE selector is set to CD1 at the factory for normal use. You can control this player by connecting to a Sony CD Player with the player control function, via the CONTROL A1 II jacks. When making this connection, set the COMMAND MODE selectors of each player to the appropriate position according to the connected line input jacks. For details, refer to the instructions supplied with the connected player.

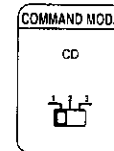

💡 When using another Sony CD player together with this player

You can make the supplied remote effective only for this player.

- When using the player equipped with the COMMAND MODE selector:
Set the COMMAND MODE selector of this player to CD1 and that of another player to CD2 or CD3. Then set the CD1/2/3 switch on the remote supplied for each player accordingly.
- When using the player not equipped with the COMMAND MODE selector:
The command mode of the player without the COMMAND MODE selector is set to CD1. Set the COMMAND MODE selector of this player to CD2, and set the CD1/2/3 switch on the remote to CD2.

Connecting the AC power cord

Connect the AC power cord to a wall outlet.

Note on placement

Be sure to place the player on a horizontal place. If the player is slanted, it may cause malfunction or damage the player.

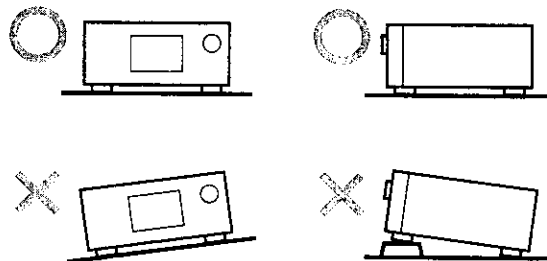

Inserting CDs

You can insert up to 200 discs into this player.

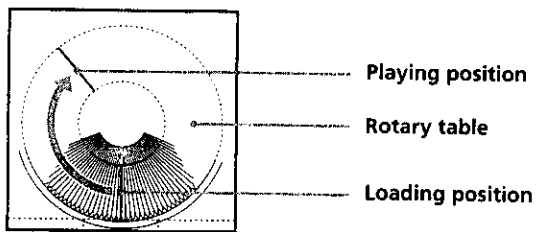
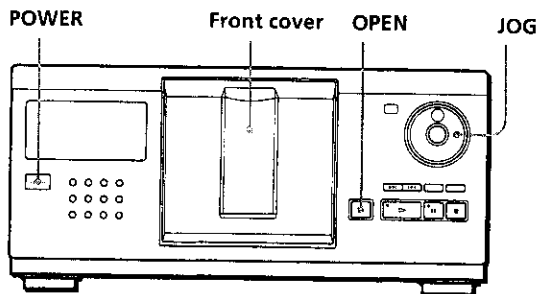

- 1 Press POWER to turn on the player.
- 2 Press OPEN.

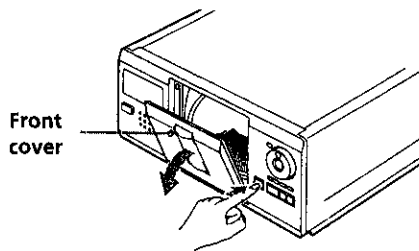

- 3 Turn the JOG dial until you find the disc slot where you want to insert a disc, while checking the disc number (written beside every five slots and also indicated in the display).

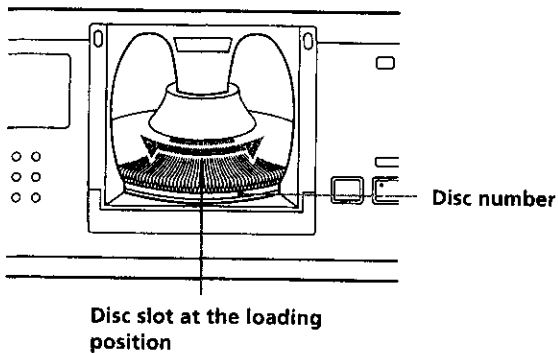

The disc number at the loading position appears in the display.* As you turn the JOG dial, the disc number changes.

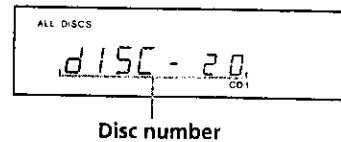

You can arrange your discs into groups and play them within a certain group using the Block Play function. When using this function, you have to insert discs into the slots assigned to one of the eight groups. For details, see "Playing Discs in a Group" on page 15.

* If you have already inserted discs, the disc number at the playing position appears. When you turn the JOG dial, the displayed disc number changes to the one at the loading position.

- 4 Insert a disc with the label side facing right.

Notes

- Make sure you have inserted the disc into each slot at a right angle to the rotary table. If the disc is not put in straight, it may damage the player or the disc.
- Make sure the rotary table comes to a complete stop before inserting or removing discs.

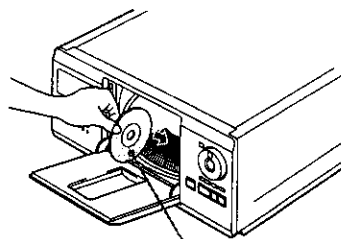

With the label side facing right

- 5 Repeat Steps 3 and 4 to insert more discs.

- 6 Close the front cover by pressing the right edge of the cover until it clicks.

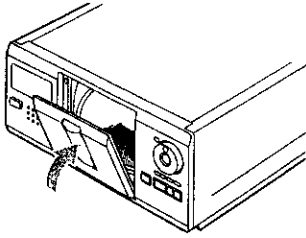

The rotary table turns and the disc slot at the loading position is set to the playing position. Always close the front cover except when you insert or remove discs.

💡 The supplied CD booklet holders help you locate a disc

You can store up to 200 CD booklets. Insert booklets and stick the number label on the film of a pocket and the booklet so that you can locate the disc easily.

Notes

- When you insert an 8 cm (3-inch) CD, be sure to attach a Sony CSA-8 adaptor (not supplied) to the disc. **Do not insert an empty 8 cm (3-inch) CD adaptor (CSA-8). It may damage the player.**
- **Do not attach anything such as seals or sleeves to CDs. It may damage the player or the disc.**
- If you drop a disc into the player and the CD won't go into the slot correctly, consult your nearest Sony dealer.
- When transporting the player, remove all discs from the player.

Removing CDs

After following Steps 1 to 3 of "Inserting CDs" on page 6, remove the discs. Then close the front cover.

Note

The disc being played does not come to the loading position if you open the front cover during playback. (The disc number flashes in the display.)

If you want to remove the disc being played, press ENTER in the center of the JOG dial after opening the front cover. The disc comes to the loading position. Remove the disc after the rotary table comes to a complete stop.

Playing a CD

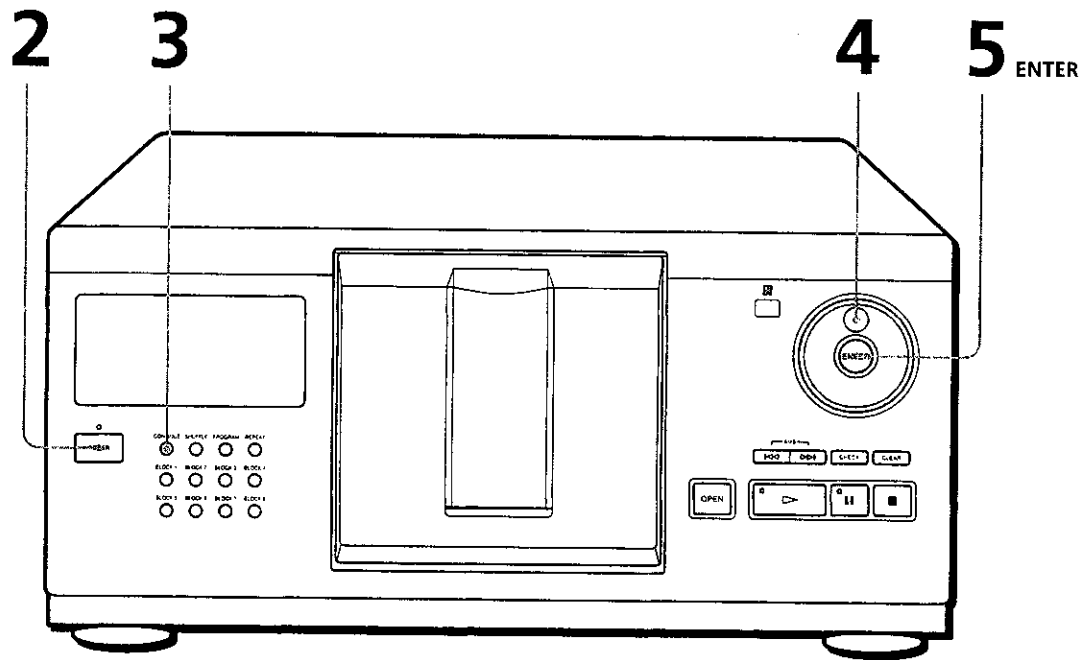

- See pages 4 – 5 for the hookup information.
- Make sure you have inserted the discs correctly as indicated on page 6.
- You can play all the tracks on a disc in the original order (Continuous Play). You can also play up to 200 discs consecutively.

You can turn on the player by pressing POWER on the remote .

- 1 Turn on the amplifier and select the CD player position.
- 2 Press POWER to turn on the player.
- 3 Press CONTINUE to select ALL DISCS or 1 DISC Continuous Play mode. Each time you press CONTINUE, "ALL DISCS" or "1 DISC" appears in the display.

When you select	The player plays
ALL DISCS	All discs in the player consecutively in the order of disc number. Empty disc slots are skipped.
1 DISC	Only one disc you have selected

- 4 Turn the JOG dial until the disc number you want appears in the display to select the first disc (ALL DISCS) or the disc you want (1 DISC).

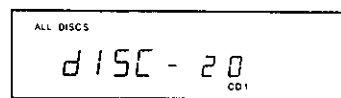

- 5 Press ENTER to start playing.
The selected disc is set to the playing position, and the player plays all the discs from the selected one (ALL DISCS) or all the tracks once (1 DISC).
Adjust the volume on the amplifier.

💡 When you turn off the player by pressing the POWER switch (standby mode)

The player remembers the last playing disc and the play mode (Continuous, Shuffle (see page 12) or Program (see page 13)). When you turn on the player again, therefore, the player plays the same disc in the same play mode. Note that the player does not remember this information, if you turn off the player by pressing the power switch of the amplifier or receiver while the AC power cord is connected to the switched AC outlet of the amplifier or receiver.

Display information while playing a disc

While playing a disc, the display shows the current disc number, track number, playing time of the track and the next disc number.

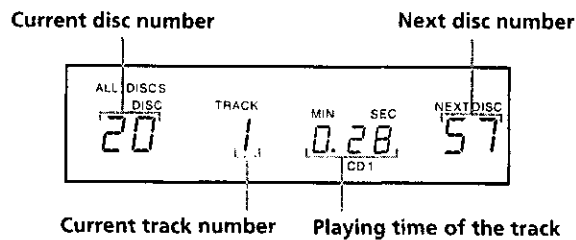

To stop playback

Press ■.

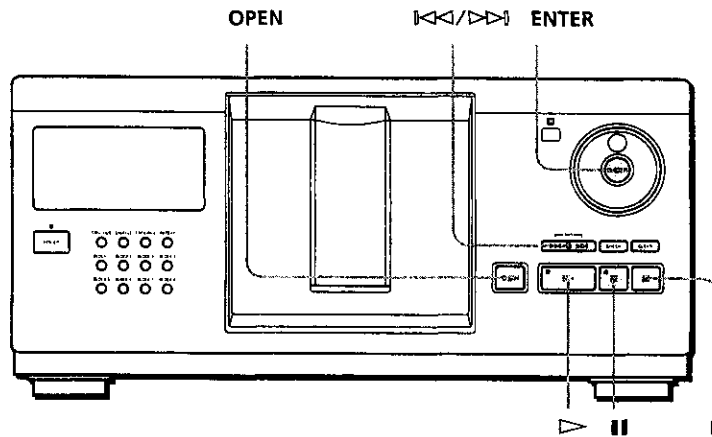

To	Press
Pause	■
Resume playing after pause	▶ or ▷
Go to the next disc	DISC SKIP + once. Hold down the button to skip discs.
Go back to the preceding disc	DISC SKIP - once. Hold down the button to skip discs.
Go to the next track	▷▶
Go back to the preceding track	◀◀
Stop playing and remove the disc	OPEN and then ENTER. The disc comes to the loading position.

Locating a Specific Disc

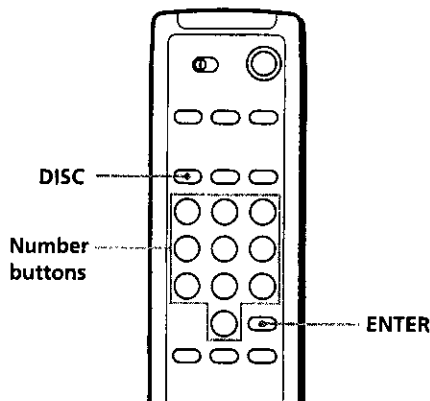
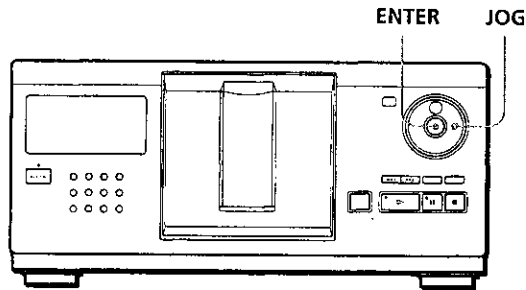

Specifying the Next Disc to Play

You can specify the next disc to play while playing a disc in Continuous or 1 DISC Shuffle Play mode.

While playing a disc, turn the JOG dial until the disc number you want appears in the display.

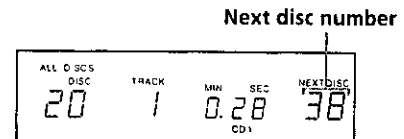

After the current disc is played, the next disc you have specified starts playing.

If you want to skip to the next disc right away, press ENTER while playing the current disc.

To cancel the disc you have specified
Press CONTINUE twice.

Selecting a disc on the player

Turn the JOG dial until the disc number you want appears in the display. Press ENTER to start play.

Selecting a disc directly using the remote

- 1 Press DISC.
- 2 Press the number button of the disc.
Example: To enter number 35
Press 3, then 5.
To enter number 100
Press 1, then 0 twice.
- 3 Press ENTER to start play.

Locating a Specific Track or a Point in a Track

You can quickly locate any track while playing a disc using the **⏮/⏭** (AMS: Automatic Music Sensor) buttons or number buttons on the remote. You can also locate a specific point in a track while playing a disc.

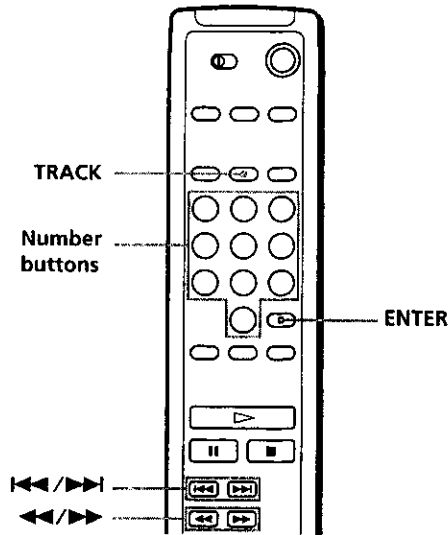
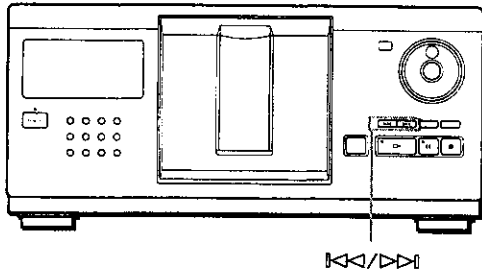

To locate	Press
the next or succeeding tracks	⏭ repeatedly until you find the track
the current or preceding tracks	⏮ repeatedly until you find the track
a specific track directly	TRACK, the number button of the track, and then ENTER. When you locate a track with a number over 10, press the 10's digit first, then the 1's digit.
a point in a track while monitoring the sound	⏭ (forward) or ⏮ (backward) and hold down until you find the point
a point in a track quickly by observing the display	⏭ (forward) or ⏮ (backward) and hold down until you find the point during pause. You will not hear the sound during the operation.

Note

If "77" appears in the display, the disc has reached the end while you were pressing **⏭**. Press **⏮** or **⏮/⏭** to go back.

Playing Repeatedly

You can play discs/tracks repeatedly in any play mode.

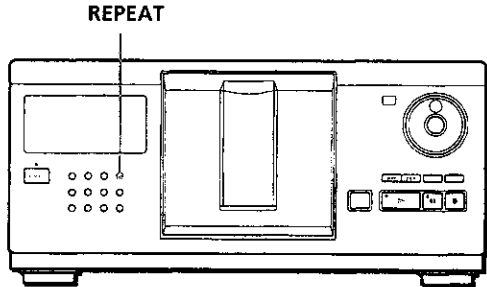

Press REPEAT while playing a disc. "REPEAT" appears in the display. The player repeats the discs/tracks as follows:

When the disc is played in	The player repeats
ALL DISCS Continuous Play (page 8)	All tracks on all discs
1 DISC Continuous Play (page 8)	All tracks on the current disc
ALL DISCS Shuffle Play (page 12)	The player does not repeat discs/tracks but keeps shuffling until you stop playback whether or not you press REPEAT.
1 DISC Shuffle Play (page 12)	All tracks on the current disc in random order
Program Play (page 13)	The same program

To cancel Repeat Play

Press REPEAT repeatedly until "REPEAT" disappears from the display.

Repeating the current track

You can repeat only the current track.

While the track you want is being played, press REPEAT repeatedly until "REPEAT 1" appears in the display.

Playing in Random Order (Shuffle Play)

You can have the player "shuffle" the tracks and play in random order. The player shuffles all the tracks on all discs or on the disc you specified.

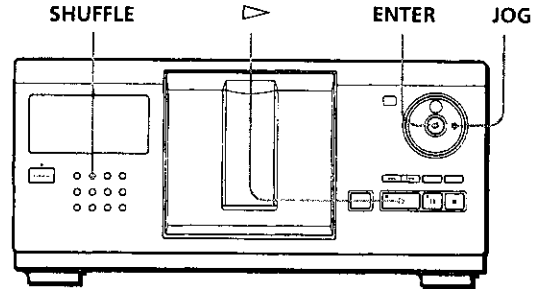

- 1 Press SHUFFLE to select ALL DISCS or 1 DISC Shuffle Play mode. Each time you press SHUFFLE, "ALL DISCS" or "1 DISC" appears in the display.

When you select	The player plays
ALL DISCS	All tracks on all discs in random order. The player keeps shuffling tracks until you stop playback.*
1 DISC	All tracks on the specific disc in random order

* The player may play the same track more than once.

- 2 When you want to specify the disc for 1 DISC Shuffle Play, turn the JOG dial until the disc number you want appears in the display.
- 3 Press ENTER or . ALL DISCS or 1 DISC Shuffle Play starts. " [] " appears in the display while the player is "shuffling" the discs or the tracks.

To cancel Shuffle Play

Press CONTINUE.

You can start Shuffle Play while playing

Press SHUFFLE, and Shuffle Play starts from the current track.

💡 You can directly select a disc for 1 DISC Shuffle Play 
See "Selecting a disc directly using the remote" on page 10.

💡 You can go to the next disc during 1 DISC Shuffle Play 
Press DISC SKIP +.

💡 You can specify the next disc to play during 1 DISC Shuffle Play
Turn the JOG dial to specify the next disc. After all the tracks on the current disc are played in random order, the next disc starts playing. If you want to skip to the next disc right away, press ENTER while playing the current disc.

Note
You cannot specify the next disc to play during ALL DISCS Shuffle Play.

Creating Your Own Program (Program Play)

You can arrange the order of the tracks and/or discs to create your own program and the program is stored automatically. A program can contain up to 32 "steps" — one "step" may contain a track or a whole disc. You can make a program using the controls on the remote as well as the ones on the player. However, the programming procedures are different.

Creating a program on the player

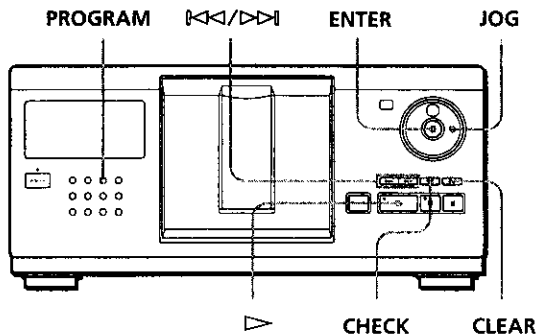

1 Press PROGRAM.
If a program is already stored, the last step of the program appears in the display. When you want to erase the whole program, hold down CLEAR until "All Clr" appears in the display (see page 14).

2 Turn the JOG dial until the disc number you want appears in the display.



Disc number

3 To program a whole disc, skip this step. Press \lll/\ggg until the track number you want appears in the display.

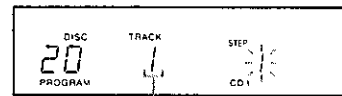

Track number

4 Press ENTER or PROGRAM.

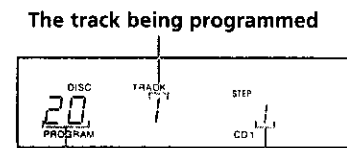

The disc being programmed Playing order

5 To program other discs/tracks, do the following:

To program	Repeat Steps
All tracks of another disc(s)	2 and 4
Other tracks on the same disc	3 and 4
Other tracks on other discs	2 to 4

6 Press \triangleright to start Program Play.

To cancel Program Play

Press CONTINUE.

💡 The program remains even after Program Play ends
When you press \triangleright , you can play the same program again.

💡 When you press PROGRAM during Continuous or Shuffle Play
The program will be played after the current track.

💡 The program remains until you erase them
If you replace discs, the programmed disc and track numbers remain. So, the player plays only the existing disc and track numbers. However, the disc and track numbers that are not found in the player or on the disc are deleted from the program, and the rest of the program is played in the programmed order.

Creating a program using the remote

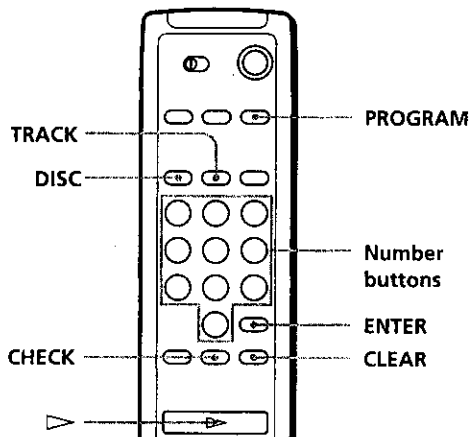

- 1** Press PROGRAM.
- 2** Press DISC.
- 3** Press the number button of the disc.
- 4** To program a whole disc, skip this step and go to Step 6. Press TRACK.
- 5** Press the number button of the track.
- 6** Press ENTER.
- 7** To program other discs/tracks, do the following:

To program	Repeat Steps
All tracks of another disc(s)	2, 3 and 6
Other tracks on the same disc	4 to 6
Other tracks on other discs	2 to 6

- 8** Press  to start Program Play.

To cancel Program Play

Press CONTINUE.

Checking the programmed order

You can check your program before or after you start playing.

Press CHECK.

Each time you press this button, the display shows the disc and track number of each step in the programmed order. (When a whole disc is programmed as one step, "AL" appears instead of the track number.) After the last step in the program, the display shows "End" and returns to the original display.

Changing the programmed order

You can change your program before you start playing.

To	You need to
Erase a track or disc	Press CHECK until the track or disc you want to erase appears in the display, then press CLEAR
Erase the last track or disc in the program	Press CLEAR. Each time you press the button, the last track or disc will be cleared.
Add tracks or discs to the end of the program	Follow the programming procedure
Erase the whole program completely	Hold down CLEAR until "All Clr" appears in the display to erase the whole program, then create a new program following the programming procedure

Erasing the program stored in memory

- 1** Press PROGRAM in the stop mode.
- 2** Hold down CLEAR until "All Clr" appears in the display.

Playing Discs in a Group (Block Play)

You can classify discs in advance by artists, category, etc. when inserting discs into the slots, and play them only within the group (called "block") you specified. The player has eight blocks, and each slot is assigned to one of the blocks as shown below.

Block number	Disc slot
1	1-25
2	26-50
3	51-75
4	76-100
5	101-125
6	126-150
7	151-175
8	176-200

You can enjoy Continuous, Shuffle or Repeat Play within a certain block.

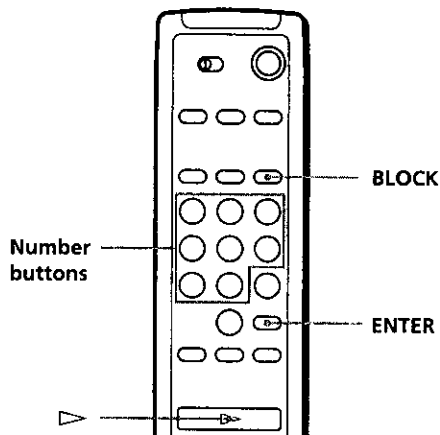
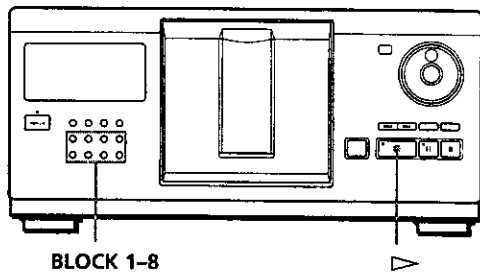

- 1 Insert discs into the slot of the block you want, referring to the table. (See also "Inserting CDs" on page 6.)
- 2 Press one of the BLOCK 1-8 buttons to select the block.
When using the remote, press BLOCK, the number button of the block you want, then ENTER.
The block number appears in the display.
- 3 Press \blacktriangleright .
Block Play starts from the disc which is the most upward number within a block and located closest to the playing position.

💡 You can start Block Play from the disc you want
When you want to start Block Play from the disc you want, turn the JOG dial to select the disc, then press ENTER.

To cancel Block Play

Press the corresponding BLOCK 1-8 button.

Note

The block number does not appear if no disc is put into the block you specified.

Precautions

On safety

- Caution — The use of optical instruments with this product will increase eye hazard.
- Should any solid object or liquid fall into the cabinet, unplug the player and have it checked by qualified personnel before operating it any further.

On power sources

- Before operating the player, check that the operating voltage of the player is identical with your local power supply. The operating voltage is indicated on the nameplate at the rear of the player.
- The player is not disconnected from the AC power source (mains) as long as it is connected to the wall outlet, even if the player itself has been turned off.
- If you are not going to use the player for a long time, be sure to disconnect the player from the wall outlet. To disconnect the AC power cord (mains lead), grasp the plug itself; never pull the cord.
- AC power cord must be changed only at the qualified service shop.

On placement

- Place the player in a location with adequate ventilation to prevent heat build-up in the player.
- Do not place the player on a soft surface such as a rug that might block the ventilation holes on the bottom.
- Do not place the player in a location near heat sources, or in a place subject to direct sunlight, excessive dust or mechanical shock.

On operation

- If the player is brought directly from a cold to a warm location, or is placed in a very damp room, moisture may condense on the lenses inside the player. Should this occur, the player may not operate properly. In this case, leave the player turned on for about an hour until the moisture evaporates.

On adjusting volume

- Do not turn up the volume while listening to a portion with very low level inputs or no audio signals. If you do, the speakers may be damaged when a peak level portion is played.

On cleaning

- Clean the cabinet, panel and controls with a soft cloth slightly moistened with a mild detergent solution. Do not use any type of abrasive pad, scouring powder or solvent such as alcohol or benzine.

On transportation

- When transporting the player, press OPEN then remove all the discs from the player and turn the power off.

If you have any questions or problems concerning your player, please consult your nearest Sony dealer.

Notes on CDs

On handling CDs

- To keep the disc clean, handle the disc carefully.
- Do not stick paper or tape on the disc.



- Do not expose the disc to direct sunlight or heat sources such as hot air ducts, nor leave it in a car parked in direct sunlight as there can be considerable rise in temperature inside the car.
- After removing a disc from the disc slot, store the disc in its case.

On cleaning

- Before playing, clean the disc with a cleaning cloth. Wipe the disc from the center out.

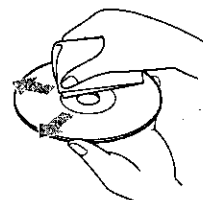

- Do not use solvents such as benzine, thinner, commercially available cleaners or anti-static spray intended for vinyl LPs.

Troubleshooting

If you experience any of the following difficulties while using the player, use this troubleshooting guide to help you remedy the problem. Should any problem persist, consult your nearest Sony dealer.

There is no sound.

- ➔ Check that the player is connected securely.
- ➔ Make sure you operate the amplifier correctly.

The CD does not play.

- ➔ There is no CD in a slot ("no DISC" appears). Insert a CD.
- ➔ Insert the CD with the label side facing right.
- ➔ Clean the CD (see page 16).
- ➔ Moisture has condensed inside the player. Press OPEN and leave the player turned on for about an hour (see page 16).

The remote does not function.

- ➔ Remove obstacles in the path of the remote and the player.
- ➔ Point the remote at the remote sensor  on the player.
- ➔ Replace all the batteries in the remote with new ones if they are weak.
- ➔ Set the CD1/2/3 switch on the remote according to the position of the COMMAND MODE selector displayed in the front panel display (see page 5).

The player functions incorrectly.

- ➔ The microcomputer chips may be operating incorrectly. Disconnect the AC power cord, then connect it back to the wall outlet to reset the player.

Specifications

Compact disc player

Laser	Semiconductor laser ($\lambda = 780 \text{ nm}$) Emission duration: continuous
Laser output	Max 44.6 μW^* * This output is the value measured at a distance of 200 mm from the objective lens surface on the Optical Pick-up block with 7 mm aperture.
Frequency response	20 Hz to 20 kHz $\pm 0.5 \text{ dB}$
Signal-to-noise ratio	More than 100 dB
Dynamic range	More than 98 dB
Harmonic distortion	Less than 0.0045%
Channel separation	More than 95 dB

Outputs

	Jack type	Maximum output level	Load impedance
LINE OUT	Phono jacks	2 V (at 50 kilohms)	Over 10 kilohms
DIGITAL OUT (OPTICAL)	Optical output connector	-18 dBm	Wave length: 660 nm

General

Power requirements	120 V AC, 60 Hz
Power consumption	13 W
Dimensions (approx.) (w/h/d)	When the front cover is closed 430 × 200 × 480 mm (17 × 7 7/8 × 19 in.) incl. projecting parts When the front cover is open 430 × 200 × 600 mm (17 × 7 7/8 × 23 5/8 in.) incl. projecting parts
Mass (approx.)	9.0 kg (19 lbs 14 oz)

Supplied accessories

- Audio cord (2 phono plugs – 2 phono plugs) (1)
- Remote commander (remote) (1)
- Size AA (R6) batteries (2)
- CD booklet holders (2)
- Label (1)

Design and specifications are subject to change without notice.

Index**A**

AMS 11
Automatic Music Sensor 11.

B

Block Play 15

C, D

Connecting 4
Continuous Play 8

E, F, G

Erasing
programs 14

H

Handling CDs 16
Hookups
overview 4

I

Inserting CDs 6

J, K

JOG dial 6

L, M, N O

Locating
a specific point 11
a specific track 11
by monitoring 11
by observing the display 11
directly 11
discs 10
using AMS 11

P, Q

Playback
Block Play 15
Continuous Play 8
Program Play 13
Repeat Play 12
Shuffle Play 12
Program
changing 14
checking 14
erasing 14

R

Remote control 4
Repeating 12
Rotary table 6

S

Searching. *See* Locating
Selecting a disc 10
Shuffle Play
on all discs 12
on one disc 12
Specifying the next disc 10

T

Troubleshooting 17

U, V, W, X, Y, Z

Unpacking 4

Names of controls**Buttons**

BLOCK 15
BLOCK 1-8 15
CHECK 14
CLEAR 14
CONTINUE 8
DISC 10
DISC SKIP 9
ENTER 9
Number 11
OPEN 6
PROGRAM 13
REPEAT 12
SHUFFLE 12
TRACK 11
◀◀/▶▶ 9
▷ 9
|| 9
■ 9
◀◀/▶▶ 11

Switches

CD1/2/3 5
POWER 6

Jacks

CONTROL A1II 5
LINE OUT 5

Connectors

DIGITAL OUT (OPTICAL) 5

Others

COMMAND MODE selector 5
Disc slots 6
Display 9
Front cover 6
JOG dial 6, 8
Rotary table 6
■ 4

