

Trinitron® Color TV

Operating Instructions

**KV-13M40
KV-13M50
KV-13M51**

**KV-20M40
KV-20S40
KV-20S41**

Warnings and Cautions

To prevent fire or shock hazard, do not expose the TV to rain or moisture.

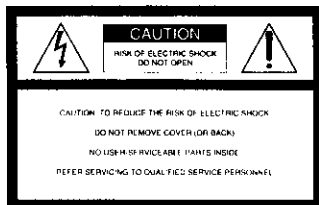

 This symbol is intended to alert the user to the presence of uninsulated "dangerous voltage" within the product's enclosure that may be of sufficient magnitude to constitute a risk of electric shock to persons.

 This symbol is intended to alert the user to the presence of important operating and maintenance (servicing) instructions in the literature accompanying the appliance.

CAUTION

When using TV games, computers, and similar products with your TV, keep the brightness and contrast functions at low settings. If a fixed (non-moving) pattern is left on the screen for long periods of time at a high brightness or contrast setting, the image can be permanently imprinted onto the screen. Continuously watching the same channel can cause the imprint of station logos onto the TV screen. These types of imprints are not covered by your warranty because they are the result of misuse.

You are cautioned that any changes or modifications not expressly approved in this manual could void your authority to operate this equipment.

Safety Precautions

- Operate the TV only on 120 V AC.
- One blade of the power plug is wider than the other for safety purposes and will fit into the power outlet only one way. If you are unable to insert the plug fully into the outlet, contact your dealer.
TO PREVENT ELECTRIC SHOCK, DO NOT USE THIS POLARIZED AC PLUG UNLESS THE BLADES CAN BE FULLY INSERTED TO PREVENT BLADE EXPOSURE.

- If any liquid or solid object falls into the TV, unplug it and have it checked by qualified personnel before operating it further.
- Unplug the TV from the wall outlet if you are not going to use it for several days or more. To disconnect the cord, pull it out by the plug. Never pull the cord itself.

For more safety information, see the "IMPORTANT SAFEGUARDS" leaflet packed with your TV.

Protecting the TV

- To prevent internal heat build-up, do not block the ventilation openings.
- Do not install the TV in a hot or humid place, or in a place subject to excessive dust or mechanical vibration.

Note on CAPTION VISION

This television receiver provides display of television closed captioning in accordance with § 15.119 of the FCC rules.

Note to CATV System Installer

Article 820-40 of the NEC that provides guidelines for proper grounding and, in particular, specifies that the cable ground shall be connected to the grounding system of the building, as close to the point of cable entry as practical.

Use of this television for other than private viewing of programs broadcast on UHF or VHF or transmitted by cable companies for the use of the general public may require authorization from the broadcaster/cable company and/or program owner.

Step 1: Connecting the TV

The following steps guide you through your initial set up. Check the model number of your TV (located on the front of this manual) and select the appropriate diagram.

Connecting an Indoor, Outdoor or Cable Antenna

This connection offers the best picture quality. Connection is made directly from the cable or antenna to the TV.

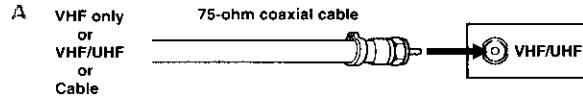

If you cannot connect your antenna or cable directly to the TV antenna terminal, follow one of the diagrams below.

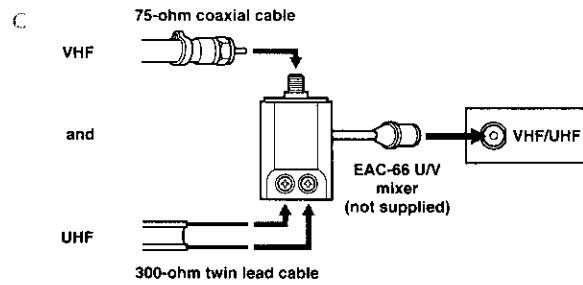
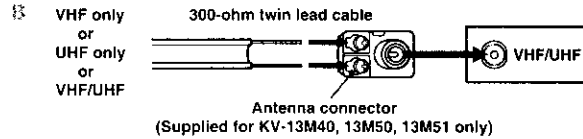

Connecting to a Cable TV System Through a Cable Box

Some pay cable TV systems use scrambled or encoded signals that require a cable box* to view all channels.

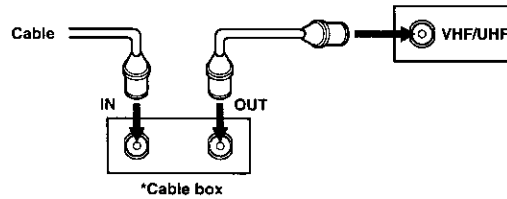

Note

- If you will be controlling all channel selection through your cable box, you should consider using the CHANNEL FIX feature discussed on page 11.

Connecting a VCR

See your VCR instructions to set up the VCR. After connecting the VCR to the TV, you will be able to do the following:

- Watch video tapes
- Record one TV program while viewing another

Notes

- If your cable system requires the use of a cable box, install it between the cable and the VCR.
- For a monaural VCR, connect the audio output of the VCR to the AUDIO L (MONO) on the TV.

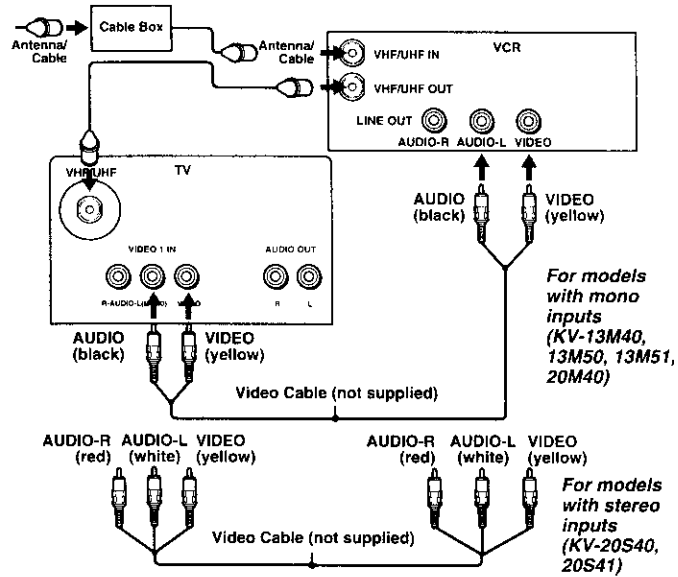

Connecting a Camcorder

All models except KV-13M40

Use this connection to view a video tape from a camcorder.

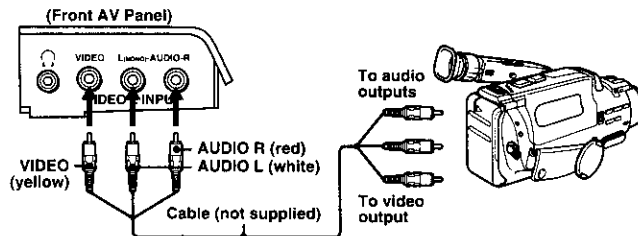

Notes

- For a monaural camcorder, connect the audio output of the camcorder to AUDIO L (MONO) on the TV.
- If you are connecting your camcorder to a monaural TV (KV-13M50, 13M51, 20M40 only), plug the white audio connector into the AUDIO-L input on the TV.
- You can also connect a camcorder to inputs on the rear of the TV (all models).

Step 2: Using the Remote Control

Inserting Batteries

Insert two size AA (R6) batteries (supplied) by matching the + and - on the batteries to the + and - inside the battery compartment. With normal use, the batteries should last for approximately six months.

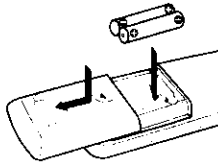

Notes

- Remove the batteries to avoid possible damage from battery leakage if you will not be using the remote control for an extended period of time.
- Handle the remote control with care. Avoid dropping it, getting it wet, or placing it in direct sunlight, near a heater, or where the humidity is high.

Remote Control Operation Buttons

In the instructions that follow, please refer to the buttons on your remote control. The remote control shown is model RM-Y155.

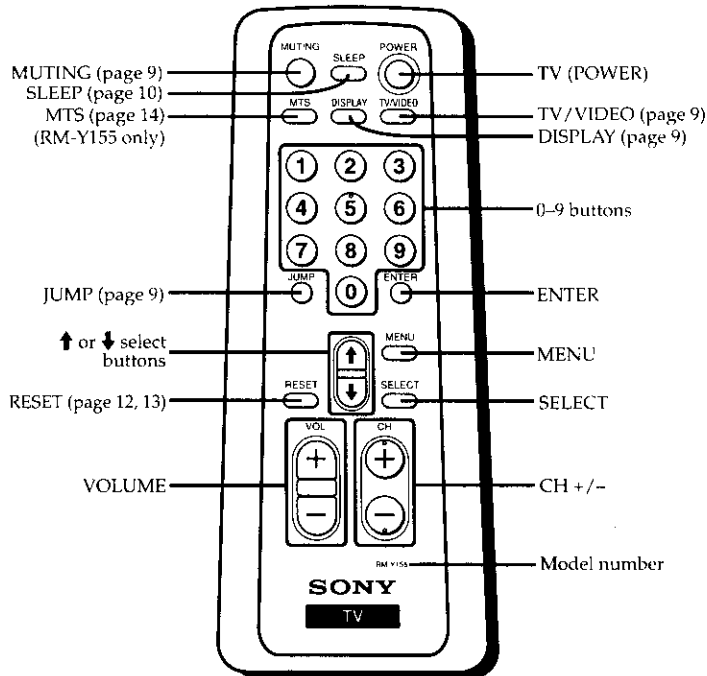

Step 3: Setting Menu Language

Changing the Menu Language

Except Canadian models

The menu illustrations are for KV-20S40. Your on-screen menus may not look like those used within this manual. When a feature is only available to a limited set of models, those models will be listed.

If you want to view the menus in Spanish, you can change the menu language.

1 Press MENU.

The main menu appears.
Move the cursor \uparrow or \downarrow to the SET UP  menu, press SELECT.



2 Press \uparrow or \downarrow to move the cursor to LANGUAGE and press SELECT.
ENGLISH will appear red.

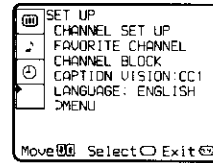

3 Press \uparrow or \downarrow to select ESPAÑOL and press SELECT.
ESPAÑOL will turn red and the menu will appear in Spanish.



4 Press MENU to return to the TV program.

Step 4: Setting up Your Channels

Setting Up the TV Automatically

KV-20M40, 20S40, 20S41 only

The Easy Set Up Guide allows you to set up the on-screen language and set all receivable channels. (The Easy Set Up Guide screen appears every time you turn on the TV until you perform AUTO PROGRAM).

- 1 Press **POWER** to turn on your TV.
The Easy Set Up Guide screen appears.
- 2 (Except Canadian Models) Press **CH +** to select English screens or **CH -** to select Spanish screens.
- 3 Press **VOL +** to continue or **VOL -** for a DEMO of functions and menus.

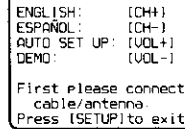

ENGLISH: [CH+]
ESPAÑOL: [CH-]
AUTO SET UP: [VOL+]
DEMO: [VOL-]
First please connect
cable/antenna
Press [SETUP] to exit

To perform this function again

Press the SET UP button on your TV.

Auto Programming Your Channels (AUTO PROGRAM)

The AUTO PROGRAM feature allows you to set all receivable channels in one step. After this function is completed, you may delete unwanted channels or add additional channels.

Notes

- If the TV is set to VIDEO, you cannot run AUTO PROGRAM. Press TV/VIDEO on the remote control until a channel number appears.
- It is usually best to preset channels during the day when more channels are broadcasting and receivable.

- 1 Press **MENU**.



- 2 Move the cursor **↑** or **↓** to the **SET UP**  menu and press **SELECT**.
The SET UP menu appears.

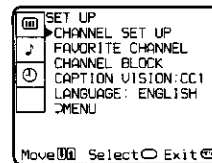

SET UP
▶ CHANNEL SET UP
▶ FAVORITE CHANNEL
CHANNEL BLOCK
CAPTION VISION: CC1
LANGUAGE: ENGLISH
MENU
Move [left arrow] Select [right arrow] Exit [right arrow]

- 3 Move the cursor **↑** or **↓** to **CHANNEL SET UP** and press **SELECT**.

- 4 Move the cursor **↑** or **↓** to **AUTO PROGRAM** and press **SELECT**.
AUTO PROGRAM appears on the screen and the TV starts scanning and presetting channels.

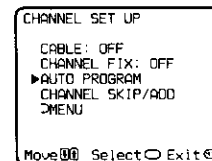

CHANNEL SET UP
CABLE: OFF
CHANNEL FIX: OFF
▶ AUTO PROGRAM
CHANNEL SKIP/ADD
MENU
Move [left arrow] Select [right arrow] Exit [right arrow]

Notes

- Pressing any button on the remote control while AUTO PROGRAM is scanning and presetting channels will cause AUTO PROGRAM to stop.
- When you run AUTO PROGRAM your CHANNEL FIX and ON/OFF TIMER settings will be erased.

Skipping or Adding Channels (CHANNEL SKIP/ADD)

After you run AUTO PROGRAM, you can skip unnecessary channels or add new ones.

- 1 Press **MENU** and select the **SET UP**  menu.
- 2 Move the cursor to **CHANNEL SET UP** and press **SELECT**.
- 3 Press **↑** or **↓** to **CHANNEL SKIP/ADD** and press **SELECT**.



- 4 To skip or add a channel:
 - (1) Press **CH +/-** or **0-9** to enter the desired channel.
 - (2) Press **SELECT** to **SKIP** or **ADD**.

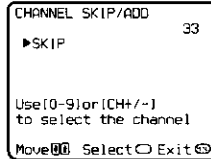

- 5 To skip or add other channels, repeat step 4.
- 6 Press **MENU** to return to the TV program.

Note

- If a channel you want to add was not received by AUTO PROGRAM, you must use the 0-9 buttons to manually add the channel.

Setting Cable TV On or Off (CABLE)

If you have connected the TV to a cable TV system, set **CABLE** to **ON**. If you will be using an antenna, set **CABLE** to **OFF** to receive VHF/UHF channels.

- 1 Press **MENU**.
- 2 Move the cursor to the **SET UP**  menu and press **SELECT**.
- 3 Move the cursor to **CHANNEL SET UP** and press **SELECT**.

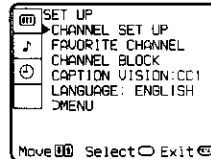

- 4 Move the cursor to **CABLE** and press **SELECT**.
- 5 Press **↑** or **↓** to select **ON** or **OFF**.
- 6 Press **SELECT**.
- 7 Press **MENU** to return to the TV program.

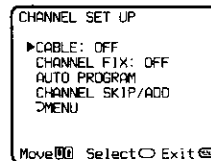

After adjusting the **CABLE** setting, you will need to run **AUTO PROGRAM**. (See page 7).

Note

- If no picture appears, the TV may be set to a video input and **CABLE** can not be selected. Press **TV/VIDEO** until a channel number appears, then follow steps 1-6.

Watching the TV

Press **POWER** to turn the TV on.

Note

- If **VIDEO** is on the screen, press **TV/VIDEO** until a channel number appears.

Selecting a Channel Directly

Press **0–9** to select a channel.

The channel changes after 2 seconds, or you can press **ENTER** for immediate selection.

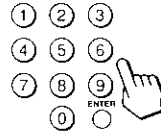

Scanning Channels

Press **CH +/-** until the channel appears.

Note

- Keeping the **CH +** or **-** button pressed, allows you to rapidly scan to the desired channel.

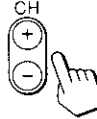

Jumping Quickly Between Two Channels

Press **JUMP**.

The TV alternates or *jumps* between the last two channels viewed.



Note

- You can only jump to channels you have selected with the **0–9** keys.

Muting the Sound

Press **MUTING**.

MUTING appears on the screen.

To restore the sound, press **MUTING** again, or press **VOL +**.



Displaying On-Screen Information

Use the **DISPLAY** key to check current time, channel and Multichannel TV Sound (MTS).

1 Press **DISPLAY**.

The channel number and local time (if set), are displayed. The TV displays the MTS mode if **SAP** or **STEREO** are selected and available (KV-20S40, 20S41 only).

The MTS mode display disappears after 4 seconds.

2 Press **DISPLAY** again.

CC1 (default setting) appears on the screen for a few seconds. A printed version of the dialog and sound effects will appear, if available.

3 To turn off **CAPTION VISION**, press **DISPLAY** again until **DISPLAY OFF** appears.

It will take a few seconds for **DISPLAY OFF** to disappear.

Notes

- See page **12** for more information about **CAPTION VISION**.
- See page **14** for more information about **MTS**.

Watching Video Tapes

Press **TV/VIDEO** until the correct video input appears.



Press **PLAY** on your **VCR** to view the video tape. Press **TV/VIDEO** to return to the TV program.

Listening with Headphones or an Earphone

Plug the headphones or earphone into the jack on the front of the TV. Using headphones will turn off the sound to the TV speakers.

Note

- If your TV is monaural, the monaural sound will be heard from both headphones.

Additional Features

Setting the SLEEP Timer

The SLEEP timer programs the TV to stay on for a length of time and then shut off automatically.

- 1 Press **SLEEP** until the length of time you want the TV to stay on appears. SLEEP appears one minute before the TV shuts off.
- 2 To cancel the sleep timer, press **SLEEP** again until **SLEEP OFF** appears, or turn off the TV.

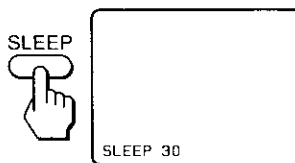

Setting DAYLIGHT SAVING

All models except KV-13M40

You can program DAYLIGHT SAVING to automatically adjust the time.

- 1 Press **MENU** and select the **TIMER** menu.
- 2 Move the cursor to **DAYLIGHT SAVING** and press **SELECT**.
- 3 Press **↑** or **↓** to select **YES** or **NO** based on the following options:

Spring: Select **YES**, the current time moves one hour ahead.
Fall: Select **NO**, the current time moves back one hour.

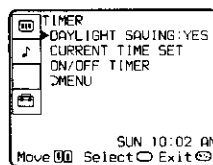

Setting the clock (CURRENT TIME SET)

All models except KV-13M40

- 1 Press **MENU** and select the **TIMER** menu.
- 2 Move the cursor to **CURRENT TIME SET** and press **SELECT**.
- 3 Set the current day.
Press **SELECT** and press **↑** or **↓** until the day entry is highlighted, press **SELECT**.
- 4 Set the current time.
Press **SELECT** until the time entry is highlighted.
Press **↑** or **↓** until the current hour is displayed and press **SELECT**.
Press **↑** or **↓** until the current minute is displayed and press **SELECT**.

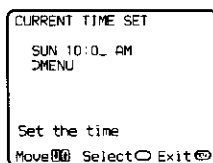
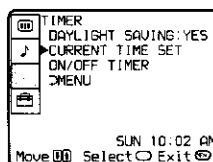

Setting the ON/OFF TIMER

All models except KV-13M40

You can program your TV for scheduled viewing using the ON/OFF TIMER. The CURRENT TIME SET must be set in order for the ON/OFF TIMER to function.

- 1 Press **MENU** and select the **TIMER** menu.
- 2 Move the cursor to **ON/OFF TIMER** and press **SELECT**.

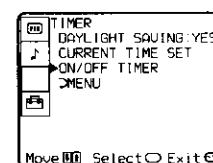

Additional Features (continued)

3 Enter the ON/OFF TIMER setting.

- Press SELECT until the day entry is highlighted.
Press \uparrow or \downarrow to cycle through the day options.
Select an entry and press SELECT.
- Press SELECT until the time entry is highlighted.
Press \uparrow or \downarrow to set the hour and press SELECT.
Press \uparrow or \downarrow to set the minute and press SELECT.
- Press \uparrow or \downarrow to set the duration, up to six hours, and press SELECT.
- Press \uparrow or \downarrow to select the channel and press SELECT.
The TIMER indicator, on the front of the TV, will light up.

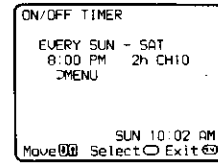

To erase your ON/OFF TIMER settings

Press RESET, while in the TIMER menu.

Note

- If you exit the ON/OFF TIMER menu while setting the TIMER, your settings will be saved.

Setting FAVORITE CHANNEL

This feature provides quick access to your favorite channels.

- Press MENU and select the SET UP  menu.
- Move the cursor to FAVORITE CHANNEL and press SELECT.



- Press \uparrow or \downarrow to select AUTO or MANUAL and press SELECT.
Selecting AUTO will display the last five channels chosen with the remote control's 0-9 buttons.
- Press \uparrow or \downarrow to select 1, 2, 3, 4 or 5 and press SELECT.
- Press \uparrow or \downarrow to highlight the desired channel and press SELECT.

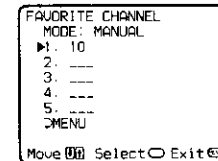

To use FAVORITE CHANNEL

Press SELECT when in normal viewing mode. Your options will appear on the screen.

Setting CHANNEL FIX

This feature is useful when you want to control all channel selection through a cable box or video equipment.

- Press MENU and select the SET UP  menu.
- Move the cursor \uparrow or \downarrow to CHANNEL SET UP and press SELECT.
- Select CHANNEL FIX and set your TV to one of the following options:

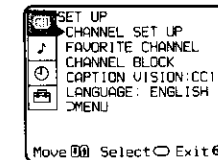

- 2-6: When the cable box is connected to VHF/UHF input. Use your cable box remote to change channels.

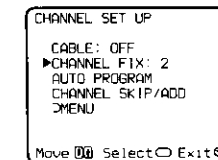

VIDEO 1: When you have connected video equipment (e.g. DSS receiver) and you want the TV fixed to it. You will be able to alternate between video sources.

OFF: When you want to switch CHANNEL FIX off.

Notes

- For information on connecting a cable box, see page 3.
- ON/OFF TIMER settings will be erased when CHANNEL FIX is set.
- FAVORITE CHANNEL can not be accessed when CHANNEL FIX is set.

Blocking out a Channel (CHANNEL BLOCK)

This feature is useful in preventing child access to designated channels.

- 1 Press **MENU** and select the **SET UP**  menu.
- 2 Move the cursor **↑** or **↓** to **CHANNEL BLOCK** and press **SELECT**.

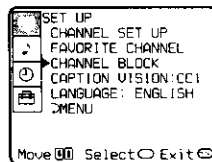

- 3 Move the cursor to 1 or 2 and press **SELECT**.
- 4 Press **↑** or **↓** until you reach the channel you want to block and press **SELECT**.

When you try to tune to the blocked channel, **BLOCKED** will appear on the screen. **CAPTION VISION** will also be blocked.

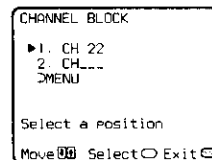

To erase your CHANNEL BLOCK settings

Press **RESET**, while in the **CHANNEL BLOCK** menu.

Selecting CAPTION VISION

Some programs are broadcast with **CAPTION VISION**. These services are sometimes limited to specific broadcasting networks and may not be available in your area. (CC1 is the default setting).

- 1 Press **MENU** and select the **SET UP**  menu.
- 2 Move the cursor **↑** or **↓** to **CAPTION VISION** and press **SELECT**.
- 3 Press **↑** or **↓** and set your TV to one of the following options:

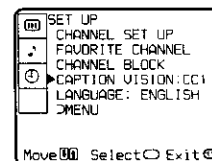

Choose	To Display
CC1, 2, 3 or 4	A printed version of the dialog or sound effects of a program. (The default setting is CC1).
TEXT 1, 2, 3 or 4	Station/network related information that usually is not related to the program.
XDS (Extended Data Services)	A program's type, name, length and call letters.

- 4 Press **DISPLAY**.
The caption will appear in a few seconds, if available.
- 5 To turn off **CAPTION VISION**, press **DISPLAY** until **DISPLAY OFF** appears.

Notes

- Captions disappear for a few seconds when you press the **MUTING** button.
- Captions may appear with a white box or other errors, if you have poor reception on the channel.



Using the VIDEO Menu

Adjusting the VIDEO Settings

You can adjust the PICTURE, BRIGHTNESS, COLOR, HUE, and SHARPNESS of any TV image.

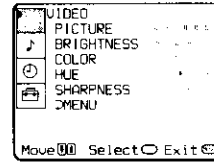

- 1 Press **MENU** and select the **VIDEO**  menu.

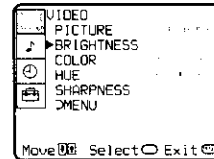

- 2 Move the cursor  or  to the feature you want to adjust and press **SELECT**. See the **ADJUSTABLE ITEMS** chart below for a list of the adjustments you can make.



ADJUSTABLE ITEMS

Item	Press  to	Press  to
PICTURE	Increase the contrast	Decrease the contrast
BRIGHTNESS	Brighten the picture	Darken the picture
COLOR	Increase color intensity	Decrease color intensity
HUE	Increase the green tones	Decrease the green tones
SHARPNESS	Sharpen the picture	Soften the picture

- 3 Press **MENU** to return to the TV program.

Restoring the factory video settings

Press **RESET**, while in the VIDEO menu.

Audio Menu

Selecting Stereo or Bilingual Programs (MTS)

KV-20S40, 20S41 only

The Multichannel TV Sound (MTS) feature allows you to enjoy Stereo Sound (STEREO), Second Audio Programs (SAP), or Monaural Sound (MONO) when available.

- 1 Press **MENU** and select the **AUDIO**  menu.
- 2 Move the cursor to **MTS** and press **SELECT**.

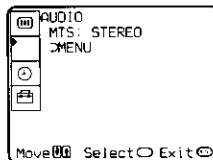

- 3 Press **↑** or **↓** to select **STEREO**, **SAP**, or **MONO** and press **SELECT**.

Choose	To
STEREO	Listen to stereo sound.
SAP	Listen to bilingual and other programs.
MONO	Reduce noise during poor stereo broadcasts.

For Direct MTS Access

Press **MTS** repeatedly to cycle through the MTS options.

Note

- If your TV does not have sound, try changing your MTS setting.

Troubleshooting

If you are having a problem with your TV, try the suggestions below. If the problem persists, contact your nearest Sony dealer.

Problem	Suggestion
No picture, no sound	<ul style="list-style-type: none">• Make sure the power cord is connected.• If a red light keeps flashing on the front of your TV, for more than a few minutes, call your local service center.• Check the TV/VIDEO setting: when watching TV, set to TV; when watching video tapes, set to VIDEO (page 9).• Make sure the batteries have been inserted correctly into the remote control.• Try another channel. It could be station trouble.
Poor or no picture, good sound	<ul style="list-style-type: none">• Adjust PICTURE in the VIDEO menu (page 13).• Adjust BRIGHTNESS in the VIDEO menu (page 13).• Check the antenna and/or cable connections (page 3).
Good picture, no sound	<ul style="list-style-type: none">• Press MUTING so that MUTING disappears from the screen (page 9).• Check your AUDIO settings. Your TV may be set to SAP (page 14).
No color	<ul style="list-style-type: none">• Adjust COLOR in the VIDEO menu (page 13).• Make sure that a black and white program is not being broadcast.
Only snow appears on the screen	<ul style="list-style-type: none">• Check the CABLE setting in the SET UP menu (page 8).• Check the antenna and/or cable connections (page 3).• Make sure the channel selected is currently broadcasting.
Dotted lines or stripes	<ul style="list-style-type: none">• Adjust the antenna.• Move the TV away from other electronic equipment. Some electronic equipment can create electrical noise, which can interfere with TV reception.
Double images or ghosts	<ul style="list-style-type: none">• Check your outdoor antenna or call your cable service.
Cannot receive higher number channels (UHF) when using an antenna	<ul style="list-style-type: none">• Make sure CABLE is set to OFF in the SET UP menu (page 8).• Use AUTO PROGRAM to add channels that are not presently in the memory (page 7).
Cable stations don't seem to work	<ul style="list-style-type: none">• Make sure CABLE is set to ON in the SET UP menu (page 8).• Use AUTO PROGRAM to add channels that are not presently in the memory (page 7).
Remote control does not operate	<ul style="list-style-type: none">• Batteries could be weak. Replace them (page 5).• Move the TV 3–4 feet away from fluorescent lights.
The TV needs to be cleaned	<ul style="list-style-type: none">• Clean the TV with a soft dry cloth. Never use strong solvents such as thinner or benzine, which might damage the finish of the cabinet.
The TV is fixed to one channel	<ul style="list-style-type: none">• Try turning CHANNEL FIX off (page 11).• Use AUTO PROGRAM to add receivable channels that are not presently in the TV memory (page 7).

If, after reading these operating instructions, you have additional questions related to the use of your Sony television, please call our Direct Response Center at 1-800-222-SONY (7669).

Specifications

For all models (except as noted)

Television system	American TV standard/NTSC
Channel coverage	VHF: 2-13/UHF: 14-69/CATV: 1-125
Antenna	75-ohm external antenna terminal for VHF/UHF
Picture tube	Trinitron tube
Power requirements	120 V, 60 Hz
Supplied accessories	Size AA (R6) batteries (2) Antenna connector (except KV-20M40, 20S40, 20S41) Remote control RM-Y155 (1) (KV-20S40, 20S41) Remote control RM-Y156 (1) (KV-13M40, 13M50, 13M51, 20M40) Antenna dipole (KV-13M40, 13M50, 13M51 only)
Optional accessory	Antenna dipole (KV-20M40, 20S40, 20S41)

KV-13M40, 13M50, 13M51

Screen size	Visible screen size: 330 mm/33 cm (13 in.) measured diagonally Actual tube size: 356 mm/35.6 cm (14 in.) measured diagonally
Inputs	1 video, 1 audio (KV-13M40) 2 video, 2 audio (KV-13M50, 13M51)
Speaker output	3 W
Power consumption	75 W when in use 6 W in standby
Dimensions (W/H/D)	358 x 342 x 401 mm (14 1/8 x 13 1/2 x 15 1/4 in.)
Mass	10 kg (22 lbs)

KV-20M40, 20S40, 20S41

Screen size	Visible screen size: 508 mm/50.8 cm (20 in.) measured diagonally Actual tube size: 527 mm/52.7 cm (21 in.) measured diagonally
Inputs	2 video, 2 audio
Speaker output	3 W (KV-20M40) 3 W + 3 W (KV-20S40, 20S41)
Power consumption	80 W when in use (KV-20M40) 90 W when in use (KV-20S40, 20S41) 6 W in standby
Dimensions (W/H/D)	522 x 477 x 479 mm (21 x 18 3/4 x 18 7/8 in.)
Mass	21.6 kg (48 lbs)

Design and specifications are subject to change without notice.
Sony Corporation Printed in U.S.A.