

---

# OWNER'S GUIDE

---

READ AND SAVE THESE INSTRUCTIONS

# ELECTRIC RANGE

Coil Surface Elements  
Electronic Oven Control  
Self-Cleaning Oven Interior

P/N 316000642 (0003)

---

## Product Registration

### Register Your Product

The self-addressed **PRODUCT REGISTRATION CARD** should be filled in completely, signed and returned to Frigidaire Home Products.

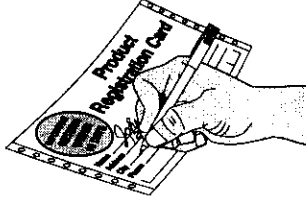

Thank you for choosing this appliance. The information contained within this Owner's Guide will instruct you on how to properly operate and care for your range. Please read through the information contained in your literature pack to learn more about your new appliance.

### Record Your Model and Serial Numbers

Record in the space provided below the model and serial numbers found on the serial plate located under the lift-up cooktop.

Model Number: \_\_\_\_\_

Serial Number: \_\_\_\_\_

Date of Purchase: \_\_\_\_\_

### Versión en español

Si desea obtener una copia en español de este Manual del Usuario, sírvase escribir a la dirección que se incluye a continuación. Solicite la P/N 316000642S.

Spanish Owner's Guides  
Frigidaire Company  
P. O. Box 9061  
Dublin, Ohio 43017-0961

This Owner's Guide contains general operating instructions for your range and feature information for several models. Your range **may not** have all the described features.

**Note:** The instructions appearing in this Owner's Guide are not meant to cover every possible condition and situation that may occur. Common sense and caution must be practiced when installing, operating and maintaining any appliance.

## Table of Contents

Product Registration .....	2
Versión en español .....	2
IMPORTANT SAFETY INSTRUCTIONS .....	3-4
Control Pad Functions .....	5
Setting the Clock and Minute Timer .....	6
Setting Surface Controls .....	7
Setting Warmer Drawer Controls (if equipped) .....	8
Before Setting Oven Controls .....	9
Setting Oven Controls .....	9-11
Oven Cleaning .....	12-13
General Cleaning .....	14-16
Changing Oven Light .....	17
Adjusting Oven Temperature .....	17
Avoid Service Checklist .....	18-19
Warranty .....	20

# IMPORTANT SAFETY INSTRUCTIONS

Read all instructions before using this appliance.

Save these instructions for future reference.

This guide contains important safety symbols and instructions. Please pay attention to these symbols and follow all instructions given. Here is a brief explanation of the use of these symbols.

**⚠ WARNING** This symbol will help alert you to situations that may cause serious bodily harm, death or property damage.

**⚠ CAUTION** This symbol will help alert you to situations that may cause bodily injury or property damage.

- Remove all tape and packaging before using the range. Destroy the carton and plastic bags after unpacking the range. Never allow children to play with packaging material.
- Proper Installation—Be sure your appliance is properly installed and grounded by a qualified technician in accordance with the National Electrical Code ANSI/NFPA No. 70 latest edition and local electrical code requirements. Install only per installation instructions provided in the literature package for this range.  
Ask your dealer to recommend a qualified technician and an authorized repair service. Know how to disconnect the power to the range at the circuit breaker or fuse box in case of an emergency.
- User servicing—Do not repair or replace any part of the appliance unless specifically recommended in the manuals. All other servicing should be done only by a qualified technician. This may reduce the risk of personal injury and damage to the range.
- Never modify or alter the construction of a range by removing leveling legs, panels, wire covers, anti-tip brackets/screws, or any other part of the product.

## ⚠ WARNING

- All ranges can tip.
- Injury to persons could result.
- Install anti-tip device packed with range.
- See Installation Instructions.



**⚠ WARNING** To reduce the risk of tipping, the range must be secured by properly installed anti-tip bracket provide with the range. To check if the bracket is installed properly, visually check that rear leveling leg is inserted into and fully secured by the anti-tip bracket by removing lower panel or storage drawer. For models with a warmer drawer, grasp the top rear edge of the range and carefully attempt to tilt it forward. Refer to the Installation Instructions for proper anti-tip bracket installation.



**⚠ WARNING** Stepping, leaning or sitting on the doors or drawers of this range can result in serious injuries and also cause damage to the range. Do not allow children to climb or play around the range. The weight of a child on an open door may cause the range to tip, resulting in serious burns or other injury.

**⚠ WARNING** Do not use the oven or warmer drawer for storage.

**⚠ CAUTION** Do not store items of interest to children in the cabinets above a range or on the backguard of a range. Children climbing on the range to reach items could be seriously injured.

**⚠ WARNING** Never Use Your Appliance for Warming or Heating the Room.

- Storage in or on Appliance—Flammable materials should not be stored in an oven, warmer drawer, broiler compartment, near surface units or in the storage drawer. This includes paper, plastic and cloth items, such as cookbooks, plasticware and towels, as well as flammable liquids. Do not store explosives, such as aerosol cans, on or near the range.
- Do Not Leave Children Alone—Children should not be left alone or unattended in the area where appliance is in use. They should never be allowed to sit or stand on any part of the appliance.
- DO NOT TOUCH SURFACE UNITS, AREAS NEAR THESE UNITS, HEATING ELEMENTS OR INTERIOR SURFACES OF THE OVEN. Both surface units and oven heating elements may be hot even though they are dark in color. Areas near surface units may become hot enough to cause burns. During and after use, do not touch, or let clothing or other flammable materials touch these areas until they have had sufficient time to cool. Among these areas are the cooktop, surfaces facing the cooktop, the oven vent openings and surfaces near these openings, oven door and window.
- Wear Proper Apparel—Loose-fitting or hanging garments should never be worn while using the appliance. Do not let clothing or other flammable materials contact hot surfaces.
- Do Not Use Water or Flour on Grease Fires—Smother the fire with a pan lid, or use baking soda, a dry chemical or foam-type extinguisher.
- When heating fat or grease, watch it closely. Fat or grease may catch fire if allowed to become too hot.
- Use Only Dry Potholders—Moist or damp potholders on hot surfaces may result in burns from steam. Do not let potholders touch hot heating elements. Do not use a towel or other bulky cloth instead of a potholder.
- Do Not Heat Unopened Food Containers—Buildup of pressure may cause container to burst and result in injury.
- Remove the oven door from any unused range if it is to be stored or discarded.

**IMPORTANT**—Do not attempt to operate the range during a power failure. If the power fails, always turn off the range. If the range is not turned off and the power resumes, the range will begin to operate again. Once the power resumes, reset the clock and oven function.

# IMPORTANT SAFETY INSTRUCTIONS

## IMPORTANT INSTRUCTIONS FOR USING YOUR COOKTOP

- **Know which knob controls each surface heating unit.** Place a pan of food on the unit before turning it on, and turn the unit off before removing the pan.
- **Use Proper Pan Size—**This appliance is equipped with one or more surface units of different sizes. Select utensils having flat bottoms large enough to cover the surface unit heating element. The use of undersized utensils will expose a portion of the heating element to direct contact and may result in ignition of clothing. Proper relationship of utensil to element will also improve efficiency.
- **Utensil Handles Should Be Turned Inward and Not Extend Over Adjacent Surface Units—**To reduce the risk of burns, ignition of flammable materials, and spillage due to unintentional contact with the utensil, the handle of the utensil should be positioned so that it is turned inward, and does not extend over adjacent surface units.
- **Never Leave Surface Units Unattended at High Heat Settings—**Boilovers cause smoking and greasy spillovers that may ignite, or a pan that has boiled dry may melt.
- **Do Not Immerse or Soak Removable Heating Elements—**Heating elements should never be immersed in water. Heating elements clean themselves during normal operation.
- **Make Sure Reflector Pans or Drip Bowls Are in Place—**Absence of these pans or bowls during cooking may subject wiring or components underneath to damage.
- **Protective Liners—**Do not use aluminum foil to line surface unit drip bowls, reflector pans, or oven bottom, or any other part of the range. Only use aluminum foil as recommended in this manual. Improper installation of these liners may result in risk of electric shock, or fire.
- **Glazed Cooking Utensils—**Only certain types of glass, glass/ceramic, ceramic, earthenware, or other glazed utensils are suitable for cooktop service without breaking due to the sudden change in temperature. Check the manufacturer's recommendations for cooktop use.
- **When flaming foods under a ventilating hood, turn the fan on.**

## IMPORTANT INSTRUCTIONS FOR USING YOUR OVEN

- **Use Care When Opening Oven Door or Warmer Drawer—**Stand to the side of the range when opening the door of a hot oven. Let hot air or steam escape before you remove or replace food in the oven.
- **Keep Oven Vent Ducts Unobstructed.** The oven vent is located under the right rear surface element. Touching the surfaces in this area when the oven is operating may cause severe burns. Also, do not place plastic or heat-sensitive items on or near the oven vent. These items could melt or ignite.
- **Placement of Oven Racks.** Always place oven racks in desired location while oven is cool. If rack must be moved while oven is hot use extreme caution. Use potholders and grasp the rack with both hands to reposition. Do not let potholders contact the hot heating elements in the oven. Remove all utensils from the rack before moving.
- **Do not use the broiler pan without its insert.** The broiler pan and its insert allow dripping fat to drain and be kept away from the high heat of the broiler.
- **Do not cover the broiler insert with aluminum foil.** Exposed fat and grease could ignite.
- **Cold temperatures can damage the electronic control.** When using the appliance for the first time, or when the appliance has not been used for an extended period of time, be certain the unit has been in temperatures above 32°F (0°C) for at least 3 hours before turning on the power to the appliance

## IMPORTANT INSTRUCTIONS FOR CLEANING YOUR RANGE

- **Clean the range regularly to keep all parts free of grease that could catch fire.** Pay particular attention to the area underneath each surface element. Do not allow grease to accumulate. Refer to the hood manufacturer's instructions for cleaning.
- **Kitchen cleaners and aerosols—**Always follow the manufacturer's recommended directions for use. Be aware that excess residue from cleaners and aerosols may ignite causing damage and injury.
- **Clean Ventilating Hoods Frequently—**Grease should not be allowed to accumulate on the hood or filter. Follow manufacturer's instructions for cleaning.

## SELF CLEANING OVENS

- **Clean in the self-cleaning cycle only the parts listed in this Owner's Guide.** Before self cleaning the oven, remove the broiler pan and any utensils or foods from the oven.
- **Do Not Use Oven Cleaners—**No commercial oven cleaner or oven liner protective coating of any kind should be used in or around any part of the oven.
- **Do Not Clean Door Gasket—**The door gasket is essential for a good seal. Care should be taken not to rub, damage or move the gasket.

## SAVE THESE INSTRUCTIONS

## Control Pad Functions

**READ THE INSTRUCTIONS CAREFULLY BEFORE USING THE OVEN.** For satisfactory use of your oven, become familiar with the various functions of the oven as described below.

**CLEAR PAD**— Used to clear any function previously entered except the time of day and minute timer. Push **CLEAR** to stop cooking.

**BAKE PAD**—Used to enter the normal baking mode temperature.

**BROIL PAD**—Used to select the variable broil function.

**CLEAN PAD**—Used to select the self-cleaning cycle.

**UP and DOWN ARROW PADS**— Used along with the function pads to select oven temperature, cooking time, stop time (when programming an automatic stop time), time of day, clean time and minute timer.

**CLOCK PAD**— Used to set the time of day.

**FEATURE INDICATOR LIGHTS**— These light to show which feature is in use.

**BAKE TIME PAD**— Used to enter the length of the baking time.

**STOP TIME PAD**— Used to set the desired stop time for baking. Can be used with **BAKE TIME** to program a delayed bake cycle.

**OVEN, PREHEAT & LOCK LIGHTS**— The "OVEN" light will glow each time the oven unit turns on to maintain the set oven temperature. The "PREHEAT" light will glow when the oven is first set to operate, or if the desired temperature is reset higher than the actual oven temperature. The "LOCK" light will flash until the door locks when the self-clean cycle is in use. It glows constantly after the door locks.

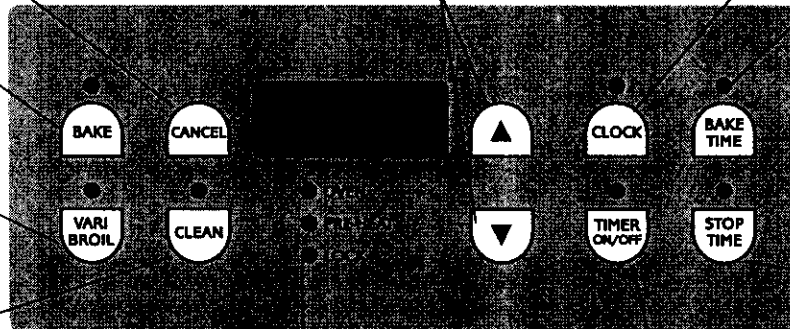

**TIMER PAD**— Used to set or cancel the minute timer. The minute timer does not start or stop cooking.



### The oven can be programmed to:

- Bake normally
- Time bake
- Broil
- Self-clean

### For a silent control panel:





When choosing a function, a beep will be heard each time a pad is pushed. If desired, the controls can be programmed for silent operation. Push and hold . After 7 seconds, the control will beep once. This will block the controls from sounding when a pad is pushed. To return the sound, push and hold  again for 7 seconds until 1 beep is heard.

**Note:** The control will return to the audible mode after a power outage.

### Temperature conversion:

The electronic oven control is set to operate in °F (Fahrenheit) when shipped from the factory. The oven can be programmed for any temperature from 170°F to 550°F (65°C to 287°C).

**To change the temperature to °C (Celsius) or from °C to °F (control should not be in a Bake or Clean mode):**

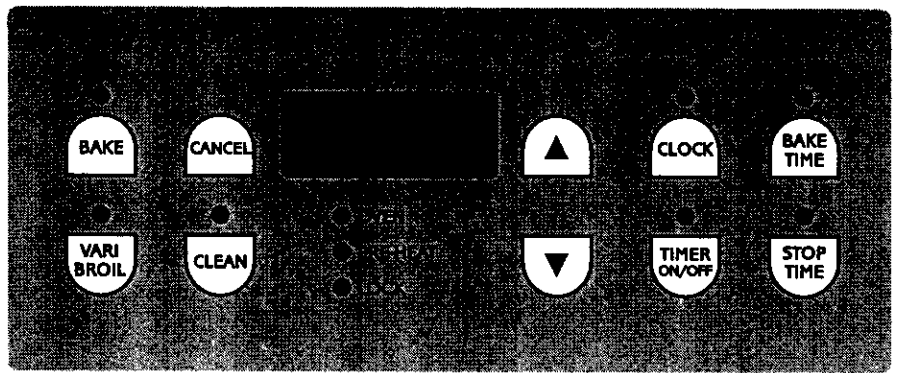

1. Push . "— — —" appears in the display.
2. Push and hold the  until "HI" appears in the display.
3. Push and hold  until °F or °C appears in the display.
4. Push the  or  to change °F to °C or °C to °F.
5. Push any function pad to return to normal operating mode.

## Setting the Clock and Minute Timer



### To Set the Clock





When the range is first plugged in, or when the power supply to the range has been interrupted, the display will flash "12:00".

1. Push .
2. Within 5 seconds, push and hold the  or  until the correct time of day appears in the display.

**Note:** The clock cannot be changed during any timed bake or self-clean cycle.



**Note:** The oven function will not work if the time of day clock is not set.

### To Set the Minute Timer

1. Push .
2. Push the  to increase the time in one minute increments. Push and hold the  to increase the time in 10 minute increments. The timer can be set for any amount of time from 1 minute to 11 hours and 59 minutes.  
**Note:** If you push the  first, the timer will advance to 11 hours and 59 minutes.
3. The display shows the timer count down in minutes until one minute remains. Then the display will count down in seconds.
4. When the set time has run out, the timer will beep 3 times. It will then continue to beep 3 times every 60 seconds until  is pushed.

**Note:** The minute timer does not start or stop cooking. It serves as an extra timer in the kitchen that will beep when the set time has run out. The minute timer can be used alone or during any of the other oven functions. When the minute timer is in use with any other mode, the minute timer will be shown in the display. To view other functions, push the function pad for that mode.

### To Change the Minute Timer while it is in use:

While the timer is active and shows in the display, push and hold the  or  to increase or decrease the time.

### To Cancel the Minute Timer before the set time has run out:

Push .

## Setting Surface Controls

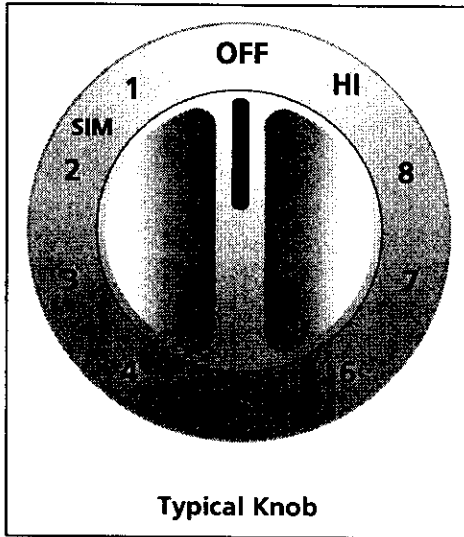

### To Operate the Surface Element

1. Place cooking utensil on the surface element.
2. Push in and turn the Surface Control knob in either direction to the desired setting. Start most cooking operations on a higher setting and then turn to a lower setting to finish cooking. The control knobs do not have to be set exactly on a particular mark. Use the marks as a guide and adjust the control knob as needed.
3. When cooking is completed, turn the surface element off before removing the pan. Note: The surface signal light will glow when one or more elements are turned on. A quick glance at the signal light(s) when cooking is finished is an easy check to be sure all control knobs are turned off.

The suggested settings found in the chart below are based on cooking in medium-weight aluminum pans with lids. Settings may vary when using other types of pans.

Setting	Type of Cooking
HIGH (HI)	Start most foods, bring water to a boil, pan broiling
MEDIUM HIGH (7-8)	Continue a rapid boil, fry, deep fat fry
MEDIUM (4-6)	Maintain a slow boil, thicken sauces and gravies, steam vegetables
MEDIUM LOW (2-3)	Keep foods cooking, poach, stew
SIMMER (1-SIM)	Keep warm, melt, simmer

**Note:** The size and type of utensil used, and the amount and type of food being cooked will influence the setting needed for best cooking results.

**CAUTION** Do not place plastic items such as salt and pepper shakers, spoon holders or plastic wrappings on top of the range when it is in use. These items could melt or ignite. Potholders, towels or wooden spoons could catch fire if placed too close to the element.

## Setting Warmer Drawer Controls (if equipped)

Use the warmer drawer to keep hot foods hot such as: vegetables, gravies, meats, casseroles, biscuits and rolls, pastries and heated dinner plates.

The warmer drawer is equipped with a catch which may require extra force when opening and closing the drawer.

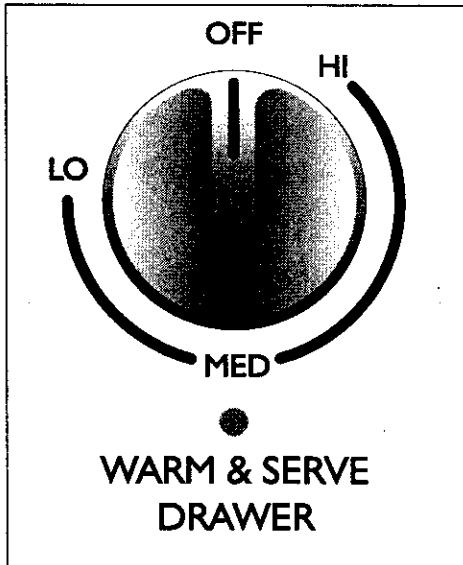

Warmer Drawer Recommended Food Settings Chart	
Food Item	Setting
Roasts (Beef, Pork, Lamb)	MED
Pork Chops	HI
Bacon	HI
Hamburger Patties	HI
Poultry	HI
Gravies	MED
Casseroles	MED
Eggs	MED
Fried Foods	HI
Vegetables	MED
Pizza	HI
Biscuits	MED
Rolls, soft	LO
Rolls, hard	MED
Pastries	MED
Empty Dinner Plates	LO

## Arranging Warmer Drawer Rack Positions

The rack can be used in 2 ways:

- In the **upright position** to allow low profile food items to be placed both under and on top of the rack (for example, rolls or biscuits on top of the rack and a casserole dish under).
- In the **downward position** to allow you to place light weight food items and empty dishware (for example, rolls or pastries and dinner plates). Set the warmer drawer rack as shown below.

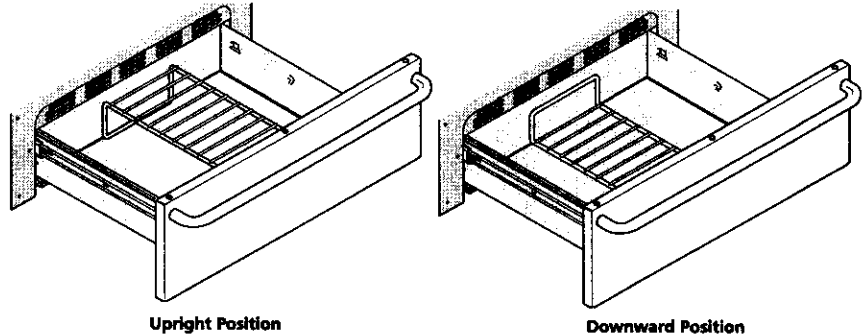

## To Operate the Warmer Drawer

Your range is equipped with a warmer drawer. The purpose of the warmer drawer is to keep hot cooked foods at serving temperature. Always start with hot food. It is not recommended to heat cold food in the warmer drawer.

All food placed in the warmer drawer should be covered with a lid or aluminum foil to maintain quality. Do not use plastic wrap to cover food. Plastic may melt onto the drawer and be very difficult to clean.

Use only dishware, utensils and cookware recommended for oven use in the warmer drawer.

**CAUTION** Always use potholders or oven mitts when removing food from the warmer drawer as cookware and plates will be hot.

## To Set the Thermostat Control

The thermostat control is used to select the temperature of the warmer drawer. It is located on the control panel. To set the thermostat, push in and turn the knob to the desired setting. The temperatures are approximate, and are designated by HI, MED and LO.

1. Turn the knob to select the desired temperature setting.
2. For best results, preheat the drawer before adding food. An empty drawer will preheat in approximately 15 minutes.
3. When done, turn the thermostat control to OFF.

## Temperature Selection

Refer to the chart in the side column for recommended settings. If a particular food is not listed, start with the medium setting. If more crispness is desired, remove the lid or aluminum foil.

Most foods can be kept at serving temperatures by using the medium setting.

When a combination of foods are to be kept warm (for instance, a meat with 2 vegetables and rolls), use the high setting.

Refrain from opening the warmer drawer while in use to eliminate loss of heat from the drawer.

## Indicator Light

The indicator light is located below the thermostat control. It turns on when the control is set, and stays on until the control is turned off. The warmer drawer is inoperable during the self-clean cycle. The indicator light will not come on during the self-clean cycle.



## Before Setting Oven Controls

### Arranging Oven Racks

**ALWAYS ARRANGE OVEN RACKS WHEN THE OVEN IS COOL (PRIOR TO OPERATING THE OVEN).** Always use oven mitts when using the oven.

### Oven Vent Location

The oven vent is located under the left rear surface element. When the oven is on, warm air is released through the vents. This venting is necessary for proper air circulation in the oven and good baking results.

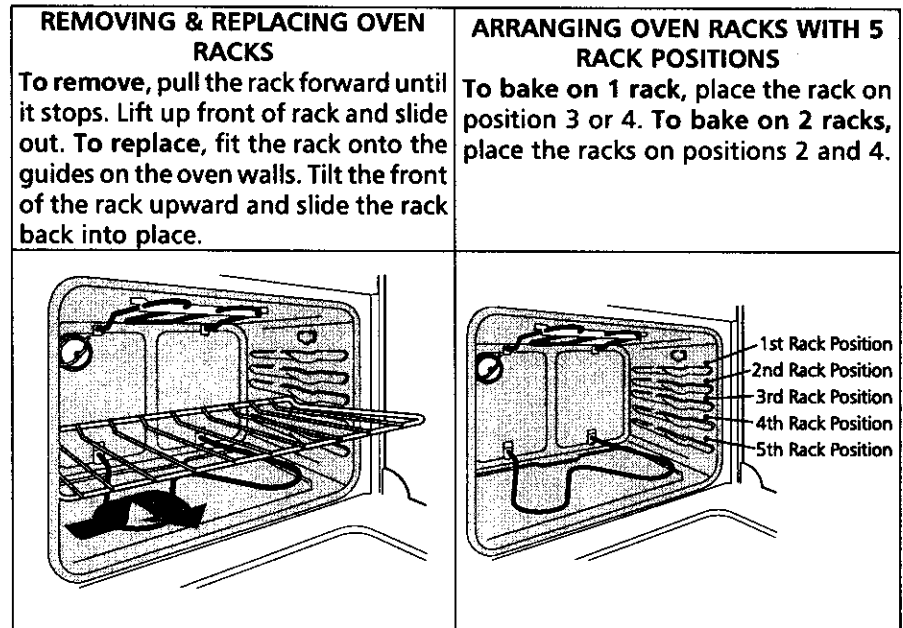

## Setting Oven Controls

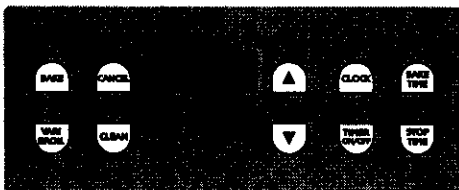

**Note:** The oven function will not work if the time of day clock is not set.

**Note:** The oven control has a built-in safety feature that will shut off the oven if the control is left on for more than 11 hours 59 minutes.

### To Set or Change the Temperature for Normal Baking

The oven can be programmed to bake at any temperature from 170°F to 550°F (65°C to 287°C).

#### To Set the Controls for Normal Baking:

1. Push **BAKE**. "— — —" appears in the display.
2. Within 5 seconds, push the **▲** or **▼**. The display will show "350°F (177°C)." By holding the **▲** or **▼**, the temperature can then be adjusted in 5°F (1°C) increments.
3. As soon as the **▲** or **▼** is released, the oven will begin heating to the selected temperature. When the displayed temperature reaches the desired baking temperature, the control will beep 3 times.
4. To cancel the baking function, push **CANCEL**.

#### To Change the Oven Temperature after Baking has Started:

1. If you are using the minute timer, push **BAKE** and make sure the bake temperature is displayed.
2. Push the **▲** or **▼** to increase or decrease the set temperature.

## Setting Oven Controls

(continued)

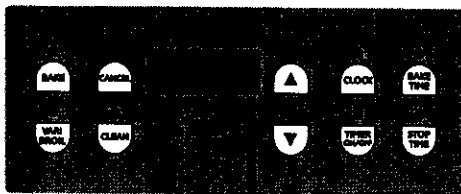

**CAUTION** Use caution when using the automatic timer. Use the automatic timer when cooking cured or frozen meats and most fruits and vegetables. Foods that can easily spoil such as milk, eggs, fish, meat or poultry, should be chilled in the refrigerator first. Even when chilled, they should not stand in the oven for more than 1 hour before cooking begins, and should be removed promptly when cooking is completed.

### To Set the Automatic Timer (Timed Bake Feature)

The **BAKE TIME** and **STOP TIME** controls operate the Timed Bake feature. The automatic timer will turn the oven on and off at the times you select in advance. The oven can be programmed to start immediately and shut off automatically or to begin baking at a later time with an automatic shutoff.

#### To Program the Oven to Begin Baking Immediately and To Shut Off Automatically:

1. Be sure that the clock shows the correct time of day.
2. Place the food in the oven.
3. Push **BAKE**.
4. Within 5 seconds, push the **▲** or **▼**. The display will show "350°F (177°C)." By holding the **▲** or **▼**, the temperature can then be adjusted in 5°F (1°C) increments.
5. Push **BAKE TIME**. "0:00" will flash in the display.
6. Push the **▲** or **▼** until the desired amount of baking time appears in the display.

#### To Program Oven for a Delayed Start Time and to Shut-Off Automatically

1. Be sure that the clock shows the correct time of day.
2. Place the food in the oven.
3. Push **BAKE**.
4. Within 5 seconds, push the **▲** or **▼**. The display will show "350°F (177°C)." By holding the **▲** or **▼**, the temperature can then be adjusted in 5°F (1°C) increments.
5. Push **BAKE TIME**. "0:00" will flash in the display.
6. Push the **▲** or **▼** until the desired amount of baking time appears.
7. Push **STOP TIME**. The earliest possible stop time will flash in the display.
8. Push the **▲** or **▼** until the desired stop time appears in the display.
9. Once the controls are set, the control calculates the time when baking will start in order to finish at the time you have set.

#### Once the Controls are Set:

- a. The oven will come on and begin heating to the selected baking temperature.
- b. The oven temperature will show in the display.

#### When the Set Bake Time Runs Out:

- a. "END" will appear in the display window and the oven will shut off automatically.
- b. The control will beep 3 times every 60 seconds until **CANCEL** is pushed.

#### To Change the Oven Temperature or Bake Time after Baking has Started:

1. Push the function pad you want to change.
2. Push the **▲** or **▼** to adjust the setting.

# Setting Oven Controls

(continued)

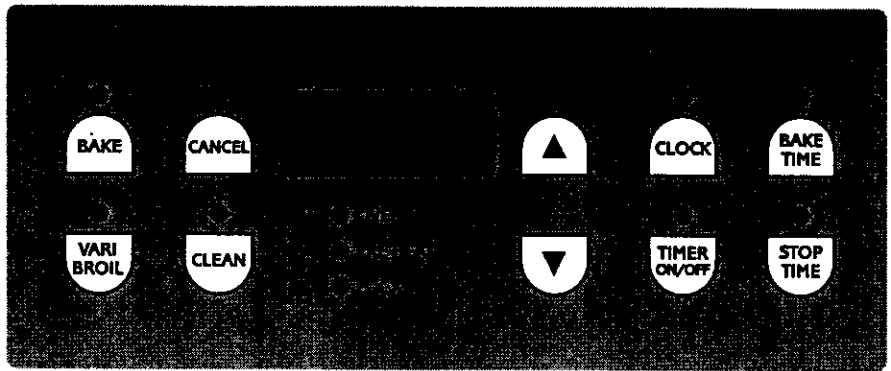

## To Broil

1. Arrange oven rack while oven is still cool. Position the rack as suggested in the chart below.

Rack Position From Top	Food
1	Rare steaks
2	Ham slices, fish, medium steaks, hamburgers and chops
3	Well-done foods such as chicken and lobster

The broiler pan and its grid allow dripping grease to drain and be kept away from the high heat of the broiler. **DO NOT** use the pan without its grid. **DO NOT** cover the grid with foil. The exposed grease could ignite.

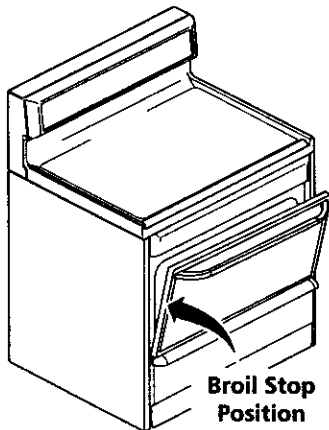
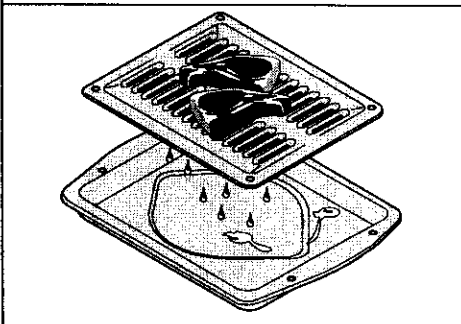

2. Push .
3. Push and hold the or until the desired broil setting level appears in the display. Push the for HI broil or the for LO broil. Most foods can be broiled at the HI broil setting. Select the LO broil setting to avoid excess browning or drying of foods that should be cooked to the well-done stage.
4. Place the grid on the broiler pan, then place the food on the grid. **DO NOT** use the broiler pan without the grid or cover the grid with aluminum foil. The exposed fat could ignite.
5. Place the pan on the oven rack. **Open the oven door to the broil stop position when broiling.**
6. Broil on one side until food is browned; turn and cook on the second side.  
**Note:** Always pull the rack out to the stop position before turning or removing food.
7. When broiling is finished, push .

**CAUTION** Should an oven fire occur, close the oven door and turn off the oven. If the fire continues, use a fire extinguisher. **DO NOT** put water or flour on the fire. Flour may be explosive.

# Oven Cleaning

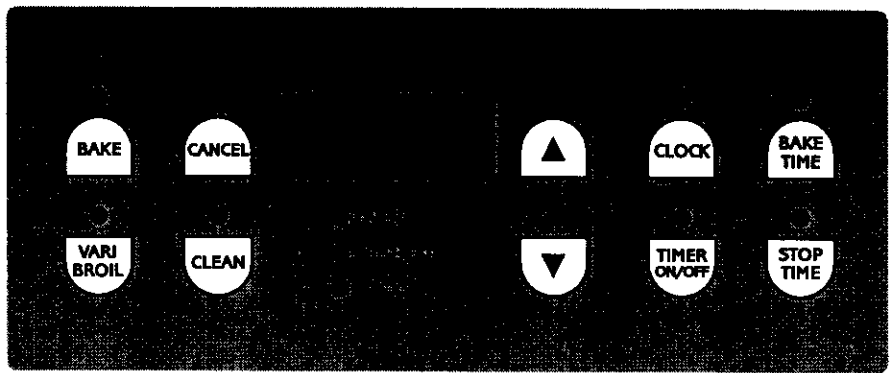

**CAUTION** During the self-cleaning cycle, the outside of the range can become very hot to the touch. **DO NOT** leave small children unattended near the appliance.

**CAUTION** The health of some birds is extremely sensitive to the fumes given off during the self-cleaning cycle of any range. Move birds to another well-ventilated room.

**CAUTION** **DO NOT** line the oven walls, racks, bottom or any other part of the range with aluminum foil. Doing so will destroy heat distribution, produce poor baking results and cause permanent damage to the oven interior (aluminum foil will melt to the interior surface of the oven).

**CAUTION** **DO NOT** force the oven door open. This can damage the automatic door locking system. Use caution when opening the door after the self-cleaning cycle is completed. The oven may still be **VERY HOT**.

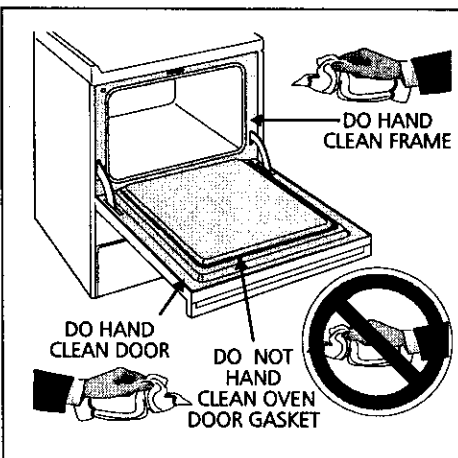

## Self-Cleaning Oven

A self-cleaning oven cleans itself with high temperatures (well above cooking temperatures) which eliminate soil completely or reduce it to a fine powdered ash you can wipe away with a damp cloth.

### 1. Adhere to the following cleaning precautions:

- Allow the oven to cool before precleaning.
  - Wear rubber gloves when precleaning and while wiping up the residue after the self-clean cycle.
  - **DO NOT** use oven cleaners or oven protective coatings in or around any part of the self-cleaning oven.
  - **DO NOT** clean the oven door gasket. The woven material of the oven door gasket is essential for a good seal. Care should be taken not to rub, damage or remove the gasket.
  - **DO NOT** use any cleaning materials on the oven door gasket. Doing so could cause damage.
- ### 2. Remove the broiler pan and insert, all utensils and any aluminum foil. These items cannot withstand high cleaning temperatures.
- ### 3. Oven racks may be left in the oven or may be removed. If they go through the clean cycle their color will turn slightly blue and the finish will be dull. After the cycle is complete and the oven has cooled, rub the sides of the racks with wax paper or a cloth containing a small amount of baby oil or salad oil (this will make the racks glide easier into the rack position).
- ### 4. Remove any excess spillovers in the oven cavity before starting the self-cleaning cycle. To clean, use hot, soapy water and a cloth. Large spillovers can cause heavy smoke or fire when subjected to high temperatures. **DO NOT** allow food spills with a high sugar or acid content (such as milk, tomatoes, sauerkraut, fruit juices or pie filling) to remain on the surface as they may cause a dull spot even after cleaning.
- ### 5. Clean any soil from the oven frame, the door liner outside the oven door gasket and the small area at the front center of the oven bottom. These areas heat sufficiently to burn soil on. Clean with soap and water.

## Oven Cleaning

(continued)

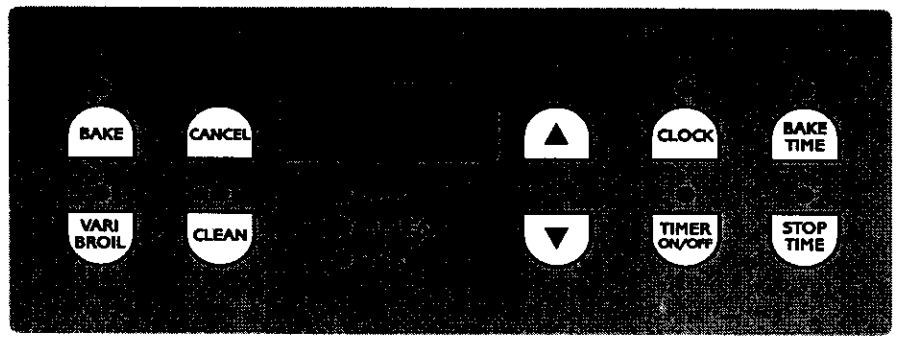

**CAUTION** Use care when opening the oven door after the self-cleaning cycle. Stand to the side of the oven when opening the door to allow hot air or steam to escape.

**CAUTION** DO NOT force the oven door open. This can damage the automatic door locking system. Use caution when opening the door after the self-cleaning cycle is completed. The oven may still be VERY HOT.

### To Start the Self-Clean Cycle

\*We recommend a 2 hour self-clean cycle for light soils and a 3 hour cycle for average to heavy soils (to assure satisfactory results).

#### To Set the Controls for a Self-Clean Cycle:

1. Be sure the clock shows the correct time of day.
2. Push **CLEAN**. "— — —" appears in the display.
3. Push the **▲** until "3:00" appears in the display for a 3 hour cycle, or push the **▼** until "2:00" appears in the display for a 2 hour cycle.
4. As soon as the **▲** or **▼** is released, "CLn" appears in the display.
5. As soon as the controls are set, the motor driven lock will begin to close automatically and the "LOCK" indicator light will flash. DO NOT open the door while the light is flashing (it takes about 15 seconds for the lock to close).
6. The "LOCK" light will glow until the cleaning cycle is completed or cancelled, and the oven temperature has cooled.

#### When the Self-Clean Cycle is Completed:

1. The time of day will appear in the display window and the "LOCK" light will continue to glow.
2. Once the oven has cooled down for about 1 HOUR and the "LOCK" light has gone out, the oven door can be opened.

### Stopping or Interrupting a Self-Cleaning Cycle

If it becomes necessary to stop or interrupt a self-cleaning cycle due to excessive smoke or fire:

1. Push **CLEAR**.
2. Once the oven has cooled down for about 1 HOUR and the "LOCK" light has gone out, the oven door can be opened.
3. Correct the condition which caused the smoking.
4. Restart the self-clean cycle once all conditions have been corrected.

## General Cleaning

### Cleaning Various Parts of Your Range

Before cleaning any part of the range, be sure all controls are turned OFF and the range is cool. Remove spillovers and heavy soiling as soon as possible. Regular cleanings will reduce the effort required for major cleanings later.

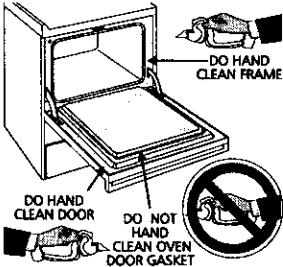
Surfaces	How to Clean
Aluminum (Trim Pieces) & Vinyl	Use hot, soapy water and a cloth. Dry with a clean cloth.
Glass, Painted and Plastic Control Knobs, Body Parts, and Decorative Trim	<i>For general cleaning</i> , use hot, soapy water and a cloth. <i>For more difficult soils and built-up grease</i> , apply a liquid detergent directly onto the soil. Leave on soil for 30 to 60 minutes. Rinse with a damp cloth and dry. <b>DO NOT</b> use abrasive cleaners on any of these materials; they can scratch. To remove control knobs, turn to the OFF position; grasp firmly and pull straight off the shaft. To replace knobs after cleaning, line up the flat sides of both the knob and the shaft; then push the knob into place.
Stainless Steel, Chrome Control Panel, Decorative Trim	<i>Before cleaning the control panel</i> , turn all controls to OFF and remove the control knobs. To remove, pull each knob straight off the shaft. Clean using hot, soapy water and a dishcloth. Rinse with a clean water and a dishcloth. Cover stubborn spots with an ammonia-soaked paper towel for 30 to 40 minutes. Rinse. Be sure to squeeze excess water from the cloth before wiping the panel; especially when wiping around the controls. Excess water in or around the controls may cause damage to the appliance. Cleaners made especially for stainless steel such as Stainless Steel Magic, trademark of Magic American Corp., or similar products are recommended. Always follow the manufacturer's instructions. Be sure to rinse the cleaners as bluish stains may occur during heating and cannot be removed. To replace knobs after cleaning, line up the flat sides of both the knob and the shaft; then push the knob into place.
Porcelain Enamel Broiler Pan and Insert, Door Liner, Body Parts, Warmer Drawer (if equipped)	Gentle scouring with a soapy scouring pad will remove most spots. Rinse with a 1:1 solution of clear water and ammonia. <i>If necessary</i> , cover difficult spots with an ammonia-soaked paper towel for 30 to 40 minutes. Rinse with clean water and a damp cloth, and then scrub with a soap-filled scouring pad. Rinse and wipe dry with a clean cloth. Remove all cleaners or the porcelain may become damaged during future heating. <b>DO NOT</b> use spray oven cleaners on the cooktop.
Oven Racks 	Oven racks may be removed or left in the oven during the self-clean cycle for cleaning. If removed, clean by using a mild, abrasive cleaner following manufacturer's instructions. Rinse with clean water and dry.  If the racks are cleaned in the self-clean cycle, their color will turn slightly blue and the finish will be dull. After the self-clean cycle is complete, and the oven has cooled, rub the sides of the racks with wax paper or a cloth containing a small amount of baby oil or salad oil (this will make the racks glide easier into the rack positions).
Oven Door 	To clean oven door, wash with hot, soapy water and a clean cloth. <b>DO NOT</b> immerse the door in water.  <b>DO NOT</b> clean the oven door gasket. The oven door gasket is made of a woven material which is essential for a good seal. Care should be taken not to rub, damage or remove the gasket.

## General Cleaning

(continued)

**⚠ CAUTION** Be sure the range is cool before removing elements or drip bowls. Be careful not to bend terminal ends when replacing elements after cleaning.

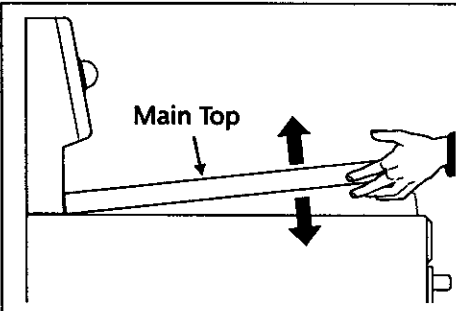
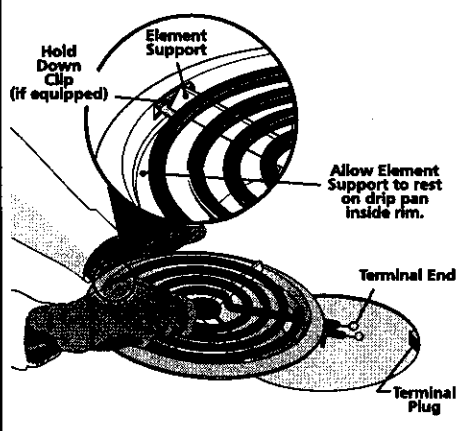

**⚠ CAUTION** When lowering the lift-up range top, grasp the sides with finger-tips only. Be careful not to pinch fingers. **DO NOT** drop or bend the range top when raising or lowering. This could damage the surface.

## Surface Elements and Drip Bowls

Surface elements can be unplugged and removed to make cleaning the drip pans easier. The surface elements clean themselves when they are turned on. Food spilled on a hot element will burn off. Food spilled on a cool element may be cleaned with a damp cloth—any remaining soil will burn off the next time the element is used.

**⚠ CAUTION** Never immerse a surface element in water.

### To Remove the Surface Elements and Drip Bowls

1. Lift the edge of the drip bowl across from the terminal end. Lift the surface element and drip bowl together just enough to clear the cooktop.
2. While holding the drip bowl and surface element, gently pull the terminal end out from the terminal plug. If equipped, **DO NOT** remove the hold down clip from the drip bowl.

### To Clean Drip Bowls

Wash in hot, soapy water or in the dishwasher. Rinse and dry while still warm. Hard to remove, burned on soil can be removed by soaking the drip bowls for about 20 minutes in a lightly diluted liquid cleanser or a solution of ammonia and water (1/2 cup ammonia to 1 gallon of water). A nylon scrubber may be used after soaking. **DO NOT** use abrasive cleaners or steel wool, as they will scratch the surface. Always rinse with clean water and polish dry with a soft cloth.

### To Replace Drip Bowls and Surface Elements

1. Slide the terminal end on the element through the opening in the drip bowl.
2. Align the element support to rest on the rim inside the drip bowl. If your drip bowl is equipped with a hold down clip, align the element support opposite the terminal end with the slot in the hold down clip, and snap into place.
3. After the element is positioned in the drip bowl, line up the terminal end with the terminal plug as shown.
4. Hold the surface element and drip bowl together as level as possible and firmly push the terminal end into the terminal plug. Make sure element terminal is seated properly into terminal plug. Make sure the surface element is level to reduce the hazard of pans sliding off the element.

### To Raise the Top for Cleaning

1. Grasp the sides and lift from the front. Lift-up rods will support the top in its raised position. Only lift the top high enough to allow the support rods to snap into place.
2. Clean underneath using a clean cloth and hot, soapy water.
3. To lower the top, gently push back on each rod to release the notched support. Hold the range top and slide the range top down into the range frame.

# General Cleaning

(continued)

**CAUTION** The door is heavy. For safe, temporary storage, lay the door flat with the inside of the door facing down.

## To Remove and Replace Oven Door

To Remove Oven Door:

1. Open the door.
2. Remove screws located on the inside of the oven door near the hinges **A** (one on each side.)
3. Close the door to the quarter-open position. Grasp the door firmly on both sides and lift up and off the hinges.
4. To clean oven door, follow the instructions provided in the cleaning chart under **General Cleaning**

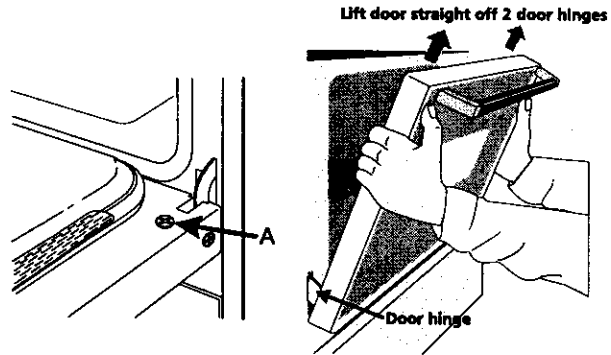

To Replace Oven Door:

1. Be sure the hinge arms are in the quarter-open position. Be careful if pulling the hinges open by hand. The hinges may snap back against the oven frame and could pinch fingers.
2. Hold the door at the sides near the top. Insert the hinge arms into slots at the bottom of the door.
3. Hinge arms must go into the range slots evenly. The hinge arms should be inserted into the bottom corners of the door as far as they can go.
4. If the door is not in line with the oven frame, remove it and repeat the above steps.

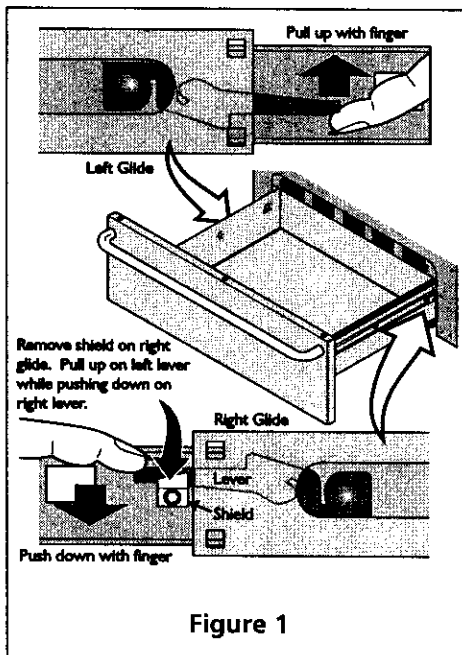

Figure 1

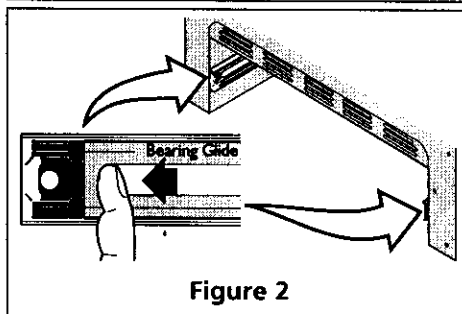

Figure 2

## To Remove and Replace Warmer Drawer (if equipped)

To Remove Warmer Drawer:

1. **CAUTION** Turn power off before removing the warmer drawer.
2. Open the drawer to the fully opened position.
3. On the right glide you will find a shield attached with a hex-head screw (see figure 1). Using a 1/4" socket and ratchet remove the shield.
4. Locate glide lever on each side of drawer, pull up on the left glide lever and push down on the right glide lever.
5. Pull the drawer away from the range.

To Replace Warmer Drawer:

1. Replace shield on the right glide of the drawer body.
2. **Pull the bearing glides to the front** of the chassis glide (see figure 2).
3. Align the glide on each side of the drawer with the glide slots on the range.
4. Push the drawer into the range until levers "click" (approximately 2"). Pull the drawer open again to seat bearing glides into position. **If you do not hear the levers "click" or the bearing glides do not feel seated remove the drawer and repeat steps 2-4.** This will minimize possible damage to the bearing glides.



**WARNING** Electrical Shock Hazard can occur and result in serious injury or death. Disconnect appliance from electric power before cleaning and servicing the warmer drawer.



## Changing Oven Light (some models)

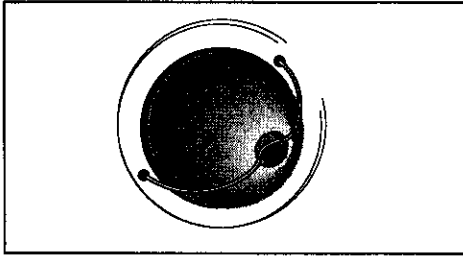

**CAUTION** Be sure the range is unplugged and all parts are COOL before replacing the surface or oven lights. Wear a leather-faced glove for protection against possible broken glass.

### To Change the Oven Light (some models)

On some models, the oven light automatically turns on when the door is opened. Some models have a switch located on the control panel to turn on the light. The oven light is located at the rear of the oven and is covered with a glass shield held by a wire holder. The glass shield must be in place whenever the oven is in use.

#### To replace the oven light:

1. Turn electrical power off at the main source or unplug the range.
2. Press wire holder to one side to release the glass shield.
3. Replace bulb with a new 40 watt appliance bulb.
4. Replace glass shield over bulb and snap wire holder into place.
5. Turn power back on again at the main source (or plug the range back in).
6. The clock(if equipped) will then need to be reset. To reset, see **Setting the Clock and Minute Timer** in this Owner's Guide.

## Adjusting Oven Temperature

**Note:** The adjustments made will not change the self-cleaning temperature.

The temperature in the oven has been set at the factory. When first using the oven, be sure to follow recipe times and temperatures. If you think the oven is too hot or too cool, the temperature in the oven can be adjusted. Before adjusting, test a recipe by using a temperature setting that is higher or lower than the recommended temperature. The baking results should help you to decide how much of an adjustment is needed.

#### To Adjust Oven Temperature:

1. Push **BAKE**.
2. Set the temperature to 550°F (287°C) by pushing and holding the **▲**.
3. Within 2 seconds, push and hold **BAKE** until the special 2 digit display appears. Release **BAKE**. The display now indicates the amount of degrees offset between the original factory temperature setting and the current temperature setting. If the oven control has the original factory calibration, the display will read "00."
4. The temperature can now be adjusted up or down 35°F (17°C), in 5°F (1°C) steps, by pushing and holding the **▲** or **▼**. Adjust until the desired amount of offset appears in the display.
5. When you have made the desired adjustment, push **CANCEL** to go back to the time of day display. When adjusting oven temperature, a minus sign (-) will appear before the number to indicate that the oven will be cooler by the displayed amount of degrees.

---

## Avoid Service Checklist

Before you call for service, review this list. It may save you time and expense. The list includes common occurrences that are not the result of defective workmanship or materials in this appliance.

This oven is equipped with a state of the art electronic oven controller. Among its many features is a full time oven circuit diagnostics system. The controller constantly monitors its internal circuitry as well as several crucial oven circuits to insure they are all operating correctly. If at any time one of these systems fails, the controller will immediately stop operation, beeping and flashing an error code of F1 or F3\* in the display window.

---

### OCCURRENCE

---

### POSSIBLE CAUSE/SOLUTION

Range is not level.

Poor installation. Place oven rack in center of oven. Place a level on the oven rack. Adjust leveling legs at base of range until the oven rack is level.

Be sure floor is level and is strong and stable enough to adequately support range.

If floor is sagging or sloping, contact a carpenter to correct the situation.

Kitchen cabinet alignment may make range appear unlevel. Be sure cabinets are square and have sufficient room for range clearance.

Cannot move appliance easily. Appliance must be accessible for service.

Cabinets not square or are built in too tightly. Contact builder or installer to make appliance accessible.

Carpet interferes with range. Provide sufficient space so range can be lifted over carpet.

\*Oven control beeps and displays F1 or F3.

Electronic control has detected a fault condition. Push **CANCEL** to clear the display and stop the beeping. Reprogram oven. If fault recurs, record fault number, push **CANCEL** and contact an authorized servicer.

Surface element too hot or not hot enough.

Incorrect control setting. Make sure the correct control is on for the surface element to be used.

Lightweight or warped pans used. Use only flat, evenly balanced, medium or heavyweight cookware. Flat pans heat better than warped pans. Cookware materials and weight of the material affect heating. Heavy- and medium-weight pans heat evenly. Because lightweight pans heat unevenly, foods may burn easily.

Surface element does not heat.

No power to the appliance. Check steps under "Entire Appliance Does Not Operate" in this Avoid Service Checklist.

Incorrect control setting. Make sure the correct control is on for the surface element to be used.

Element not making contact in block. Follow instructions under "Surface Elements and Drip Bowls" in the **General Cleaning** section.

Entire appliance does not operate.

Make sure cord/plug is plugged tightly into outlet.

Service wiring is not complete. Contact your dealer, installing agent or authorized servicer.

Power outage. Check house lights to be sure. Call your local electric company for service.

<b>Cooktop and/or oven light (some models) does not work.</b>	Replace or tighten bulb. See <b>Changing Cooktop and/or Oven Lights (some models)</b> in this Owner's Guide for instructions.
<b>Oven smokes excessively during broiling.</b>	<p>Control(s) not set properly. Follow instructions under <b>Setting Oven Controls</b>.</p> <hr/> <p>Make sure oven door is opened to <b>broil stop position</b>.</p> <hr/> <p>Meat too close to the element. Reposition the rack to provide proper clearance between the meat and the element. Preheat broil element for searing.</p> <hr/> <p>Meat not properly prepared. Remove excess fat from meat. Cut remaining fatty edges to prevent curling, but do not cut into lean.</p> <hr/> <p>Grid on broiler pan wrong side up and grease not draining. Always place grid on the broiler pan with ribs up and slots down to allow grease to drip into pan.</p> <hr/> <p>Grease has built up on oven surfaces. Regular cleaning is necessary when broiling frequently. Old grease or food spatters cause excessive smoking.</p>
<b>Poor baking results.</b>	Many factors affect baking results. Make sure the proper rack position is used. Center food in the oven and space pans to allow air to circulate. Allow the oven to preheat to the set temperature before placing food in the oven. Try adjusting the recipe's recommended temperature or baking time. If you feel the oven is too hot or cool, see <b>Adjusting Oven Temperature</b> in this Owner's Guide.
<b>Self-cleaning cycle does not work.</b>	<p>Control(s) not set properly. Follow instructions under <b>Oven Cleaning</b>.</p> <hr/> <p>Self-cleaning cycle was interrupted. Follow steps under "Stopping or Interrupting a Self-Cleaning Cycle" under <b>Oven Cleaning</b>.</p>
<b>Soil not completely removed after self-cleaning cycle.</b>	Failure to clean bottom, front top of oven, frame of oven or door area outside oven seal. These areas are not in the self-cleaning area, but get hot enough to burn on residue. Clean these areas before the self-cleaning cycle is started. Burned-on residue can be cleaned with a stiff nylon brush and water or a nylon scrubber. Be careful not to damage the oven gasket.
<b>Flames inside oven or smoking from vent.</b>	<p>Excessive spillovers in oven. Set self-clean cycle for a longer cleaning time.</p> <hr/> <p>Excessive spillovers in oven. This is normal, especially for high oven temperatures, pie spillovers or large amounts of grease on bottom of oven. Wipe up excessive spillovers before starting cycle. If flames or excessive smoke are present, stop the self-clean cycle and follow steps under "Stopping or Interrupting a Self-Cleaning Cycle" in the <b>Oven Cleaning</b> section.</p>
<b>Drip bowls are pitting or rusting.</b>	<p>Foods with acids, such as tomatoes, if allowed to stand in/on bowls will cause corrosion. Remove and wash drip bowls as soon as possible after a spillover</p> <hr/> <p>Normal environment. Houses along sea coast are exposed to salt air. Protect bowls as much as possible from direct exposure to salt air.</p>
<b>Drip bowls turning color or distorted.</b>	Bottom surface of cookware extends beyond surface elements and touches cooktop surface. This can cause high enough temperatures to discolor the drip bowls. <b>DO NOT</b> use cookware of this type. Pan sizes should be matched to the size of the element. Replacement drip bowls may be purchased from your dealer.

# MULTIFLEX RANGE WARRANTY

Your product is protected by this warranty

Your appliance is warranted by White Consolidated Industries, Inc. WCI has authorized Frigidaire Company Consumer Services and their authorized servicers to perform services under this warranty. WCI authorizes no one else to change or add to any of these obligations under this warranty. Any obligations for service and parts under this warranty must be performed by Frigidaire Consumer Services or an authorized Frigidaire servicer.

	WARRANTY PERIOD	WCI, THROUGH OUR AUTHORIZED SERVICERS:	THE CONSUMER WILL BE RESPONSIBLE FOR:
<b>FULL ONE-YEAR WARRANTY</b>	One year from original purchase date.	Pay all costs for repairing or replacing any parts of this appliance which prove to be defective in materials or workmanship.	Costs of service calls that are listed under <b>NORMAL RESPONSIBILITIES OF THE CONSUMER.*</b>
<b>LIMITED WARRANTY (Applicable to the State of Alaska)</b>	Time period listed above.	All of the provisions of the full warranty above and the exclusions listed below apply.	Costs of the technician's travel to the home and any costs for pick up and delivery of the appliance required because of service.

## \*NORMAL RESPONSIBILITIES OF THE CONSUMER

This warranty applies only to products in ordinary household use, and the consumer is responsible for the items listed below:

1. Proper use of the appliance in accordance with instructions provided with the product.
2. Proper installation by an authorized servicer in accordance with instructions provided with the appliance and in accordance with all local plumbing, electrical and/or gas codes.
3. Proper connection to a grounded power supply of sufficient voltage, replacement of blown fuses, repair of loose connections or defects in house wiring.
4. Expenses for making the appliance accessible for servicing, such as removal of trim, cupboards, shelves, etc., which are not a part of the appliance when it was shipped from the factory.
5. Damages to finish after installation.
6. Replacement of light bulbs and/or fluorescent tubes (on models with these features).

## EXCLUSIONS

This warranty does not cover the following:

1. CONSEQUENTIAL OR INCIDENTAL DAMAGES SUCH AS PROPERTY DAMAGE AND INCIDENTAL EXPENSES RESULTING FROM ANY BREACH OF THIS WRITTEN OR ANY IMPLIED WARRANTY.  
*Note: Some states do not allow the exclusion or limitation of incidental or consequential damages, so this limitation or exclusion may not apply to you.*
2. Service calls which do not involve malfunction or defects in workmanship or material, or for appliances not in ordinary household use. The consumer shall pay for such service calls.
3. Damages caused by services performed by persons other than authorized Frigidaire Company servicers; use of parts other than Frigidaire Company Genuine Renewal Parts; obtained from persons other than such servicers; or external causes such as abuse, misuse, inadequate power supply or acts of God.
4. Products with original serial numbers that have been removed or altered and cannot be readily determined.

## IF YOU NEED SERVICE

Keep your bill of sale, delivery slip, or some other appropriate payment record. The date on the bill establishes the warranty period should service be required. If service is performed, it is in your best interest to obtain and keep all receipts. This written warranty gives you specific legal rights. You may also have other rights that vary from state to state. Service under this warranty must be obtained by following these steps, in order:

1. Contact Frigidaire Company Consumer Services or an authorized Frigidaire Company servicer.
2. If there is a question as to where to obtain service, call or write our Consumer Assistance Center at:

Frigidaire Home Products Consumer Relations  
P.O. Box 212378  
Augusta, Georgia 30917-2378  
(800) 944-9044



Product features or specifications as described or illustrated are subject to change without notice. All warranties are made by White Consolidated Industries, Inc. This warranty applies only in the 50 states of the U.S.A. and Puerto Rico.