

Panasonic®

DVD Stereo System

Operating Instructions

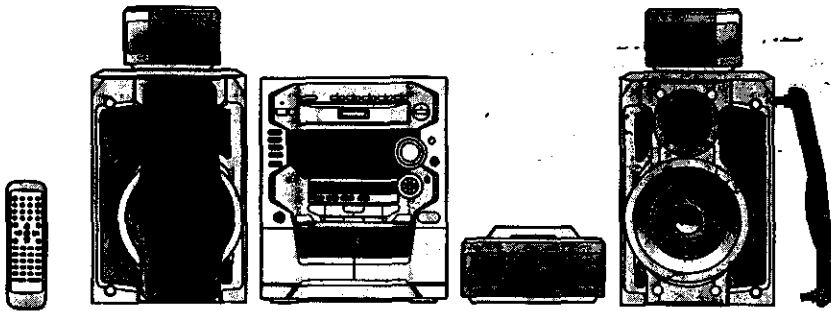

The illustration shows the model for U.S.A., Australia and New Zealand.

Model No. **SC-DK2**

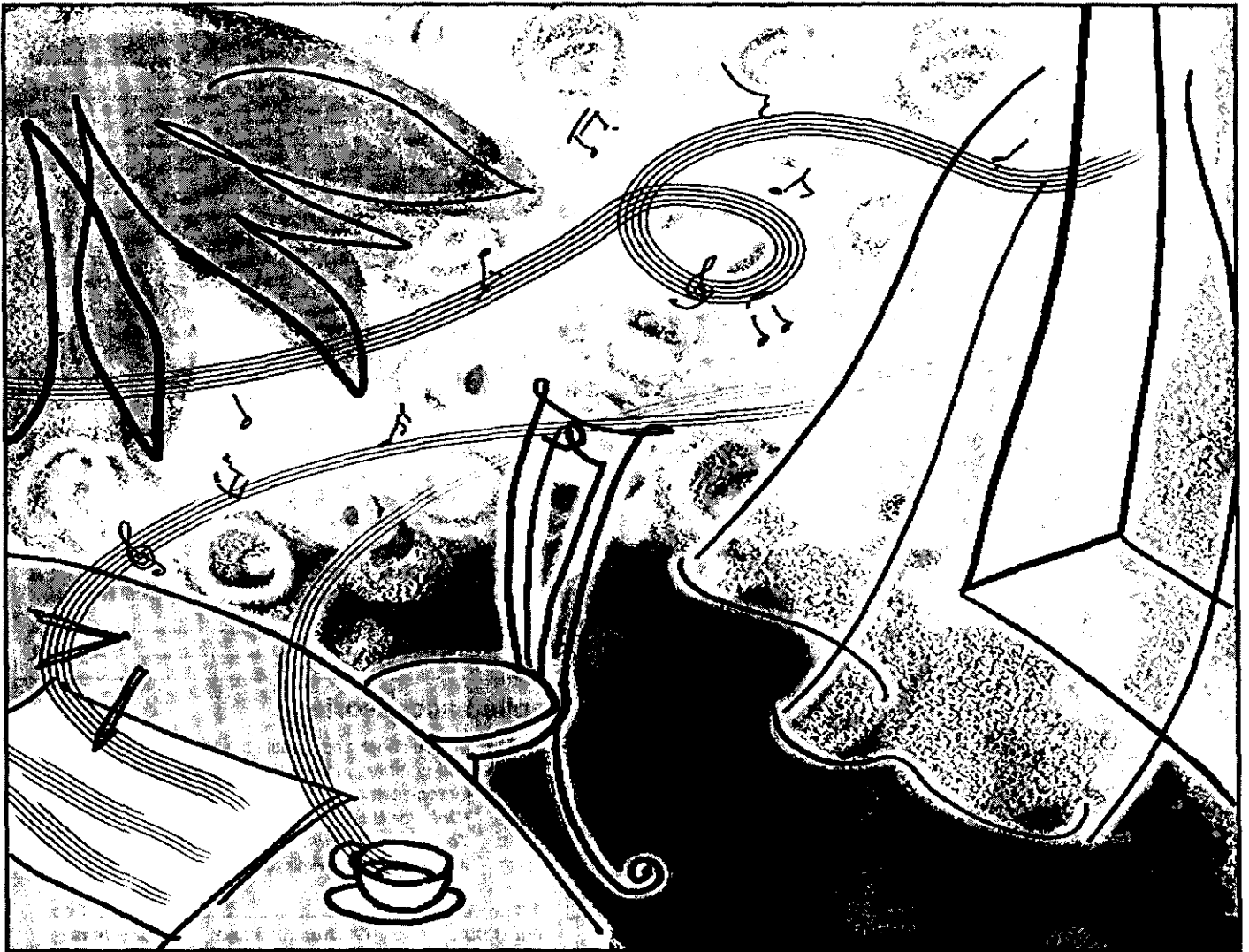

Before connecting, operating or adjusting this product, please read these instructions completely.
Please keep this manual for future reference.

Thank you for purchasing this product.
For optimum performance and safety, please read these instructions carefully.
These operating instructions are applicable to the following system.

System		SC-DK2
Main unit		SA-DK2
Speakers	Front	SB-DK2
	Center	SB-PC70
	Surround	SB-PS70

CAUTION!
THIS PRODUCT UTILIZES A LASER.
USE OF CONTROLS OR ADJUSTMENTS OR PERFORMANCE OF PROCEDURES OTHER THAN THOSE SPECIFIED HEREIN MAY RESULT IN HAZARDOUS RADIATION EXPOSURE.
DO NOT OPEN COVERS AND DO NOT REPAIR YOURSELF. REFER SERVICING TO QUALIFIED PERSONNEL.

CAUTION!
DO NOT INSTALL OR PLACE THIS UNIT IN A BOOKCASE, BUILT IN CABINET OR IN ANOTHER CONFINED SPACE. ENSURE THE UNIT IS WELL VENTILATED. ENSURE THAT CURTAINS AND ANY OTHER MATERIALS DO NOT OBSTRUCT THE VENTILATION TO PREVENT RISK OF ELECTRIC SHOCK OR FIRE HAZARD DUE TO OVERHEATING.

WARNING:
TO REDUCE THE RISK OF FIRE, ELECTRIC SHOCK OR PRODUCT DAMAGE, DO NOT EXPOSE THIS APPLIANCE TO RAIN, SPLASHING, DRIPPING OR MOISTURE.

DANGER	LASER RADIATION WHEN OPEN. AVOID DIRECT EXPOSURE TO BEAM.	(Inside of product)
DANGERS	RADIATION LASER LORSQUE OUVERT. EVITER TOUTE EXPOSITION AU FAISCEAU.	(Intérieur de l'appareil)
ADVARSEL	LASERSTRÅLING VED ÅBNING. NÅR SIKKERHEDSAFBRYDERE ER LØSE AF FUNKTION. UNDGÅ UDSÆTTELSE FOR STRÅLING.	(Indersiden af apparatet)
VARO!	AVAITTAESSA JA SUOJALUKITUS OHITETTÄESSÄ OLET ALLTIMMÄ LASERSÄTEILYLLE. ÄLÄ KATSO SÄTEESEEN.	(Tuotteen sisällä)
VARNING	LASERSTRÅLING NÅR DENNA DEL ÄR ÖPPNAD OCH SPÄRREN ÄR URKOPPLAD. BETRÄKTA EJ STRÅLEN.	(Apparatens insida)
ADVARSEL	LASERSTRÅLING NÅR DEKSEL ÅPNES OG SIKKERHEDSLÅS BRYTES. UNDGÅ EKSPONERING FOR STRÅLEN.	(Produktets inside)
VORSICHT	LASERSTRÄHLUNG, WENN ABDECKUNG GEÖFFNET. NICHT DEM STRAHL AUSSETZEN.	(Im Inneren des Gerätes)

Except for U.S.A.

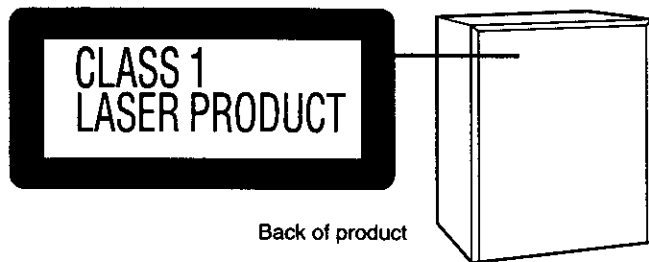

Except for U.S.A., Australia and New Zealand

CAUTION:
The AC voltage is different according to the area.
Be sure to set the proper voltage in your area before use.
(For details, please refer to pages 8 and 9.)

Before use

Supplied accessories 2
PRECAUTIONS 4
 Disc symbols used in these operating instructions 5
 Region numbers 5
 Types of discs 6
 The remote control 6
Installation 7
 Basic connections 8
 Optional antenna connections 9
 Front panel controls 10
 Setting the time 12
 Turning DEMO off 12
 Saving power in the standby mode 13
 Auto power-off 13
 Television settings 14

Disc operations

Discs 15
 Normal play 15
 Other methods of disc play 17
 Pause (Still picture) 17
 Skip function 17
 Search function 17
 Frame-by-frame viewing 18
 Slow-motion play 18
 Repeat function 19
 Marking a position 20
 Changing the picture quality for movie viewing 21
 Changing soundtrack and subtitle languages 21
 Switching angles 22
 Using menus to play 22
 Program play 23
 Starting play from a specific track 24
 Random play 24
 Using the CD MANAGER 25
 Using GUI screens 26
 GUI icon descriptions 27

Radio operations

The radio: manual tuning 29
 The radio: preset tuning 30

Supplied accessories

Please check and identify the supplied accessories. Use numbers indicated in parentheses when asking for replacement parts.
(Only for U.S.A.)
To order accessories contact 1-800-332-5368 or web site (<http://www.panasonic.com>).

- AC power supply cord 1 pc.
 For U.S.A. (RJA0065-A) For Australia and New Zealand (RJA0035-X) For others (RJA0019-2K)
- FM indoor antenna 1 pc. (RSA0006-J)
- AM loop antenna 1 pc. (RSA0029)

Tape operations

Cassette tapes 31

Sound quality/sound field operations

Changing sound field and quality 33
 Boosting the super woofer 35
 Using the tri-amp control 35
 Enjoying surround sound 36
 AV effects 41

Recording operations

Before recording (Deck 2 only) 42
 Recording discs 43
 Recording the radio 44
 Tape-to-tape recording 44

KARAOKE operations

Except for U.S.A., Australia and New Zealand

Enjoying karaoke 45

Timer and others

Using the timers 48
 Convenient functions 51
 Using headphones (not included) 51
 External unit connections 52
 Using other equipment 53
 Initial settings 54

References

Troubleshooting guide 60
 Maintenance 61
 Product Service 61
 Servicenter List (US) 62
 Specifications 63

- Video cable 1 pc.
(RJL1P016B15A)



- Remote control transmitter 1 pc.
For U.S.A., Australia and New Zealand (RAK-SA962WK)
For others (RAK-SA963WK)



- Remote control batteries 2 pcs.



- Power plug adaptor 1 pc.
Except for U.S.A., Australia, New Zealand and Asia
(SJP5213-2)



CAUTION:

This equipment has been tested and found to comply with the limits for a Class B digital device, pursuant to Part 15 of the FCC Rules.

These limits are designed to provide reasonable protection against harmful interference in a residential installation. This equipment generates, uses and can radiate radio frequency energy and, if not installed and used in accordance with the instructions, may cause harmful interference to radio communications. However, there is no guarantee that interference will not occur in a particular installation. If this equipment does cause harmful interference to radio or television reception, which can be determined by turning the equipment off and on, the user is encouraged to try to correct the interference by one or more of the following measures:

- Reorient or relocate the receiving antenna.
- Increase the separation between the equipment and receiver.
- Connect the equipment into an outlet on a circuit different from that to which the receiver is connected.
- Consult the dealer or an experienced radio/TV technician for help.

Any unauthorized changes or modifications to this equipment would void the user's authority to operate this device.

This device complies with Part 15 of the FCC Rules. Operation is subject to the following two conditions: (1) This device may not cause harmful interference, and (2) this device must accept any interference received, including interference that may cause undesired operation.

Before use

THE FOLLOWING APPLIES ONLY IN THE U.S.A.:



CAUTION: TO REDUCE THE RISK OF ELECTRIC SHOCK, DO NOT REMOVE SCREWS. NO USER-SERVICEABLE PARTS INSIDE. REFER SERVICING TO QUALIFIED SERVICE PERSONNEL.



The lightning flash with arrowhead symbol, within an equilateral triangle, is intended to alert the user to the presence of uninsulated "dangerous voltage" within the product's enclosure that may be of sufficient magnitude to constitute a risk of electric shock to persons.



The exclamation point within an equilateral triangle is intended to alert the user to the presence of important operating and maintenance (servicing) instructions in the literature accompanying the appliance.

PRECAUTIONS

Before using this unit please read these operating instructions carefully. Take special care to follow the warnings indicated on the unit itself as well as the safety suggestions listed below. Afterwards keep them handy for future reference.

Before use

Safety

- 1. Power Source**—The unit should be connected to power supply only of the type described in the operating instructions or as marked on the unit.
- 2. Polarization**—If the unit is equipped with a polarized AC power plug (a plug having one blade wider than the other), that plug will fit into the AC outlet only one way. This is a safety feature. If you are unable to insert the plug fully into the outlet, try reversing the plug. If the plug should still fail to fit, contact your electrician to replace your obsolete outlet. Do not defeat the safety purpose of the polarized plug.
- 3. Power Cord Protection**—AC power supply cords should be routed so that they are not likely to be walked on or pinched by items placed upon or against them. Never take hold of the plug or cord if your hand is wet, and always grasp the plug body when connecting or disconnecting it.
- 4. Nonuse Periods**—When the unit is not used, turn the power off. When left unused for a long period of time, the unit should be unplugged from the household AC outlet.

Installation

Environment

- 1. Outdoor Antenna Grounding**—If an outside antenna is connected to the receiver, be sure the antenna system is grounded so as to provide some protection against voltage surges and built-up static charges. Section 810 of the National Electrical Code, ANSI/NFPA No. 70-1990, provides information with respect to proper grounding of the mast and supporting structure, grounding of the lead-in wire to an antenna discharge unit, size of grounding conductors, location of antenna-discharge unit, connection to grounding electrodes, and requirements for the grounding electrode. See figure below.

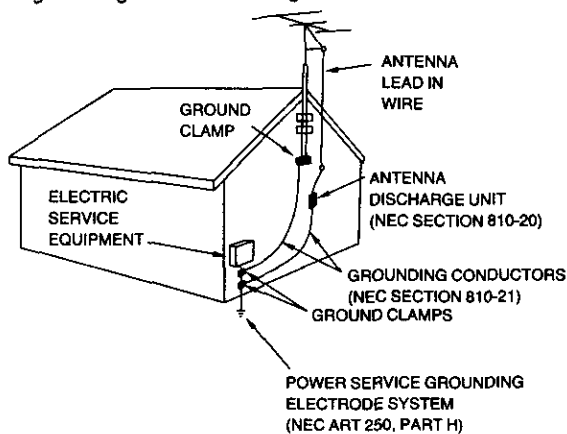

NEC—NATIONAL ELECTRICAL CODE

- 2. Water and Moisture**—Do not use this unit near water—for example, near a bathtub, washbowl, swimming pool, or the like. Damp basements should also be avoided.

- 3. Heat**—The unit should be situated away from heat sources such as radiators and the like. It also should not be placed in temperatures less than 5°C (41°F) or greater than 35°C (95°F).
- 4. Condensation**—Moisture may form on the lens in the following conditions...
 - immediately after a heater has been turned on.
 - in a steamy or very humid room.
 - when the unit is suddenly moved from a cold environment to a warm one.If moisture forms inside this unit, it may not operate properly. To correct this problem, turn on the power and wait about one hour for the moisture to evaporate.

Placement

- 1. Ventilation**—The unit should be situated so that its location or position does not interfere with its proper ventilation. Allow 10 cm (4") clearance from the rear of the unit.
- 2. Foreign Material**—Care should be taken so that objects do not fall into and liquids are not spilled into the unit. Do not subject this unit to excessive smoke, dust, mechanical vibration, or shock.
- 3. Magnetism**—The unit should be situated away from equipment or devices that generate strong magnetic fields.
- 4. Stacking**—Do not place heavy objects, other than system components, on top of the unit.
- 5. Surface**—Place the unit on a flat, level surface.
- 6. Carts and Stands**—The unit should be used only with a cart or stand that is recommended by the manufacturer. The unit and cart combination should be moved with care. Quick stops, excessive force, and uneven surfaces may cause the unit and cart combination to overturn.
- 7. Wall or Ceiling Mounting**—The unit should not be mounted to a wall or ceiling, unless specified in this operating instructions.



Maintenance

(See page 61 for details.)

Clean the cabinet, panel and controls with a soft cloth lightly moistened with mild detergent solution. Do not use any type of abrasive pad, scouring powder or solvent such as alcohol or benzine.

Service

- 1. Damage Requiring Service**—The unit should be serviced by qualified service personnel when:
 - (a) The AC power supply cord or the plug has been damaged; or
 - (b) Objects have fallen or liquid has been spilled into the unit; or
 - (c) The unit has been exposed to rain; or
 - (d) The unit does not appear to operate normally or exhibits a marked change in performance; or
 - (e) The unit has been dropped, or the enclosure damaged.
- 2. Servicing**—The user should not attempt to service the unit beyond that described in the operating instructions. All other servicing should be referred to an authorized service personnel. **For the address of an authorized servicenter:**
In the U.S.A., call 1-800-211-7262,
e-mail consumerproducts@panasonic.com,
or visit www.panasonic.com

Listening caution



Selecting fine audio equipment such as the unit you've just purchased is only the start of your musical enjoyment. Now it's time to consider how you can maximize the fun and excitement your equipment offers. This manufacturer and the Electronic Industries Association's Consumer Electronics Group want you to get the most out of your equipment by playing it at a safe level. One that lets the sound come through loud and clear without annoying blaring or distortion—and, most importantly, without affecting your sensitive hearing.

We recommend you to avoid prolonged exposure to excessive noise.

Sound can be deceiving. Over time your hearing "comfort level" adapts to higher volumes of sound. So what sounds "normal" can actually be loud and harmful to your hearing.

Guard against this by setting your equipment at a safe level BEFORE your hearing adapts.

To establish a safe level:

- Start your volume control at a low setting.
- Slowly increase the sound until you can hear it comfortably and clearly, and without distortion.

Once you have established a comfortable sound level:

- Set the dial and leave it there.

Taking a minute to do this now will help to prevent hearing damage or loss in the future. After all, we want you listening for a lifetime.

Disc symbols used in these operating instructions

The functions you can use depend on the type of disc you play. These marks are used to indicate which type of disc is available for use.

DVD : Feature can be used with DVD-Video

V-CD : Feature can be used with Video CD

CD : Feature can be used with Audio CD

Some features cannot be used even if these symbols are indicated.

Glossary

Track

This is the smallest division on Video CD and Audio CD, and usually equates to a single song.

Chapter

This is the smallest division on DVD and is roughly equivalent to a track.

Title

This is the largest division of DVD.

PBC (Playback control)

This method of controlling disc play is included on version 2.0 Video CDs. You are able to interact with the disc through menus.

Region numbers

Region numbers are allocated to DVD players and software according to where they are sold.

DVDs can be played on this unit if their region number is the same or includes the same number, or if the DVD is marked "ALL".

Confirm the region number for this unit before choosing discs. The number for this unit is indicated on the rear panel.

(For example)

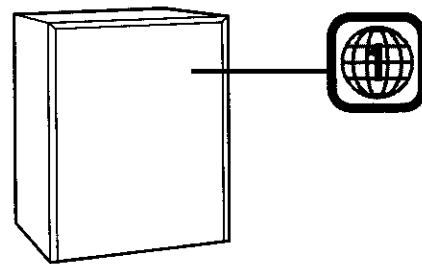

Rear panel

Discs that can be played by the unit shown in this example.



This unit can playback discs bearing any of the marks:



This unit does not have a DTS decoder so it cannot play audio encoded with DTS.

This unit cannot play the following discs:

- DVD with an unsuitable region number (⇒ page 5)
- DVD-Audio
- DVD-ROM
- DVD-R
- DVD-RAM
- DVD+RW
- DVD-RW
- DIVX Video Disc
- VSD
- CD-ROM
- CDV
- CVD
- CD-G
- CD-RW
- SACD
- SVCD
- CD-R
- Photo CD, etc.

Type of disc for the type of connected TV

DVDs and Video CDs are recorded using either PAL or NTSC. Refer to this table when selecting discs.

Example of how the picture appears on the screen



TV type	Disc	TV Monitor		
		For Asia	For Australia and New Zealand	For others
Multi-system TV	PAL	✓	✓	×
	NTSC	✓	✓*2	✓
NTSC TV	PAL	×	×	×
	NTSC	✓	×	✓
PAL TV*1	PAL	✓	✓	×
	NTSC	✓*3	✓*4	×

- *1 Only for Asia
Screens shown while the unit is stopped (e.g. initial settings) may not be displayed correctly.
- *2 If you select "2 NTSC" in "9 Other Settings" – "6 NTSC Disc Output", the picture may be clearer (⇒ page 54).
- *3 In "9 Other Settings" – "6 NTSC Disc Output", select "1 PAL 60" (⇒ page 54). If your television is not equipped to handle PAL 525/60 signals the picture will not be shown correctly.
- *4 The factory setting for NTSC disc output is "PAL 60", so no changes to the initial setting are necessary.

Note

The bottom part of the picture may be cut off if the Video CD played does not comply with standards.

Batteries

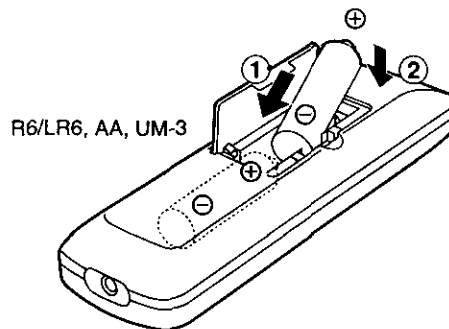

- Insert so the poles (+ and –) match those in the remote control.
- Do not use rechargeable type batteries.

Do not;

- mix old and new batteries.
 - use different types at the same time.
 - heat or expose to flame.
 - take apart or short circuit.
 - attempt to recharge alkaline or manganese batteries.
 - use batteries if the covering has been peeled off.
 - keep together with metallic objects such as necklaces.
- Mishandling of batteries can cause electrolyte leakage which can damage items the fluid contacts and may cause a fire. If electrolyte leaks from the batteries, consult your dealer. Wash thoroughly with water if electrolyte comes in contact with any part of your body.

Remove if the remote control is not going to be used for a long period of time. Store in a cool, dark place. Replace if the unit does not respond to the remote control even when held close to the front panel.

Use

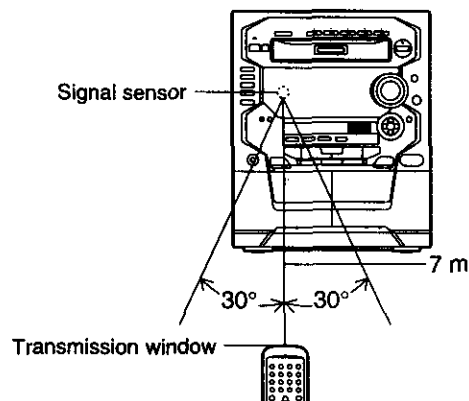

- Aim at the sensor, avoiding obstacles, at a maximum range of 7 meters directly in front of the unit.
- Keep the transmission window and the unit's sensor free from dust.
 - Operation can be affected by strong light sources, such as direct sunlight, and the glass doors on cabinets.

Do not;

- put heavy objects on the remote control.
- take the remote control apart.
- spill liquids onto the remote control.

A

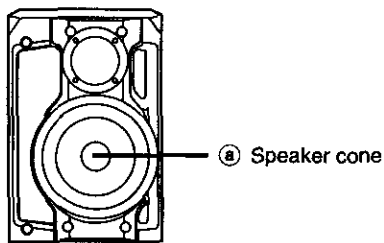
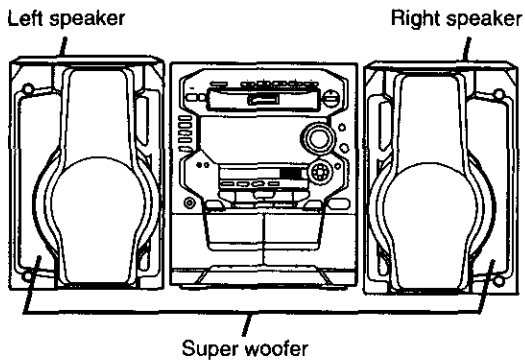

B

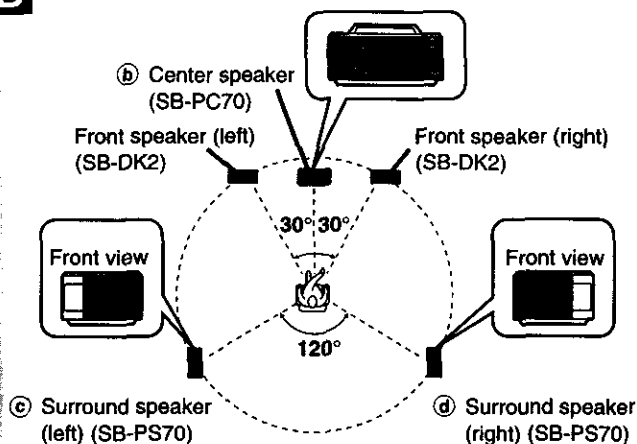

The front, center, and surround speakers should be placed at approximately the same distance from the listening position. The angles in the diagram are approximate.

C

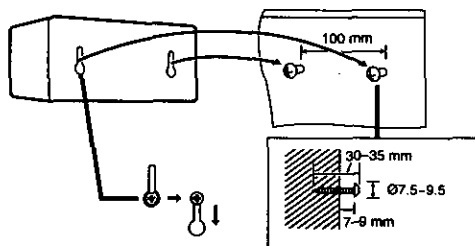

Installation

A Placement of front speakers

Place the speakers so that the super woofer is on the outside.

Note

- Keep your speakers at least 10 mm (13/32") away from the system for proper ventilation.
- To avoid damage to the speakers, do not touch the speaker cones (a) if you take the nets off.

B Placement of center/surround speakers

Center speaker

Place the center speaker (b) directly above the television.

Note

Do not place the center speaker on this unit as sound quality will be affected.

Surround speakers

Place the surround speakers (c, d) either side of the listening position, or slightly to the rear, about 1 meter higher than ear level. Place the speakers with the Panasonic logo facing towards the listening position. However, the position should be adjusted to your personal preference, because the effect varies to some degree depending upon the type of music and the music source.

Note

If you are unable to position the surround speakers as recommended, you can put them near the front speakers and still achieve a surround-like effect (→ pages 37 and 41 "Virtual rear surround").

C Attaching to a wall

Set speaker onto screws and slide through bracket to lock into position.

Note

The wall or pillar on which the speakers are to be attached should be capable of supporting 5 kg (11 lb.).

Use only the supplied speakers.

The combination of the unit and the included speakers provides the best sound. Using other speakers can damage the unit and sound quality will be adversely affected.

Caution

- Use the speakers only with the recommended system. Failure to do so may lead to damage to the amplifier and/or the speakers, and may result in the risk of fire. Consult a qualified service person if damage has occurred or if you experience a sudden change in performance.
- Do not attempt to attach these speakers to walls using methods other than those described in this manual.

If irregular coloring occurs on your television

Turn the television off for about 30 minutes.

The television's demagnetizing function should correct the problem. If it persists, move the speakers further away from the television.

Before use

Before use

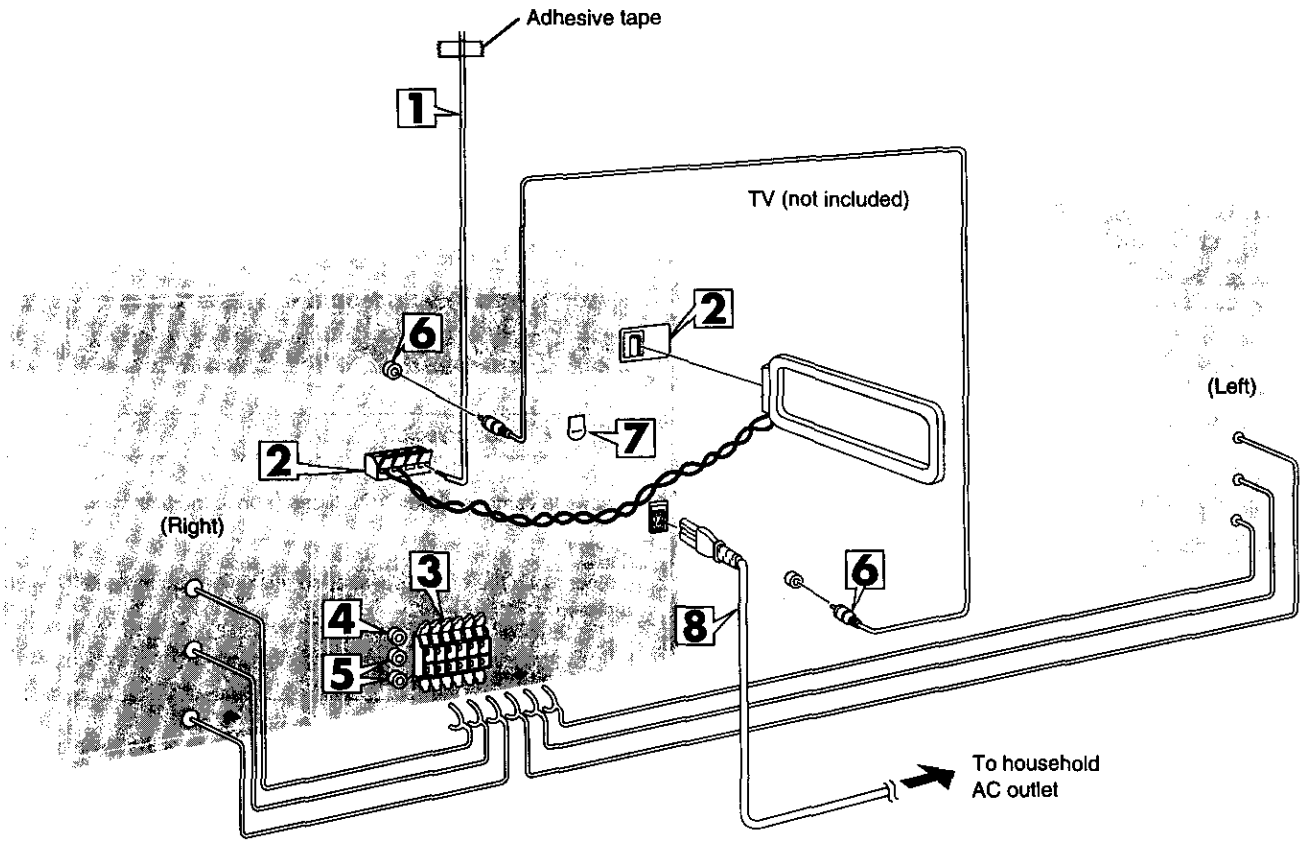

<p>1</p>	<p>4</p> <p>Center speaker</p>	<p>7</p> <p>(Except for U.S.A., Australia and New Zealand)</p> <p>VOLT ADJ</p>
<p>2</p> <p>AM loop antenna</p>	<p>5</p> <p>Surround speakers (Left) (Right)</p>	<p>8</p> <p>Connector</p> <p>AC IN ~</p> <p>Appliance inlet</p>
<p>3</p> <p>From the right speaker</p> <p>From the left speaker</p> <p>Red (+)</p> <p>Blue (+)</p> <p>Gray (+)</p> <p>Black (-)</p>	<p>6</p> <p>VIDEO OUT</p> <p>To TV</p>	<p>4</p> <p>(Except for U.S.A., Australia, New Zealand and Asia)</p>

Before connection

- Do not connect the AC power supply cord until all other connections are complete.
- To prepare the AM loop antenna, speaker cables and FM antenna, twist the vinyl tip and pull off.

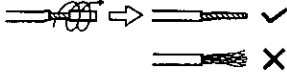

1 FM antenna.

Fix the other end of the antenna where reception is best.

2 AM loop antenna.

Clamp the antenna into the antenna holder, then connect the antenna terminal.

Keep loose antenna cord away from other wires and cords.

3 Front (L/R) speaker cables.

Connect the cables to the terminals of the same color.

Note

- To prevent damage to circuitry, never short-circuit positive (+) and negative (-) speaker wires.
- Be sure to connect only positive (red, blue or gray) wires to positive (+) terminals and negative (black) wires to negative (-) terminals.

4 Center speaker cable

5 Surround speaker cables

6 TV (not included)

Connect the video connection cord from this unit to your TV. Alternatively, connect through the [S-VIDEO] terminal if the TV has an S-VIDEO terminal (⇒ page 52).

7 (Except for U.S.A., Australia and New Zealand) Set the voltage.

Use a flat-head screwdriver to turn the voltage selector. Set it to the position for your area.

If the power supply in your area is 115 V or 120 V, please set the voltage selector as follows

For 115 V: Set to 110 V.

For 120 V: Set to 127 V.

8 AC power supply cord.

The shape of the connector depends on the area.

(Except for U.S.A., Australia, New Zealand and Asia)

A If the power plug will not fit your socket, use the power plug adaptor (included).

Note

The included AC power supply cord is for use with this unit only. Do not use it with other equipment.

For your reference

Information you enter into the unit's memory, except for time, remains intact for up to a week after the AC power supply cord is disconnected.

Optional antenna connections

Use outdoor antennas if radio reception is poor.

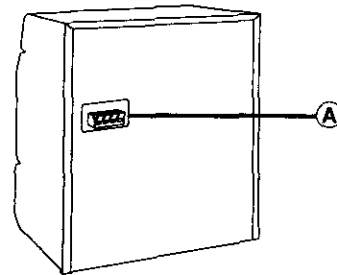

FM outdoor antenna

Note

- Disconnect the FM indoor antenna.
- The antenna should be installed by a competent technician.

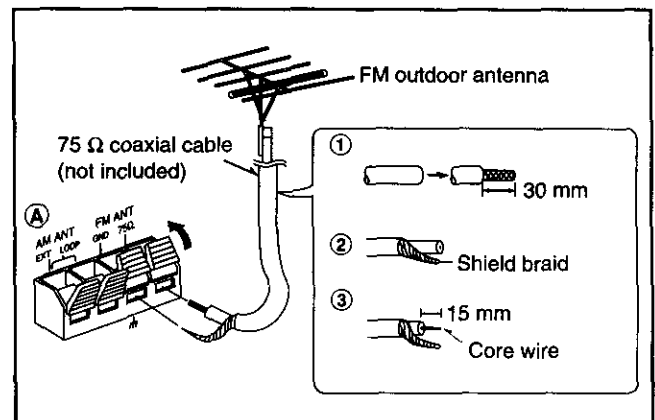

AM outdoor antenna

Run a piece of vinyl wire horizontally across a window or other convenient location.

Note

- Leave the loop antenna connected.
- Disconnect the antenna when the unit is not in use. Do not use the antenna during an electrical storm.

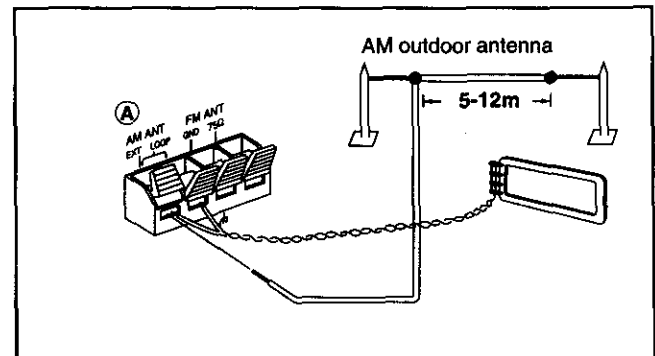

Main unit

The illustration is the model for the area except for U.S.A., Australia and New Zealand.

Before use

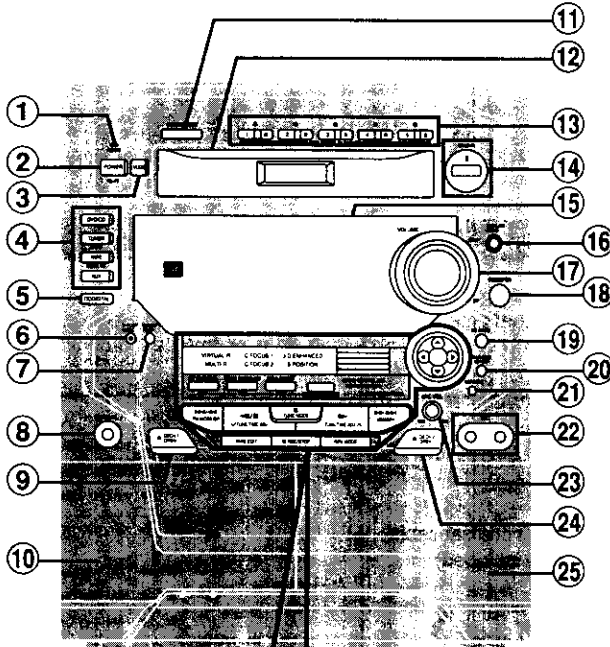

- ① AC supply indicator (AC IN)
This indicator lights when the unit is connected to the AC mains supply.
- ② Standby/on switch (⏻/I, POWER) 12
Press to switch the unit from on to standby mode or vice versa. In standby mode, the unit is still consuming a small amount of power.
- ③ ECO mode button (MODE) 13
- ④ Source select buttons (DVD/CD, TUNER, BAND, TAPE, DECK 1/2, AUX) 14, 29, 31, 53
- ⑤ DOLBY DIGITAL indicator (DOLBY DIGITAL) 38
- ⑥ Timer button (⏸PLAY/⏹REC) 48, 49
- ⑦ Clock/timer button (CLOCK/TIMER) 12, 48, 49, 50
- ⑧ Headphones jack (PHONES) 51
- ⑨ Deck 1 open button (⏏ DECK 1 OPEN) 31
- ⑩ Deck 1 cassette holder 31
- ⑪ CD manager button (CD MANAGER) 25
- ⑫ Disc tray
- ⑬ Disc select, tray open/close buttons and disc indicators (1, ⏏ - 5, ⏏) 15
- ⑭ CINEMA mode button and indicator (CINEMA) 21
- ⑮ Display
- ⑯ Display select/demonstration button (-DISPLAY/-DEMO) 12, 51
- ⑰ Volume control (VOLUME) 15, 29, 31
- ⑱ Super woofer button (S.WOOFER) 35, 38
- ⑲ 3D AI EQ button (3D AI EQ) 34

Except for U.S.A., Australia and New Zealand

- ⑳ Karaoke effect button (KARAOKE EFFECT) 47
- ㉑ Karaoke mode select button (KARAOKE) 45
- ㉒ Microphone jacks (MIC) 45
- ㉓ Microphone volume control (MIC VOL) 45
- ㉔ Deck 2 open button (⏏ DECK 2 OPEN) 31
- ㉕ Deck 2 cassette holder 31
- ㉖ DOLBY PRO LOGIC/lower range control button (DOLBY PRO LOGIC, LOW) 35, 39
- ㉗ AV effect indicators 41
- ㉘ Super surround/middle range control button (SUPER SURROUND, MID) 35, 40
- ㉙ Simulated stereo/higher range control button (SIMULATED ST, HIGH) 35, 40
- ㉚ Tri-amp control button (TRI-AMP CONTROL) 35
- ㉛ Jogcontrol (SOUND CONTROL JOG, PUSH (AV EFFECT)) 33, 35, 41
- ㉜ Joystick (⏪, ⏩, ▲, ▼) 33, 41, 45
- ㉝ Basic operation buttons
Functions change according to the source.
- ㉞ Tape edit button (TAPE EDIT) 44
- ㉟ Recording start/stop button (⏻REC/STOP) 43
- ㊱ Reverse mode select button (REV MODE) 31

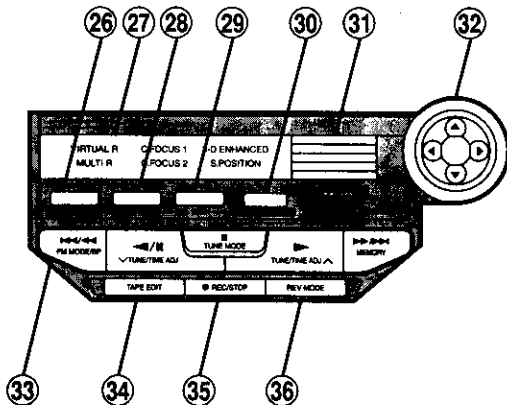

Remote control

Buttons such as 2 function in the same way as the controls on the main unit.

Buttons 49, 52 and 54 are labeled differently on the remote control for U.S.A., Australia and New Zealand (→ the lower illustration).

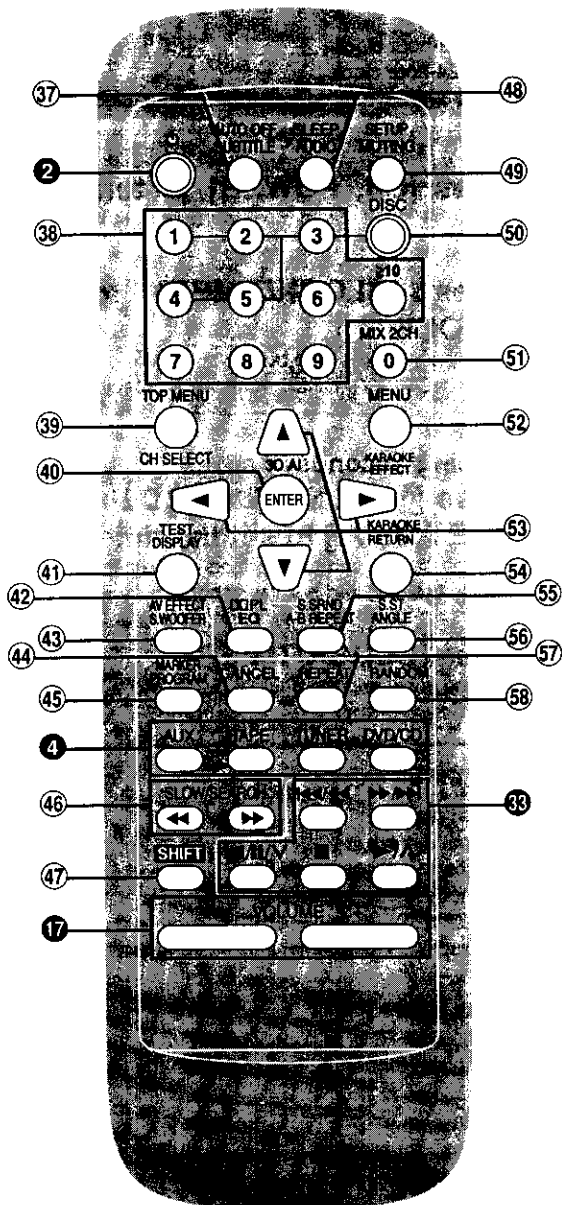

For U.S.A., Australia and New Zealand

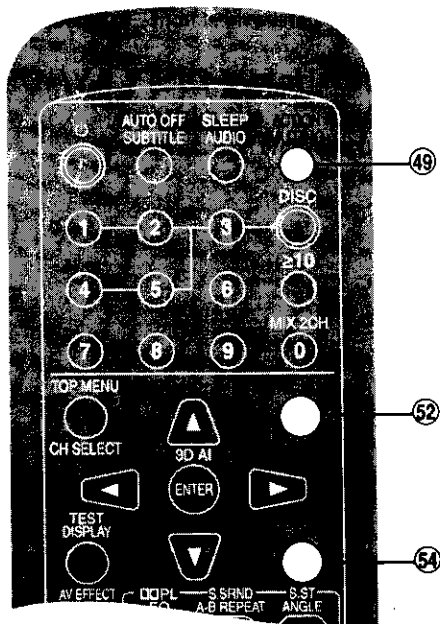

37	Subtitle button (SUBTITLE)	21
38-51	Numbered buttons (0-9, ≥10)	15, 23, 30
39	Top menu button (TOP MENU)	22
40	Enter button (ENTER)	14, 22
41	GUI select button (DISPLAY)	26
42	EQ select button (EQ)	33
43	Super woofer button (S.WOOFER)	35
44	Cancel button (CANCEL)	20, 23, 26
45	Program button (PROGRAM)	23
46	Disc slow/search button (SLOW/SEARCH ◀▶)	17, 18
47	Shift button (SHIFT)	See below.
48	Audio button (AUDIO)	21
49	Muting button (MUTING)	51
50	Disc button (DISC)	23
52	Menu button (MENU)	22
53	Cursor buttons (◀, ▶, ▲, ▼)	14, 18, 38
54	Return button (RETURN)	14, 15, 26
55	A-B repeat button (A-B REPEAT)	19
56	Angle button (ANGLE)	22
57	Repeat button (REPEAT)	19
58	Random button (RANDOM)	24

To operate functions labeled in orange, press [SHIFT] and the corresponding button at the same time.

37	Auto power-off button (AUTO OFF)	13
39	Channel select button (CH SELECT)	38
40	3D AI EQ button (3D AI)	34
41	Test signal button (TEST)	38
42	DOLBY PRO LOGIC button (DOLPL)	39
43	AV effect button (AV EFFECT)	41
45	Marker button (MARKER)	20
48	Sleep button (SLEEP)	50
49	Initial settings button	

For U.S.A., Australia and New Zealand

(ACTION)	14
----------	----

For others

(SETUP)	14
---------	----

51	2 channel down-mixing button (MIX 2CH)	38
----	--	----

Except for U.S.A., Australia and New Zealand

52	Karaoke effect button (KARAOKE EFFECT)	47
54	Karaoke mode select button (KARAOKE)	45

55	Super surround button (S.SRND)	40
56	Simulated stereo button (S.ST)	40

Setting the time

For U.S.A.: 12-hour clock

For others: 24-hour clock

The example shows how to set the 12-hour clock for 4:25 p.m. (16:25).

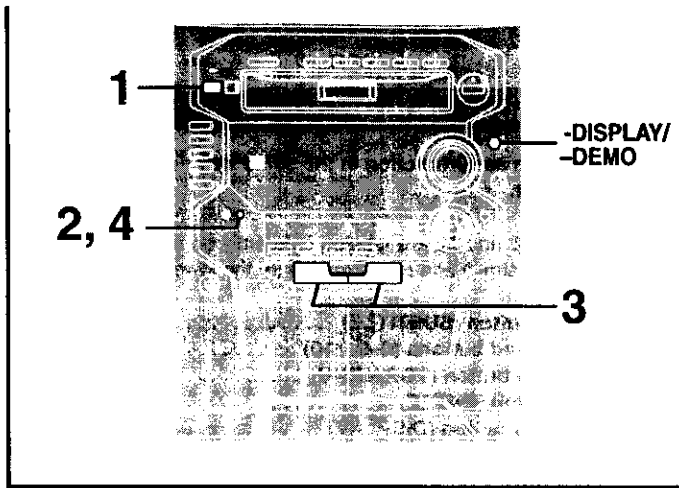

Before use

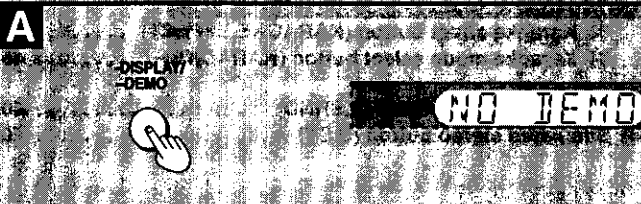
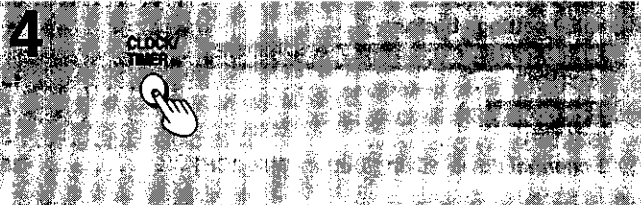
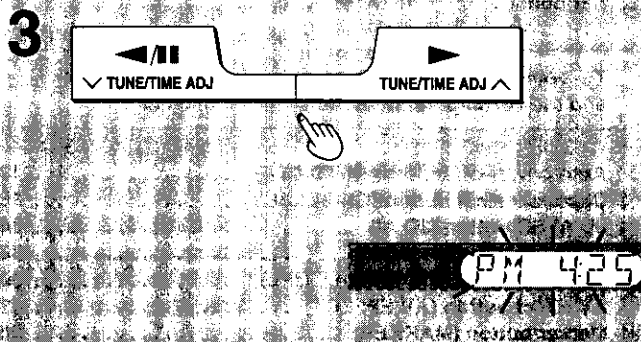
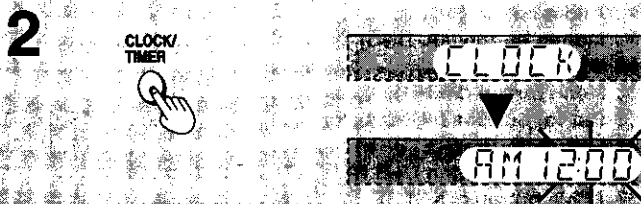
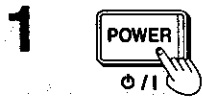

1 Press [**⏻**, POWER] to turn the unit on.

2 Press [**CLOCK/TIMER**] to display "CLOCK".

Each time you press the button:
CLOCK → **⏻**PLAY → **⏻**REC → Original display

3 (Within 5 seconds or so) Press [**∇** TUNE/TIME ADJ] or [TUNE/TIME ADJ **∧**] to set the time.

The time display can be changed in one minute units by tapping the buttons, and quickly by holding down the buttons.

4 Press [**CLOCK/TIMER**].
The time is set and the original display is restored.

Displaying the clock

When the unit is off

When ECO mode is off;

The clock is displayed constantly.

When ECO mode is on;

Press [**-DISPLAY/-DEMO**].

The clock is displayed for about 5 seconds and then the display goes blank again.

When the unit is on

Press [**CLOCK/TIMER**] to display "CLOCK".

The clock is shown for about 5 seconds then the previous display is restored.

A Turning DEMO off

A demonstration of the display is shown if you have not set the clock. Turn DEMO off to get the most from ECO mode.

Press and hold [-DISPLAY/-DEMO**] until "NO DEMO" is displayed.**

Each time you press and hold the button:

NO DEMO (off) ↔ DEMO (on)

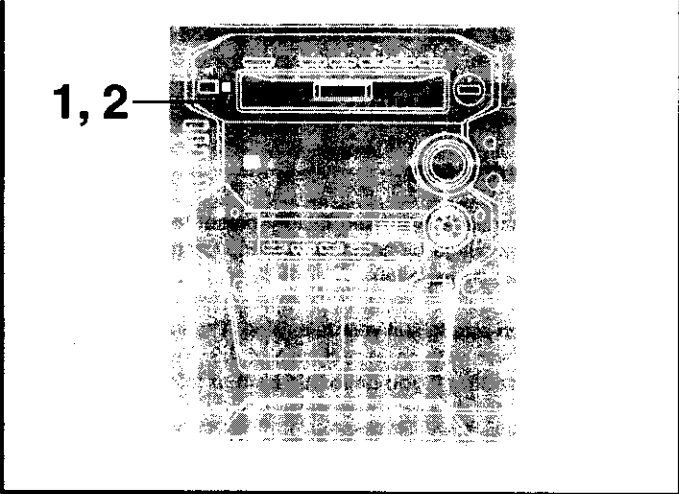

Saving power in the standby mode

Set the unit to reduce energy consumption in the standby mode.

While the unit is on:

- 1 Press [MODE].**
The current mode is displayed.
- 2 Within 2 seconds Press [MODE] to display "ECO".**
Each time you press the button:
ECO (on) ↔ NORMAL (off)

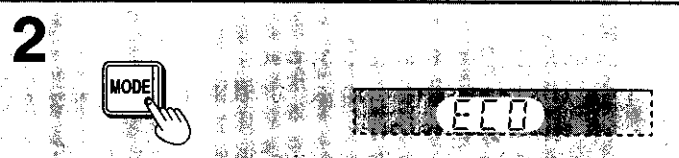
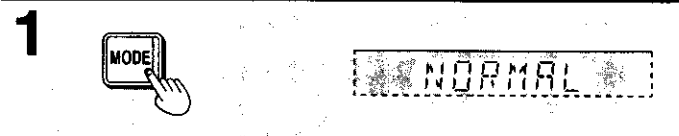

ECO: The clock is not displayed in the standby mode. The standby indicator and [⊙PLAY/⊙REC] indicator (only when the timers are set) still light.

Note

- The demonstration is shown if DEMO is on, even if ECO is on. Turn DEMO off if ECO is used.
- The mode can be switched to ECO when the unit is in standby but it cannot be switched back to NORMAL.

Conserving power

The unit consumes power* even when it is turned off with [⊙/], [POWER] and ECO mode is turned on. To save power when the unit is not to be used for a long time, unplug it from the household AC outlet. Remember to reset the radio stations and any other memory items before using the unit again.

	NORMAL	ECO
For U.S.A.	14.5 W	*0.25 W
For Australia and New Zealand	15.0 W	*0.4 W
For others	15.0 W	*0.8 W

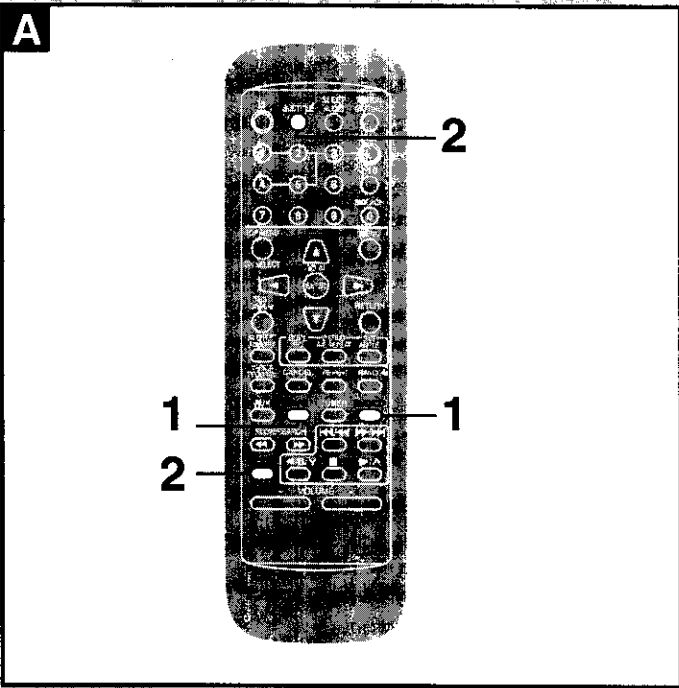

A Auto power off

Remote control only

When disc or tape is selected as the source
To save power, the unit turns off if it is left unused for 4 minutes.

This function does not work if the source is tuner or AUX or if a disc menu is being displayed.

- 1 Select disc or tape as the source.**
Press [DVD/CD] to select disc.
Press [TAPE] to select tape.
- 2 Press [SHIFT] + [AUTO OFF].**
"AUTO OFF" is displayed.



To cancel

Press [SHIFT] + [AUTO OFF] again.

For your reference

The setting is maintained even if the unit is turned off. When the unit is turned on again, the unit functions as described above. If you select tuner or AUX as the source, "AUTO OFF" goes out. It comes on again when you select disc or tape.

Screen settings

Remote control only

The menu language has been factory preset to English. You can change the language by going to "3 Menu Language" of the initial settings screen (→ page 54).

Set the screen size to suit your television. The initial setting is for a regular television with an aspect ratio of 4:3. **You do not have to change the setting if you have this kind of television.**

Preparation:

- Turn the television on.
- Switch the video input mode of the television to suit the type of connection you have made (e.g., VIDEO 1).

1 Press [DVD/CD] to select disc as the source.
The unit comes on automatically.

2 While the disc is stopped Display the initial settings screen on the television.

For U.S.A., Australia and New Zealand
Press [SHIFT] + [ACTION].

For others
Press [SHIFT] + [SETUP].

3 Press the cursor buttons, [▲] or [▼] to highlight "5 TV Aspect", and press [ENTER].

4 Press the cursor buttons, [▲] or [▼] to highlight the required size, and press [ENTER].

4:3: Regular television

16:9: Widescreen television

The initial settings screen is shown after you make your selection.

5 Press [RETURN].

Steps 3 and 4 can also be done with the numbered buttons.

Press the number next to the required item.

For example, in step 3, press [5] to select "5 TV Aspect".

Before use

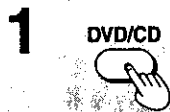
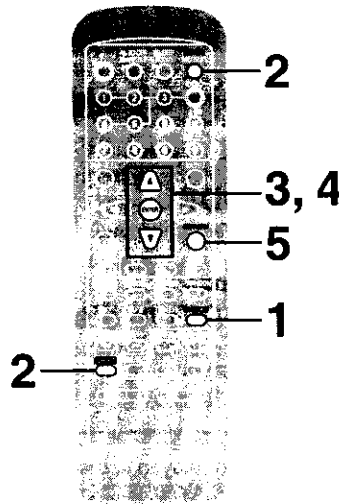

2 (For U.S.A., Australia and New Zealand)

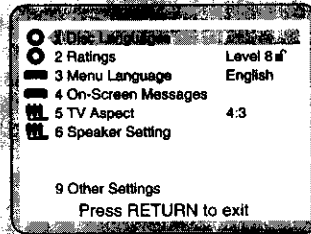
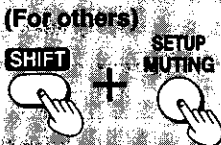

3, 4

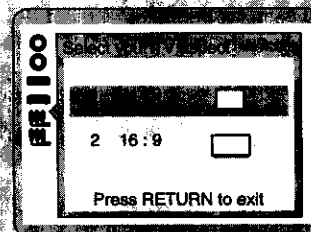

5 (For U.S.A., Australia and New Zealand)



(For others)



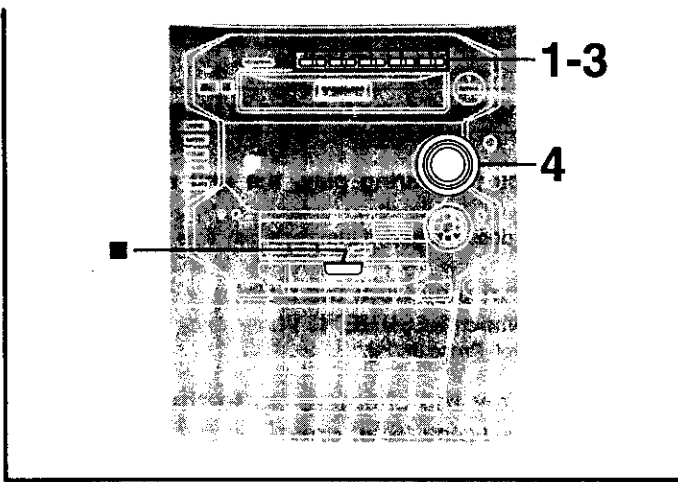

Screens illustrated are examples.

Normal play

DVD V-CD CD

Preparation:

Turn the television on and switch the video input mode on the television to suit the type of connection you have made (e.g. VIDEO 1).

- 1 Press a [▲] button to open the tray.**
The unit comes on automatically.
- 2 Set the disc on the tray and press the same [▲] button to close the tray.**

The tray closed is in the play position (its disc indicator lights). Some discs start playing automatically. Load other trays by repeating steps 1 and 2.

- 3 Press [1]–[5] to change the play position tray and start play.**
Remote control: Press [DISC] → [1]–[5].

A If a menu screen appears on the television

Remote control only

Use the cursor buttons (◀, ▶, ▲, ▼) to highlight an item and press [ENTER].

You can also select the desired item by pressing the numbered buttons with some discs.

To select title No.10 or over, press [≥10] then the two digits. e.g. Title No. 12: [≥10] → [1] → [2]

- 4 Adjust the volume.**

Use the CD MANAGER's ALL-DISC mode to play CDs and Video CDs in succession (⇒ page 25).

To stop the disc

Press [■].

Note

- With some discs, playback may start without showing the menu screen. To show the menu screen;
DVD : Press [MENU], [TOP MENU] or [RETURN] on the remote control.
Video CD : Press [RETURN] on the remote control.
- The disc continues to rotate while the menu is displayed even after a particular item has finished. When no more items are to be selected, be sure to press [■] to clear the menu display.

"⊘" is displayed on the TV

When the operation is prohibited by the unit or the disc.

"▶▶" is displayed on the unit's display

When there are 15 or more tracks on the disc (CD and Video CD without PBC).

"DVD" is displayed on the unit's display

When a DVD is in the play position tray.

"VIDEO CD" is displayed on the unit's display

When a Video CD is in the play position tray.

"NO DISC" is displayed on the unit's display

When there is no disc on the selected tray or the disc is set incorrectly.

"NO PLAY" is displayed on the unit's display

When the disc does not correspond to the unit and cannot be played.

"96kHz 24bit" is displayed on the unit's display

When the disc is one with high quality sound recorded with a sampling frequency of 96 kHz and 24 bits.

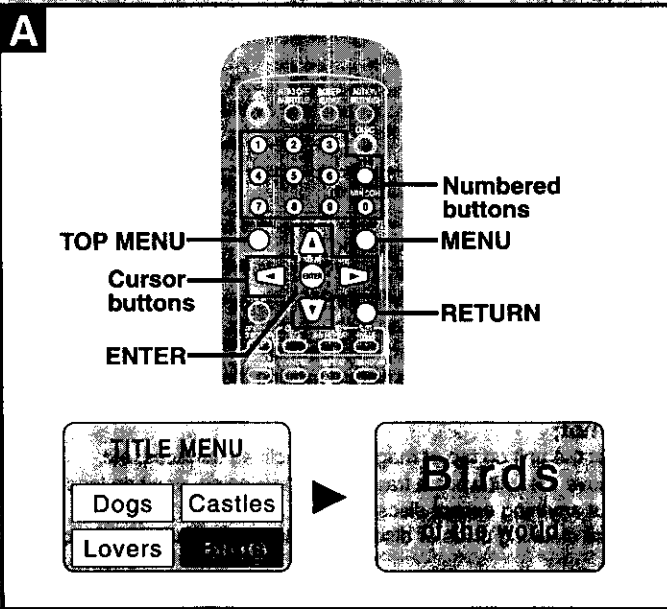
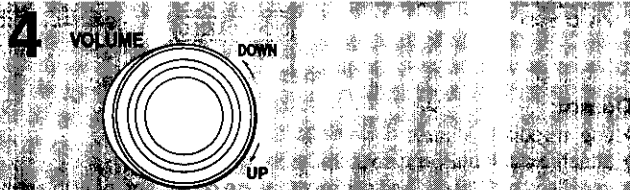
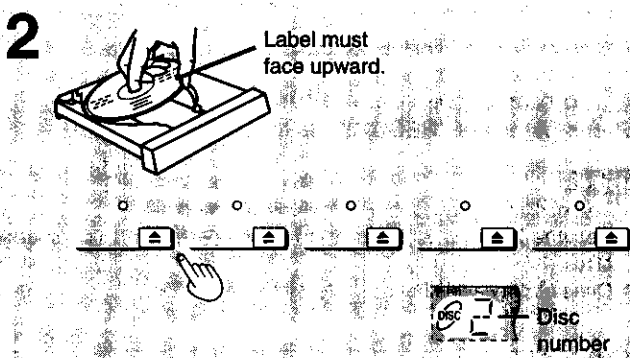
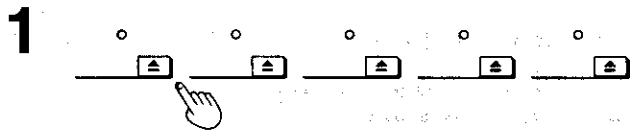

Using the resume function to restart play

If you press [■] during play, the unit remembers the position.

This function does not work if the disc's play time is not displayed.

A To restart play from the point

Press [▶] while "RESUME" is lit.

Remote control: Press [▶/∧].

B To review the chapters up to the point where you stopped play (DVD only)

The message "Press PLAY to Chapter Preview" ("Press PLAY to Chapter Review" for the Australia and New Zealand) appears for a few seconds before the resume function is activated after pressing [▶].

Press [▶] while the message is on the TV.

Remote control: Press [▶/∧].

The beginning portions of each chapter up to the current one are played.

Full play resumes from the point where you stopped play.

C To cancel the resume function

Press [■] while "RESUME" is lit.

Note

- The position is saved even if the unit is turned off.
- Resume is canceled if the disc tray is opened or if you change discs.
- Chapter preview is not possible with some DVDs.

D Disc selection

Choose discs with these marks:



Do not;

- use irregularly shaped discs (a).
- attach extra labels and stickers.
- use discs with labels and stickers that are coming off or with adhesive exuding from under labels and stickers (b).
- attach scratch-proof covers or any other kind of accessory.
- write anything on the disc.
- clean discs with liquids. (Wipe with a soft, dry cloth.)
- use discs printed with label printers available on the market.

E To prevent damage

Always observe the following points.

- Load only 1 disc per tray (c).
- Load discs as shown in figure d.
 - An adaptor is not needed with 8 cm discs (singles).
- Set the system on a flat, level surface.
- Always unload all discs before moving the unit.

Do not;

- set the unit on top of magazines, inclined surfaces, etc.
- move the unit while a tray is opening/closing, or when loaded.
- put anything except discs in trays.
- use cleaning discs or discs which are badly warped or cracked.

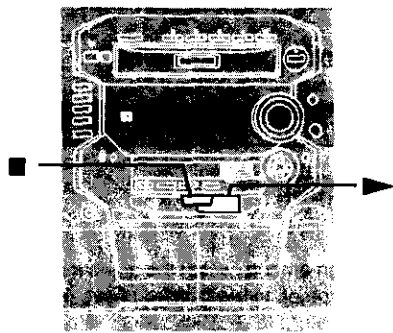

A



B



C



D

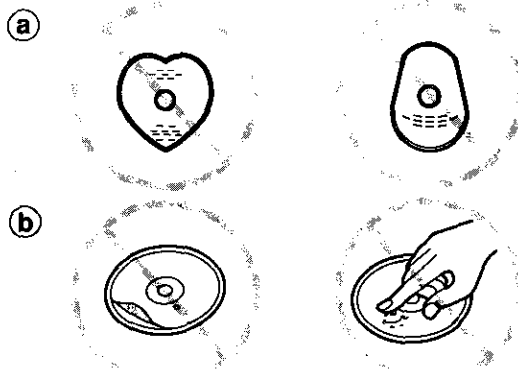

E

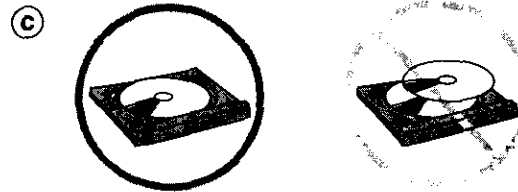

8cm disc	✓		✗	
	✓		✗	
12cm disc				

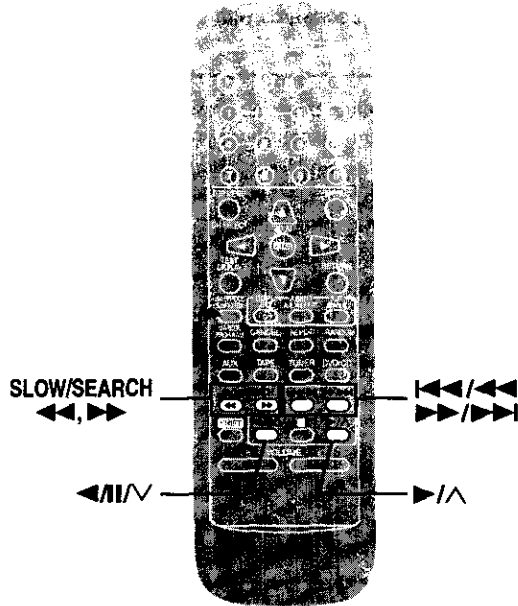
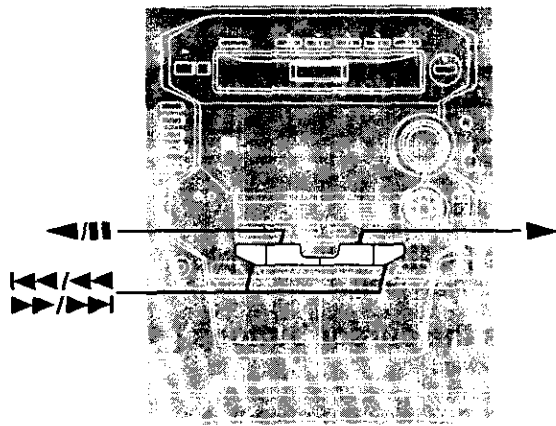

A Pause (Still picture)

DVD V-CD CD

Press [**⏸**] during play.

Remote control: Press [**⏸**].

To resume play

Press [**▶**]. (Remote control: [**▶/⏪**].)

B Skip function

DVD V-CD CD

Chapters on DVD and tracks on Video CD and CD can be skipped.

Press [**⏮**] or [**⏭**] during play.

⏮: Backward

⏭: Forward

Each press increases the number of skips.

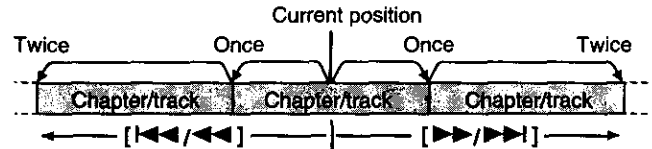

Note

- If pressed while a Video CD menu is on the screen, you may return to the previous menu.
- If pressed while playing a Video CD with PBC, you may return to a menu screen.

C Search function

DVD V-CD CD

Remote control:

Press [**SLOW/SEARCH** (**⏮** or **⏭**)] during play.

⏮: Backward

⏭: Forward

Each press increases the speed of the search. There are 5 speeds.

- If pressed while playing a Video CD with PBC, you may return to a menu screen.

To resume play

Press [**▶/⏪**]. (Main unit: Press [**▶**].)

Main unit:

Press and hold [**⏮**] or [**⏭**] during play.

Search speed cannot be changed.

Play resumes when you release the button.

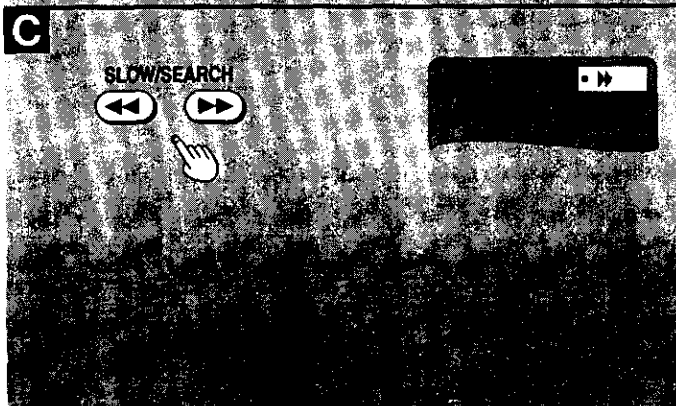
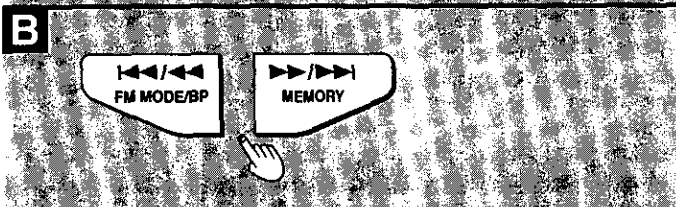
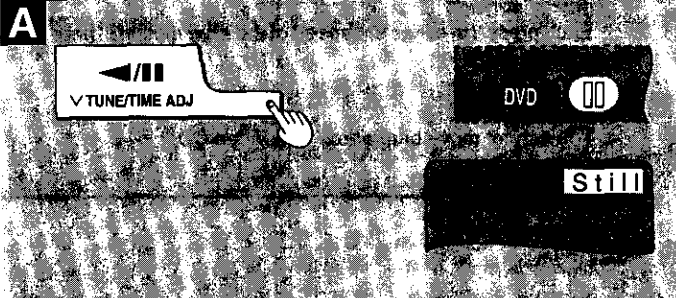

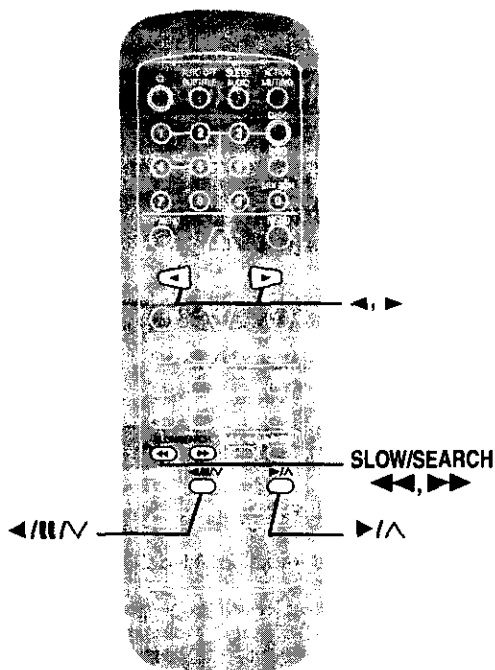

A Frame-by-frame viewing

DVD V-CD

Remote control:

- ① Press [**◀/⏮/⏭**] during play.
Main unit: Press [**◀/⏮**].
- ② Press the cursor buttons [**◀**] or [**▶**].
[**◀**]: Backward
[**▶**]: Forward
Main unit: Press joystick ([**◀**] or [**▶**]).

Note

You cannot move backwards with Video CD.

- The frame changes each time you press a cursor button.
- The frames change in succession if you press and hold a cursor button.
- The frame also advances each time you press [**◀/⏮/⏭**].

To resume play

Press [**▶/⏪**].

B Slow-motion play

DVD V-CD

Remote control only

- ① Press [**◀/⏮/⏭**] during play.
- ② Press [**SLOW/SEARCH (◀◀ or ▶▶)**].

[**◀◀**]: Backward
[**▶▶**]: Forward

Each press increases the speed of the slow motion. There are 5 speeds.

Note

You cannot move backwards with Video CD.

To resume play

Press [**▶/⏪**].

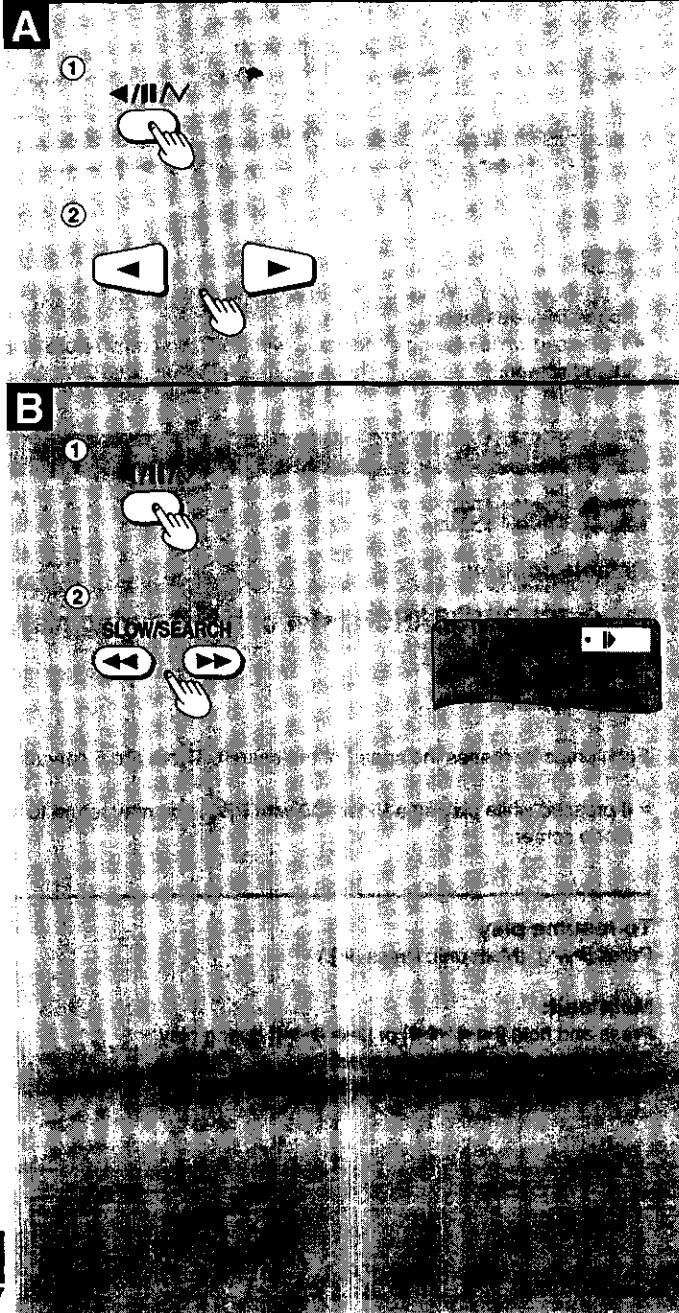

Repeat function

DVD V-CD CD

Remote control only

A Repeating chapters, titles and tracks

Press [REPEAT] during play.

Each time you press the button:

DVD

Ⓐ CHAPTER REPEAT (↺): Current chapter is repeated.

Ⓑ TITLE REPEAT (↻): Current title is repeated.

Ⓒ REPEAT OFF: Repeat mode is canceled.

Video CD, CD

↻: All tracks on the disc are repeated.

Original display: Repeat mode is canceled.

To cancel repeat play

Press [REPEAT] to clear "↻".

- When playing Video CDs and CDs, you can combine random play (⇒ page 24) or the CD MANAGER (⇒ page 25) and repeat play.

Note

Repeat play does not work if the play time for the disc is not displayed.

To repeat only your favorite tracks

Video CD and CD only

- 1 Program the tracks you want (⇒ page 23).
- 2 Press [▶/▲].
- 3 Press [REPEAT] to display "↻".

B Repeating a specific section (A-B REPEAT)

1 Press [A-B REPEAT] during play at the starting point (A).

2 Press [A-B REPEAT] at the finishing point (B).

To cancel A-B repeat play

Press [A-B REPEAT] to clear "↻".

Note

- This feature cannot be used if the play time for the DVD is not displayed.
- The player automatically determines the end of a title or track as point B.
- Subtitles may not appear around A and B.

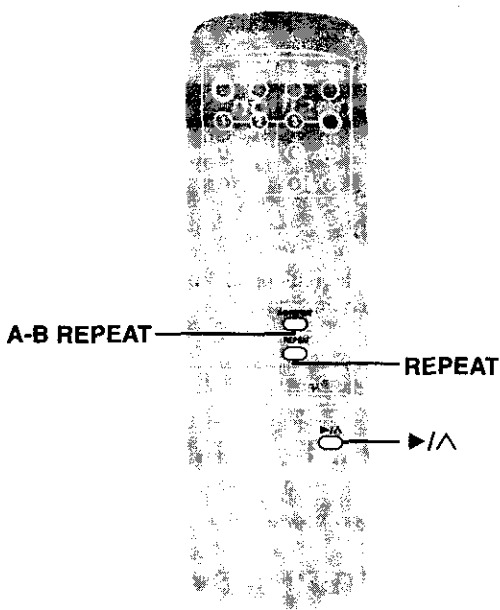

A

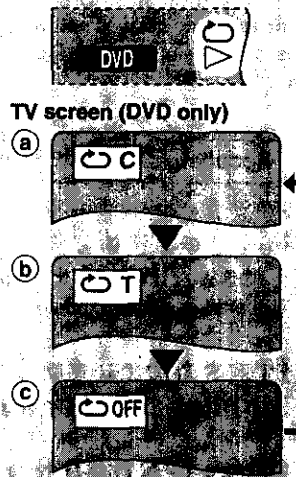

B

1

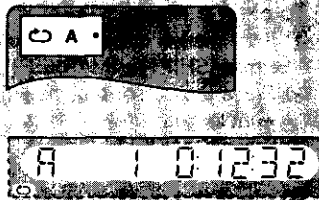

2

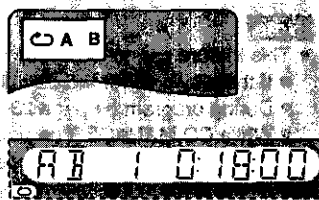

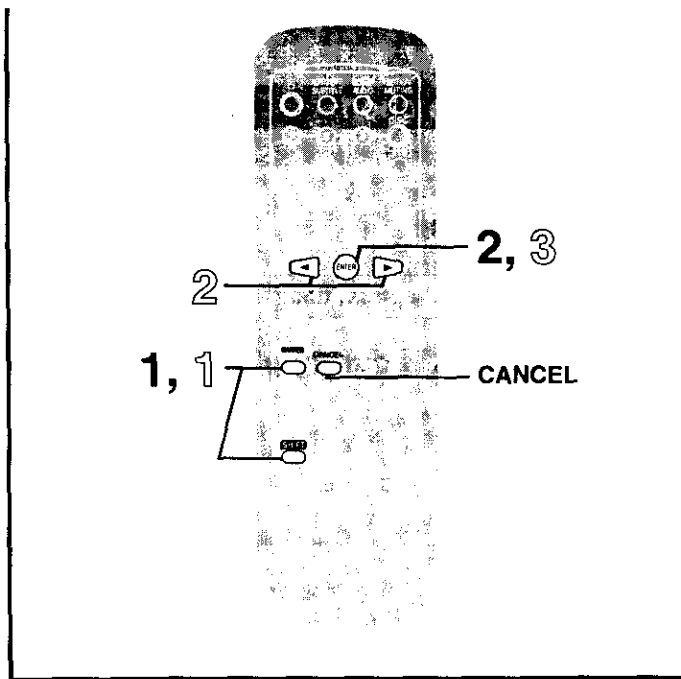

Other methods of disc play

Marking a position

DVD V-CD CD

Remote control only

This feature allows you to mark up to 5 points on a disc so you can return to them easily at a later time.

To mark a position

- 1** Press [SHIFT] + [MARKER] during play.
The marker display appears.
- 2** Press [ENTER] at the point you want to mark.

To mark another position

While the marker display is on the screen

- ① Press the cursor buttons [◀] or [▶] to select another “*”.
- ② Press [ENTER].

Recalling a marked position

- 1** If the marker display is not on the screen
Press [SHIFT] + [MARKER].
The marker display appears.
- 2** Press the cursor buttons [◀] or [▶] to highlight the required marker.
- 3** Press [ENTER] to recall the position.

To clear a marker

- ① If the marker display is not on the screen
Press [SHIFT] + [MARKER].
- ② Press the cursor buttons [◀] or [▶] to highlight the marker you want to clear.
- ③ Press [CANCEL].

To clear the marker display

Press [SHIFT] + [MARKER].

Note

- This feature cannot be used;
 - If the play time for the disc is not displayed.
 - During program (⇒ page 23) and random play (⇒ page 24).
 - While CD MANAGER (⇒ page 25) is on.
- Some subtitles may fail to appear around the marker (DVD).
- Markers clear in the following situations:
 - The unit is turned off.
 - The disc is changed or removed.
 - A source other than DVD/CD is selected.

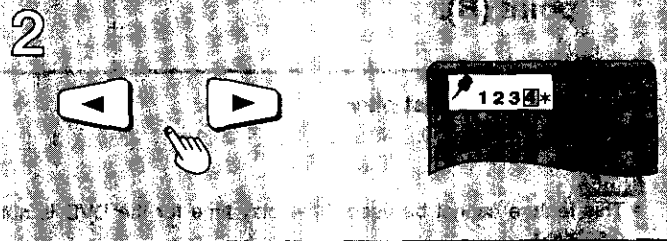
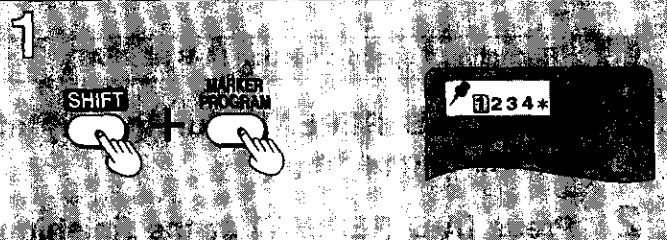
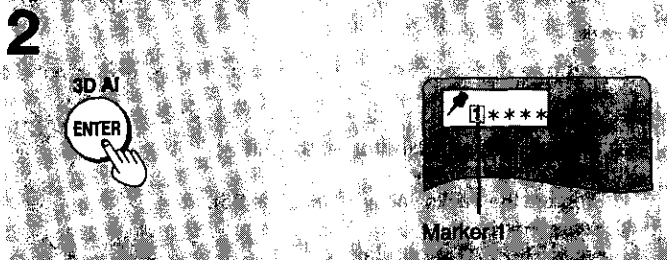
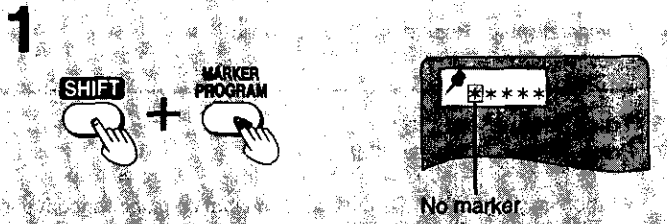

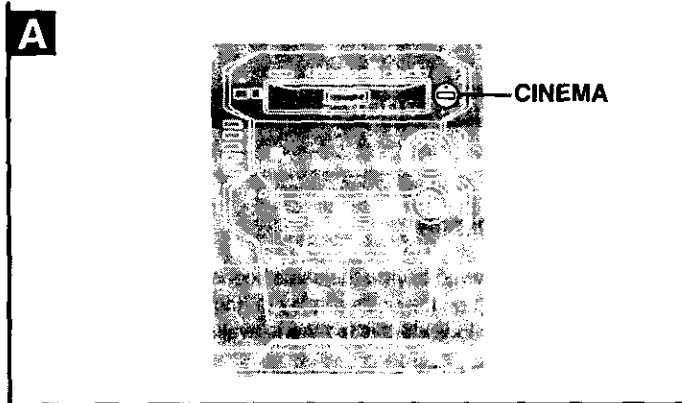

A Changing the picture quality for movie viewing

DVD V-CD

You can better enjoy pictures by changing the picture quality.

Press [CINEMA].

The [CINEMA] indicator lights and the CINEMA display appears on the screen.

Each time you press the button:
C (CINEMA is on) ↔ N (CINEMA is off)

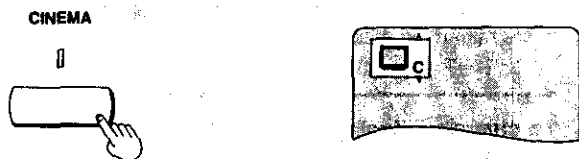

To cancel

Press [CINEMA] to display "N".

B Changing soundtrack and subtitle languages

DVD

Remote control only

Some DVDs have multiple soundtracks and subtitle languages recorded on them. You can change these during play.

To change the soundtrack

Press [AUDIO] during play.

The soundtrack display appears.

The number changes each time you press the button.

To change the subtitle language

Press [SUBTITLE] during play.

The subtitle display appears.

The number changes each time you press the button.

The number can also be changed with the cursor buttons ([▲] or [▼]) or the numbered buttons.

See the bottom of page 28 for a key to language abbreviations.

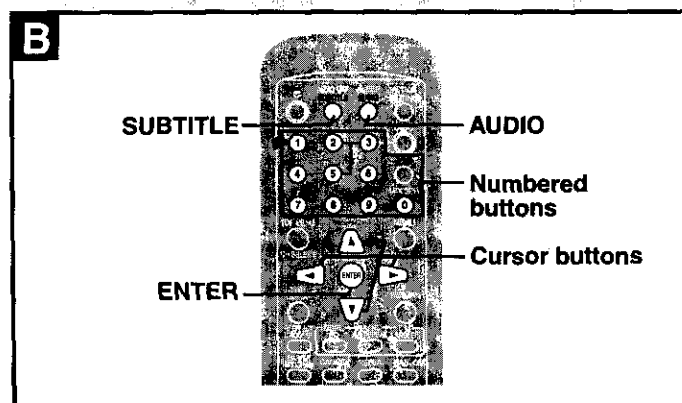

To change the soundtrack

SLEEP
AUDIO



Soundtrack number



To change the subtitle language

AUTO OFF
SUBTITLE



Subtitle number



To turn the subtitles on/off

- ① Press [SUBTITLE] to display the subtitle display.
- ② Press the cursor buttons ([◀] or [▶]).

To clear the display

Press [ENTER].

For your reference

Soundtrack and subtitle languages can be set before play with the initial settings (⇒ "1 Disc Languages", page 54).

(Some discs are designed to start in a certain language despite the initial setting.)

You can only select the languages recorded on the disc.

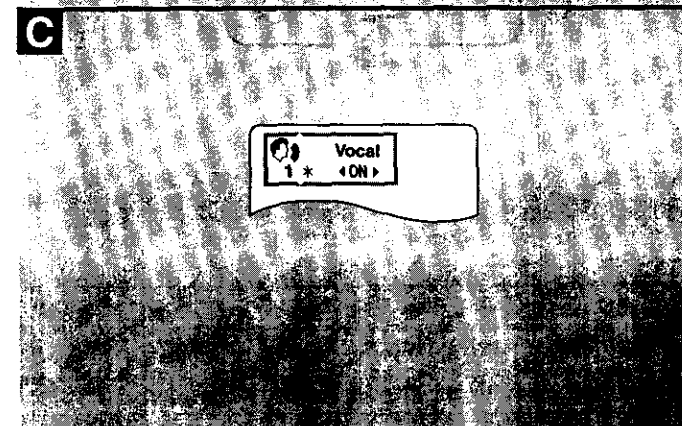

C Switching vocals on/off for karaoke discs

- ① Press [AUDIO] during play.
- ② Press the cursor buttons ([◀], [▶]) or [AUDIO] to change the setting.

- Solo
- : No vocal
- ON: Vocal
- Duet
- : No vocal
- 1+2: Vocal 1 and 2
- V1: Vocal 1
- V2: Vocal 2

Choose "---" for karaoke.

Choose "V1" or "V2" to duet with the player.

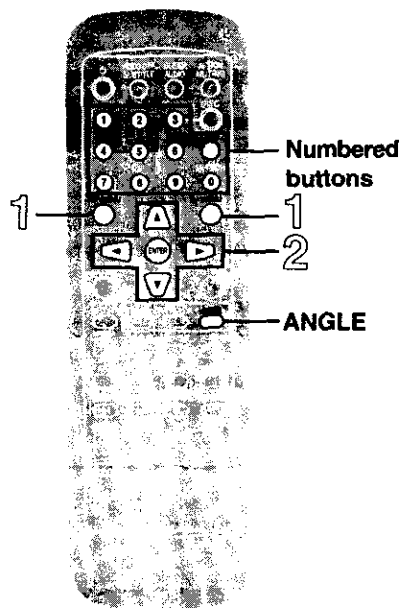

A

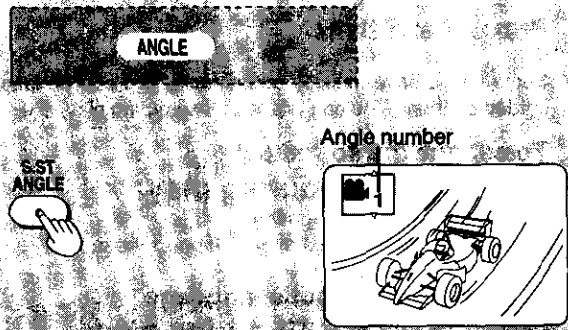

B

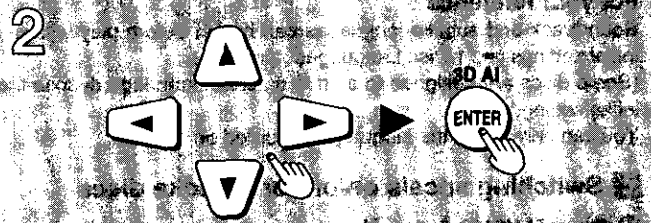
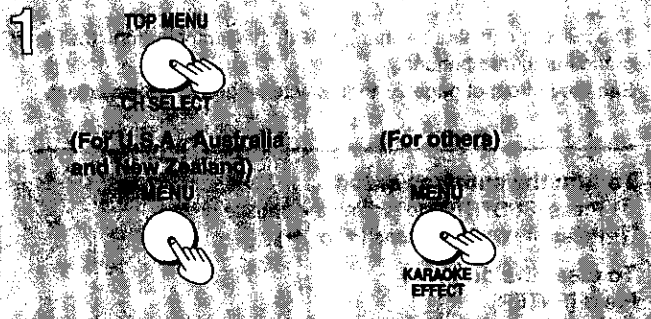

Other methods of disc play

A Switching angles

DVD

Remote control only

Some DVDs allow you to view the same scene from different angles. "ANGLE" lights up on the unit's display during scenes recorded with multiple angles to indicate this feature is available.

Press [ANGLE] during play.

The angle display appears. The angle number changes each time you press the button. The number can also be changed with the cursor buttons ([▲] or [▼]) or the numbered buttons.

To clear the display

Press [ENTER].

B Using menus to play

DVD

Remote control only

By calling up menus during play, you can start play from a specific title or chapter. Menu content depends on the disc. These operating instructions describe the basic steps.

1 Press [TOP MENU] or [MENU].

A menu screen is displayed. (Press again to return to what you were watching with some discs.)

2 Select an item with the cursor buttons ([◀], [▶], [▲], [▼]) and press [ENTER] to confirm the selection.

You can select items with the numbered buttons with some discs. Repeat if another menu is shown.

DVDs can have several menus. The menu displayed by pressing [TOP MENU] may be different to the menu displayed by pressing [MENU].

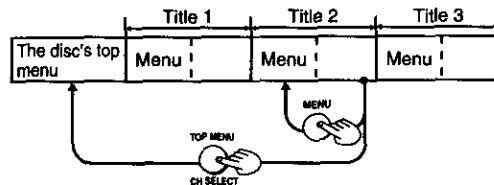

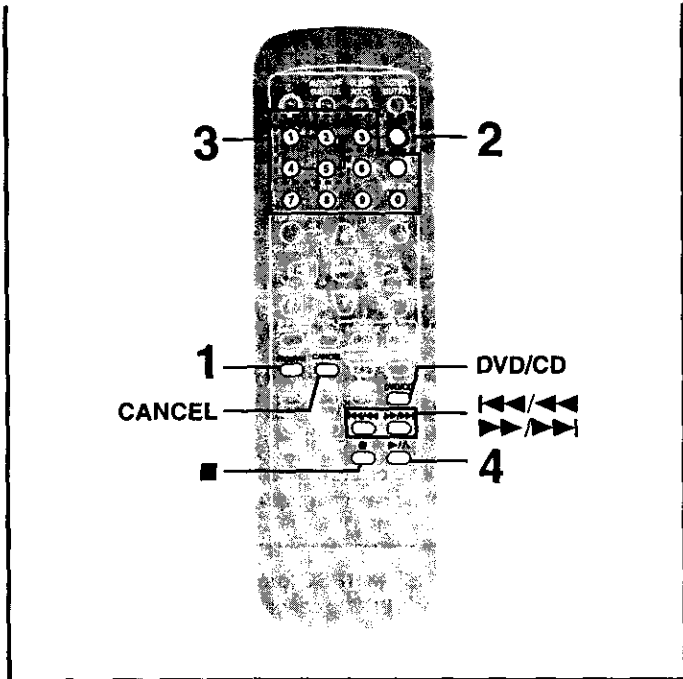

Program play

V-CD **CD**

Remote control only

You can select up to 24 tracks to play in the order you choose.

Preparation:

- Press [DVD/CD] to select disc as the source.
- Ensure a Video CD or CD is in the play position tray.
(Program play is not possible if the play position tray contains a DVD or is empty.)

- 1 While stopped**
Press [PROGRAM].
- 2 Press [DISC] and (within 10 seconds) [1]–[5]**
to select the disc.
- 3 Select the track with the numbered buttons.**
To select tracks numbered 10 and over
Press [≥10] then the two digits.

Repeat steps 2 and 3 to program all tracks you want in the required order.

- 4 Press [▶/▲].**
All the tracks are played in the selected order.

Step 2 is not necessary when selecting a track from the disc currently displayed.

To exit program mode

Press [PROGRAM] while stopped.
Program contents will be saved in the memory.

You can do the following while the disc is stopped

Press [■] to cancel the resume function if it is on.

• **To check program contents**

While "P" is displayed (A)
Press [◀◀/▶▶] or [▶▶/▶▶].
Each time you press a button, the disc number, track number and program order are displayed.

• **To add to the program**

Repeat steps 2 and 3.

• **To cancel tracks**

From the last programmed track	Press [CANCEL].
A particular track	While "P" is displayed Select the track with [◀◀/▶▶] or [▶▶/▶▶] then press [CANCEL].
All tracks	Press [■]. "CLEAR" is displayed.

When "CD FULL" is displayed

24 tracks have been programmed. No further tracks can be programmed.

Note

- Discs and tracks the unit cannot find can be programmed but are canceled during play. This is also the case if you program a DVD.
- You can program individual tracks even if the disc is a Video CD with PBC.
- Skipping is done in the programmed order.

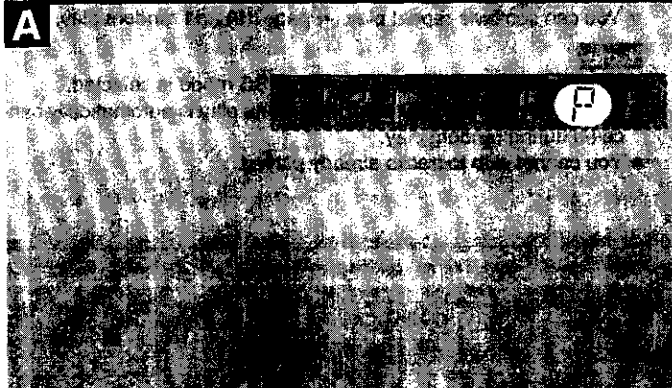
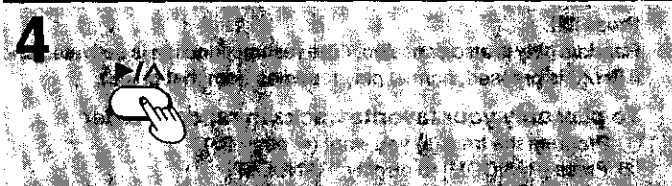
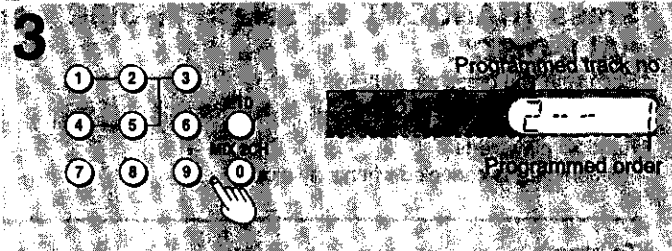
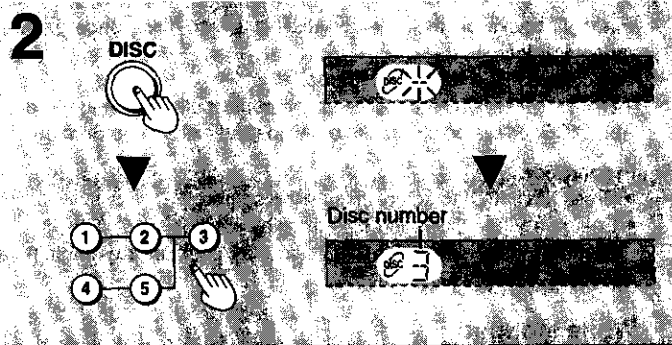

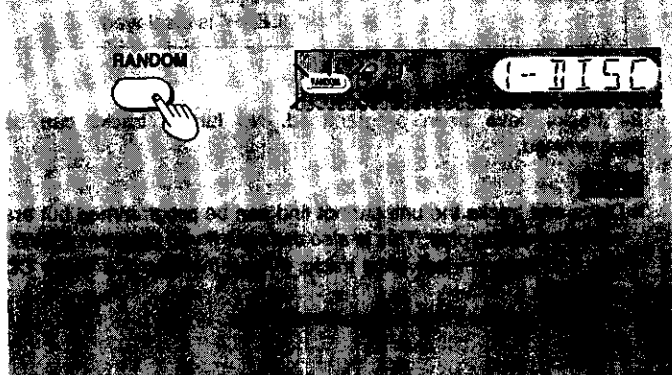
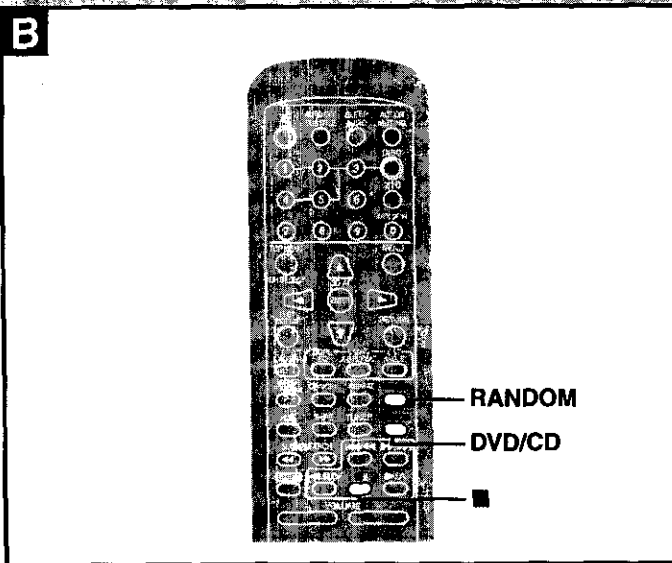
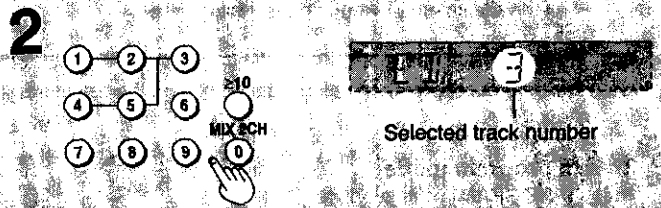
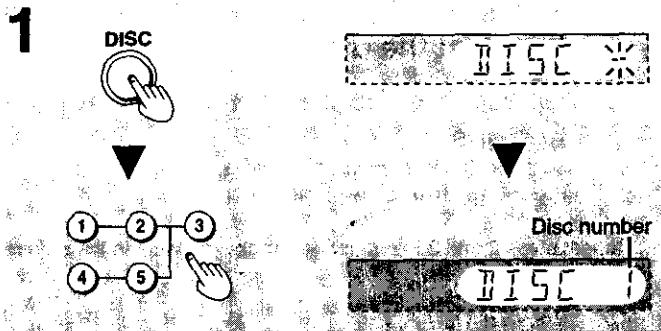
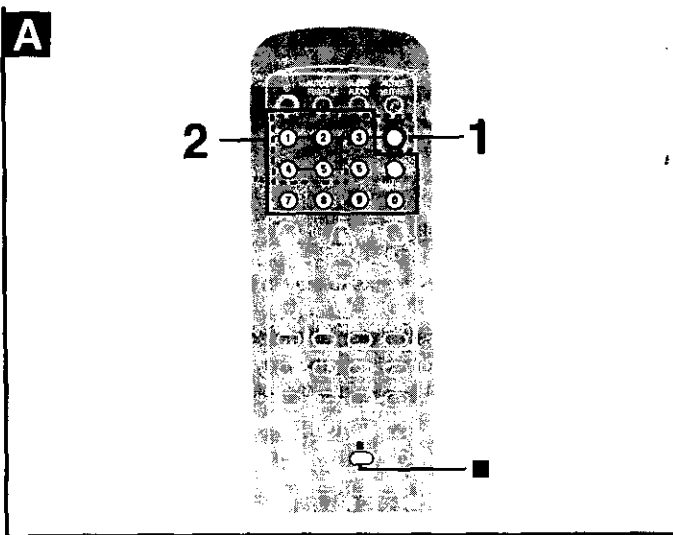

Other methods of disc play

A Starting play from a specific track

V-CD CD

Remote control only

- 1** Press [DISC] and (within 10 seconds) [1]–[5] to select the disc.
- 2** After the first track starts playing Select the track with the numbered buttons.
To select a track 10 or over, press [≥ 10] then the two digits. Play starts from the selected track.

- When playing Video CDs with PBC, press [■] to stop the disc, then select the track number. PBC is canceled. This does not work with some Video CDs with PBC.

B Random play

V-CD CD

Remote control only

Plays all tracks on the selected disc or on all discs once each in random order.

Select one of two ways to play tracks.

- 1-DISC: Plays all the tracks on the current disc in random order.
- ALL-DISC: Plays all the tracks on all loaded discs in random order.

Preparation:

- Press [DVD/CD] to select disc as the source.
- Ensure a Video CD or CD is in the play position tray. (Random play is not possible if the play position tray contains a DVD or is empty.)

While stopped

Press [RANDOM] to select "1-DISC" or "ALL-DISC".

Each time you press the button:

1-DISC ↔ ALL-DISC

Random play starts.

Random play is canceled when play stops.

To stop

Press [■].

Random play is also canceled. (The resume function is activated and if [▶/⏪] is pressed, normal play resumes from that point.)

To play only your favorite tracks in random order

- ① Program the track(s) you want (⇒ page 23).
- ② Press [RANDOM] to display "RANDOM".

- You can combine repeat play (⇒ page 19) and random play.

Note

- This function skips DVD when ALL-DISC mode is selected.
- If the disc is a Video CD with PBC, menu play is automatically canceled during random play.
- You cannot skip to tracks already played.

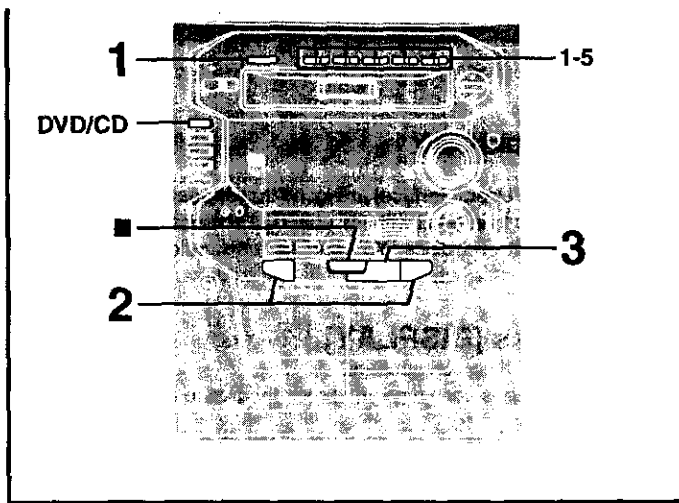

Using the CD MANAGER

V-CD CD

Use this function to select specific discs and tracks to play. There are 3 modes

1-track mode: Plays one selected track on the current disc.

1-disc mode: Plays the current disc.

All-disc mode: Plays all loaded discs in succession from the current disc to the final disc*.

These modes make recording CDs easier (⇒ page 43).

Preparation:

- Press [DVD/CD] to select disc as the source.
- Ensure a Video CD or CD is in the play position tray. (You cannot use CD MANAGER if the play position tray contains a DVD or is empty.)



- 1 While stopped
Press [CD MANAGER] to select the desired mode.

Each time you press the button:

1-TRACK → 1-DISC → ALL-DISC → NORMAL

1-TRACK: 1-track mode

1-DISC: 1-disc mode

ALL-DISC: All-disc mode

NORMAL: The function is canceled.

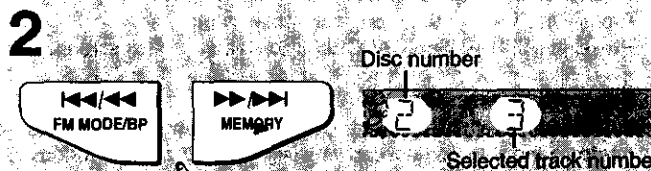

You can choose the disc after step 1.

Press [1]–[5] on the main unit to select the disc.

Remote control: Press [DISC] then (within 10 seconds) [1]–[5].



- 2 Only when you selected "1-TRACK" in step 1
Press [◀◀/▶▶] or [▶▶/▶▶] to select the track.

Remote control: Select with the numbered button(s).

To select a track 10 or over, press [≥10] then the two digits.

- 3 Press [▶] to start play.

Remote control: Press [▶/▲].

The CD MANAGER is canceled after play finishes.

To stop

Press [■].

The CD MANAGER is canceled.

(The resume function is activated and if [▶] is pressed, normal play resumes from that point.)

*"Final disc"

For example, if play starts from disc 4, disc 3 will be the "final disc".

Order of progression: Disc 4 → 5 → 1 → 2 → 3

- You can use the CD MANAGER with repeat play.

① Do steps 1–3 above.

② Press [REPEAT] on the remote control to display "↺".

Note

- If the disc is a Video CD with PBC, the PBC function is automatically canceled when you select modes other than NORMAL.

- This function skips DVD.

DVD

Remote control only

GUI (Graphic User Interface) are icons that appear on the TV screen that allow you to interact with the unit. GUI screens show information about the unit and discs. You can perform various operations by changing the information shown in these screens.

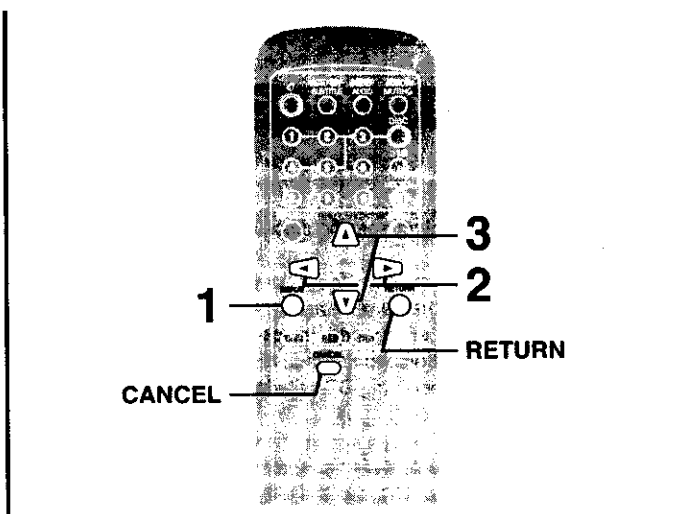

1 Press [DISPLAY].

The GUI screen appears.
It changes each time you press the button (see below).

2 Press the cursor buttons [◀] or [▶] to select an item.

3 Press the cursor buttons [▲] or [▼] to change the setting.

To clear the GUI screen

Press [DISPLAY] until the original display is restored.
Pressing [RETURN] or [CANCEL] also clears the GUI screen.

For your reference

- Some items require different operations to change the contents, so refer to the GUI icon descriptions (⇒ pages 27 and 28) for details.
- The GUI screens disappear after performing some operations, such as changing the title or chapter.
- If the GUI screen is partially cut off or fails to appear, change the position with the initial settings, "4 On-Screen Messages" (⇒ page 54).

A Type of GUI screens

There are 3 different GUI screens.

- Disc GUI:** You can change the title or chapter, or change the position by specifying the time. You can also switch soundtrack, subtitles and angles.
- Unit GUI:** You can start repeat play or mark a position and recall it. You can also turn the CINEMA mode on/off.
- Shuttle GUI:** You can fast forward, go backward or start slow-motion play.

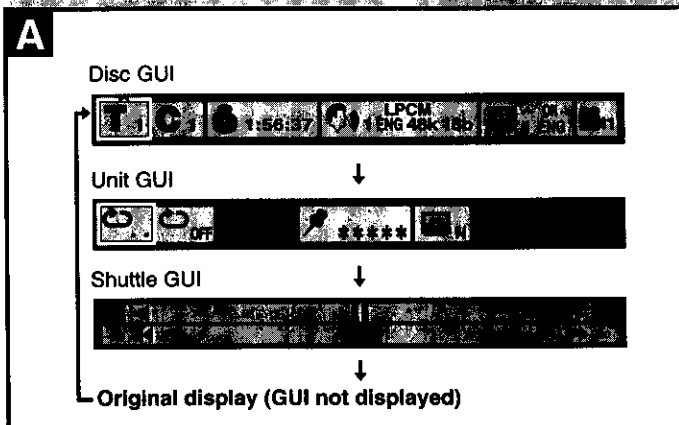
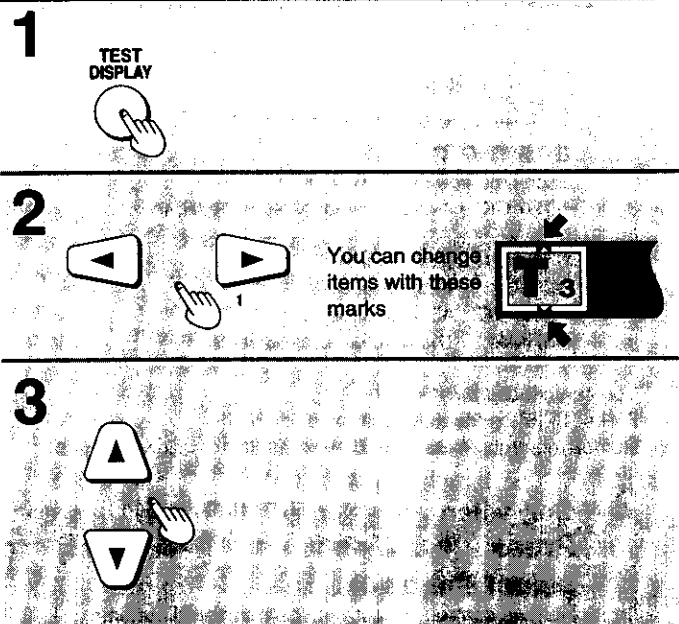

Disc operations

GUI icon descriptions

Disc GUI

Icon	Content	Operation
	Title number	Press [▲] or [▼] or the numbered buttons to change the number and press [ENTER].
	Chapter number	Press [▲] or [▼] or the numbered buttons to change the number and press [ENTER].
	Time (select a position to start play by specifying a time)	Press the numbered buttons and press [ENTER].
	<p>a) Soundtrack number See the bottom of page 28 for a key to language abbreviations.</p>	Press [▲] or [▼] or the numbered buttons to change the number.
	<p>b) Type of audio signal</p> <ul style="list-style-type: none"> • LPCM (linear PCM), Digital (Dolby Digital) <p>c) Sampling rate or number of channels</p> <ul style="list-style-type: none"> • LPCM: 48 kHz or 96 kHz • Digital: 1 to 5.1 channels* <p>d) Number of bits</p> <ul style="list-style-type: none"> • LPCM: 16, 20 or 24 bits 	---
	<p>e) Vocals on or off</p> <p>Solo karaoke disc: --- or ON</p> <p>Duet karaoke disc: ---, V1 + V2, V1 or V2</p>	DVD karaoke only Press [▲] or [▼].
	<p>f) Subtitle number See the bottom of page 28 for a key to language abbreviations.</p>	Press [▲] or [▼] or the numbered buttons to change the number.
	<p>g) Subtitles on or off</p>	Press [▲] or [▼].
	Angle number	Press [▲] or [▼] or the numbered buttons to change the number.

• Some discs will not allow some of these operations.

* The number of channels recorded on the disc

Example:

3/2.1ch

.1: Subwoofer signal (not displayed if there is no subwoofer signal)
0: No surround 1: Mono surround 2: Stereo surround (left/right)
1: Center 2: Front left + Front right 3: Front left + Front right + Center

Unit GUI screen

Icon	Content	Operation
	Start and finish points for A-B repeat.	Press [ENTER] at the start point and press again at the finish point. Press [ENTER] to cancel A-B repeat.
	Select a repeat play mode: C (chapter), T (title), OFF	Press [▲] or [▼].
First press [ENTER] to select the icon. 	Mark a position	Press [ENTER].
	Recall a mark	Press [◀] or [▶] to select the mark and press [ENTER] to recall the position.
	Erase a mark	Press [◀] or [▶] to select the mark and press [CANCEL].
	CINEMA mode on (C) or off (N).	Press [▲] or [▼].

Disc operations

Shuttle GUI

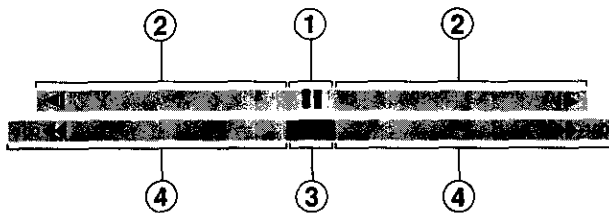

5 levels of speed can be selected in either direction.

Content	Operation
① Pause	Press [▲].
② Slow-motion play ◀ : Backward ▶ : Forward	Press [▲] to pause and press [◀] or [▶].
③ Play	Press [▼].
④ Search ◀◀ : Backward ▶▶ : Forward The numbers indicate the maximum speed.	Press [◀] or [▶].

Language abbreviations

ENG	English	POR	Portuguese	FRA	French	RUS	Russian	DEU	German	JPN	Japanese
ITA	Italian	CHI	Chinese	ESP	Spanish	KOR	Korean	NLD	Dutch	MAL	Malay
SVE	Swedish	VIE	Vietnamese	NOR	Norwegian	THA	Thai	DAN	Danish	*	Others

The radio: manual tuning

Radio stations can be tuned manually by selecting the station's frequency or they can be preset into channels to make it easy to tune (→ page 30).

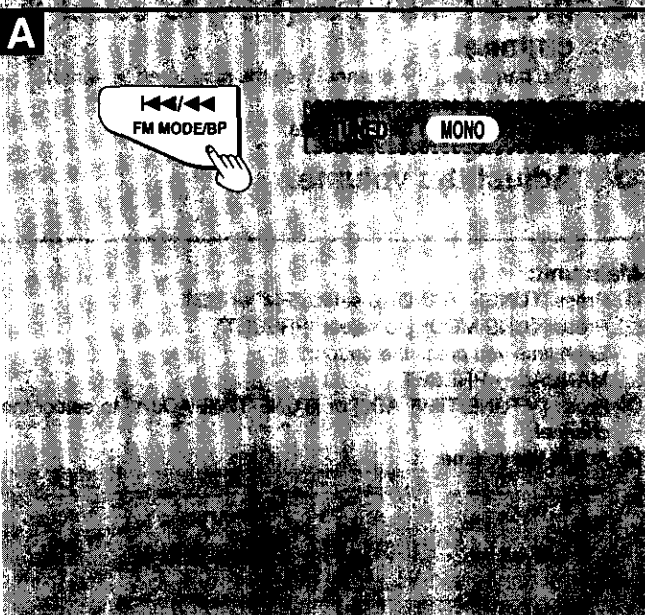
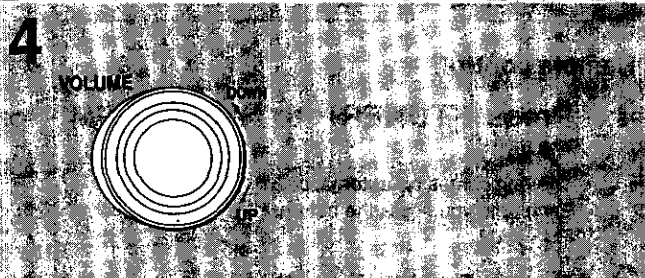
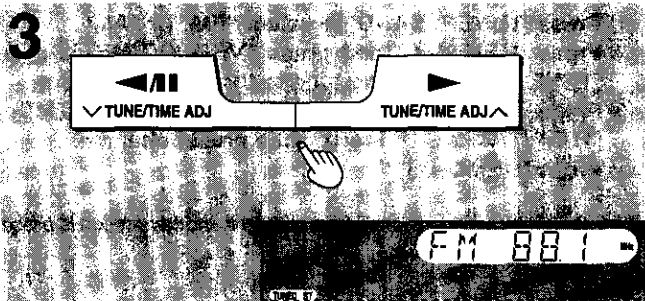
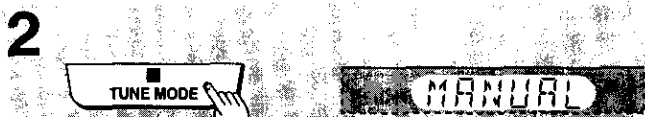
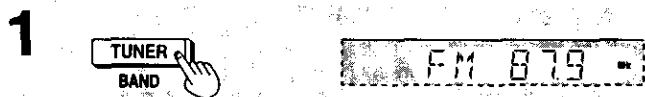
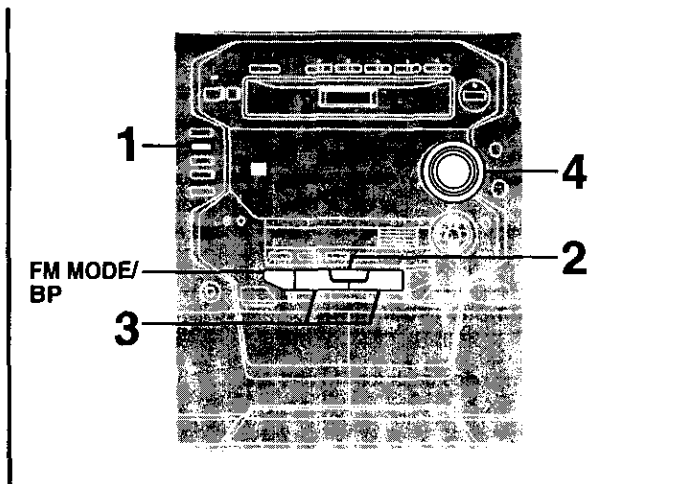

1 Press [TUNER, BAND] to select "FM" or "AM".

The unit comes on automatically.
Each time you press the button:
FM ↔ AM

2 Press [TUNE MODE] to select "MANUAL".

Each time you press the button:
MANUAL ↔ PRESET

3 Press [VTUNE/TIME ADJ] or [TUNE/TIME ADJ^] to select the frequency of the required station.

If you press and hold [VTUNE/TIME ADJ] or [TUNE/TIME ADJ^] for a moment, the frequency starts changing automatically and stops when a station is found. It may also stop if there is outside interference. Press and hold [VTUNE/TIME ADJ] or [TUNE/TIME ADJ^] again to restart. You can also stop the frequency changing by pressing [VTUNE/TIME ADJ] or [TUNE/TIME ADJ^].

"TUNED" is displayed when a radio station is tuned.
"ST" is displayed when a stereo FM broadcast is being received.

4 Adjust the volume.

A If noise is excessive in FM

Press [FM MODE/BP] to display "MONO".

This mode improves sound quality if reception is weak but broadcasts are heard in monaural.
Press [FM MODE/BP] again to cancel the mode.

Leave "MONO" off for normal listening.
Stereo and monaural broadcasts are automatically played as they are received.

Allocation settings

Each country allocates broadcast bands according to their particular system.

For U.S.A. (FM: 0.2 MHz ↔ 0.1 MHz):
This unit can receive FM broadcasts allocated in 0.1 MHz steps.
For others except Australia and New Zealand (AM: 9 kHz ↔ 10 kHz):
This unit can receive AM broadcasts allocated in 10 kHz steps.

To change the step

- ① Press and hold [TUNER, BAND].
After a few seconds the display changes to a flashing display of the current minimum frequency.
- ② Continue to hold [TUNER, BAND] down.
When the minimum frequency changes, release the button.
To return to the original step, repeat the above steps.

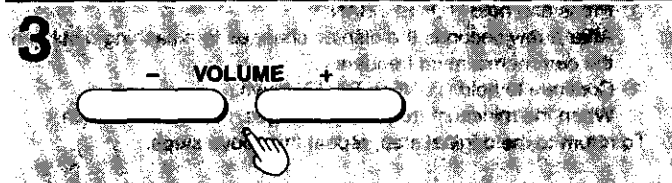
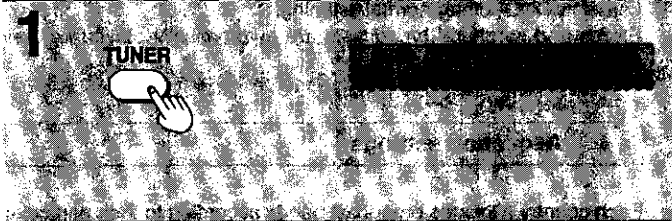
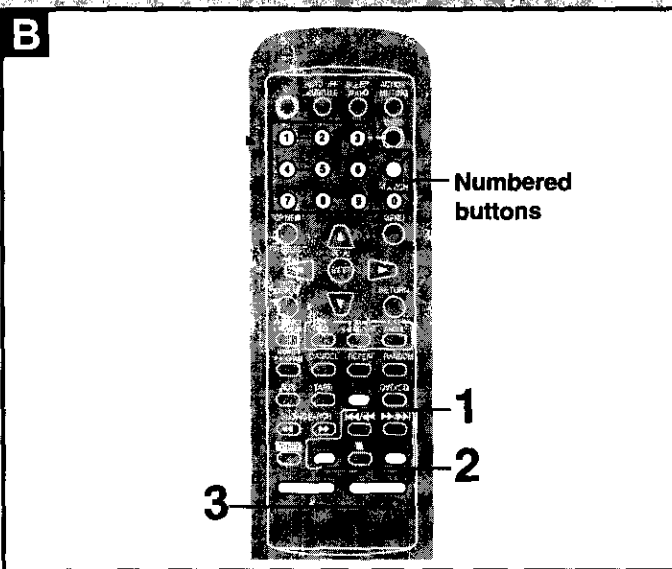
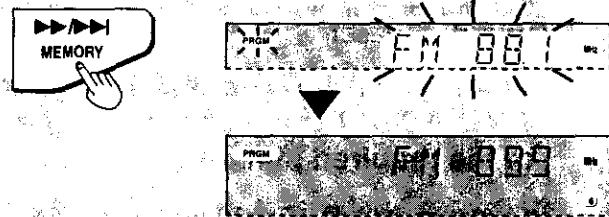
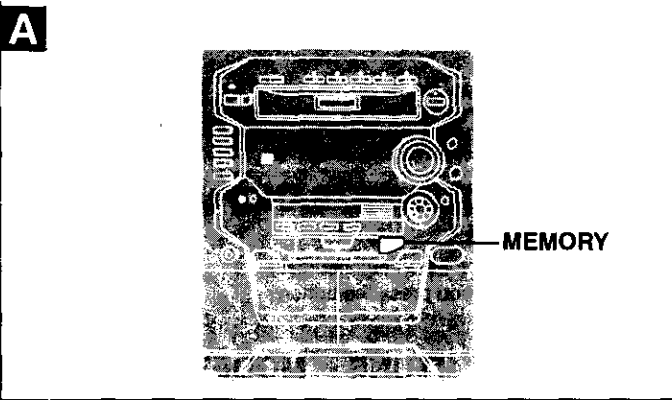

The radio: preset tuning

There are two methods of presetting stations.

Automatic presetting: The stations the tuner can receive are preset.

Manual presetting: You can select the stations to preset and the order they are preset in.

Up to 12 stations can each be set in the FM and AM bands.

A Automatic presetting

Do the following once each for FM and AM.

Preparation:

Tune to the frequency where presetting is to begin (→ page 29).

Press and hold [MEMORY].

Release the button when the frequency starts changing.

The tuner presets the stations it can receive into the channels in ascending order. When finished, the last station memorized is tuned in.

Manual presetting

Preset the stations one at a time.

- ① Press [TUNER, BAND] to select "FM" or "AM".
- ② Press [MEMORY] then press [VTUNE/TIME ADJ] or [TUNE/TIME ADJ^] to tune to the required station.
- ③ Press [MEMORY] then press [VTUNE/TIME ADJ] or [TUNE/TIME ADJ^] to select a preset channel.
- ④ Press [MEMORY].

The station occupying a channel is erased if another station is preset in that channel.

B Selecting channels

Remote control:

- 1 Press [TUNER] to select "FM" or "AM".**
The unit comes on automatically.
Each time you press the button:
FM ↔ AM
- 2 Press [◀/M/V] or [▶/^] to select the channel.**
You can select the channel with the numbered button(s).
To select channel 10 or over
Press [≥10] then the two digits.
- 3 Adjust the volume.**

Main unit:

- ① Press [TUNER, BAND] to select "FM" or "AM".
- ② Press [TUNE MODE] to select "PRESET".
Each time you press the button:
MANUAL ↔ PRESET
- ③ Press [VTUNE/TIME ADJ] or [TUNE/TIME ADJ^] to select the channel.
- ④ Adjust the volume.

Cassette tapes

You can use either deck 1 or deck 2 for tape playback.

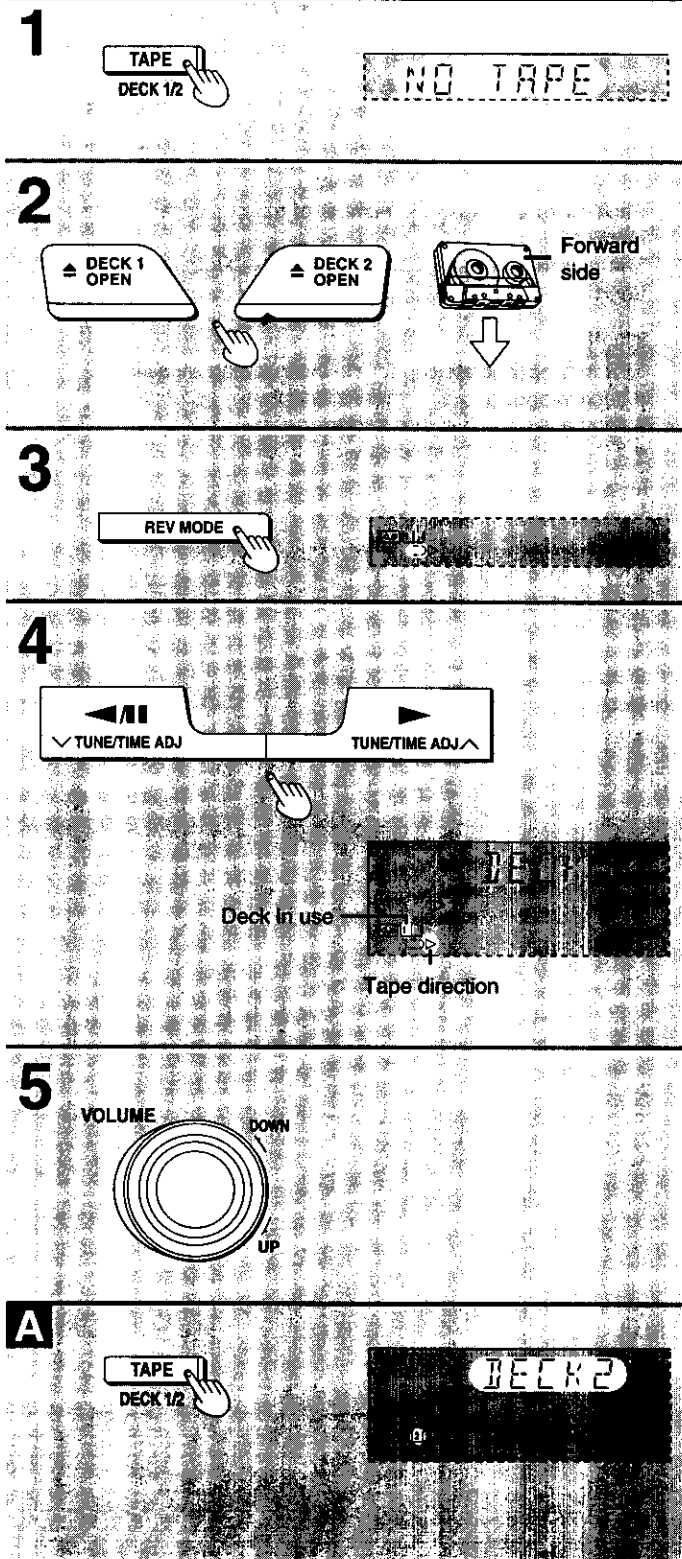

1 Press [TAPE, DECK 1/2] to select tape as the source.
The unit comes on automatically.

2 Press [▲ DECK 1 OPEN] or [▲ DECK 2 OPEN] and insert the cassette.
Insert the cassette with exposed tape facing down and close the holder by hand.

3 Press [REV MODE] to select the reverse mode.

Every time you press the button:

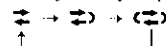

↔ : One side is played.

↔↔ : Both sides are played.

↔↔↔ : Both sides are played 8 times each.

4 Press [◀/II] (reverse side) or [▶] (forward side) to start play.

5 Adjust the volume.

To stop the tape

Press [■].

A To change the deck to be used

Press [TAPE, DECK 1/2] to select the deck you want to play.

To listen to 2 tapes consecutively

Insert a tape into each deck and select "↔↔" in step 3. Both tapes will be played 8 times each.

Note

Play is interrupted while playing a tape if you open the other deck.

Cassette tape selection and care

The unit can correctly play the following types. It identifies the type automatically.

Normal position/TYPE I	✓
High position/TYPE II	✓
Metal position/TYPE IV	✓

- Tapes exceeding 100 minutes are thin and can break or get caught in the mechanism.
- Tape slack can get caught up in the mechanism and should be wound up before the tape is played.
- Endless tapes can get caught up in the deck's moving parts if used incorrectly. Use tapes appropriate to this unit's auto-reverse mechanism.

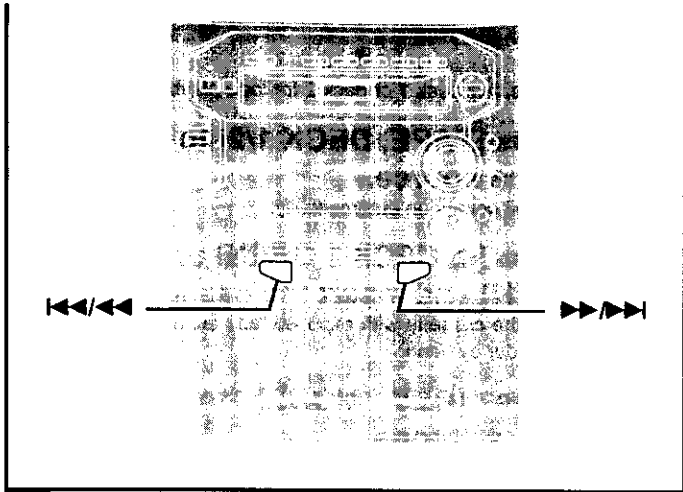

A

A Fast-forwarding and rewinding

Press [**⏮**/**⏪**] or [**⏭**/**⏩**] while the tape is stopped.

Tape direction	rewind	fast-forward
▷	⏮/⏪	⏭/⏩
◁	⏭/⏩	⏮/⏪

B Tape program sensor (TPS)

TPS finds the beginning of a track and plays from there.

Press [**⏮**/**⏪**] or [**⏭**/**⏩**] during play.

Tape direction	backward	forward
▷	⏮/⏪	⏭/⏩
◁	⏭/⏩	⏮/⏪

Each press increases the number of tracks skipped, up to a maximum of 9.

The first skip backward takes you to the beginning of the current track.

Note

TPS may not operate correctly in the following situations:

- If the interval between tracks is less than 4 seconds.
- If there is noise between tracks.
- If there are silent segments within tracks.

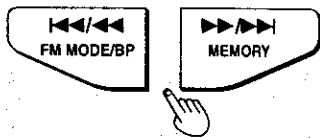

B

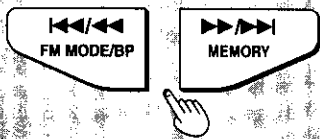

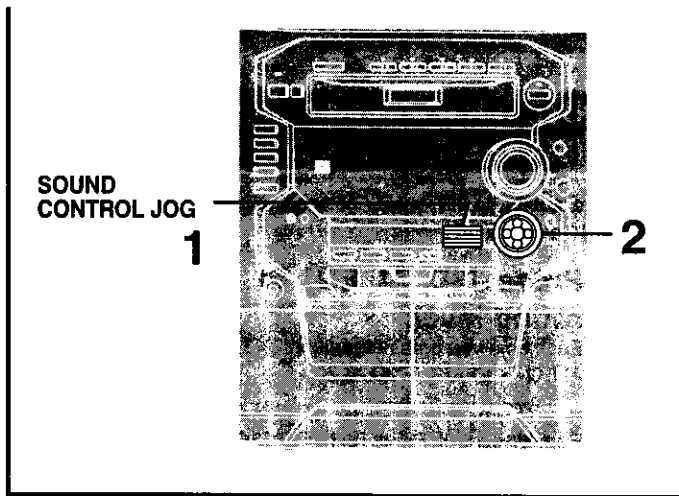

A

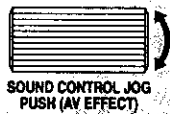

B



2

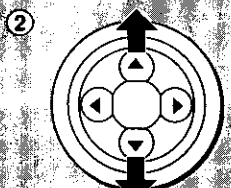
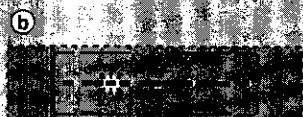
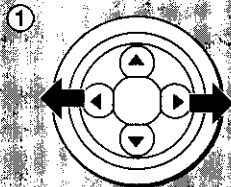

A Changing sound field and quality

Dial [SOUND CONTROL JOG] to select a setting.

Each time you dial the jog

- HEAVY: Adds punch to rock.
- CLEAR: Clarifies higher sounds.
- SOFT: For background music.
- DISCO: Reverberates sound to make you feel like you were in a disco.
- LIVE: Makes vocals more alive.
- HALL: Expands sound to make you feel like you were in a hall.
- M.EQ (MANUAL): Create your own effects (⇒ see below).
- AI-EQ (AI EQ): Adjust sound with the acoustic image equalizer (⇒ page 34).
- FLAT: Canceled (no effect is added).

Remote control:

Press [EQ].

Each time you press the button, the setting changes.

B Using the manual equalizer

Create your own sound quality effects.

1 Dial [SOUND CONTROL JOG] to select "MANUAL".

2 (Within 10 seconds) Change the sound quality with the joystick.

① Select the sound range to be adjusted with [◀] or [▶].

- Ⓐ 100 Hz: Super woofer range
- Ⓑ Around 330 Hz: Bass to midrange
- Ⓒ 1 kHz: Midrange
- Ⓓ Around 3.3 kHz: Midrange to treble
- Ⓔ 10 kHz: Treble

② Adjust the level with [▲] or [▼].

Repeat step 2 to set the desired sound quality.

The original display is restored on the display panel in about 10 seconds.

To cancel

Dial [SOUND CONTROL JOG] to select "FLAT".

The changes you make are stored and automatically recalled the next time you select "MANUAL".

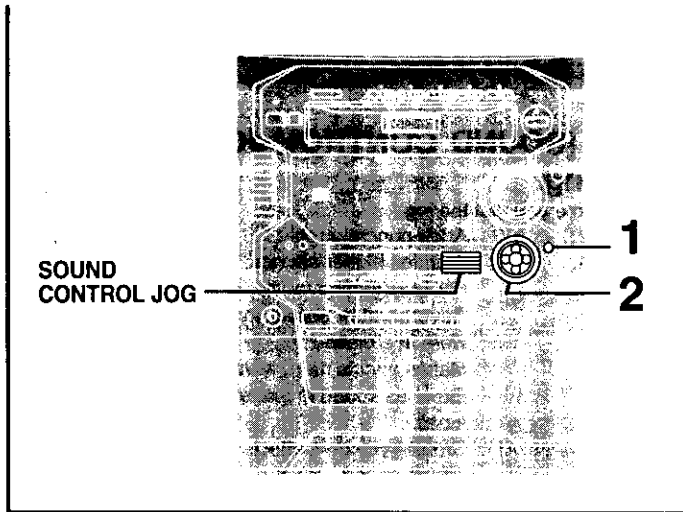

Using the acoustic image equalizer (3D AI EQ)

Achieve subtle sound quality settings with the soft, sharp, heavy, and light coordinates.

1 Press [3D AI EQ] to select the surround level.

Each time you press the button:
AI EQ → 3D AI 1 → 3D AI 2

Remote control: Press [SHIFT] + [3D AI].

2 (Within 10 seconds) Change the sound quality with the joystick (◀, ▶, ▲, ▼).

- ① Adjust softness and sharpness with [◀] or [▶].
- ② Adjust heaviness and lightness with [▲] or [▼].

Repeat steps ① and ② to set the desired sound quality.
The original display is restored on the display panel in about 10 seconds.

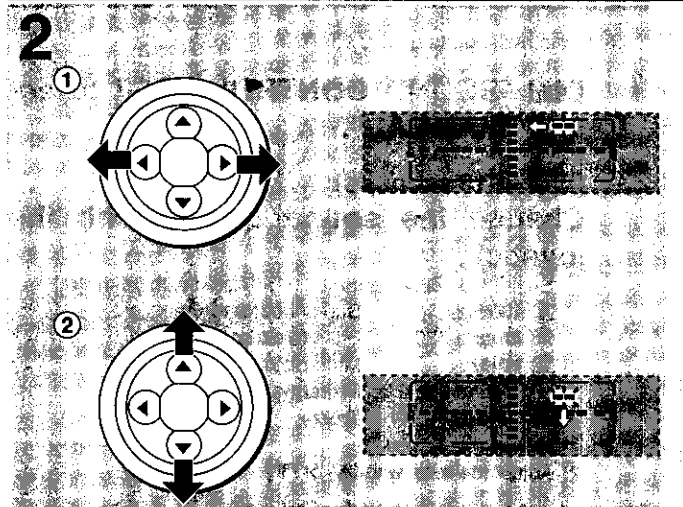
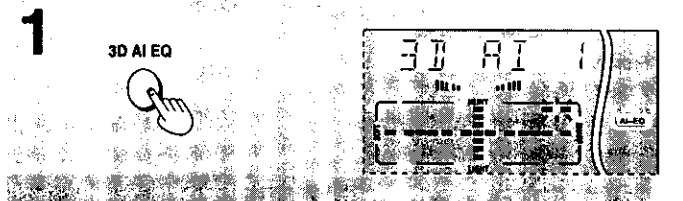

To cancel

Dial [SOUND CONTROL JOG] to select "FLAT".

The changes you make are stored and automatically recalled the next time you press [3D AI EQ] or select "AI-EQ" with [SOUND CONTROL JOG].

Note

- "3D AI 1" and "3D AI 2" cannot be selected while the surround system (⇒ page 36) or karaoke mode (except for U.S.A., Australia and New Zealand) (⇒ page 45) is on.
- "3D AI 1" and "3D AI 2" cannot be selected when you are playing a DVD (except for MIX 2CH mode).

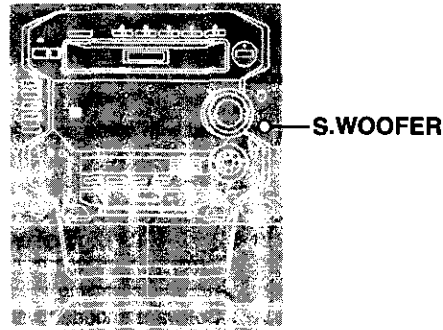
A**A Boosting the super woofer****Press [S.WOOFER].**

The button lights.

- **When listening through speakers**

Each time you press the button:

MID (medium) → MAX (high) → Light off (off)

- **When listening through headphones**

Each time you press the button:

Light on (on) → Light off (off)

To cancel

Press [S.WOOFER] to turn the light off.

S.WOOFER

**B Using the tri-amp control**

The tri-amp control takes advantage of tri-amp wiring of the front speakers, and controls sound quality by allowing you to adjust the level of the amplifiers for the low, mid and high regions.

1 Press [TRI-AMP CONTROL].

[TRI-AMP CONTROL] lights and [LOW] starts flashing.

2 Within 5 seconds

Press [LOW], [MID] or [HIGH] to select the region to be adjusted.

3 While the button is flashing

Dial [SOUND CONTROL JOG] to adjust the level.

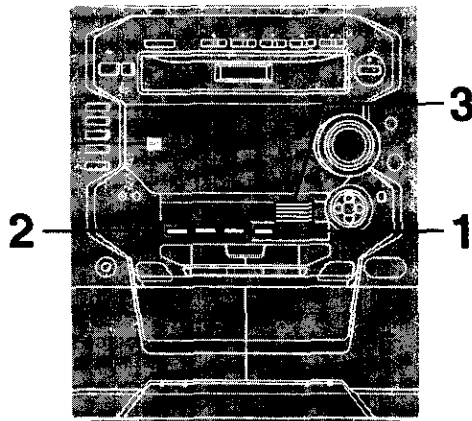
B**1**

TRI-AMP

2

Selected region

3**To cancel**

Press [TRI-AMP CONTROL] while a button ([LOW], [MID] or [HIGH]) is flashing to turn the light off.

The tri-amp setting will be saved in the memory.



Note

- The tri-amp control cannot be used while playing DVD encoded with Dolby Digital (the DIGITAL indicator lights).
- This function cannot be used with the other types of equalizer (→ page 33), DOLBY PRO LOGIC, SUPER SURROUND and SIMULATED STEREO. These features are canceled when [TRI-AMP CONTROL] is pressed.

The following chart gives a summary of this unit's surround features. It also shows additional effects that can be used to enhance your enjoyment.

Note

- All the features are only effective if speakers are used. No discernible effect will be heard through headphones.
- None of the features are effective when radio is selected as the source.
- You may experience a reduction in sound quality when these surround systems and effects are used with some sources. If this occurs, either turn the surround system or effect off or reduce the level of the effect.

Surround system	Features	Software
<p>DOLBY DIGITAL (→ page 38)</p>	<ul style="list-style-type: none"> • Dolby Digital is a discrete 5.1 (6) channel surround system developed for cinema use. The sound signals in Dolby Digital format are compressed to 1/10 their original size, allowing an entire movie to be recorded on a single DVD. • This unit automatically recognizes DVDs that have been recorded with Dolby Digital. • Not all Dolby Digital sources are recorded with 5.1 (6) channels. Some sources marked Dolby Digital may be recorded in Dolby Surround, a 2 channel system. 	<p>Software encoded with Dolby Digital can be identified with this mark.</p>  <ul style="list-style-type: none"> • DVD
<p>DOLBY PRO LOGIC (→ page 39)</p>	<p>Dolby Pro Logic is a decoding system that was developed to get a better sense of presence from sources encoded with Dolby Surround. The feeling of position has been improved by the addition of a separate center speaker channel.</p>	<p>Software encoded with Dolby Surround can be identified with this mark.</p>  <ul style="list-style-type: none"> • DVD • Video CD, CD • Laser Disc • Video tape
<p>SUPER SURROUND (→ page 40)</p> <p>MOVIE</p> <p>MUSIC</p>	<ul style="list-style-type: none"> • This mode adds surround effects to movie software that hasn't been recorded with the above systems. • In MOVIE mode you can adjust the volume of the surround speakers to get the best surround effect. <p>This mode adds surround effects to stereo sources.</p>	<p>Any stereo sound source except for the radio.</p> <ul style="list-style-type: none"> • Video CD, CD • Tape • Video tape
<p>SIMULATED STEREO (→ page 40)</p>	<p>This mode adds stereo-like effects to monaural sources.</p>	<p>Any monaural sound source except for the radio.</p> <ul style="list-style-type: none"> • Video CD, CD • Tape • Video tape

Manufactured under license from Dolby Laboratories. "Dolby", "Pro Logic" and the double-D symbol are trademarks of Dolby Laboratories. Confidential unpublished works. © 1992–1997 Dolby Laboratories. All rights reserved.

Sound quality/sound field operations

See page 41 for operation.

Additional effects

- (A) Virtual rear surround
- (B) Multi rear surround
- (C) Center focus
- (D) 3D enhanced surround
- (E) Seat position

- (A) Virtual rear surround
- (B) Multi rear surround
- (C) Center focus
- (D) 3D enhanced surround
- (E) Seat position

- (A) Virtual rear surround
- (B) Multi rear surround
- (D) 3D enhanced surround
- (E) Seat position

(A) Virtual rear surround

- This effect is useful if you have to place your surround speakers near the front speakers due to the layout of your room.
- This effect makes it seem like the sound from the surround speakers is coming from behind you.

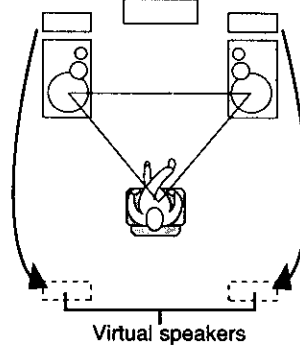

(B) Multi rear surround

- This effect makes it seem like there are multiple surround speakers in your room, increasing the cinema-like atmosphere.

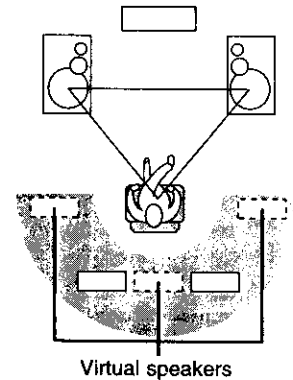

(C) Center focus

- This effect makes it seem like the sound from the center speaker is coming from within the television. You can select one of two levels. (C.FOCUS 1, C.FOCUS 2)
- The center speaker should be placed on top of the television.

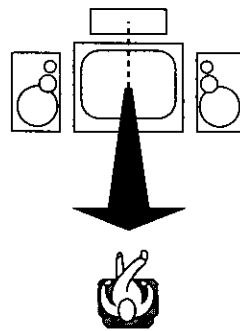

(D) 3D enhanced surround

- This effect adds width to the sound from the surround and front speakers.

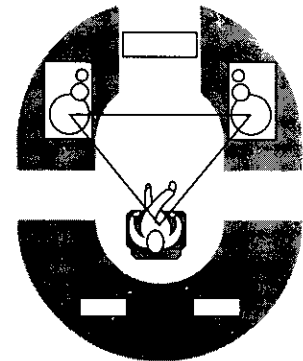

(E) Seat position

- This effect helps maintain the sound position even if the listening position itself is changed.

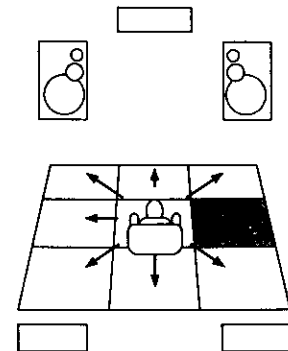

DOLBY DIGITAL

Play a DVD encoded with Dolby Digital.

The **DIGITAL** indicator lights.

S.WOOFER
The **DIGITAL**
indicator

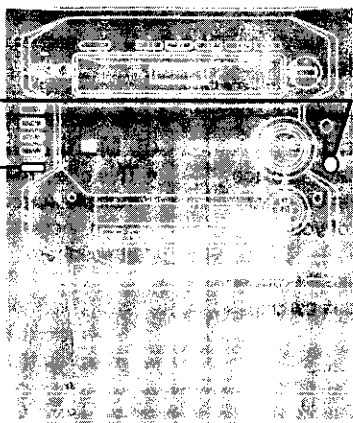

A

MIX 2CH
SHIFT



B

CH SELECT

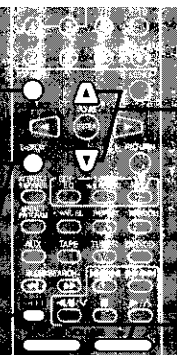

① SHIFT + TEST DISPLAY



② VOLUME +

③



Subwoofer

You can enhance the surround sound by connecting another subwoofer (⇒ page 52 for connection).

If you connect a subwoofer:

Press and hold [S.WOOFER] on the main unit until "SUB W ON" is displayed.

If you disconnect the subwoofer:

Press and hold [S.WOOFER] on the main unit until "SUB W OFF" is displayed.

A To down-mix Dolby Digital (5.1 ch) signals to 2 channels

Remote control only

Press [SHIFT] + [MIX 2CH].

To cancel, press [SHIFT] + [MIX 2CH].

B Speaker level adjustments

If the level of the speakers appears to be different while listening to a source, adjust the level of the speakers to the same apparent level. Sit in the normal listening position and make the adjustments with the remote control.

Remote control only

Preparation: Turn other surround systems off.

- ① Press [SHIFT] + [TEST] to output a test signal.
A test signal is output from the speakers in the following order.
Lch: Front left speaker
Cch: Center speaker
Rch: Front right speaker
RSch: Right surround speaker
LSch: Left surround speaker
The speaker's indicator flashes while the speaker is outputting the test signal.
No signal is output for the subwoofer.
- ② Press [VOLUME (- or +)] to set the volume level of the front speakers normally used for enjoying the source.
- ③ While the speaker to be adjusted is outputting a signal Press the cursor buttons [▲] (to increase level) or [▼] (to decrease level) to adjust the level of each speaker.
Lch, Rch: -16 dB to 0 dB
Cch, RSch, LSch: -10 dB to +6 dB

Repeat step ③ to adjust the level accordingly.

To stop the test noise

Press [SHIFT] + [TEST] again.

To select a specific speaker

1. Press [SHIFT] + [CH SELECT] to select the speaker.

Each time you press the buttons:

Lch → Cch → Rch → RSch → LSch → SWch

SWch: Subwoofer (Adjust only when connected)

2. While the speaker's indicator is flashing Press the cursor buttons [▲] or [▼] to adjust the level.

DOLBY PRO LOGIC

- 1 Press [DOLBY PRO LOGIC].
The button lights.
- 2 Playback a Dolby Surround source.

To cancel
Press [DOLBY PRO LOGIC].
The light turns off.

Note
Turn Dolby Pro Logic off when playing a DVD recorded with 5.1-channel Dolby Digital. The surround effects will not be reproduced correctly if this is left on.

A Speaker level adjustments

If the level of the speakers appears to be different while listening to a source, adjust the level of the speakers to the same apparent level. Sit in the normal listening position and make the adjustments with the remote control.

Preparation: Press [DOLBY PRO LOGIC] to turn the light on.

Remote control only

- 1 Press [SHIFT] + [TEST] to output a test signal.
A test signal is output from the speakers in the following order.
Lch: Front left speaker
Cch: Center speaker
Rch: Front right speaker
Sch: Surround speakers
The speaker's indicator flashes while the speaker is outputting the test signal.
- 2 Press [VOLUME (- or +)] to set the volume level of the front speakers normally used for enjoying the source.
- 3 While the speaker to be adjusted is outputting a signal Press the cursor buttons [▲] (to increase level) or [▼] (to decrease level) to adjust the level of each speaker.
Lch, Rch: -16 dB to 0 dB
Cch, Sch: -10 dB to +6 dB

Repeat step 3 to adjust the level accordingly.

To stop the test noise
Press [SHIFT] + [TEST] again.

To select a specific speaker

1. Press [SHIFT] + [CH SELECT] to select the speaker.
Each time you press the buttons:
Lch → Cch → Rch → Sch
2. While the speaker's indicator is flashing Press the cursor buttons [▲] or [▼] to adjust the level.

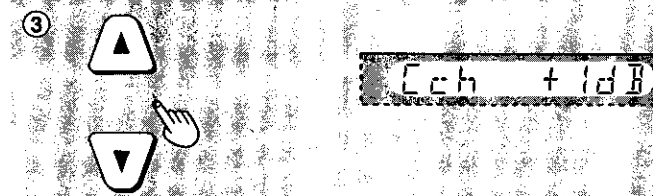
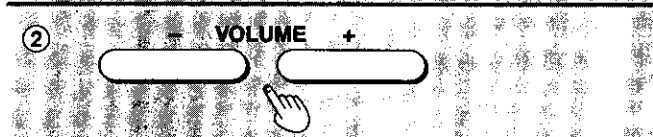
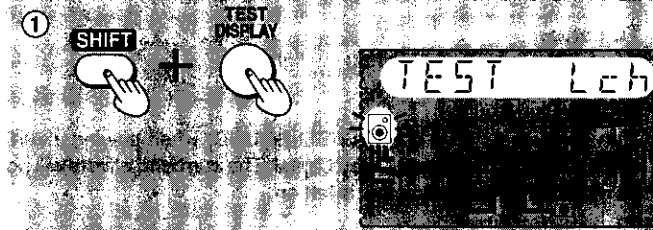
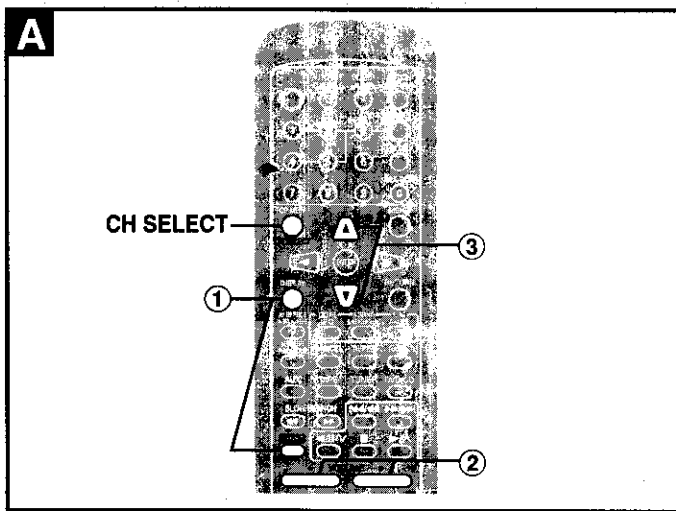
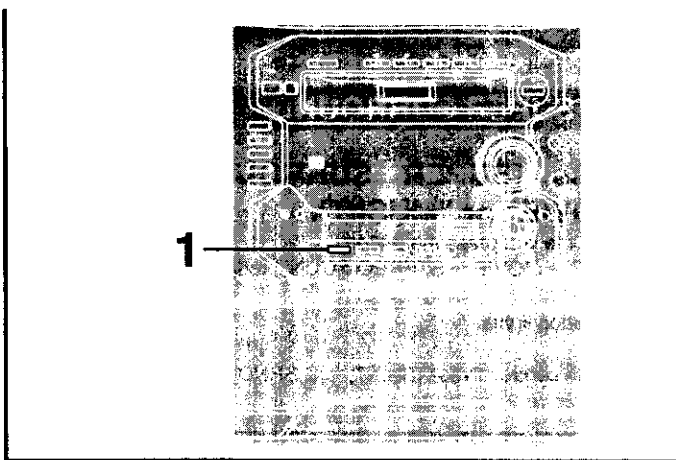

A

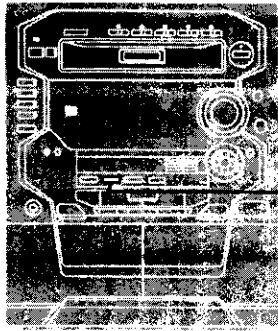

SUPER SURROUND



A SUPER SURROUND

Press [SUPER SURROUND] to select "MOVIE" or "MUSIC".

Each time you press the button:
MUSIC → MOVIE → STEREO SOUND (off)

The button lights.

Remote control: Press [SHIFT] + [S.SRND].

To cancel

Press [SUPER SURROUND] to select "STEREO". The light turns off.

Note

Turn super surround off when playing a DVD recorded with 5.1-channel Dolby Digital. The Surround effects will not be reproduced correctly if this is left on.

B Surround speaker level adjustments

Remote control only

While playing a source

- ① Press [SHIFT] + [CH SELECT].
- ② Press the cursor buttons [▲] (to increase level) or [▼] (to decrease level). (-10 dB to +6 dB)

B

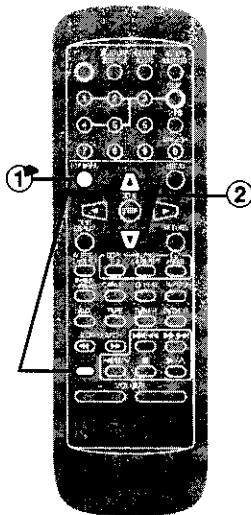

C

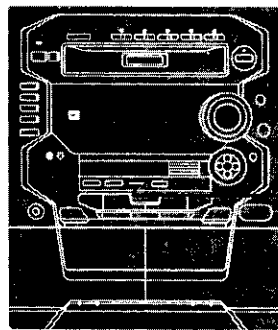

SIMULATED ST

C SIMULATED STEREO

Press [SIMULATED ST].

The button lights.

Remote control: Press [SHIFT] + [S.ST].

To cancel

Press [SIMULATED ST] to turn the light off.

Note

Turn simulated stereo off (STEREO SOUND) when playing a DVD recorded with 5.1-channel Dolby Digital. The surround effects will not be reproduced correctly if this is left on.



Sound quality/sound field operations

AV effects

Use these effects for a more enjoyable surround experience.

Turning the effects on and off

While playing a DVD or when either DOLBY PRO LOGIC or SUPER SURROUND is on.

- 1 Press [SOUND CONTROL JOG].
- 2 Dial [SOUND CONTROL JOG] to select the desired effect (→ page 37).

The following effects can be selected:

- Virtual rear surround (VIRTUAL R)
- Multi rear surround (MULTI R)
- Center focus 1 (C.FOCUS 1)
- Center focus 2 (C.FOCUS 2)
- 3D enhanced surround (3-D ENHANCED)
- Seat position (S.POSITION)

The AV effect indicator of the selected effect flashes.

You can combine some of the effects. Effects that cannot be combined are;

- Virtual rear surround and multi rear surround
- Center focus 1 and center focus 2

Note

Center focus 1 and center focus 2 cannot be selected when super surround is on.

- 3 Press [SOUND CONTROL JOG] to turn the effect on/off.

When the effect is turned on:

"ON" is displayed and the indicator lights.

When the effect is turned off:

"OFF" is displayed and the indicator turns off.

A Adjustment of the seat position

Within 10 seconds after turning on seat position

Adjust the position with the joystick (←, →, ▲, ▼).

Remote control:

① Press [SHIFT] + [AV EFFECT].

② Press the cursor buttons (←, →, ▲, ▼) to select the desired effect.

③ Press [SHIFT] + [AV EFFECT] to turn the effect on/off.

Note

- The seat position is remembered by the unit and is reactivated when you turn seat position on again.
- When used with virtual rear surround or 3D enhanced surround, seat position is changed in 3 horizontal steps.

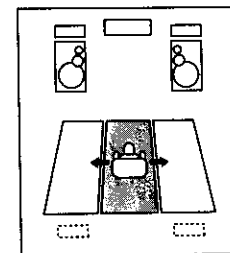

AV effect indicators

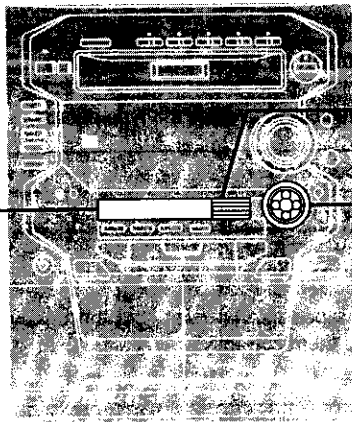

1, 2, 3

Joystick

1

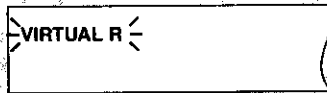

2

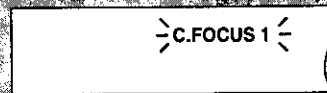

3



A

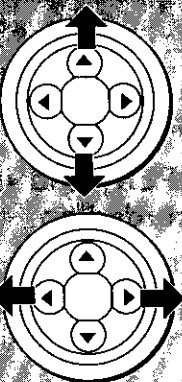

Seat position



Before recording (Deck 2 only)

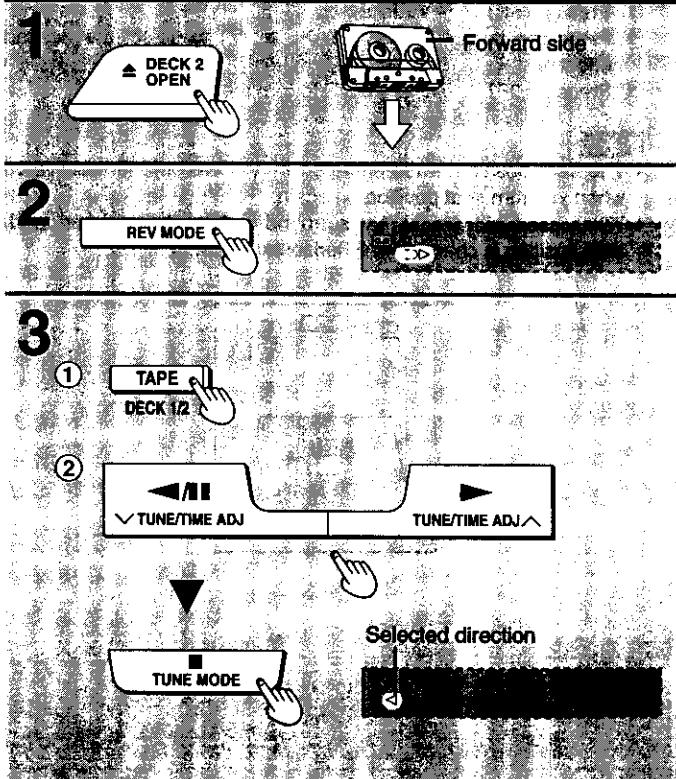
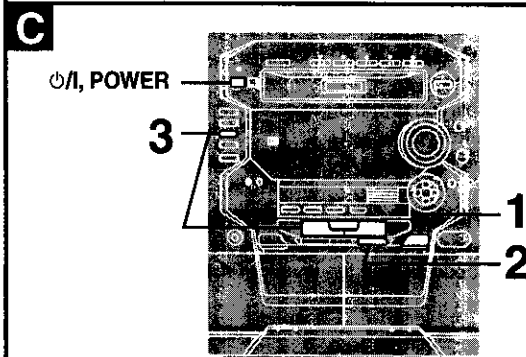
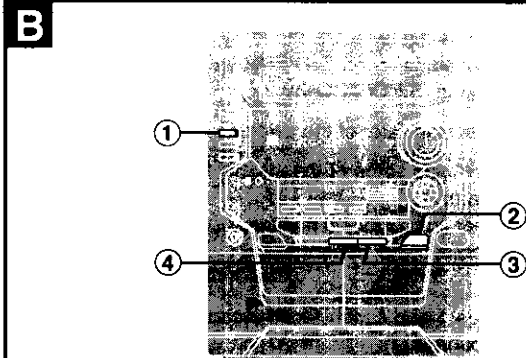
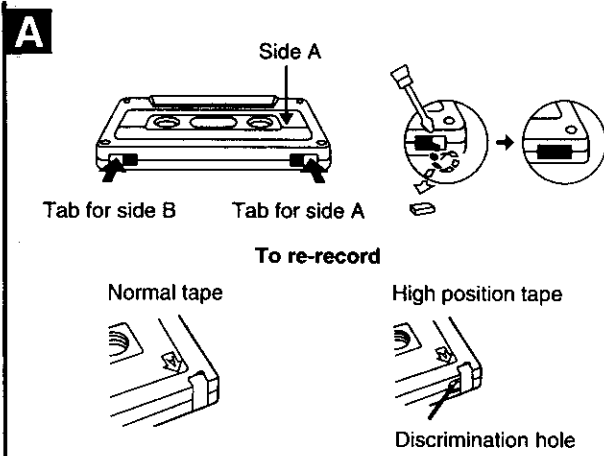

Selection of tapes for recording

The unit automatically identifies the type of tape.

Normal position/TYPE I	✓
High position/TYPE II	✓
Metal position/TYPE IV	×

Metal position tapes can be used, but the unit will not be able to record or erase them correctly.

A Erasure prevention

The illustration shows how to remove the tabs to prevent recording. To record on the tape again, cover as shown, being careful not to cover the high position discrimination hole.

Volume, sound quality and surround effects

- Recording level is set automatically.
- Multi-channel sources (3 to 5.1 channels) are automatically down-mixed to 2 channels during recording.
- All sound effects are automatically set to flat.

B Erasing recordings

Preparation:

(Except for U.S.A., Australia and New Zealand)
Disconnect the microphones.

- ① Press [TAPE, DECK 1/2].
- ② Insert the recorded tape into deck 2.
- ③ Press [REV MODE] to select the reverse mode.
- ④ Press [●REC/STOP].

C Preparatory steps

Recording is done on deck 2. Do not open deck 1 during recording.

Do these steps before each recording.

Wind up the leader tape so recording can begin immediately.

Preparation: Press [⏻/I, POWER] to turn the unit on.

1 Press [▲ DECK 2 OPEN] and insert the cassette to be recorded on.
Insert with the tape facing down.

2 Press [REV MODE] to select the reverse mode.

Each time you press the button:

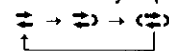

↔ : One side only records.

↔ → ↔ and ↔ ← ↔ : Both sides record (forward → reverse).

"↔ → ↔" automatically changes to "↔ ← ↔" when [●REC/STOP] or [TAPE EDIT] is pressed.

3 Set the tape direction.

① Press [TAPE, DECK 1/2] to select tape.

② Press [◀/II] (<) or [▶] (>) to select the direction, then [■].

Recording discs

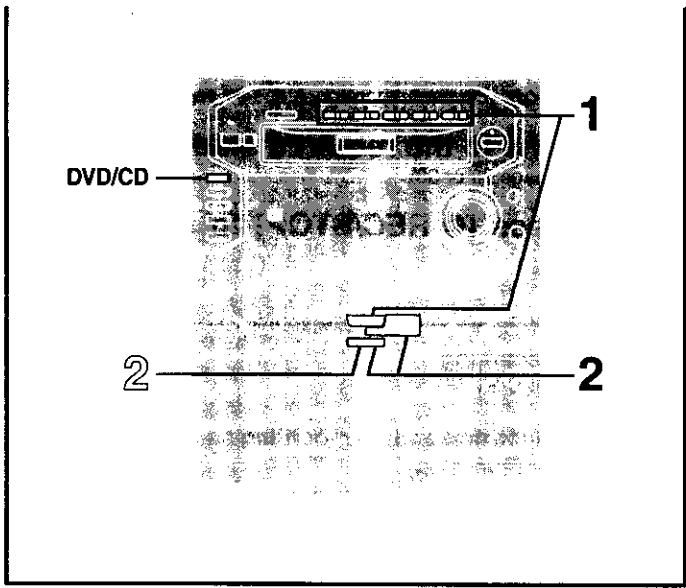

Preparation:

- Do the preparatory steps (⇒ page 42).
- Press [DVD/CD] to select disc as the source and insert the disc(s) you want to record (⇒ page 15).

Normal recording

- 1 Press [1]–[5] to select the disc to be recorded, then [■] to stop play.
The resume function is activated. Press [■] to cancel it.

DVD V-CD

- 2
 - ① Press [●REC/STOP].
 - ② Press [▶] to start play.

CD

- 2 Press [●REC/STOP] to start recording.
The CD starts.

- With DVDs and Video CDs, play will not start when you press [●REC/STOP]. Press [▶] to start play.

To stop recording

DVD and V-CD

Press [●REC/STOP].
The disc keeps playing.

CD

EITHER: Press [●REC/STOP].
The CD stops automatically.

OR: Press [■].
The CD stops, and the tape stops after making a 4 second silent interval.

To record programmed tracks

V-CD and CD only

- ① Program the tracks (⇒ page 23).
- ② Press [●REC/STOP] to start recording.
Play starts.

To stop recording, press [●REC/STOP].
Disc play stops automatically.

Recording with CD MANAGER (⇒ page 25)

V-CD CD

Record discs after selecting the required CD MANAGER mode (1-TRACK, 1-DISC, ALL-DISC).

- If a track is cut off in the middle at the end of the front side while recording, the track will be recorded from the beginning on the reverse side.
- At the end of the reverse side, recording stops and the current track will be interrupted.
- Recording pauses while discs are changing and resumes when the disc is ready.

- ① Do steps 1 and 2 on page 25.
- ② Press [●REC/STOP] to start recording.
Play starts.

To stop recording

Press [●REC/STOP].
Disc play stops automatically.

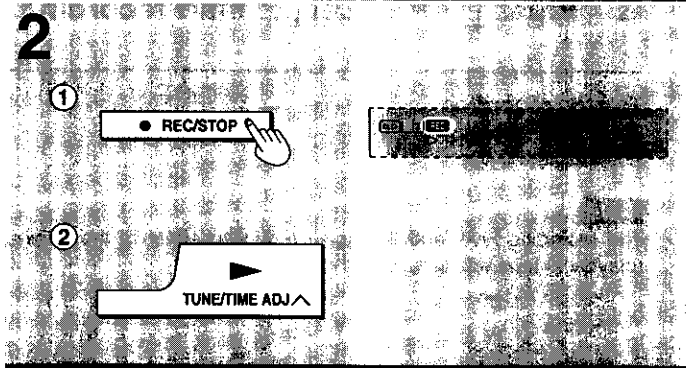
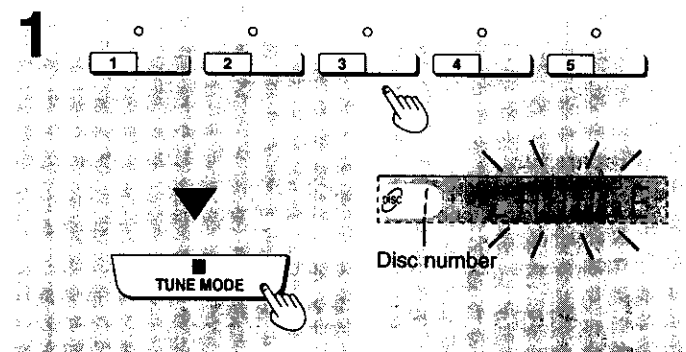

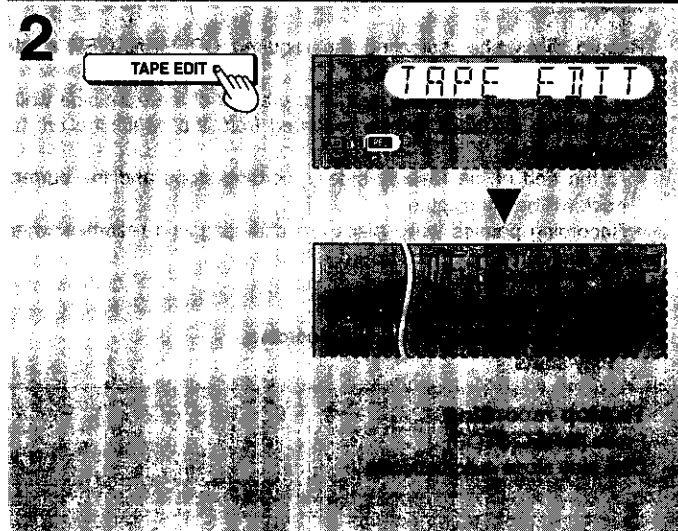
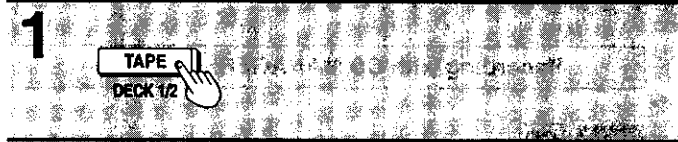
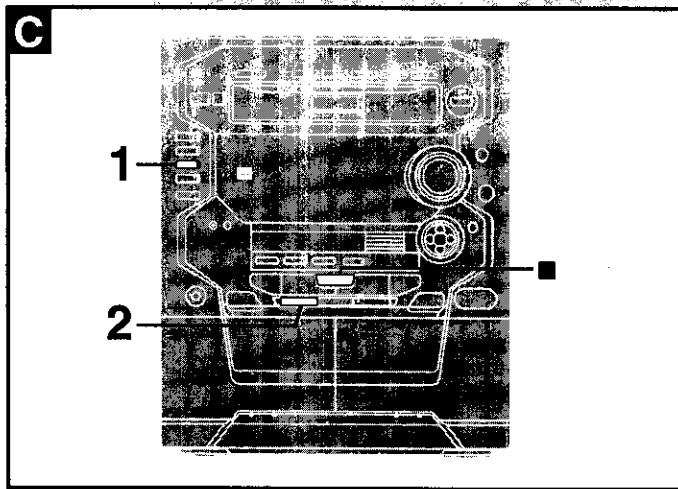
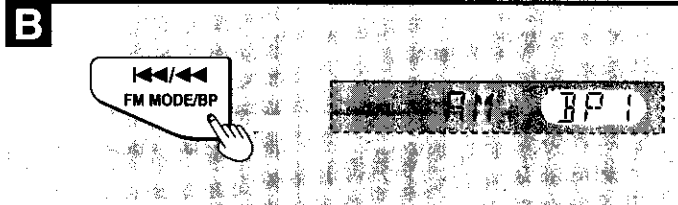
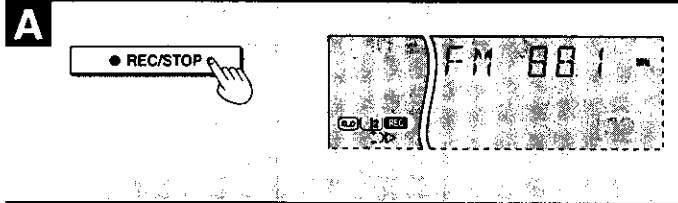
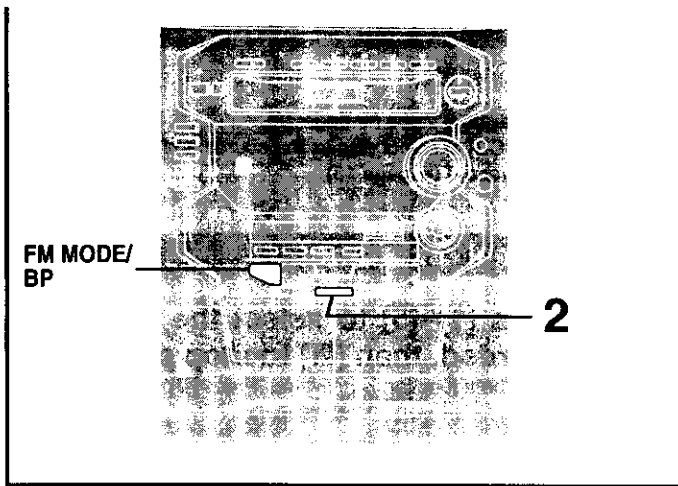

Recording the radio

Preparation: Do the preparatory steps (⇒ page 42).

- 1** Tune to the required station.
(⇒ page 29 or 30)
- 2** Press [● REC/STOP] to start recording.

To stop recording

Press [● REC/STOP].

To reduce noise while recording an AM broadcast (Beat proof function)

Press [FM MODE/BP] while recording.

Each time you press the button:

BP 1 ↔ BP 2

Select the position where there is less noise.

Tape-to-tape recording

Preparation:

- Do the preparatory steps (⇒ page 42).
- Insert the tape for playback into deck 1 with the tape facing down and set the direction.
The reverse mode is set to the same as deck 2.

- 1** Press [TAPE, DECK 1/2].
- 2** Press [TAPE EDIT] to start recording.

To stop recording

Press [■].

Both decks will stop.

Note

The recording level and the noise reduction effect of the original (playback) tape will be recorded on the new tape.

Enjoying karaoke

Except for U.S.A., Australia and New Zealand

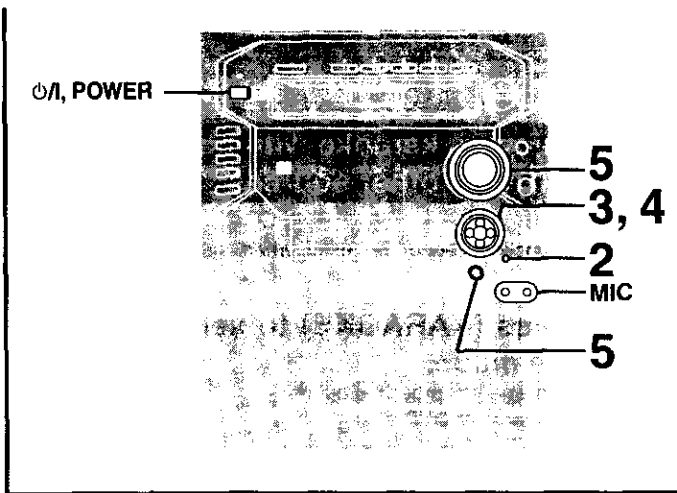

There are DVDs specifically recorded for karaoke (karaoke DVD), and those that are not (non-karaoke DVD).

Preparation:

- Press [ON, POWER] to turn the unit on.
- Turn the television on and switch the video input mode on the television to suit the type of connection you have made (e.g. VIDEO 1).
- Lower volume with [MIC VOL], then connect the microphone(s) (not included) to the microphone jack(s) ([MIC]).
Plug type: 3.5 mm (1/8 in.) monaural

Note

- If a strange noise (squealing or howling) is emitted during use, move the microphone away from the speakers, or turn down the microphone volume.
- When you are not using the microphone, disconnect it from the MIC jack, and turn down the microphone volume level to MIN.

2

KARAOKE



3

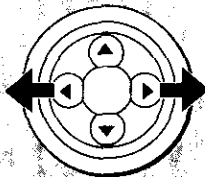

Vocal select



4

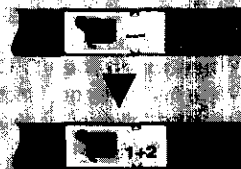
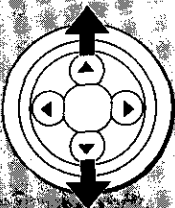

5

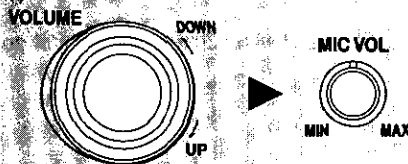

A

Guide melody



Enjoying karaoke with karaoke DVD

- 1 Insert the disc in the tray, and start play (→ page 15).
- 2 Press [KARAOKE] during play.
Karaoke screen is displayed on the television.
If the karaoke screen is not displayed, refer to page 46 for alternative operation.
- 3 Operate the joystick (◀ or ▶) to select the vocal select mode.
- 4 Operate the joystick (▲ or ▼) to select the desired mode.
 - Duet
 - Solo
 - : Vocal off
 - : Vocal off
 - 1 + 2: Vocals 1 and 2
 - ON: Vocal on
 - V1: Vocal 1 only
 - V2: Vocal 2 only

Choose "---" for karaoke.
Choose "V1" or "V2" to duet with the player.
- 5 Adjust volume with [VOLUME] and [MIC VOL] and start singing along.

To clear the karaoke screen

Press [KARAOKE].

Remote control:

- ① After step 1
Press [SHIFT] + [KARAOKE] to display the Karaoke screen.
- ② Press the cursor buttons [◀] or [▶] to select the vocal select mode.
- ③ Press the cursor buttons [▲] or [▼] to select the desired mode.

Using the guide melody function

When singing a song with unfamiliar melody, use this function to raise the volume of the melody.

This function can be used only with some Karaoke DVD.

- ① After step 1 and 2
Operate the joystick (◀ or ▶) to select guide melody mode. **A**
- ② Operate the joystick (▲ or ▼) to select the desired mode.
 - 1: Normal volume
 - 2: Louder volume
 - OFF: off

Enjoying karaoke

Except for U.S.A., Australia and New Zealand

Enjoying karaoke with non-karaoke DVD and other sources

Karaoke function cannot be used when selecting radio as the source.

1 Press [KARAOKE] to select the karaoke mode.

Each time you press the button:

Non-karaoke DVD

V.MUTE ↔ Original display (off)

Other sources

V.MUTE → MONO L → MONO R → Original display (off)

V.MUTE: Voice mute (Lowers vocal volume)

MONO L: Only left channel sound (No vocal)

MONO R: Only right channel sound (Vocal)

(off): Left and right channel sound (Normal sound)

Select voice mute or no vocal for karaoke.

Vocal and no vocal may be reversed.

2 Start the source.

Karaoke with disc: ➔ page 15

Karaoke with tape: ➔ page 31

Karaoke with external sources: ➔ page 53

3 Adjust volume with [VOLUME] and [MIC VOL] and start singing along.

To cancel

Press [KARAOKE] to select off mode.

Remote control:

Press [SHIFT] + [KARAOKE] to select the desired mode.

When using the VOICE MUTE function

Voice mute may not function effectively or noise may interfere when using the following software.

- Monaural software
- Software with few musical instruments, including classic music and poetry recitations
- Software with duets or strong choruses

Note

Karaoke mode cannot be used with surround systems or surround effects.

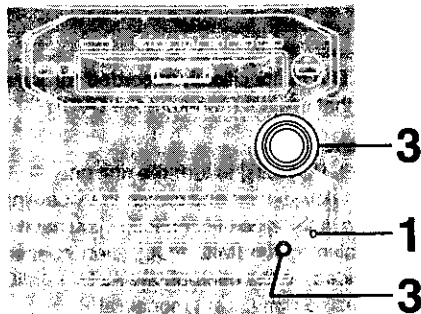

1

KARAOKE



For sources other than non-karaoke DVD

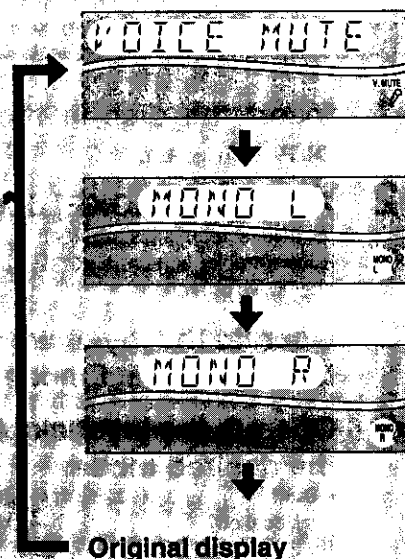

3

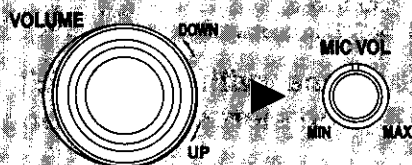

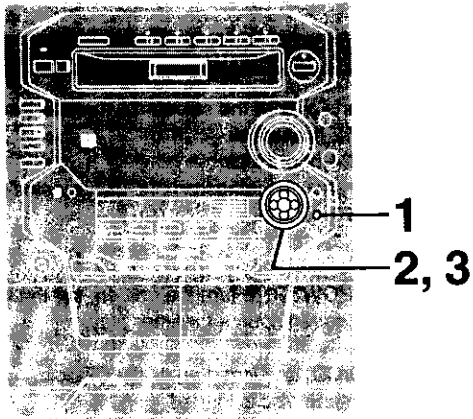

Karaoke possibilities

Adding effects to your karaoke (KARAOKE EFFECT)

- 1** Press [KARAOKE EFFECT].
- 2** Within 5 seconds
Operate the joystick (◀ or ▶) to select the desired mode.
KEYCON ↔ ECHO
- 3** Operate the joystick (▲ or ▼) to select the desired level.

KEYCON:
-3 ↔ -2 ↔ -1 ↔ 0 ↔ +1 ↔ +2 ↔ +3
ECHO:
1 ↔ 2 ↔ 3 ↔ OFF

1

KARAOKE EFFECT



KARAOKE



EFFECT

2

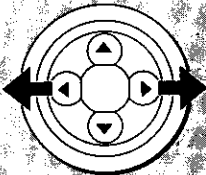

KEYCON 0

3

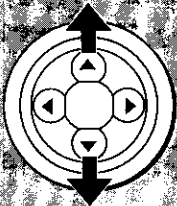

KEYCON -1

To cancel

Press [KARAOKE EFFECT].

The current mode is displayed. Press again to cancel the mode.

Remote control:

- ① Press [SHIFT] + [KARAOKE EFFECT].
- ② Press the cursor buttons [◀] or [▶] to select the desired mode.
- ③ Press the cursor buttons [▲] or [▼] to select the level of effect.

Note

Karaoke effects cannot be used with surround systems or surround effects.

A To record your karaoke performance

Preparation: Do the preparatory steps (⇒ page 42).

- ① Select the mode for karaoke and adjust volume (⇒ page 45 or 46).
- ② When enjoying karaoke with disc or external sources:
Press [●REC/STOP] and start your karaoke performance.
When enjoying karaoke with tape:
Press [TAPE EDIT] and start your karaoke performance.

Note

- To playback the recorded tape, set the karaoke mode to off.
- You cannot record in karaoke mode using sound quality and surround effect.

To record your voice

Do the preparatory steps (⇒ page 42).

1. Press [TAPE, DECK 1/2].
2. Press [●REC/STOP].
3. Speak through the microphone and adjust volume with [MIC VOL].

A

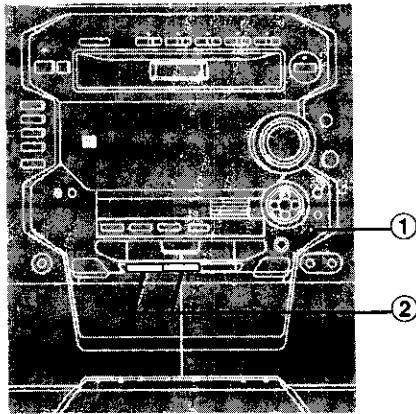

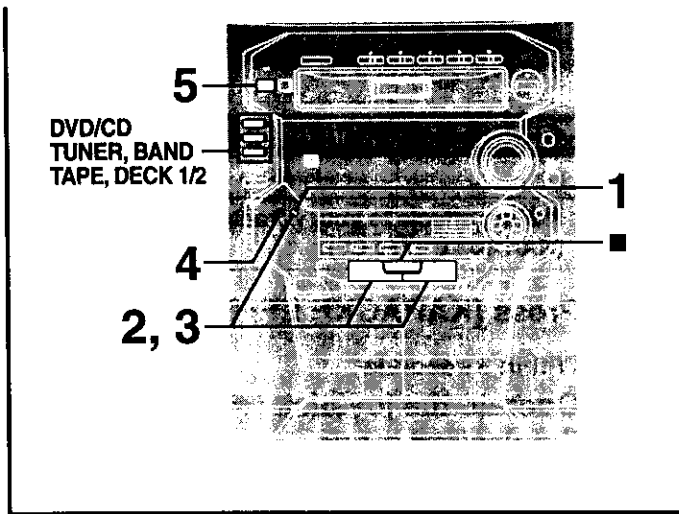

The play timer

This timer starts play of the selected source at the selected time.

For U.S.A.: 12-hour clock

For others: 24-hour clock

The example shows settings on the 12-hour clock for play between 6:30 a.m. and 7:40 a.m.

Preparation:

- Press [⏻, POWER] to turn the unit on, set the time (⇒ page 12).

- Select the desired source for timer play.

Disc

Press [DVD/CD] and insert an Audio CD, etc.

If more than one disc is loaded

Press [1]–[5] to select the disc you want to play and press [■].

Tape

Press [TAPE, DECK 1/2] and insert a cassette.

If tapes are loaded in both decks, playback starts from deck 2.

The radio

Press [TUNER, BAND] and tune in the desired station.

- Set the volume for timer play.

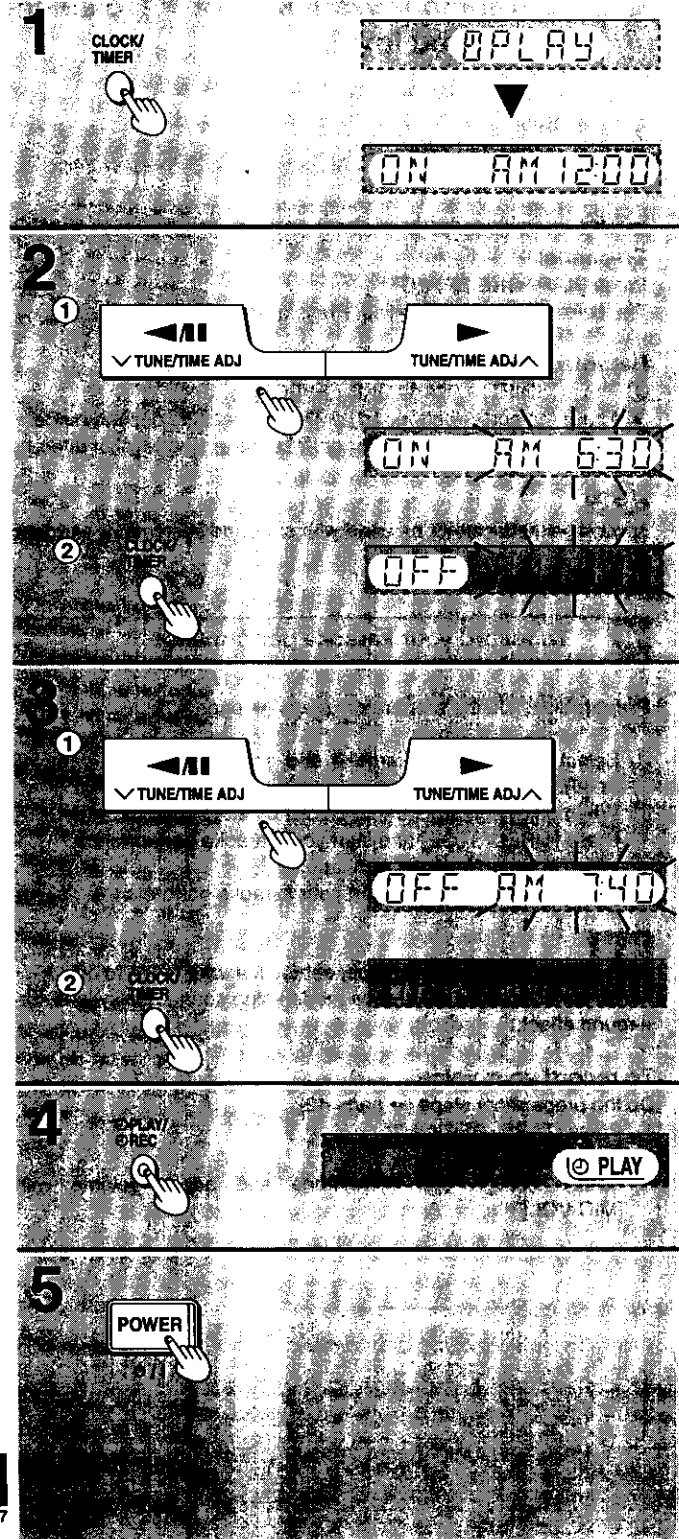

- 1 Press [CLOCK/TIMER] to select "⏻PLAY".

Each time you press the button:

CLOCK → ⏻PLAY → ⏻REC → Original display

- 2 ON time setting

- ① (Within 8 seconds)

Press [▽TUNE/TIME ADJ] or [TUNE/TIME ADJ△] to select the start time.

- ② Press [CLOCK/TIMER].

- 3 OFF time setting

- ① Press [▽TUNE/TIME ADJ] or [TUNE/TIME ADJ△] to select the finish time.

- ② Press [CLOCK/TIMER].

- 4 Press [⏻PLAY/⏻REC] to display "⏻PLAY".

Each time you press the button:

⏻PLAY → ⏻REC → Original display

The [⏻PLAY/⏻REC] indicator lights.

- 5 Press [⏻, POWER] to turn the unit off.

The timer will start in the set condition at the set time.

The volume increases gradually to the set level.

If you set the timer incorrectly

Repeat the procedure from step 1.

To cancel the timer

Press [⏻PLAY/⏻REC] to clear "⏻PLAY".

The [⏻PLAY/⏻REC] indicator turns off.

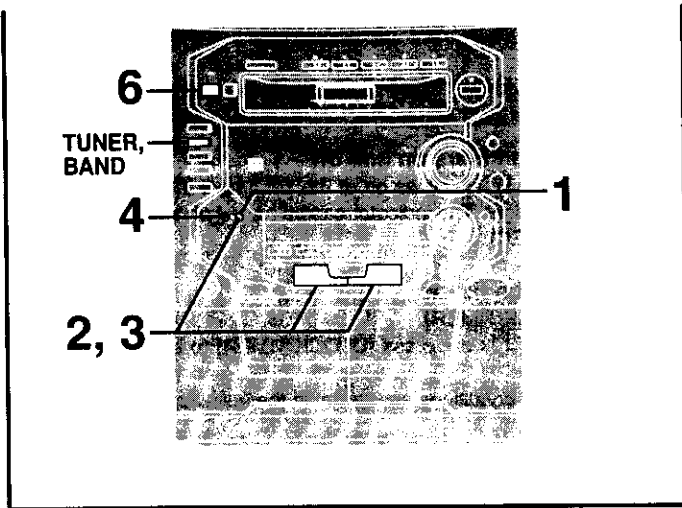

The record timer

This timer records the radio at the set time.

For U.S.A.: 12-hour clock

For others: 24-hour clock

The example shows settings on the 12-hour clock for recording from 6:30 p.m. (18:30) to 8:00 p.m. (20:00).

Preparation:

- Press [⏻/I, POWER] to turn the unit on, set the time (→ page 12).
- Press [TUNER, BAND] and tune in the desired station.

1 Press [CLOCK/TIMER] to select "⊙REC".

Each time you press the button:

CLOCK → ⊙PLAY → ⊙REC → Original display

2 ON time setting

① (Within 8 seconds)

Press [√TUNE/TIME ADJ] or [TUNE/TIME ADJ^] to select the start time.

② Press [CLOCK/TIMER].

3 OFF time setting

① Press [√TUNE/TIME ADJ] or [TUNE/TIME ADJ^] to select the finish time.

② Press [CLOCK/TIMER].

4 Press [⊙PLAY/⊙REC] to display "⊙REC".

Each time you press the button:

⊙PLAY → ⊙REC → Original display

The [⊙PLAY/⊙REC] indicator lights.

5 Prepare for recording.

- ① Insert a tape into deck 2.
- ② Select the reverse mode.
- ③ Select the tape direction.

6 Press [⏻/I, POWER] to turn the unit off.

Recording starts 30 seconds before the set time with the volume muted.

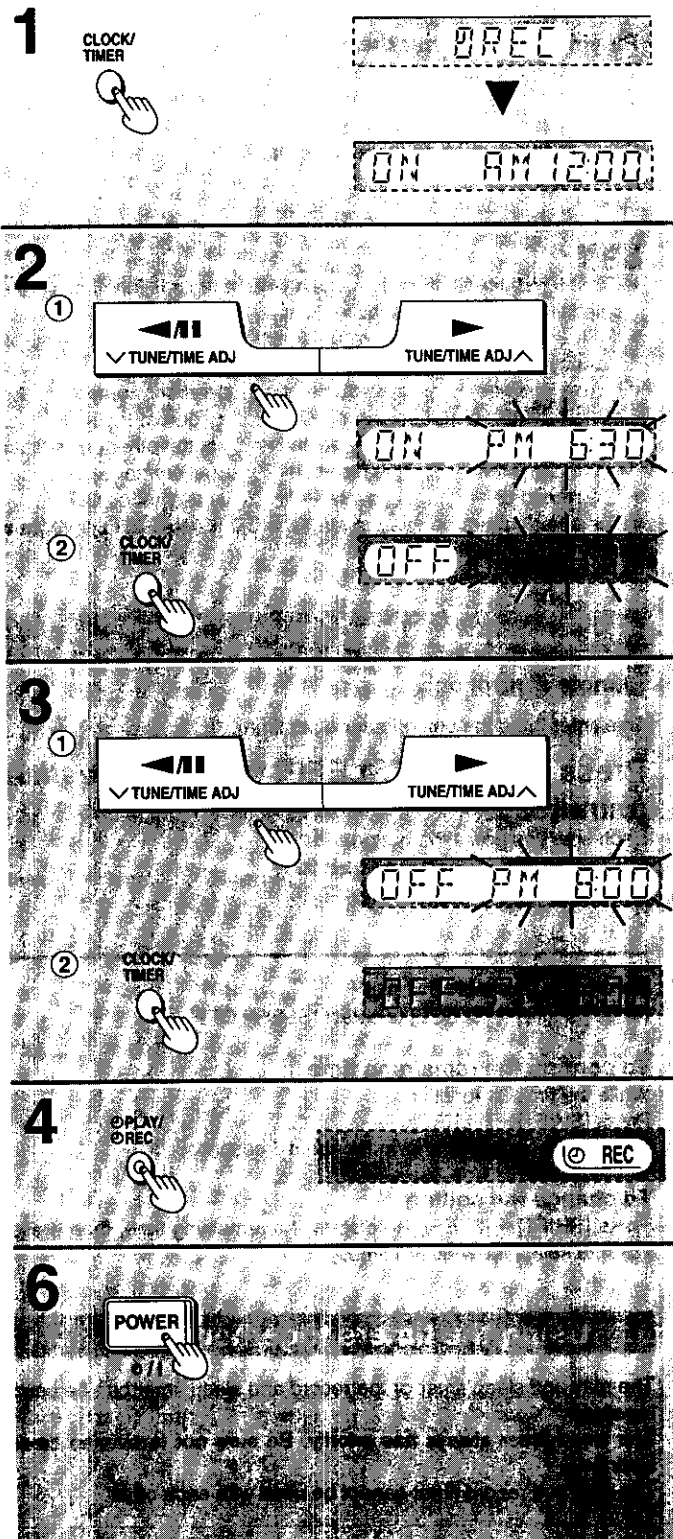

If you set the timer incorrectly

Repeat the procedure from step 1.

To cancel the timer

Press [⊙PLAY/⊙REC] to clear "⊙REC".

The [⊙PLAY/⊙REC] indicator turns off.

A

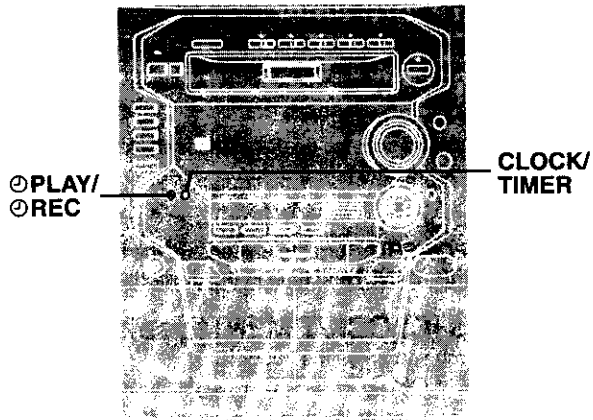

A The play and record timers

Turning the timers on and off

The selected timer comes on at the set time if the [⓪PLAY/⓪REC] indicator is alight. The indicator can be turned on and off by pressing [⓪PLAY/⓪REC].

Checking the timers

Press [CLOCK/TIMER].

(While the unit is on, press [CLOCK/TIMER] to select "⓪PLAY" or "⓪REC".)

The set timer conditions are shown in the following order.

Play timer:

start time → finish time → source → volume

Record timer:

start time → finish time → source

Playing the unit after the timers are set

The unit can be used after the timers are set.

Check the following before turning the unit off again.

If playing tapes or making a recording:

Reset deck selection and tape direction.

If playing disc:

Make sure the desired disc is selected.

Note

- If you turn the unit off and on again while a timer is functioning, the finish time setting will not be activated.
- If the unit is on, the timer will not function. The unit must be in the standby mode.
- If AUX is selected as the source, when the timer comes on, the system turns on and engages AUX as the source. If you want to playback or record from a connected unit, set the other unit's timer to the same time. (See the other unit's instruction manual.)
- The record timer cannot be used with DVDs and Video CDs.
- The timer cannot be used to start the CD MANAGER or program play.

B

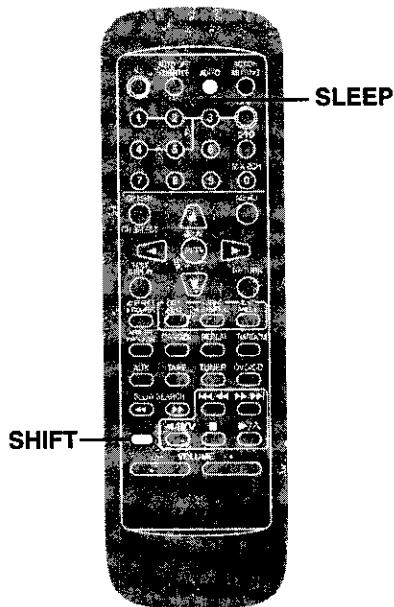

B The sleep timer

Remote control only

This timer turns the unit off after a set time.

Press [SHIFT] + [SLEEP] to select the time (minutes).

Each time you press the button:

SLEEP 30 → SLEEP 60 → SLEEP 90

↑ SLEEP OFF ← SLEEP 120 ←



To cancel the sleep timer

Press [SHIFT] + [SLEEP] to select "SLEEP OFF".

To confirm the remaining time

While the timer is functioning

Press [SHIFT] + [SLEEP].

The remaining time is shown for about 5 seconds.

To change the setting

Press [SHIFT] + [SLEEP] to display the remaining time, then press again to select the required time.

Using the timers together

The play and sleep timer or the record and sleep timer can be used together.

The sleep timer always has priority. Be sure not to overlap timer settings.

The play and record timer cannot be used with each other.

A

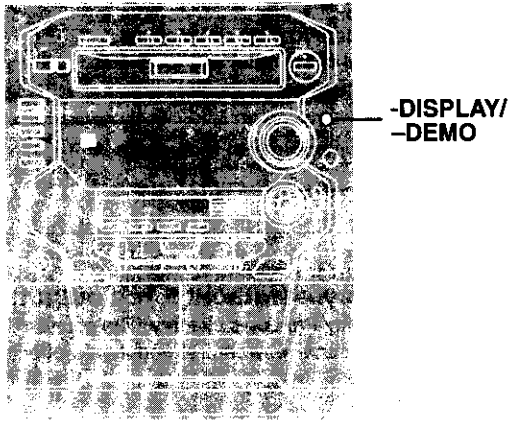

A Changing the sound range display

The unit's display shows the level of each sound range with the three types of display described below.

Press [-DISPLAY/-DEMO].

Each time you press the button:

Normal display → Peak-hold display → Aurora display
 ↑ off (dimmer) ↓

a Normal display

This display indicates the strength of the sound in each tonal range.

b Peak-hold display

The peak sound value of each sound range is held on the display for about one second after it occurs.

c Aurora display

The peak sound value of each sound range is displayed in inverted form.

d off (dimmer)

The display is dimmed and indicators, except for [AC IN] indicator, are turned off for better television viewing.

-DISPLAY/
-DEMO

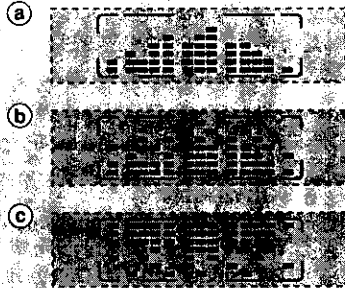

B

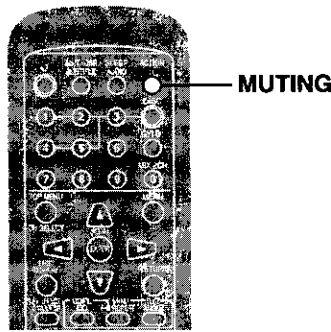

B Muting the volume

Remote control only

Press [MUTING].

Volume is reduced to minimum.

To cancel

Press [MUTING] again.

"MUTING" goes out.

To cancel from the unit, turn [VOLUME] to minimum (--- dB), then raise it to the required level.

Muting is also canceled when the unit is turned off.

(For U.S.A., Australia and New Zealand)

ACTION
MUTING



(For others)

SETUP
MUTING



MUTING



Reduce the volume before connection.

Avoid listening for prolonged periods of time to prevent hearing damage.

Plug type: 3.5 mm (1/8 in.) stereo

Note

When using L-plug headphones (not included), turn the plug to the left so it doesn't interfere with deck 1.

C

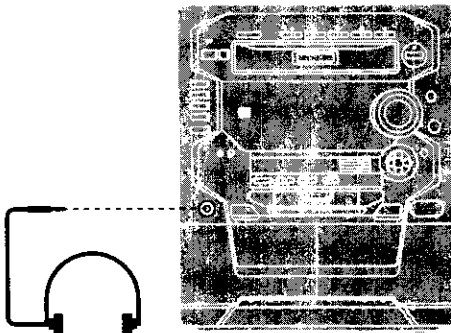

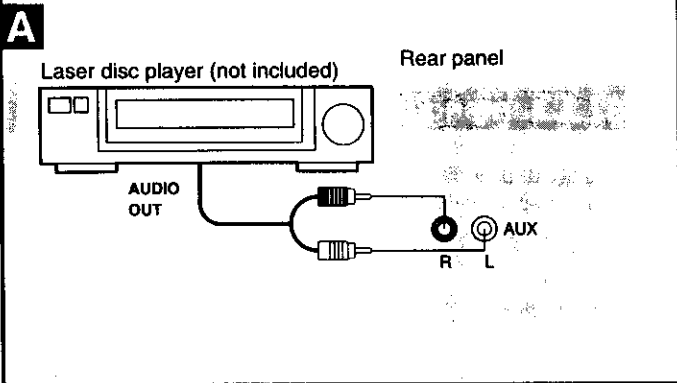

- Turn the unit off before making connections.
- Refer to the manual of the other unit for details.
(Cables and equipment not included.)

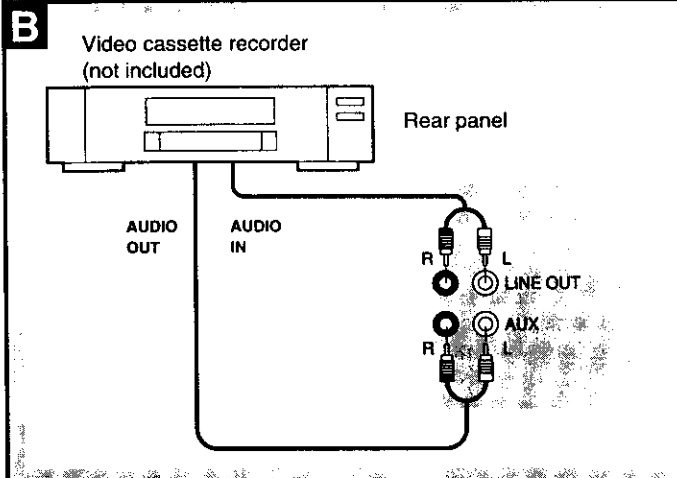
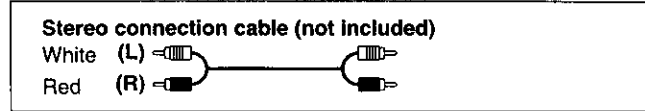

A Laser disc player (without 5.1ch output), etc.
This unit has Dolby Pro Logic circuitry. The sound will be reproduced with the same powerful stereophonic effects found in movie theaters.

B Video cassette recorder
You can playback the sound from a video cassette recorder through this unit's speakers or record sound from this unit onto a video cassette.

C Record player
Sound cannot be produced unless a phono equalizer (not included) is connected.
A record player with a built-in phono equalizer is recommended.

D Subwoofer
The included front speakers have super woofers, but by connecting a subwoofer, you can enhance the bass effect found on DVDs encoded with Dolby Digital (⇒ page 38 for operation).

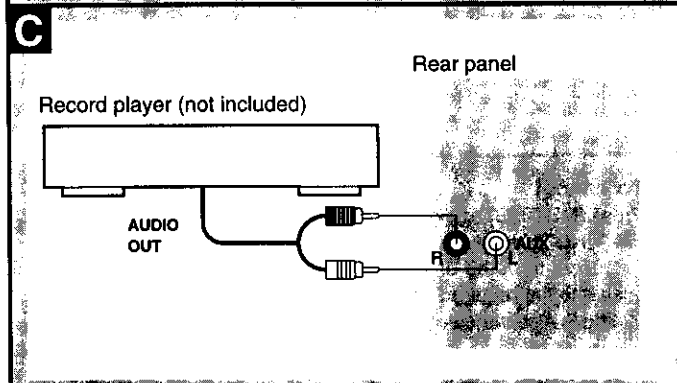

E TV with an S-VIDEO terminal
The S-VIDEO output terminal achieves a more vivid picture than the video output terminal by separating the color and luminance signals before transmitting them to the television. (Actual results depends on the television.)



See the television's manual for details on connection and operation.

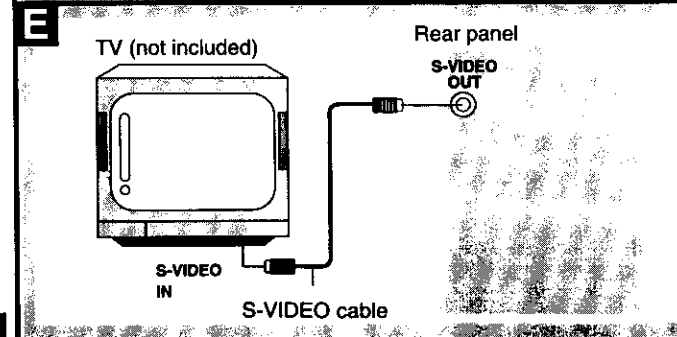
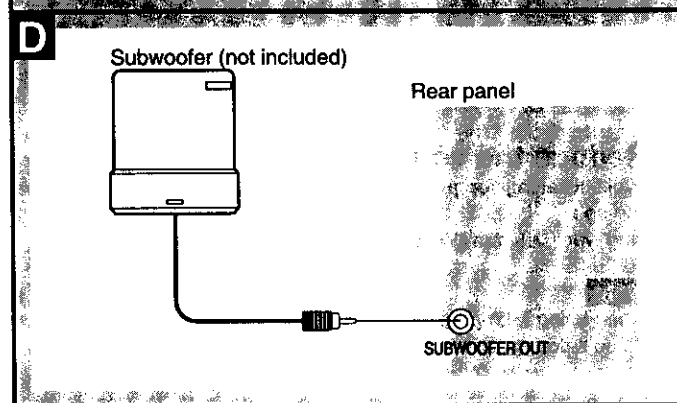

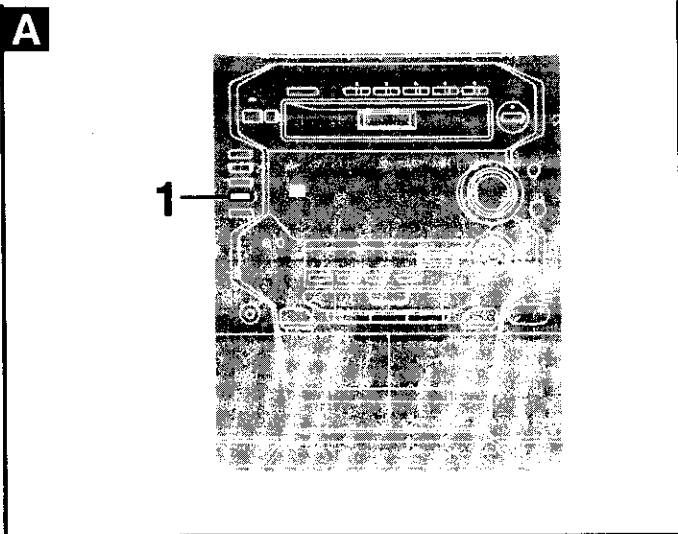

A Listening to an external source

- 1 Press [AUX].**
The unit comes on automatically.
- 2 Operate the unit.**
See the unit's manual for details on operation and connection.

B Recording an external source

Do the preparatory steps (→ page 42).

- 1 Press [AUX].**
- 2 Press [●REC/STOP].**
- 3 Start the source to be recorded.**
See the unit's manual for details on operation and connection.

To stop recording
Press [●REC/STOP].

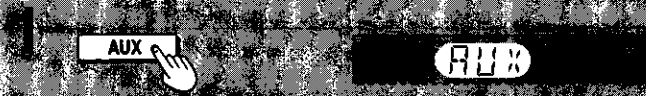
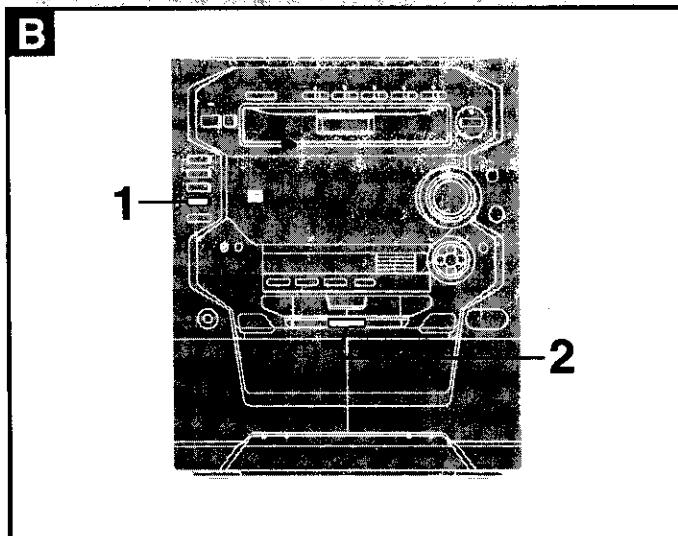

C Recording onto an external unit

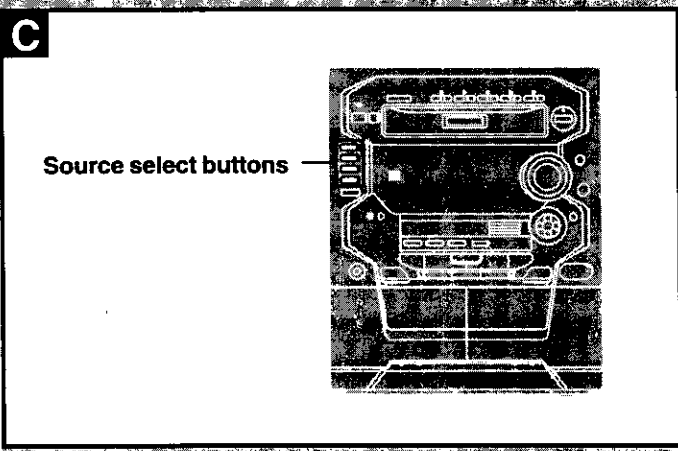

Select the desired source with the source select buttons.
Start recording on the external unit and start playing the source to be recorded.



Summary of initial settings

This chart shows the initial settings for this unit.
The menu and on-screen message language has been factory pre-set to English. You can change the language by going to "3 Menu Language" and selecting the preferred language.

See page 56 for details on operation.
Shaded items are the factory settings.

Item		Options		
1 Disc Languages	1 Audio	For Australia and New Zealand 1 English 5 Spanish 2 French 6 Original 3 German 7 Other * * * * 4 Italian	For Asia 1 English 2 Chinese 3 Original 4 Other * * * *	For others 1 English 4 Original 2 French 5 Other * * * * 3 Spanish
	2 Subtitle	For Australia and New Zealand 1 Automatic 5 Italian 2 English 6 Spanish 3 French 7 Other * * * * 4 German	For Asia 1 Automatic 2 English 3 Chinese 4 Other * * * *	For others 1 Automatic 4 Spanish 2 English 5 Other * * * * 3 French
	3 Menus	For Australia and New Zealand 1 English 4 Italian 2 French 5 Spanish 3 German 6 Other * * * *	For Asia 1 English 2 Chinese 3 Other * * * *	For others 1 English 4 Other * * * * 2 French 3 Spanish
2 Ratings		Level 8 (All DVDs can be played) to level 0 (Play of all DVDs is prohibited) The factory setting is level 8. You must also set a password if you change the rating to any level other than "8" (→ page 57).		
3 Menu Language		For Australia and New Zealand 1 English 4 Italiano 2 Français 5 Español 3 Deutsch	For Asia 1 中文 2 Français	For others 1 Español 3 Español 2 Français
4 On-Screen Messages	1 On-Screen Messages	<input checked="" type="checkbox"/>	2 Off	
	2 Color and Position	<input checked="" type="checkbox"/> 2 Violet  3 Green	4 Blue  5 Violet 6 Green	
5 TV Aspect		<input checked="" type="checkbox"/> 2 16:9		
6 Speaker Setting	Center speaker delay time	<input checked="" type="checkbox"/> 0 ms 1.3 ms 2.6 ms	3.9 ms 5.3 ms	
	Surround speaker delay time	<input checked="" type="checkbox"/> 0 ms 5.3 ms	10.6 ms 15.9 ms	
9 Other Settings	1 Still Mode	<input checked="" type="checkbox"/> Automatic 2 Field 3 Frame		
	2 Audio during Search	<input checked="" type="checkbox"/> On	2 Off	
	3 TV Mode (4:3)	<input checked="" type="checkbox"/> Pan & Scan	2 Letterbox	
	4 D.Range Compression	<input checked="" type="checkbox"/> Off 2 On		
	5 Still Picture Display	<input checked="" type="checkbox"/>	2 On	
	For Asia, Australia and New Zealand 6 NTSC Disc Output	<input checked="" type="checkbox"/> PAL 60 2 NTSC		
	For others 6 Black Level Control	<input checked="" type="checkbox"/> Lighter 2 Darker		

Changes to the initial settings remain intact after the unit is turned off.
Do the setting procedures again to restore to the original settings.

There is no item 7 or 8.

Setting details	
	Select the soundtrack language. Some discs are designed to start in a certain language despite any changes you make here. Input a code number with the numbered buttons when you select "5 Other * * * *" (⇒ page 59).
	Select the subtitle language. Some discs are designed to start in a certain language despite any changes you make here. Input a code number with the numbered buttons when you select "5 Other * * * *" (⇒ page 59).
	Select the language for the top menu and other menus shown by the disc. Input a code number with the numbered buttons when you select "4 Other * * * *" (⇒ page 59).
	Set a ratings level for playing DVDs. The DVDs must have ratings levels recorded on them for this feature to be effective. Discs with this feature will be marked. Level 8: All DVDs can be played. Level 7 to level 1: Prohibits play of DVDs with ratings recorded on them. Level 0: Prohibits play of all DVDs. The password screen is shown if you choose levels 7 to 0.
	Select the language used for menus and messages the unit displays on the television (including these menus).
	Choose whether to show the on-screen messages that appear on the television when you perform operations. Select the color and position of on-screen messages and GUI.
	Select the aspect ratio to suit your television. 4:3: Regular television 16:9: Widescreen television
	The optimum when listening to 5.1 channel sound is for all the speakers, except for the subwoofer, to be the same distance from the listening position. You can adjust the delay time for the center and surround speakers to make up for differences in distances between the speakers (⇒ page 59). These adjustments are effective when playing DVDs encoded with Dolby Digital.
	Select a picture type for when the picture is paused. Field: Less blurred field stills are shown. Select if jittering occurs when "1 Automatic" is selected. Frame: Sharper frame stills are shown. Select if small text or fine patterns cannot be seen clearly when "1 Automatic" is selected.
	Select whether to have sound on or off during the first level of forward search.
	Select how software made for a widescreen television is displayed on a regular television (⇒ page 58).
	Select whether to have dynamic range compression on or off during play of Dolby Digital software. Dynamic range is the difference between the loudest sound and the softest sound. By compressing this range, you can listen at low volume but still enjoy clear dialog.
	Select whether the picture type (I/P/B) is shown when a DVD is paused.
	Select whether to output the video signal on NTSC discs as PAL 60 or as the original NTSC signal. If you have connected a PAL system television, select "1 PAL 60". If you have connected a multi system television, select "2 NTSC".
	Lighter or darker picture.

Changing the initial settings

Remote control only

Once the initial settings have been completed, the unit can always be operated under the same conditions.

Preparation:

Press [DVD/CD] to select disc as the source.
The unit comes on automatically.

- 1** While the disc is stopped
(For U.S.A., Australia and New Zealand)
Press [SHIFT] + [ACTION].
(For others)
Press [SHIFT] + [SETUP].
The initial settings menu is displayed.
- 2** Press the cursor buttons [▲] or [▼] to highlight the item, and press [ENTER].
- 3** Press the cursor buttons (◀, ▶, ▲, ▼) to select the item, and press [ENTER].
Repeat step 3 as the menu requires to make the changes.

Steps 2 and 3 can also be done with the numbered buttons.
Press the number next to the required item.
For example, press [3] to select "3 Menu Language".

To return to the previous screen
Press [RETURN].

To exit the initial settings menu
(For U.S.A., Australia and New Zealand)
Press [SHIFT] + [ACTION].
(For others)
Press [SHIFT] + [SETUP].

Note

- The initial settings cannot be accessed while program mode is on ("P" is displayed, ⇒ page 23).
Press [PROGRAM] to turn the mode off.
- The initial settings cannot be accessed while CD MANAGER (⇒ page 25) is on. Press [CD MANAGER] to select "NORMAL".

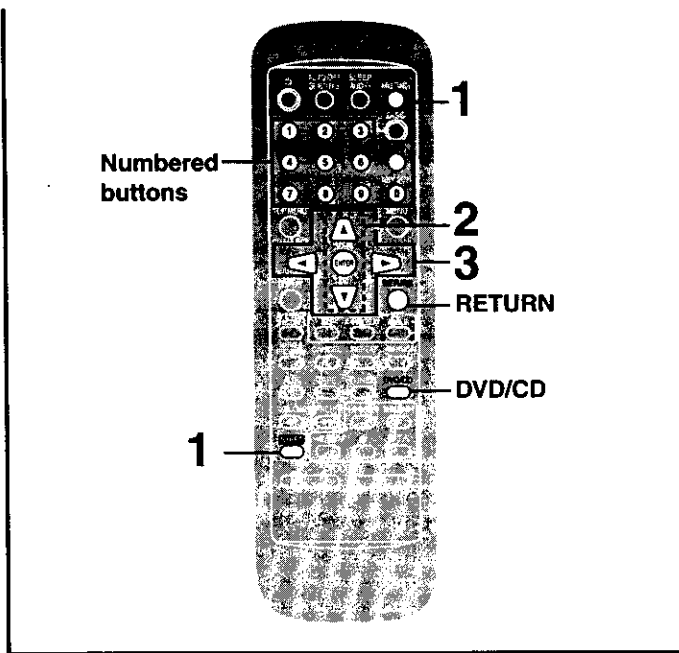

1 (For U.S.A., Australia and New Zealand)

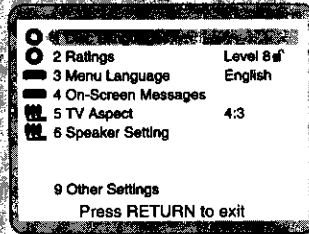
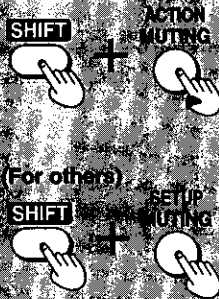

2

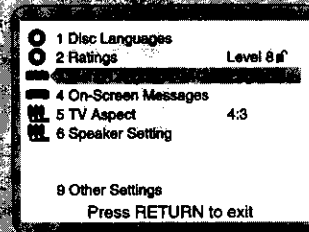

3

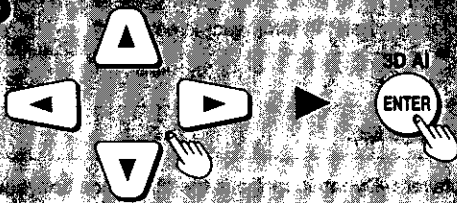

Entering a password

The password screen is shown if you choose levels 7 to 0.

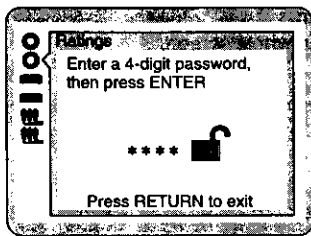

- ① Input a 4-digit password with the numbered buttons and press [ENTER].

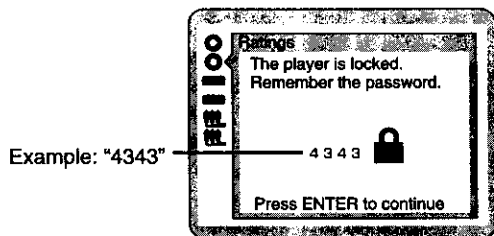

- ② Press [ENTER].

To change the level setting or the password

- ① Select "2 Ratings".
The password screen is shown.

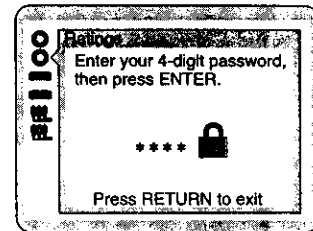

- ② Input your password with the numbered buttons and press [ENTER].

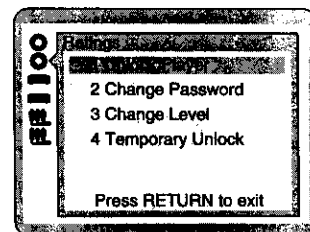

- ③ Select an item with the cursor buttons and press [ENTER].















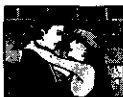

- 1 **Unlock Player:** The rating level returns to 8 and the player is unlocked.
- 2 **Change Password:** You can change the password. Enter new 4 digits and press [ENTER], then press [ENTER] again.
- 3 **Change Level:** You can change the rating level. Select a new level with the cursor buttons (▲ or ▼), then press [ENTER].
- 4 **Temporary Unlock:** The player is unlocked temporarily only for the current disc. The player is locked again when the disc tray is opened or the player is turned off.

Press [RETURN] to restore the original display.

How different kinds of software appear on your television

DVD software is recorded in a variety of picture formats, and how they appear on your television depends on the software, the kind of television you have, and the picture mode your television is set to.

- Letterbox refers to pictures where black bands appear at the top and bottom.
- Pan & Scan refers to pictures where part of the picture is cut off so it fills the whole screen.

Television and picture mode Software format	4:3	16:9 full mode	16:9 zoom mode	16:9 auto mode
Wide screen, Pan and Scan 	Edges cut off 	Full screen 	Top and bottom cut off 	Full screen 
Wide screen, non-Pan and Scan 	Letterbox 			
Regular (4:3) 	Full screen 	Screen stretched horizontally 	Top and bottom cut off 	Full screen with black bands on the left and right 
Regular (4:3), letterbox 	Letterbox 	Letterbox with screen stretched horizontally 	Full screen 	Letterbox with extremities of picture stretched 

The names given to the television picture modes depend on the maker of your television. There may also be slight differences in how the pictures appear on the screen. Refer to your television's operating instructions for details.

Calculating delay time

The sound from speakers can reach the listening position at different times depending on placement. You can allow for this difference by changing the delay time of the center and surround speakers.

Center speaker delay time

If $D1 \leq D2$, then set delay time to 0 ms.
If $D1 > D2$, then set delay time as follows:

Difference between D1 and D2	Delay time
50 cm	1.3 ms
100 cm	2.6 ms
150 cm	3.9 ms
200 cm	5.3 ms

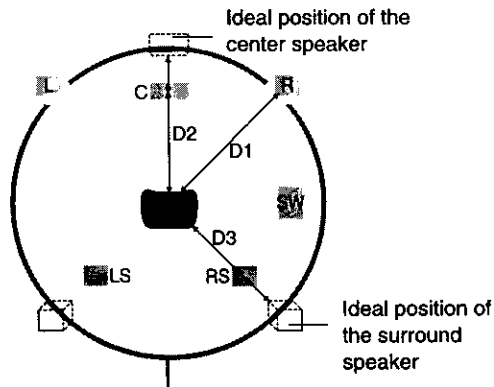

It is recommended to place all the speakers inside this circle.

D1: The distance from the front speaker
D2: The distance from the center speaker
D3: The distance from the surround speaker

Surround speaker delay time

If $D1 \leq D3$, then set delay time to 0 ms.
If $D1 > D3$, then set delay time as follows:

Difference between D1 and D3	Delay time
200 cm	5.3 ms
400 cm	10.6 ms
600 cm	15.9 ms

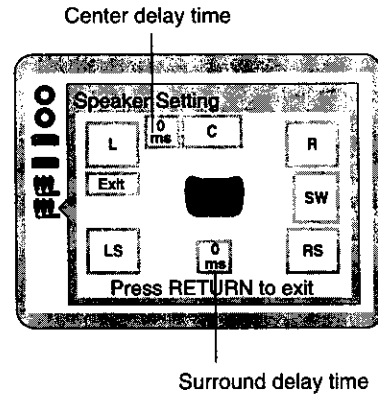

Language code list

6566: Abkhazian	7074: Fiji	7679: Laotian	8373: Singhalese
6565: Afar	7073: Finnish	7684: Lithuanian	8375: Slovak
6570: Afrikaans	7082: French	7775: Macedonian	8376: Slovenian
8381: Albanian	7089: Frisian	7771: Malagasy	8379: Somali
6577: Ameharic	7176: Galician	7783: Malay	6983: Spanish
6582: Arabic	7565: Georgian	7776: Malayalam	8385: Sundanese
7289: Armenian	6869: German	7784: Maltese	8387: Swahili
6583: Assamese	6976: Greek	7773: Maori	8386: Swedish
6588: Aymara	7576: Greenlandic	7782: Marathi	8476: Tagalog
6590: Azerbaijani	7178: Guarani	7779: Moldavian	8471: Tajik
6665: Bashkir	7185: Gujarati	7778: Mongolian	8465: Tamil
6985: Basque	7265: Hausa	7865: Nauru	8484: Tatar
6678: Bengali; Bangla	7387: Hebrew	7869: Nepali	8469: Telugu
6890: Bhutani	7273: Hindi	7879: Norwegian	8472: Thai
6672: Bihari	7285: Hungarian	7982: Oriya	6679: Tibetan
6682: Breton	7383: Icelandic	8065: Punjabi	8473: Tigrinya
6671: Bulgarian	7165: Irish	8083: Pashto, Pushto	8479: Tonga
7789: Burmese	7378: Indonesian	7065: Persian	8482: Turkish
6669: Byelorussian	7365: Interlingua	8076: Polish	8475: Turkmen
7577: Cambodian	7384: Italian	8084: Portuguese	8487: Twi
6765: Catalan	7465: Japanese	8185: Quechua	8575: Ukrainian
9072: Chinese	7487: Javanese	8277: Rhaeto-Romance	8582: Urdu
6779: Corsican	7578: Kannada	8279: Romanian	8590: Uzbek
7282: Croatian	7583: Kashmiri	8285: Russian	8673: Vietnamese
6783: Czech	7575: Kazakh	8377: Samoan	8679: Volapük
6865: Danish	7589: Kirghiz	8365: Sanskrit	6789: Welsh
7876: Dutch	7579: Korean	7168: Scots Gaelic	8779: Wolof
6978: English	7585: Kurdish	8382: Serbian	8872: Xhosa
6979: Esperanto	7665: Latin	8372: Serbo-Croatian	7473: Yiddish
6984: Estonian	7686: Latvian, Lettish	8378: Shona	8979: Yoruba
7079: Faroese	7678: Lingala	8368: Sindhi	9085: Zulu

Before requesting service, make the below checks. If you can't fix the unit as described below, or if something not listed here occurs, refer to the enclosed directory to locate an Authorized Service Center convenient to you or contact your dealer.

For detailed instructions, contact an authorized servicenter in the U.S.A..

In the U.S.A., call 1-800-211-7262, e-mail consumerproducts@panasonic.com, or visit www.panasonic.com

Reference pages are shown as black circled numbers ⑧.

Common Problems

<p>No sound.</p> <p>Sound is unfixed, reversed or comes from one speaker only.</p> <p>Humming heard during play.</p> <p>"ERROR" is displayed.</p> <p>"---:--" appears on the display.</p> <p>"F61" is displayed.</p> <p>ECO mode on but display still lights up in standby mode.</p> <p>"DTS NO AUDIO" is displayed.</p> <p>"DVD U11" is displayed.</p> <p>"DVD H □□" is displayed. (□□ will be numbers.)</p>	<p>Turn the volume up. The speaker cables may be shorted. Turn the unit off, check and correct the connections and turn the unit on. ⑧, ⑨</p> <p>Check the speaker connections. ⑧, ⑨</p> <p>An AC power supply cord or fluorescent light is near the cables. Keep other appliances and cords away from this unit's cables. If possible in your area, turn the AC power supply cord's plug or connector over to reverse the plug's polarity.</p> <p>Incorrect operation performed. Read the instructions and try again.</p> <p>You plugged the power supply cord in for the first time or there was a power failure recently. Set the time. ⑩</p> <p>Check and correct the speaker cords connection. If this does not fix the problem, there is a power supply problem. Consult the dealer.</p> <p>Turn DEMO off. ⑪</p> <p>This unit is unable to decode DTS signals.</p> <p>The disc is dirty. Wipe it with a soft cloth.</p> <p>A problem has occurred. Turn the unit off and unplug the AC power supply cord. Wait a moment and then plug the cord in and turn on the unit again. If the unit is still not working correctly, consult your dealer.</p>
---	---

Listening to the radio

<p>Noise is heard. The stereo indicator flickers or doesn't light.</p> <p>Sound is distorted.</p> <p>A beat sound is heard.</p> <p>A low hum is heard during AM broadcasts.</p>	<p>Use an outdoor antenna. ⑬</p> <p>Turn the TV off or separate it from the unit.</p> <p>Separate the antenna from other cables and cords.</p>
---	---

When there is a television set nearby

<p>The picture on the TV disappears or stripes appear on the screen.</p>	<p>The location and orientation of the antenna are incorrect. If you are using an indoor antenna, change to an outdoor antenna. The TV antenna wire is too close to the unit. Separate the antenna wire of the TV set from the unit.</p>
---	--

Using the cassette deck

<p>Poor quality sound.</p> <p>Recording is not possible.</p>	<p>Clean the heads. ⑭</p> <p>If the erasure prevention tabs have been removed, cover the holes with adhesive tape. ⑫</p>
--	---



Playing discs

<p>The display is wrong or play won't start.</p>	<p>The disc may be upside down. 15 Wipe the disc. Replace the disc if it is scratched, warped, or non-standard. Condensation may have formed inside the unit due to a sudden change in temperature. Wait about an hour for it to clear and try again.</p>
<p>"TAKE OUT/DISC" appears on the display.</p>	<p>There is a problem with the disc mechanism. (A power failure may have occurred.) The tray will open automatically. Remove the disc from the tray, and after ensuring there is no disc in the tray, close it. The unit will make the disc changing noises for a few moments and then it should operate normally.</p>
<p>The picture does not appear on the TV, when playing DVD.</p>	<p>The region number of the disc doesn't match the region number of this unit. 5 Connect the video connection cable. 8, 9 Set the TV to video input mode.</p>
<p>The picture does not appear on the TV, when playing Video CD.</p>	<p>Connect the video connection cable. 8, 9 Set the TV to video input mode.</p>
<p>CD MANAGER, program and random play cannot be used.</p>	<p>Ensure a Video CD or CD is in the play position tray.</p>
<p>The initial settings menu cannot be accessed.</p>	<p>Select disc as the source. Cancel program and random play, or select "NORMAL" with CD MANAGER. 23, 24, 25</p>
<p>You have forgotten your ratings password.</p>	<p>Reset the unit to its original factory settings by doing the following procedure. 1 Press [] on the main unit and [>10] on the remote control at the same time for about 3 seconds until the message "Initialized" disappears from the television screen. 2 Turn the unit off and on again.</p>

The remote control

<p>The remote control doesn't work.</p>	<p>Check the batteries are inserted correctly. 6 Replace the batteries if they are worn.</p>
---	---

Maintenance

If the surfaces are dirty

To clean this unit, wipe with a soft, dry cloth.

If the surfaces are extremely dirty, use a soft cloth dipped in a soap-and-water solution or a weak detergent solution.

- Never use alcohol, paint thinner or benzine to clean this unit.
- Before using chemically treated cloth, read the instructions that came with the cloth carefully.

For a cleaner crisper sound

Clean the heads regularly to assure good quality playback and recording.

Use a cleaning tape (not included).

Product Service

Do not attempt to remove the cover(s) or repair the unit yourself. Refer servicing to qualified personnel only.

Product information

For product service, product information or assistance with product operation, refer to the servicer directory.

Panasonic

Technics

Quasar

*For Product Information, Operating Assistance, Literature Request, Dealer Locations, and all Customer Service inquiries please contact:
1-800-211-PANA (7262), Monday-Friday 9 am-9 pm; Saturday-Sunday 9 am-7 pm, EST.*

*Web Site: <http://www.panasonic.com>
You can purchase parts, accessories or locate your nearest servicer by visiting our Web Site.*

Accessory Purchases:

1-800-332-5368 (Customer Orders Only)
Panasonic Services Company 20421 84th Avenue South, Kent, WA 98032
(6 am to 5 pm Monday-Friday; 6 am to 10:30 am Saturday; PST)
(Visa, MasterCard, Discover Card, American Express, Check)

Factory Servicenters Locations

CALIFORNIA

6550 Katella Avenue
Cypress, CA 90630

800 Dubuque Avenue
S. San Francisco
CA 94080

20201 Sherman Way
Suite 102
Canoga Park, CA 91306

3878 Ruffin Road
Suite A
San Diego, CA 92123

COLORADO

1640 South Abilene Street
Suite D
Aurora, CO 80012

FLORIDA

3700 North 29th Avenue
Suite 102
Hollywood, FL 33020

GEORGIA

8655 Roswell Road
Suite 100
Atlanta, GA 30350

ILLINOIS

9060 Golf Road
Niles, IL 60714

1703 North Randall Road
Elgin, IL 60123
(Pick-up/Drop-off only)

MARYLAND

62 Mountain Road
Glen Burnie, MD 21061

MASSACHUSETTS

60 Glacier Drive
Suite G
Westwood, MA 02090

MICHIGAN

37048 Van Dyke Avenue
Sterling Heights, MI 48312

MINNESOTA

7850-12th Avenue South
Airport Business Center
Bloomington, MN 55425

OHIO

2236 Waycross Road
Civic Center Plaza
Forest Park, OH 45240

PENNSYLVANIA

2221 Cabot Blvd. West
Suite B
Langhorne, PA 19047

TENNESSEE

3800 Ezell Road
Suite 806
Nashville, TN 37211

TEXAS

13615 Welch Road
Suite 101
Farmers Branch
TX 75244

WASHINGTON

20425-84th Avenue South
Kent, WA 98032

HAWAII

99-859 Iwaiwa Street
Aiea, Hawaii 96701
Phone (808) 488-1996
Fax (808) 486-4369

References

Service in Puerto Rico

*Matsushita Electric of Puerto Rico, Inc. Panasonic Sales Company/Factory Servicer:
Ave. 65 de Infanteria, Km. 9.5, San Gabriel Industrial Park, Carolina, Puerto Rico 00985
Phone (787) 750-4300 Fax (787) 768-2910*

AMPLIFIER SECTION

Front speaker power output

For U.S.A.

RMS power output	
THD 1.0 %, both channels driven	
55 Hz–120 Hz	75 W per channel (6 Ω)
120 Hz–4 kHz	25 W per channel (6 Ω)
4 kHz–15 kHz	25 W per channel (6 Ω)
Total tri-amp power	125 W per channel

For others

PMPO power output	2700 W
RMS power output	
THD 10 %, both channels driven	
Total	160 W per channel (6 Ω)
LOW (at 100 Hz)	100 W per channel (6 Ω)
MID (at 1 kHz)	30 W per channel (6 Ω)
HIGH (at 10 kHz)	30 W per channel (6 Ω)

Power output in Dolby Pro Logic

For U.S.A.

RMS power output	
THD 1.0 %, both channels driven	
Front	
(at 55 Hz–120 Hz)	75 W per channel (6 Ω)
(at 120 Hz–15 kHz)	25 W per channel (6 Ω)
Center (at 1 kHz)	40 W (8 Ω)
Surround (at 1 kHz)	30 W per channel (8 Ω)
Total power output	300 W

For others

PMPO power output	Total 3200 W
RMS power output	
THD 10 %, both channels driven	
Total	400 W
Front	
LOW (at 100 Hz)	100 W per channel (6 Ω)
HIGH (at 1 kHz)	30 W per channel (6 Ω)
Center (at 1 kHz)	70 W (8 Ω)
Surround (at 1 kHz)	35 W per channel (8 Ω)

Input sensitivity

AUX	250 mV
Except for U.S.A., Australia and New Zealand	
MIC	0.7 mV

Input impedance

AUX	10 kΩ
Except for U.S.A., Australia and New Zealand	
MIC	600 Ω

FM TUNER SECTION

Frequency range

(For U.S.A.)	87.9–107.9 MHz (200 kHz step)
	87.5–108.0 MHz (100 kHz step)
(For others)	87.50–108.00 MHz (50 kHz step)

Sensitivity	1.8 μV (IHF)
S/N 26 dB	1.5 μV
Antenna terminals	75 Ω (unbalanced)

AM TUNER SECTION

Frequency range

(For U.S.A.)	520–1710 kHz (10 kHz step)
(For Australia and New Zealand)	522–1629 kHz (9 kHz step)
(For others)	522–1629 kHz (9 kHz step)
	520–1630 kHz (10 kHz step)

Sensitivity	
For U.S.A.	
S/N 20 dB at 1000 kHz	500 μV/m
For others	
S/N 20 dB at 999 kHz	500 μV/m

CASSETTE DECK SECTION

Track system	4 track, 2 channel
Heads	
Record/playback	Solid permalloy head
Erase	Double gap ferrite head
Motor	DC servo motor
Recording system	AC bias 100 kHz
Erasing system	AC erase 100 kHz
Tape speed	4.8 cm/s (1 7/8 ips)
Overall frequency response	
(+3, –6 dB at DECK OUT)	
NORMAL (TYPE I)	35 Hz–14 kHz
HIGH (TYPE II)	35 Hz–14 kHz
S/N ratio	50 dB (A_WTD)
Wow and flutter	0.18 % (WRMS)
Fast forward and rewind time	Approx. 120 seconds with C-60 cassette tape

DISC SECTION

Disc	
DVD-Video	
	8 cm/12 cm single-sided, single-layer
	8 cm/12 cm single-sided, double-layer
	8 cm/12 cm double-sided, double-layer
	(One layer per side)
Video CD/CD	8 cm/12 cm
Video	
Signal system	NTSC/PAL
(For Asia)	(depending on disc format)
(For Australia and New Zealand)	PAL/PAL60
	(depending on disc format)
(For U.S.A. and others)	NTSC
Output level	
	Composite video 1 Vp-p (75 Ω)
S-VIDEO Y	1 Vp-p (75 Ω)
S-VIDEO C	
(For Asia)	0.300 Vp-p (75 Ω/PAL)
	0.286 Vp-p (75 Ω/NTSC)
(For Australia and New Zealand)	0.300 Vp-p (75 Ω/PAL)
(For U.S.A. and others)	0.286 Vp-p (75 Ω/NTSC)

Audio

Sampling frequency	
CD	44.1 kHz
DVD	48 kHz/96 kHz
Decoding	16/20/24 bit linear
Wow and flutter	Below measurable limit
Digital filter	8 fs
D/A converter	Delta-sigma DAC
Pick up	
Beam Source	Semiconductor Laser
Wavelength	665 nm

SPEAKER SECTION

Front speakers SB-DK2

Type	3 way speaker system
Speakers	
Super woofer	17 cm (6 1/2") cone type
Woofer	12 cm (4 3/4") cone type
Tweeter	6 cm (2 3/8") cone type
Impedance	
HIGH	6 Ω
MID	6 Ω
LOW	6 Ω
Input power	
HIGH	60 W (Music)
MID	60 W (Music)
LOW	140 W (Music)
Output sound pressure level	87 dB/W (1.0 m)
Cross over frequency	150 Hz, 3.5 kHz
Frequency range	45 Hz–22 kHz (–16 dB)
	55 Hz–20 kHz (–10 dB)
Dimensions (WxHxD)	220x330x302 mm
	(8 27/32"x13"x11 7/8")
Mass	Approx. 4.7 kg (10.4 lb.)

Surround speakers SB-PS70

Type	1 way, 1 speaker
Speaker	
Full range	8 cm (3 1/8") cone type
Impedance	8 Ω
Input power	60 W (Music)
Output sound pressure level	84 dB/W (1.0 m)
Frequency range	120 Hz–20 kHz (–16 dB)
Dimensions (WxHxD)	170x106x118 mm
	(6 11/16"x4 3/16"x4 21/32")
Mass	Approx. 0.9 kg (2.0 lb.)

Center speaker SB-PC70

Type	2 way, 2 speaker
Speaker	
Woofer	10 cm (4") cone type
Tweeter	6 cm (2 3/8") cone type
Impedance	8 Ω
Input power	120 W (Music)
Output sound pressure level	85 dB/W (1.0 m)
Cross over frequency	4 kHz
Frequency range	75 Hz–22 kHz (–16 dB)
Dimensions (WxHxD)	250x121x147 mm
	(9 27/32"x4 3/4"x5 25/32")
Mass	Approx. 1.6 kg (3.5 lb.)

GENERAL

Power supply	
(For U.S.A.)	AC 120 V, 60 Hz
(For Australia and New Zealand)	AC 230–240 V, 50 Hz
(For others)	AC 110/127/220/230–240 V, 50/60 Hz
Power consumption	
(For U.S.A.)	240 W
(For Australia and New Zealand)	190 W
(For others)	190 W
Dimensions (WxHxD)	270x330x339 mm
	(10 5/8"x13"x13 1/2")
Mass	
(For U.S.A.)	Approx. 9.3 kg (20.5 lb.)
(For others)	Approx. 9.4 kg

Power consumption in standby mode

(For U.S.A.)	Normal: 14.5 W
	ECO: 0.25 W
(For Australia and New Zealand)	Normal: 15.0 W
	ECO: 0.4 W
(For others)	Normal: 15.0 W
	ECO: 0.8 W

Notes:

- Specifications are subject to change without notice. Mass and dimensions are approximate.
- Total harmonic distortion is measured by the digital spectrum analyzer.

The model number and serial number of this product can be found on either the back or the bottom of the unit. Please note them in the space provided below and keep for future reference.

	MODEL NUMBER	SERIAL NUMBER
Main unit	SA-DK2	_____
Front speakers	SB-DK2	_____
Center speaker	SB-PC70	_____
Surround speakers	SB-PS70	_____

User memo:

DATE OF PURCHASE	_____
DEALER NAME	_____
DEALER ADDRESS	_____
TELEPHONE NUMBER	_____

Apparatus Claims of U.S. Patent Nos. 4,631,603, 4,577,216, and 4,819,098, licensed for limited viewing uses only.

This product incorporates copyright protection technology that is protected by method claims of certain U.S. patents and other intellectual property rights owned by Macrovision Corporation and other rights owners. Use of this copyright protection technology must be authorized by Macrovision Corporation, and is intended for home and other limited viewing uses only unless otherwise authorized by Macrovision Corporation. Reverse engineering or disassembly is prohibited.

En

For U.S.A

**Panasonic Consumer Electronics
Company, Division of Matsushita
Electric Corporation of America**
One Panasonic Way Secaucus,
New Jersey 07094
<http://www.panasonic.com>

**Panasonic Sales Company,
Division of Matsushita Electric of
Puerto Rico, Inc. ("PSC")**
Ave. 65 de Infanteria, Km. 9.5
San Gabriel Industrial Park, Carolina,
Puerto Rico 00985

For others

Matsushita Electric Industrial Co., Ltd.
Osaka 542-8588, Japan