



ELECTRONIC ELECTRIC AND GAS DRYERS

Use & Care Guide

For questions about features, operation/performance, parts accessories or service call: 1-800-253-1301

In Canada, for assistance call: 1-800-461-5681 for installation and service call: 1-800-807-6777

or visit our website at... www.whirlpool.com or www.whirlpool.com/canada

SÉCHEUSES ÉLECTRIQUES ET À GAZ ÉLECTRONIQUES

Guide d'utilisation et d'entretien

Pour assistance, composer le 1-800-461-5681,
pour installation ou service le 1-800-807-6777

ou visitez notre site web à www.whirlpool.com/canada

Table of Contents/Table des matières.....

GGX 9868 JTO
GGX 9868 JQO

TABLE OF CONTENTS

DRYER SAFETY	3
PARTS AND FEATURES	5
CHECKING YOUR VENT	6
USING YOUR DRYER	7
Starting Your Dryer.....	7
Stopping, Pausing and Restarting.....	7
Loading Clothes.....	7
Drying, Cycle and Temperature Tips.....	8
CYCLE DESCRIPTIONS	8
Automatic Cycle(s).....	8
Timed Cycles.....	9
Favorite Cycle.....	9
Air Only Setting.....	9
Dryer Features.....	10
CARING FOR YOUR DRYER	10
Cleaning the Lint Screen.....	10
Cleaning the Dryer Interior.....	11
Removing Accumulated Lint from Inside the Dryer Cabinet.....	11
Changing the Drum Light.....	11
TROUBLESHOOTING	11
ASSISTANCE OR SERVICE	13
WARRANTY	14

TABLE DES MATIÈRES

SÉCURITÉ DE LA SÈCHEUSE	15
PIÈCES ET CARACTÉRISTIQUES	17
VÉRIFICATION DU CONDUIT D'ÉVACUATION	18
UTILISATION DE LA SÈCHEUSE	19
Mise en marche de la sècheuse.....	19
Arrêt, pause et remise en marche.....	19
Chargement des vêtements.....	20
Conseils pour séchage, programme et température.....	20
DESCRIPTION DES PROGRAMMES	20
Programme(s) automatique(s).....	20
Programmes minutés.....	20
Programme préféré (Favorite Cycle).....	20
Réglage à l'air seulement (Air Only).....	20
Caractéristiques de la sècheuse.....	20
Caractéristiques supplémentaires.....	20
ENTRETIEN DE LA SÈCHEUSE	20
Nettoyage du filtre à charpie.....	20
Nettoyage de l'intérieur de la sècheuse.....	20
Comment enlever la charpie accumulée de l'intérieur de la sècheuse.....	20
Changement de l'ampoule d'éclairage du tambour.....	20
DÉPANNAGE	20
ASSISTANCE OU SERVICE	20
GARANTIE	20

DRYER SAFETY

Your safety and the safety of others are very important.

We have provided many important safety messages in this manual and on your appliance. Always read and obey all safety messages.



This is the safety alert symbol.

This symbol alerts you to potential hazards that can kill or hurt you and others.

All safety messages will follow the safety alert symbol and either the word "DANGER" or "WARNING." These words mean:

⚠ DANGER

You can be killed or seriously injured if you don't immediately follow instructions.

⚠ WARNING

You can be killed or seriously injured if you don't follow instructions.

All safety messages will tell you what the potential hazard is, tell you how to reduce the chance of injury, and tell you what can happen if the instructions are not followed.

WARNING: For your safety, the information in this manual must be followed to minimize the risk of fire or explosion, or to prevent property damage, personal injury, or death.

- Do not store or use gasoline or other flammable vapors and liquids in the vicinity of this or any other appliance.
- **WHAT TO DO IF YOU SMELL GAS:**
 - Do not try to light any appliance.
 - Do not touch any electrical switch; do not use any phone in your building.
 - Clear the room, building, or area of all occupants.
 - Immediately call your gas supplier from a neighbor's phone. Follow the gas supplier's instructions.
 - If you cannot reach your gas supplier, call the fire department.
- Installation and service must be performed by a qualified installer, service agency, or the gas supplier.

IMPORTANT SAFETY INSTRUCTIONS

WARNING: To reduce the risk of fire, electric shock, or injury to persons when using the dryer, follow basic precautions, including the following:

- Read all instructions before using the dryer.
- Do not place items exposed to cooking oils in your dryer. Items contaminated with cooking oils may contribute to a chemical reaction that could cause a load to catch fire.
- Do not dry articles that have been previously cleaned in, washed in, soaked in, or spotted with gasoline, dry-cleaning solvents, other flammable, or explosive substances as they give off vapors that could ignite or explode.
- Do not allow children to play on or in the dryer. Close supervision of children is necessary when the dryer is used near children.
- Before the dryer is removed from service or discarded, remove the door to the drying compartment.
- Do not reach into the dryer if the drum is moving.
- Do not install or store the dryer where it will be exposed to the weather.
- Do not tamper with controls.
- Do not repair or replace any part of the dryer or attempt any servicing unless specifically recommended in this Use and Care Guide or in published user-repair instructions that you understand and have the skills to carry out.
- Do not use fabric softeners or products to eliminate static unless recommended by the manufacturer of the fabric softener or product.
- Do not use heat to dry articles containing foam rubber or similarly textured rubber-like materials.
- Clean lint screen before or after each load.
- Keep area around the exhaust opening and adjacent surrounding areas free from the accumulation of lint, dust, and dirt.
- The interior of the dryer and exhaust vent should be cleaned periodically by qualified service personnel.
- See Installation Instructions for grounding requirements.

SAVE THESE INSTRUCTIONS

PARTS AND FEATURES

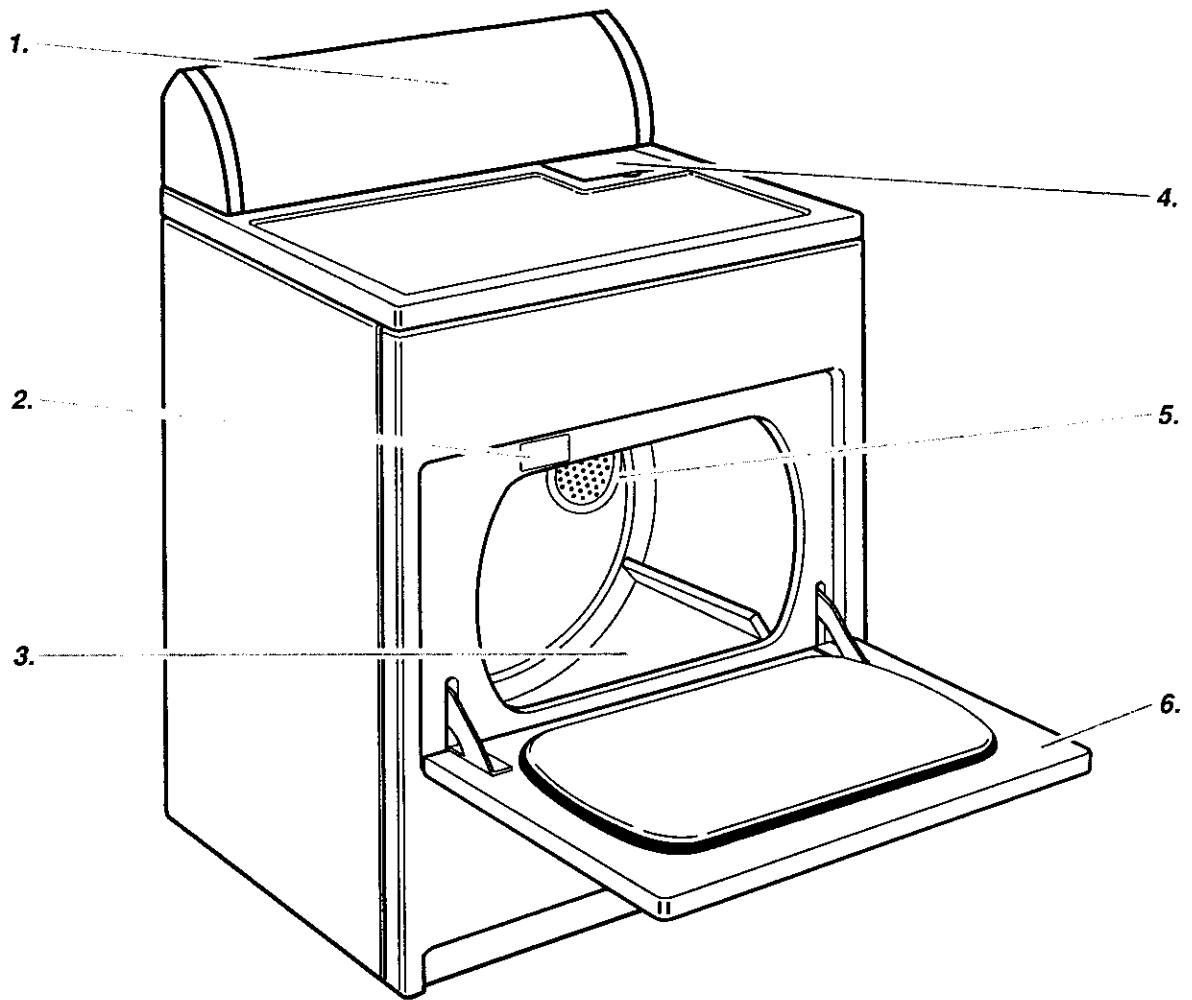

1. Control panel
2. Model and serial number label
3. Dryer drum
4. Lint screen
5. Exhaust grill
6. Wide-opening door

Additional features your dryer has:

- End of Cycle Signal selector
- WRINKLE SHIELD™ selector
- SENSEON™ electronic sensor
- Drying rack
- Drum light

CHECKING YOUR VENT

Your dryer must be properly installed and vented to achieve maximum drying efficiency and shorten drying times. Use the minimum recommended installation clearances (found in your Installation Instructions) to avoid blocking the flow of combustion and ventilation air. Refer to your Installation Instructions for more information.

⚠ WARNING



Fire Hazard

Use a heavy metal vent.

Do not use a plastic vent.

Do not use a metal foil vent.

Failure to follow these instructions can result in death or fire.

If the dryer is not properly installed and vented, it will not be covered under the warranty.

NOTE: Service calls caused by improper venting will be paid for by the customer, whether it was a paid installation or self-installed.

1. **Do not** use plastic vent or metal foil vent. Use 4 in (10.2 cm) metal or flexible metal vent. Do not kink or crush flexible metal vent. It must be completely extended to allow adequate exhaust air to flow. Check vent after installation. Refer to your Installation Instructions for proper length requirements of vent.

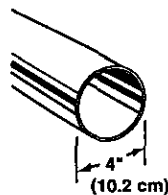

2. Use a 4 in (10.2 cm) exhaust hood. Smaller hoods increase drying times.

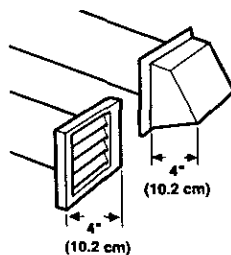

3. The exhaust vent can be routed up, down, left, right, or straight out the back of the dryer. Space requirements are listed in your Installation Instructions.

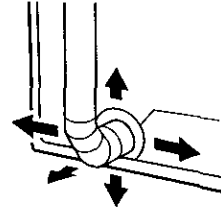

4. Use the straightest path possible when routing the exhaust vent. Use the fewest number of elbows and turns. Allow room when using elbows or making turns. Bend vent gradually to avoid kinking.

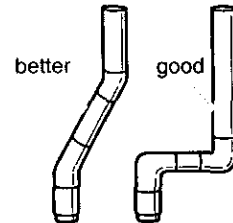

5. Use duct tape to seal all joints. **Do not** use screws to secure vent. Lint may catch on screws.

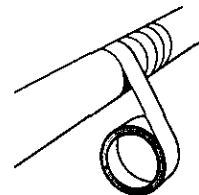

6. Clean exhaust vent periodically, depending on use, but at least every 2 years, or when installing your dryer in a new location.

- Disconnect vent from the dryer and clean one section at a time until you reach the exhaust hood.

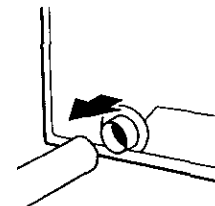

- Use the hose attachment on your vacuum, or a pole or wire with a feather duster or rag attached, to clean out lint.
- Be sure the flapper on the outside end of vent moves freely.
- When cleaning is complete, be sure to follow the Installation Instructions supplied with your dryer for final product check.

USING YOUR DRYER

⚠ WARNING



Explosion Hazard

Keep flammable materials and vapors, such as gasoline, away from dryer.

Do not dry anything that has ever had anything flammable on it (even after washing).

Failure to follow these instructions can result in death, explosion, or fire.

⚠ WARNING



Fire Hazard

No washer can completely remove oil.

Do not dry anything that has ever had any type of oil on it (including cooking oils).

Items containing foam, rubber, or plastic must be dried on a clothesline or by using an Air Cycle.

Failure to follow these instructions can result in death or fire.

Starting Your Dryer

Before using your dryer, wipe the dryer drum with a damp cloth to remove dust from storing and shipping. The following steps provide an overview for operating your dryer. Specific directions for each step are contained in the following sections.

1. Load clothes loosely into the dryer and close the door. Do not pack the dryer. Allow space for clothes to tumble freely.



2. Select one of the Automatic or Timed Cycles. Use the Heavy Duty or Normal cycles to dry most heavyweight and medium weight loads. (See "Cycle Descriptions.")



3. For Automatic Cycles, select one of the five levels of dryness by pressing the up or down arrows. (See "Cycle Descriptions")
4. For Timed Cycles only, select one of six temperature settings. (See "Cycle Descriptions")
5. Select the WRINKLE SHIELD™ setting, if desired. (See "Additional Features")
6. Select the End of Cycle Signal, if desired. The signal is helpful when drying permanent press or synthetics. Promptly remove these items from the dryer at the end of the cycle to prevent wrinkles. (See "Additional Features".)
7. Push the START pad.

Stopping, Pausing and Restarting

You can stop your dryer anytime during a cycle.

To stop your dryer

Press PAUSE/CANCEL twice.

To restart your dryer

1. Close the door.
2. Select a new cycle and temperature (if an option with your cycle.)
3. Push START.

To pause your dryer

Open the door or press PAUSE/CANCEL once. Press START to resume the cycle. Dryer will stop if more than five minutes have elapsed since the dryer was stopped.

Loading Clothes

Load clothes loosely into the dryer. Do not pack the dryer. Allow space for clothes to tumble freely. The following chart shows examples of balanced loads that would allow for proper tumbling.

Heavy work clothes	3 pair of pants, 4 pair of jeans, 2 pair of overalls, 3 shirts
Delicates	3 camisoles, 1 robe, 4 slips, 6 undergarments, 2 sets of sleepwear, 1 child's outfit
Towels	10 bath towels, 10 hand towels, 14 wash cloths, 1 bath mat
Mixed Load	3 double sheets, 4 pillowcases, 8 T-shirts, 6 pair of shorts, 2 blouses, 8 handkerchiefs

Drying, Cycle and Temperature Tips

Select the correct cycle and temperature for your load.

Dryer tips

- Press firmly in the center of the pad.
- The indicator light next to the pad will light up when a selection is valid.
- A short tone will sound when a selection is valid.
- Three short tones will sound when a selection is not valid.
- After your first use, your dryer "remembers" the Dryness level, WRINKLE SHIELD™ setting and End of Cycle Signal setting you selected.
- If you press and hold the pad with either the Temperature selector, the End of Cycle Signal selector or the More Dry or Less Dry arrows, you will advance the settings.
- If you press and hold the Less Time or More Time arrows in the Timed Cycles, the time will advance in five minute intervals.

Drying tips

- Follow care label directions when they are available.
- If you use fabric softener sheets, use only ones labeled as "dryer safe." Follow package instructions.
- Remove the load from the dryer as soon as tumbling stops to reduce wrinkling. This is especially important for permanent press, knits, and synthetic fabrics.
- Cool Down tumbles the load without heat during the last few minutes of all cycles. Cool Down makes the loads easier to handle.

Cycle tips

- Use the Timed Dry cycle with the Air Only (no heat) Temperature setting for rubber, plastic or heat sensitive fabrics.

Temperature tips

If your dryer has multiple heat settings:

- Use a high heat setting for drying heavyweight items such as towels and work clothes.
- Use a medium heat setting for drying medium-weight items such as sheets, underwear, permanent press fabrics, and some knits.
- Use a low heat setting for drying lightweight items such as lingerie, blouses, dresses, and some knits.
- Use a no heat (air) setting for rubber, plastic or heat sensitive fabrics.
- Line dry bonded or laminated fabrics.

If you are unsure of the temperature to select for a load, select the lower setting rather than the higher setting

NOTE: If you have questions about drying temperatures for various loads, refer to the care label directions.

CYCLE DESCRIPTIONS

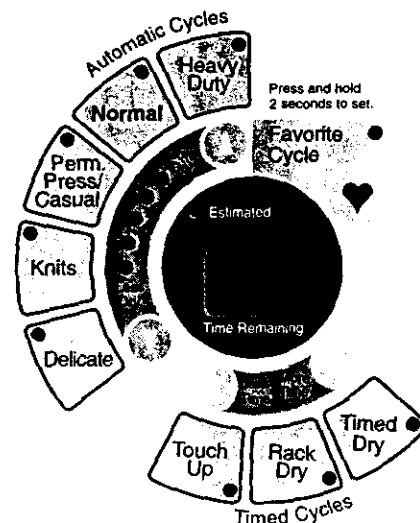

Automatic Cycle(s)

Use your Automatic Cycles to dry most loads. Your dryer uses the SENSEON™ Drying System. Electronic sensors measure the temperature of the exhaust to increase or decrease drying temperatures for faster reaction time and tighter temperature control. Your two most frequently used cycles, Heavy Duty and Normal, are enhanced with the SENSEON system to provide the shortest drying time.

After drying a load in any of the Automatic Cycles, check the dryness.

- If the load is drier than you like, press the down arrow to select a setting closer to Less Dry the next time you dry a similar load.
- If a load is not as dry as you like, complete drying using a Timed cycle. Press the Up arrow to select a setting closer to More Dry the next time you dry a similar load.

NOTE: The Up and Down arrows are located next to the Automatic Cycles pads.

To use the Automatic Cycles

1. Press the desired AUTOMATIC CYCLES pad.
2. Press the Up or Down arrows to select from five levels of More Dry or Less Dry, if desired.
3. Select the WRINKLE SHIELD™ setting, if desired.
4. Press the Bell symbol to select the End of Cycle Signal Volume.
5. Press START.

NOTE: The Estimated drying time varies from the actual drying time with an Automatic cycle. The type of fabric, size of the load, and the dryness selected affect drying time. See "Drying, Cycle and Temperature tips."

Heavy Duty with the SENSEON™ Drying System

Select this cycle to thoroughly dry heavyweight items such as, jeans, corduroys or work clothes. The temperature is automatically set at High.

Normal with the SENSEON™ Drying System

Select this cycle to evenly dry sturdy casual clothes such as, khakis and cotton jerseys. The temperature is automatically set at Medium High.

Permanent Press/Casual

Select this cycle to dry medium to lightweight synthetic or no-iron items such as, sheets, shirts or dresses. The temperature is automatically set at Medium.

Knits

Select this cycle to gently dry washable knit items such as, blouses, sweaters and lingerie. The temperature is automatically set at Low.

Delicates

Select this cycle to extra gently dry heat-sensitive items such as, exercise wear, sheer curtains or lace. The temperature is automatically set at Extra Low.

Timed Cycles

Your dryer has three Timed Cycles: Touch Up, Rack Dry and Timed Dry. Each cycle has a preset time and temperature setting. You can customize your Timed Cycles by adding options.

NOTE: If the load is not wet, several of the Drying Status lights will not be activated when using the Timed Cycles.

To add options to the Timed Cycles

1. Press the desired TIMED CYCLES pad.
2. Press the MORE TIME arrow to select more time, or press the LESS TIME arrow to deselect time.
3. Press the TIMED CYCLES SELECT pad to select a temperature.

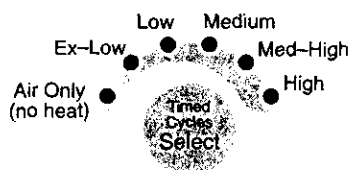

Temperature

4. Select the WRINKLE SHIELD™ setting, if desired.
5. Press the Bell symbol to select the End of Cycle Signal, if desired.
6. Press START.

Timed Dry

Use your Timed Dry cycle to complete drying if items are still damp after the Automatic cycle.

Select Timed Dry to thoroughly dry extra heavyweight and bulky items such as, bedspreads, quilts and mattress pads or large loads that require a long drying time. You may also use the Timed Dry cycle for lightweight items such as lingerie or knits.

The Timed Dry cycle is preset to 40 minutes at High heat. You can select a different time or temperature, if desired.

Touch Up

Use your Touch Up cycle to remove wrinkles from clean clothes packed tightly in a suitcase or closet. You can also use Touch Up to complete dry if items are still damp after the Automatic cycle.

The Touch Up cycle is preset to 20 minutes at Medium High heat. You can select a different time or temperature, if desired.

Rack Dry

Use your Rack Dry cycle with the drying rack to dry items that do not require tumbling.

The Rack Dry cycle is preset to 30 minutes at Medium Heat. (See "Drying Rack".) Items containing foam, rubber, or plastic must be dried on a clothesline or by using an Air Cycle.

NOTE: The Drying Status lights will not operate during the Rack Dry cycle. The WRINKLE SHIELD™ setting is not a selectable option with the Rack Dry Cycle.

Favorite Cycle

Use the Favorite Cycle to select the cycle, amount of added drying time, temperature (on Timed Cycles ONLY) and the options of the WRINKLE SHIELD™ setting or End of Cycle signal you use most frequently and store them for future use.

To store a cycle for future use with the Automatic Cycles

1. Select an Automatic Cycle.
2. Select one of five levels of dryness by pressing the up or down arrows.
3. Select the WRINKLE SHIELD setting, if desired.
4. Select the volume on the End of Cycle Signal, if desired.
5. Press the Heart symbol and hold for 2 seconds until you hear a beep.
6. Press START.

To reuse this cycle

1. Press the Heart symbol.
2. Press START.

To store a cycle for future use with the Timed Cycles

1. Select a Timed Cycle.
2. Select the number of minutes of drying by pressing the More Time or Less Time arrows.
3. Select one of six temperature settings by pressing the Timed Cycles Select pad.
4. Select the WRINKLE SHIELD setting, if desired.
5. Select the volume on the End of Cycle Signal, if desired.
6. Press the Heart symbol and hold for 2 seconds until you hear a beep.
7. Press START.

To reuse this cycle

1. Press the Heart symbol.
2. Press START.

Air Only Setting

Use the Air Only setting for items that require drying without heat such as rubber, plastic and heat sensitive fabrics. Press the Timed Dry cycle and select Air Only on the temperature selector. This chart shows examples of items that can be dried using the Air Only setting.

Type of Load	Air Only setting*
Foam rubber - pillows, padded bras, stuffed toys	20 - 30
Plastic - Shower curtains, tablecloths	20 - 30
Rubber-backed rugs	40 - 50
Olefin, polypropylene, sheer nylon	10 - 20

(*Minutes) Reset cycle to complete drying, if needed.

When using Air Only

- Check to see that coverings are securely stitched.
- Shake and fluff pillows by hand periodically during cycle.
- Dry item completely. Foam rubber pillows are slow to dry.

Dryer Features

Time Display

When you select an Automatic cycle, the estimated time is displayed in the Time Remaining window and the Estimated light is lit. After the Damp light is lit on the Drying Status bar, the Estimated light will go off. Then, the Time Remaining window will show the actual time remaining.

When you select a Timed cycle, the actual time is displayed in the Time Remaining window.

Drying Status Lights

You can monitor the progress of your load with the Drying Status lights.

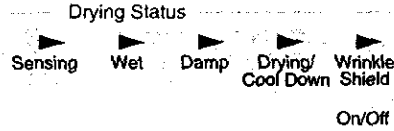

- **Sensing**
The Sensing light flashes at the start of the load when the electronic moisture sensor is searching for wetness.
- **Wet**
Once the moisture sensor detects wetness in the load, the Wet light flashes until the moisture sensor can no longer detect wetness in the clothes.
- **Damp**
The Damp light flashes after the moisture sensor no longer detects wetness in the clothes. At this point, the clothes are approximately 80% dry. You may want to remove lightweight items in a mixed load to prevent overdrying or remove partially dry items to hang up to save on ironing. The Damp light will flash for approximately two minutes.
- **Drying/Cool Down**
The Drying/Cool Down light will continue to flash until Cool Down is completed. The Drying/Cool Down light will also flash if a Timed Cycle has been selected and the Sensing light does not detect any moisture in the clothes.
- **WRINKLE SHIELD™**
The WRINKLE SHIELD™ setting light is lit when it is selected. The light flashes after the Cool Down period is complete. The WRINKLE SHIELD setting light will continue to flash until the clothes are removed or the 120 minutes of the WRINKLE SHIELD system have expired.

Additional Features

You can customize your cycles by selecting different features. If you change your mind, select a different feature.

WRINKLE SHIELD™ setting

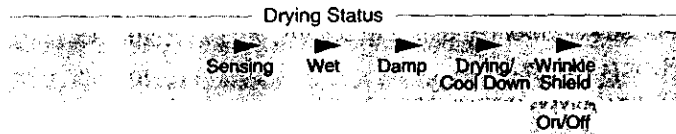

When you are unable to remove a load of clothes from the dryer as soon as it stops, wrinkles can form. The WRINKLE SHIELD setting periodically tumbles, rearranges and fluffs the load to avoid wrinkles.

Select the WRINKLE SHIELD setting by pressing the On/Off pad on the Drying Status bar. The WRINKLE SHIELD setting periodically tumbles the load without heat for up to 120 minutes.

End of Cycle Signal

If the End of Cycle Signal is selected, the signal sounds when a cycle is complete. If WRINKLE SHIELD™ is selected, the signal sounds every few minutes. The signal stops when you open the door.

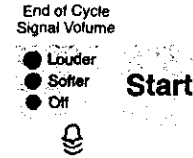

Press the Bell symbol to select a Softer or Louder signal or to turn the End of Cycle Signal off.

Drying Rack

Select this feature to dry items such as tennis shoes and pillows without tumbling. The drum turns, but the rack does not move.

To use the drying rack

1. Slide rear pegs into the dimples on the back wall of the dryer. Lower the front legs to rest on the dryer opening.

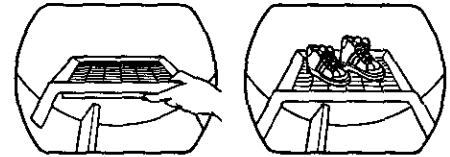

2. Put the wet items on top of the rack. Leave space between the items so air can reach all the surfaces. Close the door.
NOTE: Do not allow items to hang over the edge of the rack.
3. Select the Rack Dry cycle. Press the MORE TIME or LESS TIME arrows, if desired. Press the TIMED CYCLES SELECT pad to select a temperature. Items containing foam, rubber, or plastic must be dried on a clothesline or by using an Air Cycle. Press the START pad.

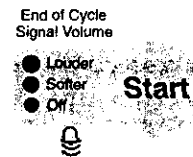

NOTE: You must remove rack for normal tumbling. Do not use automatic cycles with the drying rack.

This chart shows examples of items that can be rack dried. After selecting the Rack Dry cycle, select the temperature setting and drying time across from each item.

Rack Dry	Temp	Time*
Wool Sweaters		
Block to shape and lay flat on the rack	Low	60
Stuffed toys or pillows		
Cotton or polyester fiber filled	Low	60
Stuffed toys or pillows		
Foam rubber filled	Air Only	90
Sneakers or canvas shoes		
	Air Only	90

*(Minutes) Reset cycle to complete drying, if needed. (Drying time will depend on amount of moisture items hold).

NOTE: If your model does not have a drying rack you can order one by calling: (in the USA) 1-800-253-1301 or (in Canada) 1-800-807-6777 or by contacting the dealer from whom you bought your appliance.

CARING FOR YOUR DRYER

Cleaning the Lint Screen

Every load cleaning

The lint screen is located on the top of the dryer. Clean it before each load. A screen blocked by lint can increase drying time.

To clean

1. Pull the lint screen towards you. Roll lint off the screen with your fingers. Do not rinse or wash screen to remove lint. Wet lint is hard to remove.

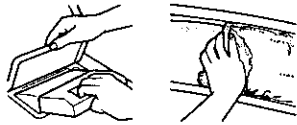

2. Push the lint screen firmly back into place.

IMPORTANT:

- Do not run the dryer with the lint screen loose, damaged, blocked, or missing. Doing so can cause overheating and damage to both the dryer and fabrics.
- Some towels made of synthetic fibers and natural fibers (polyester and cotton blends) may shed more lint than other towels, causing your dryer's lint screen to fill up faster. Be sure to remove lint from the lint screen before and after drying new towels.
- If lint falls off the screen into the dryer during removal, check the exhaust hood and remove the lint. (See "Checking Your Vent".)

As needed cleaning

Laundry detergent and fabric softener residue can buildup on the lint screen. This buildup can cause longer drying times for your clothes, or cause the dryer to stop before your load is completely dry. The screen is probably clogged if lint falls off the screen.

Clean the lint screen with a nylon brush every six months or more frequently if it becomes clogged due to a residue buildup.

To wash

1. Wet both sides of lint screen with hot water.
2. Wet a nylon brush with hot water and liquid detergent. Scrub lint screen with the brush to remove residue buildup.

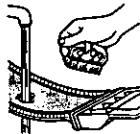

3. Rinse screen with hot water.
4. **Thoroughly** dry lint screen with a clean towel. Replace screen in dryer.

Cleaning the Dryer Interior

⚠ WARNING



Explosion Hazard

Use nonflammable cleaner.

Failure to do so can result in death, explosion, or fire.

To clean dryer drum:

1. Make a paste with powdered laundry detergent and very warm water.
2. Apply paste to a soft cloth.

OR

Apply a liquid, non-flammable household cleaner to the stained area and rub with a soft cloth until all excess dye is removed.

3. Wipe drum thoroughly with a damp cloth.
4. Tumble a load of clean cloths or towels to dry drum.

NOTE: Garments which contain unstable dyes such as denim blue jeans or brightly colored cotton items, may discolor the dryer interior. These stains are not harmful to your dryer and will not stain future loads of clothes. Dry unstable dye items inside out to prevent dye transfer.

Removing Accumulated Lint from Inside the Dryer Cabinet

Lint should be removed every two years, or more often, depending on dryer usage. Cleaning should be done by a qualified person.

Changing the Drum Light

If your dryer has a drum light, the dryer light automatically turns on inside the dryer drum when you open the door.

To change the drum light

1. Unplug dryer or disconnect power.
2. Open the dryer door. Locate the light bulb cover on the back wall of the dryer. Remove the screw located in the lower right corner of the cover. Remove the cover.

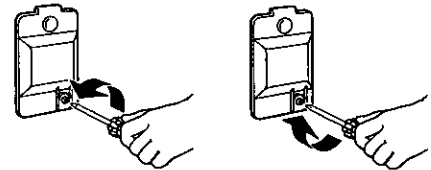

3. Turn bulb counterclockwise. Replace the bulb with a 10-watt appliance bulb only. Replace the cover.
4. Plug in dryer or reconnect power.

TROUBLESHOOTING

First try the solutions suggested here and possibly avoid the cost of a service call...

Message Codes

- **For error message "PF" (power failure), check the following:**
 - Is the dryer connected to the power supply?
 - Was the dryer connected to a power supply during installation or a power failure?
Press START to resume operation or press PAUSE/CANCEL to cancel the cycle.
 - Was the drying cycle interrupted by a power failure?
Press START to resume operation or press PAUSE/CANCEL to cancel the cycle.
 - **For error message "E1" or "E2" (service codes):**
 - Service is required, call for service.
-

Clothes are not drying satisfactorily

- **Check the following:**
 - Is the lint screen clogged with lint?
 - Is the exhaust vent or outside exhaust hood clogged with lint, restricting air movement? Run the dryer for 5-10 minutes. Hold your hand under the outside exhaust hood to check air movement. If you do not feel air movement, clean exhaust system of lint or replace exhaust vent with a heavy metal vent. See your Installation Instructions.
 - Is the exhaust vent crushed or kinked? Replace with a heavy metal vent. See your Installation Instructions.
 - Has a fuse blown, or a circuit breaker tripped? Electric dryers use 2 household fuses or breakers. The drum may be turning but you may not have heat.
 - Has an Air Dry cycle been selected? Select the right cycle for the types of garments being dried (see "Drying, Cycle and Temperature Tips").
 - Is the automatic cycle ending early? The load may not be contacting the electronic sensor strips, level the dryer.
 - For gas dryers, is the valve open on the supply line?
Are fabric softener sheets blocking the grill? Use only one fabric softener sheet and only use it once.
 - **Is the dryer located in a room with temperature below 45°F (7°C)?**
 - Proper operation of dryer cycles requires temperatures above 45°F (7°C).
 - **Was a cold rinse water used? Was the load very wet?**
 - Expect longer drying times with items rinsed in cold water and with items that hold moisture (cottons).
 - **Is the load too large and heavy to dry quickly?**
 - Separate the load to tumble freely.
-

Dryer will not run

- **Check the following:**
 - Is the power cord plugged in?
 - Has a fuse blown, or has circuit breaker tripped?
 - Was a regular fuse used? Use a time-delay fuse.
 - Is the dryer door firmly closed?
 - Was the START pad firmly pressed?
 - Is a cycle selected?
-

Unusual sounds

- **Has the dryer had a period of non-use?**
 - If the dryer hasn't been used for a while, there may be a thumping sound during the first few minutes of operation.
 - **Is it a gas dryer?**
 - The gas valve clicking is a normal operating sound.
-

Lint on load

- **Is the lint screen clogged?**
 - Clean lint screen. Check for air movement.
 - **Is load properly sorted?**
 - Sort lint givers (towels, chenille) from lint takers (corduroy, synthetics). Also sort by color.
 - **Is the load too big or too heavy?**
 - Dry smaller loads so lint can be carried to the lint screen.
 - **Was the load overdried?**
 - Use correct dryer settings for load type. (See "Drying, Cycle and Temperature Tips".) Overdrying can cause lint-attracting static electricity.
 - **Was paper or tissue left in pockets?**
 - Clean out pockets before drying.
 - **Is pilling being mistaken for lint?**
 - Pilling (surface fuzz) is caused by normal wear and laundering.
-

Stains on load or color change

- **Was dryer fabric softener properly used?**
 - Add dryer fabric softener sheets at the beginning of the cycle when the load is cold. Do not add fabric softener sheets to a warm load.
 - **Were items soiled when placed in the dryer?**
 - Items should be clean before being dried.
 - **Were items properly sorted?**
 - Sort light colors from dark colors. Sort colorfast items from noncolorfast items.
-

Items shrinking

- **Was the dryer overloaded?**
 - Dry smaller loads that can tumble freely.
 - **Did the load overdry?**
 - Check the manufacturer's care label. Match dryer setting to load type (See "Drying, Cycle and Temperature Tips").
-

Loads are wrinkled

- **Was load removed from dryer at the end of the cycle?**
Remove load as soon as tumbling stops.
- **Was dryer overloaded?**
Dry smaller loads that can tumble freely.
- **Did the load overdry?**
Check the manufacturer's care label. Match dryer setting to load type. (see "Drying, Cycle and Temperature Tips").

Odors

- **If the dryer is electric, is it being used for the first time?**
The new electric heating element may have an odor. The odor will be gone after the first cycle.
- **If the dryer is gas, there may be a gas leak:**
Turn off the gas supply line, leave your house and then call your local gas company.
- **Have you recently been painting, staining or varnishing in the area where your dryer is located?**
If so, ventilate the area. When the odors or fumes are gone from the area, re-wash the clothing and then dry it.

Garment damage

- **Check the following:**
Were zippers, snaps, and hooks left open?
Were strings and sashes tied to prevent tangling?
Were care label instructions followed?
Were items damaged before drying?

ASSISTANCE OR SERVICE

Before calling for assistance or service, please check "Troubleshooting." It may save you the cost of a service call. If you still need help, follow the instructions below.

When calling, please know the purchase date and the complete model and serial number of your appliance. This information will help us to better respond to your request.

If you need replacement parts

If you need to order replacement parts, we recommend that you only use FSP® factory specified parts. These parts will fit right and work right because they are made with the same precision used to build every new WHIRLPOOL GOLD® appliance. To locate factory specified replacement parts in your area, call our Customer Interaction Center (in the U.S.A.) or your nearest designated service center.

In the U.S.A

Call the Whirlpool Customer Interaction Center toll free: **1-800-253-1301**.

Our consultants provide assistance with:

- Features and specifications on our full line of appliances.
- Installation information.
- Use and maintenance procedures.
- Accessory and repair parts sales.
- Specialized customer assistance (Spanish speaking, hearing impaired, limited vision, etc.).
- Referrals to local dealers, repair parts distributors, and service companies. Whirlpool designated service technicians are trained to fulfill the product warranty and provide after-warranty service, anywhere in the United States.

To locate the Whirlpool designated service company in your area, you can also look in your telephone directory Yellow Pages.

For further assistance

If you need further assistance, you can write to Whirlpool with any questions or concerns at:

Whirlpool Corporation
Customer Interaction Center
c/o Correspondence Dept.
MD 8020
553 Benson Road
Benton Harbor, MI 49022-2400

Please include a daytime phone number in your correspondence.

In Canada

Call the Inglis customer relations Center toll free:

1-800-461-5681 8:30 a.m. - 6:00 p.m. (EST)

Our consultants provide assistance with:

- Features and specifications on our full line of appliances.
- Referrals to local dealers.

For service in Canada

Call **1-800-807-6777**. Inglis Limited designated service technicians are trained to fulfill the product warranty and provide after-warranty service, anywhere in Canada.

For further assistance

If you need further assistance, you can write to us with any questions or concerns at:

Consumer Relations Center
Inglis Limited
1901 Minnesota Court
Mississauga, Ontario L5N 3A7

Please include a daytime phone number in your correspondence.

WHIRLPOOL GOLD® DRYER WARRANTY

ONE-YEAR FULL WARRANTY

For one year from the date of installation, when this dryer is operated and maintained according to instructions attached to or furnished with the product, Whirlpool Corporation will pay for FSP® replacement parts and repair labor to correct defects in materials or workmanship. Service must be provided by a Whirlpool designated service company.

FOUR YEAR LIMITED WARRANTY

For the second through the fifth years from the date of purchase, when this dryer is operated and maintained according to instructions attached to or furnished with the product, Whirlpool Corporation will pay for FSP replacement parts to replace the electronic control system if defective in materials or workmanship.

Whirlpool Corporation will not pay for:

1. Service calls to correct the installation of your dryer, including venting. Heavy 4 in (10.16 cm) metal exhaust vent must be used. Refer to the venting section of this manual and your Installation Instructions.
2. Service calls to instruct you how to use your dryer, to replace house fuses or correct house wiring or reset circuit breakers, or to replace owner accessible light bulbs.
3. Repairs when your dryer is used in other than normal, single-family household use.
4. Damage resulting from accident, alteration, misuse, abuse, fire, floods, acts of God, improper installation (including, but not limited to, venting with plastic or flexible foil), installation not in accordance with local electrical and plumbing codes, or use of products not approved by Whirlpool Corporation.
5. Replacement parts or repair labor costs for units operated outside the United States and Canada.
6. Pickup and delivery. This product is designed to be repaired in the home.
7. Repairs to parts or systems resulting from unauthorized modifications made to the appliance.
8. In Canada, travel or transportation expenses for customers who reside in remote areas.
9. Any labor costs incurred during the Four Year Limited Warranty.

WHIRLPOOL CORPORATION AND INGLIS LIMITED SHALL NOT BE LIABLE FOR INCIDENTAL OR CONSEQUENTIAL DAMAGES.

Some states or provinces do not allow the exclusion or limitation of incidental or consequential damages, so this exclusion or limitation may not apply to you. This warranty gives you specific legal rights and you may also have other rights which vary from state to state or province to province.

Outside the 50 United States, and Canada, this warranty does not apply. Contact your authorized Whirlpool dealer to determine if another warranty applies.

If you need service, first see "Troubleshooting." Additional help can be found by checking "Assistance or Service," or by calling our Customer Interaction Center at 1-800-253-1301, from anywhere in the U.S.A. or write: Whirlpool Corporation, Customer Interaction Center, c/o Correspondence Dept., MD 8020, 553 Benson Road, Benton Harbor, MI 49022-2400. For service in Canada, call Inglis Limited at 1-800-807-6777.

01/01

Keep this book and your sales slip together for future reference. You must provide proof of purchase or installation date for in-warranty service.

Write down the following information about your dryer to better help you obtain assistance or service if you ever need it. You will need to know your complete model number and serial number. You can find this information on the model and serial number label/plate, located on your appliance as shown in "Parts and Features."

Dealer name _____
Address _____
Phone number _____
Model number _____
Serial number _____
Purchase date _____