

# SEARS

Model No. 831.280750

EXERCISE  
EQUIPMENT

QUESTIONS

HELPLINE!

1-800-736-6879

Patent Pending

## CAUTION

Read all precautions and instructions in this manual before using this equipment. Keep this manual for future reference.

# WEIDER<sup>®</sup> ABShaper

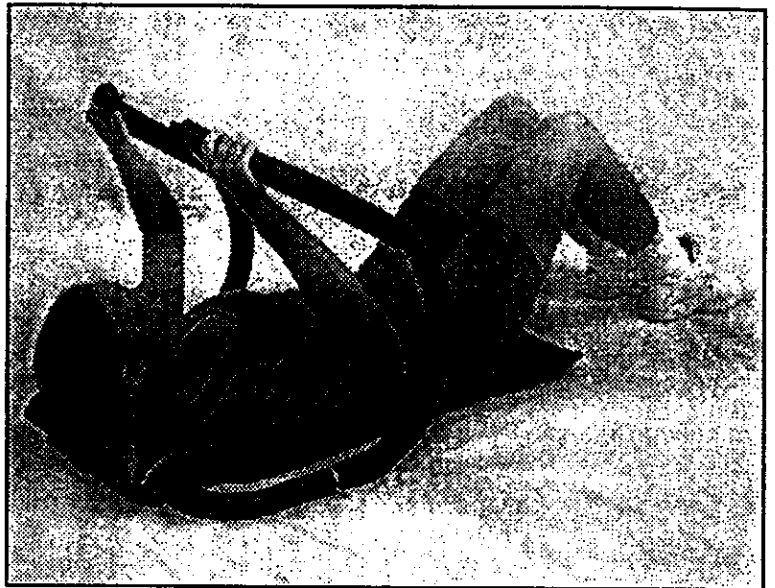

## USER'S MANUAL

SEARS, ROEBUCK AND CO., HOFFMAN ESTATES, IL 60179

## Intermediate Exercises—Cont.

### 6. Raised-knee Oblique Crunch

This exercise focuses on the oblique abdominals.

Bend your knees, lay them to one side, and hold your legs just off the floor.

Curl up to about a 45° angle, then return to the starting position. Hold your legs stationary throughout the exercise. Complete 5 to 7 repetitions, change your knees to the opposite side, and then perform another 5 to 7 repetitions.



## Advanced Exercises

The following exercises are designed to further improve your strength, tone, and flexibility. Remember to stretch for a few minutes before you begin.

### 7. "L"-Crunch

This exercise is for the upper abdominals.

Straighten your legs and raise them as shown. Curl up to about a 45° angle, and then lower yourself to the starting position. Keep your legs raised throughout the exercise.

Complete 10 to 15 repetitions.



## Advanced Exercises—Cont.

### 8. Advanced Raised-knee Crunch

This exercise focuses on the lower abdominals.

Straighten your legs and hold them just off the floor as shown in photograph 8a. Curl up to about a 45° angle, bringing your knees toward your chest as shown in photograph 8b; then return to the starting position.

Complete 10 to 15 repetitions.

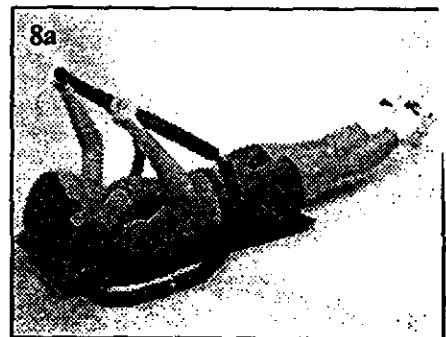

### 9. Advanced Oblique Leg Crunch

This exercise targets the oblique abdominals. Straighten your legs and hold them just off the floor as shown in photograph 9a. Curl up to about a 45° angle, bending your knees and bringing them to the side as shown in photograph 9b; then return to the starting position.

Complete 10 to 15 repetitions, alternating sides with each repetition.

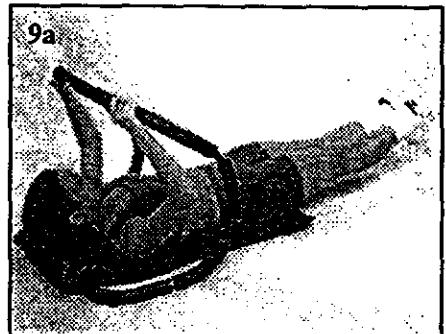

## Storage and Maintenance

The instructions on the opposite side of this manual show how the AB SHAPER is used. When you are not using the AB SHAPER, it can be folded and stored under a bed. The AB SHAPER will even fit into the trunk of your car for easy transport. Follow the instructions below to fold the AB SHAPER to the storage position.

1. Hold one of the handles with one hand, and hold the frame with the other hand. Firmly pull back the handle.

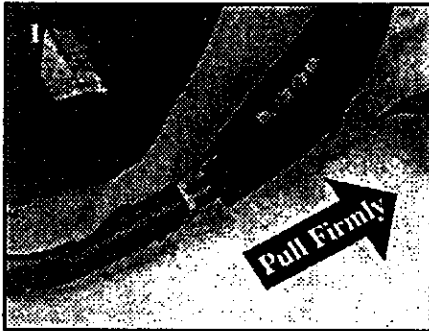

2. Rotate the handle down.

Rotate the other handle down in the same way.

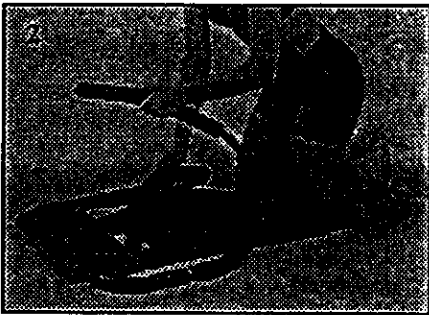

Fold the exercise mat and press together the self-adhesive surfaces on the underside of the mat.

The AB SHAPER can be wiped clean with a damp cloth and mild, non-abrasive detergent. Do not use solvents.

## Part List/Exploded Drawing

| Key No. | Qty. | Part No. | Description            |
|---------|------|----------|------------------------|
| 1       | 1    | 130680   | Right Handle           |
| 2       | 2    | 013244   | 1/4" x .6" Screw       |
| 3       | 4    | 130394   | #8 x 9/16" Screw       |
| 4       | 1    | 130681   | Left Handle            |
| 5       | 2    | 130676   | Spring                 |
| 6       | 2    | 130678   | 1/4" x 1 5/8" Roll Pin |
| 7       | 2    | 130677   | Sleeve                 |
| 8       | 2    | 130679   | 1/4" x 1 1/4" Pin      |
| 9       | 1    | 130105   | Frame                  |
| 10      | 1    | 130235   | Exercise Mat/Headrest  |
| 11      | 4    | 130205   | Foam Grip              |
| 12      | 2    | 130229   | 1" Round Cap           |
| 13      | 4    | 013141   | #8 x 1/2" Tap Screw    |
| #       | 1    | 130400   | User's Manual          |
| #       | 1    | 130381   | Training Videocassette |

Note: "#" indicates a non-illustrated part. Specifications are subject to change without notice. To order replacement parts, see the back cover of this manual.

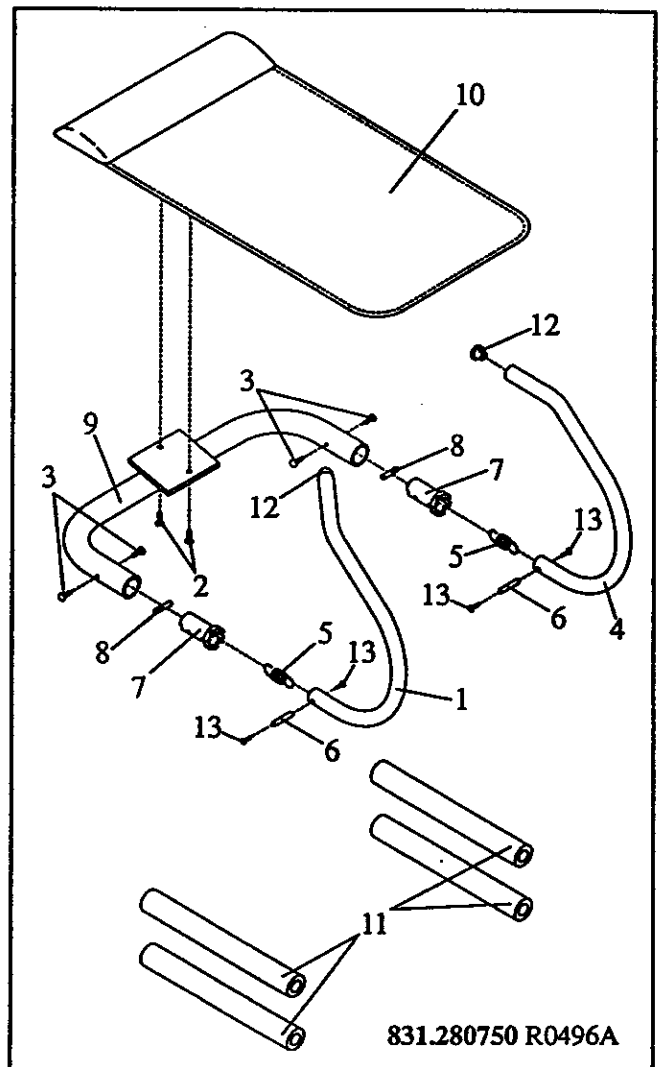

831.280750 R0496A

## How to Use the AB SHAPER

The AB SHAPER offers a variety of exercises that shape your upper abdominals, oblique abdominals, and lower abdominals.

The photographs in this manual show the correct form for each exercise. If desired, attach this manual to the wall for reference.

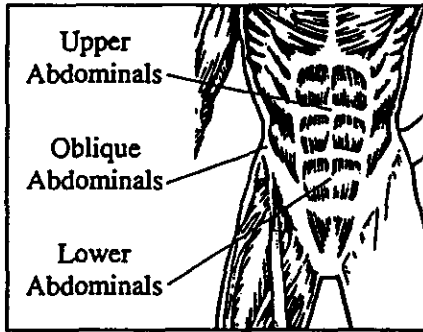

The exercises in this manual are divided into four groups: Beginning, Intermediate, Advanced, and Expert. Start with the beginning exercises, and progress at your own pace. Be careful not to overdo it during the first few weeks of your exercise program. It is better to increase the number of repetitions you do than to advance to more difficult exercises too quickly. The intensity of each exercise can be varied by changing the position of your hands on the AB SHAPER handles. The lower your hands are positioned, the more difficult the exercise will be.

To get the most from your exercise, proper form is important. As you perform each repetition, use your abdominal muscles to pull yourself up, allowing the AB SHAPER to "roll" with you. Do not press or pull the handles together. Keep your head on the headrest and the small of your back on the exercise mat. If necessary, raise your hips slightly.

Always begin and end each workout with a few minutes of stretching. Remember to keep plenty of water nearby as you exercise, and drink periodically to avoid dehydration. If you feel faint, dizzy, or short of breath at any time during exercise, stop immediately and begin cooling down.

**WARNING:** Before you begin this or any exercise program, consult your physician. This is especially important for persons over the age of 35 or persons with pre-existing health problems. SEARS assumes no responsibility for personal injury or property damage sustained by or through the use of this product.

## Suggested Stretches

Begin and end each workout with a few minutes of stretching. Stretching prepares the body for exercise by increasing the body temperature, heart rate, and circulation. After exercise, stretching allows the heart rate to return to normal and the muscles to cool down gradually. Stretching is also effective for increasing flexibility. The correct form for three basic stretches is shown below. Move slowly as you stretch—never bounce.

### 1. Hamstring Stretch

Extend one leg and rest the opposite foot against it as shown. Reach toward your toes and hold for 15 counts. Repeat 3 times for each leg.

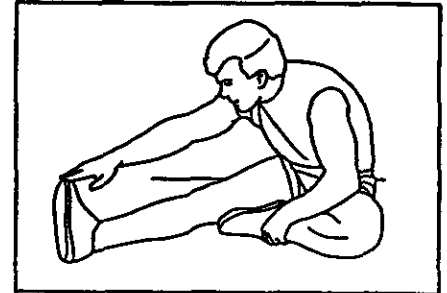

### 2. Toe Touch Stretch

Stand with your knees bent slightly as shown. Relax your back and shoulders as you reach down toward your toes. Hold for 15 counts. Repeat 3 times.

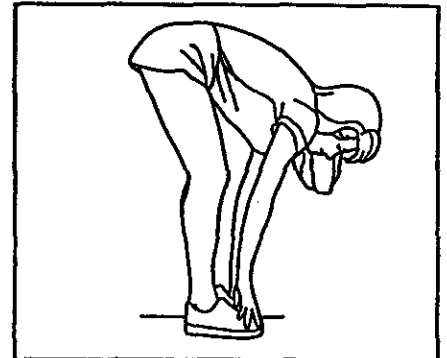

### 3. Quadriceps Stretch

Place one hand against a wall and grasp one foot with your other hand as shown. Hold your foot as close to your buttocks as possible, and hold for 15 counts. Repeat 3 times for each leg.



## Beginning Exercises

Be sure to stretch for a few minutes before you begin.

### 1. Basic Crunch

This exercise targets the upper abdominals. Lie on the exercise mat, and bend your knees as shown. Place your hands near the upper ends of the handles. Curl up to about a 45° angle, and then lower yourself to the starting position. This completes one repetition. Perform 10 to 15 repetitions.



### 2. Basic Crunch with Raised Feet

This exercise focuses on the lower abdominals. This exercise should be performed in the same way as the Basic Crunch, except your feet should be held about one inch off the floor during the exercise. Complete 10 to 15 repetitions.



### 3. Basic Oblique Crunch

This exercise is for the oblique abdominals. Perform this exercise in the same way as the Basic Crunch, but turn your knees to the side as shown. Complete 5 to 7 repetitions, change your knees to the opposite side, and then perform another 5 to 7 repetitions.



## Intermediate Exercises

As your abdominal muscles become stronger, and you can comfortably perform several repetitions of the beginning exercises, it is time to move on to the intermediate exercises. Remember to stretch for a few minutes before you begin.

### 4. Raised-knee Crunch with Knees Held to Chest

This exercise focuses on the upper abdominals. Lie on the exercise mat and bring your knees toward your chest as shown. Curl up to about a 45° angle, and then lower yourself to the starting position. Keep your knees raised throughout the exercise. Complete 10 to 15 repetitions.



This exercise can also be performed by resting your feet on a chair.

### 5. Raised-knee Crunch with Knees Lifted to Chest

This exercise targets the lower abdominals. The starting position is shown in photograph 5a. Curl up to about a 45° angle, bringing your knees toward your chest at the same time; then return to the starting position. Perform 10 to 15 repetitions.



# WEIDER. ABShaper

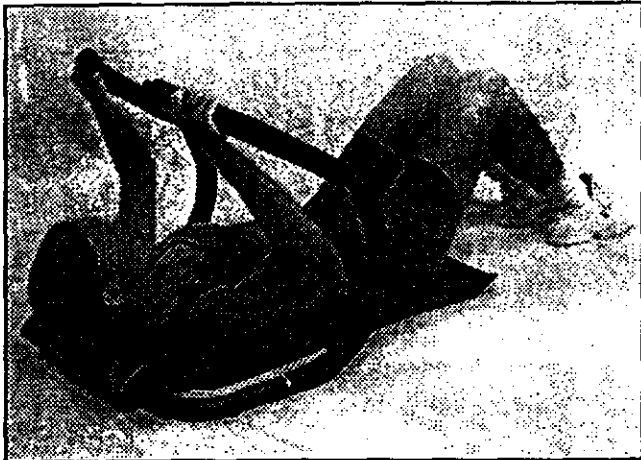

## Important Precautions

- Use the AB SHAPER only as described in this manual.
- As you exercise, keep the small of your back on the exercise mat; it may be necessary to raise your hips slightly.
- Keep your head on the headrest as you exercise.
- If you feel faint, dizzy, or short of breath at any time during exercise, stop immediately and begin cooling down.
- Read all instructions before you use the AB SHAPER. Before you begin this or any exercise program, consult your physician. This is especially important for persons over the age of 35 or persons with pre-existing health problems. SEARS assumes no responsibility for personal injury or property damage sustained by or through the use of this product.

## Before You Begin

Congratulations for purchasing the innovative WEIDER® AB SHAPER. The AB SHAPER is designed to shape your upper abs, obliques, and lower abs to give you a firm, flat stomach, in only minutes a day. The unique AB SHAPER supports your head and neck as you exercise, and helps you maintain correct form for maximum results. Used as part of a fitness program that includes regular aerobic exercise and a proper diet, the AB SHAPER will help you to look better, feel better, and enjoy the benefits of better fitness.

Before you use the WEIDER® AB SHAPER, please read this manual carefully. In addition, be sure to view the included videocassette.

If you have additional questions, please call our toll-free HELPLINE at 1-800-736-6879, Monday through Saturday, 7 a.m. until 7 p.m. Central Time (excluding holidays). To help us assist you quickly, please note the product model number before calling; the model number is 831.280750.

## Setting Up the AB SHAPER

The AB SHAPER is shipped in the compact storage position. No assembly is necessary. Follow the simple steps below to set up the AB SHAPER.

1. Lay the exercise mat flat.

Raise one of the handles as shown.

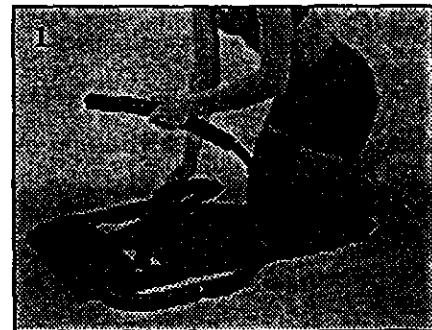

2. Continue to raise the handle until the locking pin snaps into the pin groove.

Raise the other handle in the same way.



## Expert Exercises

The expert exercises should be done only after you can comfortably perform the advanced exercises.

### 10. Bicycle Ab Crunch

This exercise focuses on the lower abdominals. Straighten your legs and hold them just off the floor as shown in photograph 10a. Curl up to about a 45° angle, bending one knee and raising it as shown in photograph 10b; then return to the starting position. Complete 10 to 15 repetitions, alternating legs with each repetition.

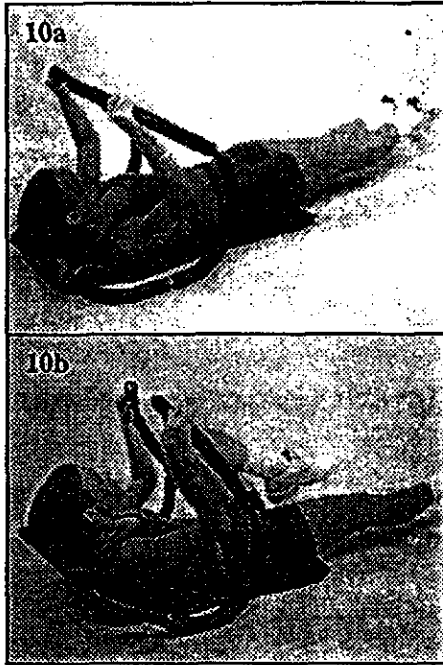

### 11. Jackknife

This exercise targets the lower abdominals. Straighten your legs and hold them just off the floor as shown in photograph 11a. Curl up to about a 45° angle, raising both legs as shown in photograph 11b; then return to the starting position. Complete 10 to 15 repetitions.

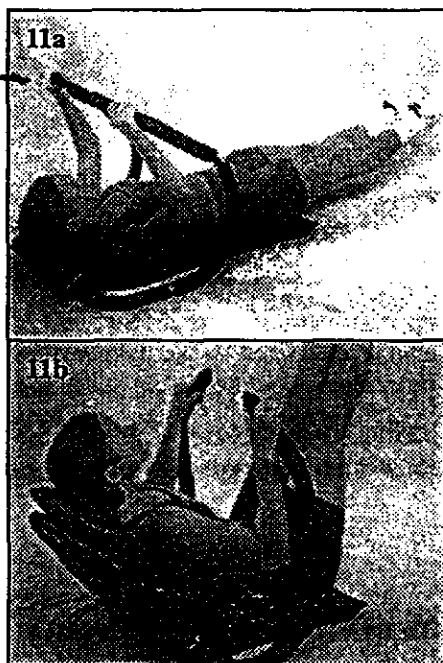

## Expert Exercises—Cont.

### 12. Reverse Trunk

This exercise focuses on the oblique abdominals. Straighten your legs and raise them as shown in photograph 12a. Curl up to about a 45° angle. This is the starting position. Lower your legs to the side as shown in photograph 12b; then return to the starting position. Complete 10 to 15 repetitions, alternating sides with each repetition.

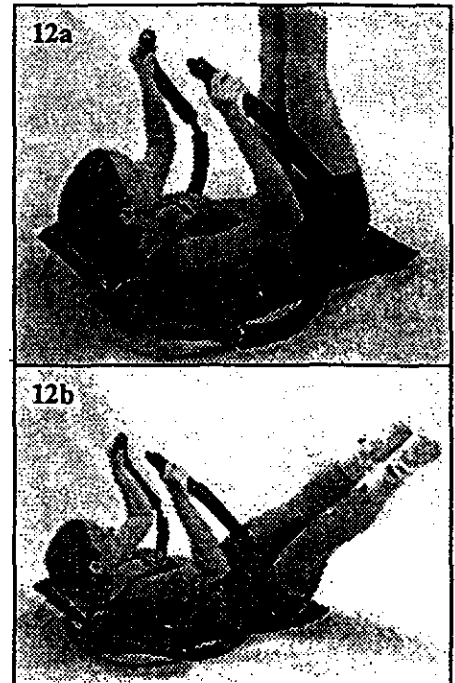

### 13. Scissors

This exercise focuses on the upper and lower abdominals. Hold your legs in the position shown in photograph 13a. Curl up to about a 45° angle. This is the starting position. Cross your ankles as shown in photograph 13b; then return to the starting position. Complete 10 to 15 repetitions, alternately crossing the right ankle above the left, and then the left ankle above the right.



# SEARS

Model No. 831.280750

## QUESTIONS?

If you find that:

- you need help assembling or operating the WEIDER® AB SHAPER
- a part is missing
- or you need to schedule repair service

call our toll-free HELPLINE

**1-800-736-6879**

Monday-Saturday, 7 am-7 pm  
Central Time (excluding holidays)

## REPLACEMENT PARTS

If parts become worn and need to be replaced, call the following toll-free number

**1-800-FON-PART**  
**(1-800-366-7278)**

All replacement parts are available for immediate purchase or special order when you visit your nearest SEARS Service Center. To request service or to order parts by telephone, call the toll-free numbers listed at the left.

When requesting help or service, or ordering parts, please be prepared to provide the following information:

- The NAME OF THE PRODUCT (WEIDER® AB SHAPER)
- The MODEL NUMBER OF THE PRODUCT (831.280750)
- The PART NUMBER OF THE PART (see the Part List and Exploded Drawing in this manual)
- The DESCRIPTION OF THE PART (see the Part List and Exploded Drawing in this manual)

## Full 90-day Warranty

For 90 days from the date of purchase, if failure occurs due to defect in material or workmanship in this AB SHAPER EXERCISER, contact the nearest SEARS Service Center throughout the United States and SEARS will repair or replace the AB SHAPER EXERCISER, free of charge.

This warranty does not apply when the AB SHAPER EXERCISER is used commercially or for rental purposes.

This warranty gives you specific legal rights, and you may also have other rights which vary from state to state.

**SEARS, ROEBUCK AND CO., DEPT. 817WA, HOFFMAN ESTATES, IL 60179**