

Operator's Manual

CRAFTSMAN®

2.5 HP Motor

ELECTRIC CHAIN SAW

Model No.

358.341140 – 16 in. Bar

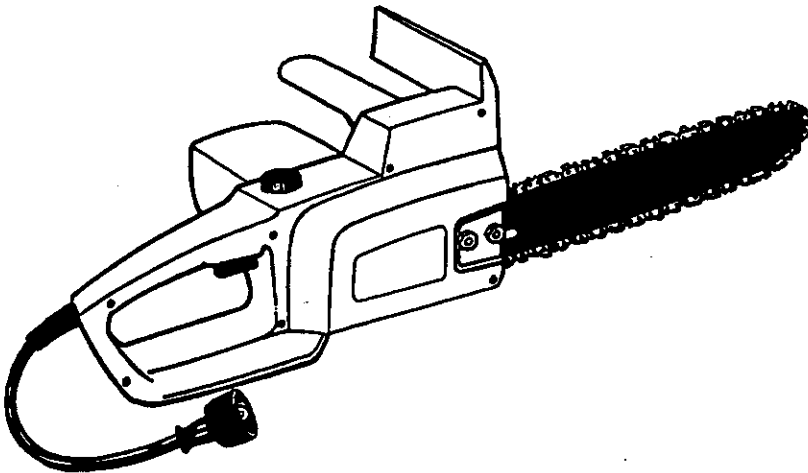

SAFETY

ASSEMBLY

OPERATION

MAINTENANCE

ESPAÑOL



WARNING:

Read and follow all Safety Rules and Operating Instructions before first use of this product.



For answers to your questions about this product:
Call 7 am–7 pm, Mon–Sat; Sun, 10 am–7 pm

1-800-235-5878

Sears, Roebuck and Co., Hoffman Estates, IL 60179 USA

TABLE OF CONTENTS

| | | | |
|--------------|----|-------------------------|------|
| Warranty | 2 | Service and Adjustments | 13 |
| Safety Rules | 2 | Storage | 15 |
| Assembly | 7 | Trouble Shooting | 15 |
| Operation | 7 | Spanish | 18 |
| Maintenance | 12 | Parts Ordering | Back |

WARRANTY STATEMENT

FULL ONE YEAR WARRANTY ON CRAFTSMAN ELECTRIC CHAINSAW.

If this Craftsman Electric Chain Saw fails to perform properly due to a defect in material or workmanship within (1) year from the date of purchase, Sears will repair or replace it, free of charge.

This warranty excludes the bar and chain, which are expendable parts and become worn during normal use.

If this Craftsman Electric Chain Saw is used for commercial purposes, this warranty applies for only 90 days from the date of purchase. If this Craftsman Electric Chain Saw is used for rental purposes, this warranty applies for only 30 days from the date of purchase. This warranty applies only while this product is in use in the United States.

WARRANTY SERVICE IS AVAILABLE BY RETURNING THE CRAFTSMAN ELECTRIC CHAIN SAW TO THE NEAREST SEARS SERVICE CENTER IN THE UNITED STATES.

This warranty gives you specific legal rights, and you may also have other rights which vary from state to state.

Sears, Roebuck and Co., Inc., Hoffman Estates, IL 60179 U.S.A.

SAFETY RULES

WARNING: When using an electric chain saw, basic safety precautions, including the following, should always be followed to reduce the risk of fire, electric shock, and injury to persons. Read all instructions.

WARNING: Always disconnect power source when making repairs. Because a chain saw is a high-speed woodcutting tool, careless or improper use of this tool can cause serious injury.

PLAN AHEAD

- Restrict the use of your saw to adult users who understand and can follow the safety rules, precautions, and operating instructions found in this manual.
- Keep children away. Do not let visitors contact chain saw or extension cord. All visitors should be kept at least 30 feet (10 meters) away from work area.
- Dress properly. Wear protective gear. Always use steel-toed safety footwear with non-slip soles; snug-fitting clothing; heavy-duty, non-slip gloves; eye protection such as non-fogging, vented goggles or face screen; an ap-

proved safety hard hat; and sound barriers (ear plugs or mufflers) to protect your hearing. Regular users should have hearing checked regularly as chain saw noise can damage hearing.

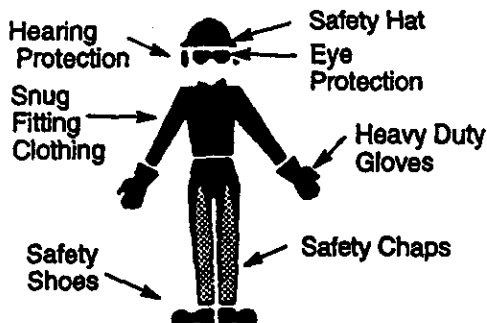

- Secure hair above shoulder length. Do not wear loose clothing or jewelry; they can get caught in moving parts.
- Keep all parts of your body away from the chain when saw is running.
- Do not handle or operate a chain saw when you are fatigued, ill, upset, or if you have taken alcohol, drugs, or me-

dication. You must be in good physical condition and mentally alert. If you have any condition that might be aggravated by strenuous work, check with doctor before operating.

Watch what you are doing. Use common sense.

- Do not start cutting until you have a clear work area, secure footing, and especially if you are felling a tree, a retreat path. Keep work area clean. Cluttered areas invite injuries.

OPERATE YOUR SAW SAFELY

- Do not operate with one hand. Serious injury to the operator, helpers, or bystanders may result from one-handed operation. A chain saw is intended for two-handed use.
- Do not operate saw from a ladder or in a tree.
- Make sure the chain will not make contact with any object while starting the saw. Never start the saw when the guide bar is in a cut.
- Don't force chain saw. It will do the job better and safer at the rate for which it was intended.
- Do not put pressure on the saw, especially at the end of the cut. Doing so can cause you to lose control when the cut is completed.
- Stop the saw before setting it down.
- Hand carry saw only when motor is stopped. Carry the chain saw by the front handle with the saw stopped, finger off the switch, the guide bar and saw chain to the rear.
- Use the right tool, cut wood only. Don't use chain saw for purpose not intended; for example, don't use chain saw for cutting plastic, masonry, non-wood building materials.
- Use extreme caution when cutting small size brush and saplings because the tender material may catch the saw chain and be whipped toward you or pull you off balance.
- When cutting a limb that is under tension be alert for spring back so you will not be struck when the tension in the wood fibers is released.

MAINTAIN YOUR SAW IN GOOD WORKING ORDER

- Have all chain saw service performed by a Sears Service Center except the items listed in the maintenance section of this manual.
- Make certain saw chain stops moving when trigger switch is released.

- Keep the handles dry and clean and free from oil and grease.
- Keep oil cap and fasteners securely tightened.
- Nonconforming replacement components or the removal of safety devices may cause damage to the unit and possible injury to the operator or bystanders. Use only Craftsman accessories and replacement parts as recommended. Never modify your saw.
- Maintain chain saw with care.
- Keep unit sharp and clean for better and safer performance.
- Follow instructions for lubricating and changing accessories.
- Unplug the chain saw from the power source when not in use, before servicing, and when changing accessories and attachments, such as saw chain and guard.
- Check for damaged parts. Before further use of the chain saw, a guard or other part that is damaged should be carefully checked to determine that it will operate properly and perform its intended function. Check for alignment of moving parts, binding of moving parts, breakage of parts, mounting and any other conditions that may affect its operation. A guard or other part that is damaged should be properly repaired or replaced by a Sears Service Center unless otherwise indicated elsewhere in the operator's manual.
- Do not operate a chain saw that is damaged, improperly adjusted, or is not completely and securely assembled. Inspect chain saw cords periodically, and if damaged have repaired by a Sears Service Center.
- When not in use, chain saws should be stored in a dry, high or locked-up place out of the reach of children.
- When storing saw, unplug and use a bar sheath or carrying case. Store idle chain saw.

ELECTRICAL SAFETY

- Use a voltage supply as shown on unit.
- Avoid dangerous environments. Don't use appliances in damp or wet locations. Don't use in rain.
- Avoid dangerous situations. Do not use in the presence of flammable liquids or gases to avoid creating a fire or explosion and/or causing damage to unit.

- To reduce the risk of electrical shock, this appliance has a polarized plug (one blade is wider than the other) and will require the use of a polarized extension cord. The appliance plug will fit into a polarized extension cord only one way. If the plug does not fit fully into the extension cord, reverse the plug. If the plug still does not fit, obtain a correct polarized extension cord. A polarized extension cord will require the use of a polarized wall outlet. This plug will fit into the polarized wall outlet only one way. If plug does not fit fully into the wall outlet, reverse the plug. If the plug still does not fit, contact a qualified electrician to install the proper wall outlet. Do not change the equipment plug, extension cord receptacle, or extension cord plug in any way.
- To reduce risk of electrical shock, use extension cords specifically marked as suitable for outdoor appliances having electrical rating not less than the rating of unit. Cord must be marked with suffix "W". Make sure your extension cord is in good condition. Inspect extension cord before use and replace if damaged. An undersized extension cord will cause a drop in line voltage resulting in loss of power and overheating. If in doubt, use the next heavier gauge. The lower the gauge number, the heavier the cord (see "Select an extension cord").
- Do not abuse cord. Never carry the unit by the extension cord or yank extension cord to disconnect unit.
- Secure extension cord to power cord to prevent disconnection from unit.
- Do not use the unit if the switch does not turn the unit on and off properly, or if the lockout does not work. Repairs to the switch must be made by a Sears Service Center.
- Keep extension cord clear of operator and obstacles at all times. Position cord so that it will not be caught on branches. Do not expose cords to heat, oil, water, or sharp edges.
- To avoid the possibility of electric shock, avoid body contact with any grounded conductor, such as metal fences or pipes.
- Ground Fault Circuit Interrupter (GFCI) protection should be provided on circuit or outlet to be used. Receptacles are available having built-in GFCI protection and may be used for this measure of safety. Inspect chain

saw cords periodically and if damaged, have repaired by a Sears Service Center.

GUARD AGAINST KICKBACK

Follow all safety rules to help avoid kickback and other forces which can result in serious injury.

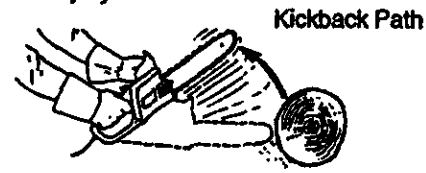

Kickback Path



Avoid Obstructions

Clear The Working Area

WARNING: Rotational Kickback can occur when the moving chain contacts an object at the upper portion of the tip of the guide bar. Contact at the upper portion of the tip of the guide bar can cause the chain to dig into the object, which stops the chain for an instant. The result is a lightning fast, reverse reaction which kicks the guide bar up and back toward the operator. Pinch-Kickback and Pull-In occur when the chain is suddenly stopped by being pinched, caught, or by contacting a foreign object in the wood. This sudden stopping of the chain results in a reversal of the chain force used to cut wood and causes the saw to move in the opposite direction of the chain rotation. Pinch-Kickback drives the saw straight back toward the operator. Pull-In pulls the saw away from the operator.

KICKBACK WARNING:

Kickback can occur when the moving chain contacts an object at the upper portion of the tip of the guide bar or when the wood closes in and pinches the saw chain in the cut. The Computed Kickback Angle (CKA) listed on your saw and listed in the following CKA Table represents the angle of kickback your bar and chain combinations will have when tested in accordance with CSA and ANSI standards. Computed angles represented in the CKA column indicate total energy and angle associated without a chain brake. When purchasing replacements, considerations should be given to the lower CKA values. In all cases, lower CKA val-

ues represent a safer operating environment for the user. Do not rely exclusively upon the safety devices built into your saw.

- Either of these reactions may cause you to lose control of the saw which could result in serious injury.
- Pinching the saw chain along the tip of the guide bar may push the guide bar rapidly back toward the operator.
- Tip contact in some cases may cause a lightning fast REACTION, kicking the guide bar up and back toward operator.

CKA TABLE

| MODEL | BAR | | CHAIN P/N | CKA |
|------------|----------|--------|-----------|-----|
| | P/N | Length | | |
| 358.341140 | 71-36366 | 16" | 71-3629 | 20° |

CHAIN BRAKE & CKA ANGLE

WARNING: The effectiveness of a chain brake in reducing operator injuries has not yet been fully determined. We cannot represent that a chain brake is an effective safety device to prevent or reduce the hazard of injuries resulting from kickback. DO NOT ASSUME THAT THE CHAIN BRAKE WILL PROTECT YOU IN THE EVENT OF A KICKBACK. Instead, use the saw properly and carefully to avoid kickback. Reduced Kickback bars and Low Kickback chains reduce the hazard of kickback and are recommended. Repairs on a chain brake should be made by a Sears Service Center. Take your unit to the place of purchase if purchased from a Servicing Center, or to the nearest Sears Service Center.

WARNING: Computed kickback angle (CKA) listed on your saw and listed in the CKA table represents angle of kickback your bar and chain combinations will have when tested in accordance with CSA and ANSI standards. When purchasing replacement bar and chain, considerations should be given to the lower CKA values. Lower CKA values represent safer angles to the user, higher values indicate more angle and higher kick energies. In all cases lower CKA values represent a safer operating environment for the user.

The guide bar and chain combination(s) shown in the CKA Table meet kickback requirements of CSA Z62.1, Z62.3, & ANSI B175.1 when used on saw(s) listed in this manual. Use of bar and chain combinations other than those listed is not recommended and may not meet the

CKA requirements per standard. REDUCE THE CHANCE OF KICKBACK

The following precautions should be followed to minimize kickback:

- Grip saw firmly. Hold chain saw firmly with both hands when motor is running. Use a firm grip with thumbs and fingers encircling chain saw handles.
- Do not over reach.
- Keep proper footing and balance at all times.
- Don't let the nose of the guide bar contact a log, branch, ground or other obstruction.
- Don't cut above shoulder height.
- Use devices such as low kickback chain, guide bar nose guards, chain brakes, and special guide bars that reduce the risks associated with kickback.
- Only use replacement bars and chains specified by the manufacturer or the equivalent.

Avoid Pinch-Kickback:

- Be extremely aware of situations or obstructions that can cause material to pinch the top of or otherwise stop the chain.
- Do not cut more than one log at a time.
- Do not twist the saw as the bar is withdrawn from an undercut when bucking.

Avoid Pull-In:

- Always begin cutting with the saw at full speed and the saw housing against wood.
- Use wedges made of plastic or wood. Never use metal to hold the cut open.

MAINTAIN CONTROL:

The following precautions should be followed to minimize kickback.

- A good, firm grip on the saw with both hands will help you maintain control. Don't let go. Grip the rear handle with your right hand whether you are right or left handed.



- Wrap the fingers of your left hand over and around the front handlebar, and your left thumb under the front handlebar.

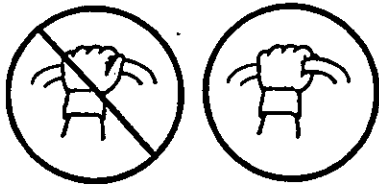

- When making bucking or pruning cuts, position your left hand on the front handlebar so it is in a straight line with your right hand on the rear handle. Stand slightly to the left side of the saw to keep your body from being in a direct line with the cutting chain. Keep your left arm straight with the elbow locked.
- Stand with your weight evenly balanced on both feet.
- Do not overreach. You could be drawn or thrown off balance and lose control.
- Do not cut above shoulder height. It is difficult to maintain control of saw above shoulder height.

KICKBACK SAFETY FEATURES

WARNING: The following features are included on your saw to help reduce hazard of kickback; however, such features will not totally eliminate this danger. Do not rely only on safety devices.

- Handguard: designed to reduce the chance of your left hand contacting the chain if your hand slips off the front handlebar.
- Position of front and rear handlebars: designed with distance between handles and "in-line" with each other. The spread and "in-line" position of the hands provided by this design work together to give balance and resistance in controlling the pivot of the saw back toward the operator if kickback occurs.
- Reduced-Kickback Guide Bar: designed with a small radius tip which reduces the size of the kickback danger zone. This type bar has been demonstrated to significantly reduce the number and seriousness of kickbacks when tested in accordance with ANSI B175.1.

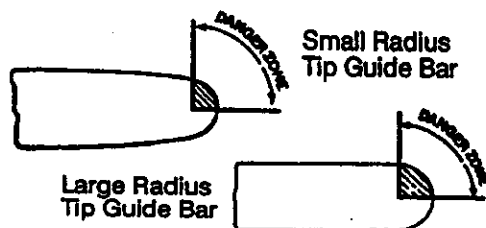

- Low Kickback Chain has met kickback performance requirements when tested on the representative sample of these chain saws specified in ANSI B175.1.

Low Kickback Chain

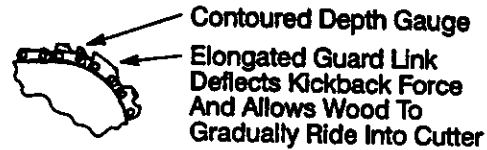

Contoured Depth Gauge

Elongated Guard Link Deflects Kickback Force And Allows Wood To Gradually Ride Into Cutter

SAFETY NOTICE: Exposure to vibrations through prolonged use of hand tools could cause blood vessel or nerve damage in the fingers, hands, and joints of people prone to circulation disorders or abnormal swelling.

Prolonged use in cold weather has been linked to blood vessel damage in otherwise healthy people. If symptoms occur such as numbness, pain, loss of strength, change in skin color or texture, or loss of feeling in the fingers, hands, or joints, discontinue the use of this tool and seek medical attention. An anti-vibration system does not guarantee the avoidance of these problems. Users who operate power tools on a continual and regular basis must closely monitor their physical condition and the condition of this tool.

DOUBLE INSULATION

CONSTRUCTION

This unit is Double Insulated to help protect against electric shock. Double insulation construction consists of two separate "layers" of electrical insulation instead of grounding.

Tools built with this insulation system are not intended to be grounded. No grounding means is provided on this unit, nor should a means of grounding be added to this unit.

Safety precautions must be observed when operating any electrical tool. The double insulation system only provides added protection against injury resulting from an internal electrical insulation failure.

STANDARDS: This product is listed by Underwriters Laboratories, Inc. in accordance with UL Standard 1662 and CSA Standards Z62.1 and Z62.3 and ANSI B175.1.

SAVE THESE INSTRUCTIONS

ASSEMBLY

CARTON CONTENTS

Models 358.341140

Chain Saw (fully assembled)

Bar Sheath

Examine parts for damage. Do not use damaged parts.

NOTE: If you need assistance or find

parts missing or damaged, please call 1-800-235-5878

ASSEMBLY

Your saw is fully assembled; no assembly is necessary.

OPERATION

KNOW YOUR SAW

READ THIS OPERATOR'S MANUAL AND SAFETY RULES BEFORE OPERATING YOUR CHAIN SAW. Compare the illustrations with your unit to familiarize yourself with the location of the various controls and adjustments. Save this manual for future reference.

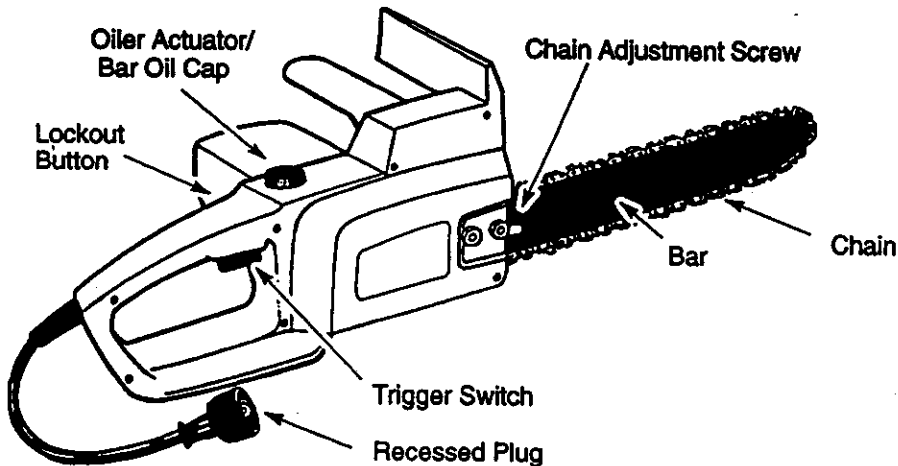

TRIGGER SWITCH

The trigger switch is used to turn on the unit. Squeeze the trigger switch to operate the unit after lockout button has been pushed in. Release the trigger to turn the unit off.

LOCKOUT BUTTON

The Lockout Button is a control feature designed to prevent the motor from being accidentally started. When the rear handle is gripped in a normal cutting position, the lockout button can be pushed in by the thumb, permitting the index finger to squeeze the trigger. It is not necessary to maintain pressure on the lockout button once the trigger has been engaged.

BAR OIL CAP/OILER ACTUATOR

The oil cap is used to access the bar oil tank and pressed to supply oil to chain.

CHAIN ADJUSTMENT SCREW

The chain adjustment screw is used to adjust the chain tension.

RECESSED PLUG

The recessed plug is used to connect the saw to an approved extension cord.

CHAIN TENSION

It is normal for a new chain to stretch during first 30 minutes of operation. You should check your chain tension frequently. Readjust chain after every 15 minutes of operation. See Chain Tension under the Service and Adjustments section.

OPERATING INSTRUCTIONS

Use only a voltage supply as specified on your unit.

Extension cords are available for this unit. Secure extension cord to power cord to prevent disconnection from unit.



SELECT AN EXTENSION CORD

| MINIMUM WIRE GAUGE RECOMMENDATIONS | | |
|------------------------------------|-----------------|--------------------|
| Volts | 100 ft. or less | 100 ft. to 150 ft. |
| 120 | 14 A.W.G.* | 12 A.W.G.* |

*American Wire Gauge

BEFORE STARTING SAW

WARNING: Be sure to read the electrical safety information in the safety rules section of this manual before you begin. If you do not understand the electrical safety information do not attempt to use your unit. Seek help from someone that does understand the information or call the customer assistance help line at 1-800-235-5878.

GUIDE BAR AND CHAIN OIL

The manually operated chain oiler provides lubrication to the chain and guide bar. Be sure to fill the bar oil tank before each cutting session. The oiler activator/bar oil cap must be used regularly and often enough to maintain a thin film of oil on the bar and chain while saw is cutting. It is recommended that the oiler actuator/bar oil cap be operated six (6) times per minute and held for approximately three (3) seconds each time it is pressed. For maximum guide bar and chain life, we recommend you use Craftsman chain saw bar oil. If Craftsman bar oil is not available, you may use a good grade SAE 30 oil until you are able to obtain Craftsman brand. The oil output is manually metered during operation. Use a funnel to fill the tank. Replace oil cap securely. Check oil level after every 15 minutes of operation.

STOPPING YOUR SAW

- Release the trigger switch.
- If motor does not stop, disconnect the extension cord.

STARTING YOUR SAW

- Connect the saw to a power source using the proper size extension cord; see SELECT AN EXTENSION CORD.
- Push in switch lock out button.
- Squeeze and hold the trigger switch.

OPERATING TIPS

- Check chain tension before first use and after 1 minute of operation. See Chain Tension in the Maintenance section and Service and Adjustment section.
- Cut wood only. Do not cut metal, plastics, masonry, non-wood building materials, etc.

- Stop the saw if the chain strikes a foreign object. Inspect the saw and repair parts as necessary.
 - Keep the chain out of dirt and sand. Even a small amount of dirt will quickly dull a chain and increase the possibility of kickback.
 - Practice cutting a few small logs using the following steps. This will help you get the "feel" of using your saw before you begin a major sawing operation.
 - Squeeze the trigger switch and allow unit to reach full speed before cutting.
 - Begin cutting with the saw frame against the log.
 - Keep the motor at full speed the entire time you are cutting.
 - Release trigger switch as soon as cut is completed, allowing motor to stop.
 - To avoid losing control when cut is complete, do not put pressure on saw at end of cut.
 - Stop motor before setting saw down.
- ### TREE FELLING TECHNIQUES
- Check for broken or dead branches which can fall while cutting causing serious injury. Do not cut near buildings or electrical wires if you do not know the direction of tree fall, nor cut at night since you will not be able to see well, nor during bad weather such as rain, snow, strong winds, etc. If the tree makes contact with any utility line, the utility company should be notified immediately.
- Carefully plan your sawing operation in advance.
 - Clear the work area. You need a clear area all around the tree so you can have secure footing.
 - Study the natural conditions that can cause the tree to fall in a particular direction, such as:
 - The wind direction and speed.
 - The lean of the tree. The lean of a tree might not be apparent due to uneven or sloping terrain. Use a plumb or level to determine the direction of tree lean.
 - Weight and branches on one side.
 - Surrounding trees and obstacles.
 - Look for decay and rot. If the trunk is rotted, it can snap and fall toward the operator.
 - Make sure there is enough room for the tree to fall. Maintain a distance of 2-1/2 tree lengths from the nearest person or other objects. Motor noise can drown out a warning call.

- Remove dirt, stones, loose bark, nails, staples, and wire from the tree where cuts are to be made.

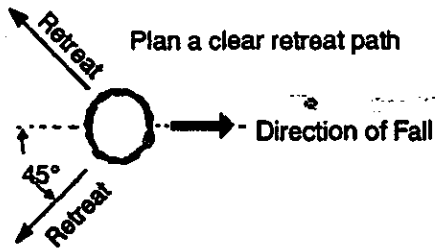

A retreat path should be planned and cleared as necessary before cuts are started. The retreat path should extend back and diagonally to the rear of the expected line of fall as illustrated above.

FELLING LARGE TREES

(6 inches in diameter or larger)

The notch method is used to fell large trees. A notch is cut on the side of the tree in the desired direction of fall. After a felling cut is made on the opposite side of tree, the tree will tend to fall in the direction of the notch.

NOTE: If tree has large buttress roots, remove them before making the notch.

NOTCH CUT AND FELLING TREE

- Make notch cut by cutting the top of the notch first. Cut through 1/3 of the diameter of the tree. Next complete the notch by cutting the bottom. See illustration. Once notch is cut, remove the wedge of wood from the tree.
- After removing the wood, make the felling cut on the opposite side of the notch. This is done by making a cut about two inches higher than the center of the notch. This will leave enough uncut wood between the felling cut and the notch to form a hinge. This hinge will help prevent the tree from falling in the wrong direction.

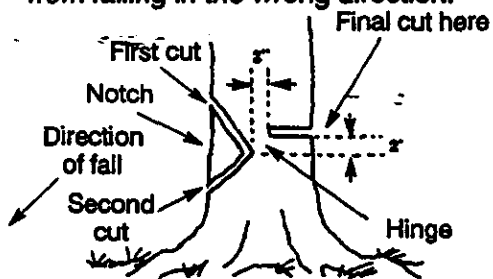

Notching Undercut – Make the notch 1/3 the diameter of the tree, perpendicular to the direction of fall as illustrated. Make the lower horizontal notching cut first. This will help to avoid pinching of either the saw chain or the guide bar when the second notch is being made.
Felling Back Cut – Make the felling back cut at least 2 inches (50.8mm)

higher than the horizontal notching cut as illustrated. Keep the felling back cut parallel to the horizontal notching cut. Make the felling back cut so enough wood is left to act as a hinge. The hinge wood helps the tree from twisting and falling in the wrong direction. Do not cut through the hinge.

As the felling cut gets close to the hinge the tree should begin to fall. If there is any chance that the tree may not fall in the desired direction or it may rock back and bind the saw chain, stop cutting before the felling back cut is complete and use wedges of wood, plastic or aluminum to open the cut and drop the tree along the desired line of fall.

When the tree begins to fall, remove the chain saw from the cut, stop the motor, put the chain saw down, then use the retreat path planned. Be alert for overhead limbs falling and watch your footing. Hinge holds tree on stump and helps control fall.

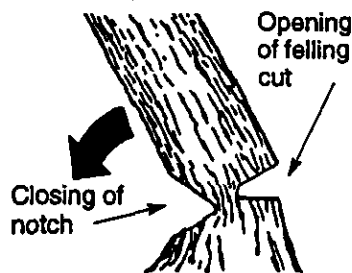

NOTE: Before felling cut is complete, use wedges to open the cut when necessary to control the direction of fall. To avoid kickback and chain damage, use wood or plastic wedges, but never steel or iron wedges.

- Be alert to signs that the tree is ready to fall: cracking sounds, widening of the felling cut, or movement in the upper branches.
- As tree starts to fall, stop saw, put it down, and get away quickly on your planned retreat path.
- Be extremely cautious with partially fallen trees that may be poorly supported. When a tree doesn't fall completely, set the saw aside and pull down the tree with a cable winch, block and tackle, or tractor. Do not use your saw to cut down a partially fallen tree.

CUTTING A FALLEN TREE (BUCKING)

Bucking is the term used for cutting a fallen tree to the desired log size.

WARNING: Do not stand on the log being cut. Any portion can roll causing

loss of footing and control. Do not stand downhill of the log being cut.

IMPORTANT POINTS

- It is important to make sure your footing is firm and your weight is evenly distributed on both feet. When possible, the log should be raised and supported by use of limbs, logs, or blocks.
- Cut only one log at a time.
- Cut shattered wood very carefully; sharp pieces of wood could be flung toward operator.
- Use a sawhorse to cut small logs. Never allow another person to hold the log while cutting and never hold the log with your leg or foot.
- Do not cut in an area where logs, limbs, and roots are tangled. Drag logs into a clear area before cutting them.
- When "cutting through", to maintain complete control, release the cutting pressure near the end of the cut without loosening your grip on the chain saw handles.
- Don't let the chain contact the ground.
- After completing the cut, wait for the saw chain to stop before you move the chain saw.
- Always stop the motor before moving from tree to tree.

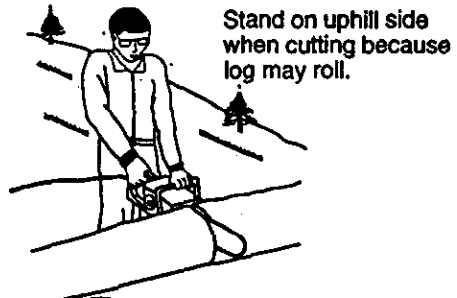

The chain saw operator should keep on the uphill side of the terrain as the tree is likely to roll or slide downhill after it is felled.

When bucking on a slope always stand on the uphill side of the log, as illustrated above. When "cutting through", to maintain complete control release the cutting pressure near the end of the cut without relaxing your grip on the chain saw handles. Don't let the chain contact the ground. After completing the cut, wait for the saw chain to stop before you move the chain saw. Always stop the motor before moving from the tree to tree.

BUCKING TECHNIQUES

WARNING: If saw becomes pinched or hung in a log, don't try to force it out. You can lose control of the saw, result-

ing in injury and/or damage to the saw. Stop the saw; drive a wedge of plastic or wood into cut until the saw can be removed easily. Restart saw and carefully reenter the cut. Do not use a metal wedge. Do not attempt to restart your saw when it is pinched or hung in a log.

Use a wedge to remove pinched saw



Turn saw OFF and use a plastic or wooden wedge to force cut open.

Overcutting begins on the top side of the log with the bottom of the saw against the log. When overcutting use light downward pressure.

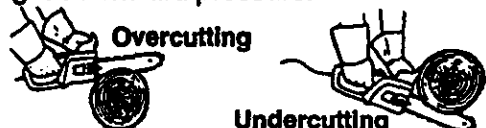

Undercutting involves cutting on the underside of the log with top of saw against the log. When undercutting use light upward pressure. Hold saw firmly and maintain control. The saw will tend to push back toward you.

WARNING: Never turn saw upside down to undercut. The saw cannot be controlled in this position. When the log is supported along its entire length as illustrated below, it is cut from the top (overbuck).



Always make your first cut on the compression side of the log.

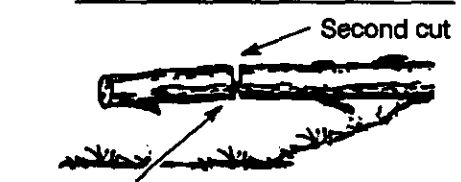
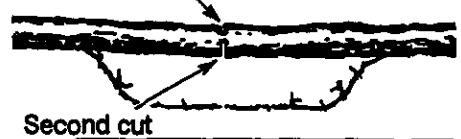

First cut on compression side of log

BUCKING WITHOUT A SUPPORT

- Overcut through 1/3 of the diameter of the log.
- Roll the log over and finish with a second overcut.

- Watch for logs with a compression side. See illustration above for cutting logs with a compression side.

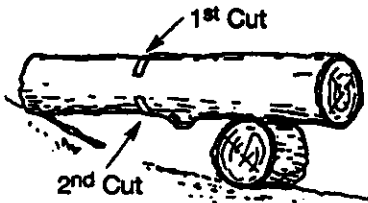
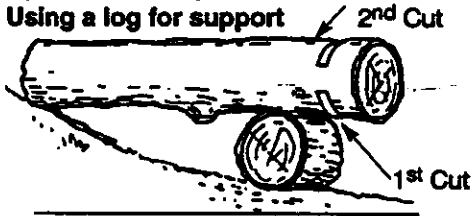

BUCKING USING A LOG OR SUPPORT STAND

- Remember your first cut is always on the compression side of the log. (Refer to the illustration below for your first and second cut)
- Your first cut should extend 1/3 of the diameter of the log.
- Finish with your second cut.

Using a support stand

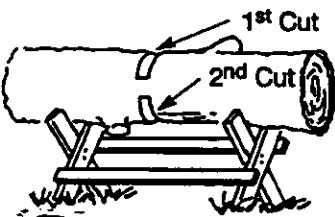
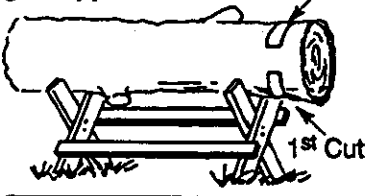

LIMBING AND PRUNING

WARNING: Never climb into a tree to limb or prune. Do not stand on ladders, platforms, a log, or in any position which can cause you to lose your balance or control of the saw.

IMPORTANT POINTS

- Watch out for springpoles. Springpoles are small size limbs which can whip toward you or pull you off balance. Use extreme caution when cutting small size limbs.
- Be alert for springback. Watch out for branches that are bent or under pressure. Avoid being struck by the branch or the saw when the tension in the wood fibers is released.

- Frequently clear branches out of the way to avoid tripping over them.

LIMBING

Remove Small Limbs With One Cut



Limbing is removing the branches from a fallen tree. When limbing, leave larger lower limbs to support the log off the ground. Remove the small limbs in one cut as illustrated in the figure above. Branches under tension should be cut from the bottom up to avoid binding the chain saw.

- Limb a tree only after it is cut down.
- Leave the larger limbs underneath the felled tree to support the tree as you work.
- Start at the base of the felled tree and work toward the top, cutting branches and limbs. Remove small limbs with one cut.
- Keep the tree between you and the chain.
- Remove larger, supporting branches with the 1/3, 2/3 cutting techniques described in the bucking section.
- Always use an overcut to cut small and freely hanging limbs. Undercutting could cause limbs to fall and pinch the saw.

PRUNING

WARNING: Limit pruning to limbs shoulder height or below. Do not cut if branches are higher than your shoulder. Get a professional to do the job.

- Make your first cut 1/3 of the way through the bottom of the limb.
- Next make a second cut all the way through the limb.
- Finish the pruning operation by using an overcut so that the stump of the limb protrudes 1 to 2 inches from the trunk of the tree.

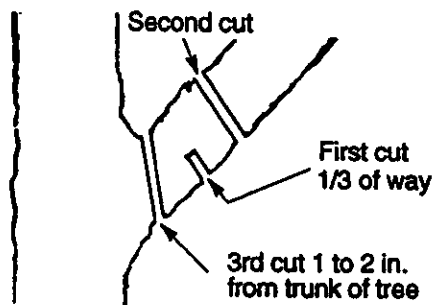

MAINTENANCE

CUSTOMER RESPONSIBILITIES

| Fill in dates as you complete regular service | Before Use | After Use | Every 15 min. | Every 5 hrs. | Yearly | Service Dates |
|---|------------|-----------|---------------|--------------|--------|---------------|
| Check for damaged/worn parts | ✓ | | | ✓ | ✓ | |
| Check for loose fasteners/parts | ✓ | | ✓ | | | |
| Check chain tension | ✓ | | ✓ | | | |
| Check chain sharpness | ✓ | | | ✓ | | |
| Check guide bar | ✓ | | | ✓ | ✓ | |
| Clean unit & labels | | ✓ | | | | |

GENERAL RECOMMENDATIONS

The warranty on this unit does not cover items that have been subjected to operator abuse or negligence. To receive full value from the warranty, the operator must maintain unit as instructed in this manual. Various adjustments will need to be made periodically to properly maintain your unit.

- Once a year, check guide bar and chain for wear.

WARNING: Disconnect the power source before performing maintenance.

LUBRICATION

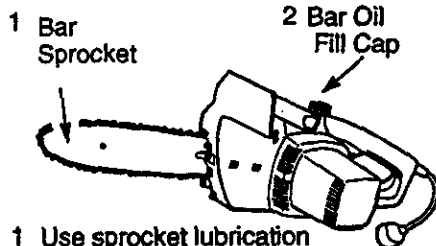

- 1 Use sprocket lubrication
- 2 Use Craftsman chain saw bar oil

CHECK FOR DAMAGED OR WORN PARTS

Replacement of damaged/worn parts should be referred to your Sears Service Center.

NOTE: It is normal for a small amount of oil to appear under the saw after motor stops. Do not confuse this with a leaking oil tank.

- Trigger Switch – Ensure the trigger switch functions properly by squeezing and holding the trigger switch. Make sure motor starts and stops.
- Oil Tank – Discontinue use of chain

saw if oil tank shows signs of damage or leaks.

- Extension Cord – Discontinue use if chain saw extension cord shows signs of damage or wear.

CHECK FOR LOOSE FASTENERS AND PARTS

- Bar Clamp Nut
- Chain
- Bar Adjusting Screw

CHECK CHAIN TENSION

- Use the screwdriver end of the bar tool to move chain around guide bar to ensure kinks do not exist. The chain should rotate freely.

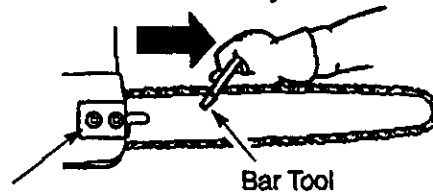

Bar Clamp Nuts

NOTE: It is recommended that the saw be turned upside down for chain tensioning.

- Unplug unit from the power source.
- Loosen bar nuts until they are only finger tight.
- Turn the adjusting screw clockwise until the drive links on the chain enter the guide bar groove.

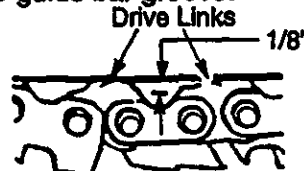

NOTE: To tighten the chain, turn the adjusting screw clockwise; to loosen the chain, turn the adjusting screw counterclockwise.

Adjusting Screw

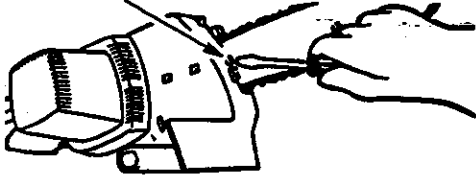

- Check the tension by lifting the chain from the guide bar. Remove some of the stiffness in the chain by pulling down and letting go of the chain several times.

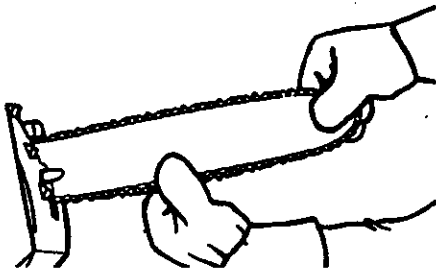

- Continue turning the adjusting screw until the tension is correct.
- Tighten bar mounting nuts with a wrench.
- Recheck chain tension.

CHECK CHAIN SHARPNESS

A sharp chain makes wood chips. A dull chain makes a sawdust powder and cuts slowly.

CHAIN SHARPENING

Chain sharpening requires special tools. You can purchase sharpening tools at Sears or go to a professional chain sharpener.

CHECK GUIDE BAR

Conditions which require guide bar maintenance:

- Saw cuts to one side or at an angle.
- Saw has to be forced through the cut.
- Inadequate supply of oil to the bar and chain.

Check the condition of the guide bar each time the chain is sharpened. A worn guide bar will damage the chain and make cutting difficult. To maintain guide bar:

- Disconnect the chain saw from the power source. See instructions under "Chain Replacement".
- Remove bar and chain from saw.
- Clean all sawdust and any other debris from the guide bar groove and sprocket hole after each use.

Remove Sawdust From Guide Bar Groove

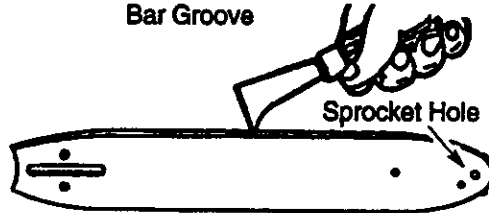

- Add lubricant to sprocket hole after each use.
- Burring of guide bar rails is a normal process of rail wear. Remove these burrs with a flat file.
- When rail top is uneven, use a flat file to restore square edges and sides.



Worn Groove

File Edges and sides Square



Correct Groove

Replace the guide bar when the groove is worn, the guide bar is bent or cracked, or when excess heating or burring of the rails occurs. If replacement is necessary, use only the guide bar specified for your saw in the repair parts list or on the decal located on the chain saw.

CLEAN UNIT & LABELS

- Clean the unit and labels using a damp cloth with a mild detergent.
- Wipe off the unit and labels with a clean dry cloth.

SERVICE AND ADJUSTMENTS

CHAIN REPLACEMENT

WARNING: Avoid accidental starting. Always unplug saw from power source before installing a bar and/or chain.

CAUTION: Wear protective gloves when handling chain. The chain is sharp and can cut you even when it is not moving.

It is normal for a new chain to stretch during the first 30 minutes of operation. You should recheck your chain tension frequently and adjust the chain tension as required. See "Check Chain Tension" in the Maintenance section.

- Turn the unit upside down on a flat surface. Straighten out chain, then lay it on a flat surface.

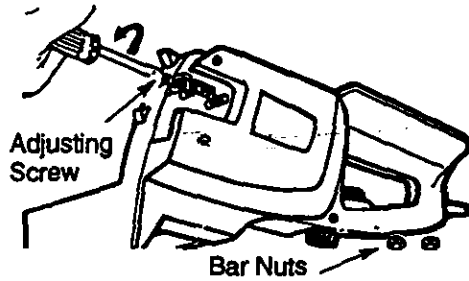

- Remove bar mounting nuts, bar clamp plate, and old chain.
- Turn the adjusting screw counter-clockwise to move the adjusting pin almost as far as it will go to the rear. Do not remove the adjusting screw from the unit.

REPLACEMENT SAW CHAIN

- See "Customer Serviceable Parts". A chain must comply with the kickback performance requirements of ANSI B175.1 when tested with this saw.
- Hold chain with cutters facing as shown.

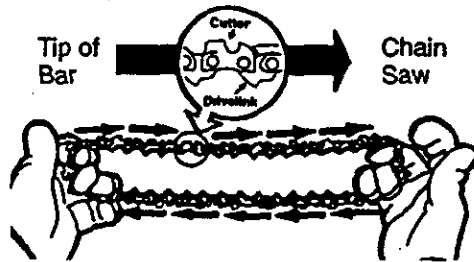

CUTTERS MUST FACE IN DIRECTION OF ROTATION

- Slide the chain between the housing and the sprocket. Place chain around the sprocket and fit the drive links into the guide bar groove and then around guide bar nose.

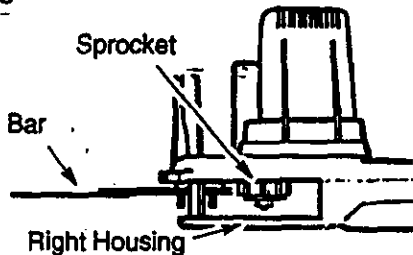

- Hold the guide bar against the saw frame and install the bar clamp plate. Be sure the tab on the bar clamp plate is toward the rear of bar.

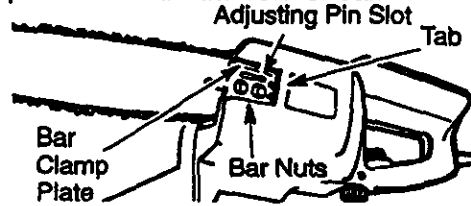

- Secure the guide bar and bar clamp plate with the bar nuts; tighten finger tight *only*.

CAUTION: If saw chain is installed backwards, the saw will vibrate excessively and will not cut wood.

CHAIN ADJUSTMENT

See "Check Chain Tension" in Maintenance section.

CUSTOMER SERVICEABLE PARTS

WARNING: Use of any other accessory or attachment might present a risk of injury to the operator.

| REPLACEMENT PART | PART NO. |
|------------------------------|-----------|
| Hex Nuts | 530015303 |
| Oil Cap | 530029282 |
| Guide Plate | 530029285 |
| Safety Lock Button | 530025873 |
| Bar Adjusting Screw | 530015514 |
| Bar Adjusting Pin | 530023492 |
| Spacer | 530015832 |
| Spacer Screw | 530015835 |
| File (5/32" dia.) Twin Pak | 7136524 |
| File Guide (File Holder) | 7136565 |
| Depth Gauge Tool | 7136557 |
| Xtra GUARD® Chain -16" | 713629 |
| Lo-Kick® Guide Bar - 16" | 7136366 |
| Bar & Chain Lubricant -1 qt | 7136556 |
| Bar & Chain Lubricant -1 gal | 7136554 |

STORAGE

Prepare your unit for storage at the end of the season or if it will not be used for 30 days or more.

WARNING:

- Allow the motor to cool, then secure the unit before storing or transporting.
- Store chain saw and extension cord in a well ventilated area
- Store chain saw with all guards in place and position chain saw so that any sharp object cannot accidentally cause injury.
- Store chain saw unplugged, well out of the reach of children.

EXTERNAL SURFACES

If your chain saw is to be stored for a period of time, clean it thoroughly before storage. Store in a clean dry area.

- Lightly oil external metal surfaces and guide bar.
- Oil the chain and wrap it in heavy paper or cloth.

To prevent chain oil seepage during storage, store the saw as follows:

- upside down if stored on a shelf, or
- hung on a hook or nail through the hole in the bar

TROUBLE SHOOTING CHART

| TROUBLE | CAUSE | REMEDY |
|---|--|--|
| Chain does not move when trigger switch is engaged. | <ul style="list-style-type: none"> • Chain tension too tight. • Guide bar rails pinched. • Trigger Switch failure. • Circuit breaker tripped/fuse blown. | <ul style="list-style-type: none"> • See "Chain Tension." • Repair or replace. • Contact Sears Service. • Reset circuit breaker/replace fuse. |
| Chain clatters or cuts roughly. | <ul style="list-style-type: none"> • Chain tension incorrect. • Cutters damaged. • Chain worn. • Cutters dull, improperly sharpened, or depth gauges too high. • Sprocket worn. | <ul style="list-style-type: none"> • See "Chain Tension." • Resharpener or replace chain. • Resharpener or replace chain. • See "Chain Sharpening" instructions. • Contact Sears Service. |
| Chain stops within the cut. | <ul style="list-style-type: none"> • Chain cutter tops not filed flat. • Guide bar burred or bent; rails uneven. | <ul style="list-style-type: none"> • See the chain sharpening instructions. • Repair or replace guide bar. |
| Oil inadequate for bar and chain lubrication. | <ul style="list-style-type: none"> • Oil tank empty. • Oil outlet clogged. • Guide bar oil hole blocked. | <ul style="list-style-type: none"> • Fill oil tank. • Contact Sears Service. • Remove bar and clean. |
| Chain cuts at an angle. | <ul style="list-style-type: none"> • Cutters damaged on one side. • Chain dull on one side. • Guide bar bent or worn. | <ul style="list-style-type: none"> • See "Sharpening Chain." • See "Sharpening Chain." • Replace guide bar. |

If situations occur which are not covered in this manual, use care and good judgement. If you need assistance, contact Sears Service or the CUSTOMER ASSISTANCE HELPLINE at 1-800-235-5878.

COMMON CHAIN SAW TERMS

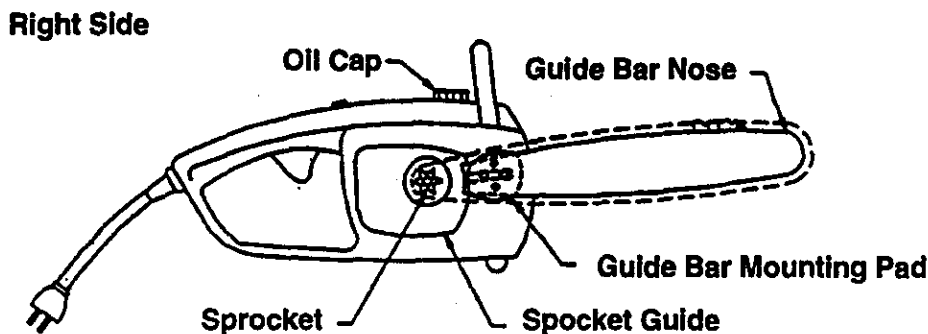
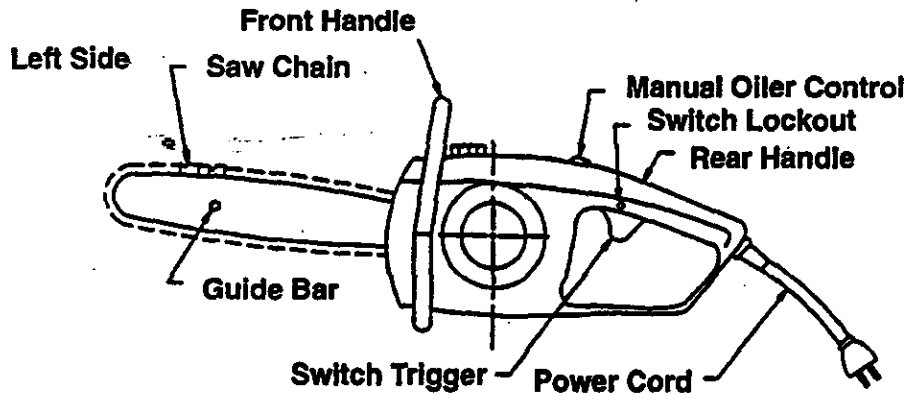

Bar Tip Guide – An attachment that may be provided on the end of the guide bar to prevent the chain at the end of the guide bar from contacting the wood.

Bucking – The process of cross cutting a felled tree or log into lengths.

Chain Brake – A device used to stop the chain saw.

Chain Saw Powerhead – A chain saw without the saw chain and guide bar.

Clutch – A mechanism for connecting and disconnecting a driven member to and from a rotating source of power.

Drive Sprocket or Sprocket – The toothed part that drives the saw chain.

Felling – The process of cutting down a tree.

Felling Back Cut – The final cut in a tree felling operation made on the opposite of the tree from the notching undercut.

Front Handle – The support handle located at or toward the front of the chain saw.

Front Handle Guard – A structural barrier between the front handle of a chain saw and the guide, typically located close to the hand position on the front handle and sometimes employed as an activating lever for a chain brake.

Guide Bar – A solid railed structure that supports and guides the saw chain.

Kickback – The backward or upward motion, or both of the guide bar occurring when the saw chain near the nose of the top area of the guide bar contacts any object such as a log or branch, or when the wood closes in and pinches the saw chain in the cut.

Kickback, Pinch – The rapid push-back of the saw which can occur when the wood closes in and pinches the moving saw chain in the cut along the top of the guide bar.

Kickback, Rotational – The rapid upward and backward motion of the saw which can occur when the moving saw chain near the upper portion of the tip of the guide bar contacts an object, such as a log or branch.

Low-Kickback Chain – A chain that complies with the kickback performance requirements of ANSI B175.1-1991 when tested on a representative sample of chain saws.

Normal Cutting Position – Those positions assumed in performing the bucking and felling cuts.

Notching Undercut – A notch cut in a tree that directs the tree's fall.

Continued on next page

Oiler Control – A system for oiling the guide bar and saw chain.

Rear Handle – The support handle located at or toward the rear of the saw.

Reduced Kickback Guide Bar – A guide bar which has been demonstrated to reduce kickback significantly.

Replacement Saw Chain – A chain that complies with the kickback performance requirements of ANSI

B175.1–1991 when tested with specific chain saws. It may not meet the ANSI performance requirements when used with other saws.

Saw Chain – A loop of chain having cutting teeth, that cut the wood, and

that is driven by the motor and is supported by the guide bar.

Spiked Bumper (Spike) – The pointed tooth or teeth for use when felling or bucking to pivot the saw and maintain position while sawing.

Switch – A device that when operated will complete or interrupt an electrical power circuit to the motor of the chain saw.

Switch Linkage – The mechanism that transmits motion from the trigger to the switch.

Switch Lockout – A movable stop that prevents the unintentional operation of the switch until manually actuated.

For the repair or replacement parts you need delivered directly to your home

Call 7 am – 7 pm, 7 days a week

1-800-366-PART

(1-800-366-7278)

Para ordenar piezas con entrega a domicilio – 1-800-659-7084

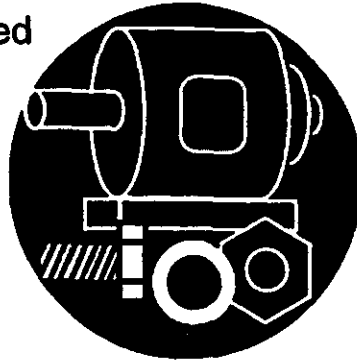

For in-house major brand repair service

Call 24 hours a day, 7 days a week

1-800-4-REPAIR

(1-800-473-7247)

Para pedir servicio de reparación a domicilio – 1-800-676-5811



For the location of a Sears Parts and Repair Center in your area

Call 24 hours a day, 7 days a week

1-800-488-1222



For information on purchasing a Sears Maintenance Agreement or to inquire about an existing Agreement

Call 9 am – 5 pm, Monday–Saturday

1-800-827-6655



When requesting service or ordering parts, always provide the following information:

- Product Type
- Part Number
- Model Number
- Part Description

SEARS
REPAIR SERVICES
America's Repair Specialists