

# Operator's Manual

# CRAFTSMAN®

4.5 Amp  
14 Inch Cutting Path/.065 In. Line  
**ELECTRIC WEEDWACKER®**

Model No.  
**358.799270**

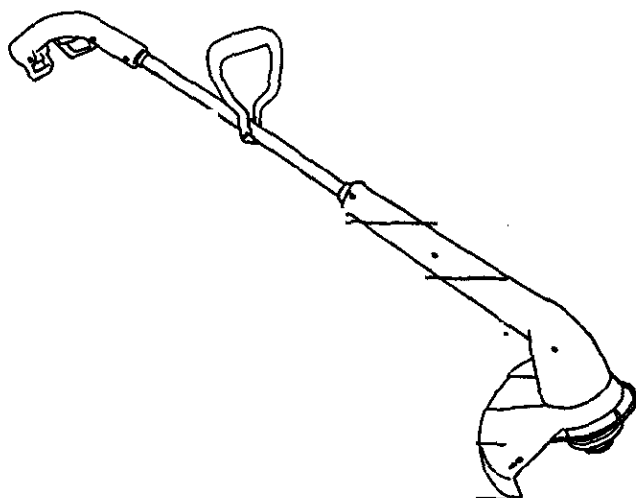

## WARNING:

Read and follow all Safety Rules and Operating Instructions before first use of this product.



For answers to your questions about this product:  
Call 7 am-7 pm, Mon-Sat; 10 am-7 pm, Sun

**1-800-235-5878** (Hours listed are Central Time)

Sears, Roebuck and Co., Hoffman Estates, IL 60179 USA

530087636 08/14/98

SAFETY

ASSEMBLY

OPERATION

MAINTENANCE

ESPAÑOL

## TABLE OF CONTENTS

Limited Warranty Statement . . . . .	2	Service & Adjustments . . . . .	8
Safety Rules . . . . .	2	Storage . . . . .	10
Assembly . . . . .	5	Troubleshooting Chart . . . . .	10
Operation . . . . .	6	Spanish . . . . .	11
Maintenance . . . . .	8	Parts Ordering . . . . .	Back

## LIMITED WARRANTY STATEMENT

### FULL ONE YEAR WARRANTY ON CRAFTSMAN ELECTRIC WEEDWACKER® LINE TRIMMER

If this Craftsman Electric Weedwacker® Line Trimmer fails to perform properly due to a defect in material or workmanship within (1) one year from the date of purchase, Sears will repair or replace it, free of charge.

This warranty does not cover the nylon line.

WARRANTY SERVICE IS AVAILABLE BY RETURNING THE CRAFTSMAN ELECTRIC WEEDWACKER® LINE TRIMMER TO THE NEAREST SEARS STORE IN THE UNITED STATES.

This warranty gives you specific legal rights, and you may also have other rights which vary from state to state.

Sears, Roebuck and Co. Dept. D/817WA Hoffman Estates, IL 60179

## SAFETY RULES

**WARNING:** When using electric gardening appliances, basic safety precautions must always be followed to reduce the risk of fire, electric shock, and serious injury. Read and follow all instructions.



Safety information on the unit

*This power unit can be dangerous!* Operator is responsible for following unit and manual instructions and warnings. Read entire Operator's Manual before using unit! Be thoroughly familiar with the controls and the proper use of the unit. Restrict the use of this unit to persons who read, understand, and follow unit and manual warnings and instructions. Never allow children to operate this unit.

**DANGER:** Never use blades or flailing devices. Unit is designed for line trimmer use only. Use of any other accessories or attachments will increase the risk of injury.



**WARNING:** Trimmer line throws objects violently. You and others can be blinded/injured. Wear safety glasses, boots, and leg protection. Keep body parts clear of rotating line.

Safety Glasses or similar eye protection

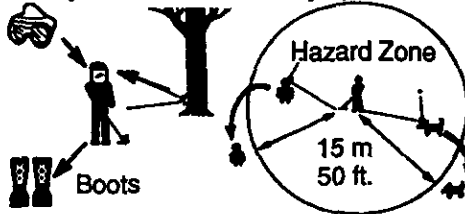

Keep children, bystanders, and animals 50 feet (15 meters) away. If approached stop unit immediately.

If situations occur which are not covered in this manual, use care and good judgement. If you need assistance, call 1-800-235-5878

### OPERATOR SAFETY

- Dress properly. Always wear safety glasses or similar eye protection when operating, or performing maintenance on your unit. (Safety glasses are available.) Always wear face or dust mask if operation is dusty. Always wear heavy, long pants, long

sleeves, boots, and gloves. Do not go barefoot or wear sandals.

- Secure hair above shoulder length. Secure or remove loose clothing and jewelry or clothing with loosely hanging ties, straps, tassels, etc. They can be caught in moving parts.
- Being fully covered also helps protect you from debris and pieces of toxic plants thrown by spinning line.
- Stay Alert. Do not operate unit when you are tired, ill, upset, or under the influence of alcohol, drugs, or medication. Watch what you are doing; use common sense.
- Avoid unintentional starting of the unit. Never carry unit with your finger on the switch. Be sure the switch is in off position when connecting extension cord.

#### **ELECTRICAL SAFETY**

- Use a voltage supply as shown on unit.
- Avoid dangerous environment. Don't use appliances in damp or wet locations. Don't use in rain.
- Avoid dangerous situations. Do not use in the presence of flammable liquids or gases to avoid creating a fire or explosion and/or causing damage to unit.
- To reduce the risk of electrical shock, this appliance has a polarized plug (one blade is wider than the other) and will require the use of a polarized extension cord. The appliance plug will fit into a polarized extension cord only one way. If the plug does not fit fully into the extension cord, reverse the plug. If the plug still does not fit, obtain a correct polarized extension cord. A polarized extension cord will require the use of a polarized wall outlet. This plug will fit into the polarized wall outlet only one way. If plug does not fit fully into the wall outlet, reverse the plug. If the plug still does not fit, contact a qualified electrician to install the proper wall outlet. Do not change the equipment plug, extension cord receptacle, or extension cord plug in any way.
- To reduce risk of electrical shock, use extension cords specifically marked as suitable for outdoor appliances having electrical rating not less than the rating of unit. Cord

must be marked with suffix "W-A" (in Canada "W"). Make sure your extension cord is in good condition. Inspect extension cord before use and replace if damaged. An undersized extension cord will cause a drop in line voltage resulting in loss of power and overheating. If in doubt, use the next heavier gauge. The lower the gauge number, the heavier the cord. (See "Selecting an extension cord")

- Do not abuse cord. Never carry the unit by the extension cord or yank extension cord to disconnect unit.
- Use cord retainer to prevent disconnection of extension cord from unit. See "Attach the extension cord to your trimmer" under the section titled "OPERATION".
- Do not use the unit if the switch does not turn the unit on and off properly. Repairs to the switch must be made by your Sears Service Center.
- Keep the extension cord clear of operator and obstacles at all times. Do not expose cords to heat, oil, water, or sharp edges.
- To avoid the possibility of electric shock, avoid body contact with any grounded conductor, such as metal fences or pipes,
- Ground Fault Circuit Interrupter (GFCI) protection should be provided on circuit or outlet to be used. Receptacles are available having built-in GFCI protection and may be used for this measure of safety.

#### **UNIT SAFETY**

- Inspect unit before use. Replace damaged parts. Make sure all handles, guards, shields, and fasteners are in place and securely fastened. Parts that are damaged must be repaired or replaced by a Sears Service Center. These include head parts that are cracked or chipped, guards, shields, or any other part that is damaged.
- Do not repair unit yourself.
- Use only .065" (1.65 mm) diameter recommended trimmer line (see "Service and Adjustments"). Never use wire, rope, string etc.

- Use specified trimmer spool. Make sure spool is properly installed and all parts are securely fastened.
- Use only recommended replacement parts and accessories.

### **CUTTING SAFETY.**

- Inspect area to be cut. Remove objects (rocks, broken glass, nails, wire, string, etc.) which can be thrown or become entangled in cutting head.
- Do not overreach or stand on unstable support. Keep firm footing and balance.
- Keep the cutting head below waist level. Do not raise handles above your waist. Cutting head can come dangerously close to your body.
- Keep away from spinning line.
- Use unit properly. Use only for trimming, edging, scalping, and mowing. Do not force unit. It will do the job better and with less risk of injury at the rate for which it was designed.
- Use only in daylight or in good artificial light.

### **MAINTENANCE SAFETY**

- Maintain unit according to recommended procedures. Keep cutting line at proper length. Follow instructions for changing trimmer line.
- Have all service and maintenance not explained in this manual performed by a Sears Service Center to avoid creating a hazard.
- Disconnect unit from the power supply before performing maintenance, or when changing trimmer line.
- Never douse or squirt the unit with water or any other liquid. Clean unit and labels with a damp sponge. Keep handles dry, clean, and free from oil and grease.
- Keep the air vents clean and free from debris to avoid overheating the motor. Clean after each use.

### **TRANSPORTING AND STORAGE**

- Stop the unit and disconnect the power source when not in use.
- Carry the unit with motor stopped.
- Store the unit so the line limiter blade cannot cause injury.
- Store unit indoors in a high, dry place out of the reach of children. Store unit unplugged.

### **DOUBLE INSULATION CONSTRUCTION**

This unit is Double Insulated to help protect against electric shock. Double insulation construction consists of two separate "layers" of electrical insulation instead of grounding.

Tools built with this insulation system are not intended to be grounded. No grounding means is provided on this unit, nor should a means of grounding be added to this unit.

Safety precautions must be observed when operating any electrical tool. The double insulation system only provides added protection against injury resulting from an internal electrical insulation failure.

**WARNING:** All electrical repairs to this unit, including housing, switch, motor, etc., must be diagnosed and repaired by qualified service personnel. Replacement parts for a double insulated appliance must be recommended by the manufacturer. A double insulated appliance is marked with the words "double insulation" or "double insulated." The symbol (square within a square)  may also be marked on the appliance. Failure to have the unit repaired by qualified service personnel can cause the double insulation construction to become ineffective and result in serious injury.

### **SAVE THESE INSTRUCTIONS**

## ASSEMBLY

### CARTON CONTENTS

Check carton contents against the following list.

#### Model 799270

- Trimmer
- Shield
- Tree Guard
- Extra Spool

Examine parts for damage. Do not use damaged parts.

**NOTE:** If you need assistance or find parts missing or damaged, call 1-800-235-5878.

### ASSEMBLY

**WARNING:** If received assembled, review all assembly steps to ensure your unit is properly assembled and all fasteners are secure.

- Extend the tube until it snaps into place.

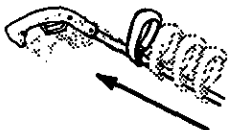

### ADJUSTING THE HANDLE

- Loosen wing nut or knob on handle.
- Rotate the handle on the tube to an upright position; place in a comfortable position and retighten wing nut.

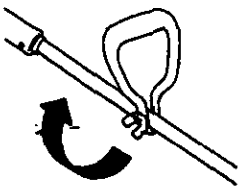

### ATTACHING THE SHIELD

**WARNING:** The shield must be properly installed. The shield provides partial protection from the risk of thrown objects to the operator and others. Your unit is equipped with a line limiter blade, which cuts excess line to the proper length while running. The line limiter blade (on underside of shield) is sharp and can cut you.

- Align the installation arrow on the shield with the arrow on the motor housing.
- Insert the shield onto the motor housing.
- Twist the shield until it snaps securely into place. Make sure the shield is facing the back of the unit as illustrated on the front cover of this manual.

**CAUTION:** Sharp blade.

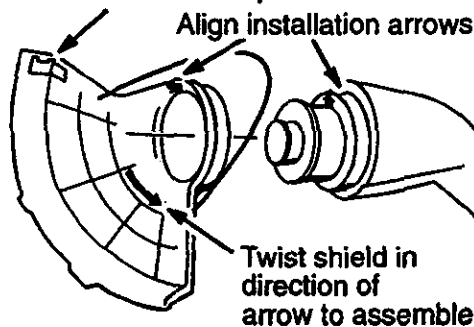

## OPERATION

### KNOW YOUR TRIMMER

READ THIS OPERATOR'S MANUAL AND SAFETY RULES BEFORE OPERATING YOUR UNIT. Compare the illustrations with your unit to familiarize yourself with the location of the various controls and adjustments. Save this manual for future reference.

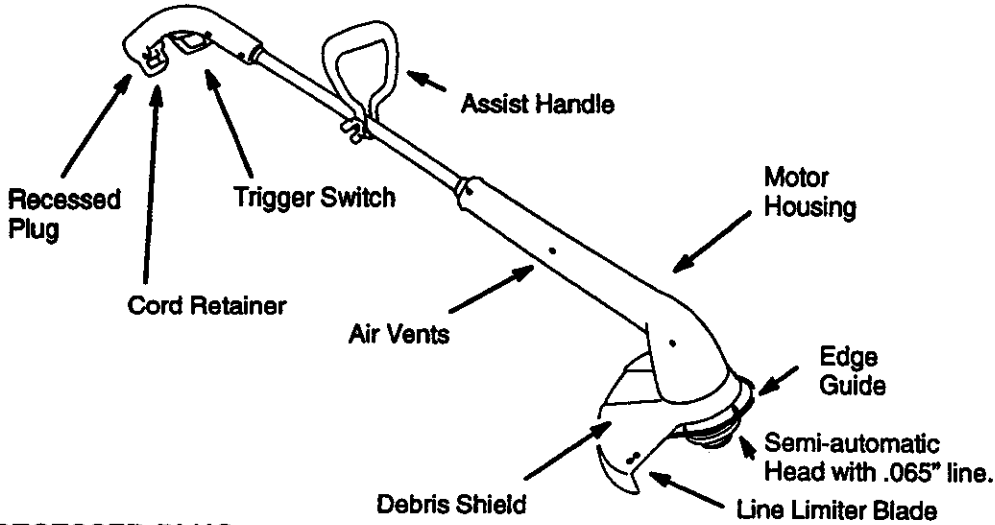

#### RECESSED PLUG

The recessed plug is where you attach your extension cord to the unit.

#### TRIGGER SWITCH

The trigger switch is used to turn on the unit. Squeeze the trigger switch to operate the unit.

#### LINE LIMITER BLADE

The line limiter blade trims the cutting line to the proper cutting length.

#### ASSIST HANDLE

The assist handle is used to help hold and guide the unit.

#### SEMI-AUTOMATIC HEAD

The semi-automatic head holds the cutting line and rotates during operation.

#### EDGE GUIDE

The edge guide protects the unit from contacting the ground during edging.

### OPERATING INSTRUCTIONS

Use only a voltage supply as specified on your unit.

#### SELECT AN EXTENSION CORD

Extension Cord Gauge Chart	
Length of Cord	Gauge
25 Ft.	18 Gauge
50 Ft.	16 Gauge
100 Ft.	16 Gauge

Extension cords are available for this unit.

#### ATTACH THE EXTENSION CORD TO YOUR TRIMMER

Loop your extension cord through the handle and around the hook. Insure the plug and cord are firmly and fully engaged.

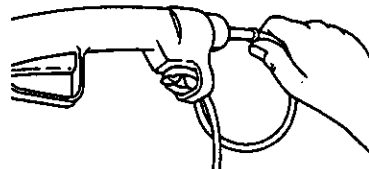

**CORRECT OPERATING POSITION**

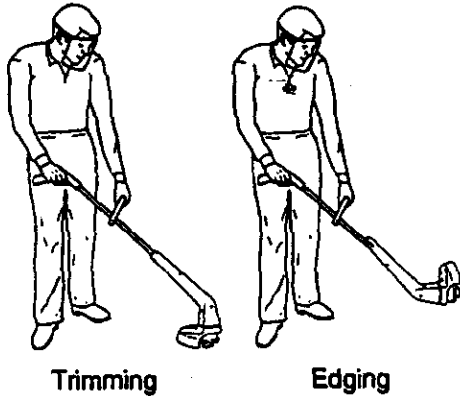

Stand as shown and check for the following:

- Operator wearing eye protection and heavy clothing.
- Both hands holding handles.
- Unit below waist level.
- Use the left side for trimming so debris is thrown away from the operator. Without operator bending over, keep the line near and parallel to ground (perpendicular when edging) and not crowded into material being cut.

**WARNING:** Always wear eye protection. Never lean over the trimmer head. Rocks or debris can ricochet or be thrown into eyes and face and cause blindness or other serious injury.

**ADVANCING THE CUTTING LINE**

Advance line by tapping bottom of cutting head lightly on the ground while unit is running at full speed. The line limiter blade attached to the shield will cut the line to the proper length.

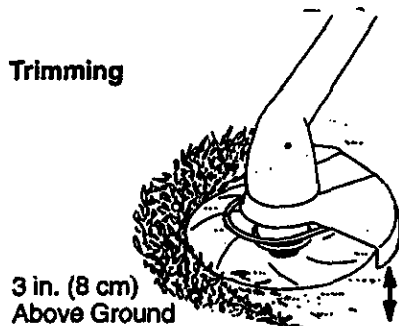

**TRIMMING**

Hold the bottom of the trimmer head about 3 in. (8 cm) above the ground and at an angle. Allow only the tip of

the line to make contact. Do not force trimmer line into work area.

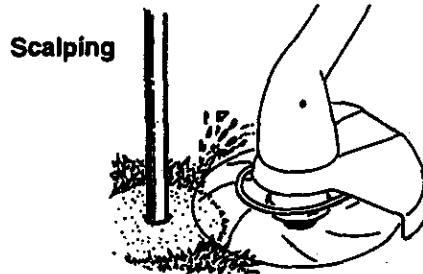

**SCALPING**

The scalping technique removes unwanted vegetation. Hold the bottom of the trimmer head about 3 in. (8 cm) above the ground and at an angle. Allow the tip of the line to strike the ground around trees, posts, monuments, etc. This technique increases line wear.

**Mowing**

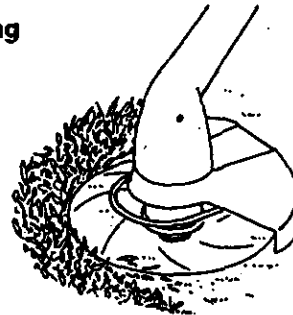

**MOWING**

Your trimmer is ideal for mowing in places conventional lawn mowers cannot reach. In the mowing position, keep the line parallel to the ground. Avoid pressing the head into the ground as this can scalp the ground and damage the tool.

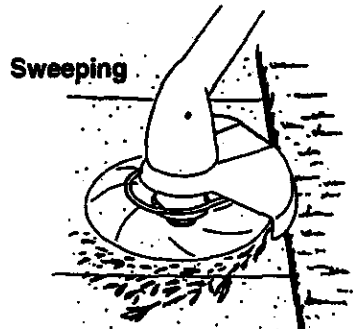

**SWEEPING**

The fanning action of the rotating line can be used for a quick and easy clean up. Keep the line parallel to and above the surfaces being swept and move the tool from side to side.

## EDGING POSITION

Press the button and twist the lower portion 180° into an edging position.

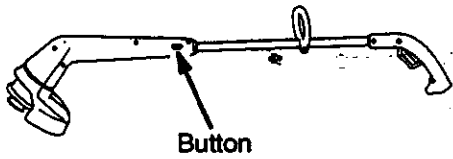

## EDGING

While edging allow the tip of the line to make contact. Do not force the line. The edge guard helps protect the unit and keeps the unit from contacting the

ground. Take extra caution while edging as objects can be thrown from the trimmer line.

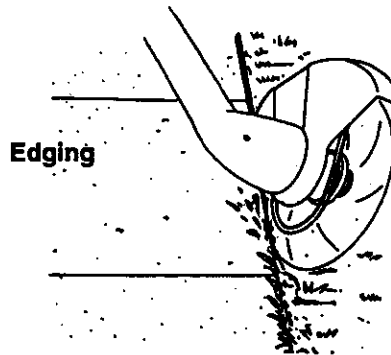

## MAINTENANCE

### CUSTOMER RESPONSIBILITIES

CARE & MAINTENANCE TASK	WHEN TO PERFORM
Check for loose fasteners and parts	Before each use
Check for damaged or worn parts	Before each use
Clean unit and labels	After each use

### GENERAL RECOMMENDATIONS

The warranty on this unit does not cover items that have been subjected to operator abuse or negligence. To receive full value from the warranty, the operator must maintain unit as instructed in this manual. Various adjustments will need to be made periodically to properly maintain your unit.

### CHECK FOR LOOSE FASTENERS AND PARTS

- Housing Screws
- Assist Handle Screw
- Debris Shield
- Edge Guide

### CHECK FOR DAMAGED OR WORN PARTS

Refer replacement of damaged/worn parts to your Sears Service Center.

- Trigger Switch – Ensure switch functions properly by pressing and releasing the trigger switch. Make sure motor stops.
- Debris Shield – Discontinue use of unit if debris shield is damaged.

### CLEAN UNIT & LABELS

- Clean the unit using a damp cloth with a mild detergent.
- Wipe off unit with a clean dry cloth.

## SERVICE AND ADJUSTMENTS

### REPLACING THE LINE

- Remove the spool by firmly pulling on the tap button.
- Clean entire surface of hub and spool.
- Replace with a pre-wound spool (# 71-85837), or cut a length of 30 feet of .065" (1.6 mm) diameter Craftsman® Pro Trimmer line. Use of heavier lines could overload the unit and damage unit. Never use wire,

rope, string, etc., which can break off and become a dangerous missile.

- Insert one end of the line about 1/2 inch (1 cm) into the small hole inside the spool.
- Wind the line evenly and tightly onto the spool. Wind in the direction of the arrow found on the spool.
- Push the line into the notch, leaving 3 to 5 inches (7 – 12 cm) unwound.

- Insert the line into the exit hole in the hub as shown in the illustration.
- Align the notch with the line exit hole.
- Push the spool into the hub until it snaps into place.
- Pull the line extending outside the hub to release it from the notch.

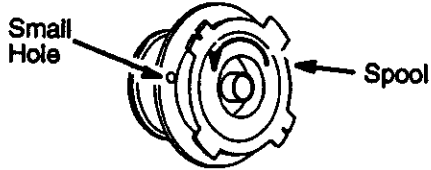
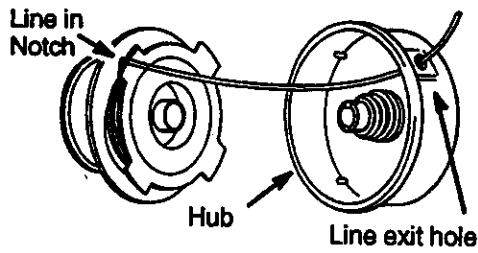

### USER REPLACEABLE SERVICE PARTS

REPLACEMENT PART	PART NUMBER
Spool with .065" Pro Trimmer Line	71-85837
Assist Handle	530402657
Bolt Carriage, 1/4-20	530401989
Wing Nut	530016152
Shield Assy.	530402672
Edge Guide	530402663
Screw, 10-16 X 1/2 HI-LO SEMS	530015815



## STORAGE

Prepare unit for storage at end of season or if it will not be used for 30 days or more.

**WARNING:**

- Stop the unit and disconnect the power source when not in use.
- Carry the unit with motor stopped.
- Store the unit so the line limiter blade

cannot cause injury.

- Store unit and extension cord indoors in a high, dry place out of the reach of children. Store unit unplugged.
- Store unit with all guards in place. Position unit so that any sharp object cannot accidentally cause injury.

### TROUBLESHOOTING CHART

TROUBLE	CAUSE	REMEDY
Trimmer head stops under a load or does not turn when switch is pressed.	<ul style="list-style-type: none"> <li>• Crowding trimmer line against material being cut.</li> <li>• Electrical failure.</li> <li>• Thrown circuit breaker</li> <li>• Debris stopping head</li> </ul>	<ul style="list-style-type: none"> <li>• Allow tip of line to do the cutting.</li> <li>• Contact your Sears Service Center.</li> <li>• Check Breaker Box.</li> <li>• Remove debris.</li> </ul>
Line does not advance or breaks while cutting.	<ul style="list-style-type: none"> <li>• Line improperly routed in head.</li> <li>• Line improperly wound onto spool.</li> <li>• Incorrect line size</li> <li>• Not enough line outside head.</li> <li>• Dirt buildup on cover.</li> <li>• Crowding trimmer line against material being cut.</li> </ul>	<ul style="list-style-type: none"> <li>• Check line routing.</li> <li>• Rewind line tightly and evenly.</li> <li>• Use only .065 in. diameter line.</li> <li>• Pull 4 Inches of line outside head.</li> <li>• Clean cover.</li> <li>• Allow tip of line to do the cutting.</li> </ul>
Line welds onto spool.	<ul style="list-style-type: none"> <li>• Line size is incorrect.</li> <li>• Incorrect spool.</li> <li>• Line is being crowded against material being cut.</li> </ul>	<ul style="list-style-type: none"> <li>• Use only .065 in. diameter line.</li> <li>• Replace with correct spool.</li> <li>• Cut with tip of line fully extended.</li> </ul>
Line releases continuously.	<ul style="list-style-type: none"> <li>• Line improperly routed in head.</li> <li>• Spool damaged.</li> </ul>	<ul style="list-style-type: none"> <li>• Check line routing.</li> <li>• Replace spool.</li> </ul>
Line usage is excessive.	<ul style="list-style-type: none"> <li>• Line improperly routed in head.</li> <li>• Line size is incorrect.</li> <li>• Crowding line against material being cut.</li> <li>• Spool teeth worn or damaged.</li> </ul>	<ul style="list-style-type: none"> <li>• Check line routing.</li> <li>• Use only .065 in. diameter line.</li> <li>• Cut with tip of line fully extended.</li> <li>• Replace Spool</li> </ul>
Line pulls back into head.	<ul style="list-style-type: none"> <li>• Too little line outside head.</li> <li>• Line size incorrect.</li> </ul>	<ul style="list-style-type: none"> <li>• Remove cover and pull 4 inches of line outside head.</li> <li>• Use only .065 in. diameter line.</li> </ul>



For the repair or replacement parts you need delivered directly to your home

Call 7 am – 7 pm, 7 days a week

**1-800-366-PART**

(1-800-366-7278)

Para ordenar piezas con entrega a domicilio – 1-800-659-7084

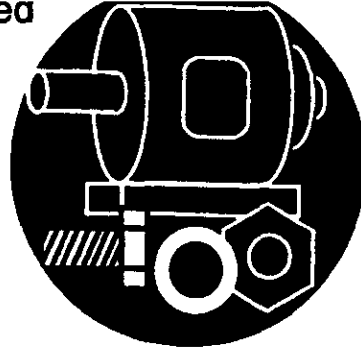

For in-house major brand repair service

Call 24 hours a day, 7 days a week

**1-800-4-REPAIR**

(1-800-473-7247)

Para pedir servicio de reparación a domicilio – 1-800-676-5811



For the location of a Sears Parts and Repair Center in your area

Call 24 hours a day, 7 days a week

**1-800-488-1222**



For information on purchasing a Sears Maintenance Agreement or to inquire about an existing Agreement

Call 9 am – 5 pm, Monday–Saturday

**1-800-827-6655**



When requesting service or ordering parts, always provide the following information:

- Product Type
- Part Number
- Model-Number
- Part Description

**SEARS**  
**REPAIR SERVICES**  
*America's Repair Specialists*