

# USER'S GUIDE

Important Information.....i

Table of Contents.....1

Quick Guide to Your TV .....2-5

Using Your Remote.....6-15

Adjusting Your TV .....16-19

Using Advanced Features...20-27

References.....28-37



C O L O R T V

# Important Information

## WARNING

To reduce the risk of fire or shock hazard, do not expose this TV to rain or moisture.

## WARNING

RISK OF ELECTRIC SHOCK  
DO NOT OPEN

TO REDUCE THE RISK OF ELECTRIC SHOCK, DO NOT REMOVE COVER (OR BACK). NO USER SERVICEABLE PARTS INSIDE. REFER SERVICING TO QUALIFIED SERVICE PERSONNEL.



This symbol indicates "dangerous voltage" inside the product that presents a risk of electric shock or personal injury.



This symbol indicates important instructions accompanying the product.

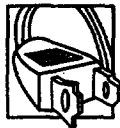

To prevent electric shock, match wide blade of plug to wide slot, fully insert.

## Cautions

Do not defeat the safety feature of the plug. The wide blade fits into the wall socket only one way. If you need an extension cord, make sure it matches the plug of the TV.

Operate TV only on 120 volts, 60 Hz AC power (normal house power).

For safety reasons, make sure any equipment or accessories connected to this product bears the UL listing mark or if purchased and used in Canada the CSA certification mark. If in doubt, contact qualified service personnel.

FCC Regulations state that unauthorized changes or modifications to this equipment may void the user's authority to operate it.

**CAUTION:** If fixed (non-moving) images are left on the screen for long periods, they may be permanently imprinted on the screen. Such images include network logos, phone numbers, and video games. Extended viewing of channels displaying these images should be avoided.

## Note To Cable TV Installer

This reminder is provided to call your attention to Article 820-40 of the National Electrical Code (Section 54 of the Canadian Electrical Code, Part 1) which provides guidelines for proper grounding and, in particular, specifies that the cable ground shall be connected to the grounding system of the building as close to the point of cable entry as practical.

Please fill out the product registration card and return it immediately. Returning this card allows us to contact you if needed.

Keep your sales receipt to obtain warranty parts and service and for proof of purchase. Attach it here and record the serial and model numbers in case you ever need them. The numbers are located on the back of the TV.

Model No. \_\_\_\_\_

Serial No. \_\_\_\_\_

Purchase Date: \_\_\_\_\_

Dealer/Address/Phone: \_\_\_\_\_

## Product Registration

# Table of Contents

## Important Information

Warning, Product Registration \_\_\_\_\_ i

## Quick Guide to Your TV

Startup \_\_\_\_\_ 2-3

Hook up your TV, Plug in the TV, Put Batteries in the Remote,  
Turn on the TV, Place Channels into Memory, Set the Time

Basic Tour of the Remote \_\_\_\_\_ 4

Basic Button Layout and Functions

Menu Basics \_\_\_\_\_ 5

Colors, Menu Buttons, Moving through the Menus

## Using Your TV and Remote

With Remote Buttons \_\_\_\_\_ 6-7

With VCRs \_\_\_\_\_ 8-10

With a Satellite Receiver \_\_\_\_\_ 11

With a Cable Box \_\_\_\_\_ 12-13

With a Laserdisc Player \_\_\_\_\_ 14

With Audio Equipment \_\_\_\_\_ 15

## Adjusting Your TV

Overall Picture \_\_\_\_\_ 16

Picture Settings \_\_\_\_\_ 17

Color, Tint, Brightness, Sharpness, Autocolor, Picture Reset

Sound Settings \_\_\_\_\_ 18-19

Stereo, Expanded Stereo, SAP, Tone, Speakers

## Using Advanced Features

Placing Channels in Memory/Autoprogram \_\_\_\_\_ 20

Naming the Channels \_\_\_\_\_ 21

Setting the Sleep Timer \_\_\_\_\_ 22

Setting the Alarm Clock \_\_\_\_\_ 23

Watching Picture-in-Picture \_\_\_\_\_ 24-25

Selecting a Language \_\_\_\_\_ 26

Watching Closed Captioning \_\_\_\_\_ 26

Setting Your TV for Antenna or Cable \_\_\_\_\_ 27

## References

Front Panel Buttons \_\_\_\_\_ 28

Displays on the Screen \_\_\_\_\_ 29

Trouble Checks \_\_\_\_\_ 30-31

Limited Warranty \_\_\_\_\_ 32

Order Form for Parts \_\_\_\_\_ 33-34

Glossary \_\_\_\_\_ 35

# Quick Guide to Your TV

## Startup

The steps below will get your TV connected and ready for watching.  
*For more details, see the page numbers listed.*

### 1. Hook up your TV

*Details are in the  
Connections Guide.*

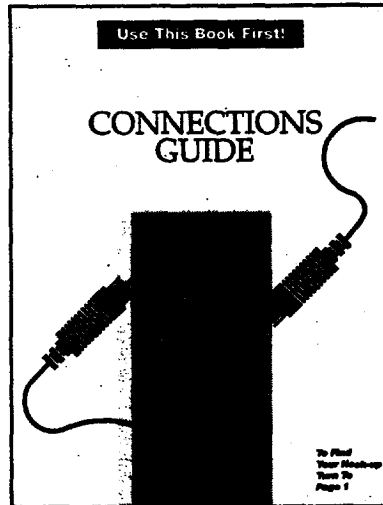

Hook up any antennas, cables or other equipment to your TV before you follow the steps below.

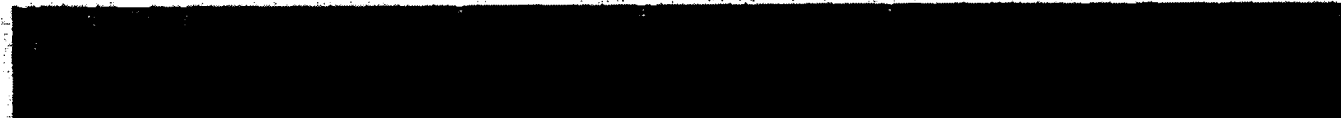

### 2. Plug in the TV

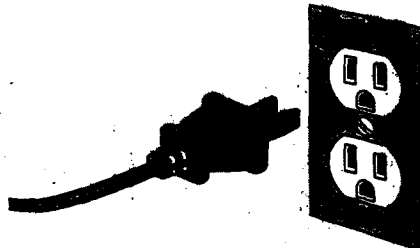

Plug the cord into the outlet, matching the wide and the small end of the plug with the outlet.

### 3. Put Batteries in the Remote

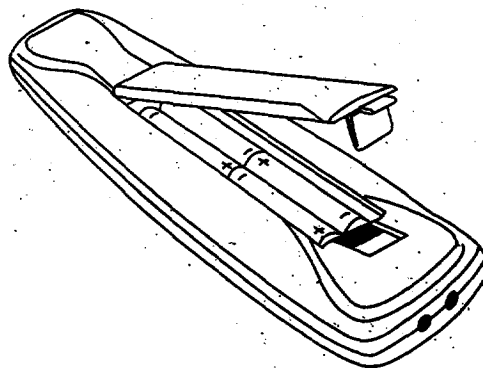

- A. Pull off the cover of the battery compartment.
- B. Place the four AAA batteries as shown, matching the + and - end of each battery in the compartment.
- C. Replace the cover.

# Quick Guide to Your TV

## Startup

### 4. Turn on the TV

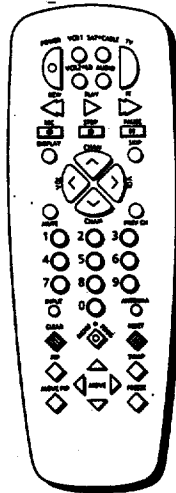

Press TV on the remote.

OR

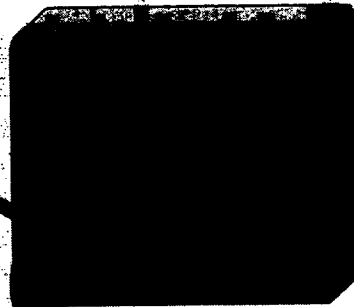

Press POWER on the TV.

### 5. Place all available channels in memory (AutoProgram)

*Details for adding and deleting channels are on page 20.*

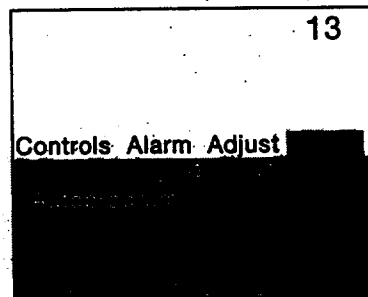

A. Press MENU•PROG until the Setup menu is selected. This menu is white.

B. Press MOVE ▼ to highlight Autoprogram.

C. Press MOVE ► to start placing channels in the TV's memory.

D. Wait until TV has cycled through all the channels and returns to original channel.

### 6. Set the Time

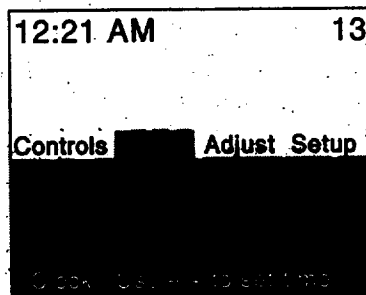

A. Press MENU•PROG until the Alarm menu is selected. This menu is green.

B. The Clock is automatically highlighted the first time you set it. If it is not, press MOVE ▼ (down) to highlight it.

C. Press MOVE ◀ to set the hour.

D. Press MOVE ▶ to set the minutes.

# Quick Guide to Your TV

## Basic Tour of the Remote

Basic information about your remote is shown below. This will give you a general idea of how your remote works. *For more details, see pages 6-15.*

### TV Power Button

Turns the TV on.

Sets the remote to control the TV.

### Volume and Channel Controls

*Details are on page 6.*

Operates TV when remote is set to control the TV.

Operates the TV and advanced features.

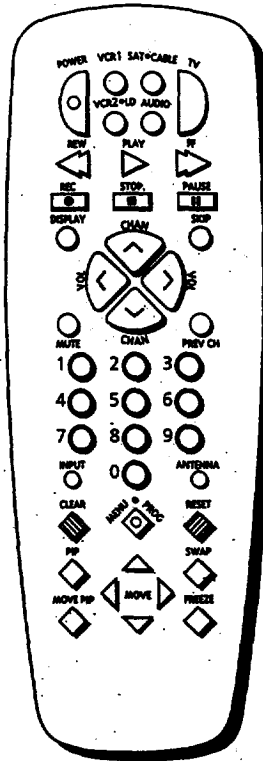

### Component Buttons

*Details are on pages 8-15.*

Controls components such as a VCR, laserdisc player, audio equipment, and a cable box.

### Menu Buttons

*See next page for details.*

Changes the menus and features on the screen.

### Picture-in-picture buttons

*Details are on pages 7 and 24-25.*

Used to watch two pictures on the TV at the same time.

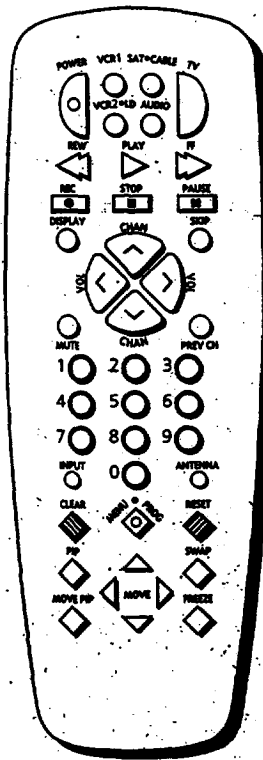

# Quick Guide to Your TV

## Menu Basics

General information about using the on-screen menu system is shown below. Details on using the remote buttons are on pages 6-7. Many menu items are explained in detail in *Using the Advanced Features* starting on page 20.

### Colors

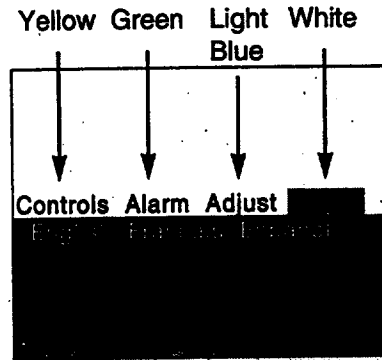

Press MENU•PROG repeatedly to see each of the four menu colors.

Each menu has a different color background as shown at the left.

### Menu Buttons

These buttons are used with the TV's menus to adjust the features. You can use the menu buttons on the remote or the front of the TV.

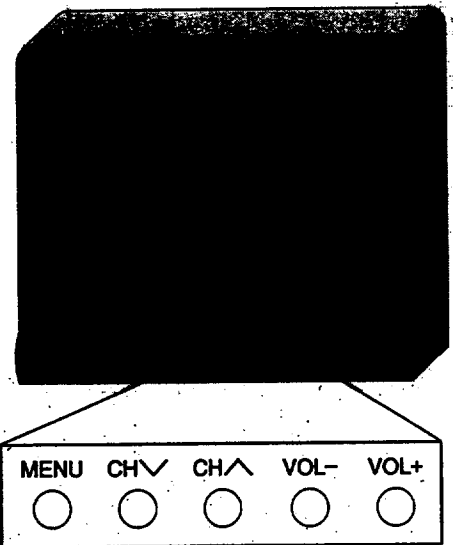
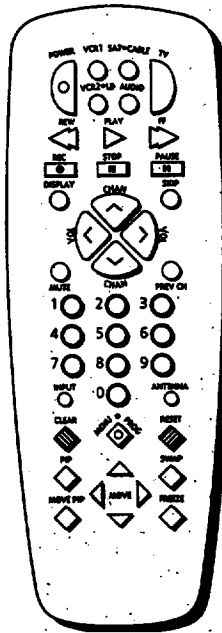

### Moving through the Menus

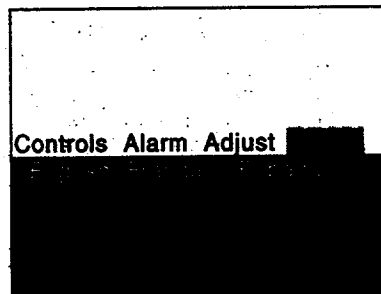

1. Press MENU•PROG on the remote or MENU on the front panel to move from menu to menu.
2. Press MOVE ▲/▼ on the remote or CHANNEL up/down on the front panel to move up and down through the features in the menu.
3. Press MOVE ◀ and ▶ on the remote or VOLUME +/- on the front panel to move left and right on the menu lines.

# Using Your TV and Remote

## With Remote Buttons

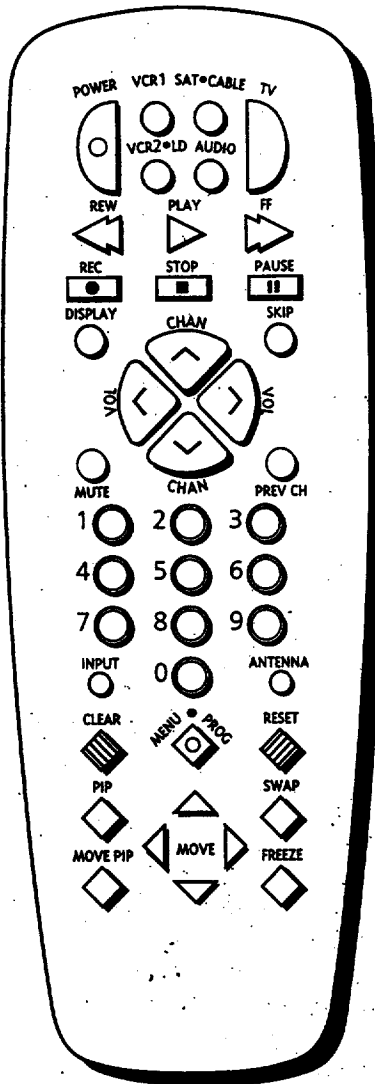

### POWER

Turns off the TV.

Turns off compatible VCRs.

Turns on a component after a component button is pressed.

### AUDIO, VCR, VCR2\*LD, SAT+CABLE, TV

Sets the remote to control the component. VCR2\*LD can only be programmed for one component: either a VCR or a Laserdisc Player.

*See Using the Remote with a VCR, Cable Box, Laserdisc Player and Audio equipment on pages 8-15.*

### TV

Turns on the TV.

Shows the displays on the screen.

Sets the remote to control the TV.

*See Using the Remote with a VCR, Cable Box, Laserdisc Player and Audio equipment on pages 8-15.*

### REW (Rewind)

Rewinds a tape or laserdisc.

Searches backward while tape or laserdisc is playing.

### PLAY

Plays tape or laserdisc.

### FF (Fast Forward)

Fast forwards a tape or laserdisc.

Searches forward while tape or laserdisc is playing.

### REC (Record)

Starts recording onto tape.

### STOP

Stops tape or laserdisc.

### PAUSE

Pauses tape or laserdisc.

### DISPLAY

Shows displays on the screen.

Clears menus from the screen.

### SKIP (Commercial Skip)

Allows you to scan other channels during commercials.

Each press adds 30 seconds. TV switches back to original channel when time runs out. Press CLEAR to cancel SKIP.

### CHAN ^ and v

(Channel up and down)

Scans up and down through channels in the TV's memory.

Moves through channels in VCR's memory.

### VOL + and -

(Volume up and down)

Raises and lowers sound.

### MUTE

Switches the TV sound on or off.

### PREV CH (Previous Channel)

Changes back and forth between two channels.

Select a channel and then select another. Press PREV CH to switch between the two channels.



# Using Your TV and Remote

## With Remote Buttons

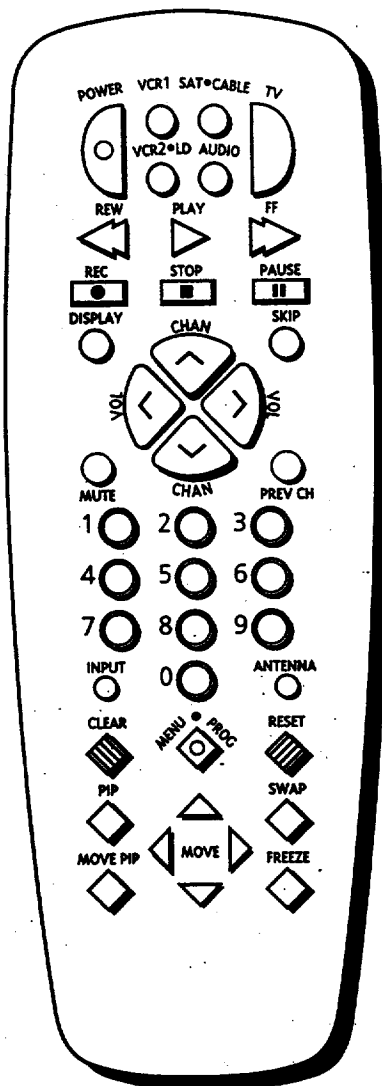

### Number Buttons (0-9)

Selects any channel number.

Two numbers must be pressed for each channel. Press 0 and 6 for channel 6. For three digit channels, press and hold 1 until 1-- appears on the screen. Then press the other two numbers.

### INPUT

Switches between the TV channels and Video 00.

### ANT A•B (Antenna)

Used as TV/VCR button when remote is set to control the VCR.

### CLEAR

Clears menus and displays from the screen.

Clears items from VCR timer programs and VCR's clock.

### MENU•PROG (Program)

Shows menus on the screen and moves from menu to menu.

Sets VCR clock and programs timer on VCR.

### RESET

Returns the picture adjustments to the original settings.

**MOVE ◀ and ▶ (left and right)**  
Moves left and right on a menu line. See *Menu Basics on page 5*.

Changes a feature setting.

**MOVE ▲ and ▼ (up and down)**  
Moves up and down menus. See *Menu Basics on page 5*.

### PIP (Picture-in-Picture)

Turns the small picture on or off.

### PIP MOVE

Moves the small picture to the next corner.

### SWAP

Switches the channel in the small picture with the big picture.

### FREEZE

Freezes or unfreezes the small picture.

# Using Your TV and Remote

## With VCRs: Programming the Remote

Refer to the Connection Book or the VCR's owners manual to hook up your VCRs. The remote may need to be programmed for your VCR. This remote may not operate all models of brands listed below. Use the codes below or on the sheet packed in with your remote.

### 1. Test the remote

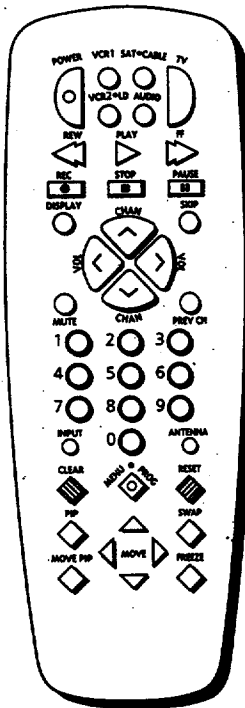

### 2. Program the remote for your VCRs

- A. Press VCR or VCR2 to turn the VCR on.
- B. Press the VCR buttons shown at the left. If your VCR does not work, program VCR or VCR2 with a VCR code from the list below.
- A. Point the remote at the VCR and hold VCR.
- B. Enter the code for your brand from the code list below.
- C. Release VCR.
- D. Press POWER. If nothing happens, try pressing VCR and then POWER.
- E. Repeat A-D with another code if the first one does not work or if a second VCR is connected.

### VCR Codes

Aiwa .....	15	Lloyd .....	15	Sanyo.....	02,12
Akai .....	03,22,23	Magnavox .....	08,29	Scott .....	04,13,41
Audio Dynamics .....	14,16	Marantz .....	02,08,14,16,29,30	Sears .....	02,05,09,12,18,19,35,43
Broksonic .....	10	Marta .....	09	Sharp .....	06,24,39
Canon .....	08	MEI .....	08	Shintom .....	17,26,31
Capehart.....	01	Memorex .....	08,09,12,15	Sony.....	17,26,38
Citizen .....	09	MGA.....	04,27	Sylvania .....	08,15,29
Craig.....	07,12	Minolta .....	05,35	Symphonic .....	02,15
Curtis Mathes.....	00,08,15	Mitsubishi .....	04,05,27,35,40	Tashiko .....	09
Daewoo .....	13	Montgomery Ward.....	06	Tatung.....	30
dbx .....	14,16	MTC.....	07,15	Teac .....	15,30
Dimensia .....	00	Multitech.....	07,15,31,32	Technics .....	08
Dynatech.....	15	NEC .....	02,14,16,30	Teknika .....	08,09,15,21
Emerson ...	09,10,13,15,20,23,24,34,41	Panasonic.....	08	Toshiba .....	05,13,19
Fisher .....	02,12,18,19,43	Pentax .....	05,35	Totevision.....	07,09
Funai.....	15	Philco .....	08,29	Unitech .....	07
GE .....	00,07,08,32,37	Philips.....	08,29	Vector Research.....	14,16
Goldstar.....	09,14	Pioneer .....	05,16,33	Victor .....	16
Harman Kardon.....	14	ProScan.....	00	Video Concepts .....	14,16
Hitachi.....	05,15,35,36	Quartz.....	02	Videosonic.....	07
Instant Replay .....	08	Quasar .....	08	Wards.....	
JCL .....	08	RCA .....	00,05,07,08,28,35,37	.....	05,06,07,08,12,13,15,25,31,35
JCPenney.....	02,05,07,08,14,16,30,35	Realistic .....	02,06,08,09,12,15,19,43	Yamaha.....	02,14,16,30
JVC.....	02,14,16,30	Samsung.....	07,13,22,32,42	Zenith.....	11,17
Kenwood.....	02,14,16,30	Sanstui .....	16		

# Using Your TV and Remote

## With VCRs: Setting the VCR1 Channel

The VCR 1 Channel works with VCR on the remote. If the VCR 1 Channel is set, pressing VCR selects the channel to see the VCR picture. The VCR 1 Channel setting depends on which diagram you have used from the Connection Guide. If you want to turn this feature off, set the VCR 1 Channel to Disable. Refer to the chart below for your setting.

### 1. Select the Setup Menu

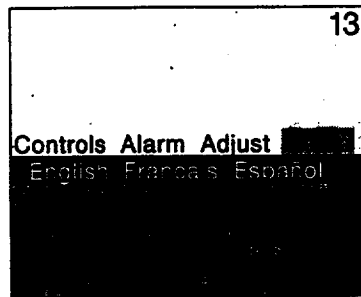

- A. Press TV to set the remote to control the TV.
- B. Press MENU•PROG to select the Setup menu. This menu is white.

### 2. Highlight VCR1 Channel

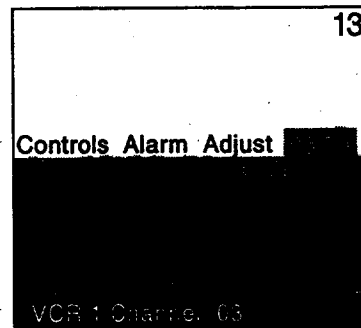

- A. Press MOVE ▼ (down) to highlight the VCR 1 Channel.
- B. Press ► to highlight the channel.

### 3. Enter channel number

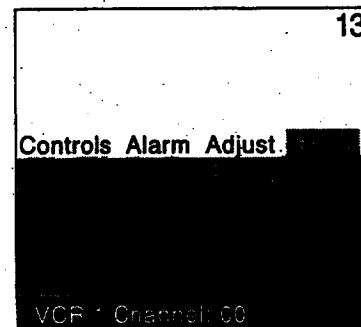

- A. Enter channel 00, 03, or 04. Choose your setting from the chart below. Press CHANNEL down until "Disabled" is displayed to turn the feature off.

Diagram used from the Connection Guide:	Set VCR1 Channel to:
1B, 1C, 2B, 2C, 3B, 3C, 4C, 5C	00
4B, 5B	3 or 4 (same as 3/4 switch)

# Using Your TV and Remote

## With VCRs: Basic Operation

If the remote operates your VCR, this page and the next will show you how to use it for basic functions. See page 7 for more details on buttons used with your VCR.

### Turn on the VCR

### Turn off the VCR

### Record one TV program and watch another

### Watch a tape in your VCR

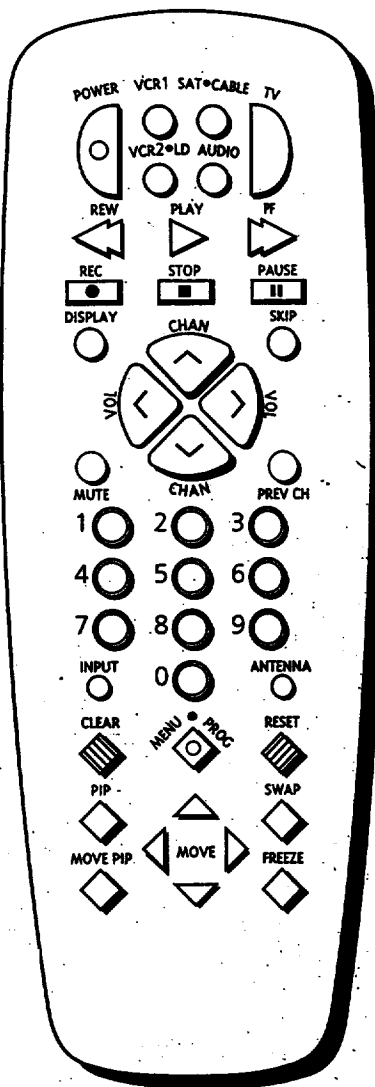

- Press channel 00 on the TV to see what the VCR is doing.
- Press VCR or VCR2 to set the remote to control the VCR.
- Press POWER to turn on the VCR if it did not turn on when you pressed VCR or VCR2.

- Press VCR or VCR2 to set the remote to control the VCR.
- Press POWER.

- Press VCR or VCR2 to set the remote to control the VCR.
- Tune the VCR to the channel you want to record using CHANNEL up and down or pressing two number buttons.
- Press RECORD to start recording.
- Press TV/VCR on the VCR.
- Press TV to set the remote to control the TV.
- Press CHANNEL up or down to change channels on the TV.
- To see the channel you are recording, tune the TV back to channel 00.

- Turn on VCR.
- Insert a tape in the VCR.
- Press PLAY to start the tape playing.
- Press STOP when you are finished.
- Press REW to rewind the tape.

# Using Your TV and Remote

## With a Satellite Receiver: Basic Operation

You may also be able to use the TV's remote with other satellite receivers. Refer to your Satellite Receiver owner's manual to hook up your Satellite Receiver. The remote may need to be programmed for other brands of satellite receivers, but may not operate all models of the brands listed below. Use the codes below or on the sheet packed in with your remote.

Follow the instructions below for basic operation of your receiver. You may also want to experiment with other buttons on the remote to see if they work with your receiver.

### Program the remote for your Satellite Receiver

#### Turn on the Satellite Receiver

#### Turn off the Satellite Receiver

#### Satellite Receiver Codes

Chaparral .....	80,81
Cheyenne .....	81
Drake .....	82,83
DSS .....	00
GE .....	00
General Instruments .....	92,93,94
ProScan .....	00
RCA .....	00
Realistic .....	84
Sierra I,II,III .....	81
STS1 .....	85
STS2 .....	86
STS3 .....	87
STS4 .....	88
Toshiba .....	89
Uniden .....	90
Video Cipher II .....	91

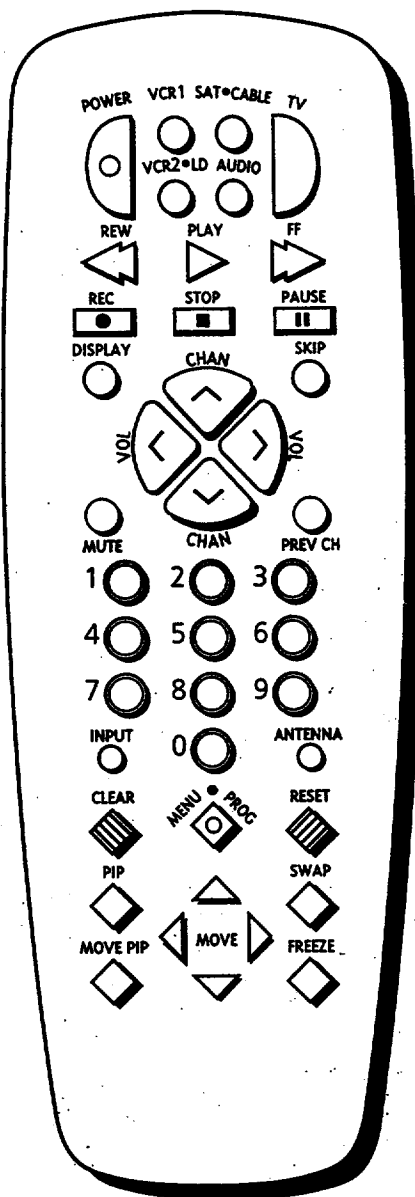

- Point the remote at the satellite receiver and hold SAT•CABLE.
- Enter the code for your brand from the code list below.
- Release SAT•CABLE.
- Press POWER. If nothing happens, try pressing SAT•CABLE and then POWER.

- Press SAT•CABLE to set the remote to control the satellite receiver.
- Press POWER to turn on the receiver if it did not turn on when you pressed SAT•CABLE.

- Press SAT•CABLE to set the remote to control the satellite receiver.
- Press POWER to turn off the receiver.

# Using Your TV and Remote

## With a Cable Box: Programming and Basic Operation

Refer to the Connection Book or contact your cable company to hook up your cable box. If you have a cable box with its own remote, then you may also be able to use the TV's remote with your cable box. This remote may not operate all models of brands listed below. Use the codes below or on the sheet packed in with your remote.

### Program the remote for your cable box

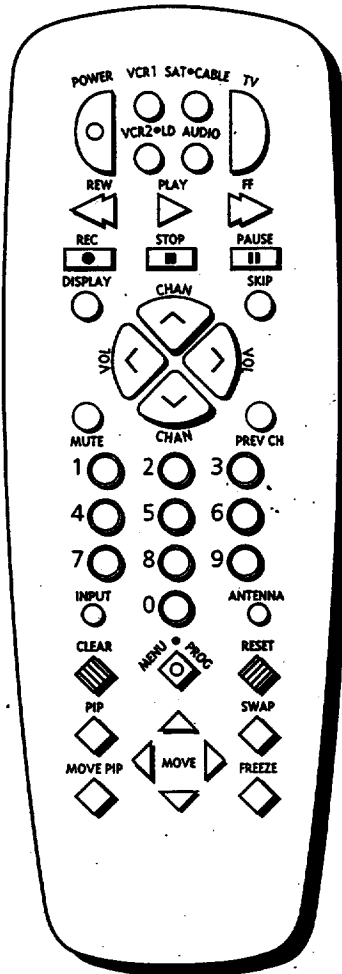

### Basic Operation:

#### Turn on the Cable Box

#### Turn off the Cable Box

- A. Point the remote at the cable box and hold CABLE.
- B. Enter the code numbers for your brand from the list below.
- C. Release CABLE.
- D. Press POWER to turn it on. If nothing happens, try pressing CABLE and then POWER.
- E. Repeat A-D with another code if the first one does not work.

- A. Tune TV to channel 02, 03, 04, 05, or 06—the cable box channel.
- B. Point remote at the cable box and press CABLE.
- C. Press POWER to turn it on.
- D. Press CHANNEL up or down to change channels on the cable box.

- A. Press CABLE.
- B. Press POWER to turn it off.

### Cable Box Codes

ABC.....	22,46	NSC.....	09	Sprucer.....	27
Anvision.....	07,08	Oak.....	01,16,38	Starcom.....	46
Cablestar.....	07,08	Oak Sigma.....	16	Sylvania.....	11
Eagle.....	08	Panasonic.....	03,27,39	Teknika.....	06
Eastern International.....	02	Philips.....	07,08,19,21,26,28,29,32,33,40,41	Texscan.....	10,11
General Instrument.....	04,05,15,23,24,25,30,36,46	Pioneer.....	18,20,44	Tocom.....	17,21,49,50
Hamlin.....	12,13,34,48	Randtek.....	07,08	Unika.....	31,32,41
Hitachi.....	37,43,46	RCA.....	00,27	Viewstar.....	07,08,19,21,26,28,29,32,33,40,41
Jerrold.....	04,05,15,23,24,25,30,36,45,46,47	Regal.....	12,13	Warner Amex.....	44
MACOM.....	37,43	Regency.....	02,33	Zenith.....	14,42
Magnavox.....	07,08,19,21,26,28,29,32,33,40,41	Samsung.....	44		
		Scientific Atlanta.....	03,22,35		
		Signature.....	46		

# Using Your TV and Remote

## With a Cable Box: Setting the Cable Channel

The Cable Channel works with CABLE on the remote. If the Cable Channel is set, pressing CABLE selects the channel to see cable channels. The Cable Channel setting depends on which channel your cable box must be on to see cable channels. The channels usually used are 02, 03, 04, 05 or 06. *Consult your cable company for more information.*

### 1. Select the Setup menu

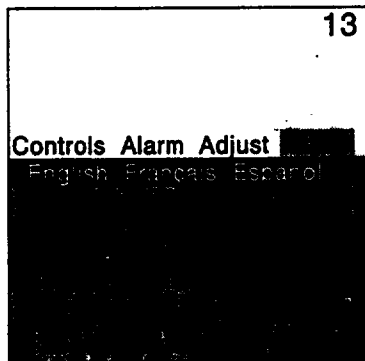

- A. Press TV to set the remote to control the TV.
- B. Press MENU•PROG to select the Setup menu. This menu is white.

### 2. Highlight Cable Channel

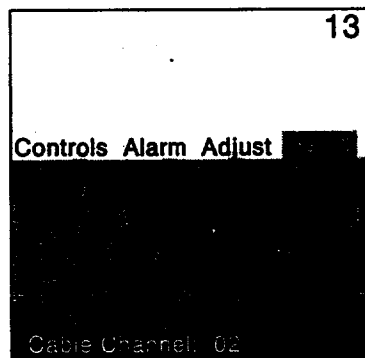

- A. Press MOVE ▼ (down) to move down the menu until Cable Channel is highlighted.
- B. Press ► to underline the channel.

### 3. Enter channel number

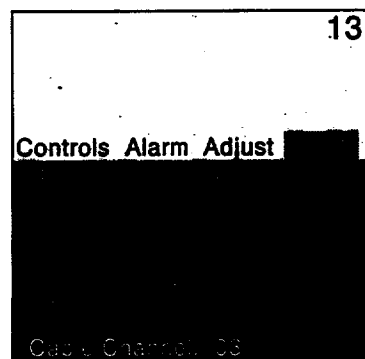

- A. Enter the number for your cable box, either 02,03,04,05, or 06. Press CHANNEL down until "Disabled" is displayed to turn this feature off.

# Using Your TV and Remote

## With a Laserdisc Player: Programming and Basic Operation

Refer to your Laserdisc Player owner's manual to hook up your Laserdisc Player. The remote may need to be programmed for your laserdisc player. This remote may not operate all models of brands listed below. Use the codes below or on the sheet packed in with your remote.

### Program the remote for your Laserdisc Player

### Basic Operation

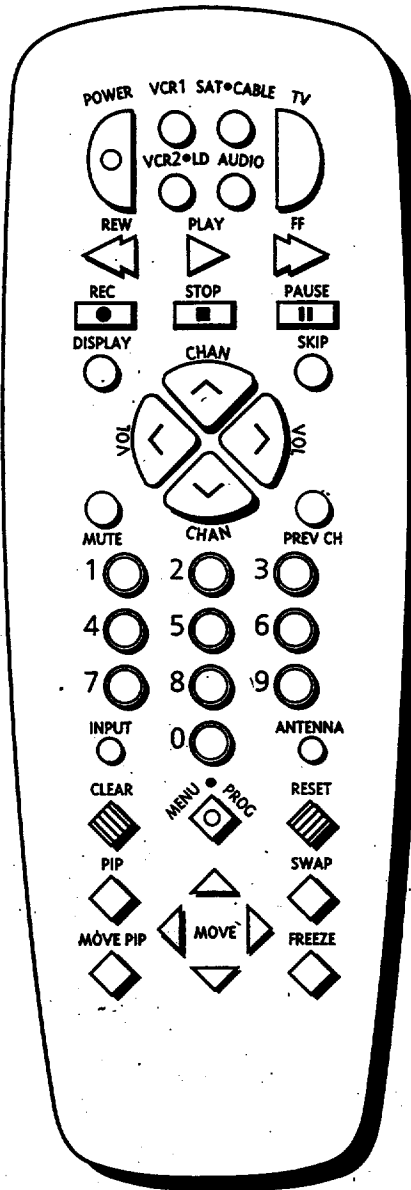

- A. Point the remote at the laserdisc player and hold LD.
- B. Enter the code for your brand from the code list below.
- C. Release LD.
- D. Press POWER. If nothing happens, try pressing LD and then POWER.

- A. Tune TV to channel 00, 03, or 04.
- B. Point the remote at the laserdisc player and press LD.
- C. Press POWER to turn it on.
- D. Use the buttons on the remote that relate to laserdisc player functions. Not all buttons highlighted may work with your laserdisc player.
- E. Press POWER to turn it off.

### Laserdisc Player Codes

Pioneer.....	33
ProScan.....	33
RCA.....	33



# Using Your TV and Remote

## With Audio Equipment: Programming and Basic Operation

Refer to the Connection Book or your Audio equipment owner's manual to hook up your audio equipment. Your remote controls only RCA audio equipment such as a radio, CD player, tape player, turntable, or amplifier. The remote may need to be programmed for your equipment. This remote may not operate all models of brands listed below. Use the codes below or on the sheet packed in with your remote.

### Program the remote for audio equipment

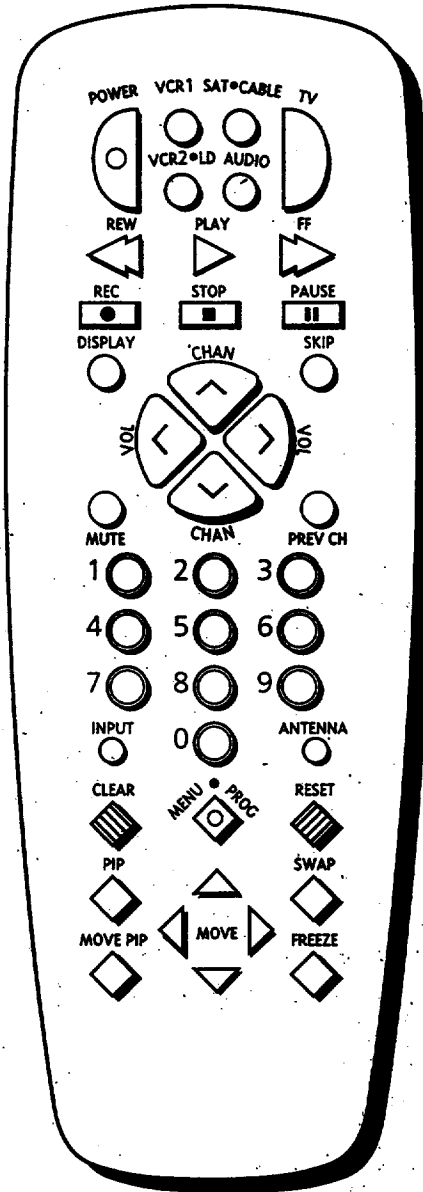

- A. Point the remote at the audio equipment and hold AUDIO.
- B. Enter the code from the code list.
- C. Release AUDIO.
- D. Press POWER to turn it on. If nothing happens, try pressing AUDIO and then POWER.
- E. Repeat A-D with another code if the first one does not work.

### Basic Operation

- A. Point the remote at the audio equipment and press AUDIO.
- B. Press POWER to turn it on.
- C. Use the buttons on the remote that relate to audio functions. Not all buttons highlighted may work with your equipment.
- D. Turn the audio equipment off using the audio component's power off button.

### Audio Codes

RCA/ Dimensia	
AM/FM.....	03
CD.....	07
Tape.....	06
Phono.....	05
Aux.....	04

# Adjusting Your TV

## Overall Picture

Follow the steps below to lighten or darken the overall picture without changing the color levels.

### 1. Select the Controls Menu

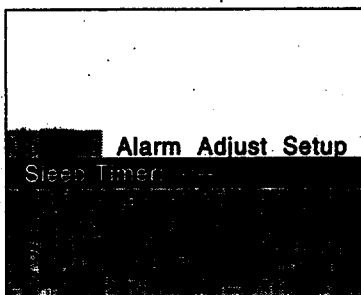

Press MENU•PROG to select the Controls menu. This menu is yellow.

### 2. Highlight Picture

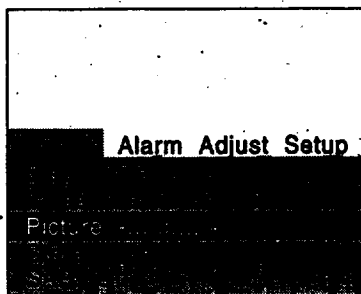

Press MOVE ▼ (down) to highlight Picture.

### 3. Use MOVE ► and ◀ to adjust the Picture

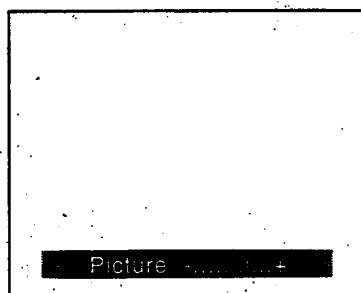

Press MOVE ► (right) to lighten the picture.

OR

Press MOVE ◀ (left) to darken the picture.

# Adjusting Your TV

## Picture Settings

Follow the steps below to change the picture on the screen to your personal setting. The chart at the bottom of the page explains your options.

### 1. Select the Adjust Menu

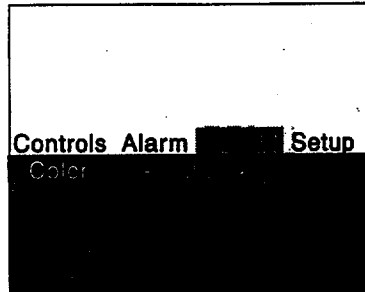

Press MENU•PROG repeatedly to select the Adjust menu. This menu is light blue.

### 2. Highlight item to change

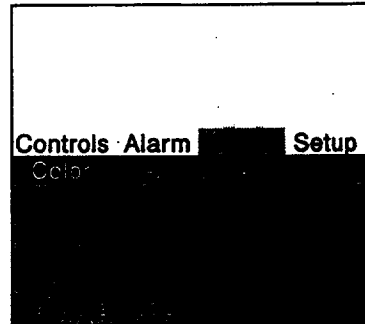

Press MOVE ▼ (down) to highlight the picture item you want to adjust.

### 3. Use MOVE ► or ◀ to adjust each item

Press MOVE ► or ◀ to adjust each item.

	Press MOVE ► to:	Press MOVE ◀ to:
<b>Color</b>	Increase color richness	Lower color to black and white
<b>Tint</b>	Give red tint to skin color	Give green tint to skin color
<b>Bright (Brightness)</b>	Add more light to dark parts of the picture	Add more dark to light parts of the picture
<b>Sharp (Sharpness)</b>	Show cleaner, clearer images	Make picture more smooth
<b>Autocolor</b>	Turn on to keep Color and Tint in proper balance each time you change channels	Turn off for manual adjustment of Color and Tint
<b>Picture Reset</b>	Reset the picture back to the original settings	Reset the picture back to the original settings

# Adjusting Your TV

## Sound Settings: Stereo, Expanded Stereo, SAP and Tone

Follow these steps to adjust the Stereo, Expanded Stereo, SAP or Tone of your TV. SAP (Second Audio Program) is sometimes used to offer the program being watched in another language. The chart below explains your options.

### 1. Select the Controls Menu

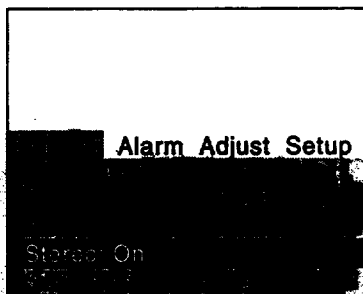

Press MENU•PROG to select the Controls menu. This menu is yellow.

### 2. Highlight item to change

Press MOVE ▼ (down) to highlight the sound item you want to adjust.

### 3. Use MOVE ► or ◀ to adjust each item

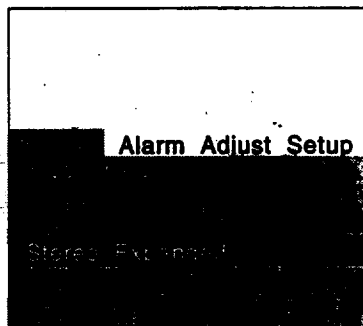

Press MOVE ► or ◀ to adjust each item.

<b>Stereo</b>	<b>On</b> Sound is automatically reproduced in stereo or mono, whichever the TV station is broadcasting.	<b>Off</b> Sound is reproduced in mono.	<b>Expanded</b> Expanded stereo adds greater width and dimension to stereo broadcasts creating a more spacious stereo sound effect.
<b>SAP</b>	<b>On</b> Sound is reproduced in another sound channel. If nothing happens, your broadcast may not have SAP.	<b>Off</b> Sound is reproduced in Stereo, Expanded Stereo or Mono, whichever is selected in the Stereo Menu Item.	
<b>Tone</b>	<b>High</b> High pitched sounds are louder.	<b>Low</b> Low pitched sounds are louder.	

# Adjusting Your TV

## Sound Settings: Speakers

Follow the steps below to turn the speakers on or off in your TV. The chart below explains your options.

### 1. Select the Setup Menu

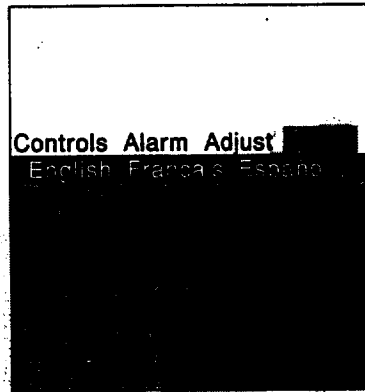

Press MENU•PROG repeatedly to select the Setup menu. This menu is white.

### 2. Highlight speakers

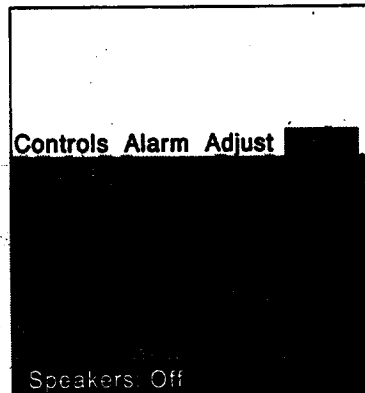

Press MOVE ▼ (down) until Speakers is highlighted.

### 3. Turn Speakers on or off

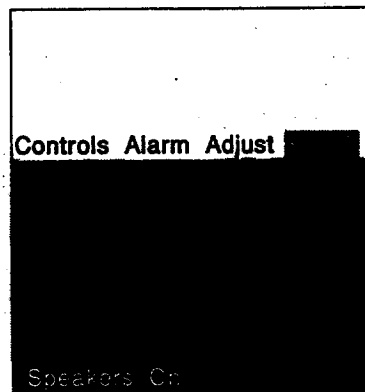

Press MOVE ► or ◀ to turn the speakers on or off.

Speakers	On	Off
	The sound comes from the TV's internal speakers.	No sound comes from the TV.

# Using Advanced Features

## Placing Channels in Memory (Autoprogramming)

Only channels 2–13 appear in the TV's memory when you first turn it on. The channels available in your area must be programmed into the TV's memory when you hook up your TV. Using CHANNEL up or down allows you to scan through these channels.

You may want to add or delete a few channels if some stations have weak signals or were off the air when the TV was programmed. Refer to the *Add or Delete Channels* section below.

### 1. Place channels in memory (AutoProgram)

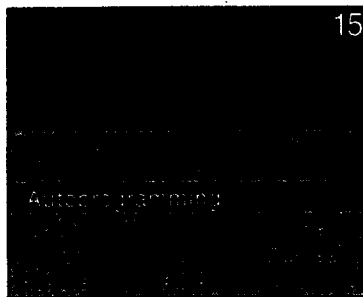
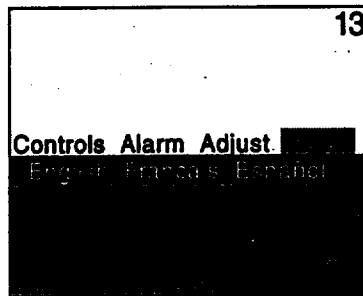

- A. Hook up an antenna, cable or components before you begin these steps or you will not be able to add channels into memory.
- B. Press MENU•PROG repeatedly to select the Setup Menu. This menu is white.
- C. Press MOVE ▼ (down) to highlight AutoProgram.
- D. Press MOVE ► to start the TV adding all active channels into memory.
- E. Wait until the TV has cycled through all the channels and returns to the original channel.

### 2. Add or delete channels

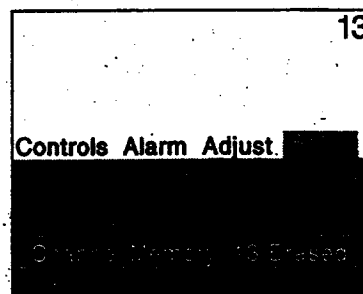
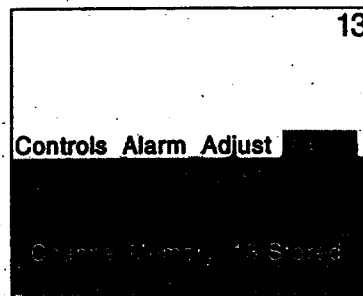

- A. Press MENU•PROG repeatedly to select the Setup menu. This menu is white.
- B. Press MOVE ▼ (down) to highlight Channel Memory.
- C. Press MOVE ► to underline the channel number.
- D. Select the channel number you want to add or delete with the number buttons.
- E. Press MOVE ► to add or delete a channel (you will see Stored on the screen when added and Erased when deleted).
- F. Repeat D and E for more channels.

# Using Advanced Features

## Naming the Channels

You can name the channels using the character list below. Full appears beside Label when the memory is used up. Fixed appears beside Label for channel 00—it cannot be named.

### 1. Name a channel

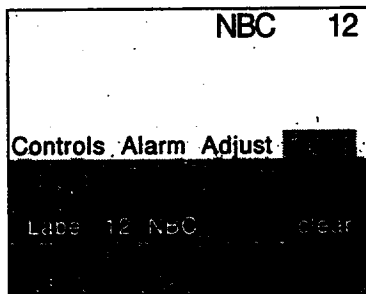
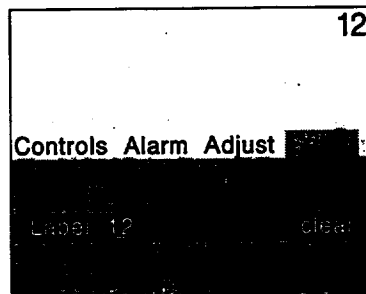

- Press MENU•PROG repeatedly to select the Setup menu. This menu is white.
- Press MOVE ▼ (down) to highlight Label.
- Press MOVE ► to underline the channel number.
- Select the channel number with the number buttons.
- Press MOVE ► to underline the first character of the name.
- Choose the character using MOVE ▲/▼ (up or down).
- Repeat E–F to complete the name.
- Press MOVE ◀ to move backward if you want to change an item.

### 2. Erase a name

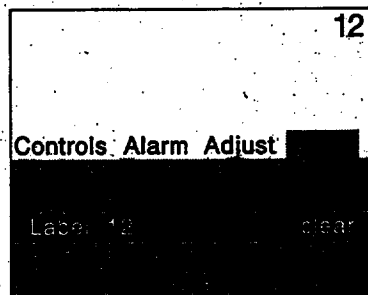

- Follow A and B above.
- Press MOVE ► until clear is underlined.
- Press MOVE ▲/▼ (up or down) to clear the name.

### Character List

A B C D E F G H I J K L M N O P Q R S T U V W X Y Z &  
' ( ) á + , - . / 0 1 2 3 4 5 6 7 8 9 : ; < = > ? @ blank space

# Using Advanced Features

## Setting the Sleep Timer

You can set your TV to turn itself off. If you're watching TV at night and fall asleep, the TV will turn off for you.

### 1. Set Sleep Timer

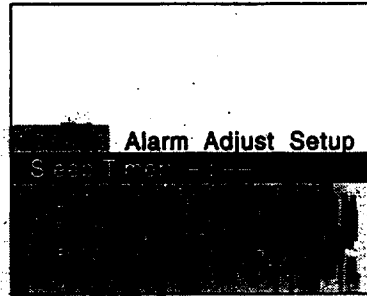

- A. Press MENU•PROG to select the Controls menu and highlight Sleep Timer. This menu is yellow.
- B. Press MOVE ► to enter the amount of time you want to watch TV before it shuts off. Each press equals 15 minutes.
- C. Press MOVE ◀ to subtract time from the sleep timer.

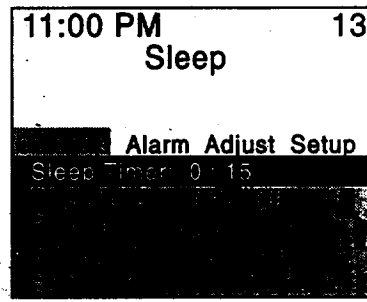

### 2. Add more time

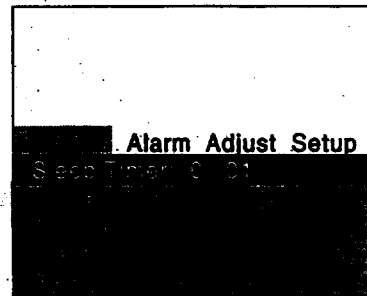

- A. When 0:01 appears on the screen, the TV will shut off in one minute. Press MOVE ► to add more time.

### 3. Cancel the Timer

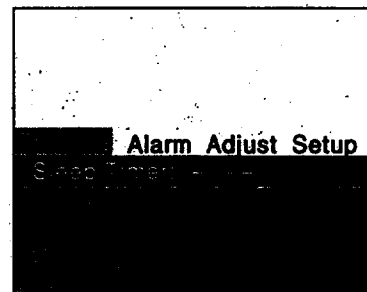

- A. Press MENU•PROG to select the Controls menu and highlight Sleep Timer.
- B. Press MOVE ◀ until the time reaches



# Using Advanced Features

## Setting the Alarm Clock

The TV can be set to turn on each day like your alarm clock. You can set it to turn on to your favorite channel at a certain time. You can also set it to turn itself off again. The Alarm cannot be used until the clock is set.

### 1. Turn on the Alarm

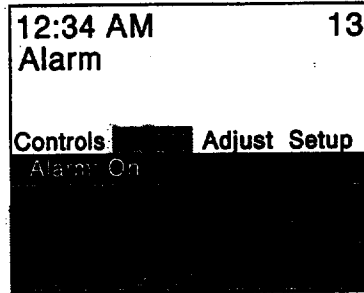

- A. Press MENU•PROG to select the Alarm menu and highlight Alarm. This menu is green.
- B. Press MOVE ► or ◀ to select On or Off.

### 2. Set the Alarm Channel

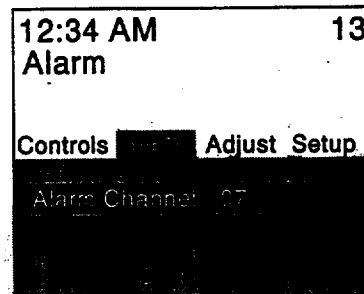

- A. Press MOVE ▼ (down) to highlight the Alarm Channel.
- B. Press MOVE ► to highlight the channel number.
- C. Enter the channel that you want the TV to turn on to with the number buttons.

### 3. Set On and Off Times

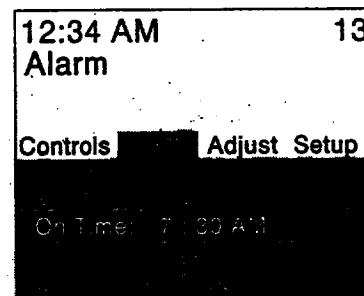

- A. Press MOVE ▼ (down) to highlight the On or Off Time.
- B. Press MOVE ◀ to set the hour.
- C. Press MOVE ► to set the minutes.
- D. Press and hold MOVE ◀ to choose Disabled. This turns the TV only on or only off at a certain time each day.

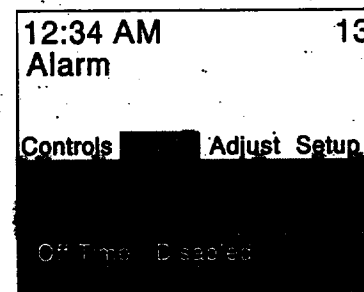

# Using Advanced Features

## Watching Picture-in-Picture

Picture-in-Picture allows you to display a small picture within the big picture of the TV screen. To watch two different programs at once, you must connect a VCR, Laserdisc Player or Camcorder. You may need to disable the VCR1 Channel if you can not get two different programs at once.

### Turn on Picture-in-Picture

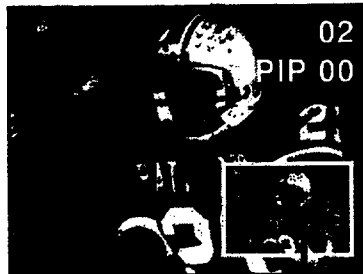

TV Picture

TV Picture

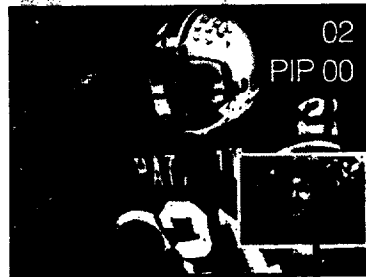

TV Picture

VCR, Laserdisc  
Player, or  
Camcorder  
Picture

- A. Hook up a VCR, Laserdisc Player, or Camcorder to the video jacks on the back of the TV. *See the Connections Guide.*
- B. Press TV to turn the TV on.
- C. Press CHANNEL up or down to select the channel you want to watch on the big picture.
- D. Turn on the VCR, Laserdisc Player, or Camcorder.
- E. Press PIP to put the small picture on the screen. It is the same as the big picture.
- F. Press 00 to see the signal from the VCR, Laserdisc Player, or Camcorder connected to the video jacks.

### Change channels on the large picture.



Press CHANNEL up and down or two number buttons to change channels on the large picture.

### Change channels on the small picture



Change channels on your VCR, Laserdisc Player, or Camcorder to change channels on the small picture.

# Using Advanced Features

## Watching Picture-in-Picture

Move the small picture

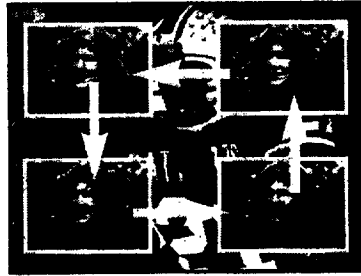

Press PIP MOVE to move the small picture to the next corner.

Swap the big picture with the little picture

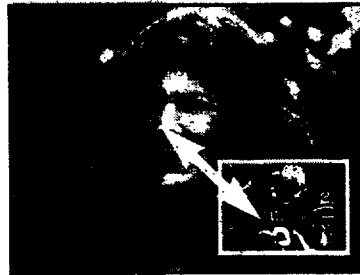

Press SWAP to switch the small picture with the big picture.

Freeze the small picture

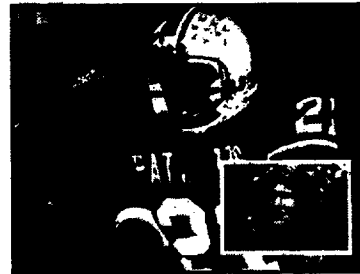

- A. Press FREEZE to stop action in the small picture.
- B. Press FREEZE again to return to an action picture.

Turn off Picture-in-Picture

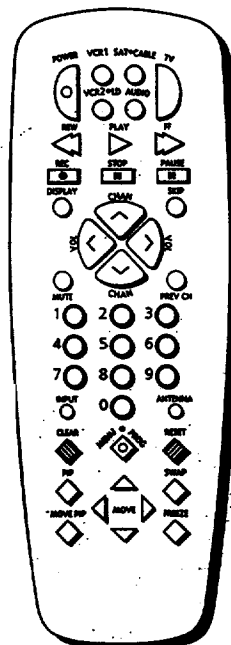

Press PIP to turn off picture-in-picture.

# Using Advanced Features

## Selecting a Language

The on-screen displays in this TV can be displayed in three languages: English, French, and Spanish. When you select a language, most of the displays will be shown on the screen in your preferred language.

### 1. Select the Setup menu

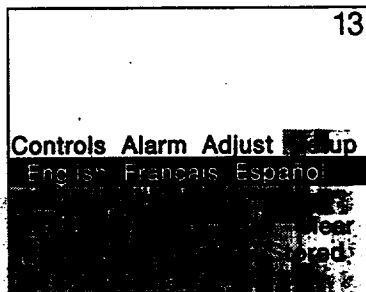

Press MENU repeatedly to select the Setup menu. This menu is white.

### 2. Select Language

Press + or - to select English, Français (French), or Español (Spanish).

## Watching Closed Captioning

Closed captioning displays the audio portion of a program as words on the TV screen. It is useful for the deaf, hearing impaired, or anyone who wants to watch a program without sound. If you have turned Closed Captioning on and it does not appear on the screen, it is not available on the channel you are watching. This TV does not support the text mode. Text information typically consists of program information, weather bulletins, local activities, etc.

### 1. Select the Controls Menu

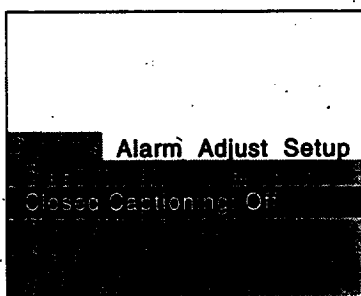

Press MENU•PROG to select the Controls menu. This menu is yellow.

### 2. Highlight Closed Captioning

Press MOVE ▼ (down) to highlight Closed Captioning.

### 3. Select Setting

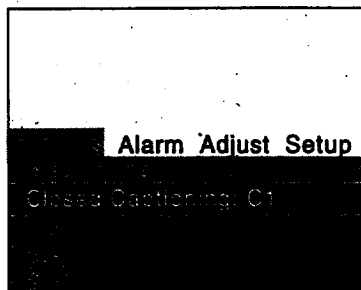

A. Press MOVE ◀ or ▶ to select Off, C1, or C2. Select C1 for full translation of the primary language in your area. Select C2 for secondary language translation, simplified English, or whatever is being broadcast in your area.

# Using Advanced Features

## Setting Your TV for Antenna or Cable

Your TV automatically adjusts this feature when the TV places channels in memory (autoprogram). Follow the steps below to change the setting as needed.

### 1. Select the Setup menu

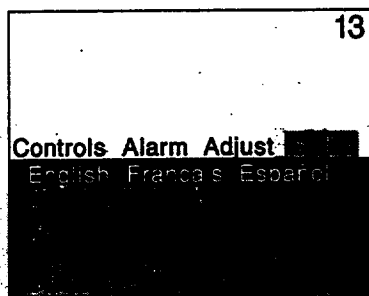

Press MENU•PROG repeatedly to select the Setup menu. This menu is white.

### 2. Highlight Cable/Air

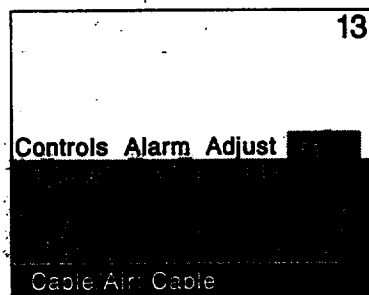

Press MOVE ▼ (down) to highlight Cable/Air.

### 3. Select Cable or Air

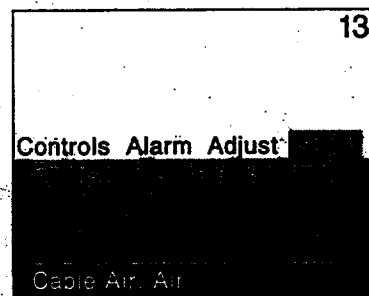

A. Press MOVE ◀ or ▶ to select Cable or Air. Select Cable if you have cable. Select Air if you have a home antenna connected to your TV.

# References

## Front Panel Buttons

*For details on using buttons with menus, see Menu Basics on page 5.*

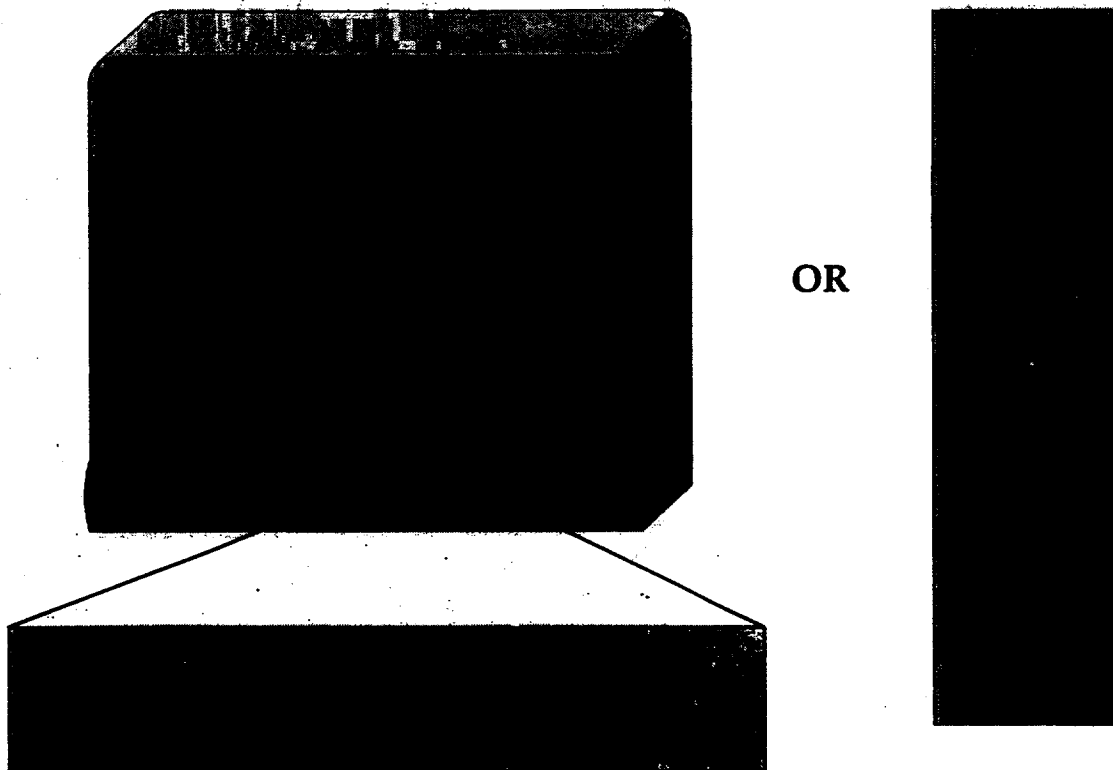

### **MENU**

Shows menus on screen.  
Moves from menu to menu.

### **CH ^ and v**

Channel up and down.  
Scans up and down through channels in the TV's memory.  
Moves up and down menus.

### **VOL + and - (Also VOL ^ and VOL v)**

Volume up and down  
Raises and lowers sound.  
Moves left and right on a menu line.  
Changes a features setting.

### **POWER**

Turns the TV on or off.

### **+ and - (Not on all models)**

Same as VOL. + and - buttons.

# References

## Displays on the Screen

Your TV shows the settings of several features on the screen. To see what features have been set on your TV, press DISPLAY on the remote.

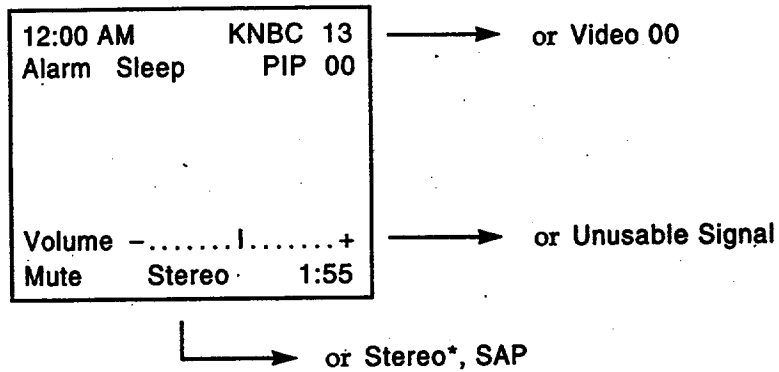

### Screen Display

**12:00 AM**

**KNBC**

**13**

**Video 00**

**Alarm**

**Sleep**

**PIP 00**

**Volume**

**Unusable Signal**

**Mute**

**Stereo**

**Stereo\***

**SAP**

**1:55**

### Description

Time of the clock. *Details are on page 3.*

Name you chose to describe the channel. *Details are on page 21.*

Channel number you are watching.

Indicates that a component is connected to the VIDEO jack on the back of the TV, it is turned on, and channel 00 is selected.

Alarm clock is set to turn on or off. *Details are on page 23.*

Sleep Timer is set to turn off the TV. *Details are on page 22.*

Picture-in-picture is turned on to channel 00. *Details are on pages 24-25.*

Sound level of the TV.

No signal is coming in on video input channel 00.

There is no sound. *See MUTE button on page 6.*

The sound is being broadcast in stereo. *Details are on page 18.*

SAP is selected in the menu, but it is not available for the program being broadcast. *Details are on page 18.*

Secondary Audio Program. SAP is selected and it is available for the program being broadcast. *Details are on page 18.*

The time remaining for commercial skip. *Details are on page 6.*

# References

## Trouble Checks

You may have problems that can be fixed with a few minor adjustments. Look for the type of problem you are having below and then try the suggestions to get your TV going again. *For warranty information see page 32.*

### Trouble

### Checks and Adjustments

#### Power

TV will not turn on

Plug TV in.

Plug something else into the outlet to make sure it is working.

Make sure batteries in the remote are not dead.

Aim the remote at the TV and press TV.

Make sure batteries are placed in the remote the right way. *See batteries on page 2.*

Unplug TV for a few minutes and then turn it on again.

No picture, no sound but TV has power

Check antenna connections.

Check position of Cable/Air feature. *See page 27.*

Try another channel. Inactive channel may be tuned.

Make sure component connected to the VIDEO INPUT jacks is turned on if you choose channel 00.

Make sure TV is tuned to the same channel as the switch on back of VCR if watching a VCR.

Make sure TV/VCR button on VCR is in correct position when using VCR.

#### Picture

Blank screen or Unusable Signal appears on screen

Try another channel.

Scan the channels.

Picture poor, sound okay

Check antenna connections.

Adjust TV picture. *See pages 16-17.*

#### Picture-in-Picture

Can't get two different channels in picture-in-picture

Make sure small picture is tuned to channel 00.

Make sure the component connected to the back of the TV is turned on.

Make sure the AUDIO and VIDEO OUT jacks on the VCR, Laserdisc player, or Camcorder are connected to the TV's VIDEO and AUDIO IN jacks.

Make sure VCR 1 Channel is set to Disabled. *See page 9.*



# References

## Trouble Checks

### Trouble

### Checks and Adjustments

#### Remote

Buttons don't work when you press them

Press TV to set the remote to control the TV. *See buttons on page 6-7.*

Works part or none of the time

Clear the path between the remote and TV of any objects.

Aim the remote at the component you are trying to control.

Press TV so remote will control TV.

Make sure batteries in the remote are not dead.

See if batteries are placed in remote correctly. *See batteries, page 2.*

Can't select certain channel

Press number buttons. Channel may not be in memory. *See autoprogram on page 20.*

Make sure TV/VCR switch on VCR is in the TV position.

For numbers over 100, press and hold 1 until 1- appears, then press the other two numbers.

Set Cable/Air feature to Cable for channels higher than 69. *See page 27.*

#### Sound

Noisy stereo reception

Turn Stereo off. The stereo broadcast may not be clear. *See page 18.*

Picture okay, no sound

Press VOLUME + or MUTE to restore sound.

Make sure TV's speakers are on. *Details are on page 19.*

Picture okay, sound poor

Try another channel.

Try adjusting the Tone. *See page 18.*

Change Stereo to off. The stereo broadcast may not be clear. *See page 18.*

No stereo on stereo station

Make sure Stereo is turned on. *See page 18.*

#### TV Turns on or off

Turns off by itself

Check Sleep Timer. *See sleep timer on page 22.*

Wait 30 seconds and turn on again, a power surge may have occurred.

Check Alarm Off time. *See alarm clock on page 23.*

Turns on by itself

Check Alarm On Time. *See alarm clock on page 23.*

Check clock time. *See clock on page 3.*

Does not turn off at Alarm Time

Make sure alarm is turned on or off. *See alarm clock on page 23.*

Check clock time. *See clock on page 3.*

# References

## Limited Warranty

### What your warranty covers:

Any defect in material or workmanship.

### How long after your purchase:

90 days for labor charges.

One year for parts.

Two years for picture tube.

The warranty period for rental units begins with the first rental or 45 days from date of shipment to the rental firm, whichever comes first.

### What we will do:

Pay any Authorized RCA Television Servicenter the labor charges to repair your television.

Pay any Authorized RCA Television Servicenter for the new or, at our option, rebuilt replacement parts and picture tube required to repair your television.

### How you get service:

For screen sizes of 20" and smaller: Take your RCA television to any Authorized RCA Television Servicenter, and pick up when repairs are complete.

For screen sizes larger than 20": Request in-home service from any Authorized RCA Television Servicenter.

To identify your nearest Authorized RCA Television Servicenter, ask your Dealer, look in the Yellow Pages, or call 1-800-336-1900.

Show the service technician your evidence of purchase date or first rental.

### What your warranty *does not* cover:

Customer instruction. (Your Owner's Manual clearly describes how to install, adjust, and operate your television. Any additional information should be obtained from your Dealer.)

Installation and related adjustments.

Signal reception problems not caused by your television.

Damage from misuse or neglect.

Remote control batteries.

Customer-replaceable fuses.

Images burnt onto the screen.

A television that has been modified or incorporated into other products or is used for institutional or other commercial purposes.

A television purchased or serviced outside the USA.

Acts of God, such as but not limited to lightning damage.

### What to do with the Product Registration Card:

Please complete and mail the Product Registration Card packed with your set. It will make it easier to contact you should it ever be necessary. The return of the card is not required for warranty coverage.

### How state law relates to this warranty:

This warranty gives you specific legal rights, and you also may have other rights that vary from state to state.

### If you purchased your product outside the United States:

This warranty does not apply. Contact your dealer for warranty information.

# References

## Order Form for Parts

### Remote #233064

If your TV has the picture-in-picture feature, this is the remote that came packed with your TV. You can use the order form at the right to order it by mail.

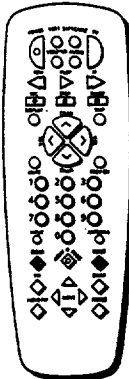

### Cleaner #AH035

To clean your TV cabinet, we recommend Murphy's® Oil Soap or Cleaner #AH035. You **should not** use cleaners such as Windex® with vinegar, Lenox® Furniture Polish spray or Heinz® Cleaning Vinegar to clean your TV cabinet. Using these cleaners will permanently mar the surface of the cabinet. Such damage is not covered under your purchase warranty.

Detach Here

### Order Form Book No. 1512778A

Part	Part Number	Price	Qty	Total
Cleaner	AH035	\$ 6.95		
Remote—CRK74A2	233064	\$39.95		

Total (\$10 Minimum Order) ..... \$ \_\_\_\_\_

Sales Tax ..... \$ \_\_\_\_\_

We are required by law to collect the appropriate sales tax for each individual state, county, and locality to which the merchandise is being sent.

Shipping, Handling, and Insurance ..... \$ 5.00

Total Amount Enclosed ..... \$ \_\_\_\_\_

VISA or MasterCard preferred.  
Money order or check must be in U.S. currency only.  
No COD or CASH.



All specifications and descriptions of parts are subject to change without notice.

# References

## Order Form for Parts

**USE YOUR CREDIT CARD**

Copy complete account number 

Card expires:

Copy complete account number 

Copy Number above the name on your MasterCard

Card expires:

---

**AUTHORIZED SIGNATURE**

Prices are subject to change without notice.

**PLEASE**



Print or type your name and address.  
This will be your mailing label.

A complete and correct order will  
save you days of waiting.

Name: \_\_\_\_\_

Street: \_\_\_\_\_

\_\_\_\_\_ Apt: \_\_\_\_\_

City: \_\_\_\_\_

State: \_\_\_\_\_ Zip: \_\_\_\_\_

Make sure that both sides of this  
form have been filled out.

### U.S. and Canadian Orders

#### By Phone:

**1 - 800 - 338 - 0376**

Call this toll-free number between  
8AM and 8PM Eastern Standard Time  
and place your order using your Visa  
or MasterCard. Use this number  
only to place an order for accessory  
items listed on this order form.

#### By Mail:

Detach the information at the left and  
mail the payment to Thomson  
Consumer Electronics, Inc., at:

Video Accessories  
PO Box 8419  
Ronks, PA 17573

Most orders are shipped UPS within  
72 hours. If it is not possible to ship  
within 30 days, we will notify you.

For more current information on  
these accessories, write to the  
following address:

Video Accessories Customer Service  
Thomson Consumer Electronics, Inc.  
Distributor & Special Products  
2000 Clements Bridge Rd  
Deptford, NJ 08096-2088

### International Orders

This offer is valid only in the U.S.  
Send your request for price quotation  
(not orders) to:

International Customer Service  
Thomson Consumer Electronics, Inc.  
Distributor & Special Products  
2000 Clements Bridge Rd  
Deptford, NJ 08096-2088 USA

Detach Here

# References

## Glossary

### Antenna

A device used to receive broadcast signals from TV stations.

### Audio

Sound reproduced by the TV.

### Audio/video cables

Cables that carry sound and picture signals from one component to another.

### Autocolor

Adjusts the Color and Tint of the picture signals to the proper balance for all channels.

### AutoProgram

A procedure that automatically adds only the active channels in your area to the TV's memory.

### Brightness

Light and dark areas of a picture.

### Channel Label

A name that is given to a specific channel number.

### Channel Memory

Where channels are stored after they have been placed in memory. Channels can be added or deleted from channel memory.

### Commerical Skip

A feature that allows the viewer to scan other channels during commercials, and return to the original channel after a timed break.

### Component

Device such as VCR, laserdisc player, audio equipment, camcorder, etc.

### Disabled

Turns off feature.

### Display

A word, words or graphics that appear on the TV screen.

### Inputs

Located on back of the TV for connection of a component to the TV. Used to route signals into the TV from components.

### Jacks

Connectors located on the back of the TV for connecting antennas or other components.

### Menu

A listing of features, controls, and adjustments shown on the TV screen that can be changed.

### Mono

Slang for monaural. Sound comes through one channel.

### On-Screen Display

See Display.

### Outputs

Located on back of the TV for connection of another component. Signals are routed out of the TV into the other component.

### Picture-in-picture

A feature that allows you to watch two channels at the same time, a small picture within a big picture. The smaller picture comes from a VCR or other component connected to the TV.

### Picture Reset

Returns all of your TV picture adjustments back to the factory setting.

### PIP

Short for picture-in-picture.

### Sharpness

Clearness of a picture.

**SKIP** See *Commerical Skip*.

### Signal

Electrical waves that are sent or received through cables or through the air.

### Sleep Timer

A feature where the TV can be set to turn off at a specific time within four hours.

### Source(s)

Components or devices that are connected to the TV.

### Stereo

Sound signals that come through two channels (left and right).

### Tone

Quality of the sound.

### Tuner

A device that receives and selects signals. The desired signal is selected by the tuner.

### Unusable Signal

A message that shows no signal is coming in on the video input.

### Video

Picture reproduced by the television.



## M

Menu .....	35
MENU Buttons .....	4,5
Menus .....	5
Menu Colors .....	5
Mono .....	18,35
MOVE Button .....	2,5,7
Moving through the Menus .....	5
MUTE Button .....	6
Mute Display .....	29

## N

Naming the Channels .....	21
Number Buttons .....	6

## O

Off Time (Alarm) .....	23
On-Screen Displays .....	29,35
On Time (Alarm) .....	23
Order Form for Parts .....	33,34
Outputs .....	35

## P

PAUSE Button .....	7,8,14
Picture .....	16,17
Picture Adjustments .....	16,17
Picture-in-Picture .....	4,7,24,25
Change Channels .....	24
Turn on .....	24
Turn off .....	25
Use PIP Buttons .....	7,25
Picture-in-Picture Buttons .....	7,25
FREEZE, PIP, PIP MOVE, SWAP	
Picture Settings .....	16,17
Picture Reset .....	17
PIP .....	4,7,24,25
PIP Button .....	4,7,24,25
PIP 00 Display .....	29
PIP MOVE Button .....	7,25
Place Channels in Memory .....	3,20
PLAY Button .....	7,8,14,15
Plug in TV .....	2
POWER Button .....	2,6
Power Buttons .....	2,6
PREV CH Button .....	6
Previous Channel Button .....	6
Problem Solving .....	31,32
Product Registration .....	i
PROG /Program Button .....	7
Programming the Remote	
Audio Equipment .....	15
Cable Box .....	12,13
Laserdisc Player .....	14
VCR .....	8,9,10,11
Put Batteries in Remote .....	2

## Q

Quick Guide to Your TV .....	2,3,4,5
------------------------------	---------

## R

REC/Record Button .....	7,11,15
References .....	28-37
Glossary .....	35
Order Form for Parts .....	33,34
Trouble Checks .....	30,31
Warranty .....	32
Registration Card .....	i
Remote Control	
Batteries .....	2
Buttons .....	6,7
Order Form .....	33
Tour .....	4
With Components .....	7,8-15
RESET Button .....	6
REW/Rewind Button .....	7,8,11,14,15

## S

Safety Information .....	i
Screen Displays .....	29
Service .....	32
Set Clock .....	3
Set Time .....	3
Setting Cable/Air .....	27
Setting the Cable Channel .....	12
Setting the Sleep Timer .....	22
Setup Menu	
Autoprogram .....	3,20,35
Cable/Air .....	27
Cable Channel .....	13
Channel Label .....	21
Channel Memory .....	3,20
Speakers .....	9
VCR 1 Channel .....	8
Sharpness .....	17
Signal .....	35
SKIP .....	6,35
Sleep Display .....	22,28
Sleep Timer .....	22
Sharpness .....	17
Sound .....	18,19
Source .....	35
Speakers .....	19
Startup .....	2,3
Stereo .....	18,35
Stereo Display .....	29
STOP Button .....	7,8,11,15
SWAP Button .....	4,7,24,25

## T

Table of Contents .....	1
Time	
Alarm .....	23
Clock .....	3
Sleep Timer .....	22
Time Display .....	29
Tint .....	17
Tone .....	18,35
Tour of the Remote .....	4
Trouble Checks .....	30,31
Turn on Alarm .....	23
Turn on Picture-in-Picture .....	24,25

Turn on TV .....	2
TV	
Buttons .....	4,6,28
Guide to .....	2,3,4
TV Button .....	3,4,6
Time .....	3
Two Pictures at one time .....	24,25

## U

Unusable Signal Display .....	29,35
Using Advanced Features .....	20-27
Naming the Channels .....	21
Place Channels in Memory .....	20
Setting Cable or Air .....	27
Setting the Alarm Clock .....	23
Setting the Sleep Timer .....	22
Watching Closed Captioning .....	26
Watching Two Pictures .....	24,25
Using the Remote	
Audio Equipment .....	15
Laserdisc Player .....	14
Cable Box .....	12,13
VCR .....	8,9,10,11

## V

VCR	
Turn on .....	10
Turn off .....	10
Record one TV program and	
watch another .....	11
Watch a tape .....	11
VCR Button .....	7,8,9,10
VCR 1 Channel .....	8
VCR2 Button .....	7,8,9,10
VCR Codes .....	8
VCR Buttons .....	7,8
CLEAR, FF/Fast Forward,	
PAUSE, PLAY, PROG/Program,	
REC/Record, REW/Rewind,	
STOP .....	
Video .....	35
VIDEO 00 Display .....	29
Volume Display .....	29
VOL + and - Buttons	
Remote .....	4,6
TV .....	28

## W

Warning .....	i
Warranty .....	32
Watching Closed Captioning .....	26
Watching Picture-in-Picture .....	24,25



## CREATING A GREENER FUTURE

At Thomson Consumer Electronics we are dedicated to the preservation of our natural heritage and to a healthy and safe way of life for current and future generations. This is a global effort which encompasses every THOMSON facility throughout the world.

We believe that clean air, clean water, a protected earth, and healthy people are not only practical and desirable goals, but achievable ones as well. Our Corporate Environmental, Health and Safety Charter acknowledges our commitment to protect these precious assets and provides a challenging vision and guideline for conducting our business.

### THOMSON CONSUMER ELECTRONICS

Below are a few examples of Thomson's achievements in our efforts to preserve our natural resources.

#### THE EARTH

Thomson reclaims millions of pounds of hazardous waste annually, diverting it from landfills.

Thomson treats millions of pounds of waste water sludge annually and renders it non-hazardous.

Thomson recycles over 50 million pounds of non-hazardous material annually that otherwise would have been treated as trash, an overall recovery rate of 50%.

Thomson globally recycles millions of pounds of broken television picture tube glass annually through both internal and external reclaim processes.

#### THE AIR

Thomson has replaced solvent-based paints at many locations resulting in an 80% reduction in toxic air emissions for equivalent material used.

Thomson has eliminated the use of ozone-depleting substances at television manufacturing facilities around the world.

Thomson collects and returns over 1.5 million pounds of glass and furnace dust to the glass making process annually.

Thomson has launched worldwide energy savings programs which contribute to efforts to reduce air emissions from electrical generating facilities.

#### THE WATER

Thomson recovers over 2 million pounds of fine glass particles from process water each year and recycles them back into its glass furnaces.

Thomson's state-of-the-art waste water treatment plants filter out over 26 million pounds of solids from process water each year.

Thomson's U.S. glass factory recycles 2,500 gallons of water per minute and cleans 2.6 million gallons of water per day.

Thomson is researching new processes and is developing new manufacturing equipment and technologies to further reduce large volume water use.

Thomson has also increased its usage of recycled materials for packaging of our products. For example, in the U.S. and Mexico our television plants use recycled content in our television cartons. The inks used for the print on cartons are soy based. For a free brochure regarding Thomson's Environmental Health and Safety Programs, write to Thomson Consumer Electronics' address below, attention Environmental Programs: INH340.

---

Please do not send any products to the Indianapolis address listed in this manual or on the carton. This will only add delays in service for your product.

### THOMSON CONSUMER ELECTRONICS

10330 North Meridian Street  
Indianapolis, IN 46290

©1996 Thomson Consumer Electronics, Inc.  
Trademark(s)® Registered

Printed in USA  
TOCOM 1512778A