

SEARS

Owner's Manual

Model Nos.

14471

14475

14478

Model and Serial
Number Plate

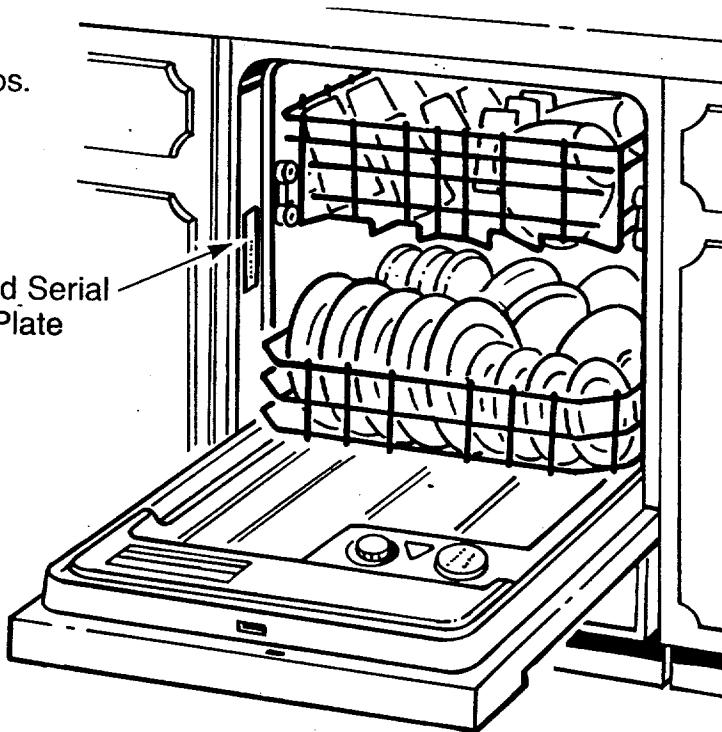

kenmore

AUTOMATIC DISHWASHER

CAUTION: Read and follow all Safety Rules and Operating Instructions before first use of this product.

Sears, Roebuck and Co., Hoffman Estates, IL 60179 U.S.A.

165D3592P062
SR5561

347 CG
Printed in U.S.A.

SAFETY

ASSEMBLY

OPERATION

MAINTENANCE

PARTS LIST

CONTENTS

Warranty	Below	Rinse Agent Dispenser	10
Important Safety Instructions	3	Proper Loading	11
Important Parts of Your Dishwasher ..	4	User Maintenance Instructions	13
What Your Dishwasher Needs	5	Care and Cleaning	13
Special Tips	6	Air Gap	13
Operating Instructions	7-9	Color Panels	14
Detergent Dispenser	10	Problems and Solutions	15-18
Detergent Usage Guide	10	Sears Service	20

WARRANTY

Full One-Year Warranty on Dishwasher

For one year from the first day of use in your home, Sears will repair, free of charge, defects in material or workmanship which appear in this dishwasher.

Full Ten-Year Warranty Against Leaks in the Tub and Inner Door Panel

For ten years from the first day of use in your home, if a leak should occur as a result of failure of the tub or inner door panel due to cracking, chipping, or peeling, Sears will replace, free of charge, the tub or inner door panel.

If the dishwasher is subjected to other than private family use, the above warranty coverage is effective for only 90 days.

Warranty service is available by contacting the nearest Sears Service Center/Department in the United States. This warranty applies only while this product is in use in the United States.

This warranty gives you specific legal rights, and you may also have other rights which vary from state to state.

The model number of your automatic dishwasher is found on the serial plate fastened to the tub wall just inside the dishwasher door.

All repair parts are available for immediate purchase or special order when you visit your nearest Sears Service Center, or the Service Department at most Sears Stores. To request service or order parts by phone, call the toll free numbers listed on the back cover.

When requesting service or ordering parts, always provide the following information:

- Product Type
- Part Number
- Model Number
- Part Description

**Sears, Roebuck and Co.,
Dept. 817WA,
Hoffman Estates, IL 60179**

IMPORTANT SAFETY INSTRUCTIONS

⚠ WARNING:

Please follow these basic precautions, including the following:

Read all instructions before using your dishwasher.

- **Only** use detergents and rinse agents recommended for use in a dishwasher.
- Store detergents and rinse agents in a cool dry place **out of children's reach**.
- **Do not** tamper with controls.
- **Do not** operate dishwasher unless all enclosure panels are properly in place.
- **Always** disconnect electrical power to dishwasher before attempting to service it. We recommend having a qualified technician service your appliance.
- **Remember**, use dishwasher for its intended purpose only.
- **Do not** wash plastic items unless marked "Dishwasher-Safe" or equivalent. If unmarked, check manufacturer's recommendations.
- This dishwasher must be properly installed in accordance with the Installation Instructions before it is used.

- **To avoid risk of electrical shock**, the dishwasher must be electrically grounded before it is operated.
- If you did not receive Installation Instructions with your dishwasher, you can get a copy by contacting your Sears Service Center.
- **Do not** touch heating element during or immediately after use. Allow time to cool.
- Load sharp or pointed tableware with handles up (points down) to avoid injury when reaching into dishwasher.
- Load sharp items and knives so they aren't likely to damage door seal.
- **Do not** sit or stand on or abuse dishwasher door or dishracks.
- **Do not** allow children to play in or on dishwasher.
- When discarding old dishwasher, **be sure** to remove door to prevent accidental entrapment.
- **Do not** install the dishwasher on carpeted floor.

GROUNDING INSTRUCTIONS

Connect to a properly rated, protected and sized power-supply circuit to avoid electrical overload.

- This appliance must be connected to a grounded metal, permanent wiring system; or an equipment-grounding conductor must be run with the circuit conductors and connected to the equipment-grounding terminal or lead of the appliance.

⚠ WARNING:

The improper connection of the equipment-grounding conductor can result in a risk of electric shock. Check with a qualified electrician or service representative if you are in doubt whether the appliance is properly grounded.

⚠ WARNING:

Under certain conditions, hydrogen gas may build up in a hot water system that has not been used for two weeks or more.

HYDROGEN GAS IS EXPLOSIVE. To prevent injury or damage, before using dishwasher, turn on all hot water faucets and allow water to run for several minutes. This will allow gases to escape. As the gas is flammable, **do not** smoke or use an open flame or appliance near faucets while they are open.

NOTE: Do not store or use combustible materials, gasoline or other flammable vapors and liquids in the vicinity of this or any other appliance.

SAVE THESE INSTRUCTIONS

IMPORTANT PARTS OF YOUR DISHWASHER

Appearance will vary according to the model number

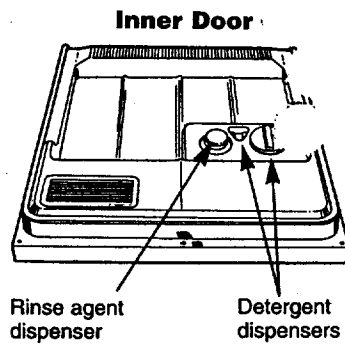
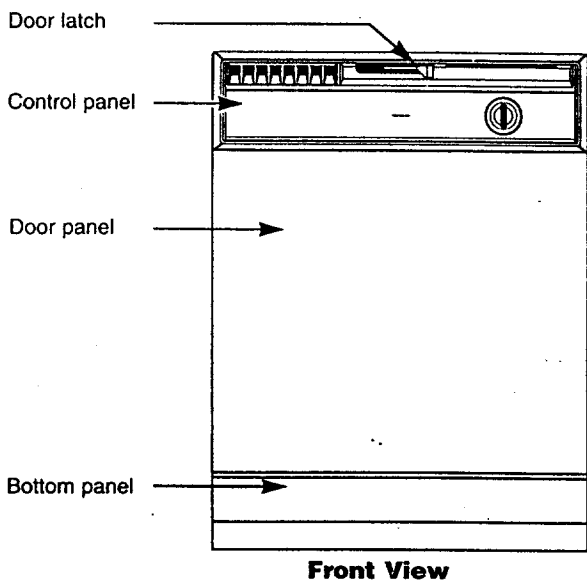
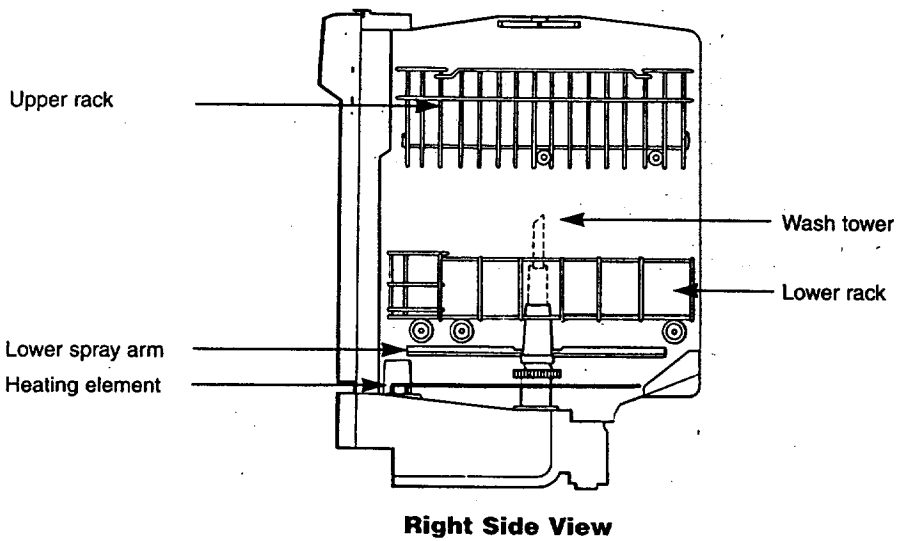

WHAT YOUR DISHWASHER NEEDS TO DO ITS JOB

Hot Water

To get dishes clean and dry you need hot water. To help you get water of the proper temperature, your dishwasher automatically heats the water in the wash cycle. Higher water temperature is needed to dissolve grease and activate powder detergents. For good washing and drying, the entering water must be at least 120°F. To prevent dish damage, inlet water should not exceed 150°F.

Check your water temperature with a candy or meat thermometer.

Turn on the hot water faucet nearest the dishwasher. Put the thermometer in a glass and let the water run continuously into the glass until the temperature stops rising.

Do not operate the dishwasher during or right after other heavy use of hot water, such as for laundry or bathing.

Water Pressure

Water supply pressure must be between 15 and 120 pounds per square inch. To determine if you have enough pressure, put a 1 quart container under a fully opened hot water faucet nearest the dishwasher. If the container fills in less than 9 seconds, water pressure is within acceptable range. Be sure all other faucets are turned off during this test.



Water Conditions

In areas where water is very hard (12 grains or more), it may be necessary to install a water softener to assure proper performance from your dishwasher. If you do not know the hardness of your water supply, contact your local water department or bring a sample into your Sears store for testing.



Detergents

Only use detergents labeled for use in automatic dishwashers. NEVER use laundry detergents, liquid soaps or other household cleaners in your dishwasher. Some detergents will be more effective with your water conditions than others. Store detergent in a cool, dry place.



Rinse Agents

Rinse agents make water flow off dishes quicker than usual. This lessens water spotting and makes drying faster, too.

Rinse agents come in either liquid or solid form. Your dishwasher's dispenser uses the liquid form.



ASSEMBLY

SPECIAL TIPS ON DISHWASHER USE

Most utensils and dishware can be safely washed in your dishwasher. However, some materials may require special handling.

Aluminum: Some darkening may take place. Colored aluminum may fade. Do not place aluminum items directly in front of detergent dispensers where contact with undissolved detergent could cause pitting, spotting or discoloration.

Cast Iron: Cast iron utensils should be handwashed.

China: Antique, hand-painted china and those with gold or platinum rings should be handwashed.

Crystal: Load carefully in **upper rack only**. To prevent chipping, items should not touch. Handwash delicate items. Select **NO HEAT DRY** option to air-dry crystal items.

Flatware: Sterling, silverplate and stainless steel are normally dishwasher safe. Flatware with dark decorative shading and/or non-metallic handles should be handwashed.

Pewter: Pewter or pewter-like materials should be handwashed.

Plastic: Plastic items should be placed in **upper rack only**. Wash only those items marked "Dishwasher Safe."

Wood: Wood items should be handwashed.

Glass: Milk glass should be handwashed.

Non-Stick Coatings: After washing, wipe the non-stick coating area with vegetable oil to keep it from losing its non-stick quality.

Non-Dishware Items: DO NOT wash items such as electronic air cleaner filters, furnace filters and paint brushes in your dishwasher. Damage to dishwasher and discoloration or staining of dishwasher may result.

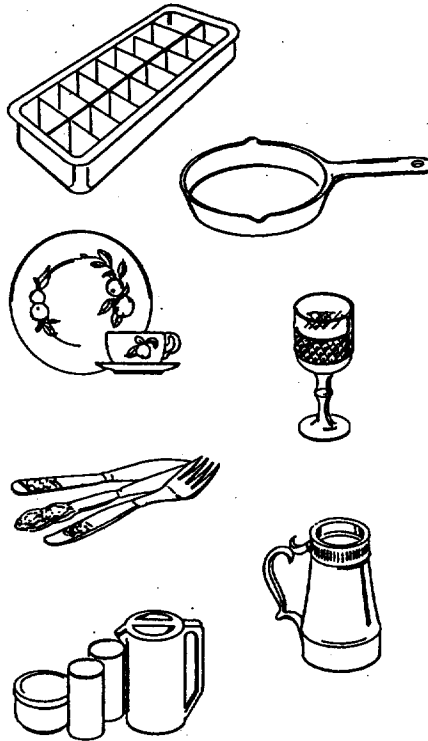

OPERATING INSTRUCTIONS

Appearance may vary

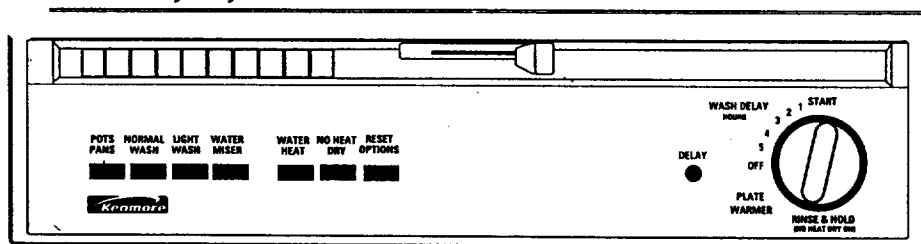

STARTING YOUR DISHWASHER

- Load the dishwasher (see pages 11 and 12).
- Add detergent (see page 10).
- Close the door **but do not latch it**.
- If dishwasher drains into a food waste disposer, operate disposer until it is empty.
- Turn on hot water faucet nearest dishwasher and let it run until the water is hot.
- Push selector buttons for desired cycles and options.
- For all cycles but RINSE & HOLD, slowly turn the Dial to START. Then latch door to start the dishwasher.
- If you plan to use the RINSE & HOLD cycle, push the NORMAL WASH button and turn the Dial to the desired cycle. Then latch the door to start the dishwasher.

- If you plan to use the PLATE WARMER option (which is for warming clean dishes and plates for the serving of hot foods), follow these steps:

1. Load clean dishware to be warmed.
2. Make sure NO HEAT DRY is not selected.
3. Be sure the door is unlatched.
4. Slowly turn the Dial to PLATE WARMER.
5. Latch door to start the cycle.

When NOT using WASH DELAY

- Slowly turn the Dial to START for the NORMAL WASH cycle. Then latch the door to start the dishwasher.

When using WASH DELAY (for all cycles)

- Slowly turn the Dial to desired delay time (up to 5 hours). Then latch the door to start the timer.
- The DELAY light will come on and stay on until the dishwasher starts automatically at the end of the selected delay time.

OPERATION

SELECT THE CYCLE

POTS PANS

For heavily soiled dishes and pots and pans.

Cycle Time: Approx. 95 minutes*

Water Usage: Approx. 9.3 gallons

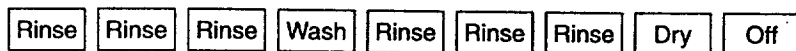
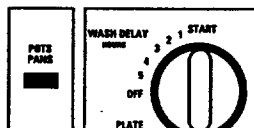

* Unextended times. These cycle times will be increased approximately 21 minutes for your dishwasher to heat the water for good washability when you use the WATER HEAT option.

NORMAL WASH

For normally soiled dishes.

Cycle Time: Approx. 95 minutes*

Water Usage: Approx. 8.0 gallons

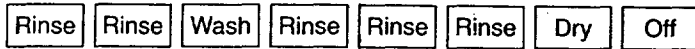
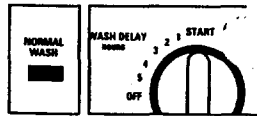

LIGHT WASH

For prerinse or lightly soiled dishes and dishes that have been stored.

Cycle Time: Approx. 95 minutes*

Water Usage: Approx. 6.7 gallons

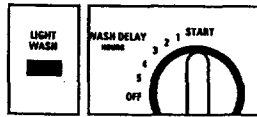

WATER MISER

For tableware that is lightly soiled with fresh soils and is prerinse.

Cycle Time: Approx. 95 minutes*

Water Usage: Approx. 5.4 gallons

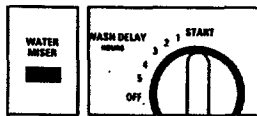

RINSE & HOLD

For rinsing dishes that will be washed later. **DO NOT** use detergent. Select **NO HEAT DRY** no-heat drying option.

Cycle Time: Approx. 9 minutes

Water Usage: Approx. 2.6 gallons

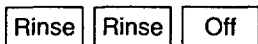
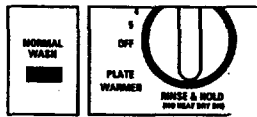

* Unextended times. These cycle times will be increased approximately 21 minutes for your dishwasher to heat the water for good washability when you use the **WATER HEAT** option.

SELECT OPTIONS

WATER HEAT Option

Select this option and the main wash cycle is extended 21 minutes while the dishwasher heats the water for good washing and drying.



RESET OPTIONS Button

Cancels selected **WATER HEAT** and **NO HEAT DRY** options. Main wash time will not be extended, and dishes will dry in heated air.



NO HEAT DRY option

Turns heater off for entire drying period. To shorten drying time, open dishwasher door slightly.



NORMAL SIGHTS AND SOUNDS

- You'll see water vapor coming through the vents by the door latch during drying and when water is being pumped out.
- You'll hear occasional sounds while your dishwasher is running:
 - Soft food disposer shredding action.
 - Drain valve opening to pump water out.
 - Timer control as cycle progresses.
 - Detergent cup opening.
 - Pump motor starting.
 - The motor stops during drying.

ENERGY AND WATER SAVING TIPS

- Wash full loads.
- Use your dishwasher during off-peak hours.
- Use the LIGHT WASH cycle whenever possible.
 - Select COOL DRY option when you don't need dry dishes in a hurry.
 - Don't prerinse normally soiled dishes.
- Load correctly to ensure good washing action.

HOW TO ADD A DISH DURING A CYCLE

- Add dishes any time during RINSE & HOLD cycle.
- With other wash cycles, you can add dishes at any time BEFORE the detergent cup has opened.

Here's how to add a forgotten dish:

1. Push door latch to the left. Washing will stop.
2. Wait a few seconds until the water calms. Then open the door.
3. Add dishes you've forgotten.

PREPARING DISHES FOR WASHING

- Prerinsing of normal food soil is not necessary.
- Scrape off bones, seeds, skins, toothpicks and other hard soils.
- Remove hard shelled vegetables, meat trimmings, leafy vegetables, and excessive amounts of oil or grease.
- Remove foods with high acid content—they can discolor stainless steel.
- Remove large quantities of any food.
- When using the POTS PANS cycle, less preparation is required. This cycle can wash heavily-soiled dishes and remove dried-on and baked-on soils from pots, pans and casseroles. However, items with burned-on soils may not come clean.

DETERGENT DISPENSER

You'll find two detergent dispensers on the inside door of your dishwasher.

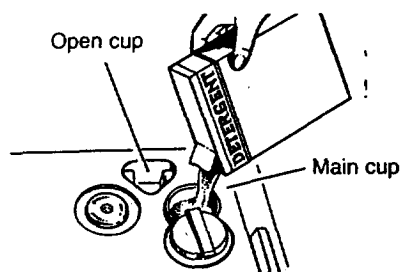

Do not add detergent until you are ready to start the cycle. Use fresh detergent.

The dispenser will automatically release detergent at the correct times during the cycle.

Always close the main cup tightly. When it is firmly latched you will hear a clicking sound. It is not necessary to overtighten.

Grasp handle, rotate and close tightly

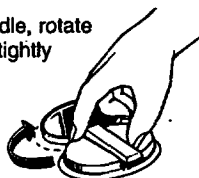

Close the main cup.

NOTE: To open the detergent dispenser after it has been closed, unlatch the door and rotate the Dial a full turn to the **OFF** position. When the closed cup contains soap it is best that the door be in a partially open position before rotating the Dial. This will help reduce the amount of detergent and rinse aid agent spillage into the tub.

Detergent Usage Guide (powder or liquid)

Cycles	Water Hardness			
	Soft Water (0 to 3 grains)	Moderately Hard Water (4 to 8 grains)	Hard Water (9 to 12 grains)	Very Hard Water (over 12 grains)
Light Wash	Main Cup 1 tablespoon	Main Cup Half Full	Main Cup Completely Full	Water Softener Recommended
Pots Pans Normal Wash	Each Cup 1 tablespoon	Each Cup Half Full	Each Cup Completely Full	Water Softener Recommended
Rinse & Hold	No Detergent	No Detergent	No Detergent	Water Softener Recommended

RINSE AGENT DISPENSER

To fill the dispenser:

Unscrew the cap. Note the **FULL** line on the tip of the cap. Add the liquid rinse agent until it just reaches the top of the **FULL** line. Replace the cap. The dispenser automatically releases the rinse agent into the final rinse water.

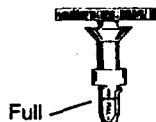

Fill as needed, but do not overfill.

PROPER LOADING

UPPER RACK (appearance will vary)

The upper rack is best for glasses, cups and saucers. Cups and glasses fit best along the sides. This is also the place for dishwasher-safe plastics. Make sure small plastic items are lodged in tightly so they can't fall onto the heating unit. Arrange stemware so that it cannot move easily. Don't let the glasses touch each other.

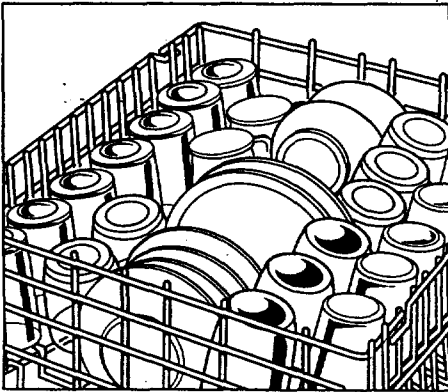

The upper rack is handy for all kinds of odd shapes. Saucepans, mixing bowls and other items should be placed face down. When loading dishwasher-safe plastics make sure each plastic item is secured over two fingers. This will insure good washing results.

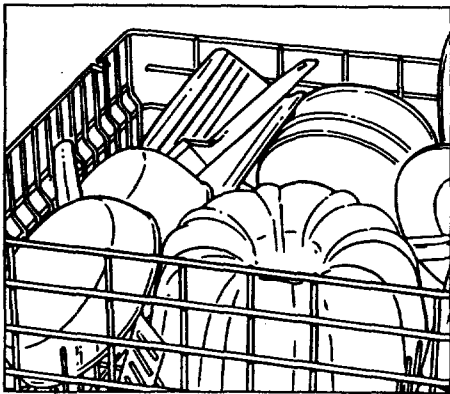

LOWER RACK (appearance will vary)

NOTE: Do not load large platters or trays in front right corner of lower rack. They may prevent detergent from circulating in the wash cycle.

The lower rack is best used for plates, saucers, and cookware. Large items such as broiler pans and racks should go in the lower rack along the edge. Load platters, pots and bowls along the sides, in corners, or in the back. For best washing results, all items should be positioned with the soiled side of the dish facing the center of the rack.

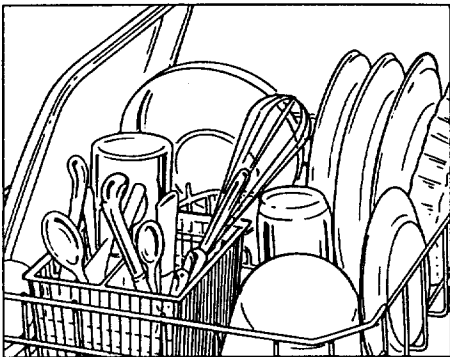

Keep center area clear in the lower rack.

The Wash Tower rises through the center of the lower rack during the wash and rinse portions of the cycle. Don't block it or load tall things next to it. Also, be careful not to let a portion of an item such as a pot or dish handle extend through the bottom rack. This could block the wash arm and cause poor washing results.

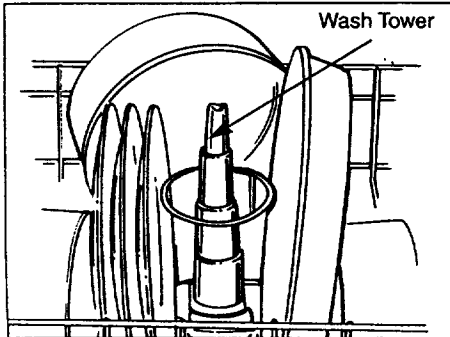

Put flatware in the removable basket with fork and knife handles up to protect your hands. Place spoons in the basket with handles down. Mix knives, forks and spoons so they don't nest together. Distribute evenly.

Small plastic items, such as measuring spoons and lids from small containers, are not recommended for automatic dishwashing. If placed in dishwasher, they should go in bottom of utensil basket with silverware on top.

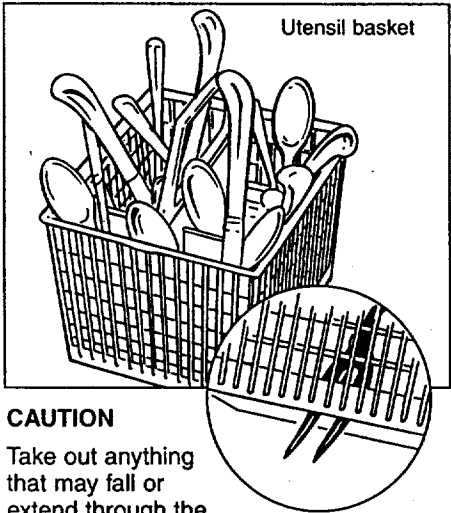

CAUTION
Take out anything that may fall or extend through the bottom of the utensil basket.

USER MAINTENANCE INSTRUCTIONS

CARE OF SURFACES

Clean control panel with lightly dampened cloth. Dry thoroughly.

DO NOT use abrasives or sharp objects—they could damage the control panel.

- Clean outside cabinet finish with a good appliance polish wax. **DO NOT** use scouring pads, harsh or gritty cleaners.
- Interior is self-cleaning with normal use. If it should ever need cleaning, use a mild cleansing powder. If hard water causes lime build-up, clean as follows:
 - Pour 2 cups white vinegar into empty dishwasher. **DO NOT** use detergent.
 - Operate machine on **NORMAL WASH** cycle.

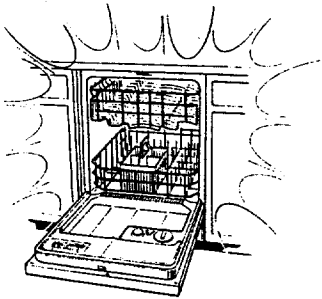

CARE OF AIR GAP

If an air gap was installed for your built-in dishwasher, check to make sure it is clean. Air gaps are usually mounted on the countertop and can be inspected by removing the cover. The air gap is not part of your dishwasher and is not covered by Sears warranty.

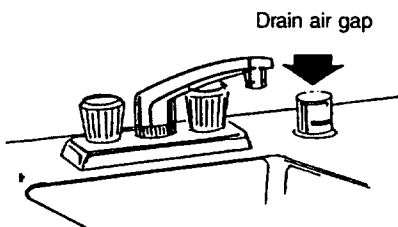

PROTECTION AGAINST FREEZING

If dishwasher is left in an unheated place during the winter:

- Shut off water and electrical power.
- Remove access panel.
- Disconnect water lines from valve. Drain into a flat pan.
- Drain collection chamber at rear of unit below filter by disconnecting hose to pump.
- Remove plastic pump cover in tub bottom and use sponge to soak up any remaining water.
- Reconnect water lines to valve and hoses to pump.

Pump cover screws

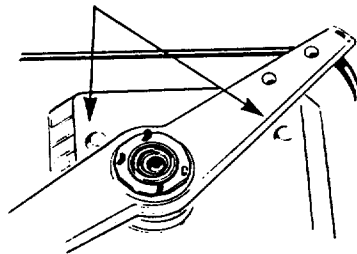

PREPARATION FOR MOVING

- Disconnect electrical power.
- Turn off water supply, disconnect water and drain lines.
- Tape racks in place; close door securely and tape it shut.
- Wrap with blankets and, if using a hand truck, lift dishwasher from side in upright position only.

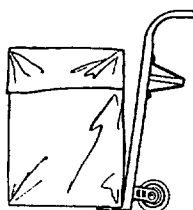

COLOR PANELS

OPTIONAL ACCESSORIES

You can change the door and lower access panel appearance of your dishwasher by ordering one of these optional accessories:

- Color Panels
- 1/4" Wood Panel Trim Kit

These accessories are available from:

Dri-View Manufacturing
4706 Allmond Avenue
Louisville, KY 40209

Specify accessory number when ordering.

DESCRIPTIONS OF OPTIONAL ACCESSORIES

Color Panels— Replacement door and lower access panels are available in the following colors:

- GPF400A (Almond)
- GPF400B (Black)
- GPF400W (White)

Wood Panel Trim Kit—This accessory contains trim and instructions for you to supply and install a 1/4" thick decorative wood door and lower access panel:

- 22-16071 (White)
- 22-16075 (Black)
- 22-16078 (Almond)

NOTE: The 22-16072 dishwasher door spring kit must also be ordered and installed when the door panel weighs four lbs. or more.

COMMON DISHWASHING PROBLEMS AND SOLUTIONS

PROBLEM	CAUSED BY	SOLUTION
Dishwasher will not start	<ul style="list-style-type: none"> •Dishwasher not receiving electricity •Dial not in correct position for cycle selected •Turning the Dial too far 	<ul style="list-style-type: none"> •Check house fuse or circuit breaker. •Make sure Dial is turned far enough and cycle button is fully pushed in. •Turn Dial to START. Be careful you do not turn the Dial any farther than necessary. There is a delay between start-up and water fill so you will not hear any wash action right away.
Dishwasher will not fill with water	<ul style="list-style-type: none"> •Turning the Dial too far •No water supply •Water inlet valve clogged 	<ul style="list-style-type: none"> •See the solution above. •Make sure water supply valve under sink is turned on. •Water valve supply line may be clogged with sediment. Clean out.
Unusual noise	<ul style="list-style-type: none"> •Improper loading 	<ul style="list-style-type: none"> •Utensils may not be secure on rack pins, or something small may have dropped from the rack. Water is causing utensils to rattle. Make sure everything is securely placed in dishwasher.
Dishwasher leaks	<ul style="list-style-type: none"> •Dishwasher not level •Too much sudsing •Spilled rinse agent •Dishwasher door interferes with surrounding cabinets 	<ul style="list-style-type: none"> •Level dishwasher as described in Installation Instructions. Don't place dishwasher on carpet. •Improper detergent. Use automatic dishwasher detergent only or try a different brand or less detergent. •If hand dishwashing detergent is used by mistake, pour one measuring cup of vegetable oil in bottom of tub and run dishwasher through a complete NORMAL WASH cycle with recommended amount of automatic dishwashing detergent. •To remove suds from tub: Open dishwasher. Let suds evaporate. Add 1 gallon of cold water to tub. Close and latch dishwasher. Pump out water by slowly turning Dial until a drain period is reached. Repeat if necessary. •Spilled rinse agent can cause foam during washing. This can lead to overflowing. Wipe up accidental spill of rinse agent with a damp cloth. •Make sure door does not touch cabinets when opening or closing. Use levelling legs to level dishwasher.

PROBLEM	CAUSED BY	SOLUTION
Dishes not dry	<ul style="list-style-type: none"> •Water is not hot •NO HEAT DRY , option selected •Improper loading •Rinse agent dispenser empty 	<ul style="list-style-type: none"> •Raise water heater thermostat to 140°F if necessary. •Do not select NO HEAT DRY option.Allow dishes to dry in heated air. •Load dishes so items drain properly. Avoid overloading. •Fill rinse agent dispenser if empty.
Spotting and filming	<ul style="list-style-type: none"> •Hard water •Water is not hot •NO HEAT DRY option selected •Not enough or poor quality detergent •Old detergent •No rinse agent 	<ul style="list-style-type: none"> •Fill detergent cups to capacity. Use dishwasher detergent with highest available phosphorous content. May be necessary to install a water softener. •Raise water heater thermostat to 140°F. •Drying without heat may cause some spotting. Do not select NO HEAT DRY option. •Use more fresh automatic dishwasher detergent. Use detergent with highest available phosphorous content, especially if you have hard water. •Use only fresh, automatic dishwasher detergent. Store tightly closed in a cool, dry place. Discard old, lumpy or separated detergent. Do not fill detergent dispenser until ready to wash. •Fill rinse agent dispenser. <p>To remove stubborn spots and film from glassware:</p> <ol style="list-style-type: none"> 1. Remove all metal utensils from the dishwasher. 2. Do not add detergent. 3. Select POTS PANS cycle. 4. Start the dishwasher and allow to run for 18 to 20 minutes. The dishwasher will now be in the main wash. 5. Then open the door and pour 2 cups (500 ml) white vinegar into bottom of dishwasher. 6. Close the door and allow to complete the cycle. <p>If vinegar rinse doesn't work: Repeat as above, except use 1/4 cup (60 ml) of citric acid crystals instead of vinegar. (Most drugstores carry citric acid crystals.)</p>

PROBLEM	CAUSED BY	SOLUTION
Spitting—permanent filming which cannot be removed	<ul style="list-style-type: none"> • Too much detergent in soft water • Improper loading 	<ul style="list-style-type: none"> • Reduce amount of dishwasher detergent. Use detergent with lower phosphorous content. • Make sure dishes and glassware are loaded properly to permit water spray to rinse all surfaces. Do not overload.
Water left in bottom of tub	<ul style="list-style-type: none"> • Normal amount of water 	<ul style="list-style-type: none"> • It is normal for a small amount of clean water to remain in bottom of tub after each cycle. • Clean the drain air gap. See User Maintenance Instructions.
Dishes and interior of dishwasher brown or yellow	<ul style="list-style-type: none"> • Iron or manganese in water 	<ul style="list-style-type: none"> • Install an iron or manganese filter in home water supply.
Film build-up on lower front of tub	<ul style="list-style-type: none"> • Some detergent did not dissolve 	<ul style="list-style-type: none"> • Use fresh, automatic dishwasher detergent. Use detergent with highest available phosphorous content, especially if you have hard water. Raise water heater thermostat to 140°F if necessary. Run water at sink until hot before starting dishwasher. Remove film with dishwashing detergent and warm water.
Silverware stained	<ul style="list-style-type: none"> • Undissolved detergent contacting wet silverware • Acidic or salty food soils 	<ul style="list-style-type: none"> • Avoid spilling dry detergent on wet silverware. Clean with silver polish. • Use RINSE & HOLD cycle. Certain foods left on silverware for extended periods of time may cause pitting.
Bronze tarnish on silver plate	<ul style="list-style-type: none"> • Silver plate worn off exposing base metal—takes on bronze hue 	<ul style="list-style-type: none"> • Remove tarnish with silver polish.
Black or gray marks on dish	<ul style="list-style-type: none"> • Metal utensils rubbing against dishes during wash 	<ul style="list-style-type: none"> • Load metal utensils so they do not rub against dishes. Marks may be removed with mild abrasive cleanser and plastic scouring pad.
Dishware chipped or broken	<ul style="list-style-type: none"> • Improper loading 	<ul style="list-style-type: none"> • Do not overload. Load glasses in upper rack only. See Loading section for tips.
Dishwasher odor	<ul style="list-style-type: none"> • Soiled dishes held too long in dishwasher • Vinyl rack coating 	<ul style="list-style-type: none"> • Use RINSE & HOLD cycle if dishes will not be washed at end of day. • Plastic odor will be gone after several weeks use.

PROBLEM	CAUSED BY	SOLUTION
Motor hums	<ul style="list-style-type: none"> •Dishwasher has not been used on a regular basis 	<ul style="list-style-type: none"> •If you do not use your dishwasher often, set it to fill and pump out once every week. This will help keep the seal moist and the garbage disposer clear.
Staining of tub interior	<ul style="list-style-type: none"> •Some detergents contain colorant (pigment or dyes) •Some tomato-based foods can stain 	<ul style="list-style-type: none"> •This will discolor the tub interior with extended use. Check the detergent dispenser for signs of any discoloration. If dispenser is discolored, change to detergent without any colorant. •Using the RINSE & HOLD cycle after adding dish to the load can decrease the level of staining.
Vapor at the vent	<ul style="list-style-type: none"> •Water vapor comes through the vent by the door latch during drying and when water is being pumped out 	<ul style="list-style-type: none"> •This is a normal occurrence.
Detergent cup lid won't latch after adding detergent	<ul style="list-style-type: none"> •Dial not in OFF position 	<ul style="list-style-type: none"> •Dial must be in OFF position for cup lid to close and latch properly. If you unlatch the door and open it to dry your dishes, the Dial does not advance to OFF by itself.

NOTES

For the repair or replacement parts you need
delivered directly to your home
Call 7 am – 7 pm, 7 days a week

1-800-366-PART
(1-800-366-7278)

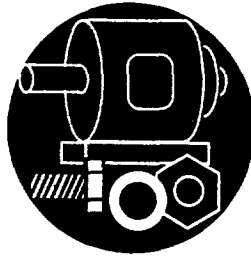

For in-home major brand repair service
Call 24 hours a day, 7 days a week

1-800-4-REPAIR
(1-800-473-7247)



For the location of a
Sears Parts and Repair Center in your area
Call 24 hours a day, 7 days a week

1-800-488-1222



For information on purchasing a Sears
Maintenance Agreement or to inquire
about an existing Agreement
call 9 am – 5 pm, Monday–Saturday

1-800-827-6655



When requesting service or ordering
parts, always provide the following
information:

- Product Type
- Part Number
- Model Number
- Part Description

SEARS
REPAIR SERVICES
America's Repair Specialists