

Trinitron Color TV

Operating Instructions

<i>KV-27S26</i>	<i>KV-29RS26</i>	<i>KV-32S26</i>	<i>KV-34RS26C</i>	<i>KV-35S26</i>	<i>KV-37RS26</i>
<i>KV-27S36</i>	<i>KV-29RS26C</i>	<i>KV-32S36</i>	<i>KV-34V36C</i>	<i>KV-35S36</i>	<i>KV-37V36M</i>
<i>KV-27V26</i>	<i>KV-29V36C</i>	<i>KV-32TW26</i>		<i>KV-35V36</i>	
<i>KV-27V36</i>	<i>KV-29V66M</i>	<i>KV-32V26</i>		<i>KV-35V76</i>	
	<i>KV-29V76M</i>	<i>KV-32V36</i>			

© 1997 by Sony Corporation

WARNING

To prevent fire or shock hazard, do not expose the TV to rain or moisture.



CAUTION
RISK OF ELECTRIC SHOCK
DO NOT OPEN



ATTENTION
RISQUE DE CHOC ELECTRIQUE,
NE PAS OUVRIR

PRECAUCION
RIESGO DE CHOQUE ELECTRICO
NO ABRIR

**CAUTION: TO REDUCE THE RISK OF ELECTRIC SHOCK,
DO NOT REMOVE COVER (OR BACK).
NO USER-SERVICEABLE PARTS INSIDE.
REFER SERVICING TO QUALIFIED SERVICE PERSONNEL.**



This symbol is intended to alert the user to the presence of uninsulated "dangerous voltage" within the product's enclosure that may be of sufficient magnitude to constitute a risk of electric shock to persons.



This symbol is intended to alert the user to the presence of important operating and maintenance (servicing) instructions in the literature accompanying the appliance.

CAUTION

TO PREVENT ELECTRIC SHOCK, DO NOT USE THIS POLARIZED AC PLUG WITH AN EXTENSION CORD, RECEPTACLE, OR OTHER OUTLET UNLESS THE BLADES CAN BE FULLY INSERTED TO PREVENT BLADE EXPOSURE.

CAUTION

When using TV games, computers, and similar products with your TV, keep the brightness and contrast functions at low settings. If a fixed (non-moving) pattern is left on the screen for long periods of time at a high brightness or contrast setting, the image can be permanently imprinted onto the screen. Continuously watching the same program can cause the imprint of station logos onto the TV screen. These types of imprints are not covered by your warranty because they are the result of misuse.

Note on Caption Vision

This television receiver provides display of television closed captioning in accordance with §15.119 of the FCC rules.

Note on cleaning the TV

Clean the TV with a soft dry cloth. Never use strong solvents such as thinner or benzine, which might damage the finish of the cabinet.

Note to CATV system installer

This reminder is provided to call the CATV system installer's attention to Article 820-40 of the NEC that provides guidelines for proper grounding and, in particular, specifies that the cable ground shall be connected to the grounding system of the building, as close to the point of cable entry as practical.

Use of this television receiver for other than private viewing of programs broadcast on UHF or VHF or transmitted by cable companies for the use of the general public may require authorization from the broadcaster/cable company and/or program owner.

NOTIFICATION

This equipment has been tested and found to comply with the limits for a Class B digital device pursuant to Part 15 of the FCC Rules. These limits are designed to provide reasonable protection against harmful

interference in a residential installation. This equipment generates, uses, and can radiate radio frequency energy and, if not installed and used in accordance with the instructions, may cause harmful interference with radio communications. However, there is no guarantee that interference will not occur in a particular installation. If this equipment does cause harmful interference to radio or television reception, which can be determined by turning the equipment off and on, the user is encouraged to try to correct the interference by one or more of the following measures:

- Reorient or relocate the receiving antennas.
- Increase the separation between the equipment and receiver.
- Connect the equipment into an outlet on a circuit different from that to which the receiver is connected.
- Consult the dealer or an experienced radio/TV technician for help.

You are cautioned that any changes or modifications not expressly approved in this manual could void your authority to operate this equipment.

This document is for the remote control RM-Y136A/Y137A.

MODELS: KV-27S26, 27S36, 27V26, 27V36, 29RS26, 29RS26C, 29V36C, 29V66M, 29V76M, 32S26, 32S36, 32TW26, 32V26, 32V36, 34RS26C, 34V36C, 35S26, 35S36, 35V36, 35V76, 37RS26, 37V36M

Table of Contents

Welcome!	1
Precautions	1
Using This Manual	1

Connecting and Installing the TV

Connector Types	2
Making Connections	2
Connecting directly to cable or an antenna	2
Cable or antenna	3
Cable and antenna	3
Connecting a cable box	3
Cable box and cable	3
Connecting an antenna/cable TV system with a VCR	4
Connecting to an S Video equipped VCR	4
Connecting a VCR and TV with a cable box	5
Connecting to an S Video equipped VCR with a cable box	5
Connecting a DBS receiver	6
Connecting a DBS receiver and a VCR	6
Connecting an audio system	7
Connecting an AV receiver	7

Connecting two VCRs for tape editing using MONITOR OUT	8
Using the S-Link function	9
Connecting a camcorder	9
Installing the glass door	10
Adjusting the shelf	11

Basic Set Up

Inserting batteries	12
Using the remote control Select buttons	12
Adjusting sliders	12
On Line Help/Instructions	12

Using your New TV

Setting up the TV automatically	13
Watching the TV	14
Watching two programs at one time — PIP	16

Adjusting your SET UP (menus)

Learning menu selection	18
Using the VIDEO menu	19
Using the AUDIO menu	20
Using the TIMER menu	21

Using the SET UP menu	22
-----------------------------	----

Operating video equipment

Setting the manufacturer's code	24
---------------------------------------	----

Operating a cable box or DBS receiver

Programming the remote	26
------------------------------	----

Troubleshooting

.....	27
-------	----

Specifications

.....	28
-------	----

Index

.....	31
-------	----

Owner's Record

The model and serial numbers are located at the rear of the TV, below the Sony logo, on the sticker, and also on the TV box (white label). Record these numbers in the spaces provided below. Refer to them whenever you call upon your Sony dealer regarding this product.

Model No. KV-
Serial No.

Remote Control

In the instructions that follow, we will refer to the buttons on your remote control. Keep this flap unfolded and look to this page for reference.



SYSTEM OFF
(page 9 and 15)

DISPLAY SLEEP

JUMP
TV/DBS
(page 20)

RESET
(page 19)

VOL +/-

CODE SET
(page 24)

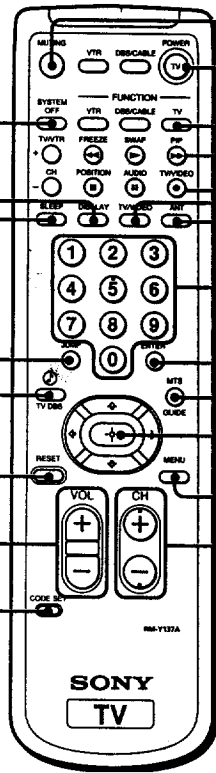

MUTING

TV (POWER)

TV (FUNCTION)

PIP (page 16)

TV / VIDEO

ANT (page 3 and 15)

0 - 9 buttons

ENTER

MTS (page 20)/GUIDE

Select buttons
(page 12 and 18)

MENU

CH +/-

Getting to know the buttons on the remote control

Names of the buttons on the remote control are presented in different colors to represent the available functions.

Button color

Transparent Press to select the component you want to control; e.g. VTR (VCR), DBS (Direct Broadcast Satellite)/CABLE, or TV.

Green Buttons relevant to power operations, like turning the TV, DBS (Direct Broadcast Satellite)/CABLE, or VTR (VCR) on or off.

Label color

White TV/VTR (VCR)/DBS (Direct Broadcast Satellite)/CABLE operation buttons.

Yellow PIP operation buttons.

Blue DBS (Direct Broadcast Satellite) operation buttons.

Green S-Link operation buttons.

For a detailed explanation of most buttons, see "Watching the TV" on page 14.

Welcome!

Thank you for purchasing the Sony Trinitron® Color TV. This manual is written for the models listed below. Before reading, check the model number on the rear of your TV.

Model KV-27S26 is used for illustration purposes. The screens displayed are for model KV-35V36. Differences in operation features are indicated in the text; for example, "KV-27S26 only".

Model Number	Single tuner (VCR required for PIP)	Dual tuner ("Ready to Use" PIP)	LightSensor/SRS	Tilt correction	Channel Fix	Favorite Channel Preview
KV-27S26	•				•	
KV-27V26	•		•		•	
KV-29RS26	•				•	
KV-29V36C		•	•		•	•
KV-29V76M		•	•		•	•
KV-32S36		•			•	•
KV-32V26	•		•		•	
KV-34RS26C	•				•	
KV-35S26	•			•	•	
KV-35V36		•	•	•	•	•
KV-37RS26	•			•	•	

Precautions

Safety

- Operate the TV only on 120 V AC (except KV-29RS26C, 29V36C, 34RS26C, 34V36C).
- Operate the TV only on 220 V AC (KV-29RS26C, 29V36C, 34RS26C, 34V36C only).
- The plug is designed, for safety purposes, to fit in the wall outlet only one way. If you are unable to insert the plug fully into the outlet, contact your dealer (except KV-29RS26C, 29V36C, 34RS26C, 34V36C).
- If any liquid or solid object should fall inside the cabinet, unplug the TV immediately and have it checked by qualified personnel before operating it further.
- If you will not be using the TV for several days, disconnect power by pulling the plug itself. Never pull on the cord.

For details concerning safety precautions, see the supplied leaflet "IMPORTANT SAFEGUARDS".

Installing

- To prevent internal heat build-up, do not block the ventilation openings.
- Do not install the TV in a hot or humid place, or in a place subject to excessive dust or mechanical vibration.

Using This Manual

This manual is divided into four major sections. We recommend that you carefully review the contents of each section in the order provided to ensure that you fully understand the operation of your new TV.

1 Connecting and Installing the TV.

This section will guide you through your initial set up. It will show you how to connect your new components, connect to your antenna or cable, and connect any accessories.

2 Basic Set Up.

This section will teach you the basic skills needed to operate your new TV. It will show you how to operate special functions of the remote control.

3 Using your New TV.

This section will show you how to begin using your new TV. It will show you how to use the AUTO SET UP feature, and how to use your remote control's features.

4 Adjusting your Set Up (menus).

This section will teach you how to access on-screen menus and adjust your TV's settings.

Instructions in this manual are written for the remote control. Similar controls may be found on the TV console.

Connecting and Installing the TV

Connector Types

You may find it necessary to use some of the following connector types during set up.

Coaxial Cable

Standard TV Cable and Antenna connector

Plug Type



Screw-on Type



S Video Cable

High quality Video connector for enhanced picture quality

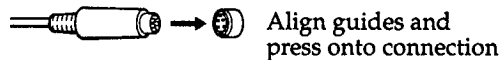

Audio/Video Cable

Conventional Audio/Video cable

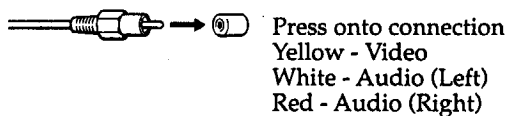

S-Link Cable

Sony Link connector (only available on Sony products) for simultaneous control of your components



Making Connections

For best picture quality, a cable TV system or outdoor antenna is recommended.

Connecting directly to cable or an antenna

The connection you choose will depend on the cable found in your home. Newer homes will be equipped with standard coaxial cable (see **A**); older homes will probably have 300-ohm twin lead cable (see **B**); still other homes may contain both (see **C**).

A

- VHF only or
- VHF/UHF or
- Cable

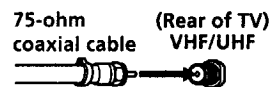

B

- VHF only or
- UHF only or
- VHF/UHF

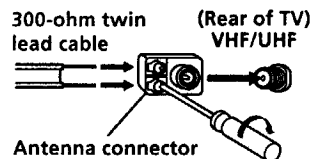

C

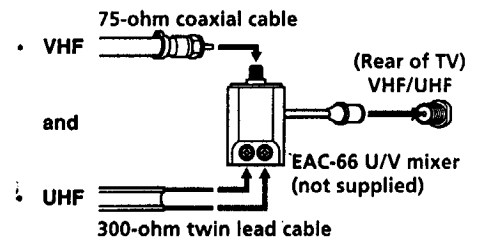

Cable or antenna

Most simple connection. Connection is made directly from the cable or antenna to the TV.



Cable and antenna

- KV-27536, 27V36, 29V36C, 29V76M, 32536, 32V36, 34V36C, 35536, 35V36, 35V76, 37V36M only

You may find it convenient to use the following set up if your cable provider does not feature local channels that you are able to receive using an antenna.

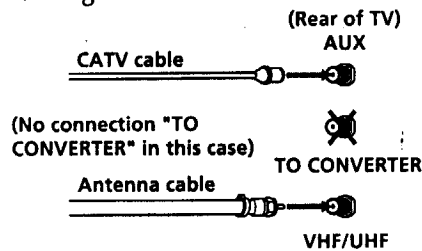

Select Cable or ANT mode by pressing ANT on the remote control.

Connecting a cable box

Some pay cable TV systems use scrambled or encoded signals that require a cable box* to view all channels.

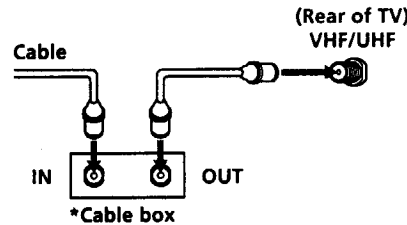

Note:

- If you will be controlling all channel selection through your cable box you should consider using the CHANNEL FIX feature discussed on page 22.

Cable box and cable

- KV-27536, 27V36, 29V36C, 29V76M, 32536, 32V36, 34V36C, 35536, 35V36, 35V76, 37V36M only

Some pay cable TV systems use scrambled or encoded signals requiring a cable box* only for certain channels (e.g. HBO, SHOWTIME, etc.).

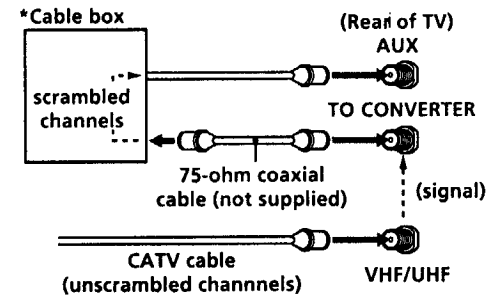

For this set up, you can switch between scrambled channels (through your cable box), and normal (CATV) channels by pressing ANT on your remote control.

- * Your Sony remote control can be programmed to operate your cable box (see page 26).

Notes:

- You cannot watch the signal through the "AUX" input as a window picture when using Picture-in-Picture (PIP).
- If you are connecting a cable box through the "AUX" input and would like to switch between the "AUX" and normal (CATV) input you should consider using the CHANNEL FIX feature discussed on page 22.

Connecting and Installing the TV (continued)

Connecting an antenna/cable TV system with a VCR

- 1 Attach the coaxial connector from your cable or antenna to IN on your VCR.
- 2 Using AUDIO/VIDEO connectors, connect AUDIO and VIDEO OUT on your VCR to AUDIO and VIDEO IN on your TV (Yellow-VIDEO, White-AUDIO Left, Red-AUDIO Right)*.
- 3 Using a coaxial connector, connect OUT on your VCR to VHF/UHF on your TV.

Connecting to an S Video equipped VCR (for optimum picture quality)

- 1 Attach the coaxial connector from your cable or antenna to IN on your VCR.
- 2 Using AUDIO connectors, connect AUDIO OUT on your VCR to AUDIO IN on your TV (White-AUDIO Left, Red-AUDIO Right)*.
- 3 Using a coaxial connector, connect OUT on your VCR to VHF/UHF on your TV.
- 4 Using an S VIDEO connector, connect S VIDEO on your VCR to S VIDEO on your TV.

* If you are connecting a monaural VCR, connect only the single audio output to the left input on your TV.

Note on DVD Connection:

- For the best picture quality, connect the DVD player directly to the TV. Refer to your DVD manual for detailed connection information.

4

Disconnect all power sources before making any connections.

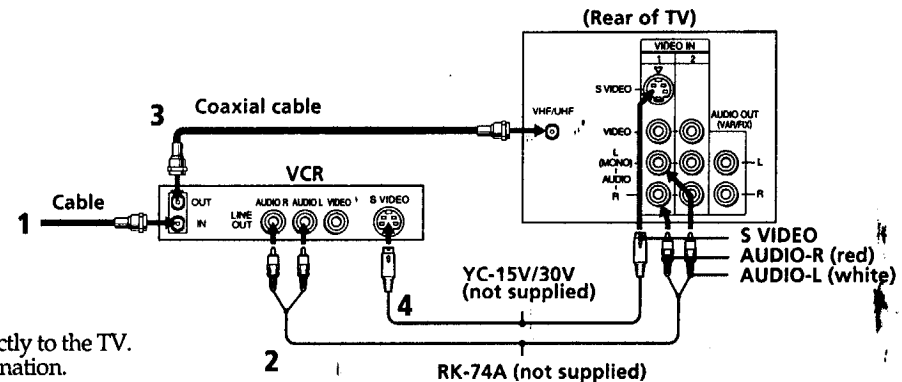
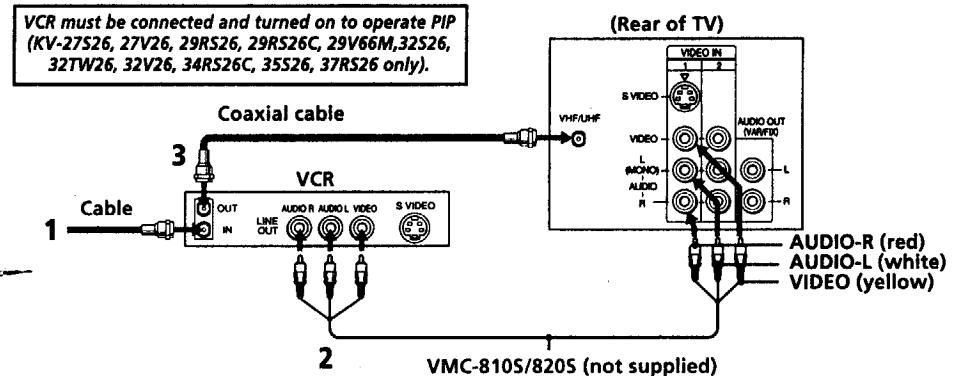

Connecting a VCR and TV with a cable box

- 1 Connect the single (input) jack of the Splitter to your incoming cable connection, and connect the other two (output) jacks (using coaxial cable) to IN on your cable box and VHF/UHF on your TV.
- 2 Using a coaxial connector, connect OUT on your cable box to IN on your VCR.
- 3 Using AUDIO/VIDEO connectors, connect AUDIO and VIDEO OUT on your VCR to AUDIO and VIDEO IN on your TV (Yellow-VIDEO, White-AUDIO Left, Red-AUDIO Right).

Connecting to an S Video equipped VCR with a cable box (for optimum picture quality)

- 1-2 Perform as described above.
- 3 Using AUDIO connectors, connect AUDIO OUT on your VCR to AUDIO IN on your TV (White-AUDIO Left, Red-AUDIO Right).
- 4 Using an S VIDEO connector, connect S VIDEO on your VCR to S VIDEO on your TV.

Note:

- To view scrambled channels through your cable box, select VIDEO 1 by pressing TV/VIDEO on the remote control.

Disconnect all power sources before making any connections.

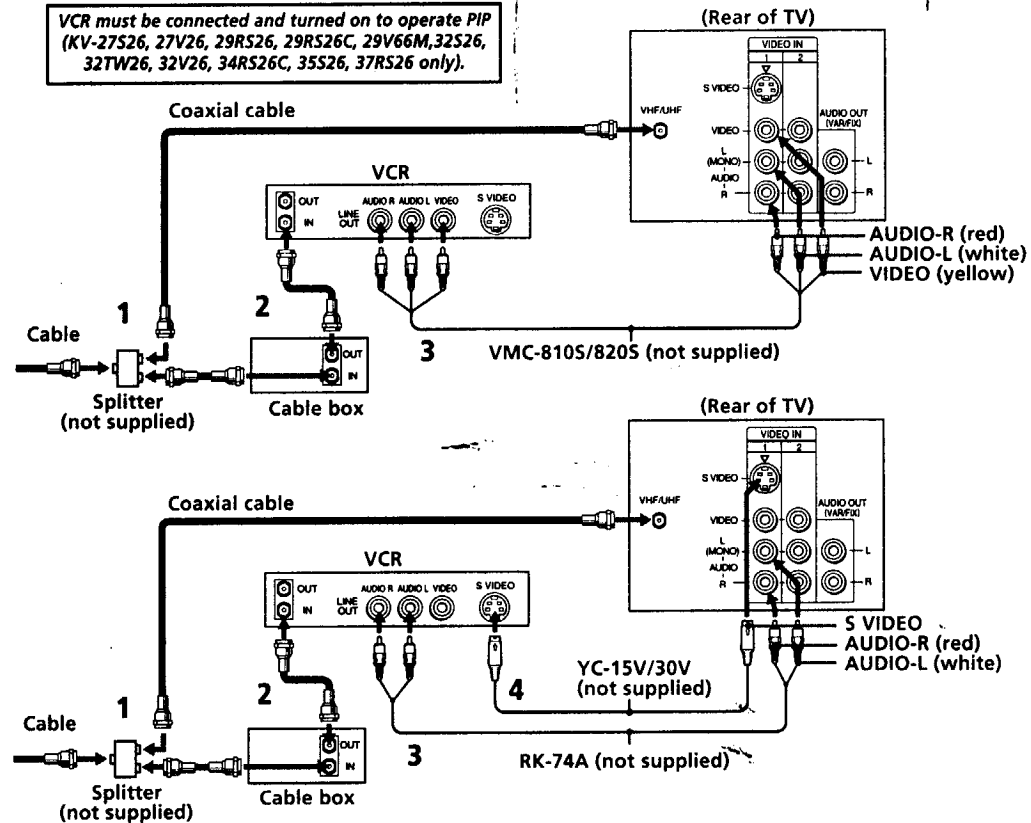

Connecting and Installing the TV (continued)

Connecting a DBS (Direct Broadcast Satellite) receiver

- 1 Connect the cable from your satellite antenna to your DBS receiver.
- 2 Attach the coaxial connector from your cable or antenna to VHF/UHF on your TV.
- 3 Using AUDIO/VIDEO connectors, connect AUDIO and VIDEO OUT on your DBS receiver to AUDIO and VIDEO IN on your TV.

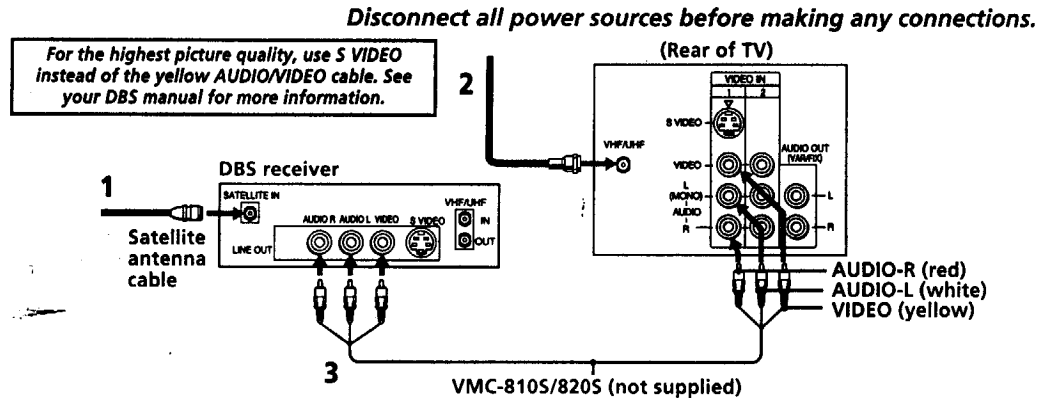

Connecting a DBS (Direct Broadcast Satellite) receiver and a VCR

- 1 Connect the cable from your satellite antenna to your DBS receiver.
- 2 Attach the coaxial connector from your cable or antenna to VHF/UHF-IN on your VCR.
- 3 Using a coaxial connector, connect VHF/UHF-OUT on your VCR to VHF/UHF on your TV.
- 4 Using AUDIO/VIDEO connectors, connect AUDIO and VIDEO OUT on your DBS receiver to AUDIO and VIDEO IN on your VCR.
- 5 Using AUDIO/VIDEO connectors, connect AUDIO and VIDEO OUT on your VCR to AUDIO and VIDEO IN on your TV.

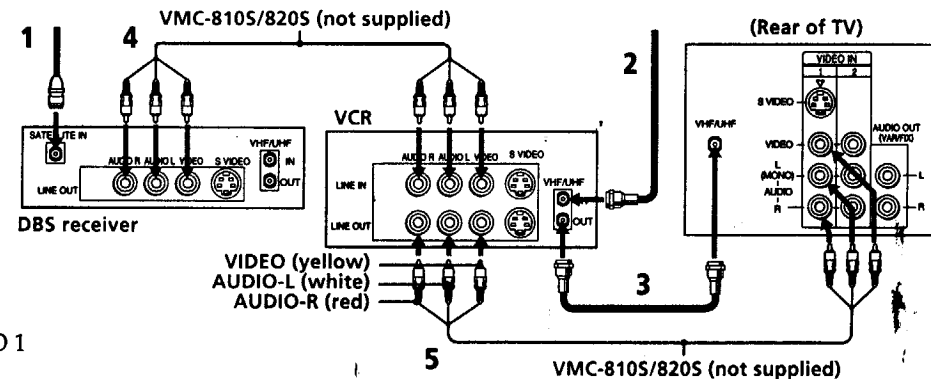

Note:

- To view input from the DBS or VCR, select VIDEO 1 by pressing TV/VIDEO on the remote control.

Connecting an audio system

For greater viewing pleasure, integrate your home stereo into the system.

- 1 Using AUDIO connectors, connect AUDIO OUT on your TV to one of the unused Line inputs (e.g. Tape-2, etc.) on your stereo (White-AUDIO Left, Red-AUDIO Right).
- 2 Set your stereo to the chosen Line input and refer to page 20 of this manual for additional audio setup instructions.

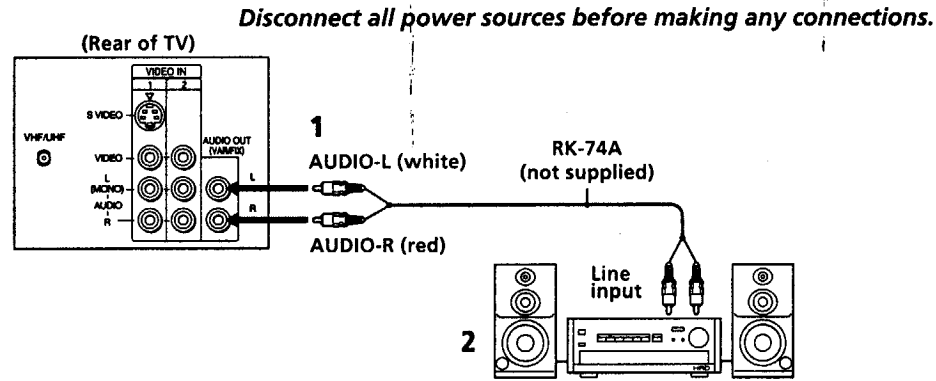

Connecting an AV receiver

- KV-27V36, 29V36C, 29V76M, 32V36, 34V36C, 35V36, 35V76, 37V36M only

For greater viewing pleasure, connect your AV receiver.

- 1 Using AUDIO/VIDEO connectors, connect VIDEO 1 IN on your TV to Monitor AUDIO and VIDEO OUT on your AV receiver.
- 2 Using AUDIO/VIDEO connectors, connect TV OUT on your TV to TV AUDIO and VIDEO IN on your AV receiver.

You may want to use CHANNEL FIX to fix your TV's input to the AV receiver (VIDEO 1).
See CHANNEL FIX, page 22.

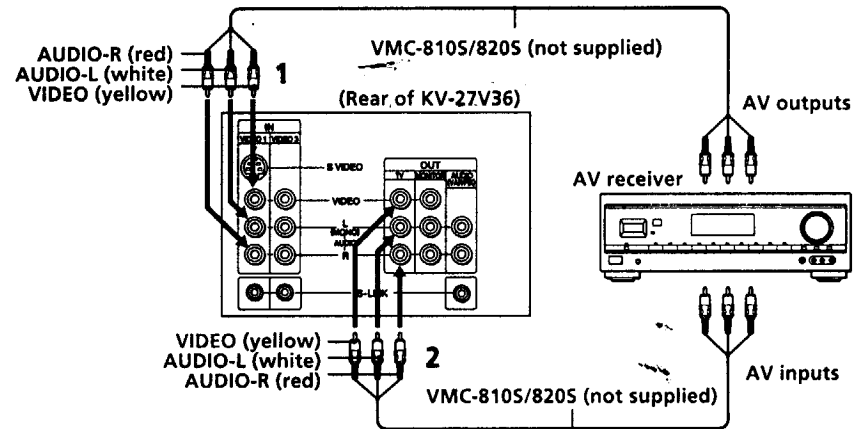

Connecting and Installing the TV (continued)

Connecting two VCRs for tape editing using MONITOR OUT

- KV-27V26, 27V36, 29V36C, 29V66M, 29V76M, 32V26, 32V36, 34V36C, 35V36, 35V76, 37V36M only

MONITOR OUT gives you the ability to use a second VCR to record a program being played by the primary VCR or to perform tape editing and dubbing.

- 1 Connect the VCR intended for playback using the setup instructions on page 4 of this manual.
- 2 Using AUDIO/VIDEO connectors, connect AUDIO and VIDEO IN on your VCR intended for recording to MONITOR AUDIO and VIDEO OUT on your TV.

Disconnect all power sources before making any connections.

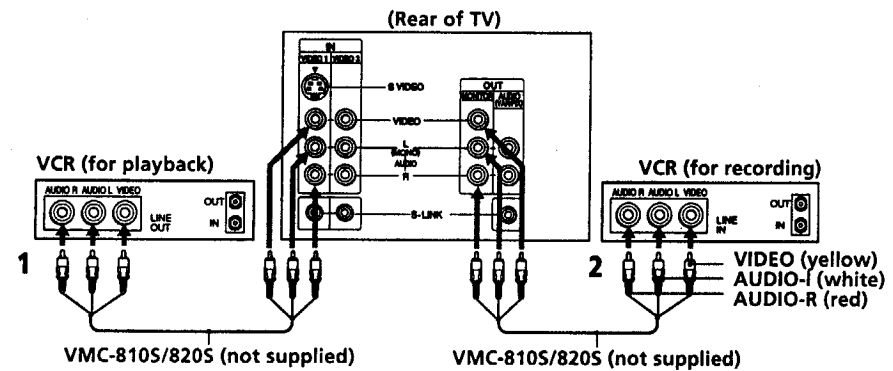

Notes:

- Do not change the input signal while editing through MONITOR OUT.
- When connecting a single VCR to the TV; if VCR LINE OUT is connected to TV VIDEO IN, *do not* connect the TV MONITOR OUT jacks to the VCR LINE INPUT (see right). Doing so will cause program interference and other viewing problems.

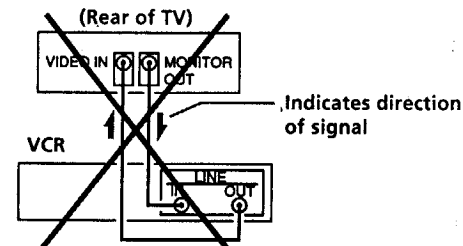

Using the S-Link function

- KV-27V26, 27V36, 29V36C, 29V66M, 29V76M, 32V26, 32V36, 34V36C, 35V36, 35V76, 37V36M only

S-Link is a Sony innovation designed to make your Sony components work together. It allows you to automatically switch the TV input mode to video when you press PLAY on your Sony S-Link VCR. It also allows you to turn the VCR and TV off at the same time with the SYSTEM OFF button.

- 1 Connect your VCR using the setup instructions on page 4 of this manual.
- 2 Using an S-Link connector, connect the S-LINK jacks on your VCR and TV. Ensure that both ends are seated firmly and that the TV S-LINK connector is in the same row as the AUDIO/VIDEO connectors.

Disconnect all power sources before making any connections.

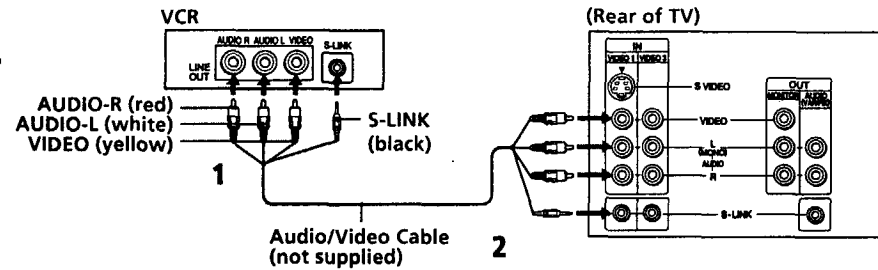

Connecting a camcorder

- KV-27V26, 27V36, 29V36C, 29V66M, 29V76M, 32V26, 32V36, 34V36C, 35V36, 35V76, 37V36M only

This connection is convenient for viewing a picture directly from your camcorder.

Using AUDIO/VIDEO connectors, connect AUDIO and VIDEO OUT on your camcorder to AUDIO and VIDEO IN on the front panel of your TV (Yellow-VIDEO, White-AUDIO Left, Red-AUDIO Right).

Note:

- If you are connecting a monoaural camcorder, connect only the single audio output to the left input on your TV.

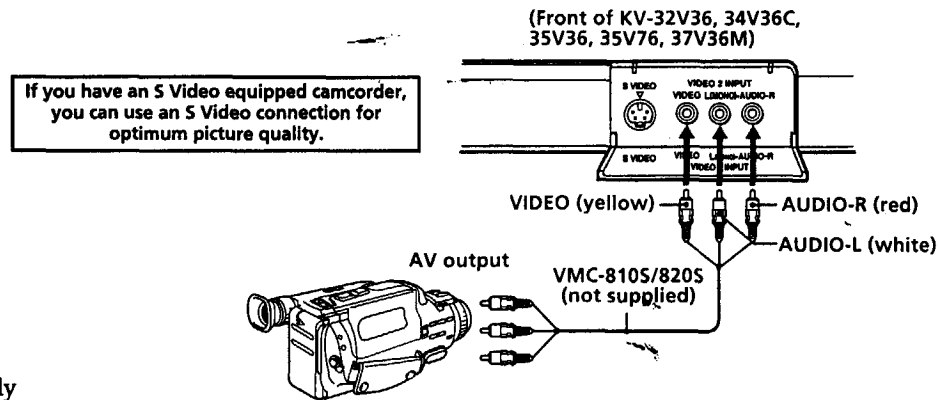

Connecting and Installing the TV (continued)





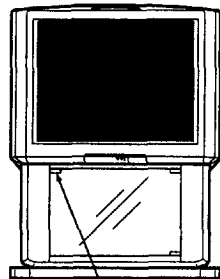

KV-32TW26 and KV-35V76 only

Follow these instructions to install the glass door and adjust the shelf.



Push here to close.
To open, push again.

Parts List

A	Bottom hinge		1
B	Top hinge		1
C	Screw 4x4		4
D	Plate pad		1
E	Plate		1
F	Metal pin		4

Note:

- Confirm that all parts are included before beginning assembly. If any parts are missing, contact your dealer.

Installing the glass door

- 1 Check that the projection of the screw through the bottom hinge **A** does not interfere with the proper installation of the hinge to the glass door, and then insert the hinge into the hole located at the bottom right side of cabinet.

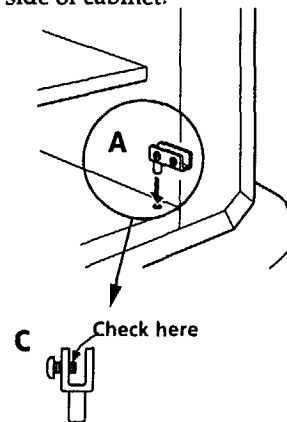

- 2 Attach the top hinge **B** to the right side of the glass door; tighten the screws snugly, but do not overtighten. Attach the plate pad **D** to the left side and push the plate **E** over the plate pad.

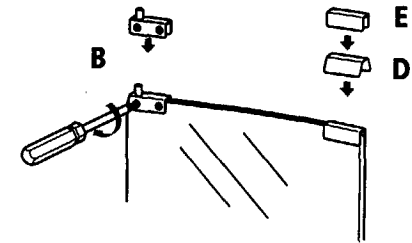

- 3** Push the top glass door hinge into the top right pushing and gently slide the glass door into the bottom hinge. Adjust the glass door until level, and tighten the hinge screws.

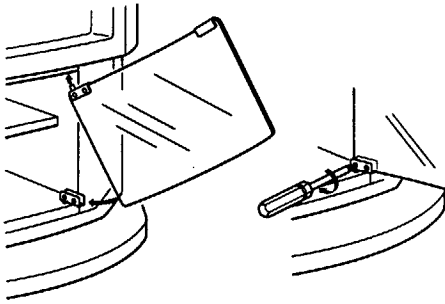

Adjusting the shelf

- 1** Press the upper part of the temporary shelf supports and remove the shelf.

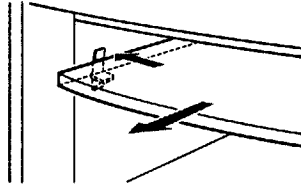

- 2** Insert the metal pin shelf supports (2 each side).

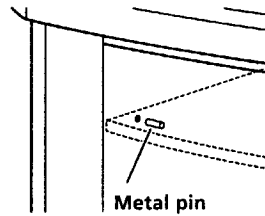

- 3** Insert the shelf, ensuring that the pin supports are seated in the grooves on the bottom side of the shelf.

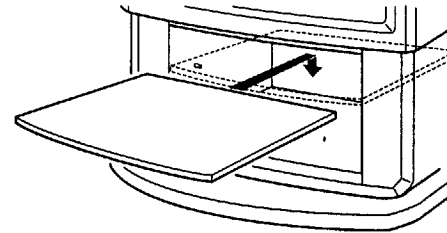

Basic Set up

Inserting batteries

Insert two size AA (R6) batteries (supplied) by matching the + and - on the batteries to the diagram inside the battery compartment.

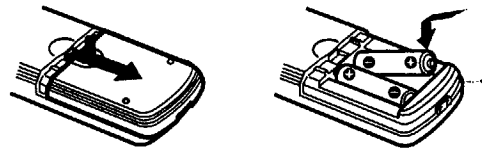

Notes:

- Remove the batteries to avoid damage from possible battery leakage whenever you anticipate that the remote control will not be used for an extended period.
- Handle the remote control with care. Avoid dropping it, getting it wet, or placing it in direct sunlight, near a heater, or where the humidity is high.
- Your remote control can be programmed to operate most video equipment. See page 24.

Using the remote control Select buttons

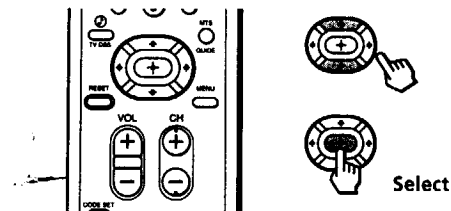

The supplied remote control has select buttons which allow for movement of the on-screen selector in four directions. Pressing on the edge of the select buttons will cause the selector to *move* in the selected direction. Pressing the center of the select buttons "⊕" will *activate* the selected item.

Adjusting sliders

When menu items present a slider (▬ or ▬), use the select buttons (⬆ or ⬇) to adjust the setting.

On Line Help/Instructions

Several menu windows will provide prompts and instructions to assist you in navigating through the different functions. *When presented, use these to supplement the instructions in this manual.*

Using your New TV

Setting up the TV automatically

The EASY SETUP GUIDE feature will allow you to set the on-screen language and set all receivable channels. The EASY SETUP GUIDE screen will appear every time you turn on the TV until you perform AUTO PROGRAM.

The EASY SETUP GUIDE feature does not apply for installations that use a cable box for all channel selection.

To set up the TV manually, refer to "Using the SET UP menu" on page 22.

Tips

- Perform this function during the day, with the antenna and/or cable properly connected, to ensure that all available channels will be broadcasting and receivable.
- After using EASY SETUP GUIDE you will still have the option of adjusting any of the system settings, like erasing channels, through the SET UP menu (page 22).
- The TV must be set to TV input to execute AUTO PROGRAM. Press ANT until the channel number appears.
- If your cable or antenna is connected to AUX, then press ANT until "AUX" appears next to the channel number. (KV-27S36, 27V36, 29V36C, 29V76M, 32S36, 32V36, 34V36C, 35S36, 35V36, 35V76, 37V36M only)

Using the buttons on the front of the TV:



For KV-27V36, 29V36C, 29V76M, 32V36, 34V36C, 35V36, 35V76 and 37V36M, the control buttons are located on the top of the TV.

- 1 Press POWER to turn on the TV. The EASY SETUP GUIDE screen appears.

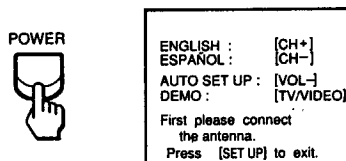

- 2 (Except Canadian models) Press CHANNEL + to select English screens or CHANNEL - to select Spanish screens.

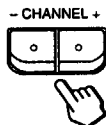

- 3 Press VOLUME - to continue or TV/VIDEO for a DEMO of functions and menus.

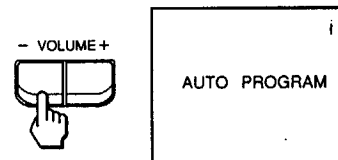

"AUTO PROGRAM" appears and the TV starts scanning and presetting channels automatically. When all the receivable channels are stored, the lowest numbered channel is displayed. If the TV receives cable TV channels, CABLE is set ON automatically.

To perform AUTO SET UP again

- Press SET UP.
- Press CHANNEL + or CHANNEL - to select a language.
- Press Volume - to restore factory settings ("CONTINUE TO AUTO PROGRAM?" will appear on the screen. Press CH+ to execute or CH- to exit).
- Press SET UP to exit.

Note:

- When you perform AUTO PROGRAM, your CHANNEL FIX, TIMER, and CHANNEL BLOCK settings will be erased.

■ ■ ■ Using your New TV (continued)

Watching the TV

All of the TV features can be accessed via the remote control. The following chart will explain the function of the buttons found on your remote control.



**REFER TO THE
ILLUSTRATION OF THE
REMOTE CONTROL ON THE
INSIDE FRONT COVER OF
THIS MANUAL AS YOU
REVIEW THIS CHART**

TV (FUNCTION)	Activates the remote control for use with the TV.
TV POWER	Turns the TV on and off. If "VIDEO" appears on the screen, press TV/VIDEO or ANT so that a channel number appears.
① - ⑨	Use for direct channel selection. Press 0-9 to select a channel (for example, to select channel 10, press 1 and 0), the channel will change after 2 seconds, or you can press ENTER for immediate selection.
CH +/-	Press to scan through the channels (+ up or - down).
VOL +/-	Press to adjust the volume (+ up or - down).
JUMP	Press to alternate or <i>jump</i> back and forth between two channels. You can only jump between the last two channels that have been selected with the 0-9 keys.
MUTING	Press to mute the sound ("MUTING" will appear on the screen). Press again or press VOL + to restore sound.
FREEZE	Press to <i>freeze</i> the window picture while in PIP mode. If you are not in PIP mode, pressing FREEZE will cause the main picture to freeze into a window picture. Great for copying down phone numbers, addresses, recipes, etc.

SLEEP	Press repeatedly until the TV displays the approximate time in minutes (30, 60, or 90) that you want the TV to remain on before shutting off automatically. Cancel by pressing until "SLEEP OFF" appears.
DISPLAY	Press repeatedly to step through available displays: Status Channel number, current time, channel caption (if set), and MTS mode (if SAP is selected) are displayed. SAP indication disappears after three seconds. XDS XDS (Extended Data Service) shows a network name, program name, program type, program length, call letters, and time of the show if the broadcaster offers this service. Caption Vision Caption Vision will be displayed on the screen if the broadcaster offers this service. (see right) To cancel the display, press DISPLAY repeatedly until "DISPLAY OFF" appears. "DISPLAY OFF" disappears after three seconds.
TV/VIDEO	Press repeatedly to step through available video inputs: TV, Video 1 and Video 2 (KV-27S26, 27S36, 29RS26, 29RS26C, 32S26, 32S36, 32TW26, 34RS26C, 35S26, 35S36, 37RS26 only) TV, Video 1, Video 2 and Video 3 (KV-27V26, 27V36, 29V36C, 29V66M, 29V76M, 32V26, 32V36, 34V36C, 35V36, 35V76, 37V36M only)
ANT	Press to change the VHF/UHF input to the AUX input (KV-27S36, 27V36, 29V36C, 29V76M, 32S36, 32V36, 34V36C, 35S36, 35V36, 35V76, 37V36M only) For detailed connection information, see "Cable box and cable" or "Cable and antenna" on page 3.
SYSTEM OFF	KV-27V26, 27V36, 29V36C, 29V66M, 29V76M, 32V26, 32V36, 34V36C, 35V36, 35V76, 37V36M only. Press to turn off the TV and all other equipment connected with S-Link and return the TV input to either antenna or AUX, whichever was last used.
MTS/GUIDE	Press this button to cycle through the Multi-channel TV Sound (MTS) options. (page 20)

CAPTION VISION

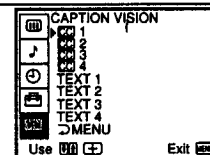

Some programs are broadcast with Caption Vision. To display Caption Vision, select CC1, CC2, CC3, CC4, TEXT1, TEXT2, TEXT3, or TEXT4 from the menu, then press DISPLAY until Caption Vision is displayed.

CC1, CC2, CC3, or CC4 shows you a caption, that is, a printed version of the dialogue or sound effects of a program. (The mode should be set to CC1 for most programs) TEXT1, TEXT2, TEXT3, or TEXT4 shows you text, that is, information presented using either half or the whole screen. It is not usually related to the program.

Notes:

- Poor reception of TV programs can cause errors in Caption Vision and XDS. Captions may appear with a white box or other errors instead of intended text.
- XDS, Caption Vision, and the status display cannot be used at the same time.

Using your New TV (continued)

Watching two programs at one time — PIP

The Picture-in-Picture (PIP) feature allows you to view two channels simultaneously, one in the full size “main” picture and one in a smaller “window” picture. This means that two separate tuners must be available to provide the two signals.

Certain models (KV-27S26, 27V26, 29RS26, 29RS26C, 29V66M, 32S26, 32TW26, 34RS26C, 35S26, 37RS26 only) are equipped with a single tuner. This simply means that a VCR must be connected and turned on for PIP to operate.

Tip

To ensure a correct single tuner PIP connection (KV-27S26, 27V26, 29RS26, 29RS26C, 29V66M, 32S26, 32TW26, 34RS26C, 35S26, 37RS26 only), make sure the following list of simple connections is complete before using PIP:

- A cable or antenna is connected to the VCR
- The VCR is connected to your TV
- The VCR is turned on

(for detailed connection information, see page 3-5)



Note:

- You must press TV (FUNCTION) before you can control PIP with the yellow labeled buttons.

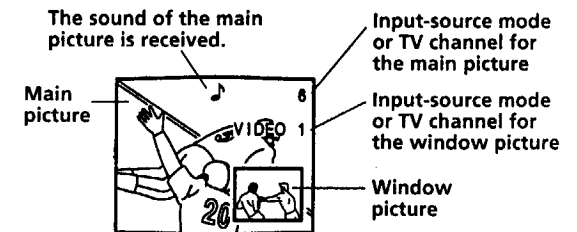

REFER TO THE ILLUSTRATION OF THE REMOTE CONTROL ON THE INSIDE FRONT COVER OF THIS MANUAL AS YOU REVIEW THIS CHART



PIP 	Press once to display the window picture (1/9 size). Press again to reduce the size of the window picture (1/16 size). Press a third time to remove the window picture.
TV/VIDEO 	Press repeatedly to step through available video inputs: TV, Video 1, Video 2, and Video 3 (KV-27V26, 27V36, 29V36C, 29V66M, 29V76M, 32V26, 32V36, 34V36C, 35V36, 35V76, 37V36M only) <i>If you use one of the connections from page 4, your PIP input source is the VCR. If you use one of the connections from page 5, your PIP input source is a VCR or cable box.</i>
AUDIO 	Press to alternate sound between the main picture and the window picture. A ♪ will appear for a few seconds to indicate which picture is receiving sound.

<p>TV/VTR + ○ CH - ○</p>	<p>Press to change the TV channel in the window picture (+ to increase the channel number and – to decrease). For models KV-27S26, 27V26, 29RS26, 29RS26C, 29V66M, 32S26, 32TW26, 34RS26C, 35S26, and 37RS26, if you are watching the video input in the window picture, you must press VTR (FUNCTION), then use the main CH +/- buttons to change channels.</p>
<p>POSITION ◻</p>	<p>Press to move the location of the window picture (counterclockwise) around the main picture.</p>
<p>FREEZE ◀</p>	<p>Press to freeze the window picture. Great for copying down phone numbers, addresses, recipes, etc. If a window picture is displayed, then it will be frozen. If only the main picture is displayed, then it will be frozen and displayed as a window picture. <i>Press FREEZE again to restore the previous screen(s).</i></p>
<p>SWAP ▶</p>	<p>Press to switch the audio and video of the main picture and the window picture. Each time you press SWAP, the picture and sound of the two will be SWAPPED. <i>The channels being received through the AUX jack cannot be displayed as a window picture (KV-27S36, 27V36, 29V36C, 29V76M, 32S36, 32V36, 34V36C, 35S36, 35V36, 35V76, 37RS26, 37V36M only).</i></p>

Adjusting your SET UP (menus)

Learning menu selection

Use the MENU button to access a menu and use the Select buttons to alter settings. Use the following example to learn how to modify settings.

- 1 Press the MENU button.

The main menu appears.

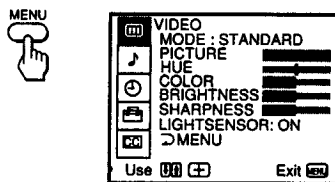

- 2 Press the select buttons (↑ or ↓) to highlight the desired menu and press (+) to activate it.

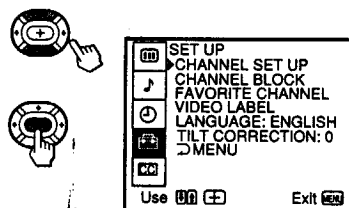

- 3 Press the select buttons (↑ or ↓) to select the desired option.

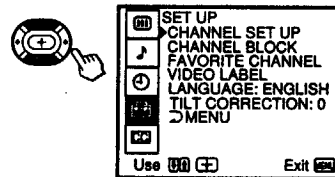

- 4 Press (+).

Options for your selection will be displayed.

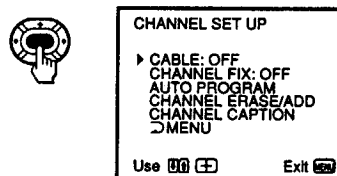

- 5 Make your selection and press (+) to activate it.

The previous screen will reappear.

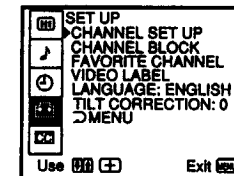

When you are done with changes to the selected menu, choose MENU to return to the main menu. Once you have completed all menu corrections, press MENU on the remote control to exit the menu screens.

Note:

- Pressing MENU on the remote control will allow you to exit from the menus.

Using the VIDEO menu

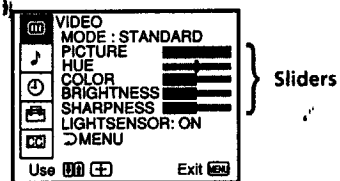

For detailed information on using the remote to modify menu settings, refer to "Learning menu selection" on page 18.

To select the VIDEO menu:

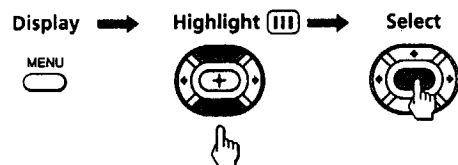

To restore the factory settings

Press RESET on the remote control while the VIDEO menu is displayed.

MODE <i>Customized picture viewing</i>	STANDARD: Select to receive a standard picture. MOVIE: Select to receive a finely detailed picture. SPORTS: Select to receive a vivid, bright picture.
PICTURE <i>Picture Adjustment</i>	Adjust slider left (cursor down) to decrease picture contrast and soften the color. Adjust slider right (cursor up) to increase picture contrast and create more vivid color.
HUE <i>Picture Adjustment</i>	Adjust slider left (cursor down) to decrease the green tones. Adjust slider right (cursor up) to increase the green tones.
COLOR <i>Picture Adjustment</i>	Adjust slider left (cursor down) to decrease color intensity. Adjust slider right (cursor up) to increase color intensity.
BRIGHTNESS <i>Picture Adjustment</i>	Adjust slider left (cursor down) to darken the picture. Adjust slider right (cursor up) to brighten the picture.
SHARPNESS <i>Picture Adjustment</i>	Adjust slider left (cursor down) to soften the picture. Adjust slider right (cursor up) to sharpen the picture.
LIGHTSENSOR <i>Picture Adjustment</i>	(KV-27V26, 27V36, 29V36C, 29V66M, 29V76M, 32V26, 32V36, 34V36C, 35V36, 35V76, 37V36M only) ON: TV automatically adjusts the brightness of the picture according to the brightness of the room. OFF: Brightness remains at preset value.

Adjusting your SET UP (menus) (continued)

Using the AUDIO menu

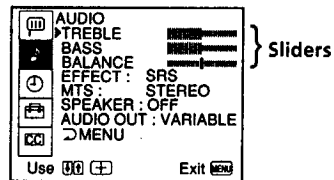

For detailed information on using the remote to modify menu settings, refer to "Learning menu selection" on page 18.

To select the AUDIO menu:

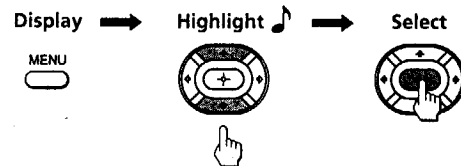

To restore the factory settings

Press RESET on the remote control while the AUDIO menu is displayed.

Tip

Press for direct selection of an EFFECT setting.

TREBLE <i>Sound Adjustment</i>	Adjust slider left (cursor down) to decrease higher pitched sounds. Adjust slider right (cursor up) to increase higher pitched sounds.
BASS <i>Sound Adjustment</i>	Adjust slider left (cursor down) to decrease low pitched sounds. Adjust slider right (cursor up) to increase low pitched sounds.
BALANCE <i>Sound Adjustment</i>	Adjust slider left (cursor down) to emphasize left speaker volume. Adjust slider right (cursor up) to emphasize right speaker volume.
EFFECT <i>Customize sound effect based on the program's audio type.</i>	SURROUND: Simulates theater quality sound (only for stereo programs). (KV-27S26, 27S36, 29RS26, 29RS26C, 32S26, 32S36, 32TW26, 34RS26C, 35S26, 35S36, 37RS26 only) SRS: Produces a dynamic three dimensional sound for stereo or encoded audio signals. (KV-27V26, 27V36, 29V36C, 29V66M, 29V76M, 32V26, 32V36, 34V36C, 35V36, 35V76, 37V36M only) SIMULATED: Adds a surround-like effect to mono programs. (KV-27V26, 27V36, 29V36C, 29V66M, 29V76M, 32V26, 32V36, 34V36C, 35V36, 35V76, 37V36M only)
MTS <i>Enjoy stereo, bilingual and mono programs.</i>	STEREO: Select for stereo reception when viewing a program broadcast in stereo. SAP: Select to listen to bilingual broadcast. (non-SAP programs will be muted when this feature is selected) MONO: Select for mono reception. (use to reduce noise during stereo broadcasts) Quick MTS access: Press MTS on your remote to cycle through the MTS options as follows: (STEREO \blacktriangleright SAP \blacktriangleright MONO \blacktriangleright STEREO)
SPEAKER <i>Custom selection of audio output source.</i>	ON: Select to listen to the sound from the TV speakers and a separate stereo system. OFF: Select to turn off the TV speakers and listen to the TV's sound only through external audio system speakers.
AUDIO OUT <i>Easy control of volume adjustments.</i>	AUDIO OUT can only be set when speakers are set to OFF. VARIABLE: Sound output varies according to the TV settings. Volume, Bass, Treble, and Balance are adjusted through the TV. Useful when you want to use your remote to control the output of a separate audio system. FIXED: Sound output is held at a fixed level. Volume, Bass, Treble, and Balance are fixed to the factory settings. Volume adjustments are made through your stereo.

⌚ Using the TIMER menu

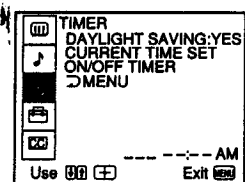

After setting the clock you can use the timer to turn the TV on and off.

For detailed information on using the remote to modify menu settings, refer to "Learning menu selection" on page 18.

To select the TIMER ⌚ menu:

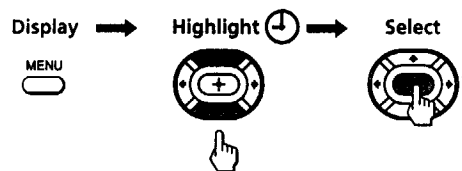

Tip 💡

Set daylight saving time before setting the clock. Any loss of power will cause these settings to be erased.

<p>DAYLIGHT SAVING <i>Automatically adjusts the time.</i></p>	<p>Spring: Select YES to compensate for Daylight Saving Time. The current time automatically moves one hour ahead. Fall: Select NO at the end of Daylight Saving Time. The current time moves back one hour.</p>
<p>CURRENT TIME SET <i>Necessary for the TIMER.</i></p>	<p>CURRENT TIME SET window will appear.</p> <ol style="list-style-type: none"> 1 Press ↑ or ↓ on the select buttons until the current day (MON-SUN) is displayed. Press (+) to select. 2 Press ↑ or ↓ on the select buttons until the current hour (01-12) and AM/PM is displayed. Press (+) to select. 3 Press ↑ or ↓ on the select buttons until the current minute (00-59) is displayed. 4 Press (+). <p>The Clock has now started. Press MENU to exit.</p>
<p>ON/OFF TIMER <i>Wake up or scheduled viewing.</i></p>	<p>ON/OFF TIMER window will appear.</p> <ol style="list-style-type: none"> 1 Press ↑ or ↓ on the select buttons until the desired day (MON-SUN) or range of days (EVERY Sun-Sat or EVERY Mon-Fri) is displayed. Press (+) to select. 2 Indicate the time (hours then minutes) that you want the TV to turn on by pressing ↑ or ↓ and then (+). 3 Set the time duration (maximum of 6 hours) by pressing ↑ or ↓ and then (+). <p>TO CANCEL THE TIMER FUNCTION, PRESS RESET.</p> <ol style="list-style-type: none"> 4 Press ↑ or ↓ on the select buttons to select the desired channel. Press (+) to select. <p>The timer is now set. The TIMER indicator on your TV will be lit. Press MENU to exit. When you perform AUTO PROGRAM, all TIMER settings will be erased.</p>

Adjusting your SET UP (menus) (continued)

Using the SET UP menu



For detailed information on using the remote to modify menu settings, refer to "Learning menu selection" on page 18.

To select the SET UP menu:

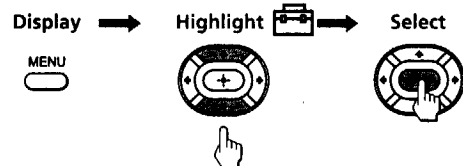

If any menu items are "grayed out", press the ANT button on your remote so that a channel number appears.

Favorite channel feature is not available for the AUX input.

CHANNEL SET UP

Basic set up options for viewing

With the CHANNEL SET UP window open:

- 1 Use \uparrow or \downarrow to select the feature you want to change.
- 2 Press \oplus to access the feature.

CABLE: Select ON if your TV is connected to a cable system. (AUTO SET UP will set CABLE to ON automatically when it programs the TV)

CHANNEL FIX: Use this feature to set the TV's input to one of the following options:

2-6: Choose when the cable box is connected to the VHF/UHF input and you do not want to switch to AUX mode. Once this setting is made you will not be able to use the "TV function" CH+/- to change channels; instead, use the "Cable function" CH +/-.

AUX 2-6: Choose when a cable box is connected to AUX and a cable or antenna is connected to ANT. You can alternate between the two inputs by pressing ANT on the remote control. (KV-27S36, 27V36, 29V36C, 29V76M, 32S36, 32V36, 34V36C, 35S36, 35V36, 35V76, 37V36M only)

VIDEO 1: Choose when you have connected video equipment (e.g. AV receiver) and you want TV input fixed to it. You will only be able to switch between video sources.

TIMER and CHANNEL BLOCK settings are erased when CHANNEL FIX is set.

AUTO PROGRAM: Instructs the TV to automatically program all receivable channels.

CHANNEL ERASE/ADD: With the CHANNEL ERASE/ADD window open:

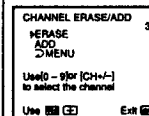

- 1 Place the cursor next to ERASE or ADD.
- 2 Select the desired channel using CH+/-, or by selecting with the 0-9 buttons and pressing ENTER.
- 3 Press \oplus to activate.

CHANNEL CAPTION: With the CHANNEL CAPTION window open:

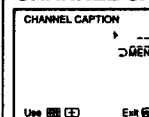

- 1 Press \oplus and then \uparrow or \downarrow on the select buttons to select the desired channel, and press \oplus again.
- 2 Press \uparrow or \downarrow on the select buttons to display the first letter or number of the caption and press \oplus to select it. (Repeat until all four digits are selected)
- 3 Press \oplus to activate. *To erase a Caption, press RESET.*

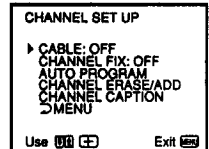

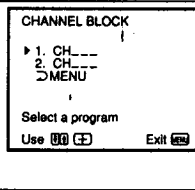
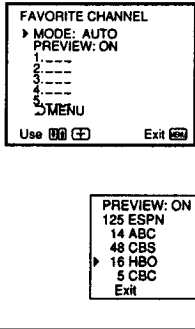
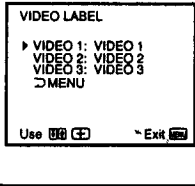
<p>CHANNEL BLOCK Prevent child access to certain channels.</p>	<p>You will be able to block two channels. With the CHANNEL BLOCK window open:</p> <ol style="list-style-type: none"> 1 Select 1 or 2 and press (+). 2 Press ▲ or ▼ on the select buttons to display the channel you want to block. 3 Press (+) to activate. <p>When you select the blocked channel, "BLOCKED" will appear on the screen. Caption Visior, XDS, and output from the selected channel will also be blocked. To erase your CHANNEL BLOCK settings, press RESET while in the CHANNEL BLOCK window. When you perform AUTO PROGRAM, your CHANNEL BLOCK settings will be erased.</p>	
<p>FAVORITE CHANNEL Quick access to favorite channels</p>	<p>Setting FAVORITE CHANNEL: With the FAVORITE CHANNEL window open:</p> <ol style="list-style-type: none"> 1 Press (+) and then ▲ or ▼ on the select buttons to select AUTO or MANUAL, and press (+) again. (Selecting AUTO will cause the last five channels that you chose with the remote control 0-9 buttons to be selected) 2 Press ▲ or ▼ on the select buttons to select 1, 2, 3, 4, or 5 and press (+). 3 Press ▲ or ▼ on the select buttons to select the desired channel and press (+). 4 For KV-27S36, 27V36, 29V36C, 29V76M, 32S36, 32V36, 34V36C, 35S36, 35V36, 35V76, 37V36M only, you can preview your favorite channels in the window picture, to do so, set PREVIEW DISPLAY to ON. <p>Using FAVORITE CHANNEL:</p> <ol style="list-style-type: none"> 1 Press (+), and your FAVORITE CHANNEL options appear. 2 Press ▲ or ▼ to select the channel you want to watch, and press (+). 3 For models KV-27S36, 27V36, 29V36C, 29V76M, 32S36, 32V36, 34V36C, 35S36, 35V36, 35V76, 37V36M only, if PREVIEW is turned on, then a window picture will display your favorite channels as you cycle through the options. 	
<p>VIDEO LABEL Easy recognition of connected equipment (e.g. DBS, VHS, etc.).</p>	<p>This feature allows you to label each input mode so that you can easily identify the connected equipment (e.g. you can label VIDEO 1 IN as VHS).</p> <ol style="list-style-type: none"> 1 Press ▲ or ▼ on the select buttons to select the input mode you want to label and press (+). 2 Press ▲ or ▼ to select the label and press (+). <p>VIDEO LABEL Options: Video 1: VHS, 8mm, BETA, LD, GAME, DBS, DVD, WEB, RECEIVER Video 2/3: VHS, 8mm, BETA, LD, GAME, DBS, DVD, WEB</p>	
<p>LANGUAGE</p>	<p>(Except Canadian models) Select from available languages to cause all menus to appear in your language of choice.</p>	
<p>TILT CORRECTION Adjust your picture.</p>	<p>Use this feature to correct any tilt of the picture KV-35S26, 35S36, 35V36, 35V76, 37RS26, 37V36M only. Press ▲ or ▼ on the select buttons to select a correction between +5 and -5 and press (+).</p>	

Operating video equipment

Setting the manufacturer's code

You can use the supplied remote control to operate Sony or non-Sony video equipment that has an infrared sensor.

- 1 Press CODE SET.
- 2 Press VTR (FUNCTION).
- 3 Use the 0-9 buttons to key in the manufacturer's code number from the following chart.
- 4 Press ENTER.

VCR manufacturer code numbers

Manufacturer	Code
Sony	301, 302, 303
Aiwa	338, 344
Admiral (M. Wards)	327
Audio Dynamic	314, 337
Bell & Howell (M. Wards)	330, 343
Broksonic	319, 317
Canon	309, 308
Citizen	332
Craig	315, 302, 332
Criterion	315
Curtis Mathis	304, 338, 309

Daewoo	341, 312, 309
DBX	314, 336, 337
Dimensia	304
Emerson	319, 320, 316, 317, 318, 341
Fisher	330, 334, 335, 333
Funai	338
General Electric	329, 304, 309
Go Video	322
Goldstar	332
Hitachi	306, 304, 305, 338
Instant Replay	309, 308
JC Penney	309, 305, 304, 330, 314, 336, 337
JVC	314, 336, 337
Kenwood	314, 336, 332, 337
LXI (Sears)	332, 305, 333, 334, 330, 335, 338
Magnavox	308, 309, 310
Marantz	314, 336, 337
Marta	332
Memorex	309, 335
Minolta	305, 304
Mitsubishi/MGA	323, 324, 325, 326
Multitech	325, 338, 321
NEC	314, 336, 337
Olympic	309, 308
Optimus	327
Panasonic	308, 309, 306, 307
Pentax	305, 304
Philco	308, 309
Philips	308, 309, 310
Pioneer	308
Quasar	308, 309, 306
RCA/PROSCAN	304, 305, 308, 309, 311, 312, 313, 310, 329
Realistic	309, 330, 328, 335, 324, 338
Sansui	311

Singer	315
Samsung	322, 313, 321
Sanyo	330, 335
Scott	312, 313, 321, 335, 323, 324, 325, 326
Sharp	327, 328
Shintom	315
Signature 2000 (M. Wards)	338, 327
Sylvania	308, 309, 338, 310
Symphonic	338
SV2000	338
Tashiro	332
Tatung	314, 336, 337
Teac	314, 336, 338, 337
Technics	309, 308
Toshiba	312, 311
Wards	327, 328, 335, 331, 332
XR-1000	315
Yamaha	330, 314, 336, 337
Zenith	331

MDP manufacturer code numbers

Manufacturer	Code
Sony	701
Kenwood	707
Magnavox	703
Marantz	702
Mitsubishi	702
Panasonic	704, 710
Philips	703

Pioneer	702
RCA	702, 709
Sanyo	706
Sharp	705
Yamaha	703, 708

Tips 

- In some rare cases, you may not be able to operate your non-Sony video equipment with the supplied remote control. In this case, please use the equipment's own remote control.
- The code numbers for Sony equipment are assigned at the factory as follows:

VHS VCR	301 (preset code for the supplied remote control)
8 mm VCR	302
Beta, ED Beta VCRs	303

- When you remove the batteries, the code number may revert to the factory setting.

Operating a VCR	Buttons on the remote control
To turn on or off	Press VTR (POWER).
To select a channel directly	Press the 0 – 9 buttons.
To change channels	Press CH +/-.
To record	Press ▶▶ while pressing ● . First release ▶▶ , then release ● .
To play	Press ▶ .
To stop	Press ■ .
To fast forward	Press ▶▶▶ .
To rewind the tape	Press ◀◀ .
To pause	Press . To resume normal playback, press again.
To search the picture forward or backward	Press ▶▶▶ or ◀◀◀ during playback. To resume normal playback, release the button.
To change input mode	Press TV/VTR.

Operating an MDP	Buttons on the remote control
To turn on or off	Press VTR (POWER).
To play	Press the ▶ .
To stop	Press ■ .
To pause	Press . To resume normal playback, press again.
To search the picture forward or backward	Keep pressing ▶▶▶ or ◀◀◀ during playback. To resume normal playback, release the button.
To search the chapter forward or backward	Press CH +/-.

■■■ Operating a cable box or DBS receiver

Programming the remote

You can program the supplied remote control to operate a cable box or DBS receiver.

- 1 Press CODE SET.
- 2 Press DBS/CABLE (FUNCTION).
- 3 Use the 0-9 buttons to key in the manufacturer's code number from the following chart.
- 4 Press ENTER.

To operate the TV

Press TV (FUNCTION). Then use the TV control buttons to control the TV.

For more details on operating the cable box or DBS receiver

Refer to the operating instructions that come with the equipment.

If the remote control doesn't work

- First, try repeating the setup procedures using the other codes listed for your equipment.

Tips

- *If more than one code number is listed, try entering them one by one until you come to the correct code for your equipment.*
- *If you enter a new code number, the code number you previously entered at that setting is erased.*
- *In some rare cases, you may not be able to operate your equipment with the supplied remote control. In this case, use the equipment's own remote control unit.*
- *Whenever you remove the batteries — to replace them, for example — if too much time is taken, the code numbers may revert to the factory setting and must be reset.*

Manufacturer code numbers (cable box)

Manufacturer	Code number
Hamlin/Regal	222, 223, 224, 225, 226
Jerrold/G. I.	201, 202, 203, 204, 205, 206, 207, 208, 218
Oak	227, 228, 229
Panasonic	219, 220, 221
Pioneer	214, 215
Scientific Atlanta	209, 210, 211
Tocom	216, 217
Zenith	212, 213

Manufacturer code numbers (DBS receiver)

Manufacturer	Code number
Sony	801 (preset code for remote control)
General Electric	802
RCA/PROSCAN	802

Troubleshooting

Troubleshooting

Cannot Operate Single-Tuner PIP (KV-27S26, 27V26, 29RS26, 29RS26C, 29V66M, 32S26, 32TW26, 34RS26C, 35S26, 37RS26 only)

- Check that cable is connected to the VCR, and the VCR is turned on.
- Check that the VCR is connected to the TV.

No picture (screen not lit), no sound

- Make sure the power cord is plugged in.
- Operate with the buttons on the TV and the remote control.
- Insert the batteries in the remote control with the correct polarity.
- Replace the batteries with new ones if they are weak.
- Check to see if the TV/VIDEO setting is correct: when watching TV, set to TV, and when watching video tapes, set to VIDEO1, 2, or 3.
- Try another channel. *It could be station trouble.*
- Perform AUTO SET UP again using the SET UP button to return to the factory preset condition. (page 13)

Poor or no picture (screen lit), good sound

- Adjust PICTURE in the VIDEO menu. (page 19)
- Adjust BRIGHTNESS in the VIDEO menu. (page 19)
- Check antenna/cable connections.
- Perform AUTO SET UP again using the SET UP button to return to the factory preset condition. (page 13)
- Remove objects from the front of TV.
- Check the LIGHTSENSOR setting in the VIDEO menu. (page 19)

Good picture, no sound

- Press MUTING so that "MUTING" disappears from the screen. (page 14)
- Check the MTS setting in the AUDIO menu. (page 20)
- Make sure SPEAKER is set to ON in the AUDIO menu. (page 20)
- Perform AUTO SET UP again using the SET UP button to return to the factory preset condition. (page 13)

No color

- Adjust the COLOR in the VIDEO menu. (page 19)

- Black and white programs cannot be seen in color.
- Perform AUTO SET UP again using the SET UP button to return to the factory preset condition. (page 13)

Only snow and noise appear on the screen

- Check the CABLE setting in the SET UP menu. (page 22)
- Check the antenna/cable connections.
- Make sure the channel is broadcasting programs.
- Press ANT to change the input mode. (page 15)

Dotted lines or stripes

- Adjust the antenna.
- Move the TV away from noise sources such as cars, neon signs, or hair-dryers.

Double images or ghosts

- Use a highly directional outdoor antenna or a cable (when the problem is caused by reflections from nearby mountains or tall buildings).

Cannot operate menu

- If the item you want to choose appears in gray, you cannot select it. Press TV/VIDEO correctly.

■■■ Troubleshooting (continued)

Cannot receive upper channels (UHF) when using an antenna

- Make sure CABLE is OFF in the SET UP menu. (page 22)
- Use AUTO PROGRAM to add receivable channels that are not presently in TV memory. (page 22)

Cannot receive any channels when using cable TV

- Make sure CABLE is ON in the SET UP menu. (page 22)
- Use AUTO PROGRAM to add receivable channels that are not presently in TV memory. (page 22)

Remote control does not operate

- Batteries could be weak. Replace the batteries.
- Press TV (FUNCTION) when operating your TV.
- Make sure the TV's power cord is connected securely to the wall outlet.
- Locate the TV at least 3-4 feet away from fluorescent lights.
- Check the S-Link connection. (page 4,5)

Cannot gain enough volume when using a cable box

- Increase the volume at the cable box. Then press TV (FUNCTION) and adjust the TV's volume.

TV is fixed to one channel

- Try turning CHANNEL FIX off. (see page 22)
- Use AUTO PROGRAM to add receivable channels that are not presently in the TV memory. (page 22)
- To reset the TV: First, turn the TV on. Then, while pressing the RESET key on the remote control, press the POWER Key on the TV. The TV will turn itself off, then back on. When the TV turns on again, all settings will be reset, and the EASY SETUP GUIDE will appear.

TV malfunctions when using the S-Link function (KV-27V26, 27V36, 29V36C, 29V66M, 29V76M, 32V26, 32V36, 34V36C, 35V36, 35V76, 37V36M only)

- Make sure the TV's power cord is connected securely to the wall outlet.
- Check the S-Link connection. (page 4,5)

■■■ Specifications

Supplied accessories

Remote control RM-Y136A (1)
(KV-27S26, 27S36, 29RS26, 29RS26C, 32S26, 32S36, 32TW26, 34RS26C, 35S26, 35S36, 37RS26 only)

Remote control RM-Y137A (1)
(KV-27V26, 27V36, 29V36C, 29V66M, 29V76M, 32V26, 32V36, 34V36C, 35V36, 35V76, 37V36M only)

Batteries (2) size AA (R6)

Optional accessories

Connecting cables
VMC-810S/820S, VMC-720M, YC-15V/30V, RK-74A

TV Stand SU-27A
(KV-27S26, 27S36, 27V26, 27V36, 29RS26, 29RS26C, 29V36C, 29V66M, 29V76M (except Canadian models))

TV Stand SU-32A
(KV-32S26, 32S36, 32V26, 32V36, 34RS26C, 34V36C (except Canadian models))

TV Stand SU-35A
(KV-35V36, 35S26, 35S36, 37RS26, 37V36M (except Canadian models))

U/V mixer EAC-66

Specifications (continued)

	KV-	27S26	27S36	27V26	27V36	29RS26	29RS26C	29V36C	29V66M	29V76M
Power requirements		120 V, 60 Hz	120 V, 60 Hz	120 V, 60 Hz	120 V, 60 Hz	120 V, 60 Hz	220V, 50/60Hz	220V, 50/60Hz	120 V, 60 Hz	120 V, 60 Hz
Number of inputs/outputs										
Video ¹⁾		2	2	3	3	2	2	3	3	3
S Video ²⁾		1	1	1	1	1	1	1	1	1
Audio ³⁾		2	2	3	3	2	2	3	3	3
Audio out ⁴⁾		1	1	1	1	1	1	1	1	1
Monitor out ¹⁾		-	-	1	1	-	-	1	1	1
TV out ¹⁾		-	-	-	1	-	-	1	-	1
S-Link		-	-	.	.	-	-	.	.	.
Speaker output (W)		5W x 2	5W x 2	5W x 2	10W x 2	5W x 2	5W x 2	10W x 2	5W x 2	10W x 2
Power consumption (W)										
In use (Max.)		165W	180W	180W	195W	165W	165W	195W	180W	195W
In standby		9W	9W	9W	13W	9W	9W	13W	9W	13W
Dimensions (W/H/D) (mm) (in.)		660.4 x 602.5 x 521.2 mm 26 x 23 3/4 x 20 1/8 in.	660.4 x 602.5 x 521.2 mm 26 x 23 3/4 x 20 1/8 in.	690 x 575.4 x 503.4 mm 27 1/4 x 22 3/4 x 19 7/8 in.	690 x 575.4 x 503.4 mm 27 1/4 x 22 3/4 x 19 7/8 in.	660.4 x 602.5 x 521.2 mm 26 x 23 3/4 x 20 1/8 in.	660.4 x 602.5 x 521.2 mm 26 x 23 3/4 x 20 1/8 in.	690 x 575.4 x 503.4 mm 27 1/4 x 22 3/4 x 19 7/8 in.	690 x 575.4 x 503.4 mm 27 1/4 x 22 3/4 x 19 7/8 in.	690 x 575.4 x 503.4 mm 27 1/4 x 22 3/4 x 19 7/8 in.
Mass (kg) (lbs)		40.6 kg 89 lbs 8 oz	42 kg 92 lbs 10 oz	43 kg 94 lbs 13 oz	43 kg 94 lbs 13 oz	40.6 kg 89 lbs 8 oz	40.6 kg 89 lbs 8 oz	43 kg 94 lbs 13 oz	43 kg 94 lbs 13 oz	43 kg 94 lbs 13 oz

Television system

American TV standard

Channel coverage

VHF: 2-13/UHF: 14-69/CATV: 1-125

Picture tube

Hi Black Trinitron® tube

Screen size

27-inch picture measured diagonally

Antenna

75 ohm external terminal for VHF/UHF

- ¹⁾ 1 Vp-p, 75 ohms unbalanced, sync negative
- ²⁾ Y: 1 Vp-p, 75 ohms unbalanced, sync negative
C: 0.286 Vp-p (Burst signal), 75 ohms
- ³⁾ 500 mVrms (100% modulation), Impedance: 47 kilohms
- ⁴⁾ More than 408 mVrms at the maximum volume setting (variable)
More than 408 mVrms (fix)
Impedance: 5 kilohms

● SRS (SOUND RETRIEVAL SYSTEM)

The ● SRS (SOUND RETRIEVAL SYSTEM) is manufactured by Sony Corporation under license from SRS Labs, Inc. It is covered by U.S. Patent No. 4,748,669. Other U.S. and foreign patents pending.

The word 'SRS' and the SRS symbol (●) are registered trademarks of SRS Labs, Inc.

Specifications (continued)

	KV- 32S26	32S36	32TW26	32V26	32V36	34RS26C	34V36C	35S26	35S36	35V36	35V76	37RS26	37V36M
Power requirements	120 V, 60 Hz	120 V, 60 Hz	120 V, 60 Hz	120 V, 60 Hz	120 V, 60 Hz	220 V, 50/60 Hz	220 V, 50/60 Hz	120 V, 60 Hz	120 V, 60 Hz	120 V, 60 Hz	120 V, 60 Hz	120 V, 60 Hz	120 V, 60 Hz
Number of inputs/outputs													
Video ¹⁾	2	2	2	3	3	2	3	2	2	3	3	2	3
S Video ²⁾	1	1	1	1	2	1	2	1	1	2	2	1	2
Audio ³⁾	2	2	2	3	3	2	3	2	2	3	3	2	3
Audio out ⁴⁾	1	1	1	1	1	1	1	1	1	1	1	1	1
Monitor out ¹⁾	-	-	-	1	1	-	1	-	-	1	1	-	1
TV out ¹⁾	-	-	-	-	1	-	1	-	-	1	1	-	1
S-Link	-	-	-	-	-	-	-	-	-	-	-	-	-
Speaker output (W)	5W x 2	5W x 2	5W x 2	5W x 2	10W x 2	5W x 2	10W x 2	5W x 2	5W x 2	5W x 2	10W x 2	5W x 2	5W x 2
Power consumption (W)													
When in use (Max.)	185W	190W	185W	190W	210W, 2.75 A	185W	210W	215W, 2.80 A	215W, 2.80 A	215W, 2.80 A	225W	215W, 2.80 A	215W, 2.80 A
In standby	9W	9W	9W	9W	13W	9W	13W	13W	13W	13W	13W	13W	13W
Dimensions (W/H/D)													
(mm)	781 x 712.1	781 x 712.1	942 x 1133.1	821 x 675.3	821 x 675.3	781 x 712.1	821 x 675.3	870 x 761	870 x 761	920 x 730.8	920 x 1207	870 x 761	920 x 730.8
(in.)	x 582.5 mm 30 3/4 x 28 1/8 x 23 in.	x 582.5 mm 30 3/4 x 28 1/8 x 23 in.	x 661.5 mm 37 1/8 x 44 3/8 x 26 1/8 in.	x 587 mm 33 1/2 x 27 3/8 x 24 in.	x 587 mm 33 1/2 x 27 3/8 x 24 in.	x 582.5 mm 30 3/4 x 28 1/8 x 23 in.	x 587 mm 33 1/2 x 27 3/8 x 24 in.	x 653 mm 34 1/4 x 30 x 25 1/8 in.	x 653 mm 34 1/4 x 30 x 25 1/8 in.	x 641.8 mm 37 3/8 x 29 7/8 x 26 1/4 in.	x 713 mm 37 3/8 x 49 3/8 x 28 1/8 in.	x 653 mm 34 1/4 x 30 x 25 1/8 in.	x 641.8 mm 37 3/8 x 29 7/8 x 26 1/4 in.
Mass (kg)	64.3 kg	66 kg	108.9 kg	70 kg	70 kg	64.3 kg	70 kg	83 kg	83 kg	90 kg	130 kg	83 kg	90 kg
(lbs)	141 lbs 12 oz	145 lbs 9 oz	240 lbs	154 lbs 6 oz	154 lbs 6 oz	141 lbs 12 oz	154 lbs 6 oz	182 lbs 9.6 oz	182 lbs 9.6 oz	198 lbs 7 oz	279 lbs 6 oz	182 lbs 9.6 oz	198 lbs 7 oz

Television system

American TV standard

Channel coverage

VHF: 2-13/UHF: 14-69/CATV: 1-125

Picture tube

Hi Black Trinitron® tube

Antenna

75 ohm external terminal for VHF/UHF

Screen size

32-inch picture measured diagonally (KV-32S26,

32S36, 32TW26, 32V26, 32V36, 34V36C)

35-inch picture measured diagonally (KV-35S26,

35S36, 35V36, 35V76, 37RS26, 37V36M)

¹⁾ 1 Vp-p, 75 ohms unbalanced, sync negative

²⁾ Y: 1 Vp-p, 75 ohms unbalanced, sync negative

C: 0.286 Vp-p (Burst signal), 75 ohms

³⁾ 500 mVrms (100% modulation), Impedance: 47 kilohms



⁴⁾ More than 408 mVrms at the maximum volume setting (variable)

More than 408 mVrms (fix)
Impedance: 5 kilohms

Design and specifications are subject to change without notice.

Index

A		Caption Vision 15	Editing using monitor out 8
Adjusting your SET UP 18	CATV cable 3	EFFECT	
ANT 15	Coaxial cable 2, 4, 5	SIMULATED 20	
Antenna cable 3	CH +/- 14	SRS 20	
Antenna connector 2	CHANNEL ERASE/ADD 22	Surround 20	
AUDIO button 16	CHANNEL BLOCK 23	F	
AUDIO menu operations	CHANNEL CAPTION 22	Factory settings 19, 20	
AUDIO OUT 20	CHANNEL FIX 22	FAVORITE CHANNEL 23	
BALANCE 20	COLOR 19	FAVORITE CHANNEL W/PREVIEW 23	
BASS 20	Connecting TV to	Features table 1	
EFFECT 20	antenna 3	FREEZE button 14, 17	
MTS 20	audio system 7	G	
SPEAKER 20	AV receiver 7	Glass door installation 10	
TREBLE 20	cable 3	Adjusting shelf 11	
AUDIO OUT	cable box and cable 3	Parts list 10	
FIXED 20	camcorder 9	H	
VARIABLE 20	DBS receiver 6	Hook Ups 2	
Audio Video Cable 2	DBS receiver and VCR 6	HUE 19	
AUTO PROGRAM 22	two VCRs 8	I, J, K	
AUTO SET UP 22	VCR 4	Input-source mode 16	
AUX Hookup 3, 15	CURRENT TIME SET 21	JUMP button 14	
B	D	L	
BALANCE 20	DAYLIGHT SAVING 21	Language selection 13, 23	
BASS 20	DBS receiver operation 26	Learning menus	
Battery installation 12	DISPLAY	AUDIO 20	
BRIGHTNESS 19	Caption vision 15	SET UP 22	
C	Status 15	TIMER 21	
CABLE 22	XDS 15	VIDEO 19	
Cable box 3, 5	E	LIGHTSENSOR™ 13	
operation 26	Easy Setup Guide 13		

M, N			
MDP operation	24	SWAP	17
Menu selection	18	TV/VIDEO	16
Mode		TV/VTR CH +	16
MOVIE	19	Programming the remote	26
SPORTS	19	R	
STANDARD	19	Remote control	14
Monitor out	8	Function buttons	14, 15
Mono	20	Graphic Illustration	(inside cover)
MTS		S	
MAIN	20	SAP	20
SAP	20	S-Link cable	2
MONO	20	S-Link connector	9
MUTING button	14	S-Link function	9
O		S Video cable	2
On Line Help	12	Safety	1
ON/OFF TIMER	21	Select buttons	12
Other video equipment	24	Adjusting sliders	12
Operating video equipment	24	SET UP menu 	22
P, Q		AUTO PROGRAM	22
Picture-in-Picture (PIP)		CABLE	22
Main picture	16	CHANNEL ERASE/ADD	22
Window picture	16	CHANNEL CAPTION	22
PIP connections (single tuner)	16	CHANNEL BLOCK	23
PIP operations		FAVORITE CHANNEL	23
AUDIO	16	Setting up TV	13
CH+/-	17	SHARPNESS	19
FREEZE	16	SLEEP button	15
PIP	16	SPEAKER	
POSITION	17	ON	20
		OFF	20
		Specifications	28, 29, 30
		Splitter	5
		SWAP button	17
		T, U	
		TILT CORRECTION	23
		TIMER menu operations 	
		CURRENT TIME SET	21
		DAYLIGHT SAVING	21
		ON/OFF TIMER	21
		TREBLE	20
		Troubleshooting	27, 28
		TV (FUNCTION) button	14
		TV POWER button	14
		TV/VIDEO button	15
		V, W, X, Y, Z	
		VCR	4, 5, 8
		VCR manufacturer code numbers	24
		VCR operation	25
		VIDEO LABEL	23
		VIDEO menu operations 	
		BRIGHTNESS	19
		COLOR	19
		HUE	19
		LIGHTSENSOR	19
		MODE	19
		PICTURE	19
		SHARPNESS	19
		VOL +/-	14
		VTR	24
		XDS	15

