

TOSHIBA

Color Television

OWNER'S MANUAL

CF27H40

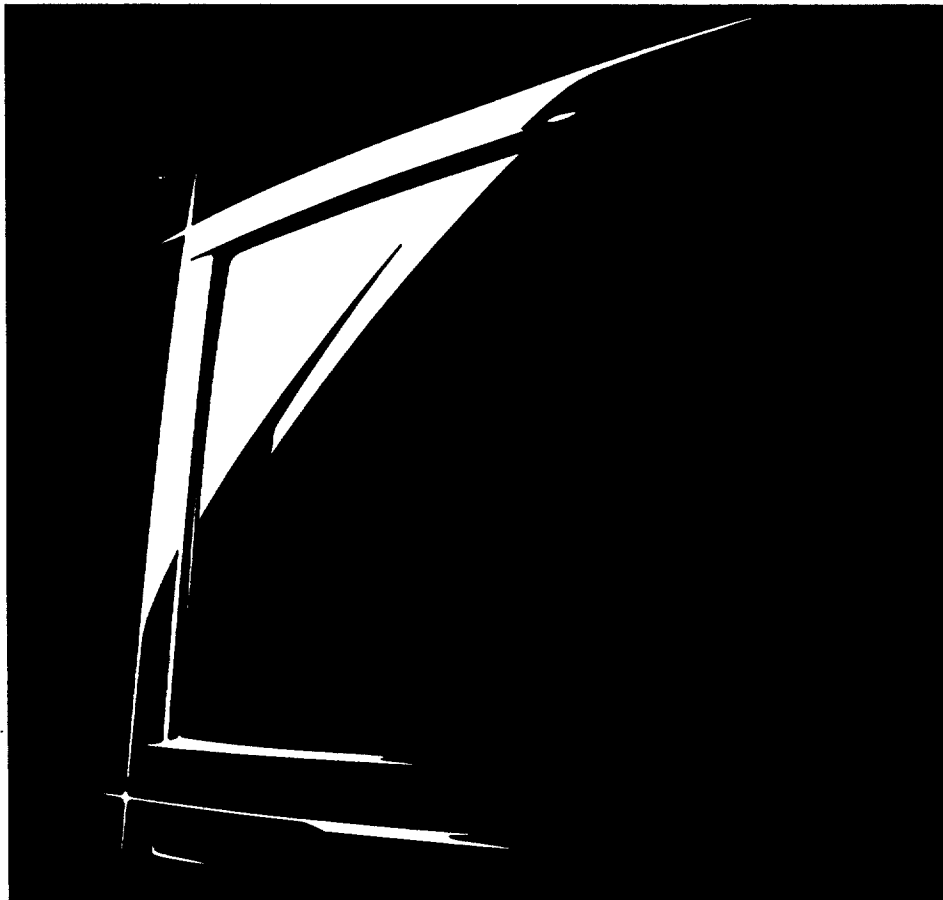

SET UP

PREPARATION

BASIC OPERATION

ADVANCED
OPERATION

EQUIPMENT
CONNECTIONS

REFERENCE
SECTION

Dear Customer

Congratulations! You have purchased one of the finest Color TV's on the market!

This manual will help you use the many exciting and useful features to make your TV viewing more enjoyable than ever before.

Before operating your TV set, please read all these safety and operating instructions completely and then retain for future reference.

Customer's Record

You will find the model number and serial number on the back of your TV set.

Record these numbers in the spaces provided below. Refer to them whenever you call upon your TOSHIBA dealer regarding this product.

Model Number _____

Serial Number _____

Safety Precautions

WARNING:

TO REDUCE THE RISK OF FIRE OR ELECTRIC SHOCK, DO NOT EXPOSE THIS APPLIANCE TO RAIN OR MOISTURE.

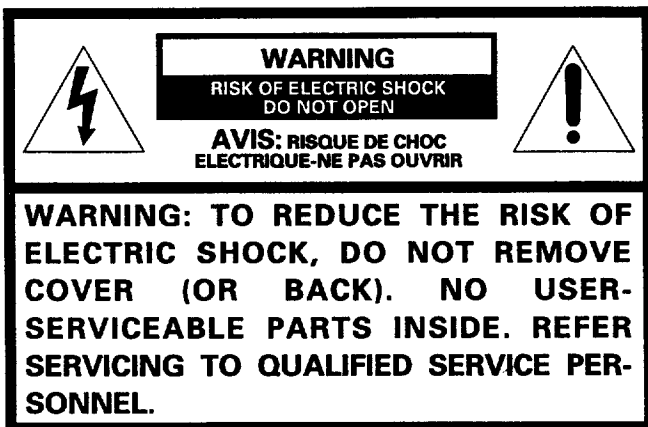

The lightning symbol in the triangle tells you that the voltage inside this product may be strong enough to cause an electric shock. **DO NOT TRY TO SERVICE THIS PRODUCT YOURSELF.**



The exclamation point in the triangle tells you that important operating and maintenance instructions follow this symbol.

CAUTIONS:

TO PREVENT ELECTRIC SHOCK, DO NOT USE THIS POLARIZED PLUG WITH AN EXTENSION CORD RECEPTACLE OR OTHER OUTLET UNLESS THE PRONGS CAN BE FULLY INSERTED INTO THE OUTLET TO PREVENT ANY EXPOSURE OF THE PRONGS ON THE POLARIZED PLUG.

ATTENTION:

POUR PRÉVENIR LES CHOCS ÉLECTRIQUES, NE PAS UTILISER CETTE FICHE POLARISÉE AVEC UN PROLONGATEUR, UNE PRISE DE COURANT OU UNE AUTRE SORTIE DE COURANT, SAUF SI LES LAMES PEUVENT ÊTRE INSÉRÉS À FOND SANS EN LAISSER AUCUNE PARTIE À DÉCOUVERT.

Avoid displaying stationary images on your TV screen for extended periods of time. Stationary patterns generated by computer displays, video games, stock market reports, etc. can become permanently engrained on the picture tube. This damage is not protected by your warranty as it is the result of misuse. Should you wish to use your TOSHIBA Television to display still images, it is always advisable to reduce brightness and contrast settings. Never leave a computer or video game display unattended.

NOTE TO CATV SYSTEM INSTALLER IN THE USA:

This reminder is provided to call the CATV system installer's attention to Article 820-40 of the NEC that provides guidelines for proper grounding and, in particular, specifies that the cable ground shall be connected to the grounding system of the building, as close to the point of cable entry as practical.

Table of Contents

Set Up

Installing Your TV Set	3
Antenna/Cable TV Connection	4

Preparation

Location of Controls (TV Set)	5
Location of Controls (Remote Control)	6
Before Using the Remote Control	7
Using the Remote with VCR or Cable TV	
Converter	8
Programming the Remote Control	9
Menu Function (General Instructions)	12
Programming Channel Memory	13

Basic Operation

Watching TV Programs	15
Convenient Remote Functions	16
Setting the Off-Timer (Sleep Timer)	17

Adjusting the Picture	18
Adjusting the Sound	19

Advanced Operation

Selecting Stereo/SAP Broadcasts	20
Locking Channels	22
Programming Your Favorite Channels	24
Operating Closed Captioning Feature	25
Changing On-Screen Display Language	26

Equipment Connections

Connecting Video Equipment	27
----------------------------------	----

Reference Section

Cleaning and Care	28
Specifications	28
Before Calling Service Personnel	29
Limited United States Warranty	30

Installing Your TV Set

Where to install

Place the TV on the floor or on a sturdy platform. The mounting surface should be flat and steady.

Lighting

Do not place the TV in a room where direct lighting strikes the screen. Use soft and indirect lighting.

Air circulation

Place the TV far enough from the walls to allow proper ventilation. This will prevent the TV from overheating and avoid possible damage to the TV. Avoid dusty places too.

Power supply

Plug into an electrical outlet with standard household power (120 volt AC, 60Hz). Do not change the plug's safety prong. See the right column.

WARNING : TO AVOID PERSONAL INJURY

- Do not stand or climb on the TV.
- Do not put a VCR or any heavy object on top of the TV.

CAUTION :

As a safety feature, the plug has one prong wider than the other. It will fit only one way into a standard electrical outlet. If the plug will not fit into the outlet, try turning it around. If the plug will not fit either way, the outlet is probably old and non-standard.

You will need to have a new outlet installed by an electrician.

DO NOT CHANGE THE SAFETY FEATURE OF THE PLUG.

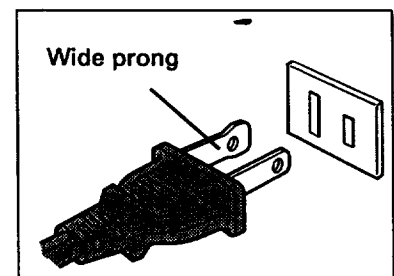

Antenna/Cable TV Connection

You can use either an indoor or outdoor antenna to receive VHF and/or UHF channels. Channels 2 - 13 are VHF channels, and channels 14 - 69 are UHF channels. We recommend using an outdoor antenna for better picture quality. You can receive Cable TV by connecting a cable supplied by your local cable company.

To connect an antenna or Cable without a decoder box

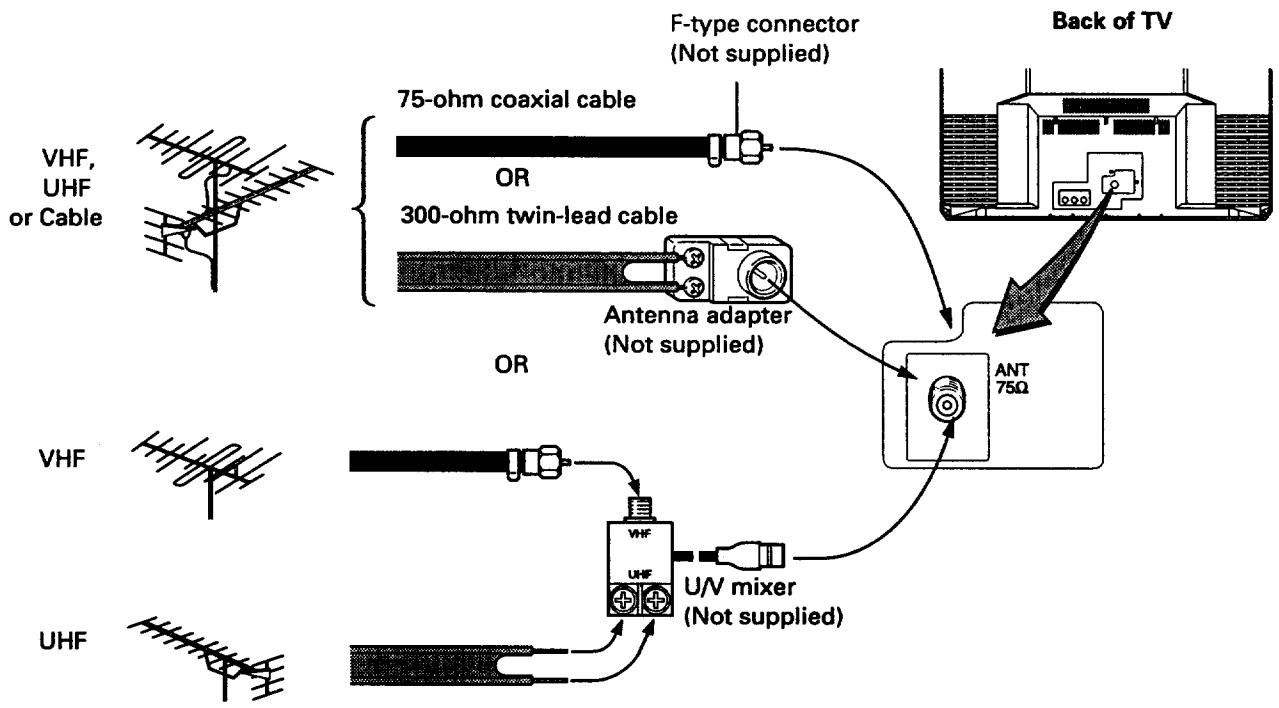

To connect a Cable with a decoder box

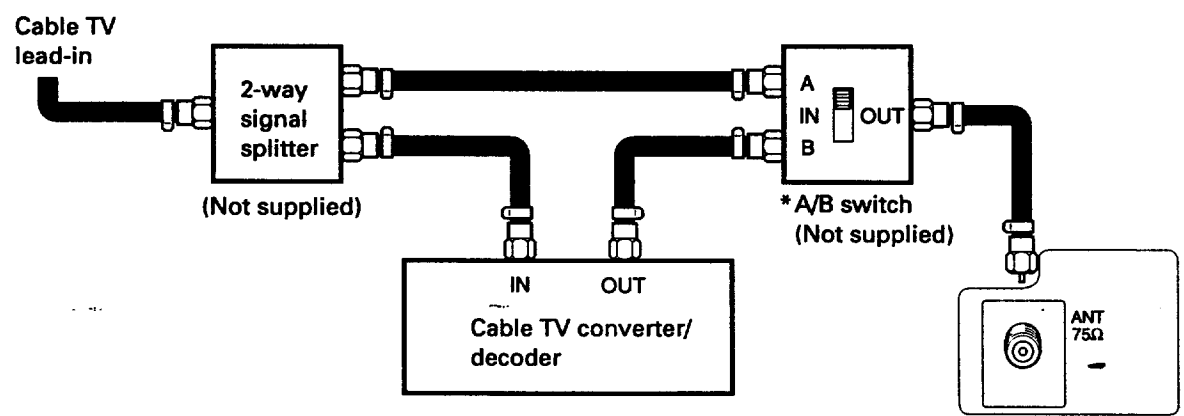

- Notes:**
- *"A" position on the A/B switch allows you to select unscrambled channels using the TV's channel keys.
 - "B" position allows you to select scrambled channels via the converter/decoder box using the converter's channel keys. Place your TV on channel 3 or 4 to match the converter's output channel.
 - If you use a VCR, connect its antenna in/out between the decoder box and A/B switch.

Location of Controls (TV Set)

For specific use of each control, consult the corresponding page numbers in brackets.

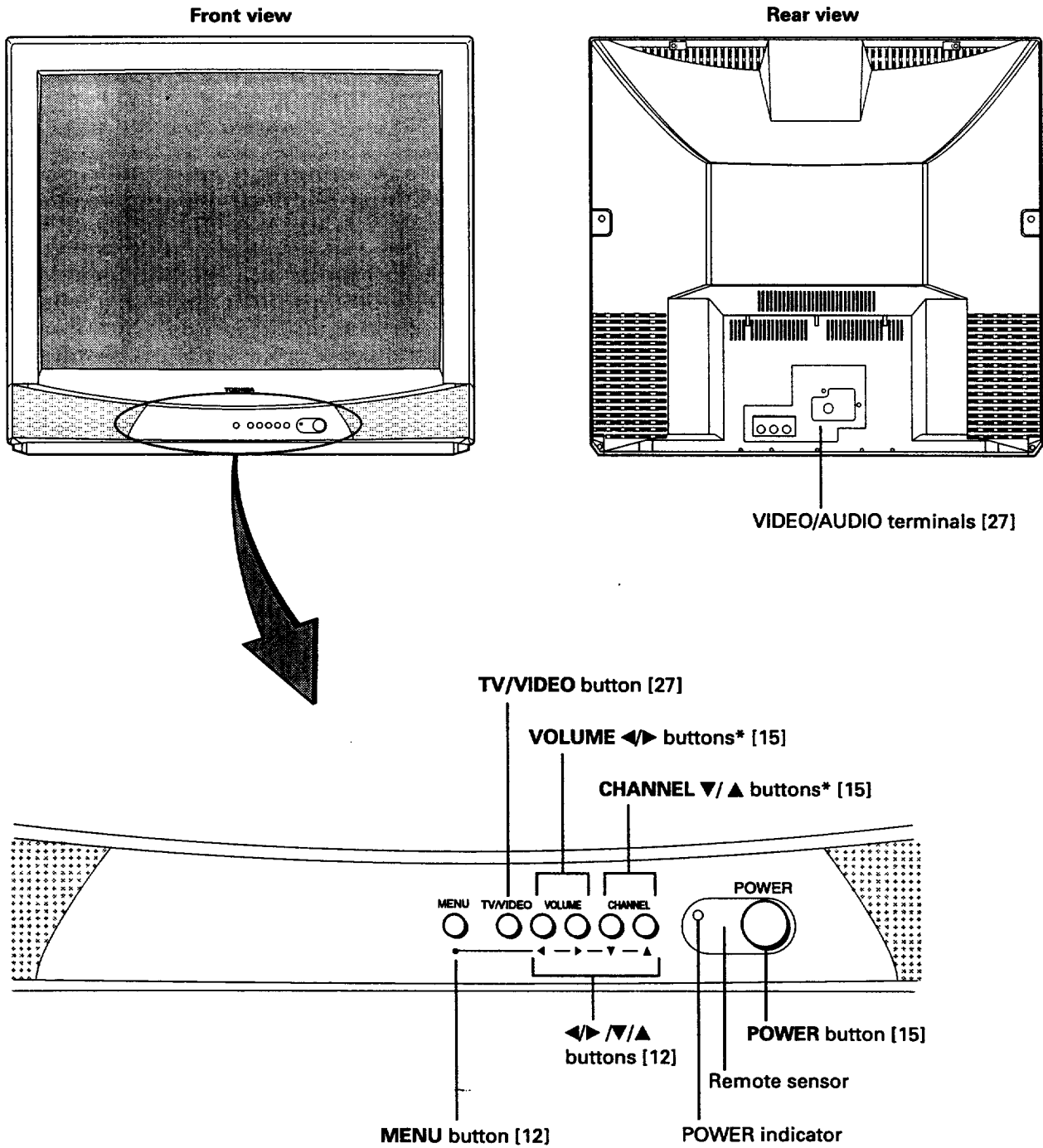

* Dual function buttons

SET UP

PREPARATION

Antenna/Cable TV Connection
Location of Controls (TV Set)

Location of Controls (Remote Control)

Only the buttons that are used to operate the TV set are described here.
For details on the use of each control, refer to pages in brackets.

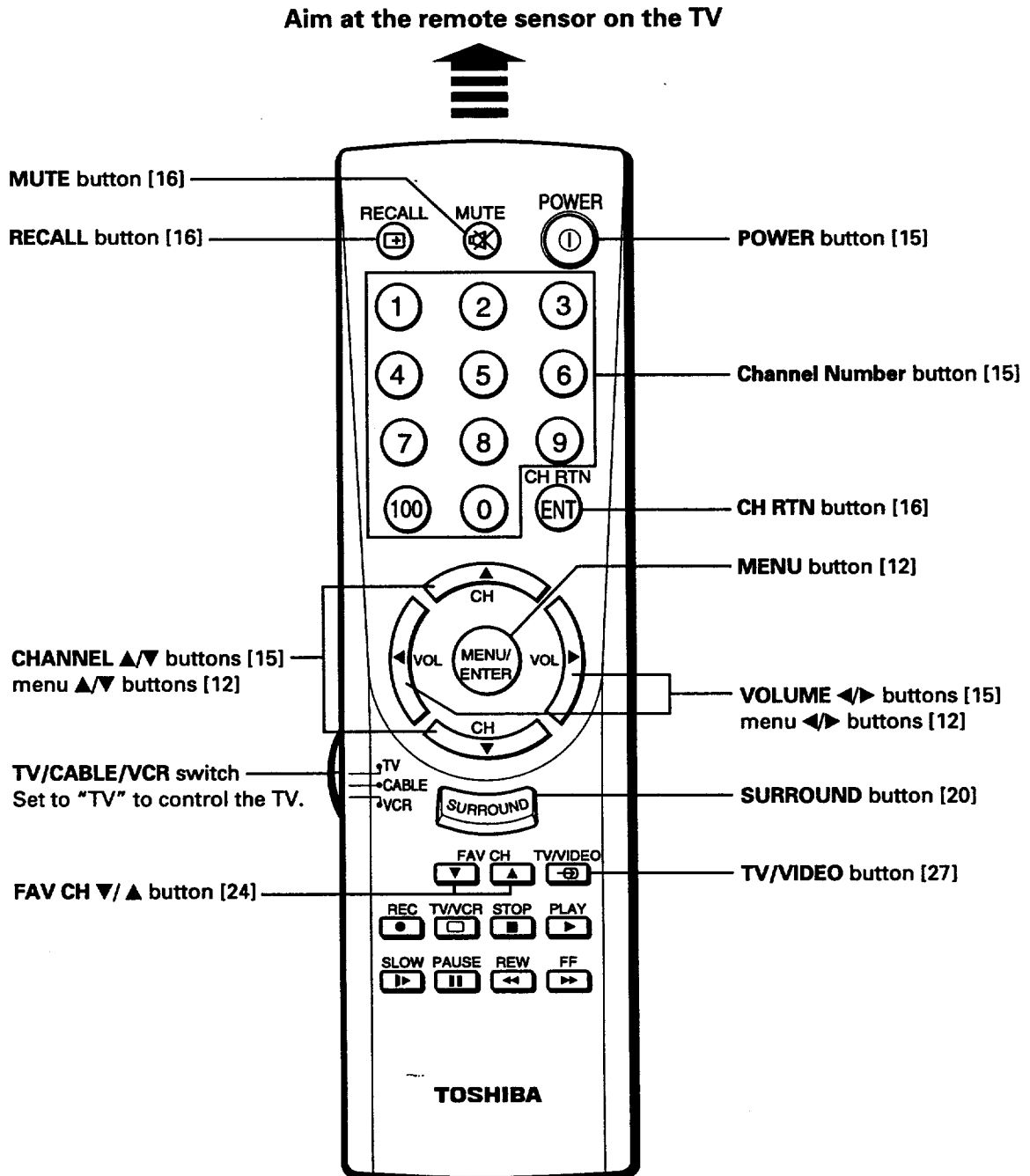

Before Using the Remote Control

Introductions

With this Remote Control, you can operate your TV and most models of remote-controlled VCR's and Cable TV converters even if they are different brands. However, this Remote Control must first be programmed to control other brands of VCR's and/or Converters. If you will be using your TV set with a TOSHIBA VCR, your Remote has already been preprogrammed for you.

- Before attempting to operate your Remote Control, install the batteries according to the section "To install batteries" shown below.
- For more detailed instructions, see the section "Programming the Remote Control" on page 9.

Notes:

- After installing new batteries, the Remote Control will set itself to the codes for TOSHIBA's TV and VCR. If you are using the Remote Control to operate equipment that uses different codes, it will have to be reprogrammed for those codes.
- This Remote Control may have functions not available on the original remote controller.
- These functions may or may not operate your VCR or Cable TV Converter. Refer to the owner's manuals supplied with the equipment to see which functions are available.
- The remote controller supplied with your VCR or cable TV converter may have keys not duplicated on this Remote Control. If these functions are desired, the original remote controller will have to be used.

To install batteries

- 1 Place the Remote Control with the face down. Press down on the ridged area of the battery cover and slide it off.

Press and slide to remove.

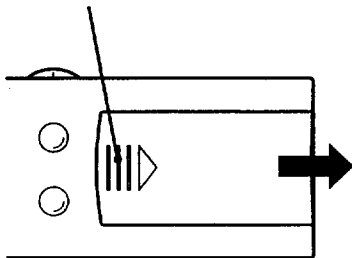

- 2 Place two "AA" size batteries, matching the + and - signs on each battery to the + and - signs of the battery compartment.

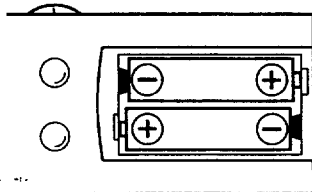

- 3 Replace the battery cover until the lock snaps.

CAUTION:

- Do not throw your batteries into a fire. Dispose of your batteries in a designated disposal area.
- Do not combine used old batteries with new ones.
- Do not mix battery types.

Tips for Best Operation

- For optimum performance, aim the Remote Control directly at the TV from a distance of no more than 16 ft (5m) and be sure there is no obstruction between the Remote Control and the TV.
- If your Remote Control does not always adjust the TV as you wish, you probably need to replace the batteries.
- Remove dead batteries immediately to prevent battery acid from leaking into the battery compartment.
- If you do not intend to use the Remote Control for a long period, remove the batteries.

Using the Remote with VCR or Cable TV Converter

- To control a TOSHIBA VCR, first set the TV/CABLE/VCR switch to "VCR" position. The buttons shown below will then control the VCR. The rest of the buttons operate the TV as usual. If you have another brand of VCR, you can probably program your Remote to control it. Details are on page 9.
- To control a cable TV converter, this Remote Control must be programmed to recognize the brand of your converter. See page 9. The shaded buttons can be used to control the cable TV converter. Set the TV/CABLE/VCR switch to "CABLE" position whenever you control the cable TV converter.

Aim at the VCR or cable TV converter

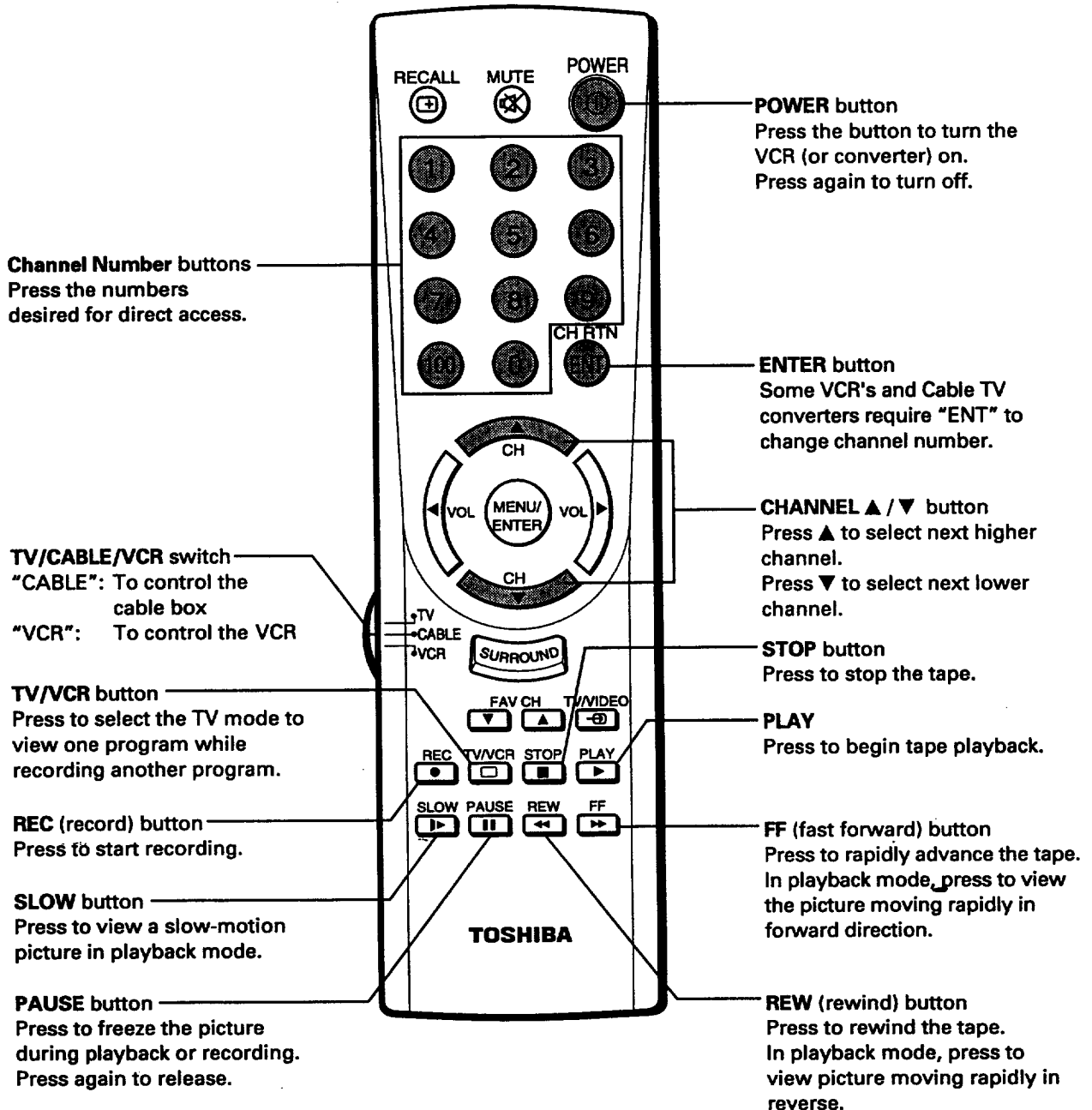

Programming the Remote Control

- This Remote Control is preprogrammed to operate TOSHIBA VCR's.
- To use VCR's other than Toshiba models (or cable converter), perform the following procedures before operating.

To control other brands of VCR's and cable TV converters

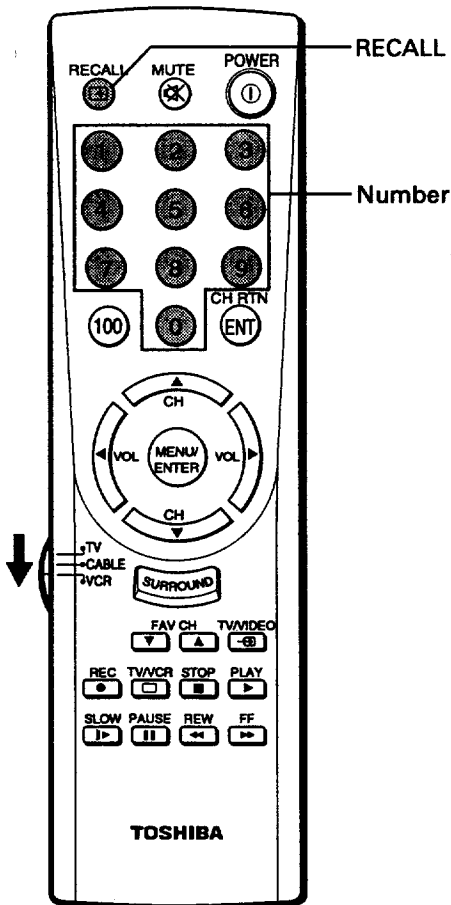

1 Refer to the "VCR code table" (or "Cable TV converter code table") on pages 10 and 11 to find the code number that corresponds to the brand name of your VCR (or converter).

If more than one number is listed, try each one separately until you find the one that works.

2 Set the TV/CABLE/VCR switch to "VCR" (or "CABLE").

3 Hold down RECALL while pressing the Number buttons for the three digit code number for your brand of VCR (or converter).

4 Point the Remote Control at the VCR (or at the converter) and press POWER to test the code number.

-If the right number was entered, the VCR (or the converter) should turn off.

-If the VCR (or the converter) does not respond to the Remote Control, repeat steps 1 to 4 with another code number.

Notes:

- You have to reprogram the Remote Control when you change its batteries.
- Some newer VCR's are capable of working on either of two remote codes. These VCR's have a switch labeled "VCR1/VCR2". If your VCR has this kind of switch, and does not respond to all the code numbers for your VCR brand name, set the switch to another position ("VCR1" or "VCR2") and reprogram the Remote Control.

For future reference, write the code you used.

VCR CODE: _____

CABLE CODE: _____

Programming the Remote Control (Continued)

- In some rare cases, you may not be able to operate your non-Toshiba equipment with the supplied Remote Control. This is because your equipment may use a code that is not provided with this Remote Control. In this case, please use the equipment's own remote control.

VCR code table

BRAND NAME	CODE NUMBER	BRAND NAME	CODE NUMBER	BRAND NAME	CODE NUMBER
Adventura	019	KLH	091	Realistic	019,054,056,065, 066,067,081,085, 123,259
Aiko	297	Kodak	054,056	Ricoh	053
Aiwa	019	Lloyd	019	Runco	058
Akai	060,068,080,125, 261	Lloyd's	227	Samsung	064,259
American High	054	Logik	091	Sanky	058,067
Asha	259	LXI	056	Sansui	060,086
Audiovox	056	Magnavox	054,058,100,129, 168	Sanyo	065,066,123,259
Beaumarck	259	Magnin	259	Scott	062,064,140,203, 229,230,231
Bell & Howell	123	Marantz	054,100	Sears	054,056,061,065, 066,073,085,123, 124
Brandt	206	Marta	056	Sharp	067,081
Broksonic	140,203,230,314, 380	Matsushita	054	Shintom	091
Calix	056	MEI	054	Shogun	259
Canon	054	Memorex	019,054,056,058, 065,066,067,123, 259	Singer	091
Capehart	039	MGA	062,080	Sony	051,052,053,054
Carver	100	MGN Technology ..	259	STS	061
CCE	091,297	Minolta	061,124	Sylvania	019,054,062,100, 129
Citizen	056,297	Mitsubishi	062,080,086,094 192,233,261	Symphonic	019,344
Colt	091	Motorola	054,067	Tatung	060
Craig	056,066,091,259	MTC	019,259	Teac	019,060
Curtis Mathes	054,060,079	Multitech	019,091	Technics	054,181
Cybernex	259	NAD	077	Teknika	019,054,056,071
Daewoo	039,064,297	NEC	057,059,060,069, 086	Telefunken	206
Daytron	039	Nikko	056	TMK	227,259
Dynatech	019	Noblex	259	Toshiba	062,064,085,229, 231,385
Electrohome	056	Olympus	054	Totevision	056,259
Electroponic	056	Optimus	056,067,077,123	Unitech	259
Emerex	051	Optonica	081	Vector	064
Emerson	019,021,056,062, 080,087,140,203, 227,228,230,231, 297,313,314,380, 498	Orion	498	Vector Research ...	057,059
Fisher	066,073,085,123	Panasonic	054,096,181,244, 473	Video Concepts	059,064,080
Fuji	052,054	Penney	054,056,057,059, 061,073,259	Videosonic	259
Funai	019,344	Pentax	061,084,124	Wards	019,054,061,066, 067,081,091,168, 231,259
Garrard	019,344	Philco	054	XR-1000	019,054,091
GE	054,079,084,221	Philips	054,081,100,129	Yamaha	057
Goldstar	037,056,057	Pilot	056	Zenith	052,053,058
Gradiente	019	Pioneer	077,086		
Harley Davidson	019	Portland	039		
Harman/Kardon'	057,094	Protec	091		
Harwood	087,091	Pulsar	058		
Headquarter	065	Quarter	065		
HI-Q	066	Quarts	065		
Hitachi	060,061,084,124, 185, 254	Quasar	054,096		
Jensen	060	Radio Shack	019,056,344		
JVC	027,060,086	Radix	056		
Kenwood	057,060,086	Randex	056		
		RCA	061,079,084,096, 124,125,168,221		

Cable TV converter code table

BRAND NAME	CODE NUMBER	BRAND NAME	CODE NUMBER
ABC	020,022,026,027, 030,032,033,036, 066	SL Marx	059
Antronix	041	Sprucer	040
Archer	041,058,172	Standard Components	174
Belcor	075	Starcom	022,034,066
Cable Star	075	Stargate	034,059
Cabletenna	041	Starquest	034
Cableview	041	Sylvania	020
Century	172	Televue	059
Citizen	172	Texscan	020
Colour Voice	044,050	Tocom	031,032,078
Comtronics	059,079	Toshiba	019
Contec	038	Tusa	034
Dae Ryung	027	Unika	041,172
Eastern	021	United Artists	026
Focus	419	United Cable	022
Garrard	172	Universal	041,058,075,172
GC Electronics	075	Viewstar	046,079,230
Gemini	034,089	Zenith	019
General		Zentek	419
Instrument	030,295		
Goldstar	059,163		
Hamlin	028,039,053,278, 292		
Hitachi	030		
Hytex	026		
Jasco	172		
Jerrold	022,030,031,033 034,066,295		
Macom	052		
Magnavox	046		
Memorex	019		
Movie Time	175		
NSC	089,175		
Oak	026,038,267		
Panasonic	019,040,126		
Paragon	019		
Philips	044,046,047,048 049,050,172		
Pioneer	042,163,552		
Popular			
Mechanics	419		
Pulsar	019		
RCA	040		
Recoton	419		
Regal	039,278,292		
Regency	021		
Rembrandt	030,089		
Runco	019		
Samsung	059,163		
Scientific Atlanta ...	025,027,036,296		
Signal	034,059		
Signature	030		

Menu Function (General Instructions)

We suggest you familiarize yourself with the procedure before using the Menu function.

To adjust any TV feature, the use of the Menu function is required. The adjustments that can be made to the TV appear on the screen.

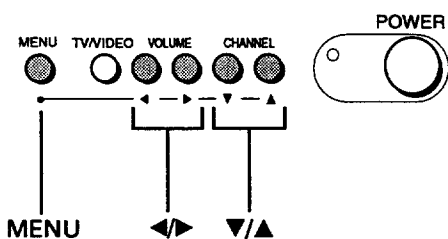

MENU button (on TV and on Remote)

Each time you press MENU, the Picture, Audio, Setup or Option menu on-screen display is selected in order, then press ▼ or ▲.

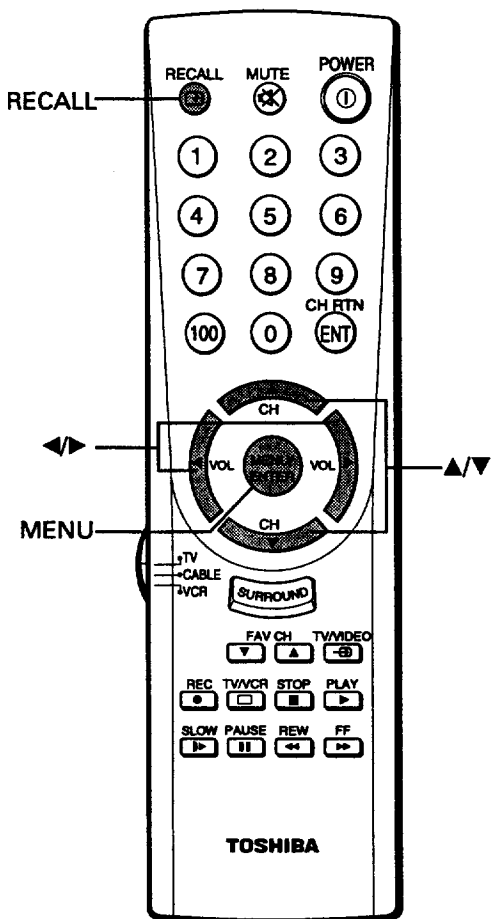
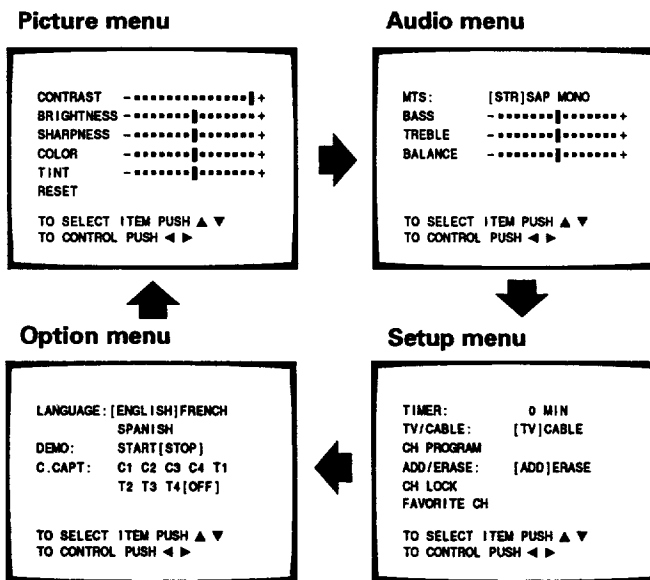

▼/▲ buttons (on TV and on Remote)

Use ▼ or ▲ after you have selected the on-screen menu you want to adjust with the MENU button.

Each time you press ▼ or ▲, the function to be adjusted will be selected in order.

▼ button from top to bottom

▲ button from bottom to top

The selected function will be displayed in purple.

◀/▶ buttons (on TV and on Remote)

Use ◀ or ▶ to adjust the function you have selected with the ▼/▲ buttons.

RECALL button (on Remote)

The above four menu displays will automatically disappear from the screen if no control has been operated for about 15 seconds.

If you want to instantly clear the screen of all menu displays, press **RECALL**.

Notes:

- The ◀/▶ buttons will function as the VOLUME ◀/▶ buttons when no menu display is on the screen.
- The ▲/▼ buttons will function as the CHANNEL ▲/▼ buttons when no menu display is on the screen.

Programming Channel Memory

The channel memory is the list of TV channel numbers your TV will stop on when you press the CHANNEL ▲ or ▼ button. First, use the TV/CABLE and CH PROGRAM functions to preset all active channels in your area. If necessary, arrange the preset channels with the ADD/ERASE functions so that you can tune into only desired channels.

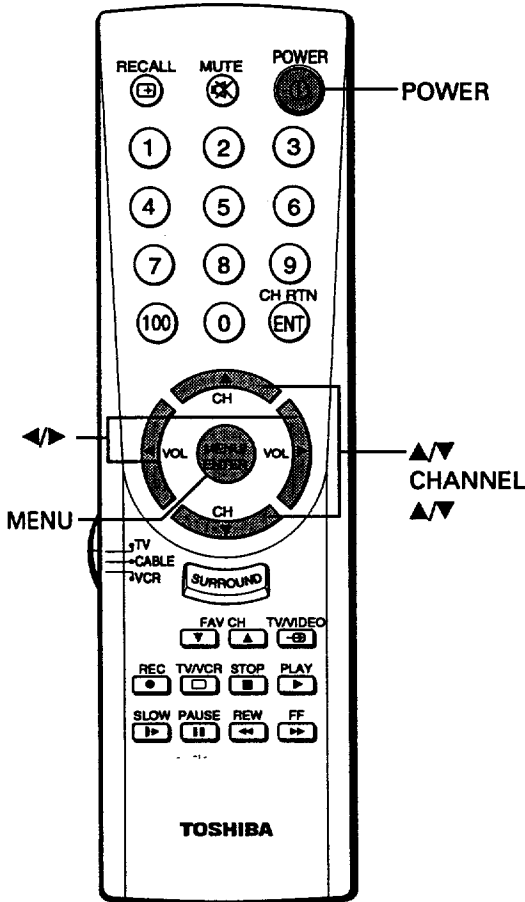
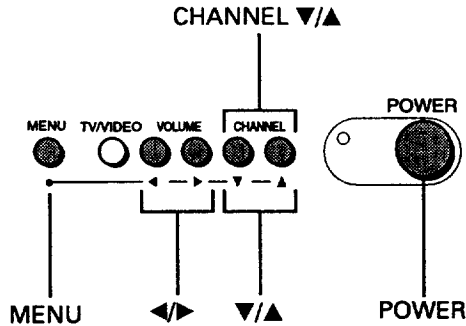

TV/CABLE function

- 1 Press **POWER** to turn on the TV.
- 2 Press **MENU** repeatedly until the Setup menu is displayed on the screen.
- 3 Press **▲** or **▼** repeatedly until "TV/CABLE" is displayed in purple.

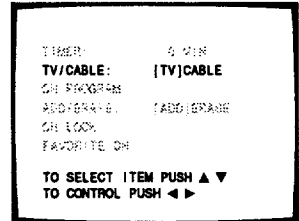

- 4 Press **◀** or **▶** until the mode that corresponds to your TV signal system is displayed in purple.
TV: TV broadcasts signals.
 (VHF channels 2 through 13 and UHF channels 14 through 69)
CABLE: Cable TV signals.
 (Cable channels 1 through 125)

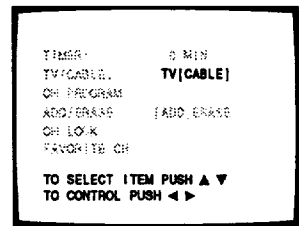

CH PROGRAM function

- 1 Press **MENU** repeatedly until the Setup menu is displayed on the screen.
- 2 Press **▲** or **▼** repeatedly until "CH PROGRAM" is displayed in purple.

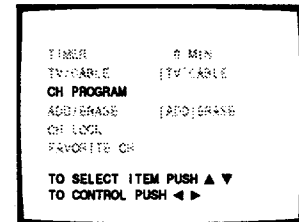

- 3 Press **◀** or **▶** to start channel programming. The TV will automatically cycle through all the TV or CABLE channels depending on the mode selected, and store active channels in the channel memory.

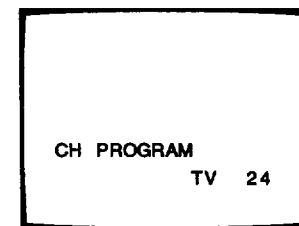

- 4 When channel programming is complete, you will see the message at the right.

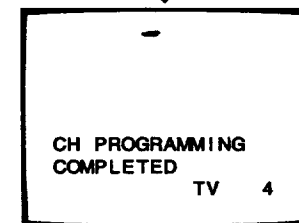

- 5 Press **CHANNEL ▲** or **▼** to make sure the channel programming has been done properly.

PREPARATION Menu Function (General Instructions)/ Programming Channel Memory

Programming Channel Memory (Continued)

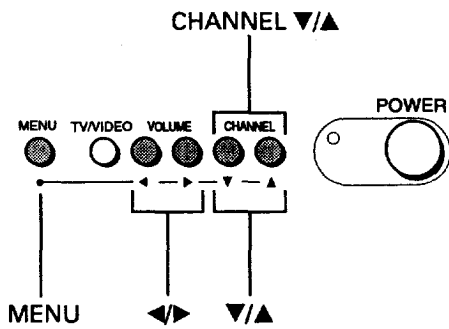

ADD/ERASE function

After performing the CH PROGRAM function, you can add or erase specific channels.

- 1 Select the channel you want to erase using the **CHANNEL ▲** or **▼** button, or select the channel you want to add using the **Channel Number** buttons.
- 2 Press **MENU** repeatedly until the Setup menu is displayed on the screen.
- 3 Press **▲** or **▼** until "ADD/ERASE" is displayed in purple.

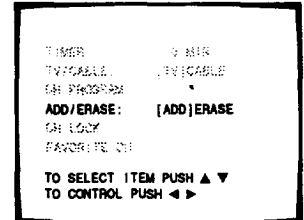

- 4 Press **◀** or **▶**
To erase the channel
 Press the button until "ERASE" is displayed in purple indicating that the channel has been erased from the memory.

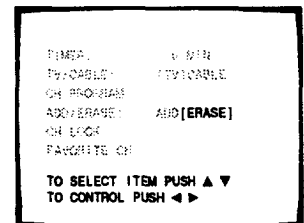

To add the channel
 Press the button until "ADD" is displayed in purple indicating that the channel has been memorized.

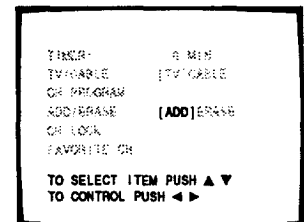

- 5 Repeat steps 1 to 4 for other channels.

You have now completed the channel programming.

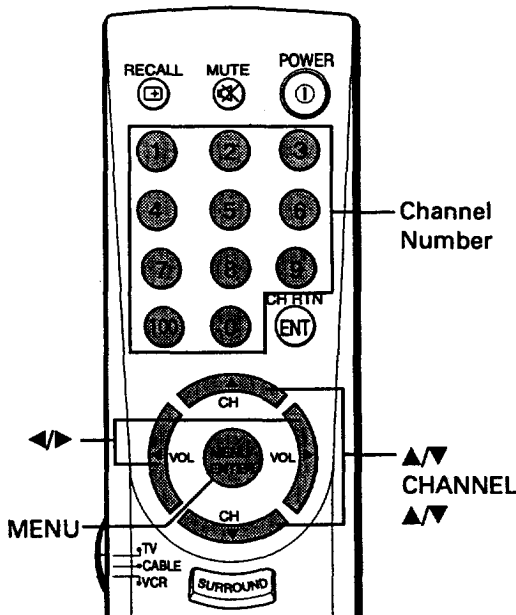

CABLE channel reference chart

Number on this TV	1	5	6	14	15	16	34	35	36	37	38	60	61	62	63	64	65	66
Corresponding CABLE channel	A-8	5(A-7)	6(A-6)	A	B	C	U	V	W	AA	BB	XX	YY	ZZ	AAA	BBB	65	66
Number on this TV	67	68	69	92	93	94	95	96	97	98	99	100	101	102	123	124	125	
Corresponding CABLE channel	67	68	69	92	93	94	A-5	A-4	A-3	A-2	A-1	100	101	102	123	124	125	

The above chart is typical of many cable system channel allocations. If in doubt, consult your cable company.

Watching TV Programs

- First set the TV/CABLE/VCR switch on the Remote Control to "TV" position.

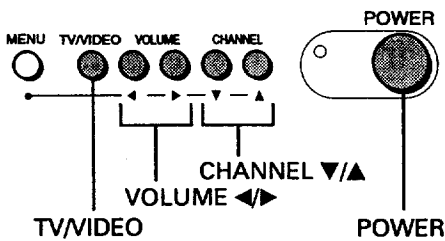

1 Press POWER to turn on the TV.

To turn off the TV, press POWER again.

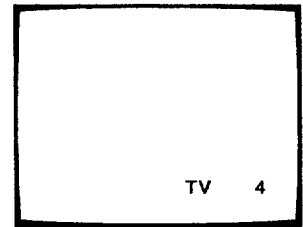

2 Select a channel in one of the following two ways.

- **To scan the memorized channels in numerical sequence**
Press CHANNEL \blacktriangle to select the next higher channel.
Press CHANNEL \blacktriangledown to select the next lower channel.
Press the button again to select the next memorized channels.

- **To select a channel directly**
Press the Channel Number buttons (0-9 and 100).
To select channel 4, press "4" (or press "0", "4").
To select channel 38, press "3", "8".
To select channel 125, press "100", "2", "5" in sequence.

If you cannot select certain channels, either TV (off the air) or CABLE channels
Check if the TV/CABLE function is properly set. See page 13.

3 Press VOLUME \leftarrow/\rightarrow to adjust the volume.

To increase the volume, press \blacktriangleright .
To decrease the volume, press \blacktriangleleft .

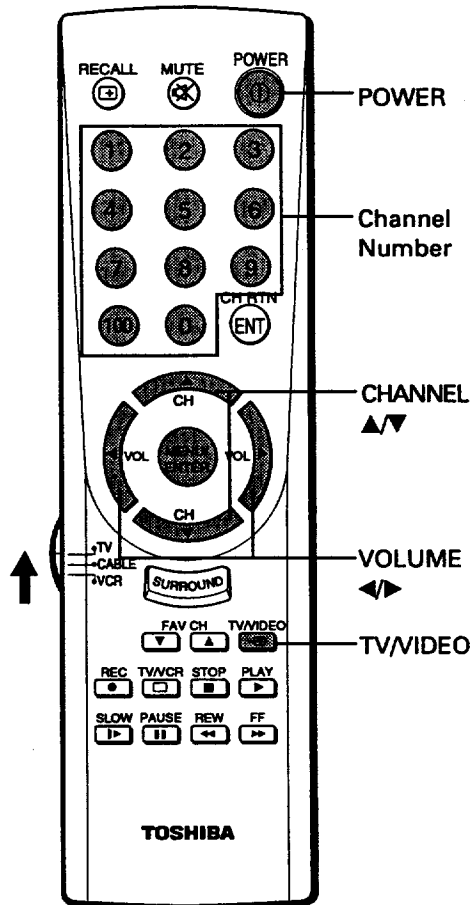
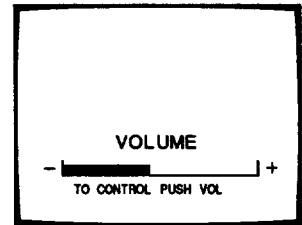

Watching Video Input

The TV/VIDEO button is used to view the signals coming from other devices like VCR's or Laser Disc Players connected to this TV.

Details are on page 27.

Auto-Power-Off

If a vacant channel is tuned or TV broadcast for a day is finished, the TV will automatically turn off after about 15 minutes.
This feature does not operate in the VIDEO mode.

Last Mode Memory

If the power is cut off while you are viewing the TV and the power is resupplied, the TV is turned on automatically by the Last Mode Memory feature. If the power is going to be off or when you leave home for a long time, remove the power plug from the wall outlet to prevent the TV from turning on in your absence.

Demonstration Mode

When this function is activated, your TV will automatically display a variety of its on-screen menus and special features, this function is provided for demonstration purpose only.

To start the demonstration, select "DEMO [START]" in the Option menu. (See page 12.)
To stop, press RECALL or POWER.

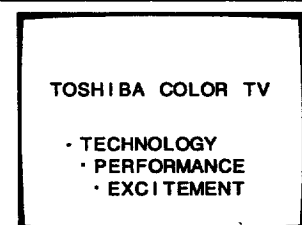

Convenient Remote Functions

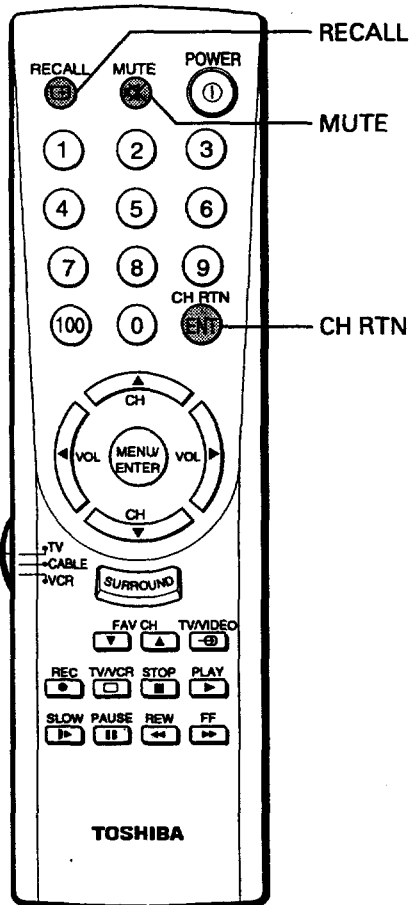

To display on-screen information

Press **RECALL** to display the following on-screen information.

- Channel number
- VIDEO mode selected
- Stereo or SAP audio status

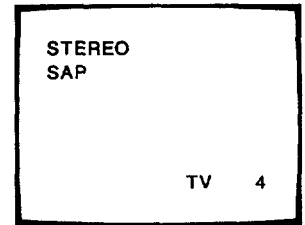

To mute the sound

Press **MUTE** to mute the sound. The word "MUTE" will be displayed on the screen as shown. This is useful during telephone calls or other interruptions.

To restore the sound, press **MUTE** again.

Note: When the MUTE button is pressed, the Closed-Captioned feature "C1" is activated. ("MUTE" on the screen display will disappear.) To deactivate, press the MUTE button again. (This feature only functions when the Closed Caption mode is set to "OFF".)



To change quickly between two channels

Press **CH RTN** to return to the last channel viewed. This is useful should you want to view two channels. This allows you to view two programs without entering an actual channel number each time.

To operate this function

- 1 Select the first channel you want to view.
- 2 Select the other channel with the Channel Number buttons.
- 3 Press **CH RTN**.
The previous channel will return.

Each time you press **CH RTN**, the TV will switch back and forth between the two channels.

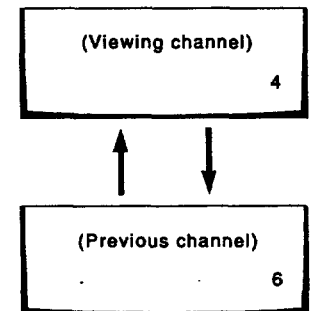

Setting the Off-Timer (Sleep Timer)

With the off-timer, you can set the TV to turn off automatically after a pre-determined period of time (up to 180 minutes in 10 minute units).

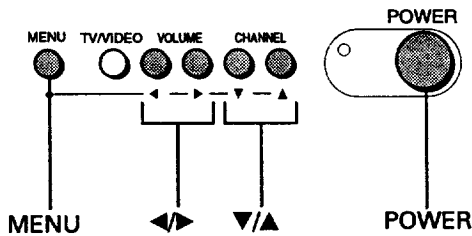

To set the off-timer

- 1 Press **MENU** repeatedly until the Setup menu is displayed on the screen.

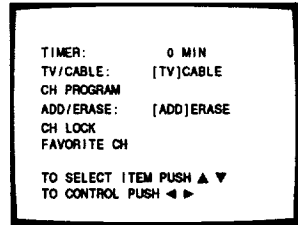

- 2 Press **▲** or **▼** repeatedly until "TIMER" is displayed in purple.

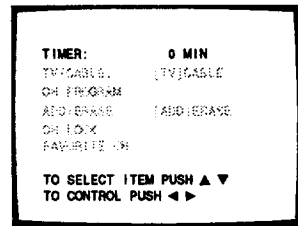

- 3 Press **◀** or **▶** to enter the length of time you want the TV to stay on. Each time you press the button, the time display will increase (▶) or decrease (◀) by 10 minutes.

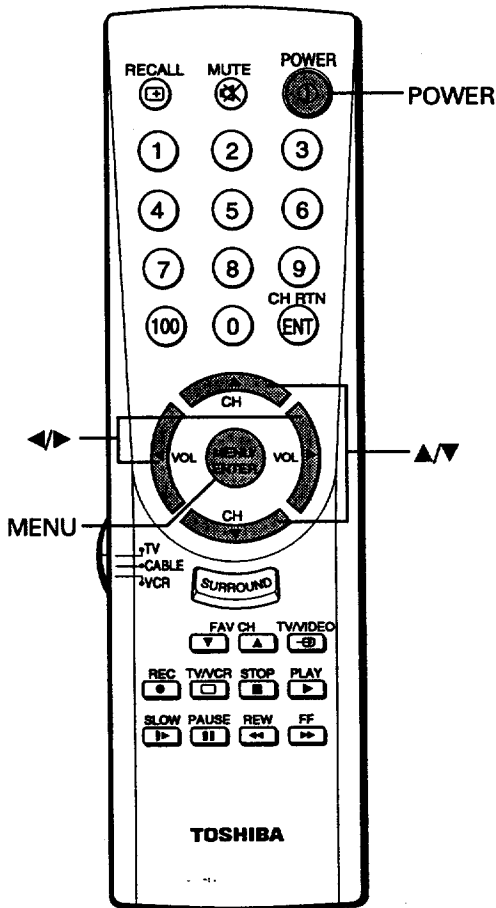
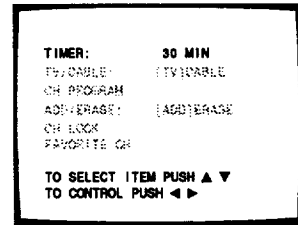

To cancel the setting

Press **POWER** twice, once to turn the TV off and once to turn it on again.

BASIC OPERATION

Convenient Remote Functions/ Setting the Off-Timer (Sleep Timer)

Adjusting the Picture

You can adjust the picture quality (CONTRAST, BRIGHTNESS, SHARPNESS, COLOR and TINT) to suit your taste.

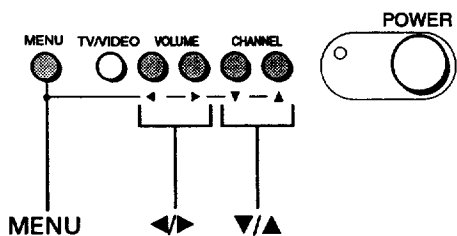

To adjust the picture quality

- 1 Press **MENU** repeatedly until the Picture menu is displayed on the screen.
- 2 Press **▲** or **▼** repeatedly until the item you want to adjust is displayed in purple.

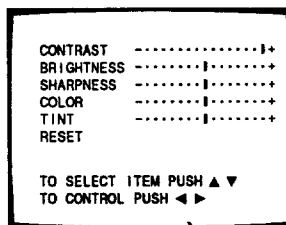

- 3 Press **◀** or **▶** to adjust the level.

Example: CONTRAST adjustment mode display

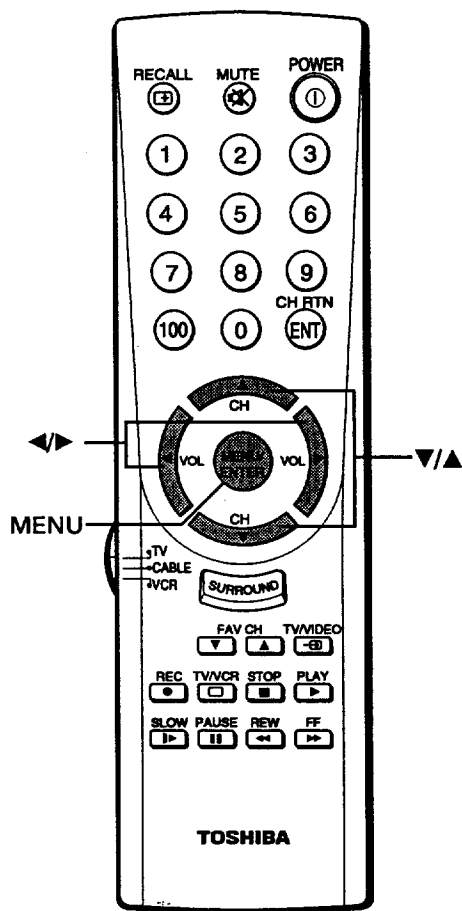
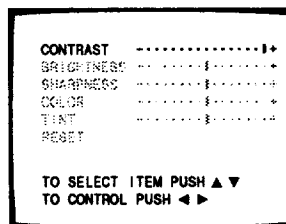

Selection	Pressing	
	◀	▶
CONTRAST	lower	higher
BRIGHTNESS	darker	lighter
SHARPNESS	softer	sharper
COLOR	paler	deeper
TINT	reddish	greenish

To reset the Picture and Sound adjustments to the factory-preset status (maximum CONTRAST and all other adjustments centered)

- 1 Press **MENU** repeatedly until the Picture menu is displayed on the screen.
- 2 Press **▲** or **▼** repeatedly until "RESET" is displayed in purple.

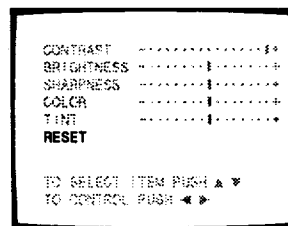

- 3 Press **◀** or **▶**.

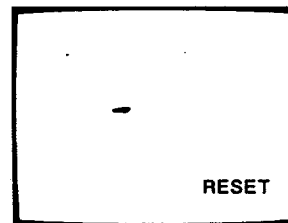

Adjusting the Sound

You can adjust the sound quality (BASS, TREBLE and BALANCE) to suit your taste.

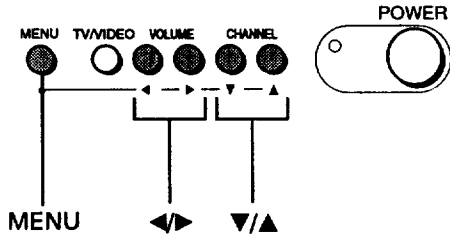

To adjust the sound quality

- 1 Press **MENU** repeatedly until the Audio menu is displayed on the screen.
- 2 Press **▲** or **▼** repeatedly until the item you want to adjust is displayed in purple.

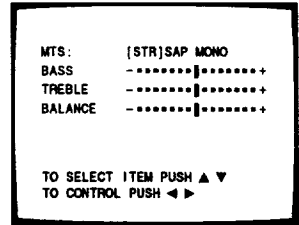

- 3 Press **◀** or **▶** to adjust the level.

Example: BASS adjustment mode display

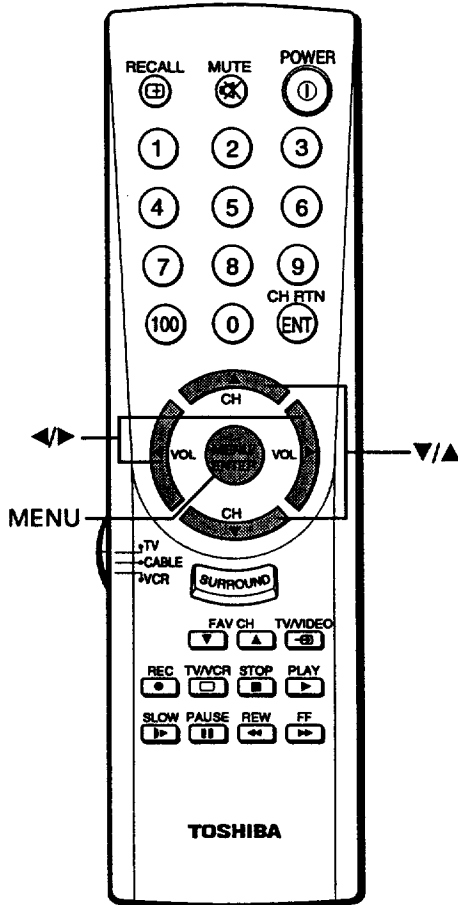
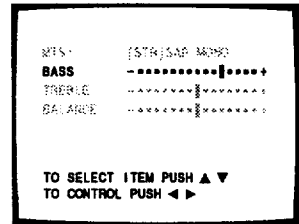

Selection	Pressing	
	◀	▶
BASS	weaker	stronger
TREBLE	weaker	stronger
BALANCE	decreases the right channel	decreases the left channel

Selecting Stereo/SAP Broadcasts

The MTS (Multi-channel TV Sound) feature allows you to improve your TV viewing with high fidelity stereo sound. This TV also allows you to activate or deactivate the stereo surround sound effect. MTS also provides for an extra channel, SAP (Second Audio Program), used to transmit a second language or other audio information.

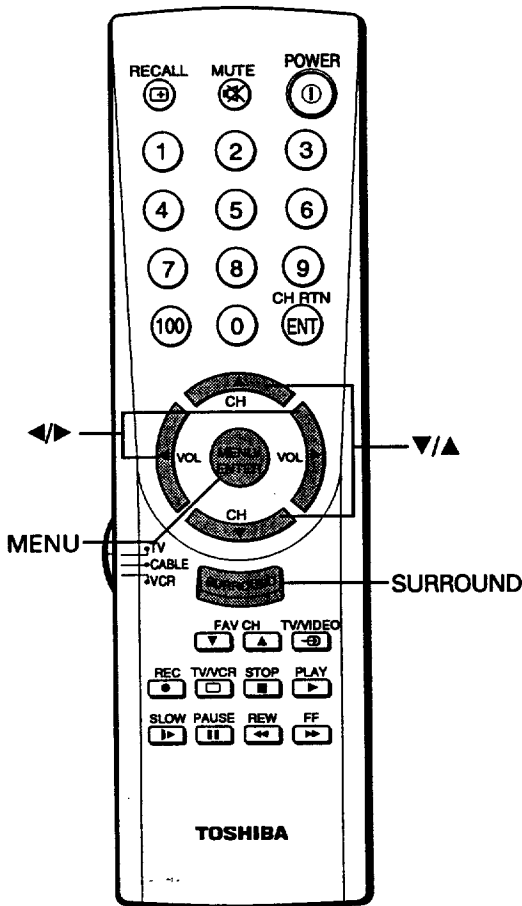
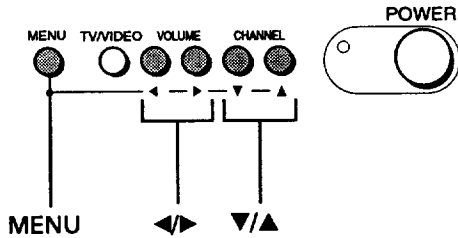

To listen to stereo sound

- 1 When the TV receives a stereo broadcast, the word "STEREO" is displayed on the screen whenever the TV is turned on, a channel is selected, or the RECALL button is pressed.
 - 2 Press **MENU** repeatedly until the Audio menu is displayed on the screen.
 - 3 Press **▲** or **▼** repeatedly until "MTS" is displayed in purple. If a stereo broadcast is received, "STR" will be displayed in yellow.
 - 4 Press **◀** or **▶** until "STR" (stereo) is displayed in purple.
- Normally this function can be left in "STR" mode. Your TV will then automatically reproduce either stereo or monaural sound, whichever is broadcast.

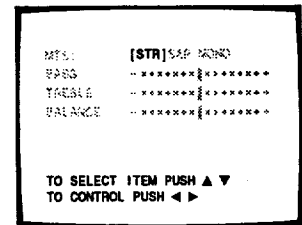
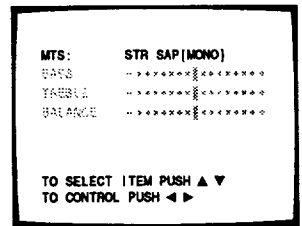
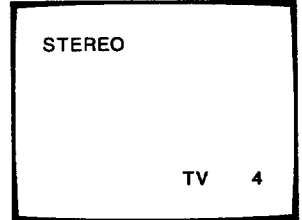

If the stereo sound is noisy

Be sure you have selected "STR" mode if broadcast is in stereo. However, if a broadcast signal is not strong enough, and noise-free stereo sound is not available, select "MONO" (monaural) mode. The noise should be reduced.

To activate surround sound effect

- 1 Select the STEREO mode as described above.
 - 2 Press **SURROUND** repeatedly until "SURROUND ON" is displayed in purple.
- The surround function has now been activated.

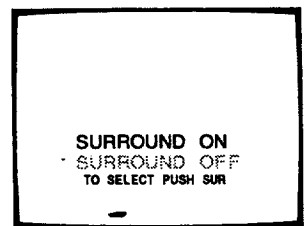

Note: "MTS" function is not available while in the VIDEO mode.

To deactivate the surround effect
Select "SURROUND OFF" in step 2 above.

Note: Normally you can leave the "STR" mode turned on and the surround function activated. The TV will automatically produce either surround stereo or monaural, whatever is broadcast.

To listen to second language

- 1 When the TV receives a SAP broadcast, the word "SAP" is displayed on the screen.

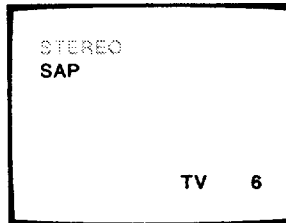

- 2 Press MENU repeatedly until the Audio menu is displayed on the screen.
- 3 Press ▼ or ▲ until "MTS" is displayed in purple. If a SAP broadcast is received, "SAP" will be displayed in yellow.

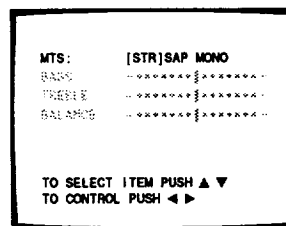

- 4 Press ◀ or ▶ until "SAP" is displayed in purple. You will hear only the second language from the left and right speakers.

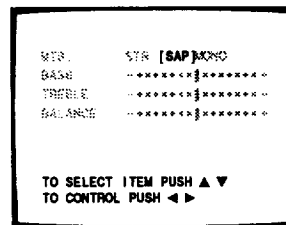

Locking Channels

With this function you can lock out specific channels (for example a channel that you do not want your children to watch) by entering your own 4-digit code. The TV will not be able to tune them for the next 24 hours, unless you cancel the locked out channels. This TV has 8 memory spaces total, 4 for the TV mode and 4 for the CABLE mode.

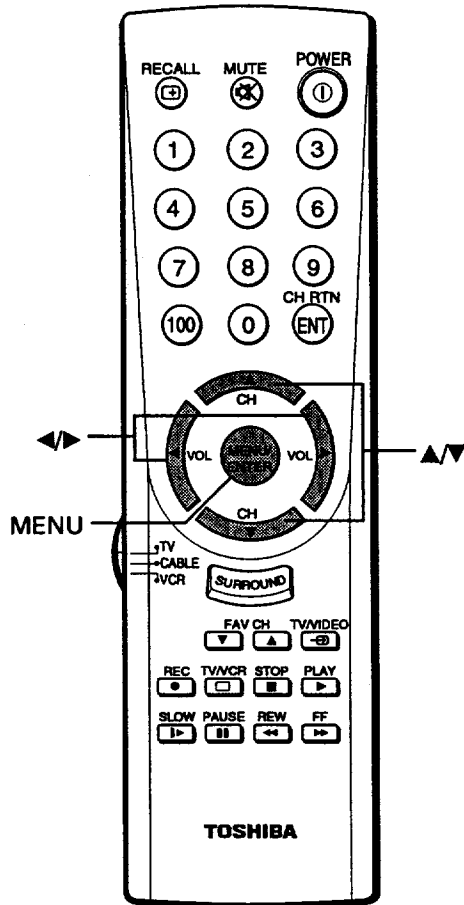
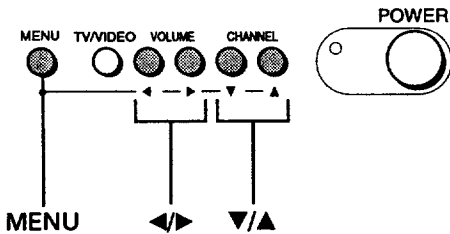

To lock out channels

1 Select a channel you want to lock out.

Example: channel 4

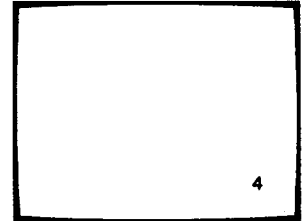

2 Press **MENU** repeatedly until the Setup menu is displayed on the screen.

3 Press **▲** or **▼** repeatedly until "CH LOCK" is displayed in purple.

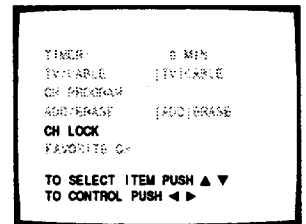

4 Press **◀** or **▶** to call up the channel lock adjustment display shown below. Each time you press the button, you are guided between "SET" and "CLEAR". Select "SET"

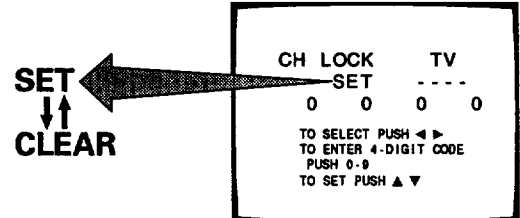

5 Press Number buttons (0 - 9) to enter a 4-digit code. The numbers you enter will replace the dashes in the display. Pick a number that is easy to remember.

Example: To enter "1234"

Press 1, 2, 3 and 4 in order.

1----→12--→123-→1234

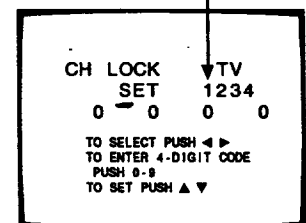

- 6** Press ▲ or ▼ to lock out the channel.
The display at the right will appear on the screen for about 4 seconds.

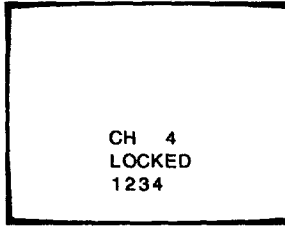

- 7** Repeat steps 1 to 6 for other channels.
This TV has 8 memory spaces total, 4 for the TV mode and 4 for the CABLE mode.

Note: If a different code number is used whenever you lock out a channel, the last one has priority over the preceding ones.

- 8** Select another channel before turning off the TV.

To restore channels

- 1** Select "CLEAR" following the steps 2 to 4 on the previous page.

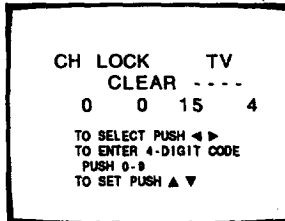

- 2** Press the 4-digit code used to lock out the channels with the Number buttons.

- 3** Press ▲ or ▼.
If you have entered the correct code
The display shown at the right appears.

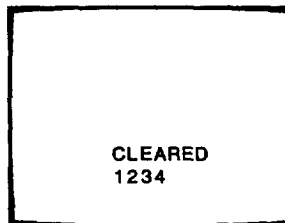

If a wrong code has been entered
These messages appear. Try to enter the correct code again.

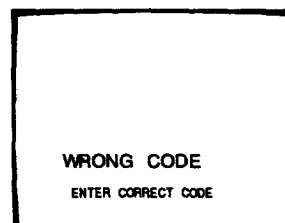

If you want to know the channels you have locked out
Call up the channel lock adjustment mode using the Setup menu.

Programming Your Favorite Channels

The Favorite Channel Programming feature allows you to program up to 12 of your favorite channels. Once programmed, you can use the FAV ∇/\blacktriangle buttons on the Remote Control to scan through only your favorite channels, skipping other channels you do not normally view. You can use the CHANNEL \blacktriangle/∇ buttons to scan through all the channels you programmed in TV's memory.

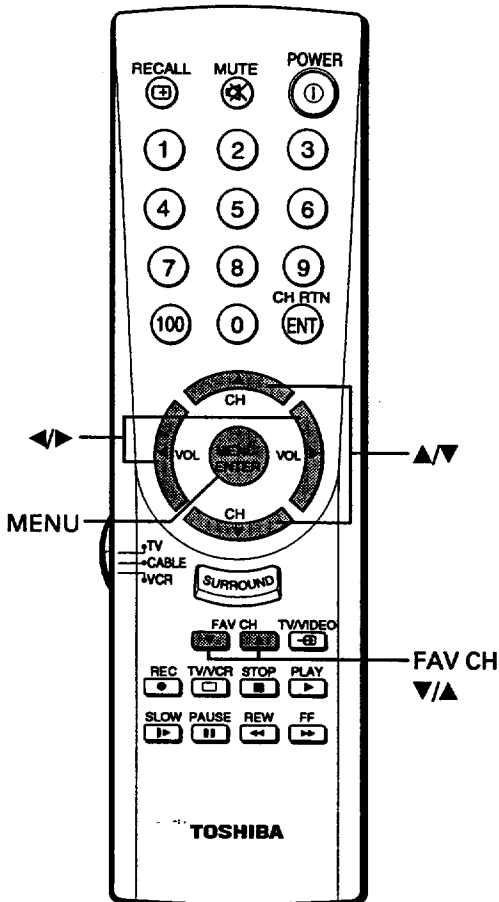
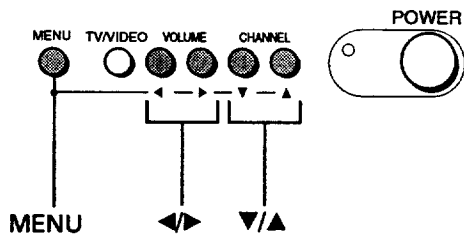

To program your favorite channels

1 Select a channel you want to program.

Example: channel 2

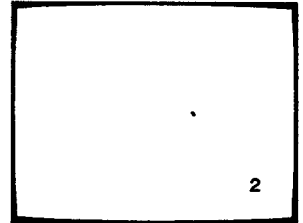

2 Press **MENU** repeatedly until the Setup menu is displayed on the screen.

3 Press \blacktriangle or ∇ until "FAVORITE CH" is displayed in purple.

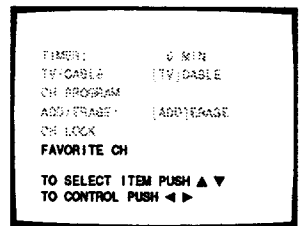

4 Press \blacktriangleleft or \blacktriangleright to display the FAVORITE CH program menu.

Each time you press \blacktriangleleft or \blacktriangleright , you are guided between "SET" and "CLEAR".

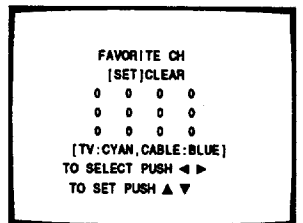

5 To program channels: Select "SET". Then press \blacktriangle or ∇ until the channel number to be programmed ("2" in this example) replaces "0" on the display.

To erase channels:

Select "CLEAR". Then press \blacktriangle or ∇ until "0" replaces the channel number to be erased, "2" for example.

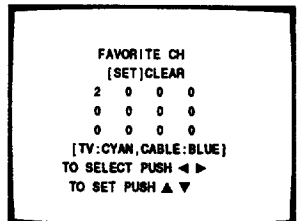

6 Repeat steps 1 to 5 for other channels.

To select your favorite channels

To select your favorite channels you have programmed, use the FAV ∇/\blacktriangle buttons on the Remote Control instead of using the CHANNEL \blacktriangle/∇ buttons.

Note: The FAV ∇/\blacktriangle buttons cannot function if you have not programmed your favorite channels.

Operating Closed Captioning Feature

Caption mode
example display
(C1, C2, C3, C4)

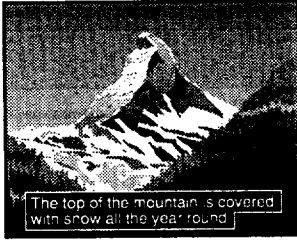

Text mode
example display
(T1, T2, T3, T4)

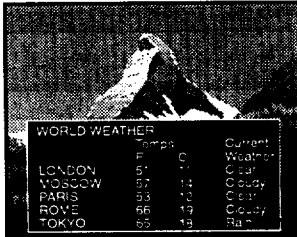

Captions

Closed captioning provides an on-screen display of the dialogue, narration, and/or sound effects of a TV program. Captions will appear at either the top or bottom of the screen while a captioned broadcast is shown. Captioning is especially helpful for hearing impaired individuals.

Text

Text is information that is presented on a portion of the TV screen. It is usually not related to the program. For example, it could be a listing of the closed-captioned programs, news, weather information or stock market reports.

To view captions or text

- 1 Select the desired program. The captioned programs are usually noted in your local TV listings by service marks such as "CC".
- 2 Press **MENU** repeatedly until the Option menu is displayed on the screen.
- 3 Press **▲** or **▼** repeatedly until "C.CAPT" is displayed in purple.
- 4 Press **◀** or **▶** repeatedly until "C1", "C2", "C3", "C4", "T1", "T2", "T3" or "T4" is displayed in purple. ("C1" stands for CAPTION 1, for example.) Select "C1" for translation of the primary language in your area.

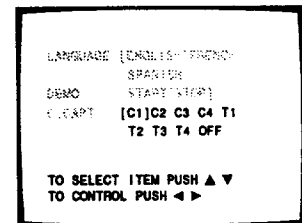
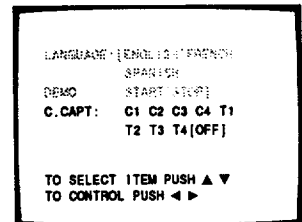

To deactivate this feature
Select "OFF" in step 4 above.

Note:

- A closed-captioned signal may not be decoded in the following situations.
 - When a video tape has been dubbed.
 - When the signal reception is weak.
 - When the signal reception is non-standard.
- If you select a closed-captioned channel and the Text mode, the text screen always appears. However, text characters are not displayed when no signal is aired.

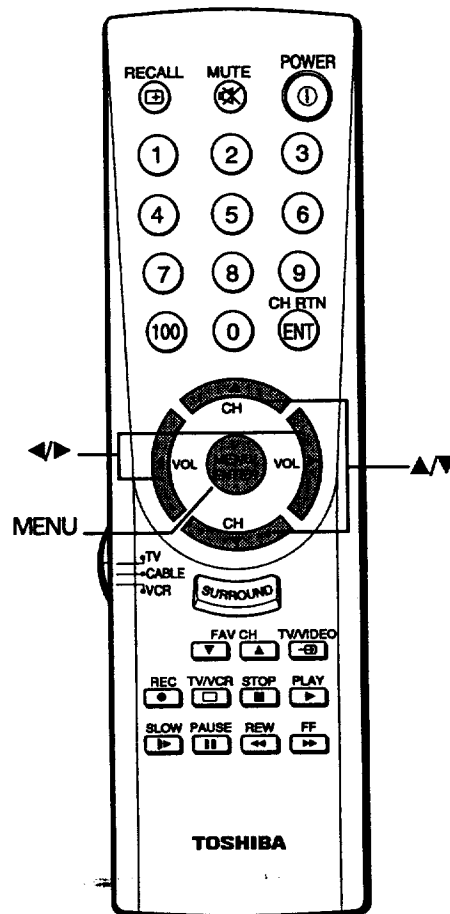
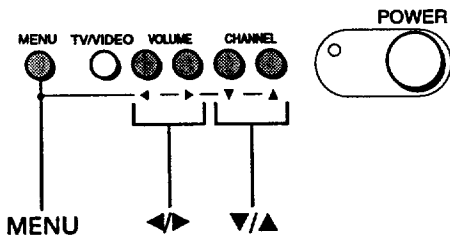

Changing On-Screen Display Language

You can choose from three different languages (ENGLISH, FRENCH and SPANISH) for the on-screen displays (adjustment menus, and messages).

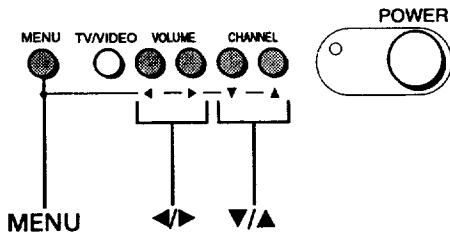

To select a language

- 1 Press **MENU** repeatedly until the Option menu is displayed on the screen.
- 2 Press **▲** or **▼** repeatedly until "LANGUAGE" is displayed in purple.
- 3 Press **◀** or **▶** until your desired language is displayed in purple.
If you select "FRENCH" for example, the display language changes to french.

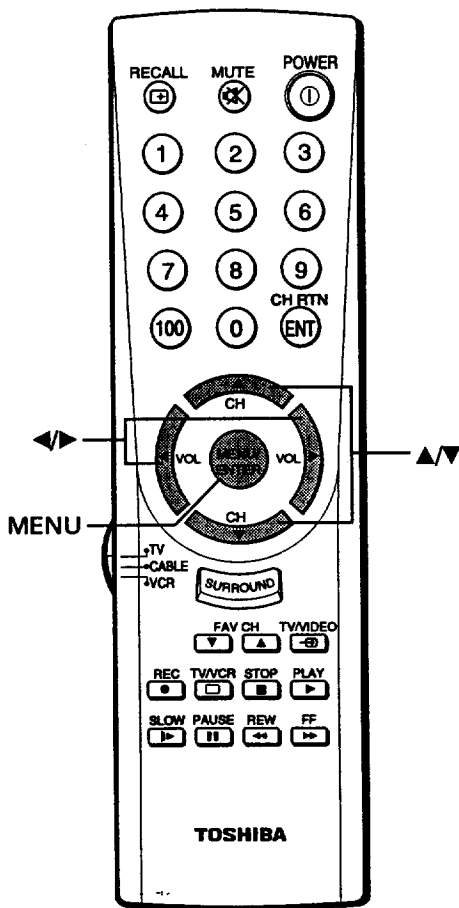
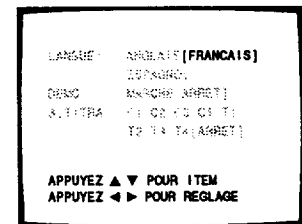
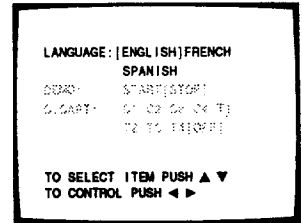

Example: Picture menu display "ENGLISH"

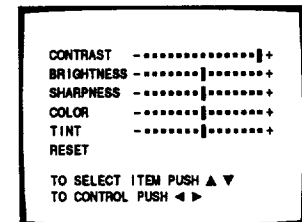

"FRENCH"

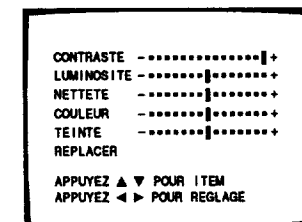

"SPANISH"

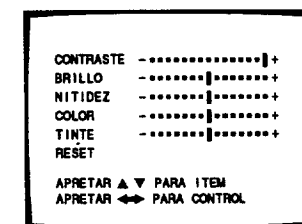

Connecting Video Equipment

Connect VIDEO/AUDIO IN jacks on the rear of the TV to the video/audio output jacks of a VCR, Laser Disc player, etc. for playback of video material.

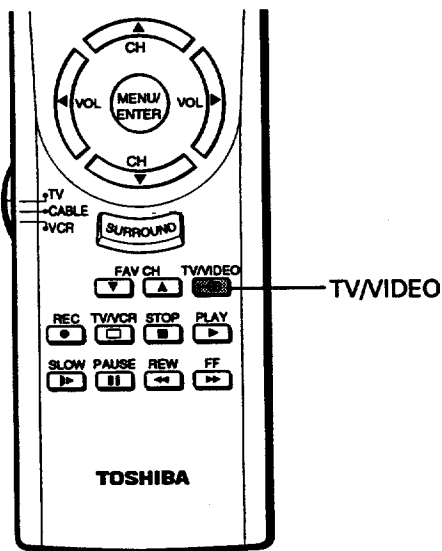
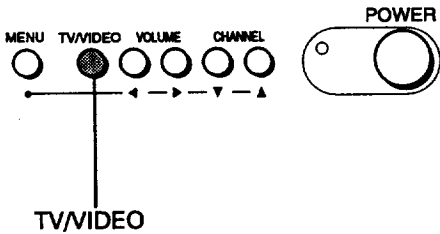
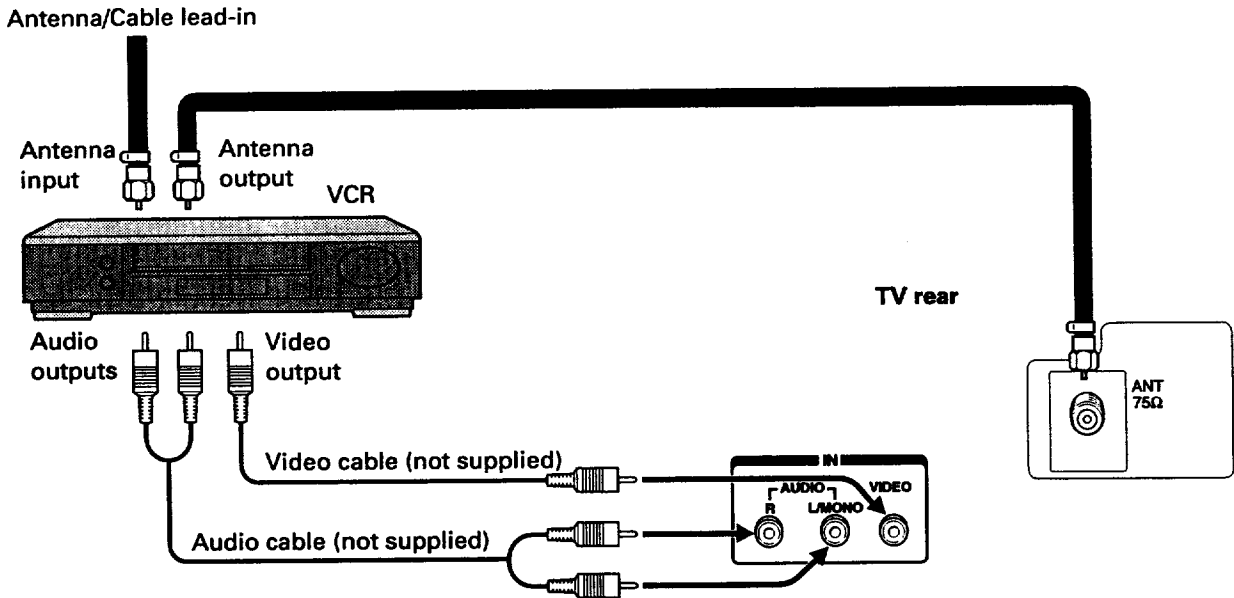

To select the video input source

To operate your TV and video equipment properly, refer to the instructions furnished with the video equipment.

- 1 Turn the TV and the video equipment ON.
- 2 Press TV/VIDEO on the Remote Control or on the TV to select "VIDEO". The selected source will be displayed in purple.

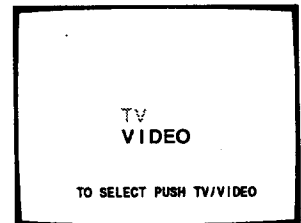

- 3 Operate the video equipment normally.

Note: If you connect a monaural video equipment, connect the audio output of the video equipment to the L/MONO jack on the TV.

Cleaning and Care

WARNING: TV sets use High Voltage. Do not try to remove the cabinet back. Refer servicing to qualified service personnel.

- To clean the TV screen:
 1. First remove the plug from the power outlet to avoid possible shock hazard.
 2. Use a clean cellulose sponge or chamois cloth dampened with a solution of mild detergent and warm water to clean TV screen and trim. Do not use too much water on the TV screen. Water spills into the cabinet and may cause damage to the TV. Avoid excess water.
 3. Remove any extra moisture with the same cloth or a dry one.
 - To maintain the finish and appearance of the cabinet, polish it from time to time with a quality furniture polish.
- Caution:** Never use strong solvents such as thinner, benzene or other chemicals on or near cabinet, as they might damage the finish of the cabinet.

Specifications

TELEVISION SYSTEM:	NTSC standard
CHANNEL COVERAGE:	VHF; 2 through 13 UHF; 14 through 69 Cable TV; mid band (A-8 through A-1, A through I) super band (J through W) hyper band (AA through ZZ, AAA, BBB) ultra band (65 through 94, 100 through 125)
POWER SOURCE:	120V AC, 60Hz
POWER CONSUMPTION:	82W (average)
AUDIO POWER:	2W + 2W
SPEAKER TYPE:	Two 2 x 3-1/2 inches (5 x 9 cm) oval
VIDEO/AUDIO INPUTS:	VIDEO: 1V(p-p), 75 ohm, negative sync. AUDIO: 150mV(rms) (30% modulation equivalent, 47k ohm)
DIMENSIONS:	Width 26 inches (660mm) Height 24 inches (610 mm) Depth 22 3/8 inches (568mm)
MASS:	73 lbs. (33 kg)
SUPPLIED ACCESSORIES:	Remote Control with 2 size "AA" batteries

Design and specifications are subject to change without notice.

Before Calling Service Personnel

Before calling service personnel, please check the following chart for a possible cause of the problem you are experiencing. A minor adjustment on your part may eliminate the problem and restore your TV reception.

Problem	Checks and Adjustments	Page
TV will not turn on	● Make sure the power cord is plugged in, then press POWER button.	15
	● Check battery in the Remote. (Maybe batteries are "dead".)	7
No picture, no sound	● Check antenna/cable connections.	4
No sound, picture OK	● Maybe sound is muted. Try pressing VOLUME ► button.	15
	● Try another channel. (Maybe station trouble.)	
Poor sound, picture OK	● Try another channel. (Maybe station trouble or local interference from appliance.)	
Poor picture, sound OK	● Check antenna/cable connections.	18
	● Try another channel. (Maybe station trouble or local interference.)	
	● Adjust Picture menu.	
Poor reception of broadcast channels	● Try another channel.	4
	● Check antenna connections.	8
	● If using VCR, check TV/VCR button.	
No UHF, VHF OK	● Make sure TV/CABLE function is in "TV" mode.	13
Black box appears on the screen	● Captioning may be turned on	25
Cannot select a certain channel	● That channel may be locked out with CH LOCK function, or erased with the ADD/ERASE function.	22
		14
Multiple images (ghosts)	● Try another channel. (Maybe station trouble.)	
	● Use a highly directional outdoor antenna.	
Poor color or no color	● Try another channel. (Maybe station trouble or local interference.)	18
	● Adjust TINT and/or COLOR in the Picture menu.	
	● If you change the direction of the TV while the TV is activated, the picture may suffer from color shading. If so, turn off the TV and allow it to cool for about 30 minutes, then turn on the TV again. The picture should improve.	
No stereo or SAP sound from an MTS broadcast	● Check if MTS function is properly set.	20
The Remote Control does not operate	● Check if TV/CABLE/VCR switch is properly set.	6, 8
	● Maybe something was between the Remote and the remote sensor.	
	● Maybe batteries are "dead". Try replacing batteries with new ones.	7



Limited United States Warranty

Toshiba America Consumer Products, Inc. ("TACP") and Toshiba Hawaii Inc. ("THI") make the following limited warranties. These limited warranties extend to the original consumer purchaser or any person receiving this set as a gift from the original consumer purchaser and to no other purchaser or transferee.

Limited One (1) Year Warranty

TACP and THI warrant this product and its parts against defects in materials or workmanship for a period of one (1) year after the date of original retail purchase. During this period, TACP and THI will repair a defective product or part, without charge to you. "Authorized TACP/THI service station personnel will come to your home when warranty service is required. Depending on the type of repair required, the service will either be performed in your home or the set will be taken to the authorized TACP/THI service station for repair and returned to your home at no cost to you."

Limited Two (2) Year Warranty of Picture Tube

TACP and THI further warrant the picture tube in this product against defects in materials or workmanship for a period of two (2) years after the date of original retail purchase. During this period, TACP and THI will replace a defective picture tube without charge to you, except that if a defective picture tube is replaced after one (1) year from the date of the original retail purchase, you pay labor charges involved in the replacement.

Rental Units

The warranty for rental units begins with the first rental of thirty (30) days from the date of shipment to the rental firm, whichever comes first.

Commercial Units

Products sold and used for commercial use have a limited ninety (90) day warranty for all parts, labor and picture tube.

Owner's Manual and Demographic Card

You should read this owner's manual thoroughly before operating this product. You should complete and mail the enclosed Demographic card within ten days after you, or the person who has given you this product as a gift, purchased this product. This is one way to enable TACP/THI to provide you with better customer service and improved products. Failure to return the Demographic card will not affect your rights under this warranty.

Your Responsibility

The above warranties are subject to the following conditions:

- (1) You must retain your bill of sale or provide other proof of purchase.
- (2) All warranty servicing of this product must be made by an Authorized TACP/THI Service Station.
- (3) **These warranties are effective only if the product is purchased and operated in the U.S.A. or Puerto Rico.**
- (4) Labor service charges for set installation, set up, adjustment of customer controls and installation or repair of antenna systems are not covered by this warranty. Reception problems caused by inadequate antenna systems are your responsibility.
- (5) Warranties extend only to defects in materials or workmanship as limited above and do not extend to any product or parts which have been lost or discarded by you or to damage to products or parts caused by misuse, accident, damage caused by Acts of God, such as lightning or fluctuations in electric power, improper installation, improper maintenance or use in violation of instructions furnished by us; or to units which have had the serial number removed, altered, defaced or rendered illegible.

How to Obtain Warranty Service

If after following all of the operating instructions in this manual and checking the section "BEFORE CALLING SERVICE PERSONNEL", you find that service is needed:

- (1) Call the TACP toll free number 1-800-631-3811 after you find a defective product or part to find the nearest TOSHIBA Authorized Service Station.
- (2) Please present your bill of sale or other proof to the Authorized Service Station.
"Authorized TACP/THI service station personnel will come to your home when warranty service is required. Depending on the type of repair required, the service will either be performed in your home or the set will be taken to the TACP/THI Authorized service station for repair and returned to your home at no cost to you."

IN THE CONTINENTAL UNITED STATES
Should your unit require service, Call:



HAWAII, 327 Kamakee Street, Honolulu, HI 96814
(808) 521-5377

(A)

All warranties implied by state law, including the implied warranties of merchantability and fitness for a particular purpose, are expressly limited to the duration of the limited warranties set forth above. With the exception of any warranties implied by state law as hereby limited, the foregoing warranty is exclusive and in lieu of all other warranties, guarantees, agreements and similar obligations of manufacturer or seller with respect to the repair or replacement of any parts. In no event shall TACP or THI be liable for consequential or incidental damages.

No person, agent, distributor, dealer or company is authorized to change, modify or extend the terms of these warranties in any manner whatsoever. The time within which action must be commenced to enforce any obligation of TACP or THI arising under this warranty or under any statute, or law of the United States or any state thereof, is hereby limited to 90 days from the date you discover or should have discovered, the defect. This limitation does not apply to implied warranties arising under state law.

This warranty gives you specific legal rights and you may also have other rights which may vary from state to state. Some states do not allow limitation on how long an implied warranty lasts, when an action may be brought, or the exclusion or limitation of incidental or consequential damages, so the above provisions may not apply to you.

ATTENTION CANADIAN CONSUMERS:

Canadian consumers are requested to complete the special Canadian "Warranty Registration Form" enclosed, and forward this completed form with a copy of bill of sale to TOSHIBA OF CANADA to "Register and Validate" their warranty.
Products purchased in the U.S.A. and used in Canada are not covered by these warranties.
Products purchased in Canada and used in the U.S.A. are not covered by these warranties.



TOSHIBA AMERICA CONSUMER PRODUCTS, INC.

HEAD OFFICE/82 TOTOWA ROAD, WAYNE, NEW JERSEY 07470

FACTORY SERVICE CENTERS/NORTHEAST: 82 TOTOWA ROAD, WAYNE, NEW JERSEY 07470

MIDWEST: 1010 JOHNSON DRIVE, BUFFALO GROVE, ILLINOIS 60089-6900

WEST: 5490 E. FRANCIS ST., ONTARIO, CA 91761

SOUTHWEST: 1421 CHAMPION DRIVE, SUITE 304 CARROLLTON, TEXAS 75006

SOUTHEAST: 6115 JIMMY CARTER BLVD., SUITE C2, NORCROSS, GA 30071-4607

TOSHIBA HAWAII, INC.

HEAD OFFICE/327 KAMAKEE STREET, HONOLULU, HAWAII 96814, U.S.A.

TOSHIBA OF CANADA LTD.

HEAD OFFICE/191 McNABB STREET, MARKHAM, ONTARIO, L3R 8H2, CANADA TEL: (905) 470-5400

SERVICE CENTERS/TORONTO: 191 McNABB STREET, MARKHAM, ONTARIO, L3R 8H2, CANADA TEL: (905) 470-5400

MONTREAL: 1643, NORTH SERVICE RD., TRANS-CANADA HIGHWAY, DORVAL QUEBEC, H9P 1J1, CANADA

TEL: (514) 856-4100

VANCOUVER: 22171 FRASER WOOD WAY, RICHMOND, B.C., V6W 1J5 TEL: (604) 303-2500

MANUFACTURED BY

TOSHIBA AMERICA CONSUMER PRODUCTS, INC.

PRINTED IN USA

(98-05)

TOSHIBA

23563349