

TOSHIBA

Color Television

OWNER'S MANUAL

CX35F60

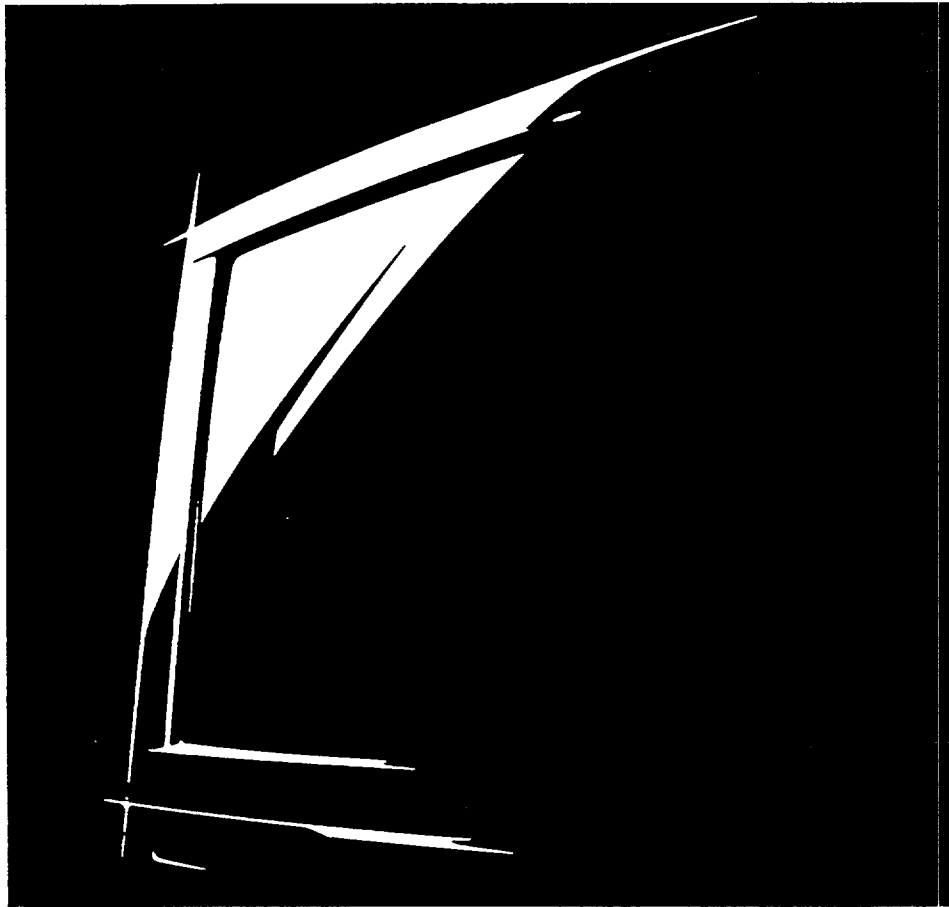

SET UP

PREPARATION

BASIC OPERATION

ADVANCED
OPERATION

EQUIPMENT
CONNECTIONS

REFERENCE
SECTION

Dear Customer

Congratulations! You have purchased one of the finest Color TV's on the market!

This manual will help you use the many exciting and useful features to make your TV viewing more enjoyable than ever before.

Before operating your TV set, please read all these safety and operating instructions completely and then retain for future reference.

Customer's Record

You will find the model number and serial number on the back of your TV set.

Record these numbers in the spaces provided below. Refer to them whenever you call upon your TOSHIBA dealer regarding this product.

Model Number _____

Serial Number _____

Safety Precautions

WARNING:

TO REDUCE THE RISK OF FIRE OR ELECTRIC SHOCK, DO NOT EXPOSE THIS APPLIANCE TO RAIN OR MOISTURE.

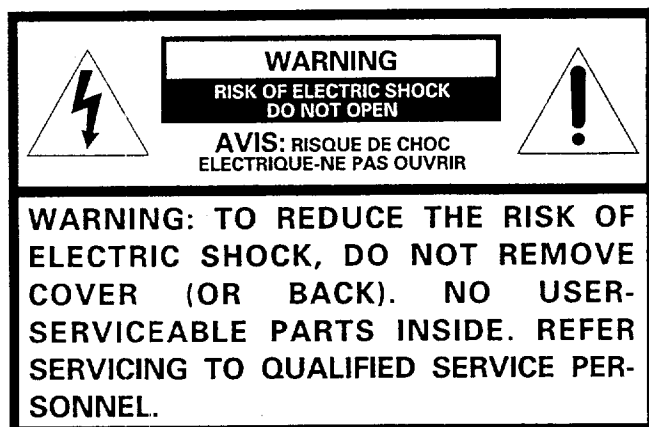

The lightning symbol in the triangle tells you that the voltage inside this product may be strong enough to cause an electric shock. **DO NOT TRY TO SERVICE THIS PRODUCT YOURSELF.**



The exclamation point in the triangle tells you that important operating and maintenance instructions follow this symbol.

This TV set may be used only with TOSHIBA stand model ST3512. Use with other stands may result in instability causing possible injury.

CAUTIONS:

TO PREVENT ELECTRIC SHOCK, DO NOT USE THIS POLARIZED PLUG WITH AN EXTENSION CORD RECEPTACLE OR OTHER OUTLET UNLESS THE PRONGS CAN BE FULLY INSERTED INTO THE OUTLET TO PREVENT ANY EXPOSURE OF THE PRONGS ON THE POLARIZED PLUG.

ATTENTION:

POUR PRÉVENIR LES CHOC ÉLECTRIQUES, NE PAS UTILISER CETTE FICHE POLARISÉE AVEC UN PROLONGATEUR, UNE PRISE DE COURANT OU UNE AUTRE SORTIE DE COURANT, SAUF SI LES LAMES PEUVENT ÊTRE INSÉRÉS À FOND SANS EN LAISSER AUCUNE PARTIE À DÉCOUVERT.

Avoid displaying stationary images on your TV screen for extended periods of time. Stationary patterns generated by PIP display, computer displays, video games, stock market reports, etc. can become permanently engraved on the picture tube. This damage is not protected by your warranty as it is the result of misuse. Should you wish to use your TOSHIBA Television to display still images, it is always advisable to reduce brightness and contrast settings. Never leave a PIP display, computer display or video game display unattended.

NOTE TO CATV SYSTEM INSTALLER IN THE USA:

This reminder is provided to call the CATV system installer's attention to Article 820-40 of the NEC that provides guidelines for proper grounding and, in particular, specifies that the cable ground shall be connected to the grounding system of the building, as close to the point of cable entry as practical.

Table of Contents

Set Up

Installing Your TV Set	4
Antenna/Cable TV General Information	4
Antenna/Cable TV Connection	5
Antenna/Cable TV and VCR Connections	6

Preparation

Location of Controls (TV Set)	7
Location of Controls (Remote Control)	8
Before Using the Remote Control	9
Using the Remote with VCR or Cable TV	
Converter	10
Programming the Remote Control	11
Menu Function (General Instructions)	14
Selecting the Antenna Input	16
Programming Channel Memory	17

Basic Operation

Watching TV Programs	19
Convenient Remote Functions	20
Adjusting the Picture	22
Adjusting the Sound	23
Selecting Stereo/SAP Broadcasts	24
Enhancing the Surround Sound Effect	25

Advanced Operation

Watching Picture-in-Picture	26
Setting the Off-Timer (Sleep Timer)	28
Programming Your Favorite Channels	29
Locking Channels	30
Using Closed-Captioned Function	32
Labeling Channels	34
Changing On-Screen Display Language	36
Demonstration Mode	37

Equipment Connections

Connecting a Standard VCR	38
Connecting a VCR with an S-Video Jack	39
Connecting an Audio Amplifier	40

Reference Section

Cleaning and Care	41
Specifications	41
Before Calling Service Personnel	42
Limited United States Warranty	43

Installing your TV Set

Where to install

Place the TV on the floor or on a sturdy platform. The mounting surface should be flat and steady.

Lighting

Do not place the TV in a room where direct lighting strikes the screen. Use soft and indirect lighting.

Air circulation

Place the TV far enough from the walls to allow proper ventilation. This will prevent the TV from overheating and avoid possible damage to the TV. Avoid dusty places too.

Power supply

Plug into an electrical outlet with standard household power (120 volt AC, 60Hz). Do not change the plug's safety prong. See the right column.

WARNING :

TO AVOID PERSONAL INJURY

- Do not stand or climb on the TV.
- Do not put a VCR or any heavy object on top of the TV.

CAUTION :

As a safety feature, the plug has one prong wider than the other. It will fit only one way into a standard electrical outlet. If the plug will not fit into the outlet, try turning it around. If the plug will not fit either way, the outlet is probably old and non-standard.

You will need to have a new outlet installed by an electrician.

DO NOT CHANGE THE SAFETY FEATURE OF THE PLUG.

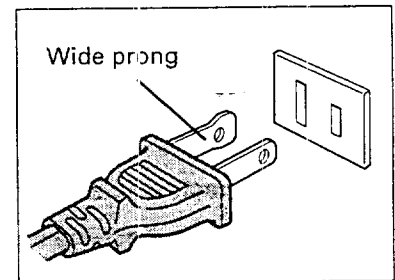

Antenna/Cable TV General Information

You can use either an indoor or outdoor antenna to receive VHF and/or UHF channels. Channels 2 - 13 are VHF channels, and channels 14 - 69 are UHF channels. We recommend using an outdoor antenna for better picture quality. You can receive Cable TV by connecting the cable supplied by your local cable company. Cable TV delivers both VHF and UHF channels and other channels not available to your antenna.

Types of antenna cables

Shown below are two basic types of antenna cables. Signals from a home antenna may be conveyed by either type. Cable TV signals will always be conveyed by a 75 ohm coaxial cable.

- 1 A 75 ohm coaxial cable is generally a round cable with an F-type connector that can easily be attached to a terminal without tools.

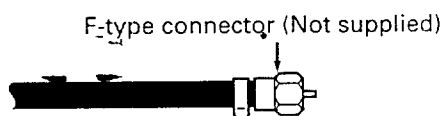

- 2 A 300 ohm cable is a flat "twin-lead" cable that can be attached to a terminal using an antenna adapter supplied as an accessory.

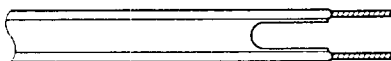

Antenna connection panel

There are two separate 75 ohm F-type connector terminals and a converter output terminal as shown below.

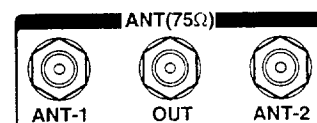

The ANT-1 and ANT-2 terminals are for connecting a VHF/UHF antenna or a cable TV system. The signal, which is input through the ANT-1 terminal, is also output from the OUT terminal whenever the antenna input is set to the ANT 2 mode. You can switch between the ANT 1 and ANT 2 modes by pressing the ANT 1/2 button on the Remote Control or the ANT/VIDEO button on the TV. See page 16.

Antenna/Cable TV Connection

Connecting an antenna or Cable without a decoder box

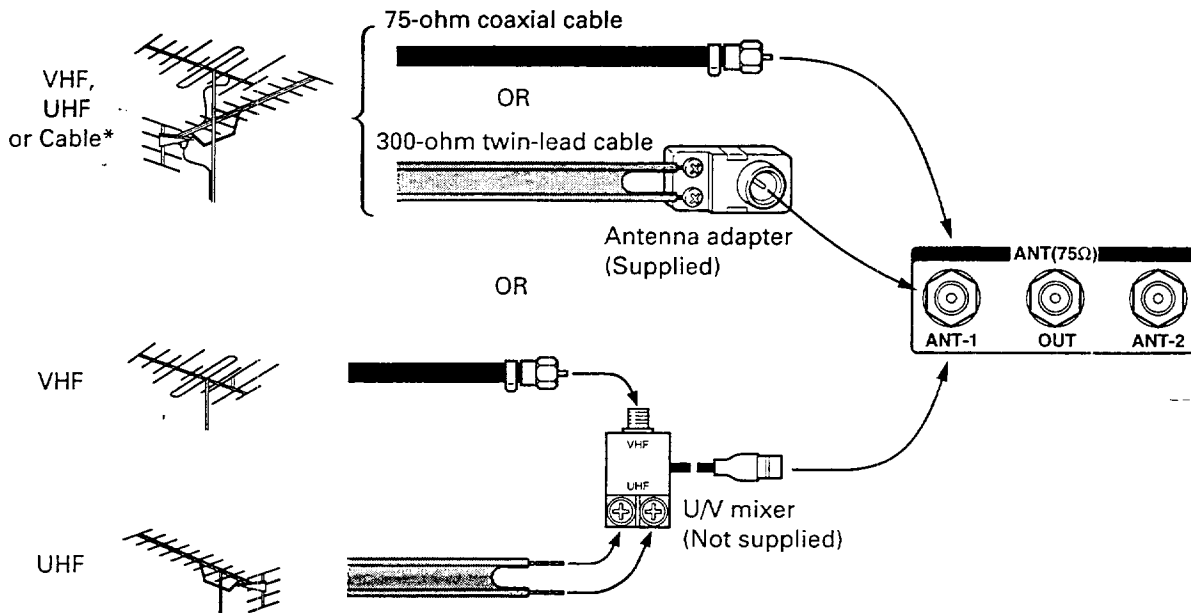

Notes:

- * Generally, the incoming cable for a Cable TV system can be connected directly to the TV antenna terminal just like a home antenna connection. You will be able to receive unscrambled cable channels.
- You can connect another source such as a home antenna or video game to the ANT-2 terminal.

Connecting a Cable with a decoder box

Some cable companies offer "premium pay channels". Since the signals of these premium pay channels are scrambled, a cable TV converter/decoder is generally provided to the subscriber by the cable TV company. This decoder box is necessary for normal viewing the scrambled channels. For more specific instructions on installing cable TV, consult your cable TV company.

You can choose between viewing unscrambled channels and scrambled channels by pressing the ANT 1/2 button or the ANT/VIDEO button. See page 16.

All channels including the unscrambled channels will come through the ANT-1 terminal when the "ANT 1" mode is selected.

All channels including the scrambled channels from the decoder box will come through the ANT-2 terminal when the "ANT 2" mode is selected. Select channel 3 or 4 on your TV to match your converter's output channel and select channels using the converter's channel keys.

Note: The descrambler device may or may not be a part of the cable converter.

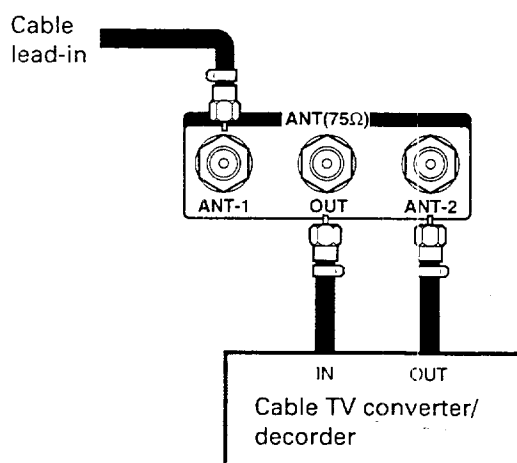

Antenna/Cable TV and VCR Connections

After antenna cable connections are made, you are still required to connect the VCR using a video/audio connecting cables for (stereo) playback of good quality from the VCR. See page 38.

Antenna/Cable TV connection via VCR (simplified method)

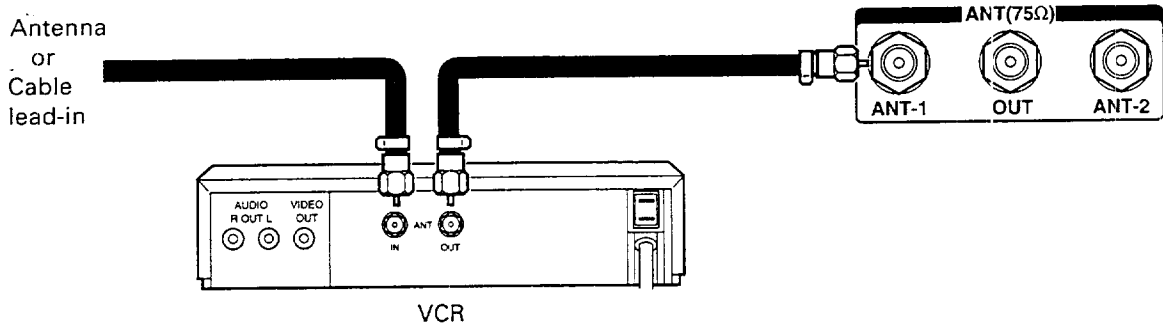

Note: On many VCR's, playing tapes causes the VCR's TV/VCR switching to disconnect the antenna signals from the TV. If you cannot select a certain channel, try pressing the TV/VCR button on the Remote Control.

Using a 2-way signal splitter

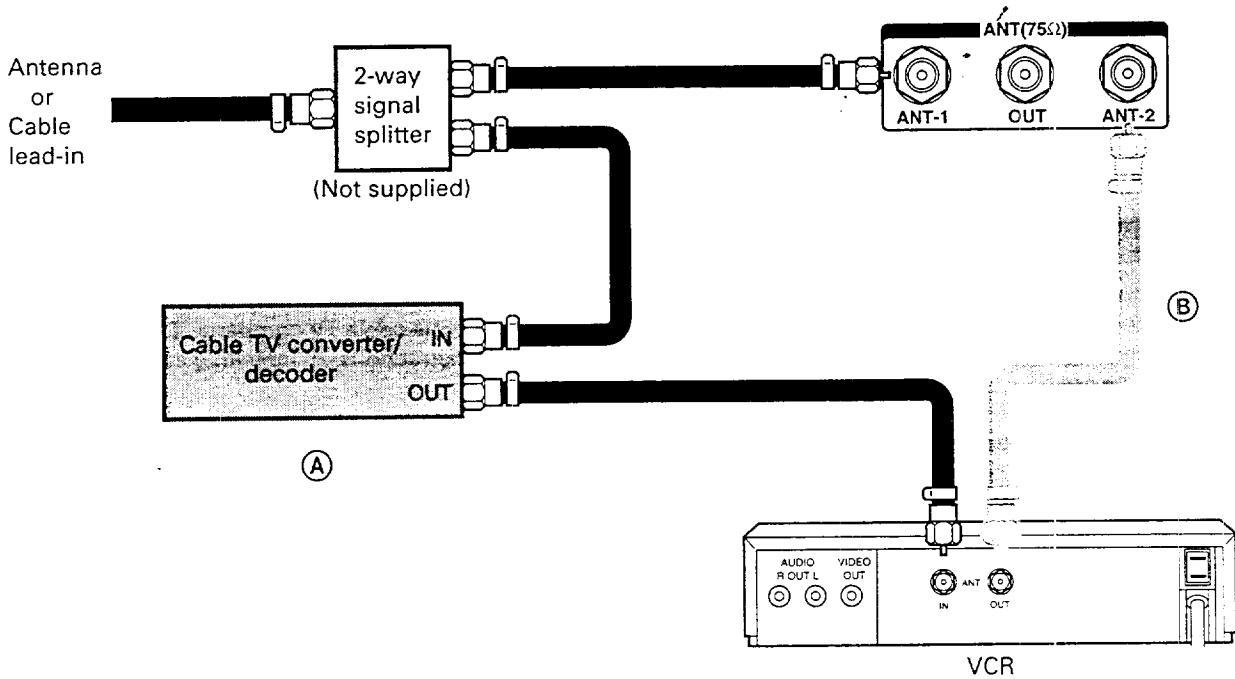

Notes:

- When connecting a cable TV converter/decoder (A):
All channels including the unscrambled channels will come through the ANT-1 terminal whenever the antenna input is set to the "ANT 1" mode.
All channels including the scrambled channels from the decoder box will come through the VCR and the ANT-2 terminal whenever the antenna input is set to the "ANT 2" mode. Select channel 3 or 4 on your TV and VCR to match your converter's output channel. See page 16.
- The cable (B) connection is necessary only when the cable TV converter/decoder (A) is connected.

Location of Controls (TV Set)

For specific use of each control, consult the corresponding page numbers in brackets.

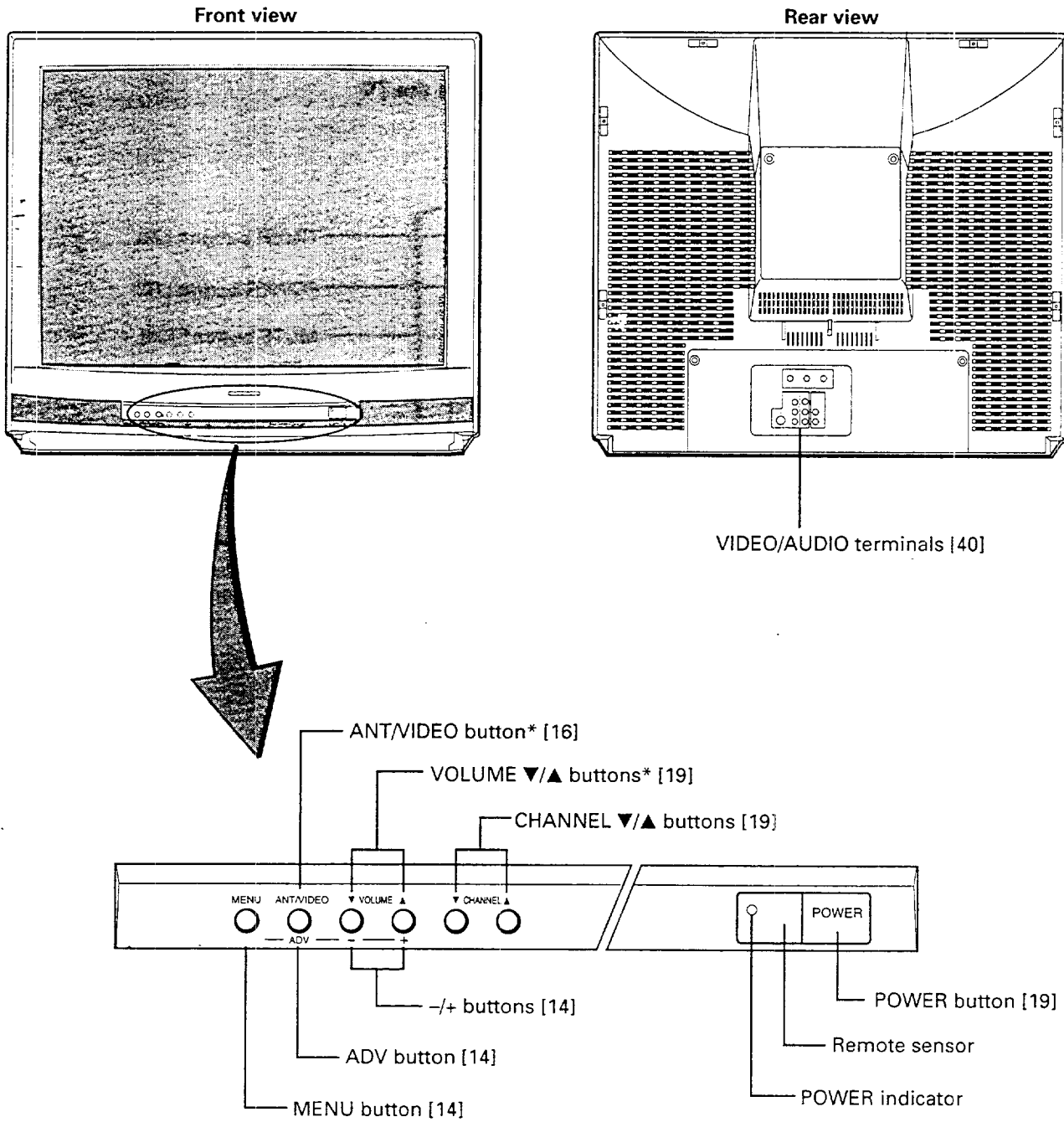

*Dual function buttons

SET UP

PREPARATION

Antenna/Cable TV and VCR Connections
Location of Controls (TV Set)

Location of Controls (Remote Control)

Only the buttons that are used to operate the TV set are described here.
For details on the use of each control, refer to pages in brackets.

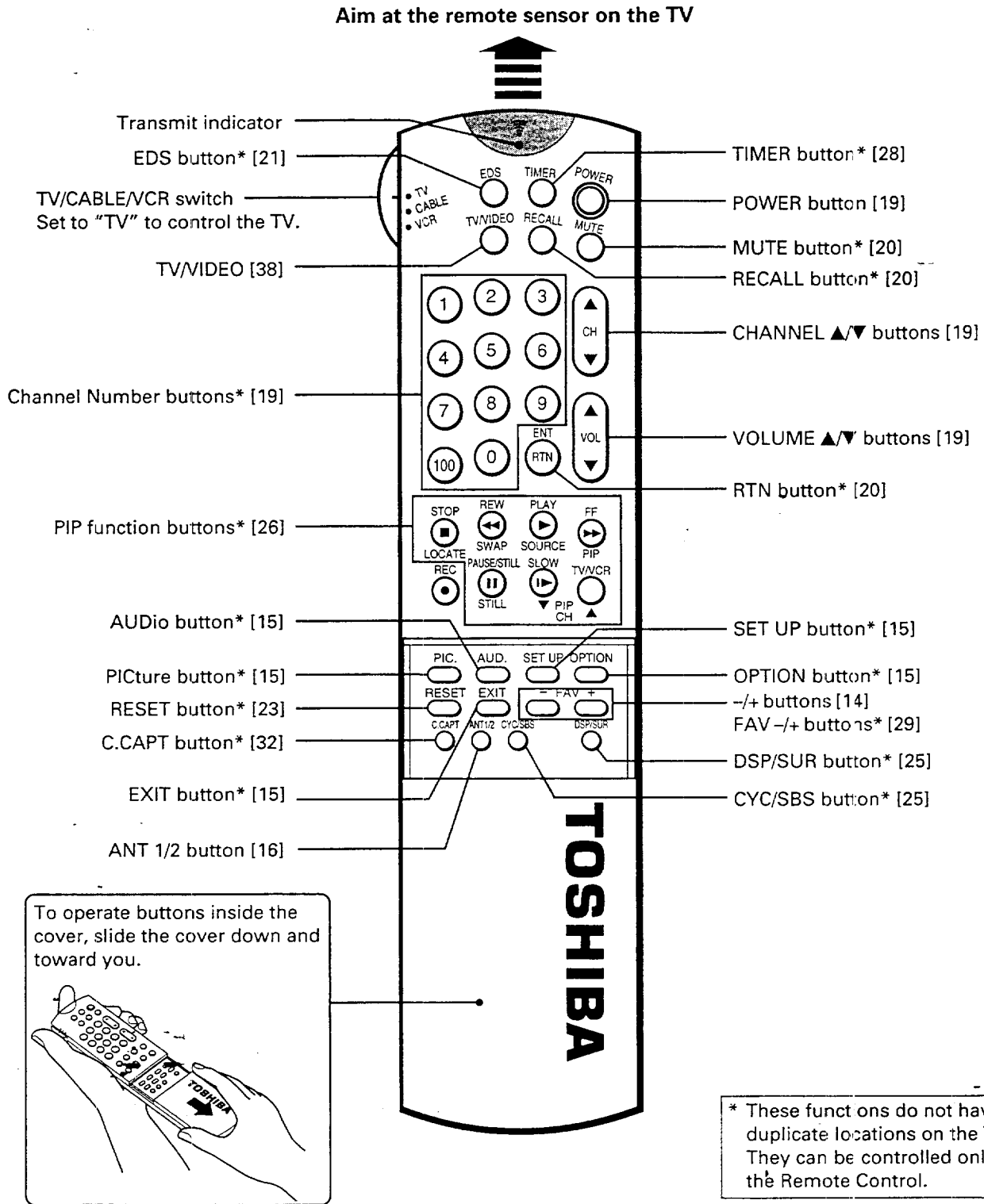

Before Using the Remote Control

Introductions

With this Remote Control, you can operate your TV and most models of remote-controlled VCR's and Cable TV converters even if they are different brands.

However, this Remote Control must be programmed to control other brands of VCR's and/or converters. If you will be using your TV set with a TOSHIBA VCR, your Remote Control has already been preprogrammed for you.

- Before attempting to operate your Remote Control, install the batteries according to the section "Installing and replacing batteries" shown below.
- For more detailed instructions, see the section "Programming the Remote Control" on page 11.

Notes:

- After installing new batteries, the Remote Control will set itself to the codes for TOSHIBA's TV and VCR. If you are using the Remote Control to operate equipment that uses different codes, it will have to be reprogrammed for those codes.
- This Remote Control may have functions not available on the original remote control.
- These functions may or may not operate your VCR or Cable TV converter. Refer to the owner's manuals supplied with the equipment to see which functions are available.
- The remote control supplied with your VCR or Cable TV converter may have keys not duplicated on this Remote Control. If these functions are desired, the original remote control will have to be used.

Installing and replacing batteries

- 1 Place the Remote Control with the face down. Press down on the ridged area of the battery cover and slide it off.

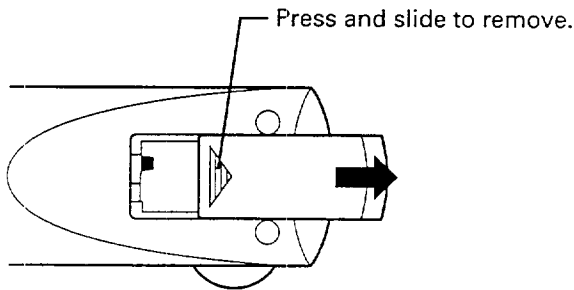

- 2 Place two "AA" size batteries, matching the + and - signs on each battery to the + and - signs of the battery compartment.

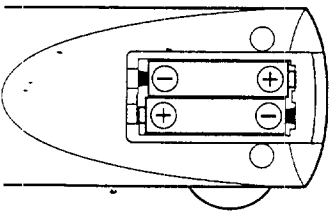

- 3 Replace the battery cover until the lock snaps.

CAUTIONS:

- Do not throw your batteries into a fire. Dispose of your batteries in a designated disposal area.
- Do not combine used old batteries with new ones.
- Do not mix battery types.

Tips for best operation

- For optimum performance, aim the Remote Control directly at the TV from a distance no more than 16 ft (5m) and be sure there is no obstruction between the Remote Control and the TV.
- If your Remote Control does not always control the TV as you wish, you probably need to replace the batteries.
- Remove dead batteries immediately to prevent battery acid from leaking into the battery compartment.
- If you do not intend to use the Remote Control for a long period, remove the batteries.

Using the Remote with VCR or Cable TV Converter

- To control a TOSHIBA VCR, first set the TV/CABLE/VCR switch to VCR. The buttons shown below will then control the VCR. The rest of the buttons operate the TV as usual.
If you have another brand of VCR, you can probably program the Remote Control to control it.
Details are on page 11.
- To control a cable TV converter, this Remote Control must be programmed to recognize the brand of your converter.
See page 11.
Set the TV/CABLE/VCR switch to CABLE whenever you want to control the cable TV converter.

Aim at the VCR or cable TV converter

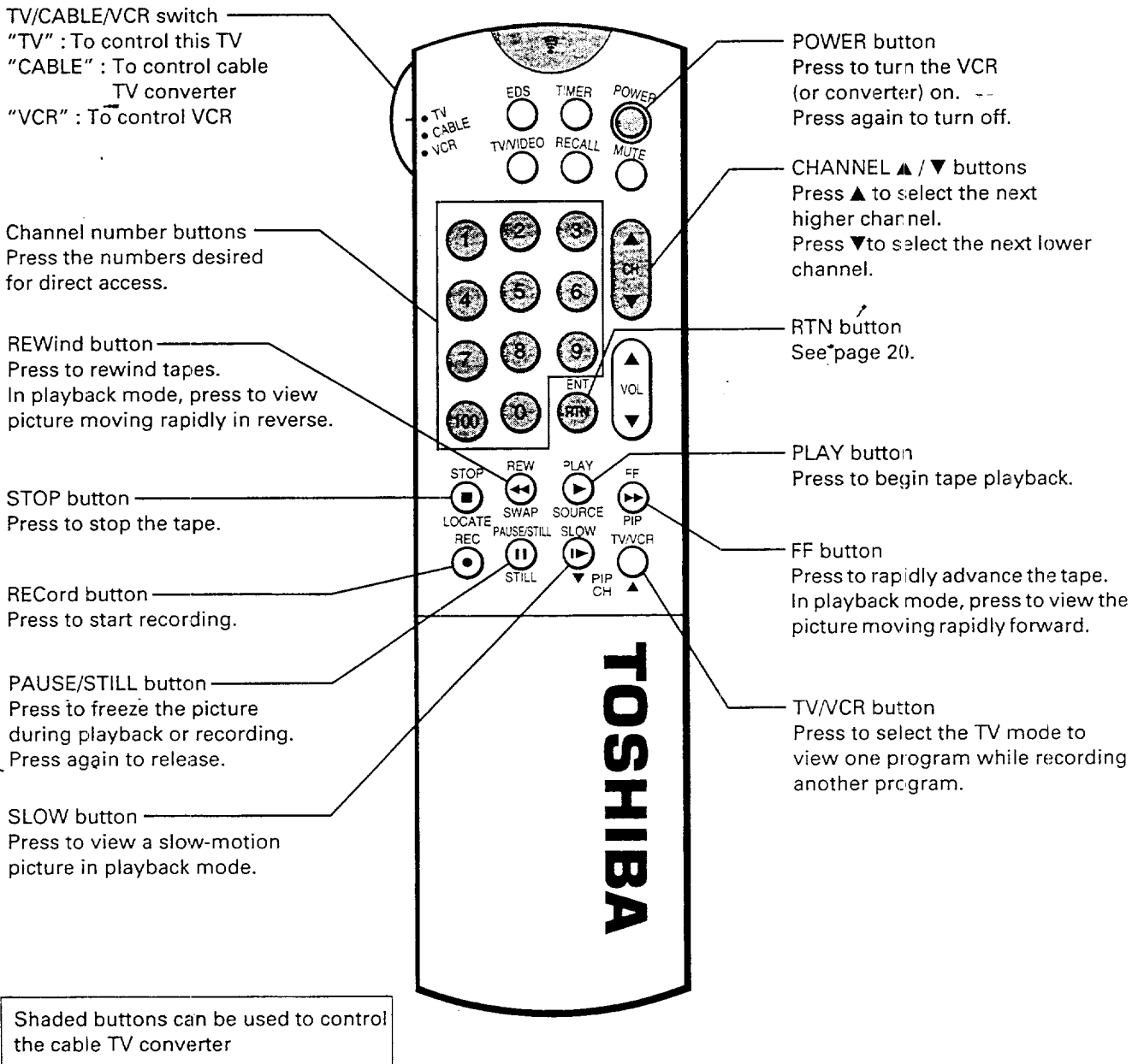

Programming the Remote Control

- This Remote Control is preprogrammed to operate TOSHIBA VCRs.
- To use VCRs other than TOSHIBA models (or Cable converter), perform the following procedures before operating.

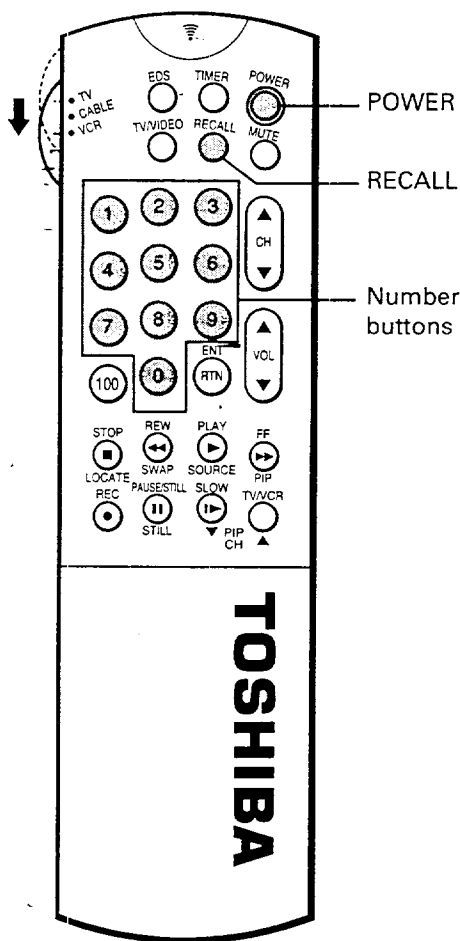

Controlling other brands of VCR's and cable TV converters

- 1 Refer to the "VCR code table" (or "Cable TV converter code table") on pages 14 and 15 to find the code number that corresponds to the brand name of your VCR (or your converter).

If more than one number is listed, try each one separately until you find the one that works.

- 2 Set the TV/CABLE/VCR switch to "VCR" (or "CABLE").

- 3 Hold down **RECALL** while pressing the **Number** buttons for the three digit code number for your brand of VCR (or converter). -- The transmit indicator lights up for 1 second when the programming is completed.

When an operation error has occurred, the indicator blinks. Press **RECALL** again to reset.

- 4 Point the Remote Control at the VCR (or at the converter) and press **POWER** to test the code number.
 - If the right number was entered, the VCR (or the converter) should turn on.
 - If the VCR (or the converter) does not respond to the Remote Control, repeat steps 1 to 4 with another code number.

Notes:

- You have to reprogram the Remote Control when you change its batteries.
- Some newer VCR's are capable of working on either of two remote codes. These VCR's have a switch labeled "VCR1/VCR2". If your VCR has this kind of switch, and does not respond to any of the code numbers for your VCR brand name, set the switch to another position ("VCR1" or "VCR2") and reprogram the Remote Control.

For future reference, write the code you used.

VCR CODE: _____

CABLE CODE: _____

Programming the Remote Control (Continued)

◆ In some rare cases, you may not be able to operate your non-TOSHIBA equipment with the supplied Remote Control. This is because your equipment may use a code that is not provided with this Remote Control. In this case, please use the equipment's own remote control.

VCR code table

BRAND NAME	CODE NUMBER		
Adventura	019	Ferguson	060
Aiko	297	Fidelity	019
Aiwa	019	Finlandia	100,123,129
Akai	060,068,080,125	Finlux	019,061,100,123
	261	Firstline	056,062,064,091
Akiba	091		228
Alba	039,228,297,314	Fisher	065,066,073,085
American High	054		123
Amstrad	019	Frontech	039
Anam	181	Fuji	052,054
Anitech	091	Funai	019
ASA	056,100	Garrard	019
Asha	259	GE	054,079,084,221
Asuka	056	GEC	100
Audiovox	056	General	071
Baird	019,123	Go Video	251,298
Basic Line	039,091,297	Goldstar	056,057
Beaumarck	259	Goodmans	019,039,056,081
Bell & Howell	123		091,297
Blaupunkt	053,181	Gradiente	019
Brandt	206	Graetz	060,123
Broksonic	140,203,230,380	Granada	065,100,123
Bush	091,228,297	Grandin	019,056,091
Calix	056	Grundig	100
Canon	054	Harley Davidson	019
Capehart	039	Harman/Kardon	057
Carver	100	Harwood	091
CCE	091,297	Hcm	091
CGE	019	Headquarter	065
Cimline	091	Hi-Q	066
Citizen	056,297	Hinari	091,227
Clatronic	039	Hitachi	019,060,061,084
Colt	091	Hypson	091
Condor	039	Imperial	019
Craig	056,066,091,259	Interfunk	100
Crown	091,297	ITT	060,065,123,125
Curtis Mathes	054,079	ITV	056,297
Cybernex	259	JCL	054
Dae'woo	039,064,065,297	Jensen	060
Dansai	091	JVC	027,060,086
Daytron	039	Kaisui	091
De Graff	061	Kendo	125,228
Decca	019,100	Kenwood	057,060,065,086
Dual	060	KLH	091
Dumont	019,100,123	Kodak	054,056
Dynatech	019	Korpel	091
Elcotech	091	Leyco	091
Electrohome	056	Lloyd	019
Electronic	019	Loewe	056
Electrophonic	056	Loewe opta	100
Emerex	051	Logik	091,259
Emerson	019,021,056,062	Luxor	062,065,123,125
	080,140,203,227	LXI	056
	228,230,231,313	M-Electronic	019
	314,380	Magnavox	019,054,058,100
ESC	297		129,168
		Magnin	259
		Manesth	064,091
		Marantz	054,057,081,100
		Marta	056
		Masushita	054
		Matsui	227,228,314
		MEI	054
		Memorex	019,054,056,058
			065,066,067,123
			259
		Memphis	091
		Metz	181
		MGA	062,080
		MGN Technology ..	259
		Minolta	061
		Mitsubishi	062,080,086,100
			233,261
		Motorola	054,067
		MTC	019,259
		Multitech	019,091
		Murphy	019
		NEC	057,059,060,069
			086
		Neckermann	100
		Nesco	091
		Nikko	056
		Noblex	259
		Nokia	060,065,123,125
			259
		Nordmende	060
		Oceanic	019
		Olympus	054
		Optimus	056,067
		Optonica	067,081
		Orion	140,227,228,314
		Osaki	019,056,091
		Otto Versand	100
		Palladium	056,091
		Panasonic	054,096,115,181
			244
		Penney	054,056,057,059
			061,073,259
		Pentax	061,084
		Perdio	019
		Philco	054
		Philips	054,081,100,129
		Phonola	100
		Pilot	056
		Pioneer	086,100
		Portland	039
		Profitronic	259
		Proline	019
		Protec	091
		Pulsar	058
		Pye	100
		Quarter	065
		Quartz	065
		Quasar	054,096,115
		Quelle	100
		Radio Shack	019,056

Radiola	100
Radix	056
Randex	056
RCA	054,061,079,084 096,115,125,168 221
RCA-Unified	079
Realistic	019,054,056,065 066,067,081,085 123,259
Rex	060
Ricoh	053
Roadstar	056,091,259,297
Runco	058
Saba	060
Saisho	227,228
Salora	062,065,125
Samsung	064,259
Sanky	058,067
Sansui	060,086
Sanyo	065,066,123,259
SBR	100
Schaub Lorenz	019,060
Schneider	019,091,100,129
Scott	062,064,140,203 229,230,231
Sears	054,056,061,065 066,073,085,123
SEG	259
SEI	100
Seleco	060
Sentra	039
Sharp	067,081
Shintom	091
Shogun	259
Siemens	056,123
Silva	056
Singer	091
Sinudyne	100
Sontec	056
Sony	051,052,053,054
STS	061
Sunstar	019
Sylvania	019,054,062,100 129
Symphonic	019
Tandy	019,123
Tashiko	019
Tatung	019,060,100
Teac	019,060
Technics	054,181
Teknika	019,054,056,071
Teleavia	060
Telefunken	060,206
Tenosal	091
Tensai	019
Thomson	060
Thorn	060,123

TMK	227,259
Toshiba	060,062,064,085 229,231,385
Totevision	056,259
Triumph	227
Unitech	259
Universum	019,056,068,100 125
Vector	064
Vector Research	057,059
Victor	027,060,086
Video Concepts	059,064,080
Videosonic	259
Wards	019,054,061,066 067,081,091,168 231,259
XR-1000	019,054,091
Yamaha	057,060
Yamishi	091
Yokan	091
Yoko	039,259
Zenith	052,053,058

Popular	
Mechanics	419
Pulsar	019
PVP Stereo	
Visual Matrix	022
RCA	040
Regal	039,278,292
Regency	021
Rembrandt	030,089
Runco	019
Samsung	059,163
Scientific Atlanta	025,027,036,296 346
Signal	034,059
Signature	030
SL Marx	059
Sprucer	040
Standard	
Components	174
Starcom	022,034
Stargate	034,059
Starquest	034
STS	175
Televue	059
Tocom	031,032,078
Toshiba	019
Tusa	034
Unika	172
United Artists	026
United Cable	022
Universal	058,096,172,210
Viewstar	046,079
Zenith	019

Cable TV converter code table

BRAND NAME	CODE NUMBER
ABC	022,026,030,032 033,036
Archer	058,172
Century	172
Citizen	172
Colour Voice	044,050
Comtronics	059,079
Contec	038
Eastern	021
Garrard	172
Gemini	034,089
General	
Instrument	030
Hamlin	028,039,278,292
Hitachi	030
Hytex	026
Jasco	172
Jerrold	022,030,031,033 034,043,045,295
Macom	052
Magnavox	046
Memorex	019
Movie Time	175
NSC	089,175
Oak	026,038
Panasonic	040
Paragon	019
Philips	044,046,047,048 049,050,079,172
Pioneer	163

Menu Function (General Instructions)

We suggest you familiarize yourself with the procedure before using the Menu function.

To adjust any TV feature, the use of the Menu function is required. The adjustments that can be made to the TV appears on the screen.

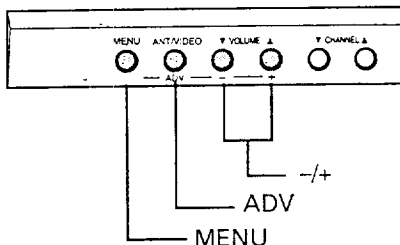

MENU button (on TV)

Each time you press **MENU**, the Picture, Audio, Set up or Option menu on-screen display is selected in order, then press **ADV**.

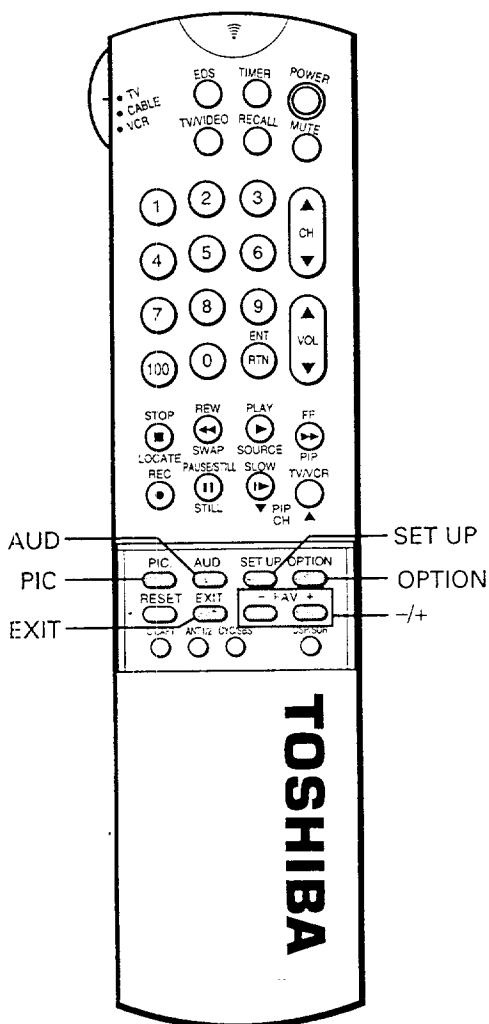
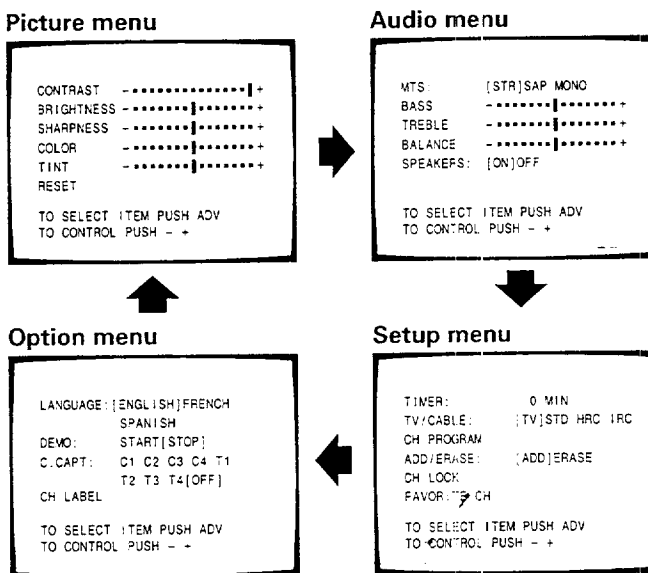

ADV button (on TV)

Use **ADV** after you have selected the on-screen menu you want to adjust with the **MENU** button.

Each time you press **ADV**, the function to be adjusted will be selected in order.

The selected function will be displayed in magenta.

-/+ buttons (on TV and on Remote)

Use -/+ to adjust the function you have selected with the **ADV** button or any of the four menu buttons (**PIC**, **AUD**, **SET UP** or **OPTION**; see the next page).

Notes:

- The **ADV** button on the TV will function as the **ANT/VIDEO** button when no menu display is on the screen.
- The -/+ buttons on the TV will function as the **VOLUME** ∇/\blacktriangle buttons when no menu display is on the screen.
- The -/+ buttons on the Remote Control will function as the **FAV** -/+ buttons when no menu display is on the screen.

PIC (Picture) button (on Remote)

Press **PIC** repeatedly until one of the Picture menu functions you want to adjust is selected.

The selected function will be displayed in magenta, then press **-/+** to adjust the setting.

Details for each function begin on page 22.

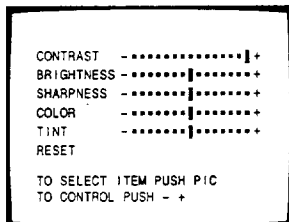

AUD (Audio) button (on Remote)

Press **AUD** repeatedly until one of the Audio menu functions you want to adjust is selected.

The selected function will be displayed in magenta, then press **-/+** to adjust the setting.

Details for each function begin on page 23.

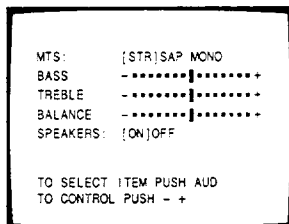

SET UP button (on Remote)

Press **SET UP** repeatedly until one of the Set up menu functions you want to adjust is selected.

The selected function will be displayed in magenta, then press **-/+** to adjust the setting.

Details for each function begin on page 17.

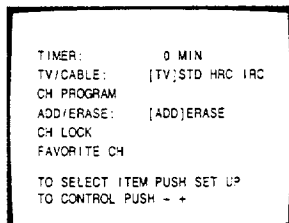

OPTION button (on Remote)

Press **OPTION** repeatedly until one of the Option menu functions you want to adjust is selected.

The selected function will be displayed in magenta, then press **-/+** to adjust the setting.

Details for each function begin on page 32.

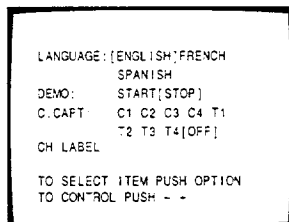

EXIT button (on Remote)

The above four menu displays will automatically disappear from the screen if no control has been operated for about 15 seconds, and all other menu displays also disappear after about 6 seconds.

If you want to clear the screen of all on-screen displays instantly, press **EXIT**.

Selecting the Antenna Input

Your TV has two separate antenna inputs (ANT-1 and ANT-2) that allow you to connect two different signal sources, if desired.

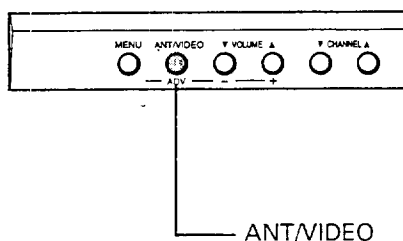

Using the ANT 1/2 button (on the Remote)

Each time you press the **ANT 1/2** button, the ANT 1 mode and ANT 2 mode will alternate. The selected mode will be displayed in magenta to show which antenna source you are watching. Select the mode that matches the antenna terminal you want to use.

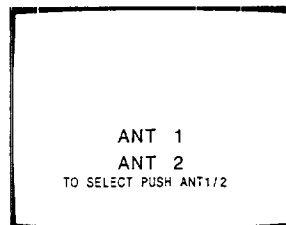

Note: This button does not function in the VIDEO mode.

Using the ANT/VIDEO button (on the TV)

Each time you press the **ANT/VIDEO** button, the ANT 1, VIDEO 1, VIDEO 2 or ANT 2 mode will be selected in order. The selected mode will be displayed in magenta to show which signal source you are watching. Press the button until "ANT" 1 or "ANT 2" is displayed in magenta to match the antenna terminal you want to use.

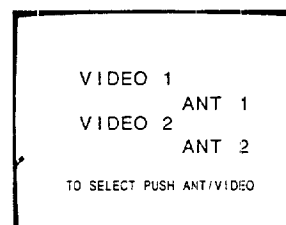

Note: This button functions as the ADV button while any of four menu displays (Picture, Audio, Setup or Option) is on the screen.

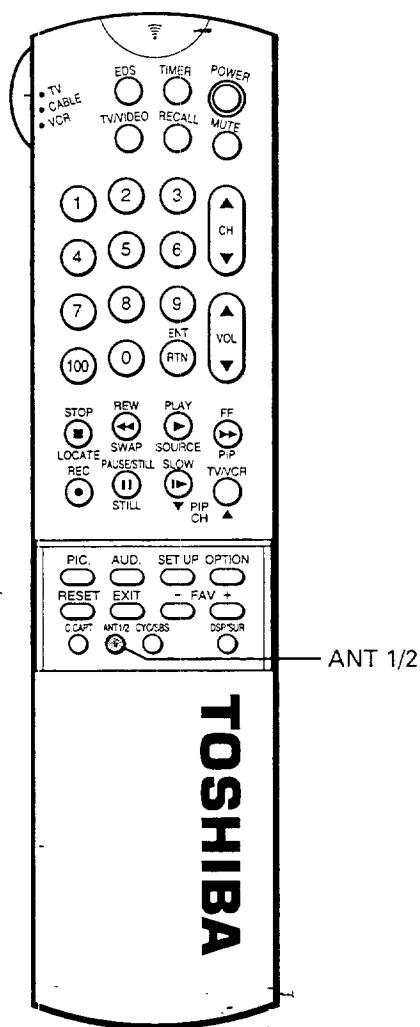

Programming Channel Memory

The channel memory is the list of TV channel numbers your TV will stop on when you press the CHANNEL ▲ or ▼ button. **First, use the TV/CABLE and CH PROGRAM functions to preset all active channels in your area automatically.** If necessary, arrange the preset channels with the ADD/ERASE functions so that you can tune into only desired channels. **Note:** If you utilize both ANT-1 and ANT-2 terminals, perform programming channels for each input source.

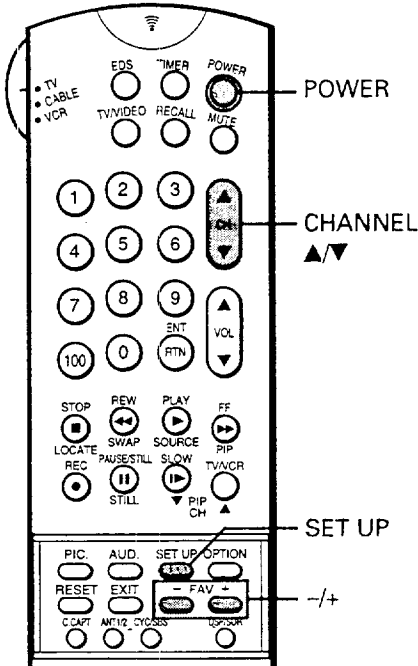
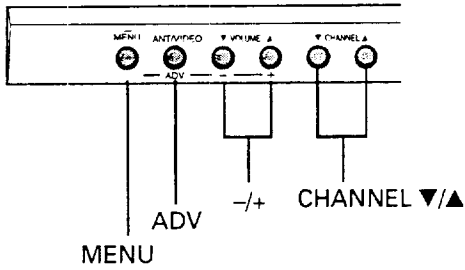

TV/CABLE function

- 1 Press **POWER** to turn on the TV.
- 2 Press **SET UP** on the Remote Control (or **MENU** on the TV) to display the Setup menu.
- 3 Press **SET UP** repeatedly (or **ADV** on the TV) until "TV/CABLE" is displayed in magenta.
- 4 Press - or + until the mode that corresponds to your TV signal system is displayed in magenta. Each time you press the button, the TV*, STD*, HRC* or IRC* mode will be selected in order.

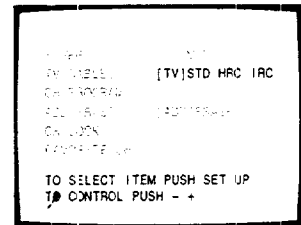
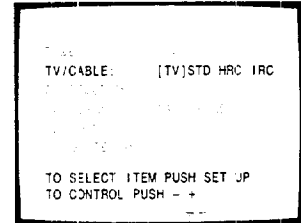

CH PROGRAM function

- 1 Select "CH PROGRAM" following steps 2 and 3 above.
- 2 Press - or + to start channel programming. The TV will automatically cycle through all the TV or CABLE channels on the mode selected by the TV/CABLE function, and store active channels in the channel memory.
- 3 When channel programming is complete, you will see the message at the right.
- 4 Press **CHANNEL ▲** or **▼** to make sure the channel programming has been done properly.

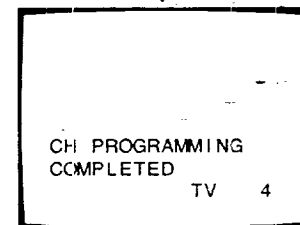
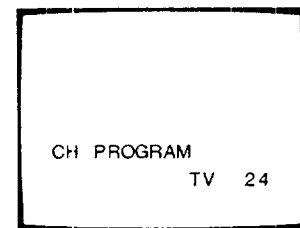
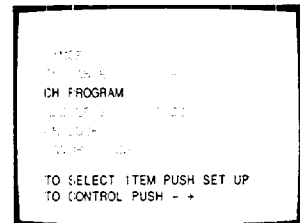

* This TV receives the following TV signals:

1. **TV:** TV broadcasts signals. (VHF channels 2 through 13 and UHF channels 14 through 69)
2. **STD CABLE:** Standard cable TV signals.
3. **HRC CABLE:** Harmonic Related Carrier cable TV signals.
4. **IRC CABLE:** Incremental Related Carrier cable TV signals.

If you are not sure what CABLE system they are using, consult your local cable company.

Programming Channel Memory (Continued)

ADD/ERASE function

After performing the CH PROGRAM function, you can add or erase specific channels.

1 Select the channel you want to erase using the **CHANNEL ▲** or **▼** button, or select the channel you want to add using the **Channel Number** buttons.

2 Press **SET UP** on the Remote Control (or **MENU** on the TV) to display the Setup menu.

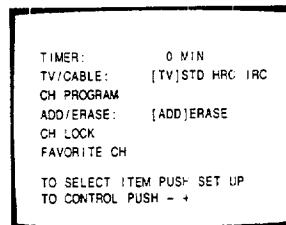

3 Press **SET UP** repeatedly (or **ADV** on the TV) until "ADD/ERASE" is displayed in magenta.

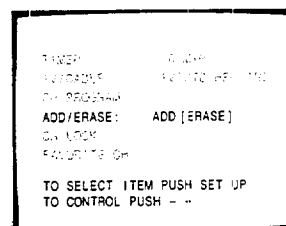

4 Press **-** or **+**:
To erase the channel
 Press the button until "ERASE" is displayed in magenta indicating that the channel has been erased from the memory.
To add the channel
 Press the button until "ADD" is displayed in magenta indicating that the channel has been memorized.

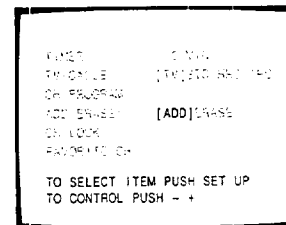

5 Repeat steps 1 to 4 for other channels.

You have now completed the channel programming.

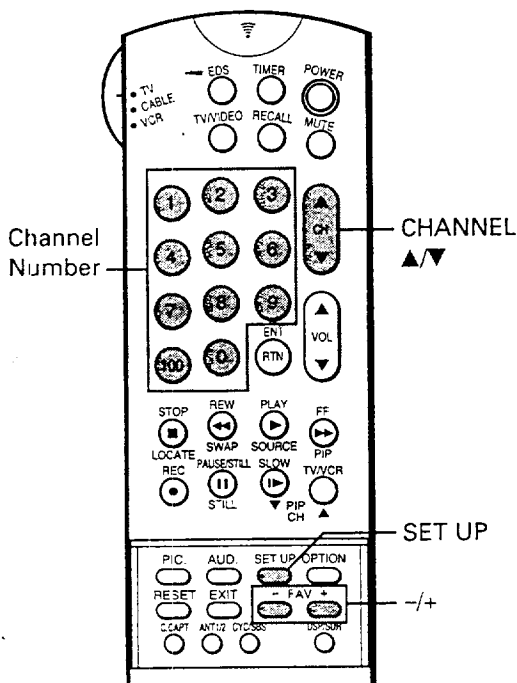
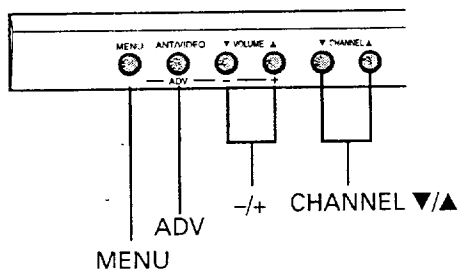

CABLE channel reference chart

Number on this TV	1	5	6	14	15	16	34	35	36	37	38	60	61	62	63	64	65	66
Corresponding CABLE channel	A-8	5(A-7)	6(A-6)	A	B	C	U	V	W	AA	BB	XX	YY	ZZ	AAA	BBB	65	-66
Number on this TV	67	68	69	92	93	94	95	96	97	98	99	100	101	102	123	124	125	
Corresponding CABLE channel	67	68	69	92	93	94	A-5	A-4	A-3	A-2	A-1	100	101	102	123	124	125	

The above chart is typical of many cable system channel allocations. If in doubt, consult your cable company.

Watching TV Programs

- First set the TV/CABLE/VCR switch on the Remote Control to the "TV" position.

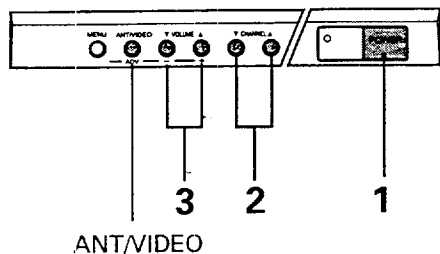

- 1 Press **POWER** to turn on the TV.
The following on-screen information will be displayed for a few seconds.

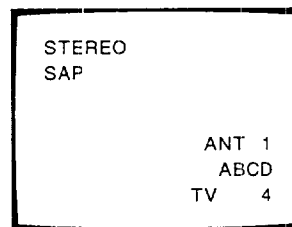

- Antenna mode (when in the TV mode).
- Channel number or the VIDEO mode selected.
- Channel label (if previously preset).
- Stereo or SAP audio status.

To turn off the TV, press **POWER** again.

- 2 Select a channel in one of the following two ways.
 - **To scan the memorized channels in numerical sequence**
Press **CHANNEL ▲** to select the next higher channel.
Press **CHANNEL ▼** to select the next lower channel.
Press the button again to select the next memorized channels.

- **To select a channel directly**
Press the **Channel Number** buttons (0-9 and 100).
To select channel 4, press "4" (or press "0", "4").
To select channel 38, press "3", "8".
To select channel 125, press "100", "2", "5" in sequence.

If you cannot select certain channels, either TV (off the air) or CABLE channels
Check if the TV/CABLE function is properly set. See page 17.

- 3 Press **VOLUME ▲/▼** to adjust the volume.
To increase the volume, press **▲**.
To decrease the volume, press **▼**.

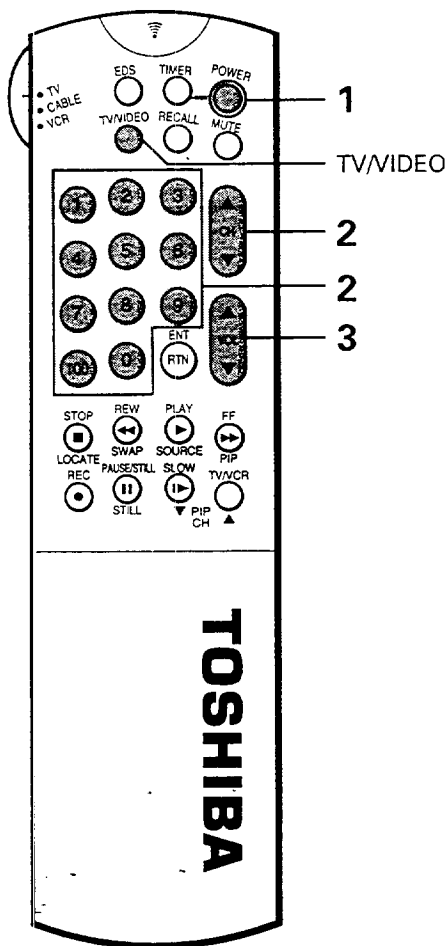
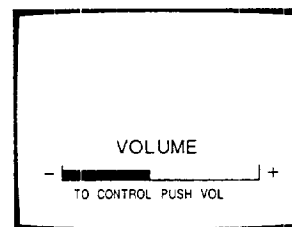

Notes:

- The **VOLUME ▼/▲** buttons on the TV function as the **-/+** buttons while any of the menu displays (Picture, Audio, Setup or Option) is on the screen.
- The **ANT/VIDEO** button on the TV functions as the **ADV** button while any of the menu displays (Picture, Audio, Setup or Option) is on the screen.

Watching Video Input

The **TV/VIDEO** button (or **ANT/VIDEO** button on the TV) is used to view the signals coming from other devices such as VCR's or Video Disc Players connected to this TV.
Details are on page 38.

Auto-Power-Off

If a vacant channel is tuned or TV broadcast for a day is finished, the TV will automatically turn off after about 15 minutes.
This feature does not operate in the VIDEO mode.

Last Mode Memory

If the power is cut off while you are viewing the TV and the power is resupplied, the TV is turned on automatically by the **Last Mode Memory** feature. If the power is going to be off or when you leave home for a long time, remove the power plug from the wall outlet to prevent the TV from turning on in your absence.

Convenient Remote Functions

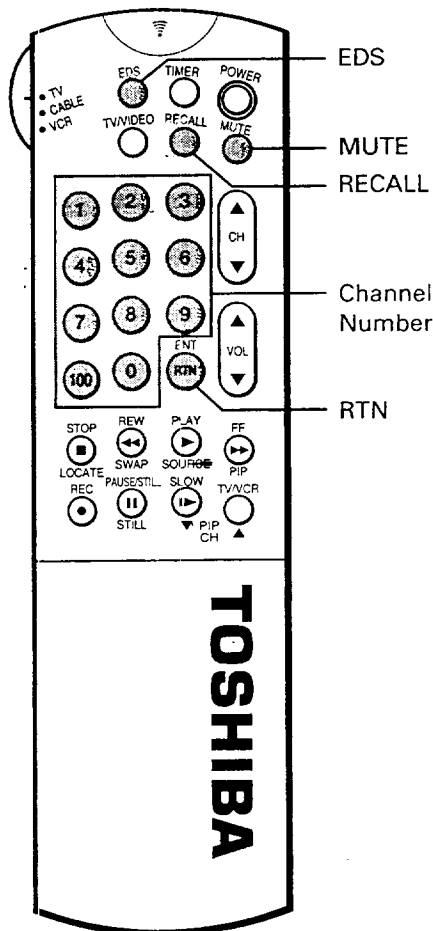

Displaying on-screen information

Press **RECALL** to display the following on-screen information.

- Antenna mode (when in TV mode)
- Channel number or VIDEO mode selected
- Channel label (if previously preset)
- Stereo or SAP audio status
- Closed Caption or Text program status

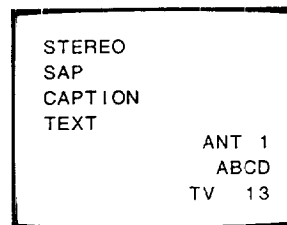

Muting the sound

Press **MUTE** to mute the sound. The word "MUTE" will be displayed on the screen as shown. This is useful during telephone calls or other interruptions.

To restore the sound, press **MUTE** again.

Note: When the MUTE button is pressed, the Closed-Captioned feature "C1" is activated. ("MUTE" on the screen display will disappear.) To deactivate, press the MUTE button again. (This feature only functions when the Closed Caption mode is set to "OFF".)

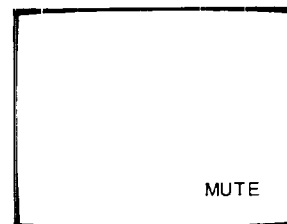

Changing quickly between two channels

Press **RTN** to return to the last channel viewed.

This is useful should you want to view two channels. This allows you to view two programs without entering an actual channel number each time.

To operate this function

- 1 Select the first channel you want to watch.
- 2 Select the other channel with the **Channel Number** buttons.
- 3 Press **RTN**.
The previous channel will return.

Each time you press **RTN**, the TV will switch back and forth between the two channels.

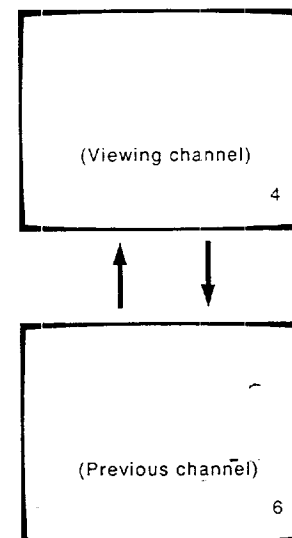

To display the EDS information

Press **EDS** to display the following EDS (Extended Data Service) information for about 10 seconds.

- Network name ①
- Program name ②
- Program type ③
- Time in show ④
- Program length ⑤

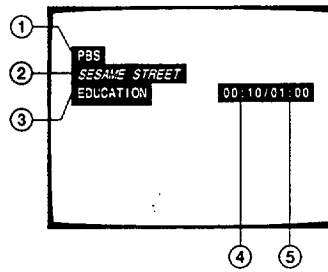

Some of the above information may not be displayed.

If the TV program you are watching does not include the EDS information

"NO EDS INFORMATION" will be displayed instead for about 10 seconds when you press **EDS**.

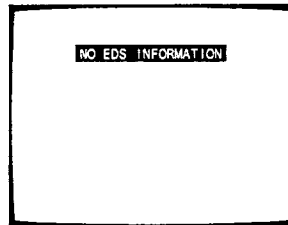

Adjusting the Picture

You can adjust the picture quality (CONTRAST, BRIGHTNESS, COLOR, TINT and SHARPNESS) to suit your taste.

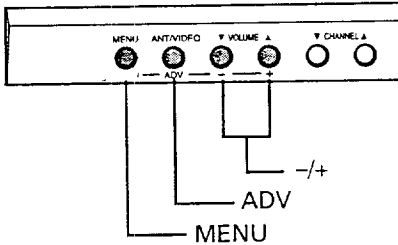

Adjusting the picture quality

- 1 Press **PIC** on the Remote Control (or **MENU** on the TV) to display the Picture menu.
- 2 Press **PIC** repeatedly (or **ADV** on the TV) until the item you want to adjust is displayed in magenta.
- 3 Press **-** or **+** to adjust the level.

Example: CONTRAST adjustment mode display

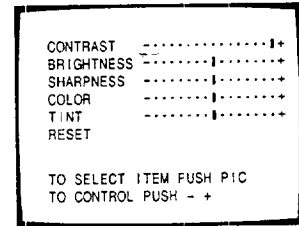
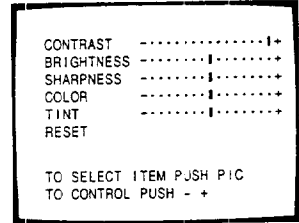

Selection	Pressing	
	-	+
CONTRAST	lower	higher
BRIGHTNESS	darker	lighter
SHARPNESS	softer	sharper
COLOR	paler	deeper
TINT	reddish	greenish

To reset the Picture adjustment to the factory-preset level (maximum CONTRAST and all other adjustments centered)

- 1 Press **PIC** on the Remote Control (or **MENU** on the TV) to display the Picture menu.
- 2 Press **PIC** repeatedly (or **ADV** on the TV) until "RESET" is displayed in magenta.
- 3 Press **-** or **+**.

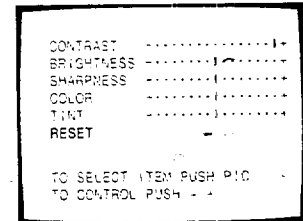
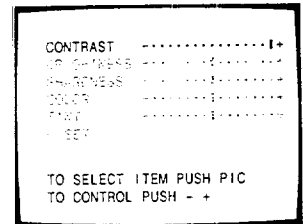

Note: You can also use the RESET button on the Remote Control. (See page 23.)

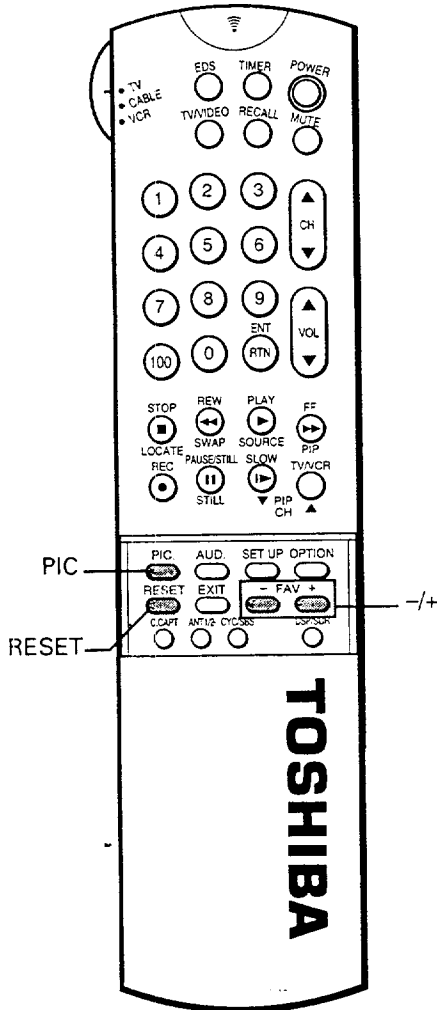

Adjusting the Sound

You can adjust the sound quality (BASS, TREBLE and BALANCE) to suit your taste.

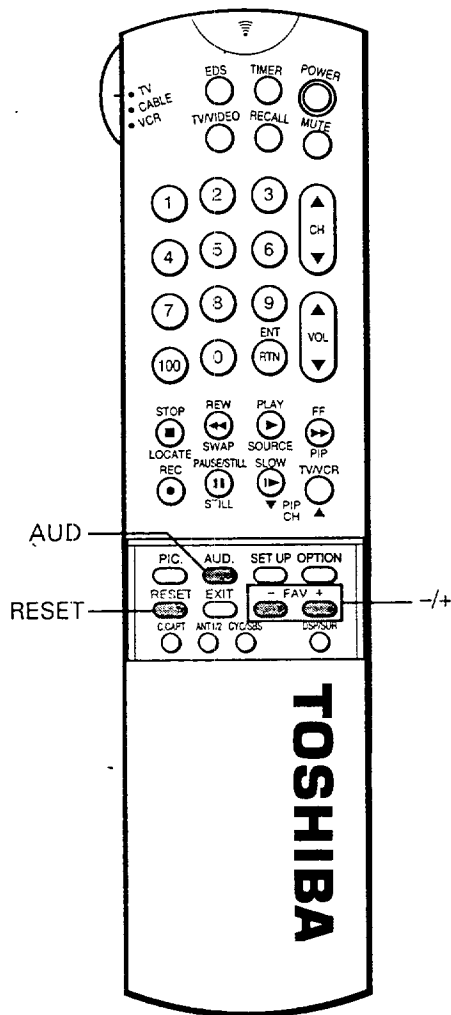
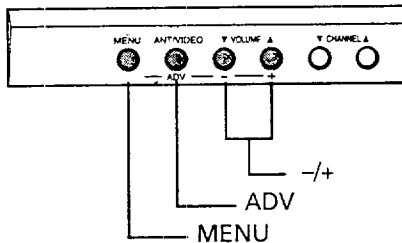

Adjusting the sound quality

- 1 Press **AUD** on the Remote Control (or **MENU** on the TV) to display the Audio menu.
- 2 Press **AUD** repeatedly (or **ADV** on the TV) until the item you want to adjust is displayed in magenta.
- 3 Press **-** or **+** to adjust the level.

Example: BASS adjustment mode display

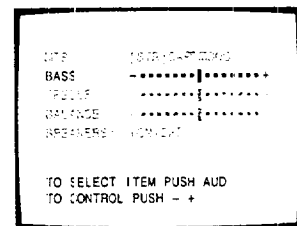
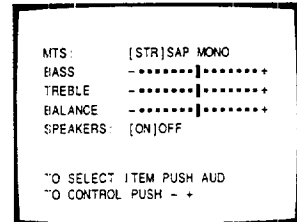

Selection	Pressing	
	-	+
BASS	weaker	stronger
TREBLE	weaker	stronger
BALANCE	decreases the right channel	decreases the left channel

RESET button (on the Remote Control)

To reset the Picture and Audio adjustments to the factory-preset level (maximum CONTRAST and all other adjustments centered)

Press **RESET**.

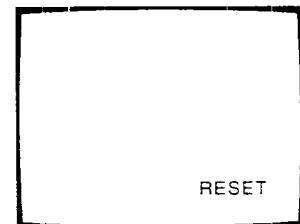

Note: There are some other items in the Audio menu — MTS and SPEAKERS. To use these function, see pages 24 and 40.

Selecting Stereo/SAP Broadcasts

The MTS (Multi-channel TV Sound) feature allows you to improve your TV viewing with high fidelity stereo sound. MTS also provides for an extra channel, SAP (Second Audio Program), used to transmit a second language or other audio information.

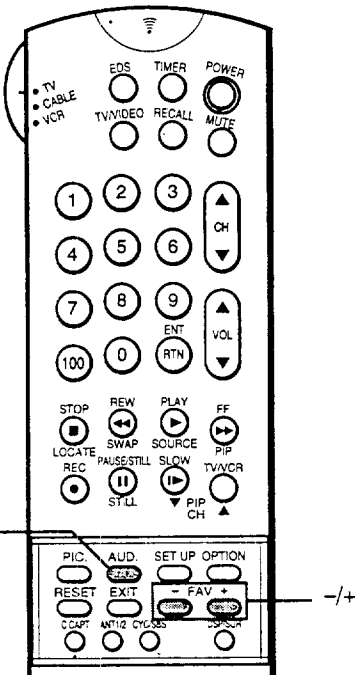
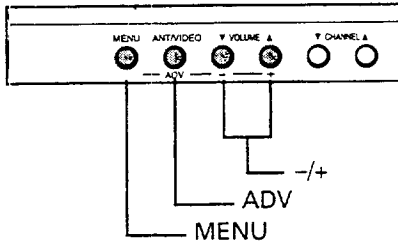

Listening to stereo sound

- 1 When the TV receives a stereo (or SAP) broadcast, the word "STEREO" (or "SAP") is displayed on the screen whenever the TV is turned on, a channel is selected, or the RECALL button is pressed.
- 2 Press **AUD** on the Remote Control (or **MENU** on the TV) to display the Audio menu.
- 3 Press **AUD** repeatedly (or **ADV** on the TV) until "MTS" is displayed in magenta.
- 4 Press **-** or **+** until "STR" is displayed in magenta. If a stereo broadcast is received, "STR" will be displayed in yellow.

Normally this function can be left in "STR" mode. Your TV will then automatically reproduce either stereo or monaural sound, whichever is broadcast.

STEREO
SAP

4

```

MTS:      [STR]SAP MONO
TREBLE   .....
BASS     .....
BALANCE  .....
SPEAKERS MON/OFF
    
```

TO SELECT ITEM PUSH AUD
TO CONTROL PUSH - +

```

MTS:      [STR]SAP MONO
TREBLE   .....
BASS     .....
BALANCE  .....
SPEAKERS MON/OFF
    
```

TO SELECT ITEM PUSH AUD
TO CONTROL PUSH - +

Listening to second language

- 1-3 Follow the above steps 1 to 3.
- 4 Press **-** or **+** until "SAP" is displayed in magenta. You will hear only the second language from the left and right speakers.

```

MTS:      STR[SAP]MONO
TREBLE   .....
BASS     .....
BALANCE  .....
SPEAKERS MON/OFF
    
```

TO SELECT ITEM PUSH AUD
TO CONTROL PUSH - +

If the stereo sound is noisy

If a broadcast signal is not strong enough, and noise-free stereo sound is not available, select the MONO mode. The noise should be reduced.

Notes:

- Be sure you have selected "STR" mode if broadcast is in stereo.
- "MTS" in the Audio menu does not function in the VIDEO mode.

Enhancing the Surround Sound Effect

The Surround function expands the audio listening field wider and deeper than you would believe possible from a TV's speakers. This function process stereo signals from a TV broadcast or VIDEO input.

The Sub-Bass System allows you to improve bass-performance (even when the sound volume is low).

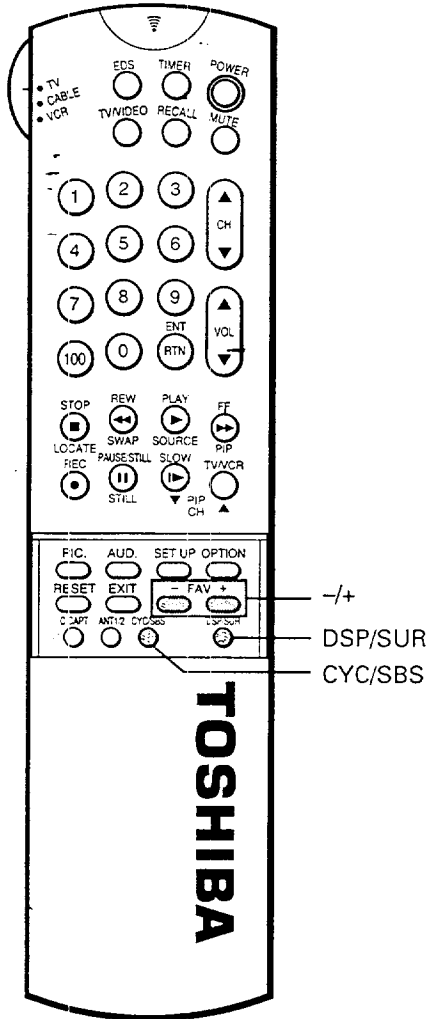

Note on the Surround function

Normally you can leave the MTS function set to "STR" and the Surround function set to "ON". The TV will automatically produce either Surround stereo or monaural, depending on the broadcast type.

Note on the Sub-Bass System

The Sub-Bass System does not operate through the "VARIABLE AUDIO OUT" jacks. (See page 40.) However, the above on-screen displays will appear when the buttons are pressed.

Activating the Surround function

- 1 Select "STR" mode following the steps on the previous page.
- 2 Press **DSP/SUR** on the Remote Control to call up the Surround ON/OFF mode on the screen display as shown.

Press **DSP/SUR** until "SURROUND ON" is displayed in magenta.

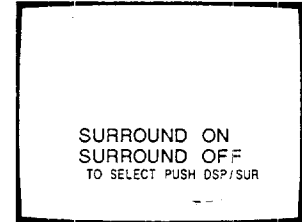

The Surround function has now been activated.

To deactivate the Surround effect

Select "SURROUND OFF" in step 2 above.

Adjusting the level of the Sub-Bass System (SBS)

The Sub -Bass System allows you to improve bass performance (even when the sound volumes is low).

- 1 Press **CYC/SBS** on the Remote Control to call up the SBS ON/OFF mode display.

Press **CYC/SBS** until "SBS ON" is displayed in magenta.

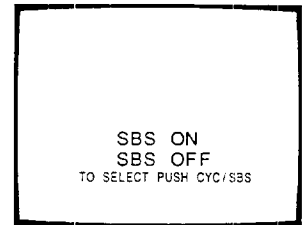

- 2 Press - or + while the SBS ON/OFF mode display shown above is on the screen to call up the SBS level adjustment display.

Press + to increase the SBS level.
Press - to decrease the SBS level.

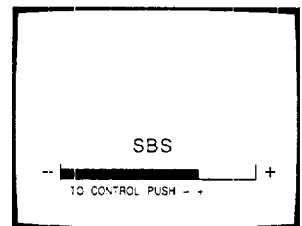

To deactivate the Sub-Bass System

Select "SBS OFF" in step 1 above.

Watching Picture-in-Picture

This TV is capable of displaying two pictures simultaneously. This is called the Picture-in-Picture function. A TV broadcast picture, or a picture from external source such as a VCR, can be displayed as a small picture.

Note: The signal sources input through the ANT-2 terminal cannot be displayed as a small picture.

Displaying a small picture

To display a TV broadcast picture as a small picture

- 1 Turn on the TV and select the desired program.
- 2 Press **PIP** once to display a small picture. The 1/9 size window picture will appear. If you press **twice**, the 1/16 size window picture will appear.
- 3 Press **PIP CH** ∇/\blacktriangle to select the desired program for the small picture.
- 4 To turn off the small picture, press **PIP** again.

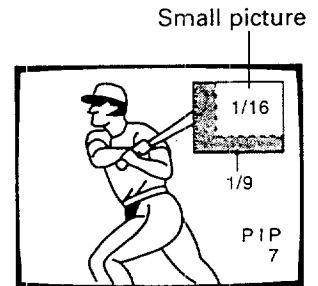

To display a picture from an external source as a small picture

Connect external source equipment for the small picture. (For connection, see pages 38 and 39.)

- 1 Turn on the TV and select the desired program.
- 2 Press **PIP** to display a small picture.
- 3 Press **SOURCE** repeatedly to select the input source (TV, VIDEO 1 or VIDEO 2) for the small picture. The selected source will be displayed in magenta.

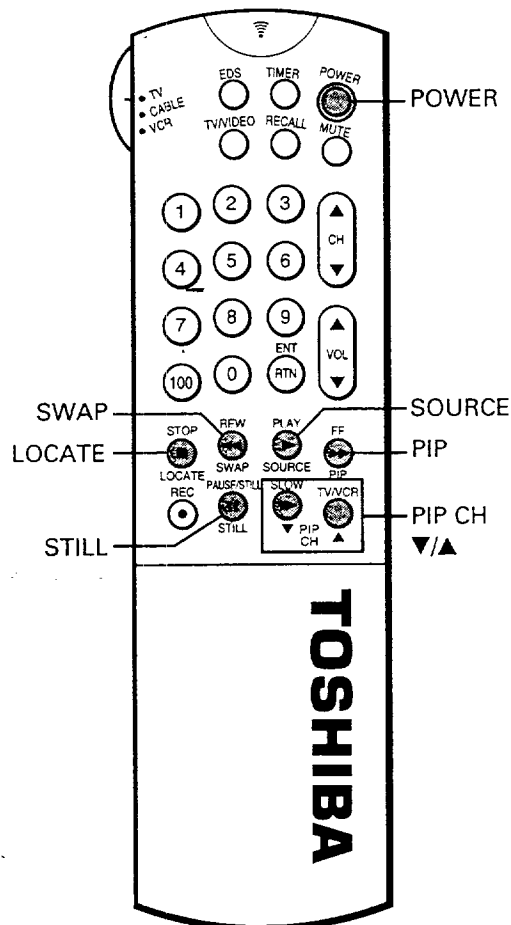
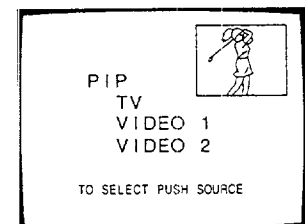
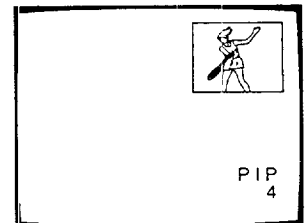

To turn off the small picture, press PIP

- Twice, if you watch the 1/9 size window picture.
- Once, if you watch the 1/16 size window picture.

Using advanced functions

To change the position of the small picture

Press **LOCATE** repeatedly when a small picture is displayed. The display position of the small picture will change in order.

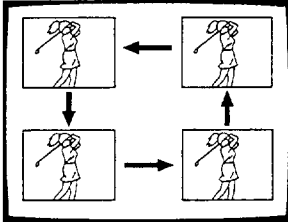

To switch the main and small picture

Press **SWAP** when a small picture is displayed. The main and small pictures will switch. To switch them again, press **SWAP** again.

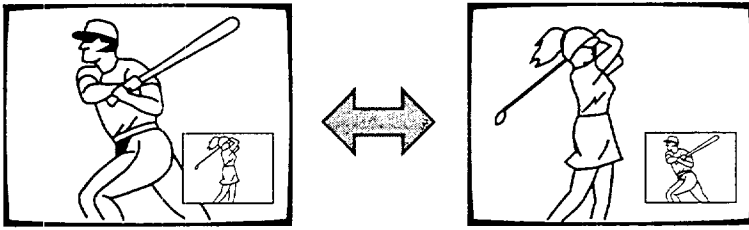

To freeze the small picture

Press **STILL** when a small picture is displayed. The small picture will become a still picture. To return it to a moving picture, press **STILL** again.

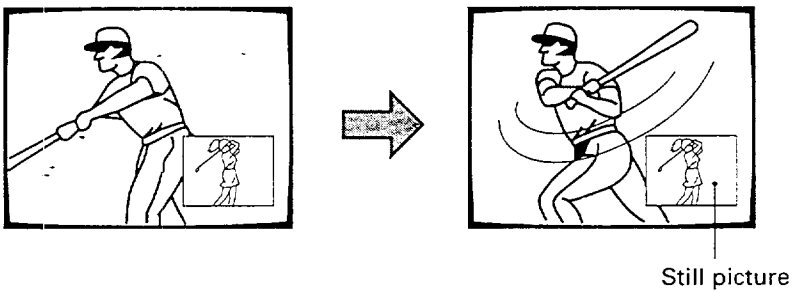

Setting the Off-Timer (Sleep Timer)

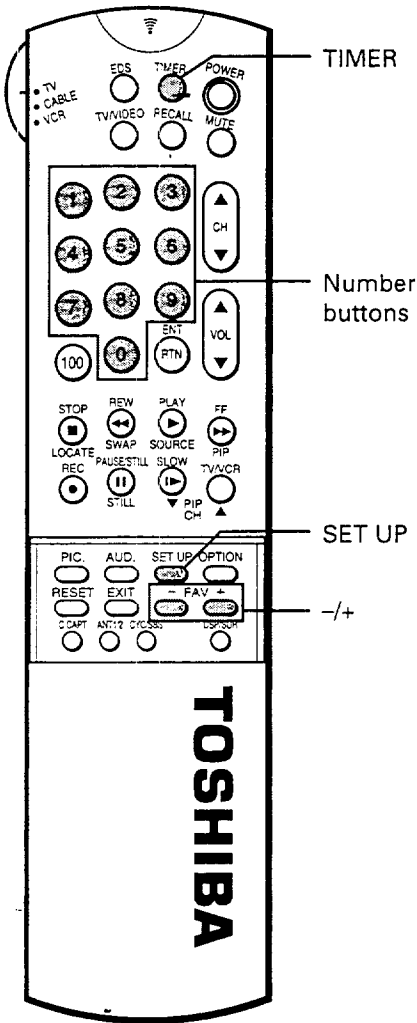
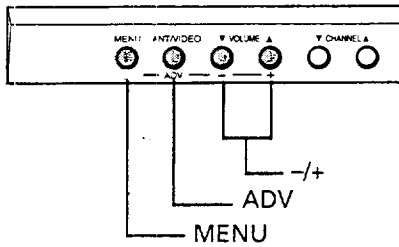

Setting the off-timer

With the off-timer, you can set the TV to turn off automatically after a pre-determined period of time (up to 180 minutes in 10 minutes unit).

- 1 Press **TIMER** on the Remote Control to select the OFF TIMER mode.
 - 2 Press two **Number** buttons to enter the length of time you want the TV to stay on after each number position starts to blink.
- Example:** 120 minutes
Press 1, then 2.
- 3 Press **TIMER** to start the timer. The display color will change from magenta to cyan, then the display will go off.

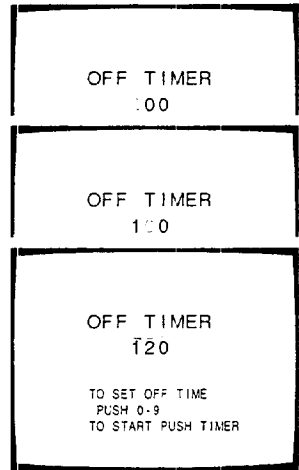

To cancel the setting

Press **POWER** twice, once to turn the TV off and once to turn it on again.

You can also set the off-timer using the on-screen menu function.

- 1 Press **SET UP** on the Remote Control (or **MENU** on the TV) to display the Setup menu.
- 2 Press **SET UP** repeatedly (or **ADV** on the TV) until "TIMER" is displayed in magenta.
- 3 Press **+** or **-** to enter the length of time you want the TV to stay on. Each time you press the button, the time display will increase or decrease by 10 minutes.

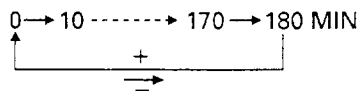
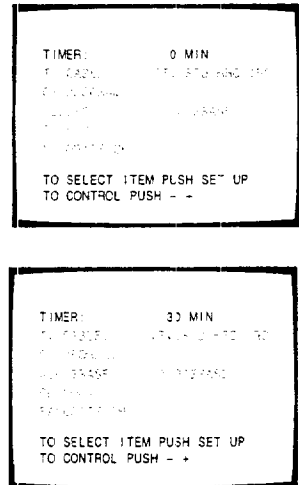

Note: To display the time remaining, press **TIMER** once.
To close the display, press **TIMER**.

Programming Your Favorite Channels

The Favorite Channel Programming feature allows you to program up to 12 of your favorite channels. Once programmed, you can use the FAV +/- buttons on the Remote Control to scan through only your favorite channels, skipping other channels you do not normally view. You can use the CHANNEL ▲/▼ buttons to scan through all the channels you programmed in the TV's memory.

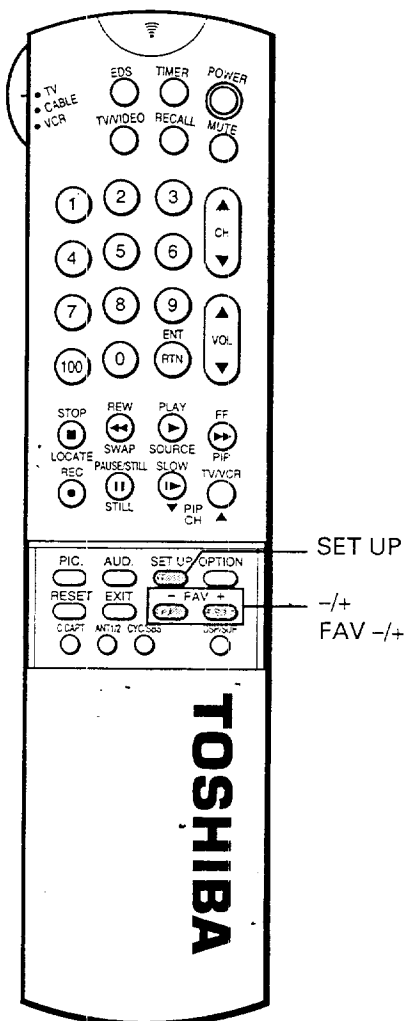
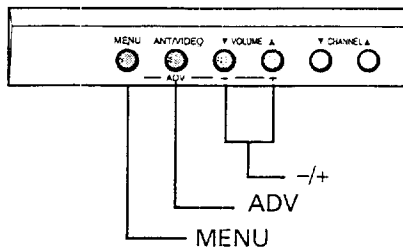

Programming your favorite channels

- 1 Select a channel you want to program.

Example: channel 2

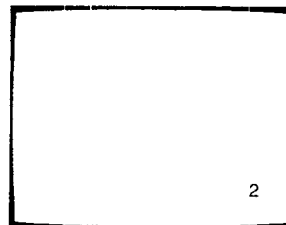

- 2 Press **SET UP** on the Remote Control (or **MENU** on the TV) to display the Setup menu on the screen.

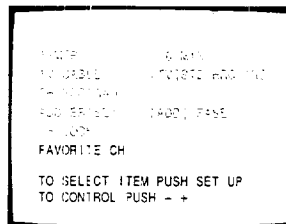

- 3 Press **SET UP** repeatedly (or **ADV** on the TV) until "FAVORITE CH" is displayed in magenta.

- 4 Press - or + to display FAVORITE CH menu. Each time you press - or +, you are guided between "SET" and "CLEAR".

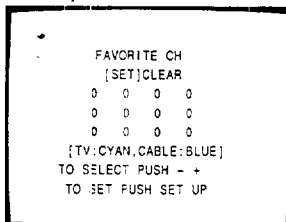

- 5 **To program channels:**
Press **SET UP** (or **ADV**) until the channel number to be programmed ("2" in this example) replace "0" on the display.

To erase channels:
Press **SET UP** (or **ADV**) until "0" replaces channel number to be erased, "2" for example.

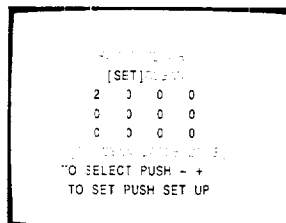

- 6 Repeat steps 1 to 5 for other channels.

Selecting your favorite channels

To select your favorite channels you have programmed, use the FAV +/- buttons on the Remote Control instead of using the CHANNEL ▲/▼ buttons.

Note: The FAV +/- buttons cannot function if you have not programmed your favorite channels.

Locking Channels

With this function you can lock out specific channels by entering your own 4-digit code. The TV will not be able to tune to those channel for the next 24 hours, unless you enter the code. This TV has 8 memory spaces total, 4 for the TV mode and 4 for CABLE mode.

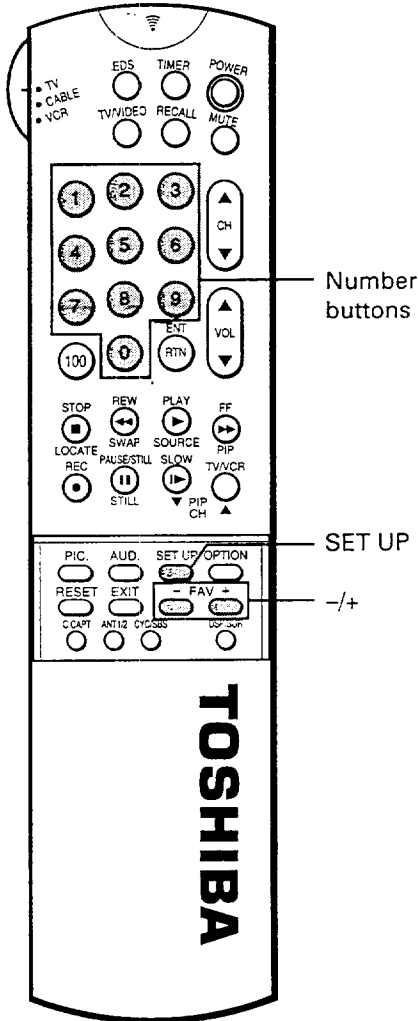

Locking out channels

- 1 Select a channel you want to lock out.

Example: channel 4



- 2 Press **SET UP** on the Remote Control to display the Setup menu.

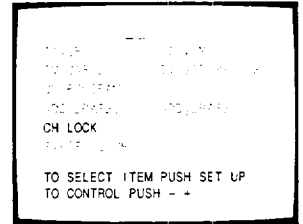

- 3 Press **SET UP** repeatedly until "CH LOCK" is displayed in magenta.

- 4 Press - or + to call up the channel lock adjustment display shown below. Each time you press the button, you are guided between "SET" and "CLEAR". Select "SET"

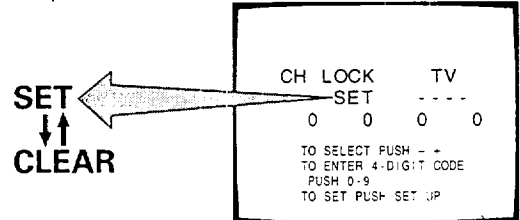

- 5 Press **Number** buttons (0 - 9) to enter a 4-digit code. The numbers you enter will replace the dashes in the display. Pick a number that is easy to remember.

Example: To enter "1234"
Press 1, 2, 3 and 4 in order.

1 - - - → 12 - - → 123 - → 1234

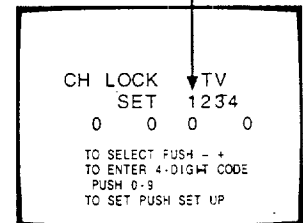

- 6** Press **SET UP** to lock out the channel.
The display at the right will appear on the screen for about 4 seconds.

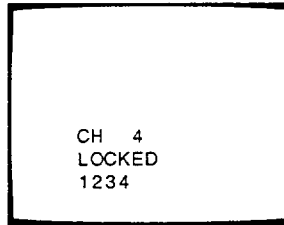

- 7** Repeat steps 1 to 6 for other channels.
This TV has 8 memory spaces total, 4 for the TV mode and 4 for **CABLE** mode respectively.

Note: If a different code number is used whenever you lock out a channel, the last one has priority over the preceding ones.

- 8** Select another channel, or turn off the TV if desired.

Unlocking channels

- 1** Select "CLEAR" following steps 2 to 4 on the previous page.

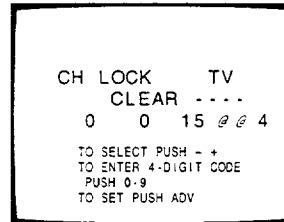

- 2** Enter the 4-digit code used to lock out the channels with the Number buttons.

- 3** Press **SET UP**.
If you have entered the correct code
The display shown at the right appears.

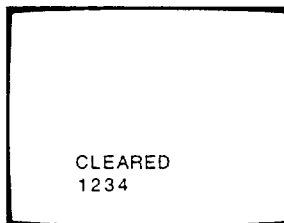

If a wrong code has been entered
These messages appear. Try to enter the correct code again.

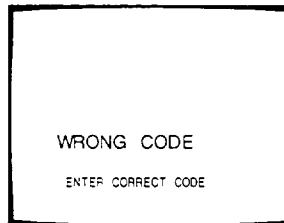

If you want to know the channels you have locked out
Call up the channel lock adjustment mode using the Setup menu.

Using Closed-Captioned Function

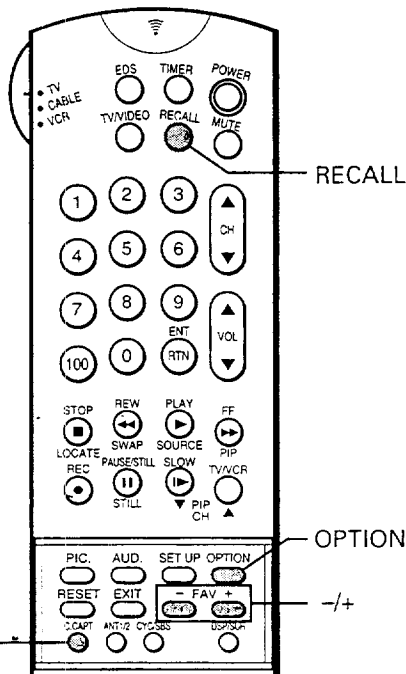
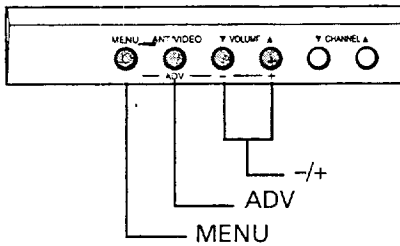
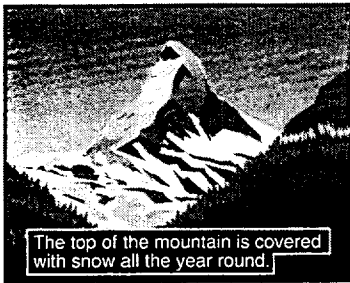

Viewing captions

Closed-captioning is a printed version of the dialogue, narration, and/or sound effects of a TV program. Captions will appear at either the top or bottom of the screen during captioned broadcasts as shown. Captioning is especially helpful for hearing impaired individuals.

- 1 Select the desired program.
- 2 Press **RECALL** to check if the program is being captioned. If it is, the word "CAPTION" is displayed on the screen. The captioned programs are usually notated on your local TV listings by its service marks such as "CC".

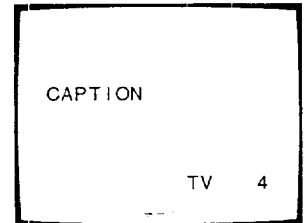

- 3 Press **C.CAPT** on the Remote Control to call up the CLOSED CAPTION menu. Usable selections are displayed in yellow.

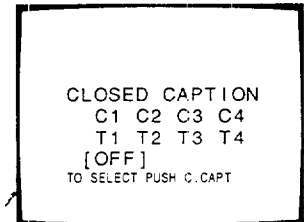

Press **C.CAPT** repeatedly until "C1", "C2", "C3" or "C4" is displayed in magenta. ("C1" stands for CAPTION 1, for example.) Select "C1" for translation of the primary language in your area. Select "C3" for captioning information usually of secondary languages. "C2" or "C4" carry Closed Captioning but not necessarily in the same time frame as the sound from the program.

You can also select this feature using the on-screen menu function.

- 1 Press **OPTION** on the Remote Control (or **MENU** on the TV) to display the Option menu.
- 2 Press **OPTION** repeatedly (or **ADV** on the TV) until "C.CAPT" is displayed in magenta.
- 3 Press **-** or **+** to select "C1", "C2", "C3" or "C4".

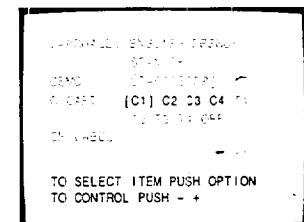
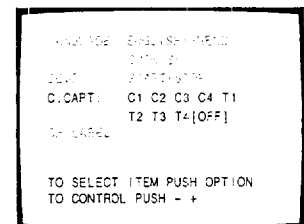

Note:
A closed-captioned signal may not be decoded in the following situations.

- When a video tape has been dubbed.
- When the signal reception is weak.
- When the signal reception is non-standard.

To deactivate this feature
Select "OFF" in the CLOSED CAPTION mode display.

Viewing text

Text is information that is presented using from one half to full television screen. It is usually not related to the program. For example, it could be a listing of the closed-captioned programs, news, weather information or stock market reports.

- 1 Select the desired program.
- 2 Press **RECALL** to check if the program includes text information. If it is, the word "TEXT" is displayed on the screen.

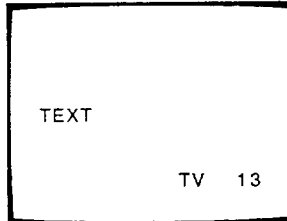

- 3 Press **C.CAPT** on the Remote Control to call up the CLOSED CAPTION menu. Usable selections are displayed in yellow.

Press **C.CAPT** repeatedly until "T1", "T2", "T3" or "T4" is displayed in magenta. ("T1" stands for TEXT 1, for example.)

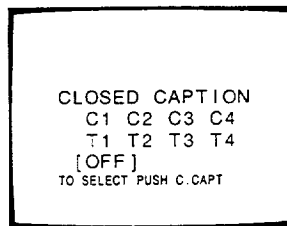

	Temps		Current Weather
	F	C	
LONDON	51	11	Clear
MOSCOW	57	14	Cloudy
PARIS	53	12	Clear
ROME	66	19	Cloudy
TOKYO	65	18	Rain

You can also select this feature using the on-screen menu function.

- 1 Press **OPTION** on the Remote Control (or **MENU** on the TV) to display the Option menu.
- 2 Press **OPTION** repeatedly (or **ADV** on the TV) until "C.CAPT" is displayed in magenta.
- 3 Press **-** or **+** to select "T1", "T2", "T3" or "T4".

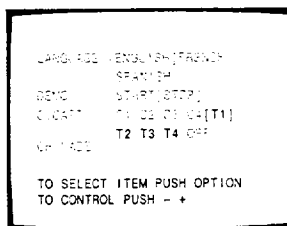
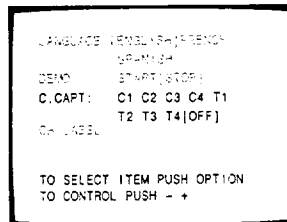

To deactivate this feature

Select "OFF" in the **CLOSED CAPTION** mode display.

Note: If you select a closed-captioned channel and the "TEXT" mode, the text screen always appears. However, text characters are not displayed when no signal is aired.

Labeling Channels

This feature allows you to enter a 4 letter channel identifier of your choice that will appear over the channel number display. The labeling can be anything you want (for example the station call letters).

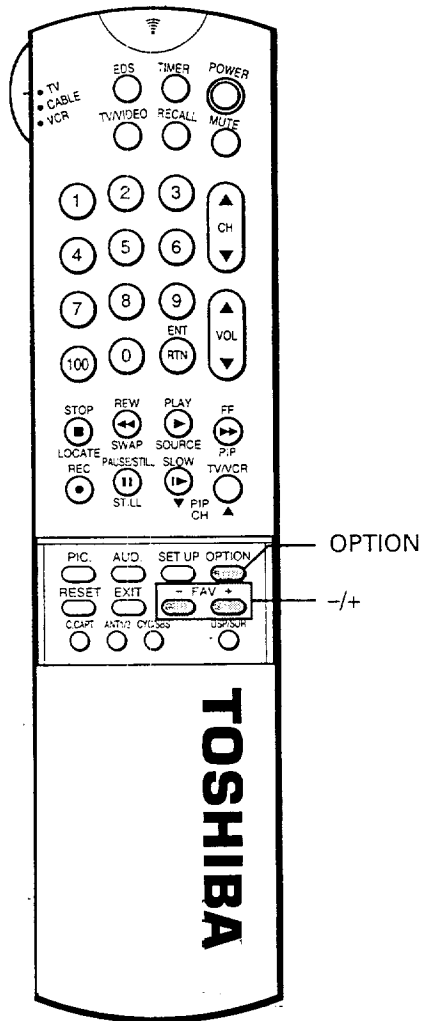
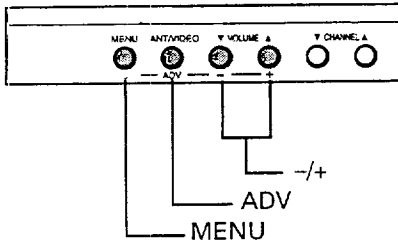

Programming the channel labels

- 1 Select the channel you want to apply labels.

Example: To assign "ABCD" to channel 4.

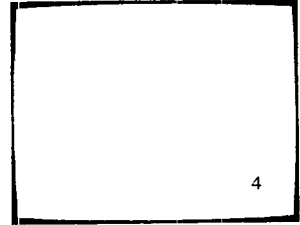

- 2 Press **OPTION** on the Remote Control (or **MENU** on the TV) to display the Option menu.

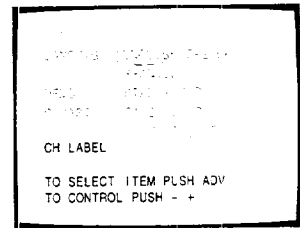

- 3 Press **OPTION** repeatedly (or **ADV** on the TV) until "CH LABEL" is displayed in magenta.

- 4 Press - or + to call up the CH LABEL mode display shown below on the screen.

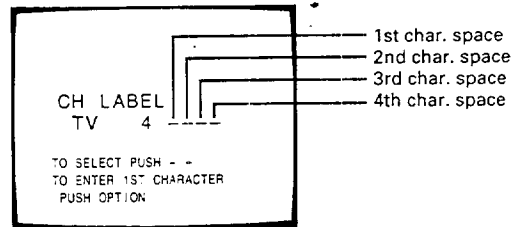

Letters of the alphabet, numbers and other graphic symbols are available for labeling.

Each time you press the - or + button, the displayed character will change in the following order.

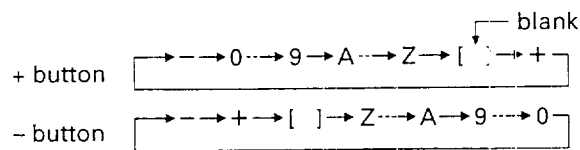

- 5 Press - or + repeatedly until the 1st character ("A" in this example) appears in the 1st character space.

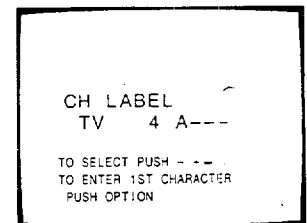

- 6 Press **OPTION** (or **ADV**) once to enter the 1st character and to advance to the next character space.

7. Repeat steps 5 and 6 to enter the 2nd, 3rd and 4th characters ("B", "C", "D" in this example). When the on-screen message at the right appears, the channel label has been stored in the memory.

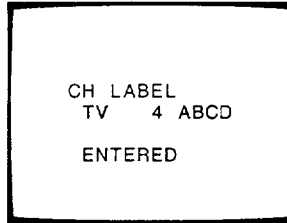

8. Repeat steps 1 through 7 for other channels. You will be able to apply labels to up to 32 names. The label will appear when you turn the TV on, select a channel, or press the RECALL button.

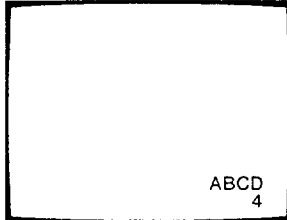

Clearing channel labels

1. Select the channel which has the label you want to clear.

- 2-4. Follow steps 2-4 on the previous page to call up the CH LABEL mode display.

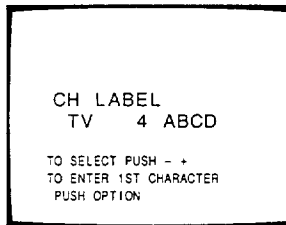

5. Enter "[blank]" (or "-") in all character spaces.

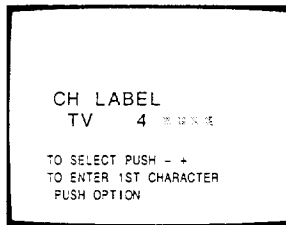

Changing On-Screen Display Language

Three different languages (ENGLISH, FRENCH and SPANISH) are available for the on-screen displays (adjustment menus, and messages), and you can choose the desired one.

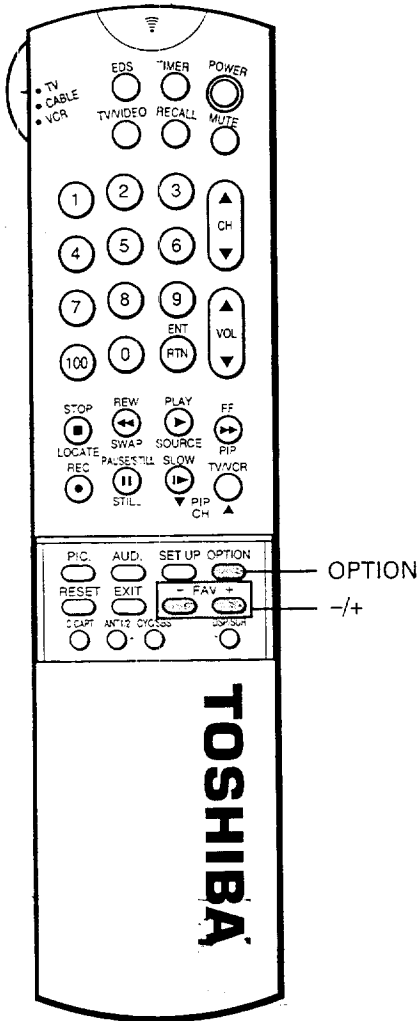
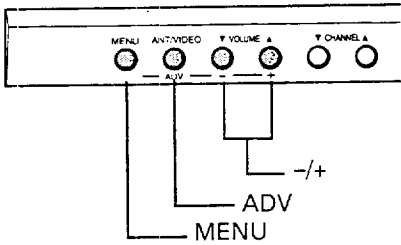

Selecting a language

- 1 Press **OPTION** on the Remote Control (or **MENU** on the TV) to display the Option menu.
- 2 Press **OPTION** repeatedly (or **ADV** on the TV) until "LANGUAGE" is displayed in magenta.
- 3 Press - or + until your desired language is displayed in magenta.

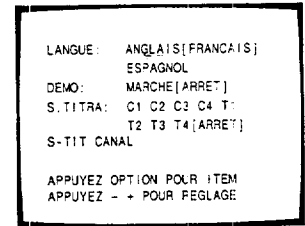
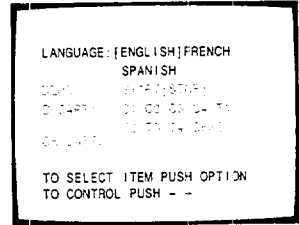

Example: Picture menu display "ENGLISH"

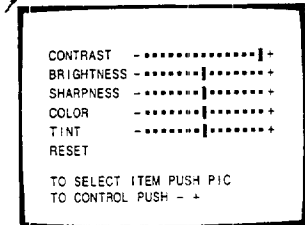

"FRENCH"

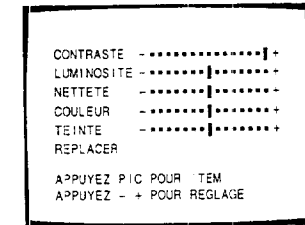

"SPANISH"



Demonstration Mode

When this function is activated, your TV will automatically display a variety of its on-screen menus and special features. This function is provided for demonstration purpose only.

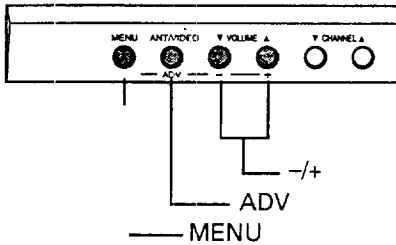

Starting the on-screen demonstration

- 1 Press **OPTION** on the Remote Control (or **MENU** on the TV) to display the Option menu.
- 2 Press **OPTION** repeatedly (or **ADV** on the TV) until "DEMO" is displayed in magenta.
- 3 Press **-** or **+** until "START" is displayed in magenta. The on-screen demonstration will start after about 15 seconds.

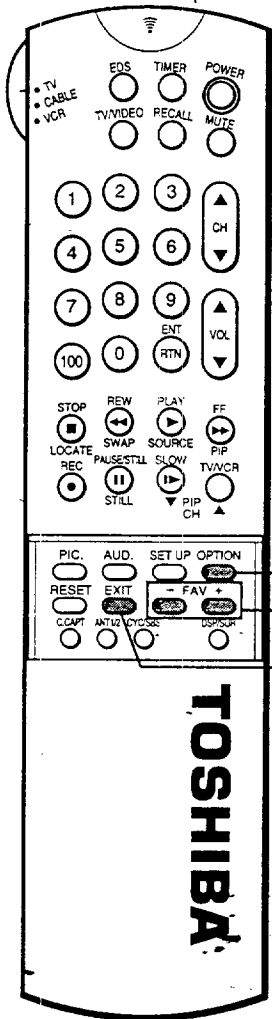
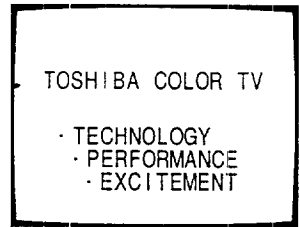
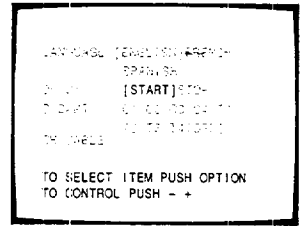
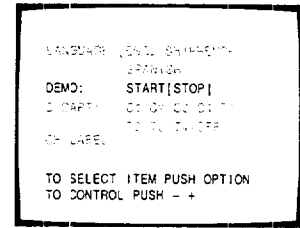

OPTION
-/+
EXIT

To stop the demonstration
Press **EXIT**, or select "STOP" in step 3 above.

Connecting a Standard VCR

Connect VIDEO 1 or VIDEO 2 IN jacks on the TV rear panel to the video/audio output jacks of an installed VCR, Laser disk player, video camera etc. for playback of video material.

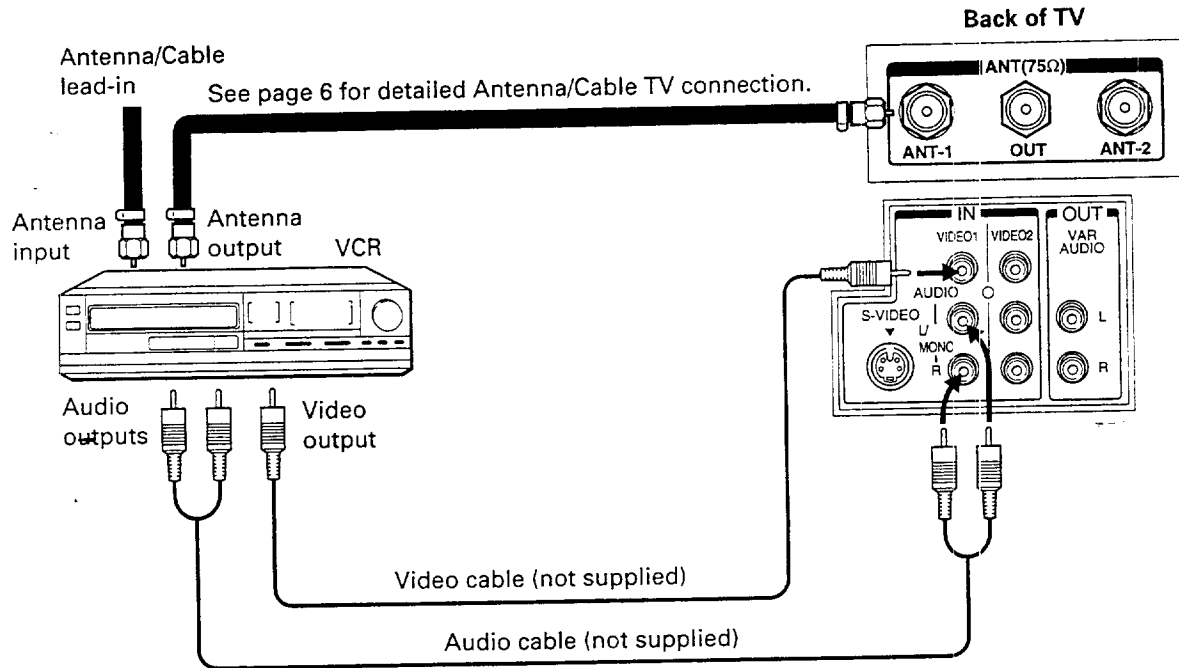

Selecting video input source

To operate your TV and video equipment properly, refer to the instructions furnished with the video equipment.

- 1 Turn the TV and VCR ON.
- 2 Press **TV/VIDEO** on the Remote Control (or **ANT/VIDEO** on the TV) to select the appropriate source. Each time you press the button, TV, VIDEO 1 or VIDEO 2 source will be selected in order. The selected source will be displayed in magenta.
- 3 Operate your VCR normally.

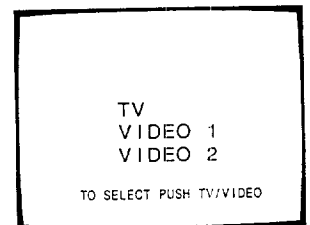

Notes:

- The VIDEO 2 IN jacks can also be used for connecting a second piece of video equipments with video/audio outputs. To view video from equipment connected to the VIDEO 2 IN jacks, select "VIDEO 2".
- If you connect a monaural VCR, connect the audio output of the VCR to the L/MONO jack of the VIDEO 1/2 IN jacks on the TV.

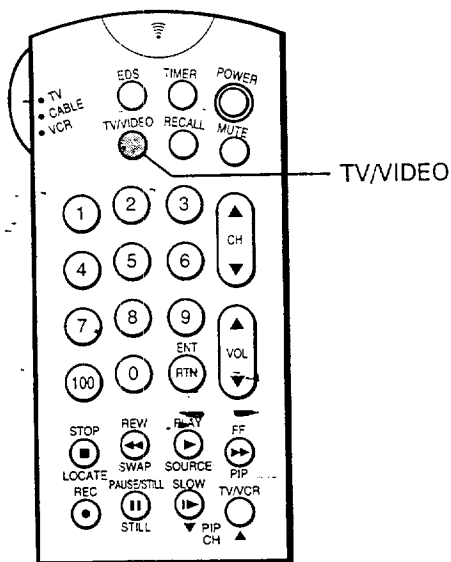
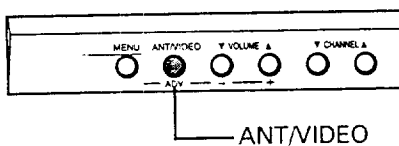

Connecting a VCR with an S-Video Jack

If you connect a VCR with an S-video jack to the S-VIDEO jack on the back of the TV, you must also connect the audio cables to the AUDIO jacks of the VIDEO 1 IN jacks on the back of the TV. The S-video cable only carries the video signal. Audio signals are separate.

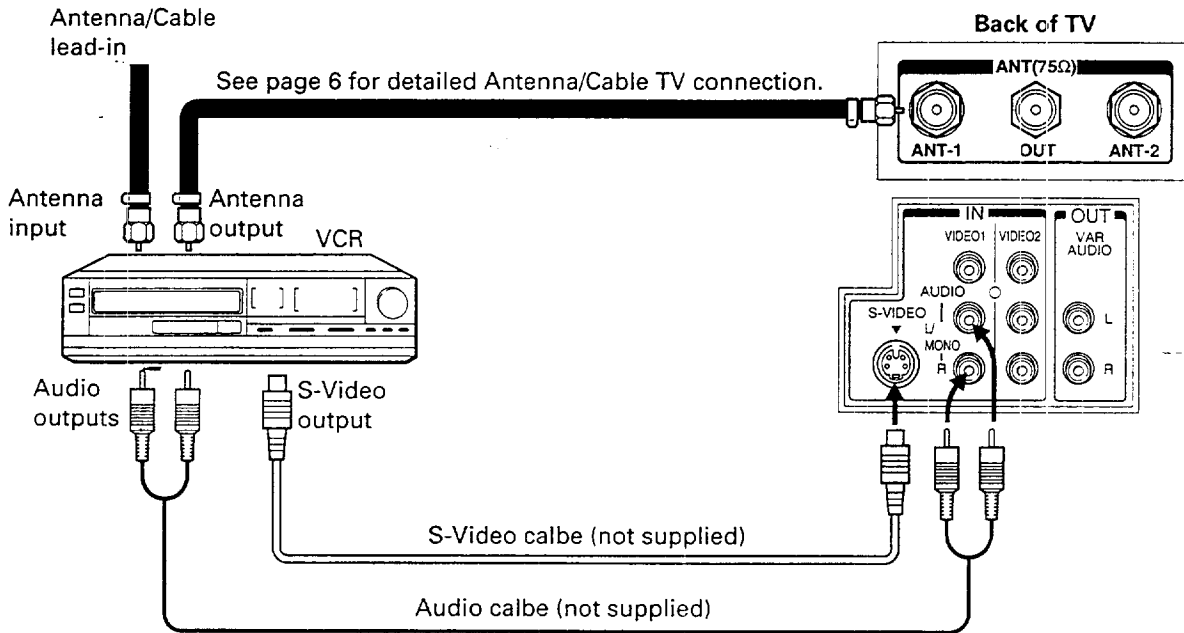

Selecting video input source

- 1 Turn the TV and VCR ON.
- 2 Press TV/VIDEO (or ANT/VIDEO) to select "VIDEO 1".
- 3 Operate your VCR normally.

Notes:

- When the S-video cable is connected to the S-VIDEO IN jack, the video cable (phono-type) should not be connected.
- The S-VIDEO jack accepts SEPARATED Luminance/Chrominance (Y-C) signals conforming to the NTSC standard.

Connecting an Audio Amplifier

Connect the VARIABLE AUDIO OUT jacks to the auxiliary input jacks on the stereo amplifier. You can control the audio level using the Remote Control for this TV.

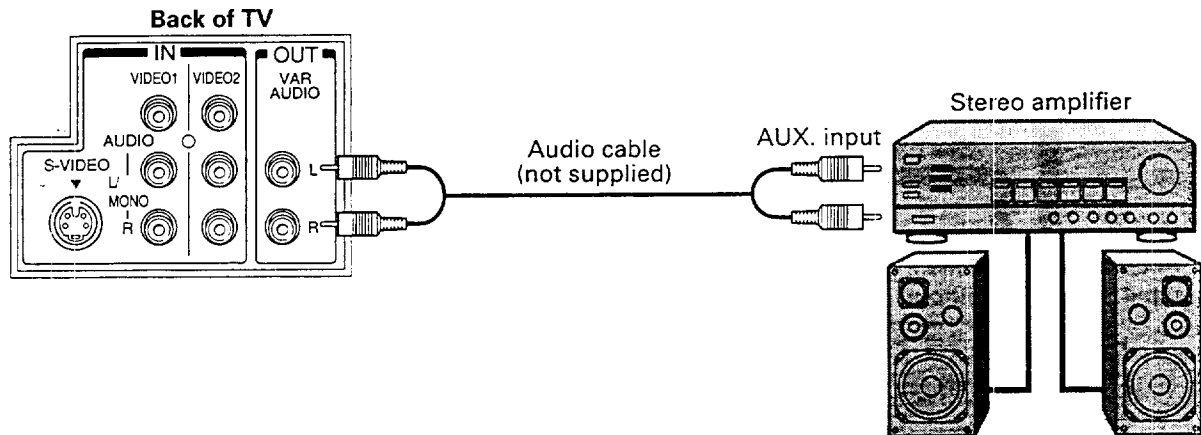

Preparing for use

- 1 Turn the TV and the stereo amplifier ON.
- 2 Adjust the VOLUME buttons on the TV for a moderate listening level.
- 3 Disconnect the built-in speakers following the instructions at the right.
- 4 Adjust the volume control on the stereo amplifier for a moderate listening level.
- 5 Control of the audio can now be done using the VOLUME and MUTE buttons on the Remote Control of the TV, and using the Audio menu items (BASS, TREBLE and BALANCE).

Disconnecting the built-in speakers

- 1 Press **AUD** repeatedly until "SPEAKERS" is displayed in magenta in the Audio menu.
- 2 Press **-** or **+** until "OFF" is displayed in magenta.
The built-in speakers will be disconnected.

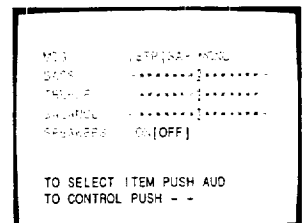
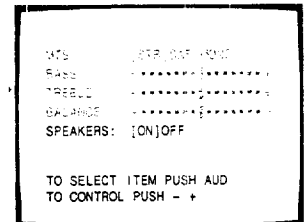

To use the built-in speakers again
Select "ON" in step 2 above.

Cleaning and Care

WARNING: TV sets use High Voltage. Do not try to remove the cabinet back. Refer servicing to qualified service personnel.

■ To clean the TV screen:

1. First remove the plug from the power outlet to avoid possible shock hazard.
2. Use a clean cellulose sponge or chamois cloth dampened with a solution of mild detergent and warm water to clean TV screen and trim. Do not use too much water on the TV screen. Water spills into the cabinet and may cause damage to the TV.
- Avoid excess water.
3. Remove any extra moisture with the same cloth or a dry one.

- To maintain the finish and appearance of the cabinet, polish it from time to time with a quality furniture polish.

Caution: Never use strong solvents such as thinner, benzene or other chemicals on or near cabinet, as they might damage the finish of the cabinet.

Specifications

TELEVISION SYSTEM:	NTSC standard
CHANNEL COVERAGE:	VHF; 2 through 13 UHF; 14 through 69 Cable TV; mid band (A-8 through A-1, A through I) super band (J through W) hyper band (AA through ZZ, AAA, BBB) ultra band (65 through 94, 100 through 125, .
POWER SOURCE:	120V AC, 60Hz
POWER CONSUMPTION:	115W (average)
AUDIO POWER:	5W + 5W
SPEAKER TYPE:	2-3/4 x 5-1/8 inches (70 x 130 mm)
VIDEO/AUDIO TERMINALS:	S-VIDEO INPUT Y-INPUT: 1V (p-p), 75 ohm, negative sync. C-INPUT: 0.286V (p-p) (burst signal), 75 ohm VIDEO/AUDIO INPUT VIDEO: 1V(p-p), 75 ohm, negative sync. AUDIO: 150mV(rms) (30% modulation equivalent, 47k ohm) VARIABLE AUDIO OUTPUT 0 - 350mV (rms) (30% modulation equivalent, 4.7k ohm)
DIMENSIONS:	Width 34-7/8 inches (886mm) Height 30-3/4 inches (781mm) Depth 24-3/32 inches (612mm)
MASS:	157.4 lbs (71.4kg)
SUPPLIED ACCESSORIES:	Remote Control with 2 size "AA" batteries Antenna adapter
OPTIONAL TV STAND:	ST3512

Design and specifications are subject to change without notice.

Connecting an Audio Amplifier
Cleaning and Care/ Specifications

EQUIPMENT
CONNECTIONS

REFERENCE
SECTION

Before Calling Service Personnel

Before calling service personnel, please check the following chart for a possible cause of the problem you are experiencing. A minor adjustment on your part may eliminate the problem and restore your TV reception.

Symptoms	Check	Adjustments
● No picture, no sound	<ul style="list-style-type: none"> ● Be sure power cord is plugged in. ● May be station trouble. ● Check antenna connections. ● Check antenna for broken wires. 	<ul style="list-style-type: none"> ● Press POWER button. ● Try another channel.
● No sound, picture OK	<ul style="list-style-type: none"> ● May be station trouble. ● Check if SPEAKERS ON/OFF function (page 40) is properly set. 	<ul style="list-style-type: none"> ● Try another channel. ● Adjust VOLUME.
● Poor sound, picture OK	<ul style="list-style-type: none"> ● May be station trouble. ● Check antenna connections. ● May be local interference from an appliance. 	<ul style="list-style-type: none"> ● Try another channel. ● Adjust VOLUME. ● Adjust BASS, TREBLE, or BALANCE control. ● Re-orient antenna.
<ul style="list-style-type: none"> ● Poor picture, sound OK ● Snowy picture ● Lines in picture ● Distorted picture ● Weak picture 	<ul style="list-style-type: none"> ● May be local interference from an appliance. ● Check antenna connections. ● Check antenna for broken wires. ● May be station trouble. 	<ul style="list-style-type: none"> ● Try another channel. ● Adjust BRIGHTNESS. ● Adjust CONTRAST. ● Adjust SHARPNESS. ● Re-orient antenna.
● Poor reception of broadcast channels	<ul style="list-style-type: none"> ● Check antenna connections. ● Check antenna for broken wires. ● If VCR is connected, check TV/VCR switch. 	<ul style="list-style-type: none"> ● Try another channel. ● Re-orient antenna.
● No UHF, VHF OK	<ul style="list-style-type: none"> ● Be sure TV/CABLE function (page 17) is in "TV" mode. 	
● Unable to select a certain channel	<ul style="list-style-type: none"> ● That channel may be locked out with CH LOCK function (page 30), or erased with the ADD/ERASE function (page 18). 	
● Multiple images (ghosts)	<ul style="list-style-type: none"> ● May be station trouble. ● Check antenna connections. 	<ul style="list-style-type: none"> ● Try another channel. ● Re-orient antenna.
● Poor color or No color	<ul style="list-style-type: none"> ● May be station trouble. ● Check antenna connections. ● Check antenna for broken wires. ● May be local interference from an appliance. ● Check if station is broadcasting in color. ● If you change the direction of the TV while the TV is activated, the picture may suffer from color shading. If so, turn off the TV and allow to cool for about 30 minutes, then turn on the TV again. The picture should improve. 	<ul style="list-style-type: none"> ● Try another channel. ● Re-orient antenna. ● Adjust TINT. ● Adjust COLOR.
● No stereo or SAP sound from a known MTS broadcast	<ul style="list-style-type: none"> ● Check if MTS function is properly set. 	
● Remote control does not work	<ul style="list-style-type: none"> ● Check if TV/CABLE/VCR switch is properly set. ● Be sure power cord is plugged in. ● Check battery in Remote Control. 	<ul style="list-style-type: none"> ● Change batteries.

Limited United States Warranty

Toshiba America Consumer Products, Inc. ("TACP") and Toshiba Hawaii Inc. ("THI") make the following limited warranties. These limited warranties extend to the original consumer purchaser or any person receiving this set as a gift from the original consumer purchaser and to no other purchaser or transferee.

Limited One (1) Year Warranty

TACP and THI warrant this product and its parts against defects in materials or workmanship for a period of one (1) year after the date of original retail purchase. During this period, TACP and THI will repair a defective product or part, without charge to you. "Authorized TACP/THI service station personnel will come to your home when warranty service is required. Depending on the type of repair required, the service will either be performed in your home or the set will be taken to the authorized TACP/THI service station for repair and returned to your home at no cost to you."

Limited Two (2) Year Warranty of Picture Tube

TACP and THI further warrant the picture tube in this product against defects in materials or workmanship for a period of two (2) years after the date of original retail purchase. During this period, TACP and THI will replace a defective picture tube without charge to you, except that if a defective picture tube is replaced after one (1) year from the date of the original retail purchase, you pay labor charges involved in the replacement.

Rental Units

The warranty for rental units begin with the first rental or thirty (30) days from the date of shipment to the rental firm, whichever comes first.

Commercial Units

Products sold and used for commercial use have a limited (90) day warranty for all parts, labor and picture tube.

Owner's Manual and Demographic Card.

You should read this owner's manual thoroughly before operating this product. You should complete and mail the enclosed demographic card within ten days after you, or the person who has given you this product as a gift, purchased this product. This is one way to enable TACP/THI to provide you with better customer service and improved products. Failure to return the card will not affect your rights under this warranty.

Your Responsibility

The above warranties are subject to the following conditions:

- (1) You must retain your bill of sale or provide other proof of purchase.
- (2) All warranty servicing of this product must be made by an Authorized TACP/THI Service Station.
- (3) **These warranties are effective only if the product is purchased and operated in the U.S.A. or Puerto Rico**
- (4) Labor service charges for set installation, set up, adjustment of customer controls and installation or repair of antenna systems are not covered by this warranty. Reception problems caused by inadequate antenna systems are your responsibility.
- (5) Warranties extend only to defects in materials or workmanship as limited above and do not extend to any product or parts which have been lost or discarded by you or to damage to products or parts caused by misuse, accident, damage caused by Acts of God, such as lightning or fluctuations in electric power, improper installation, improper maintenance or use in violation of instructions furnished by us; or to units which have had the serial number removed, altered, defaced or rendered illegible.

How to Obtain Warranty Service

If, after following all of the operating instructions in this manual and checking the section "BEFORE CALLING SERVICE PERSONNEL", you find that service is needed;

- (1) Call the TACP toll free number **1-800-631-3811** after you find a defective product or part -to find the nearest TOSHIBA Authorized Service Station.
- (2) Please present your bill of sale or other proof to the Authorized Service Station. "Authorized TACP/THI service station personnel will come to your home when warranty service is required. Depending on the type of repair required, the service will either be performed in your home or the set will be taken to the TACP/THI authorized service station for repair and returned to your home at no cost to you."

IN THE CONTINENTAL UNITED STATES
Should your unit require service, Call



HAWAII
327 Kamakee Street,
Honolulu,
Hawaii 96814
(808) 521-5377

Before Calling Service Personnel/ Limited United States Warranty

REFERENCE SECTION

All warranties implied by state law, including the implied warranties of merchantability and fitness for a particular purpose, are expressly limited to the duration of the limited warranties set forth above. With the exception of any warranties implied by state law as hereby limited, the foregoing warranty is exclusive and in lieu of all other warranties, guarantees, agreements and similar obligations of manufacturer or seller with respect to the repair or replacement of any product or parts. In no event shall TACP or THI be liable for consequential or incidental damages.

No person, agent, distributor, dealer or company is authorized to change, modify or extend the terms of these warranties in any manner whatsoever. The time within which action must be commenced to enforce any obligation of TACP or THI arising under this warranty or under any statute, or law of the United States or any state thereof, is hereby limited to 90 days from the date you discover or should have discovered, the defect. This limitation does not apply to implied warranties arising under state law.

This warranty gives you specific legal rights and you may also have other rights which may vary from state to state. Some states do not allow limitation on how long an implied warranty lasts, when an action may be brought, or the exclusion or limitation of incidental or consequential damages, so the above provisions may not apply to you.

ATTENTION CANADIAN CONSUMERS:

Canadian consumers are requested to complete the special Canadian "Warranty Registration Form" enclosed, and forward this completed form with a copy of bill of sale to TOSHIBA OF CANADA to "Register and Validate" their warranty. Products purchased in the U.S.A. and used in Canada are not covered by these warranties.

TOSHIBA AMERICA CONSUMER PRODUCTS, INC.

HEAD OFFICE/82 TOTOWA ROAD, WAYNE, NEW JERSEY 07470

FACTORY SERVICE CENTERS/NORTHEAST: 82 TOTOWA ROAD, WAYNE, NEW JERSEY 07470

MIDWEST: 1010 JOHNSON DRIVE, BUFFALO GROVE, ILLINOIS 60089-6900

WEST: 5490 E. FRANCIS ST., ONTARIO, CA 91761

SOUTHWEST: 1421 CHAMPION DRIVE, SUITE 304 CARROLLTON, TEXAS 75006

SOUTHEAST: 6115 JIMMY CARTER BLVD., SUITE C2, NORCROSS, GA 30071-4607

TOSHIBA HAWAII, INC.

HEAD OFFICE/327 KAMAKEE STREET, HONOLULU, HAWAII 96814, U.S.A.

TOSHIBA OF CANADA LTD.

HEAD OFFICE/191 MCNABB STREET, MARKHAM, ONTARIO, L3R 8H2, CANADA TEL: (905) 470-5400

SERVICE CENTERS/TORONTO: 191 MCNABB STREET, MARKHAM, ONTARIO, L3R 8H2, CANADA TEL: (905) 470-5400

MONTREAL: 1643, NORTH SERVICE RD., TRANS-CANADA HIGHWAY, DORVAL QUEBEC, H9P 1J1, CANADA

TEL: (514) 332-6860

VANCOUVER: 3870 JACOMBS ROAD, RICHMOND, B.C., V6V 1Y6, CANADA TEL: (604) 270-8481

MANUFACTURED BY

TOSHIBA AMERICA CONSUMER PRODUCTS, INC.

PRINTED IN USA

(96-10) ACL

TOSHIBA

23562732