

# Panasonic®

## Color Television

### Operating Instructions

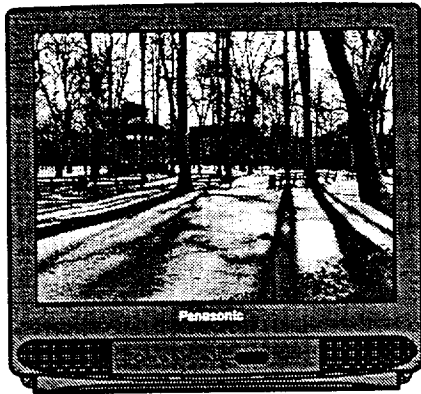

**CT-27G2  
CT-27G2U**



**CT-27G12  
CT-27G12U**

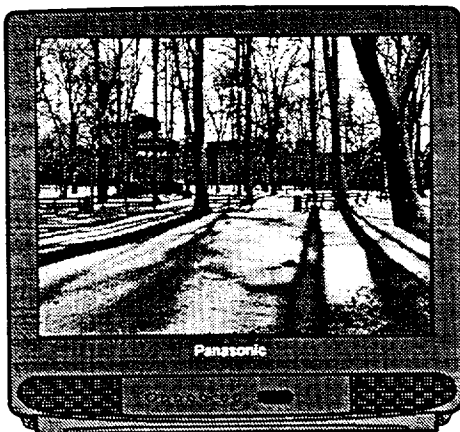



**CT-32G2  
CT-32G2U**



**CT-32G12  
CT-32G12U**

# Safety Instructions

	<b>WARNING</b> <b>RISK OF ELECTRIC SHOCK</b> <b>DO NOT OPEN</b>	
<b>WARNING: To reduce the risk of electric shock do not remove cover or back. No user-serviceable parts inside. Refer servicing to qualified service personnel.</b>		



The lightning flash with arrow-head within a triangle is intended to tell the user that parts inside the product are a risk of electric shock to persons.



The exclamation point within a triangle is intended to tell the user that important operating and servicing instructions are in the papers with the appliance.

**Note To CATV System Installer:** This reminder is provided to call the CATV system installer's attention to Article 820-40 of the NEC that provides guidelines for proper grounding and, in particular, specifies that the cable ground shall be connected to the grounding system of the building, as close to the point of cable entry as practical.

## Safety Instructions For Television Receivers

1. Read and apply the operating instructions provided with your television receiver.
2. Read all of the instructions given here and retain them for later use.
3. Unplug this television receiver from the wall outlet before cleaning. Do not use liquid or aerosol cleaners. Use a damp cloth for cleaning.
4. Do not use attachments not recommended by the television receiver manufacturer as they may cause hazards.
5. Do not use this television receiver near water. For example: Avoid placing it near a bathtub, washbowl, kitchen sink, or laundry tub, in a wet basement, or near a swimming pool, etc.
6. Do not place this television receiver on an unstable cart, stand, or table. The television receiver may fall, causing serious injury to a child or adult, and serious damage to the appliance. Use only with a cart or stand recommended by the manufacturer, or sold with the television receiver. Wall or shelf mounting should follow the manufacturer's instructions, and should use a mounting kit approved by the manufacturer.
- 6A. An appliance and cart combination should be moved with care. Quick stops, excessive force, and uneven surfaces may cause the appliance and cart combination to overturn.
7. Slots and openings in the cabinet and the back or bottom are provided for ventilation, and to insure reliable operation of the television receiver and to protect it from overheating. These openings must not be blocked or covered. The openings should never be blocked by placing the television receiver on a bed, sofa, rug or other similar surface. This television receiver should never be placed near or over a radiator or heat register. This television receiver should not be placed in a built-in installation such as a bookcase unless proper ventilation is provided.
8. Operate only from the type of power source indicated on the marking label. If you are not sure of the type of power supplied to your home consult your television dealer or local power company. For television receivers designed to operate from battery power, refer to the operating instructions.
9. This television receiver is equipped with a polarized alternating-current line plug (a plug having one blade wider than the other). This plug will fit into the power outlet only one way. This is a safety feature. If you are unable to insert the plug fully into the outlet, try reversing the plug. If the plug should still fail to fit, contact your electrician to replace your obsolete outlet. Do not defeat the safety purpose of the polarized plug.
10. Do not allow anything to rest on the power cord. Do not locate this television receiver where the cord will be abused by persons walking on it.
11. Follow all warnings and instructions marked on the television receiver.
12. Do not overload wall outlets and extension cords as this can result in fire or electric shock.
13. Never push objects of any kind into this television receiver through cabinet slots as they may touch dangerous voltage points or short out parts that could result in a fire or electric shock. Never spill liquid of any kind on the television receiver.



**EXAMPLE OF ANTENNA GROUNDING AS PER (NEC) NATIONAL ELECTRICAL CODE**

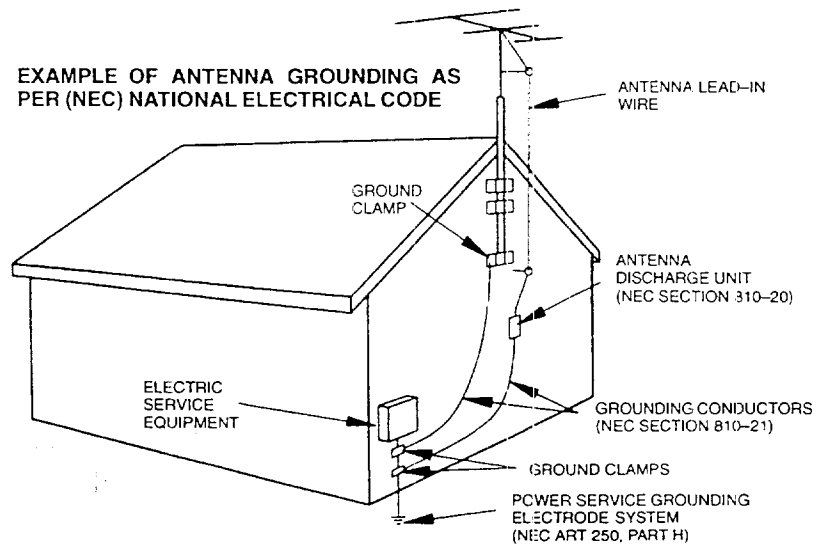

14. If an outside antenna is connected to the television equipment, be sure the antenna system is grounded so as to provide some protection against voltage surges and built up static charges. In the U.S. Section 810 of the National Electrical Code and in Canada Part 1 of the Canadian Electrical Code provides information with respect to proper grounding of the mast and supporting structure, grounding of the lead-in wire to an antenna discharge unit, size of grounding conductors, location of antenna-discharge unit, connection to grounding electrodes, and requirements for the grounding electrode. See Figure.
15. For added protection for this television receiver during a lightning storm, or when it is left unattended and unused for long periods of time, unplug it from the wall outlet and disconnect the antenna. This will prevent damage to the receiver due to lightning and power-line surges.
16. An outside antenna system should not be located in the vicinity of overhead power lines or other electric light or power circuits, or where it can fall into such power lines or circuits. When installing an outside antenna system extreme care should be taken to keep from touching such power lines or circuits as contact with them might be fatal.
17. Unplug this television receiver from the wall outlet, and refer servicing to qualified service personnel under the following conditions:
  - a. When the power cord or plug is damaged or frayed.
  - b. If liquid has been spilled into the television receiver.
  - c. If the television receiver has been exposed to rain or water.
  - d. If the television receiver does not operate normally by following the operating instructions. Adjust only those controls that are covered by the operating instructions as improper adjustment of other controls may result in damage and will often require extensive work by a qualified technician to restore the television receiver to normal operation.
  - e. If the television receiver has been dropped or the cabinet has been damaged.
  - f. When the television receiver exhibits a distinct change in performance – this indicates a need for service.
18. Do not attempt to service this television receiver yourself as opening or removing covers may expose you to dangerous voltage or other hazards. Refer all servicing to qualified service personnel.
19. When replacement parts are required, be sure the service technician has used replacement parts specified by the manufacturer that have the same characteristics as the original part. Unauthorized substitutions may result in fire, electric shock, or other hazards.
20. Upon completion of any service or repairs to this television receiver, ask the service technician to perform routine safety checks to determine that the television is in safe operating condition.
21. **WARNING: To prevent fire or shock hazard, do not expose this appliance to rain or moisture.**
22. **CAUTION: TO PREVENT ELECTRIC SHOCK DO NOT USE THIS (POLARIZED) PLUG WITH A RECEPTACLE OR OTHER OUTLET UNLESS THE BLADES CAN BE FULLY INSERTED TO PREVENT BLADE EXPOSURE.**

**NOTE:** This equipment is designed to operate in the U.S.A., Canada and other countries where the broadcasting system and AC house current is exactly the same as in the U.S.A. and Canada.

**Important Information Regarding Use of Video Games, Computers, DSS or Other Fixed Image Displays.**

The extended use of fixed image program material can cause a permanent "shadow image" on the picture tube. This background image is viewable on normal programs in the form of a stationary fixed image. This type of irreversible picture tube deterioration can be limited by observing the following steps:

- A. Reduce the brightness/contrast setting to a minimum viewing level.
- B. Do not display the fixed image for extended periods of time.
- C. Turn the power off when not in actual use.

**NOTE:** The marking or retained image on the picture tube resulting from fixed image use is not an operating defect and as such is not covered by Warranty. This product is not designed to display fixed image patterns for extended periods of time.

## Specifications

**Power Source:** 120V, 60Hz, AC  
**Channel Capability:** 181 channels (See chart)  
 VHF 2-13, UHF 14-69, Cable 125 channels  
**Video Input Jacks:** 1V p-p, 75 ohm, phono jack type  
**Audio Input Jacks:** 500mV rms 47K ohm  
**To Audio AMP Jacks:** 0-2.0V rms 4.7K ohm  
**For These Models Only**  
**(CT-27G12/U & CT-32G12/U)**

**Stereo Sound**

**Closed Caption Display**

Specifications are subject to change without notice or obligation.

## Channel Capability Chart

BAND	CHANNELS
VHF	12
UHF	56
CABLE (Mid-Band)	15
CABLE (Super Band)	14
CABLE (Hyper Band)	28
CABLE (Ultra Band)	56
<b>TOTAL CHANNELS</b>	<b>181</b>

# Introduction

## Congratulations on Your New Purchase

Your new video component features an all solid state chassis which is designed to give you many years of enjoyment. It was thoroughly tested and adjusted at the factory for best performance.

In order for you to take full advantage of your new video component, please read and follow the installation and operating instructions supplied with this product.

### Customer's Record

The model and serial number of this product may be found on its back cover. You should note the model and serial number in the space provided and retain this book as a permanent record of your purchase to aid in identification in the event of theft or loss.

Model Number: \_\_\_\_\_ Serial Number: \_\_\_\_\_

## Table of Contents

<b>Safety Instructions</b> .....	2	<b>Main Menu Icons</b> .....	16
<b>Specifications</b> .....	3	Menu Language Selection .....	16
<b>Introduction</b> .....	4	Picture Adjustments .....	17
<b>Care and Cleaning</b> .....	5	Picture Norm .....	17
<b>Models Difference Feature Table</b> .....	5	Color, Tint, Brightness, Picture and Sharpness ..	17
<b>Installation</b> .....	6	Audio Adjustments .....	18
Receiver Location .....	6	Mode (Stereo/SAP/Mono) .....	18
Optional External Equipment Connections .....	6	AI Sound .....	
AC Power Supply Cord .....	6	(Not used in CT-27G2/U & CT-32G2/U) ...	18
Remote Control Battery Installation .....	6	TV Speakers (For CT-32G12/U Only) .....	18
Antenna/Cable Connections .....	7	Lock .....	19
Other Video Equipment .....	7	Lock Game Guard .....	19
<b>Optional Equipment Connection and Operation</b> ..	8	Unlock Game Guard .....	19
To Audio AMP Connection .....	8	Channel Caption .....	20
Audio/Video Input Connection .....	9	Timer Features .....	20
<b>Location of Controls Remote</b> .....	10	Sleep Timer .....	20
<b>Remote Quick Reference Functional Key Chart</b>		Program Timer .....	21
(For CT-27G2/U & CT-32G2/U) .....	11	Set-Up Features .....	22
<b>Location of Controls Remote</b> .....	12	Set Time .....	22
<b>Remote Quick Reference Functional Key Chart</b>		Antenna (Ant) .....	22
(CT-27G12/U & CT-32G12/U) .....	13	Auto Prog .....	22
<b>Location of Controls Receiver</b> .....	14	Manual Prog .....	23
<b>Special Functions</b> .....	15	Auto Power On .....	23
R-Tune Button .....	15	CC (Closed Caption) Mode .....	23
Recall Button .....	15	<b>Programming The Universal Remote</b> .....	24
Cable Power Button .....	15	<b>VCR and Cable Converter Box</b>	
Multi Button .....	15	Infrared Codes Index .....	25
		<b>Troubleshooting Chart</b> .....	26
		Power Loss .....	26
		Notes .....	27

# Care and Cleaning

## Picture Tube (Turn set off)

Use a mild soap solution or window cleaner and a clean cloth. DO NOT USE ABRASIVE CLEANERS. Avoid excessive moisture and wipe dry.

## Plastic Cabinets

Wipe the cabinet with a soft cloth dampened with water or a mild detergent solution and wipe dry with a soft clean cloth. Avoid excessive moisture. Do not use benzene, thinners or other petroleum based cleaners.

## Wood Cabinets

When dusting or polishing the cabinet, use a clean soft cloth and stroke straight with the grain. An occasional coat of furniture polish will help preserve the finish. Do not use benzene, thinners or other petroleum based cleaners. Do not place objects made of plastic or rubber directly on top of the cabinet. A chemical reaction could result causing permanent marring of the finish.

## Remote Control Transmitter

Do not use benzene, thinners or other petroleum based cleaners to clean the Remote Control Transmitter. To clean, wipe with a soft cloth slightly moistened with a mild detergent and then wipe dry with a soft clean cloth.

## Models Difference Feature Table

FEATURE \ MODELS	CT-27G2/U	CT-32G2/U	CT-27G12/U	CT-32G12/U
Remote Part #	EUR501371	EUR501371	EUR511000A	EUR511000A
AI Sound	NO	NO	YES	YES
TV Speakers ON/OFF Location	NO	NO	Rear Of Receiver	In Audio Menu
Variable Audio Out Jacks	NO	NO	YES	YES

# Installation

## Receiver Location

This unit is intended to be used with an optional stand or entertainment center. Consult your dealer for available options. Locate for comfortable viewing. Avoid placing where sunlight or other bright light (including reflections) will fall on the screen.

Use of some types of fluorescent lighting may reduce remote control transmitter range.

Adequate ventilation is essential to prevent internal component failure. Keep away from areas of excessive heat or moisture.

To insure optimum color purity do not position magnetic equipment (motors, fans, other speakers, etc.) nearby.

## Optional External Equipment Connections

The Video/Audio connections between components can be made with shielded video and audio cables. For best performance, video cables should utilize 75 ohm coaxial shielded wire. Cables are available from your dealer or electronic supply house.

Before you purchase any cables, be sure you know what type of output and input connectors your various components require. Also determine the length of cable you'll need.

## AC Power Supply Cord

**CAUTION:** TO PREVENT ELECTRIC SHOCK, MATCH WIDE BLADE OF PLUG TO WIDE SLOT OF AC OUTLET AND FULLY INSERT. DO NOT USE THIS (POLARIZED) PLUG WITH A RECEPTACLE OR OTHER OUTLET UNLESS THE BLADE CAN BE FULLY INSERTED TO PREVENT BLADE EXPOSURE.

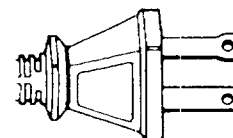

Polarized Plug

## Remote Control Battery Installation

Batteries: Use two "AA" batteries.

1. Remove the battery compartment cover on back of the remote.
2. Install the batteries in the battery compartment. (Polarity (+) or (-) must be correct.)
3. Reattach the battery cover.

To Remove Cover Push In And Up  
On Catch With A Narrow Object

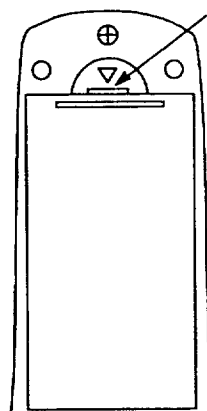

EUR501371

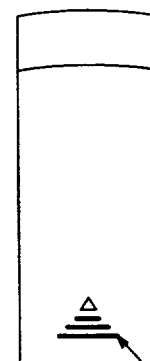

Press Down Here  
And Slide Cover  
Back

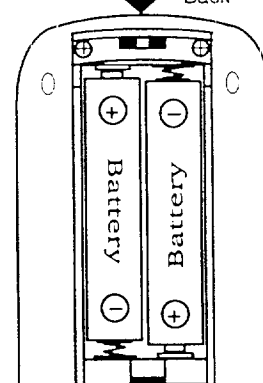

EUR511000A

### Helpful Hints:

For frequent Remote Control users, replace old batteries with Alkaline batteries for longer life.

## Precaution on Battery Use

Incorrect installation can cause battery leakage and corrosion that will damage the Remote Control Transmitter.

### Observe the Following Precautions:

1. Batteries must be replaced as a pair.
2. Do not combine a used battery with a new one.
3. Do not mix battery types (Example: "Zinc Carbon" with "Alkaline").
4. Do not attempt to charge, short-circuit, disassemble, heat or burn used batteries.
5. Battery replacement is necessary when Remote Control reacts sporadically or stops operating the Receiver.

## Installation (cont.)

### Antenna/Cable Connections

**Antenna Connection** – For proper reception of VHF/UHF channels, an external antenna is required. For best reception an outdoor antenna is recommended. **Antenna Mode must be set to TV.** (Refer to Antenna Mode section.)

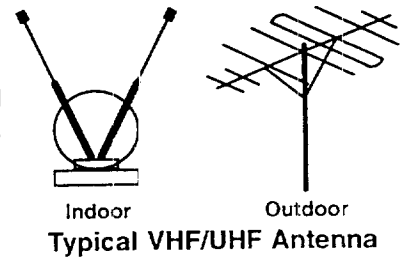

### Incoming Cable from Home Antenna

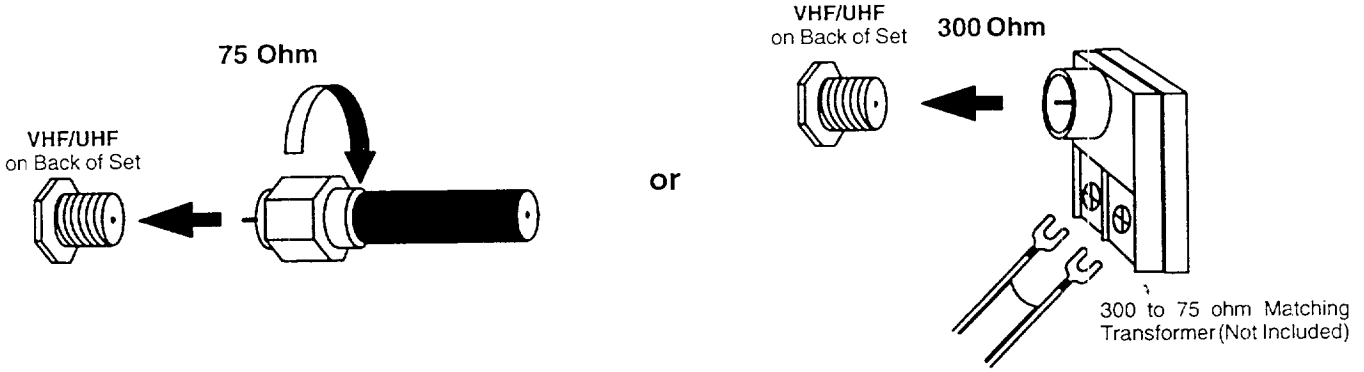

**Cable Connection** – For reception of cable channels, connect the cable supplied by your local cable company. **Antenna Mode must be set to CABLE.** (Refer to Antenna Mode section.)

### Incoming Cable from Cable Company

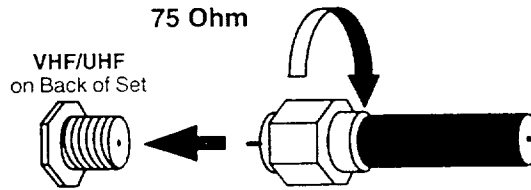

**NOTE:** Certain cable systems offset some channels to reduce interference or have Premium (scrambled) channels. A cable converter box is required for proper reception. Check with your local Cable company for compatibility requirements.

## Other Video Equipment

VCRs, Video Disc Players, Computers, TV games, and DSS equipment can also be connected to the antenna input connection.

# Optional Equipment Connection and Operation

(For CT-27G12/U And CT-32G12/U)

## To Audio AMP Connection

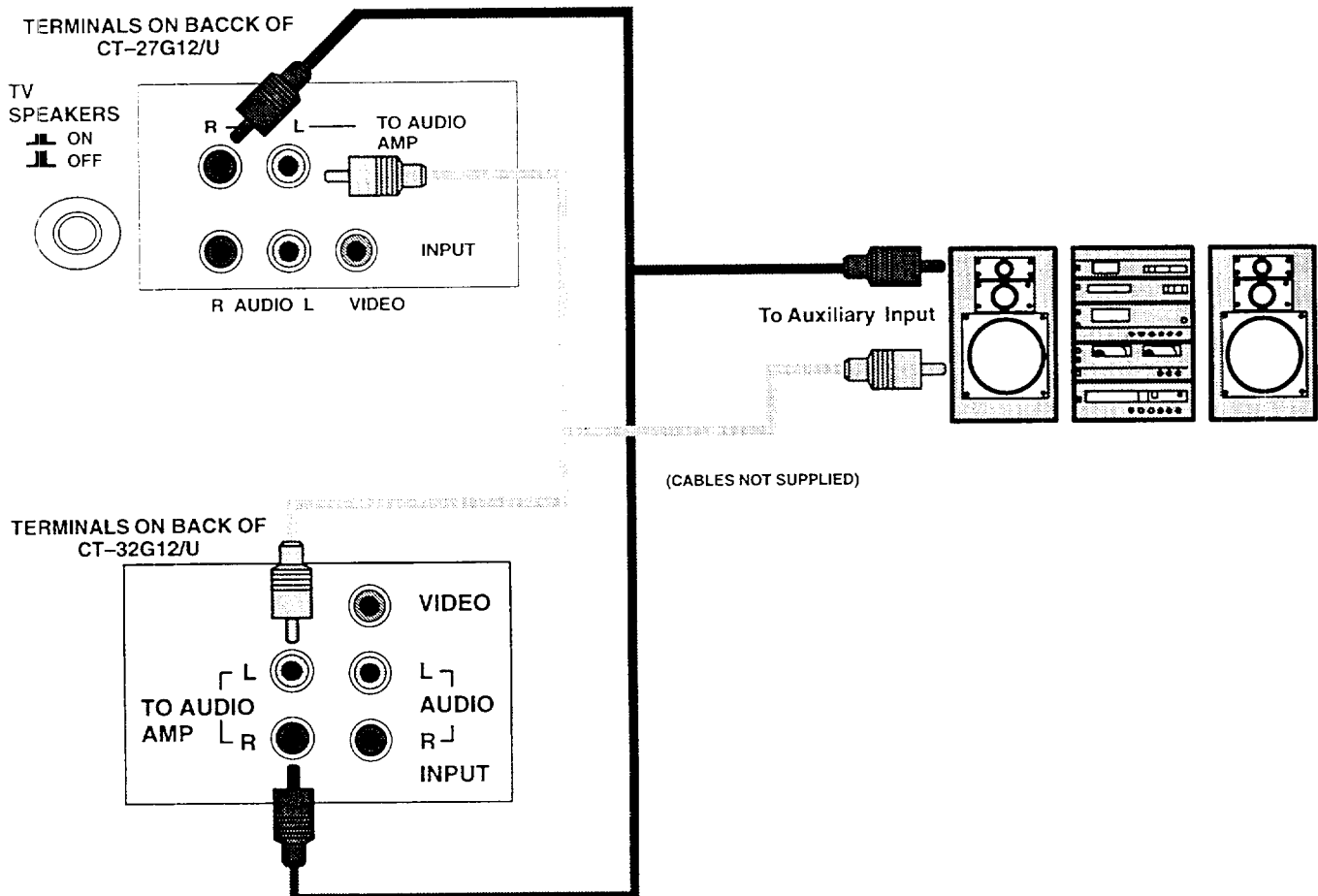

### • To Audio AMP

Connect to an external audio amp auxiliary input for monitoring sound through a stereo system.

**NOTE:** "TO AUDIO AMP" terminals cannot be used for external speakers.

**Adjustment** – When an audio amp is connected to "TO AUDIO AMP" terminals as shown:

1. Press the TV SPEAKERS button located on back of Receiver to turn INT. SPEAKERS "ON". **NOTE:** In some models the TV Speakers ON/OFF is located in the Audio menu.
2. Set volume of audio amp to near minimum.
3. Adjust volume of TV to desired listening level.
4. Adjust volume of audio amp to match the level of TV.
5. Press the TV SPEAKERS button located on back of Receiver to turn INT. SPEAKERS "OFF". **NOTE:** In some models the TV Speakers ON/OFF is located in the Audio menu.
6. Volume and mute can now be controlled by the TV Remote Control.



# Optional Equipment Connection and Operation (Cont.)

## Audio/Video Input Connection

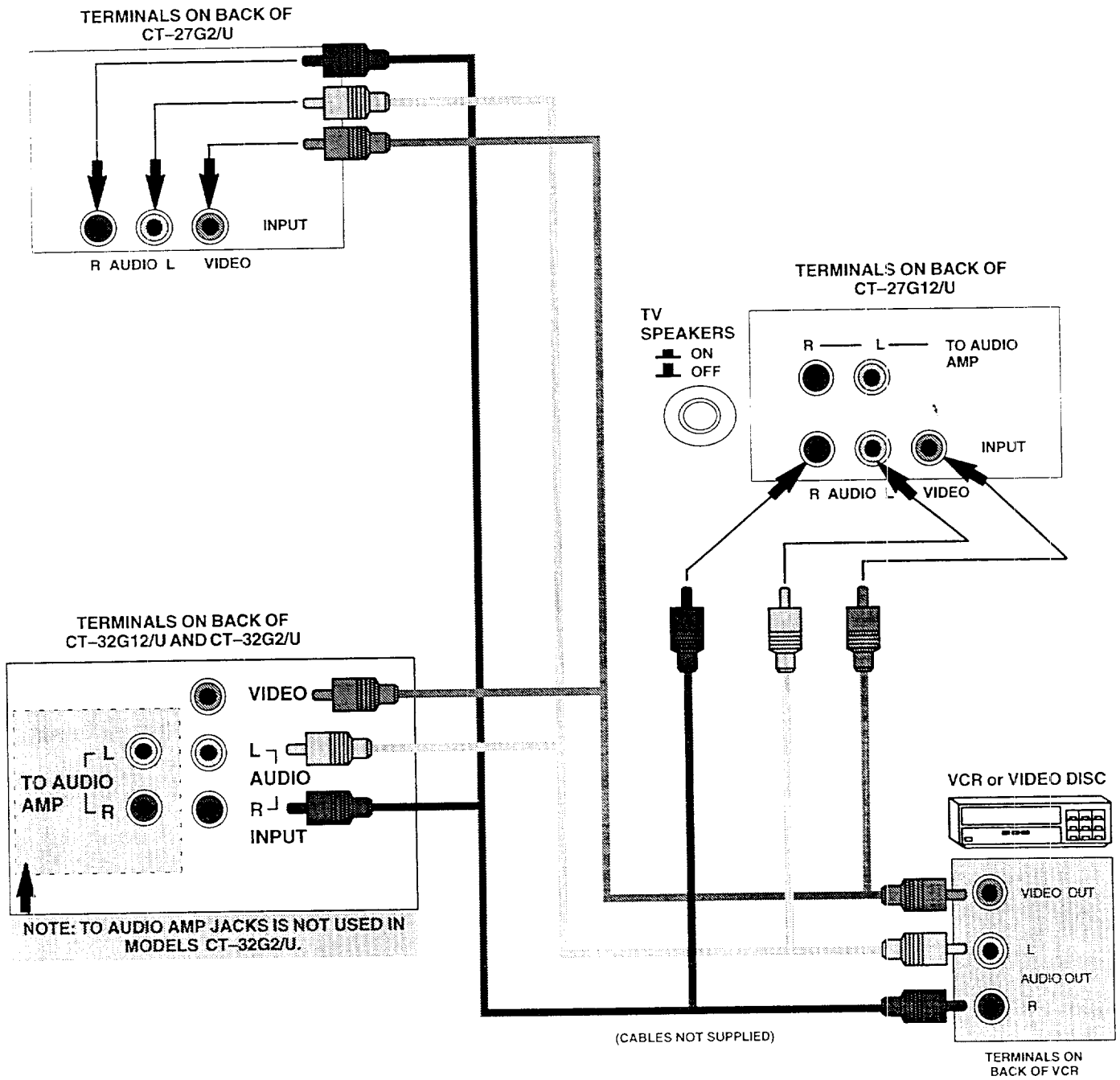

### Operation

1. Connect optional equipment as shown to Rear Audio/Video Input Jacks.
2. Select the Video mode by pressing the TV/VIDEO button.
3. Operate optional equipment as instructed in Optional Equipment manual.

# Location of Controls Remote

(For CT-27G2/U and CT-32G2/U)

## Power Button

Press to turn ON or OFF.

## Mute Button

Press to mute sound. A second press resumes sound. Press also to access and delete Closed Caption.

## Volume Buttons

Press to adjust TV sound level. Use with Channel buttons to navigate in menus.

## Keypad Buttons

Press desired channel number to randomly access any channel.

## R-Tune (Rapid Tune) Button

Press to switch to the previous channel.

## TV/Video Button

Press to select TV or Video Input.

## Channel Buttons

Press to select channels. Use with Volume buttons to navigate in menus.

## Action Button

Press to display Main Menu and access or exit On Screen feature and Adjustment Menus.

## Recall Button



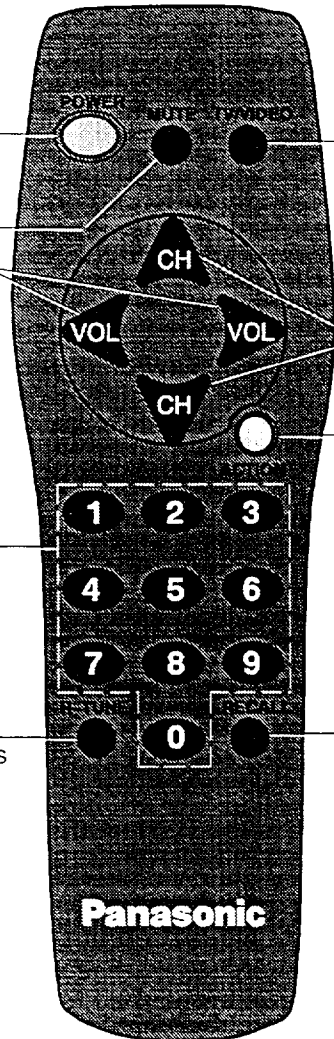







Press to display Time, status of Sleep Timer, Channel, Video Mode, Channel Caption (Station Identifier) and Audio Mode.

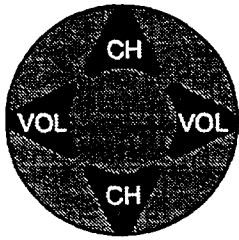

EUR501371

# Remote Quick Reference Functional Key Chart

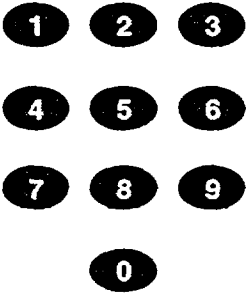
## (For CT-27G2/U and CT-32G2/U)

KEY	OPERATES	FUNCTION
POWER 	TV	Turns TV On and Off
MUTE 	TV	Mutes TV Audio Access Closed Caption
TV/VIDEO 	TV	Selects the TV Input Mode
ACTION 	TV	Activates TV Menus
	TV  TV  TV  	Channel Up/Down, Menu Navigation  Volume Up/Down, Menu Navigation
	TV	Selects Channel Selects code in Game Guard Menu Selects Channel in Channel Caption Menu Selects Channel in Timer Menu
R-TUNE 	TV	Selects Previously Tuned Channel
RECALL 	TV	Displays Channel, Time, and Audio Mode

# Location of Controls Remote

## (For CT-27G12/U And CT-32G12/U)

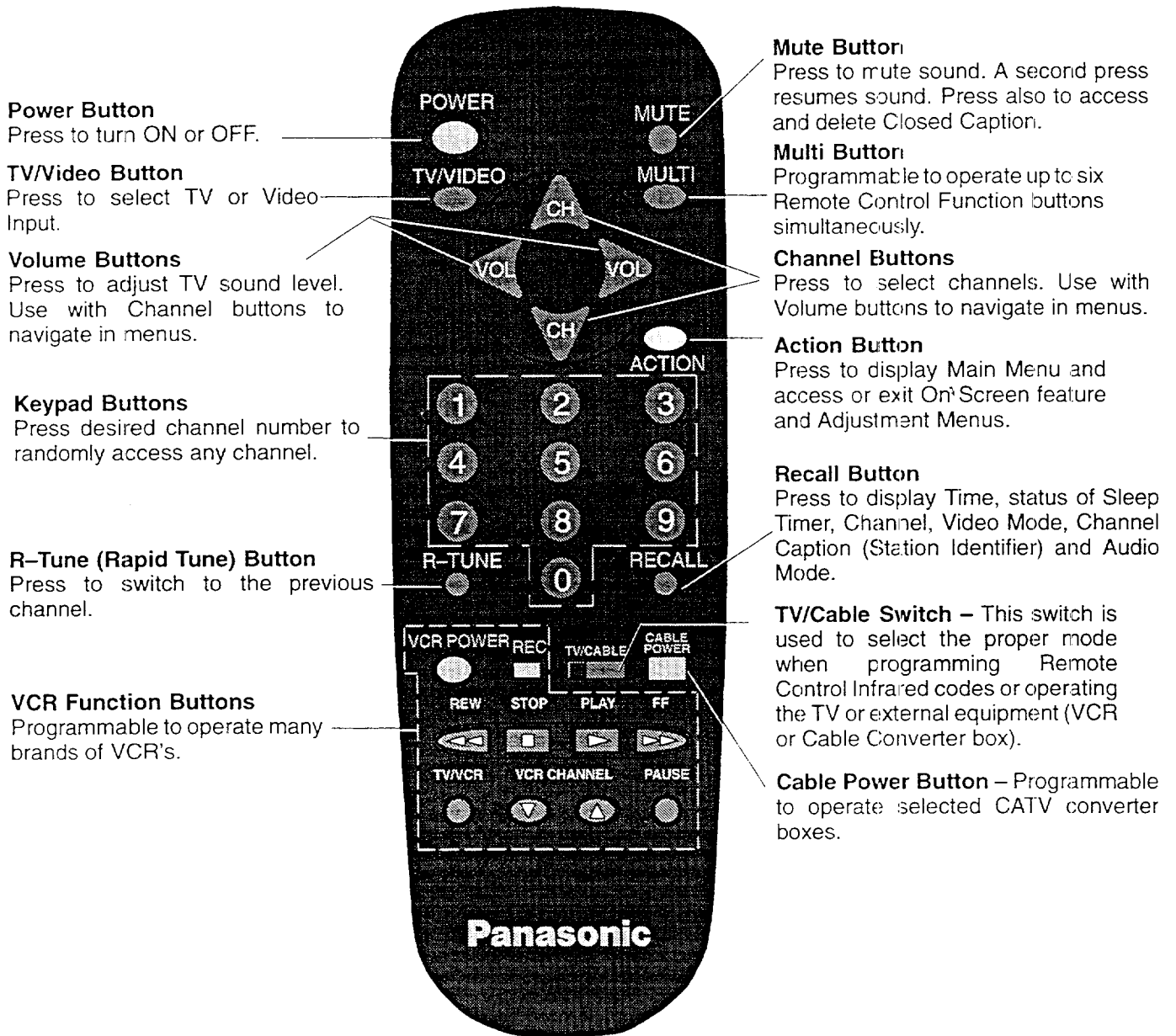

EUR511000A

# Remote Quick Reference Functional Key Chart

## (For CT-27G12/U And CT-32G12/U)

KEY	OPERATES	FUNCTION
POWER 	TV	Turns TV On and Off
MUTE 	TV	Mutes TV Audio Access Closed Caption
TV/VIDEO 	TV	Selects the TV Input Mode
MULTI 	ALL COMPONENTS	Programmable Button that can operate up to six Remote Functions at once
ACTION 	TV	Activates TV Menus
	TV CABLE	Channel Up/Down, Menu Navigation Channel Up/Down
	TV CABLE	Volume Up/Down, Menu Navigation Search For Infrared Code When Programming Remote
	TV  VCR CABLE	Selects Channel Selects code in Game Guard Menu Selects Channel in Channel Caption Menu Selects Channel in Timer Menu  Selects Infrared code when programming remote Selects Infrared code when programming remote
R-TUNE 	TV	Selects Previously Tuned Channel
RECALL 	TV	Displays Channel, Time, and Audio Mode
TV/CABLE 	TV  CABLE	TV Mode Selection for Remote Control Also VCR Mode Selection for Remote Control  CATV Mode Selection for Remote Control
CABLE POWER 	CABLE	Turns Cable On and Off
VCR POWER 	VCR	Turns VCR On and Off
	VCR	<b>Standard VCR Control Keys</b> Record Rewind Stop Play Fast Forward Selects TV/VCR Mode VCR Channel Up/Down Pause

# Location of Controls Receiver

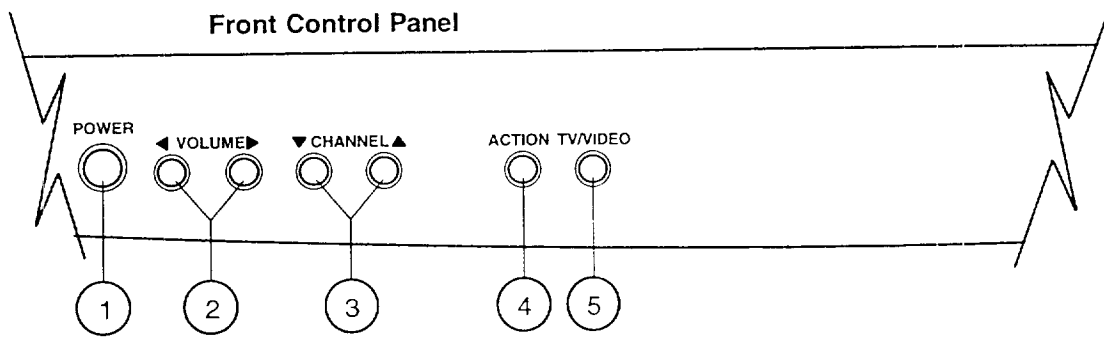

- ① **Power Button** – Press to turn ON or OFF.
- ② **Volume Buttons** – Press to adjust Sound Level. Press to adjust Audio Menus, Video Menus and select operating features when menus are displayed.
- ③ **Channel Buttons** – Press to select programmed channels. Press to highlight desired features when menus are displayed.
- ④ **Action Button** – Press to display Main Menu and access On Screen feature and Adjustment Menus.
- ⑤ **TV/Video Button** – Press to select TV or Video Input.

# Special Functions

**R-Tune Button** – Pressing  will switch between the last two channels selected on the numeric keypad.

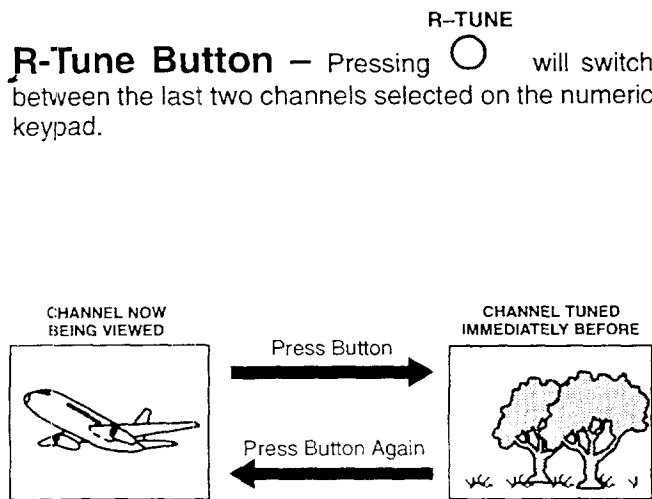

**Recall Button** – Press  to review:

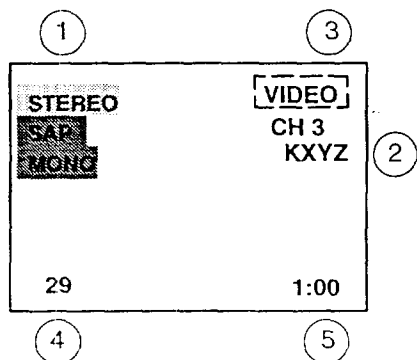

- ① Audio Mode Status
- ② Channel Caption (Station Identifier)
- ③ CH Number Or Video Input Selected
- ④ Sleep Timer Status
- ⑤ Clock Time



## Cable Power Button

(Not used in CT-27G2/U and CT-32G2/U)

The  on the Remote Control has been designed to operate selected brands of Cable Television Converter boxes. The proper cable television converter box infrared code must be obtained prior to use. (Please refer to Programming the Universal Remote for programming instructions.) The Remote Control TV/CABLE switch should be in the CABLE position.

**NOTE:** The  or  on the Remote may be used for selecting Cable Converter box channels.

## Multi Button

(Not used in CT-27G2/U and CT-32G2/U)

The **MULTI** button can be programmed to operate up to 6 Remote function buttons at the same time.

**For Example:** TV Power/On, VCR Power/On (selected brands) can be operated at the same time with one press of the MULTI button.

### Procedure

1. First program the Remote for the selected VCR Infrared access code. Confirm that the Remote Control is compatible with the equipment.
2. Face the Remote Control transmitter away from all equipment remote sensors.
3. Press and hold down the Remote TV Power button, then press and hold down the MULTI button at the same time. Release buttons (All previous commands will be erased.)

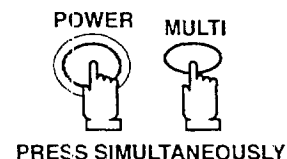

4. Press a maximum of 6 Function buttons on the Remote.

Each button you press is equal to one function. If six Remote button functions are entered, all will register in the MULTI button memory in the sequence entered. When less than six Remote button functions are entered, press the MULTI button to end the program mode. (Waiting more than 30 seconds without pressing another button will also end the program mode.)

The following is an example of Remote functions that can be programmed into the MULTI button.

- TV Power – For turning TV ON and OFF.
- VCR Power – For turning VCR ON and OFF (selected brands after programming it's Infrared access code, if necessary).

Both can be turned ON or OFF with one press of the MULTI button.

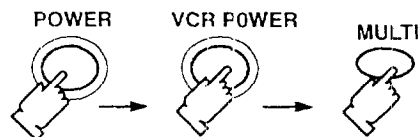

**To delete entered functions** – Repeat step 3. Now you can enter from one to six different Remote functions.

**NOTE:** You can also program the MULTI button to perform most individual Remote Control button functions. Buttons which continuously perform a function as long as pressed (Volume Up/Down, Channel Up/Down, etc.) cannot be programmed. Only those buttons which perform a function when initially pressed (Power On/Off, Mute, Direct Channel Entry, etc.) can be programmed.

## Main Menu Icons

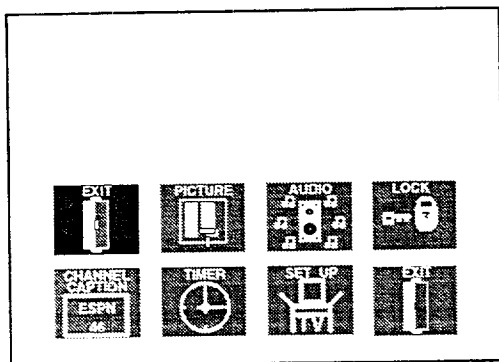

**NOTE:** When Auto Power On feature is activated, Timer Icon will change to Exit Icon.



Display and Exit Menus

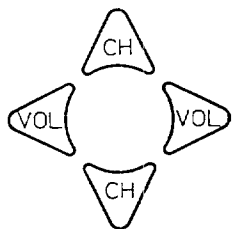

**CH BUTTONS**  
Highlight Desired Feature when Menu is Displayed

**VOL BUTTONS**  
Selects or Adjusts Features when Menu is Displayed

Located On Remote Control

1. Press .
2. Press and to select the desired icon.
3. Press after selecting the desired icon to access sub menus.
4. Press twice to exit sub menus or press once while the EXIT icon is highlighted to exit Main Menu.

## Menu Language Selection

The MENU LANGUAGE is factory set to ENGLISH. Follow the instructions to change the Menu Language to SPANISH, FRENCH, and back to ENGLISH.

1. Press .
2. Press and to highlight the Set-Up icon.
3. Press to display the Set-Up Menu.

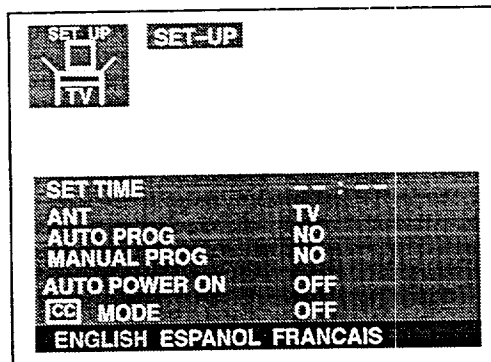







4. Press to highlight ENGLISH, ESPAÑOL, FRANÇAIS.
5. Press to select ENGLISH, ESPAÑOL, or FRANÇAIS.
6. Press twice to exit menus.







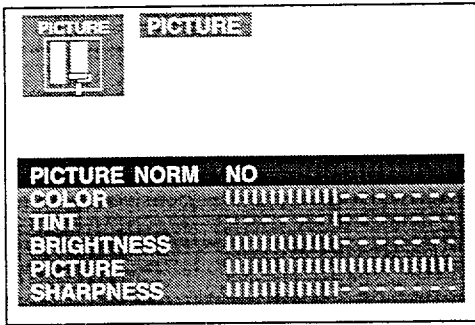

# Picture Adjustments

## Picture Norm







Use to reset Color, Tint, Brightness, Picture, and Sharpness adjustments back to a factory preset level.

1. Press .
2. Press  or  and  or  to highlight the Picture Icon.
3. Press  to display the Picture Adjustment Menu.





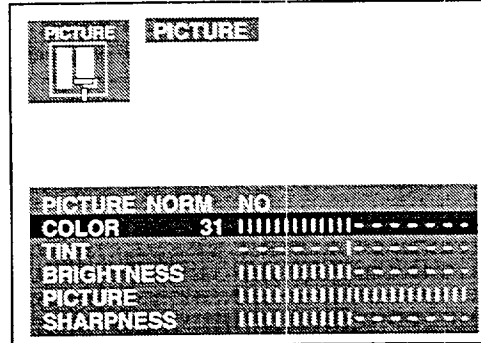

4. Press  or  to highlight PICTURE NORM.
5. Press  or  to select "SET" to normalize Color, Tint, Brightness, Picture, and Sharpness.
6. Press  twice to exit menus.

# Color, Tint, Brightness, Picture, and Sharpness Adjustments

1. Press .
2. Press  or  and  or  to highlight the Picture Icon.
3. Press  to display the Picture Adjustment Menu.









4. Press  or  to select the desired Picture Adjustment (Color, Tint, Brightness, Picture, or Sharpness).
5. Press  or  to adjust your selection. (The Selected Picture Adjustment will be displayed.)
6. Repeat steps 4 and 5 for the remaining Picture Adjustments.
7. Press  twice to exit menus.



# Audio Adjustments

## Mode

When Audio is broadcast in Stereo or SAP, an On-Screen display will appear on initial "Turn On" and "Channel Change". The available choices will be highlighted.

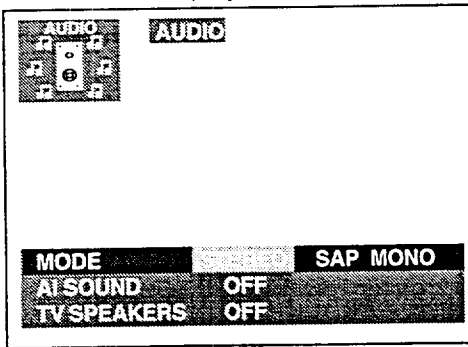





1. Press  .
2. Press  or  and  or  to highlight the Audio Icon.
3. Press  to display the Audio Adjustment Menu.







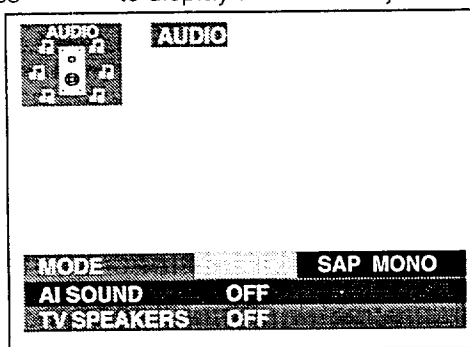

4. Press  or  to select STEREO, SAP (Second Audio Programming), or MONO. The selected mode will be highlighted.
5. Press  twice to exit menus.

## AI Sound (Not used in CT-27G2/U and CT-32G2/U)

This feature regulates the volume between programs and commercial audio to maintain a constant sound output level.







1. Press  .
2. Press  or  and  or  to highlight the Audio Icon.
3. Press  to display the Audio Adjustment Menu.







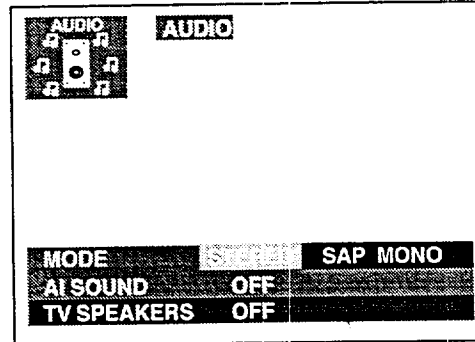

4. Press  or  to highlight AI SOUND.
5. Press  or  to select ON or OFF.
6. Press  twice to exit menus.

## TV Speakers (Used in CT-32G12/U only)

This feature is used to turn the internal speakers "ON" or "OFF". It is used when the TV is connected to an External Audio Amplifier. (Refer to "To Audio Amp Connection" section for further information.)

1. Press  .
2. Press  or  and  or  to highlight the Audio Icon.
3. Press  to display the Audio Adjustment Menu.









4. Press  or  to highlight TV SPEAKERS.
5. Press  or  to select ON or OFF.
6. Press  twice to exit menus.



# Lock

## Lock Game Guard

Prevents video games and other video sources from being viewed. Channel 3, 4 and video inputs are locked out for 12, 24 or 48 hours. **NOTE:** Be sure to understand this feature before attempting its use. **Use a code that you will easily remember or write the code on a piece of paper.**

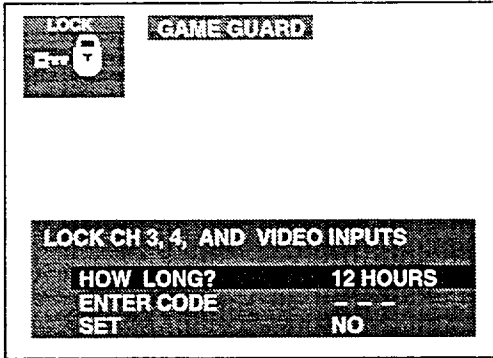
1. Press  .
2. Press  or  and  or  to highlight the Lock Icon.
3. Press  to display the Lock Menu.



4. "HOW LONG" should already be highlighted. Press  to select the desired amount of time (12, 24 or 48 hours) for Game Guard Lockout to be activated.
5. Press  to highlight ENTER CODE. Then enter a 3 digit code with the Remote Control Keypad. "SET" should be highlighted after entering the last digit. **IMPORTANT NOTE:** Use a code you can easily remember or write the code on a piece of paper.
6. Press  after entering three digit code. "Game Guard Locked" will display On Screen.

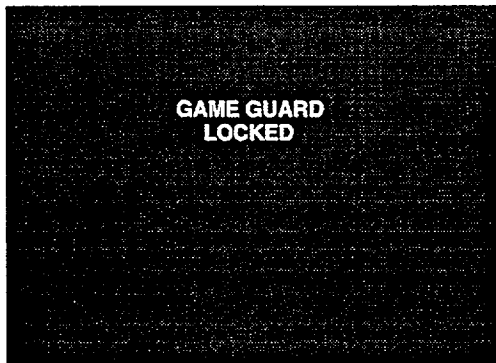

Game Guard Activated

## Unlock Game Guard

To unlock the Game Guard feature, repeat steps 1 through 3. Enter the same 3 digit code previously used in step 5 with Remote Control Keypad.

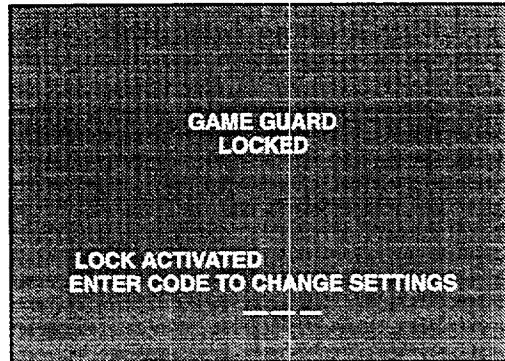

Enter Same 3 Digit Code Previously Used

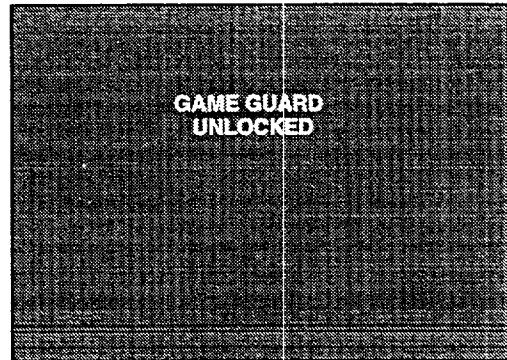

If 3 Digit Code s The Same

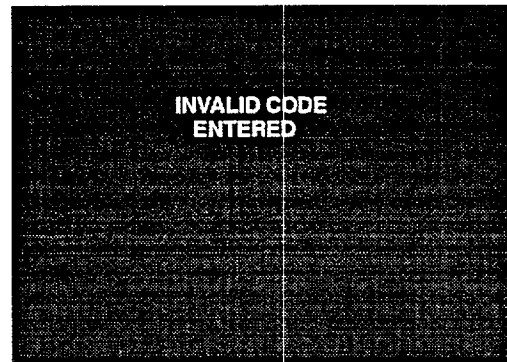

If 3 Digit Code Is Not The Same

# Channel Caption

This feature allows you to enter the call names of up to 30 stations into memory (using up to 4 characters for each station). The call name will then display along with the channel number when changing channels or pressing RECALL.

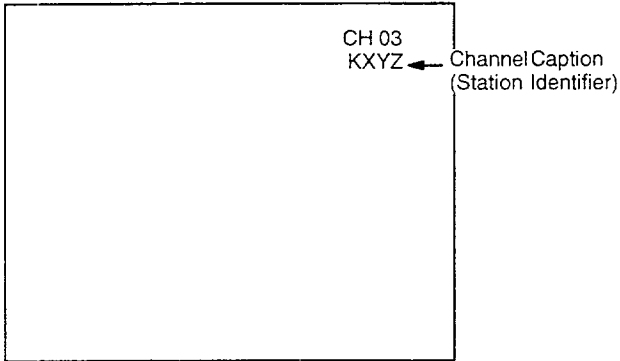

1. Press **ACTION**.
2. Press **CH** or **CH** and **VOL** or **VOL** to highlight the Channel Caption Icon.
3. Press **ACTION** to display the Channel Caption Menu.

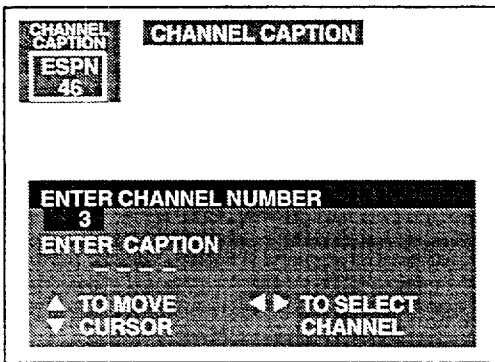

4. Press **VOL** or **VOL**, or use the Remote Control Keypad to enter the channel number you wish to assign a Station Identifier.
5. Press **CH** to highlight ENTER CAPTION.
6. Press **VOL** or **VOL** to select first character in Station Identifier. Then press **CH** to move cursor to the second position and repeat until the complete Station Identifier is entered (up to 4 characters).
7. Press **CH** or **CH** to highlight ENTER CHANNEL NUMBER. Then repeat steps 4 through 6 to continue adding Channel Station Identifier(s).
8. Press **ACTION** twice to exit menus.

**NOTE: To delete** a Channel Caption (Station Identifier) from memory all four character positions in the "ENTER CAPTION" area must display a dash mark (-).

## Helpful Hints:

When the Maximum amount of station identifiers are entered, "FULL" will be displayed in the caption position.

# Timer Features

## Sleep Timer

This feature is used for automatic turn off in 30, 60 or 90 minutes. Display will flash 3, 2 and 1 to indicate the last three remaining minutes prior to turn off. The Recall display will also appear.

**NOTE: This feature will be disabled when Auto Power On is activated.**

1. Press **ACTION**.
2. Press **CH** or **CH** and **VOL** or **VOL** to highlight the Timer Icon.
3. Press **ACTION** to display the Timer Control Menu.

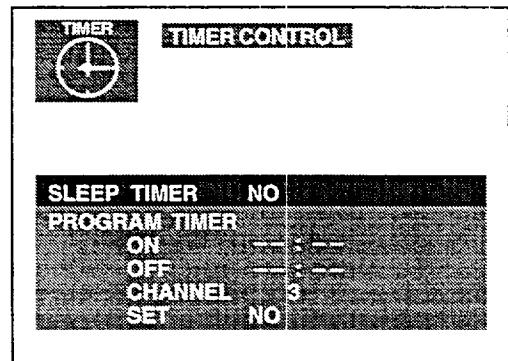

4. Press **VOL** to select NO, 30, 60 or 90 minutes (Sleep Timer will be activated).
5. Press **ACTION** twice to exit menus.

**NOTE: To deactivate** Sleep Timer repeat steps 1 through 4. In step 4 select "NO" instead of minutes.

## Helpful Hints:

Press the RECALL button to display the remaining minutes for Sleep Timer, the status will display in the bottom left corner.

## Timer Features (cont.)

### Special Feature:

#### Automatic turn "OFF" after 90 minutes.

The TV has a special feature that will shut itself **OFF** after 90 minutes when turned **ON** by the program timer unless a function key is pressed during the 90 minutes.





This feature is useful so that the TV will not remain **ON** unattended for an extended period of time.

Programming the **OFF** timer will cancel the automatic **OFF** Special Feature.





## Program Timer

This feature is capable of turning the TV on, tuned to a desired channel and off at a predetermined time (one day or daily). The clock must be set for this feature to operate. (Refer to the Set-Up Menu to set time.)

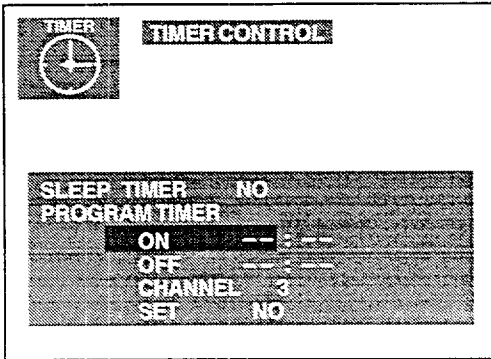
**NOTE: This feature will be disabled when Auto Power On is activated.**

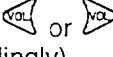
1. Press .
2. Press  or  to highlight the Timer Icon.
3. Press  to display the Timer Control Menu.

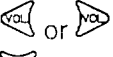

4. Press  to highlight ON (time).
5. Press  repeatedly to set hours (set AM/PM accordingly).
6. Press  to highlight the minutes position.
7. Press  repeatedly to set minutes.
8. Press  to highlight OFF (time).

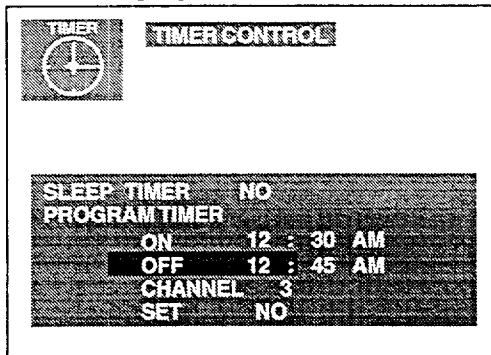

9. Repeat steps 5 through 7 for setting OFF (time).

10. Press  to highlight CHANNEL.

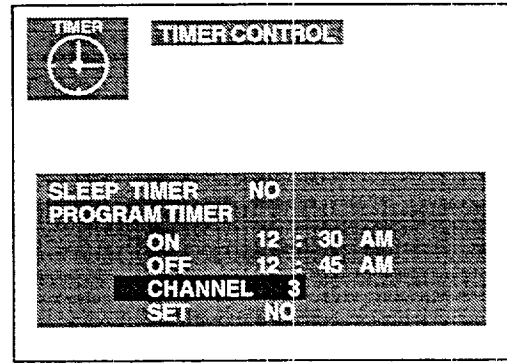

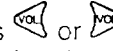
11. Press  or use the Remote Control Keypad to enter the channel number desired when the set turns "ON".

12. Press  to highlight SET.

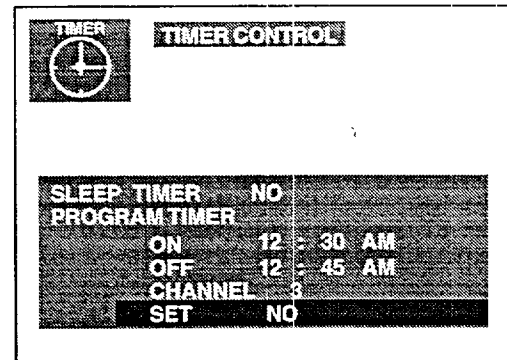

13. Press  to select:

- NO – not activated
- ONE DAY – activated
- DAILY – activated

14. Press  twice to exit menus.

**NOTE: To deactivate Program Timer select NO in step 13.**

### Helpful Hints:



- If the Program Timer "ON" functions while the set is operating, the set will automatically tune to the channel designated in the "Timer Program."

# Set-Up Features



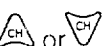
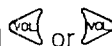

## Set Time

Clock (when set) will display on screen at initial "Turn On", after a channel change and when pressing the RECALL button. The time must be set first in order to operate the Program ON/OFF Timer.

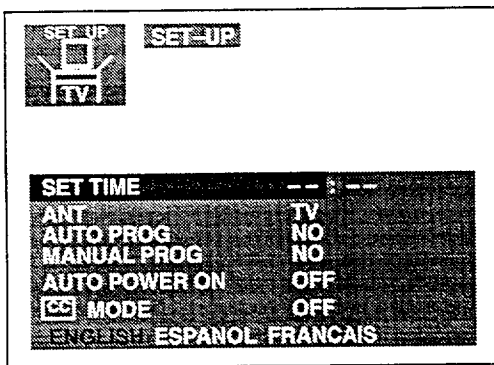
**NOTE: This feature will be disabled when Auto Power On is activated.**

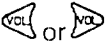
1. Press .
2. Press  or  to highlight the Set-Up Icon.
3. Press  to display the Set-Up Menu.

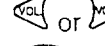



4. Press  to set hours (set AM/PM accordingly).
5. Press  to select minutes position.
6. Press  repeatedly to set minutes.
7. Press  twice to exit menus.

## Antenna (Ant)

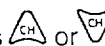
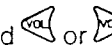

The proper Input mode must be selected for the type of signal at the antenna input.

- TV mode is used when the Receiver is not connected to a cable TV system, for example when using a VHF/UHF antenna (channels 02 – 69).
- Cable mode is used when the Receiver is connected to a Cable TV system and you are not using a cable company converter box (channels 01 – 125).

**NOTE: This feature is disabled when Game Guard Lock is activated.**

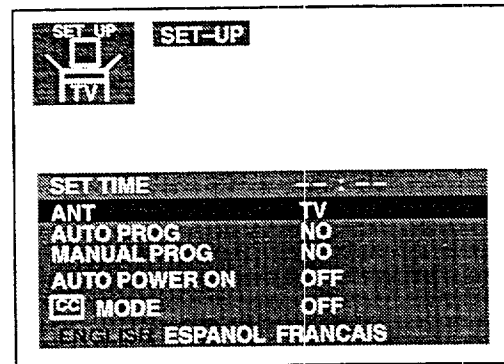
1. Press .
2. Press  or  to highlight the Set-Up Icon.
3. Press  to display the Set-Up Menu.

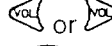



4. Press  to highlight ANT.
5. Press  to select TV or CABLE.
6. Press  twice to exit menus.

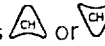
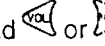

## Auto Prog

This feature allows you to place all channels with a video signal into Channel Scan Memory.

**NOTE: This feature is disabled when Game Guard Lock is activated.**

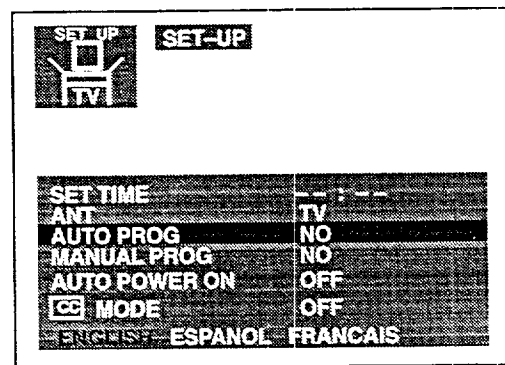
1. Press .
2. Press  or  to highlight the Set-Up Icon.
3. Press  to display the Set-Up Menu.

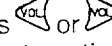







4. Press  to highlight AUTO PROG.
5. Press  to start Auto Programming. Channels will automatically advance until all channels have been scanned.
6. Press  twice after completion of Auto Programming to exit menus.

**NOTE: Channel numbers with signal present will turn blue which indicates stored in Channel Scan Memory.**



## Set-Up Features (cont.)

### Manual Prog

This feature allows you to select which channels are placed into Channel Scan Memory.

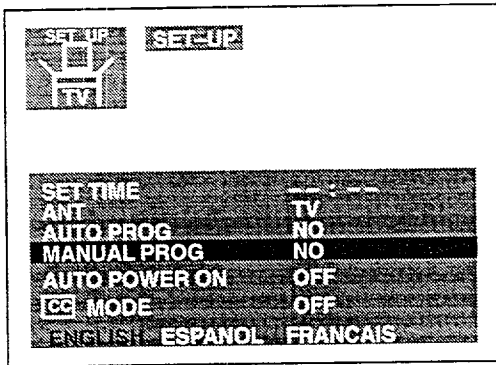



1. Press .
2. Press  or  and  or  to highlight the Set-Up Icon.
3. Press  to display the Set-Up Menu.

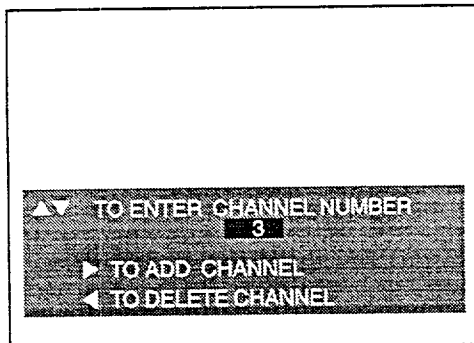

4. Press  to highlight MANUAL PROG.
5. Press  or  to display the Manual Programming Menu.

**NOTE: This feature is disabled when Game Guard Lock is activated.**







6. Use the  or  or the Remote Keypad "0 through 9" buttons to select channels.
7. Press  to **add** channel(s) to memory (Blue). Press  to **delete** channels from memory (Yellow).
8. Repeat steps 6 and 7 to continue adding or deleting channels.
9. Press  twice to exit menus.

### Auto Power On





This feature allows the user to power up the TV at the same time as the cable box (or other components). Of course, the TV must be plugged into the cable box.

**NOTE: When this feature is activated (on), Timer features will be disabled.**

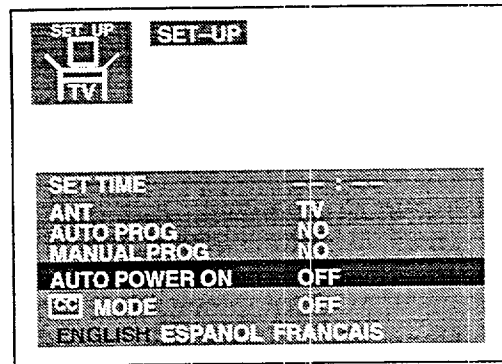
1. Press .

2. Press  or  and  or  to highlight the Set-Up Icon.
3. Press  to display the Set-Up Menu.



4. Press  to highlight AUTO POWER ON.
5. Press  or  to select SET or OFF.
6. Press  twice to exit menus.







### CC (Closed Caption) Mode

This Receiver has a built in decoder that provides a visual depiction of the audio portion of a television program, in the form of written words across the screen (White or Colored letters on a black background). It allows the viewer to read the dialogue of a television program or other information.



**When the Closed Caption is in the OFF Mode:**

**The viewer may display closed caption by pressing**

 on the remote control. Press again to delete.

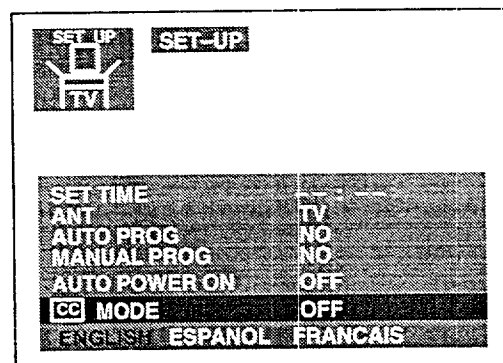
1. Press .
2. Press  or  and  or  to highlight the Set-Up Icon.
3. Press  to display the Set-Up Menu.



4. Press  to highlight CC MODE.
5. Press  to select OFF, C1, or C2.
6. Press  twice to exit menus.

# Programming The Universal Remote

(For CT-27G12/U and CT-32G12/U)

## VCR

### Preferred Procedure – Code Known Programming Universal Remote Using Infra-Red Access Codes for VCRs

- Determine brand of VCR.
- Identify code(s) associated with the brand in the infra-red code index for VCRs (located in this manual).

#### Procedure

1. Place the Remote  into the TV position (Left).

2. Press and hold  down on Universal Remote.

3. Enter two digit code using keypad “0 through 9” buttons.

Release . The Universal Remote is now programmed.

**NOTE:** Some brands have multiple codes. Repeat procedure using each code listed until VCR responds correctly.

### Alternate Procedure – Code Unknown Programming Universal Remote Using the “Sequence Method” for VCRs



- Confirm VCR is plugged in and operating properly, then turn OFF.

#### Procedure

1. Place the Remote  into the TV position (Left).

2. Press and hold the  down on Universal Remote.

3. Press  repeatedly. Check for the VCR to turn ON after each press. When the VCR turns ON, release VCR Power button. The proper infra-red code has now been accessed.

- It may take several attempts before the correct code is found.
- The  can be used to return to a code that was accidentally passed by.
- Some Remote Controls may have unique operating functions for some buttons. For Example: The POWER button may only turn the VCR OFF as opposed to both ON and OFF. It will then be necessary to modify the procedure. Turn the VCR ON and repeatedly press the  until the VCR turns OFF.

**NOTE:** When operating equipment (VCR or Cable Converter box) with the Universal Remote Control, the TV/CABLE Switch should be set to the same position where the Access Code was first programmed for the equipment. Otherwise, leave the switch in the TV position.

## Cable Converter Box

### Preferred Procedure – Code Known Programming Universal Remote Using Infrared Access Codes for Cable Television Converter Boxes

- Determine brand of Cable Television Converter box.
- Identify code(s) associated with the brand in the infra-red code index for Cable Television Converter boxes (located in this manual).

#### Procedure

1. Place the Remote  into the CABLE position (Right).

2. Press and hold the  down on Universal Remote.

3. Enter two digit code using keypad “0 through 9” buttons.

Release . The Universal Remote is now programmed. Use the Remote  and  for

selecting Cable Converter Box channels.

**NOTE:** Some brands have multiple codes. Repeat procedure using each code listed until Cable Television Converter box responds correctly.

### Alternate Procedure – Code Unknown Programming Universal Remote Using the “Sequence Method” for Cable Television Converter Boxes



- Confirm Cable Television Converter box is plugged in and operating properly, then turn OFF.

#### Procedure

1. Place the Remote  into the CABLE position (Right).

2. Press and hold  down on Universal Remote.

3. Press  repeatedly. Check for the Cable Television Converter box to turn ON after each press. When the Cable Television Converter box turns ON, release Cable Power button. The proper infrared code has now been accessed.

- It may take several attempts before the correct code is found.
- The  can be used to return to a code that was accidentally passed by.
- Some Remote Controls may have unique operating functions for some buttons. For Example: The POWER button may only turn the Cable Television Converter box OFF as opposed to both ON and OFF. It will then be necessary to modify the procedure. Turn the Cable Television Converter box ON and repeatedly press the  until the Cable Television Converter box turns OFF.



# VCR and Cable Converter Box Infrared Codes Index

## (For CT-27G12/U and CT-32G12/U)

The Universal infrared Remote Control is capable of operating many brands of VCRs and Cable Television Converter Boxes after entering the proper infrared code.

**NOTE:** The Universal Remote Control memory is limited. Some models of VCRs or Cable Television Converter Boxes may not operate. The Universal Remote Control is not designed to control all features that are available in all models.

### Infrared Code Index For VCRs















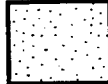

VCR Brand	Code(s)	VCR Brand	Code(s)
Audio Dynamics	14, 16	NEC	02, 14, 16, 30
Broksonic	10	Panasonic	00, 01
Canon	00, 01	Pentax	05
Capehart	01	Philco	00, 29
Citizen	09	Philips	00, 29
Craig	12	Pioneer	05
Curtis Mathes	00, 08, 15	Quasar	00, 01
DBX	14, 16	RCA	05, 07, 08, 28, 35
Emerson	10, 20, 34, 35, 36, 37	Realistic	00, 02, 06, 12, 15
Fisher	12, 18, 19	Samsung	07, 32
Funai	15	Sanyo	02, 12
GE	00, 07, 08, 32	Scott	04, 13, 33, 36
Goldstar	09	Sears	02, 05, 18, 19
Hitachi	05, 35, 36	Sharp	06, 24
Instant Replay	00	Sony	17, 26, 33, 34
JC Penney	00, 02, 05, 14, 16, 30	Sylvania	00, 29
JVC	02, 14, 16, 30	Symphonic	15
Kenwood	02, 14, 16, 30	Tashiko	09
Magnavox	00, 29	Tatung	30
Marantz	02, 14, 16, 29, 30	Teac	15, 30
Marta	09	Teknika	21
Memorex	00, 12	Toshiba	05, 13
MGA	04, 27	Vector Research	14, 16
Minolta	05	Video Concepts	14, 16
Mitsubishi	04, 27	Wards	06
Montgomery Ward	06	Yamaha	02, 14, 16, 30
Multitech	07, 15, 32	Zenith	11, 17

### Infrared Code Index For Cable Television Converter Box

Brand of Cable-TV Box	Code(s)	Brand of Cable-TV Box	Code(s)
G.I.	04, 05, 15, 23, 24, 25, 30, 36	Pioneer	18, 20
Hamiin	12, 13, 34	RCA	27
Jerrold	04, 05, 15, 23, 24, 25, 30, 36	Regency	02
Macom	27	Scientific Atlantic	03, 22
Magnavox	19, 26, 28, 29, 32, 33, 40, 41	Sylvania	11
Oak	14, 16, 18	Texscan	10, 11
Oak Sigma	16	Tocom	17, 21
Panasonic	27, 39	Unika	31
Philips	19, 26, 28, 29, 32, 33, 40, 41	Viewstar	19, 26, 28, 29, 32, 33, 40, 41
		Zenith	01, 42

# Troubleshooting Chart

Before you call for service, determine the symptoms and make a few simple checks shown below.

Symptoms		Check
Picture	Sound	
 SNOWY PICTURE	 NOISY SOUND	- ANTENNA LOCATION AND/OR CONNECTION
 MULTIPLE IMAGE	 NOISY SOUND	- ANTENNA DIRECTION AND/OR LOCATION - ANTENNA LEAD-IN WIRE
 INTERFERENCE	 NOISY SOUND	- ELECTRICAL APPLIANCES, LIGHTS, CARS AND TRUCKS - DIATHERMY AND OTHER MEDICAL EQUIPMENT
 NORMAL PICTURE	 NO SOUND	- VOLUME CONTROL SETTING - MUTE CONTROL (IF APPLICABLE) - TRY ANOTHER CHANNEL - TV SPEAKERS SWITCH (IF APPLICABLE) IN THE OFF POSITION
 NO VIDEO	 NOISY SOUND	- TV OR CABLE TUNING MODE SET TO PROPER SETTING - ANTENNA INPUT CORRECT (IF APPLICABLE)
 NO PICTURE	 NO SOUND	- CHECK THAT AC POWER LINE IS PLUGGED INTO AC OUTLET - BRIGHTNESS & AUDIO CONTROLS SET PROPERLY - TRY ANOTHER CHANNEL
 NO COLOR	 NORMAL SOUND	- COLOR CONTROL SETTINGS - TRY ANOTHER CHANNEL
 BLACK PICTURE	 NO SOUND	- RECEIVER IN VIDEO MODE WITH NO SIGNAL

## Power Loss

Prolonged power interruption causes the following features to reset to their factory preset state.

FEATURE	FACTORY PRESET STATE	FEATURE	FACTORY PRESET STATE
POWER	OFF	CLOCK	NOT SET
AUTO POWER ON	NO CHANGE	SLEEP TIMER	OFF
VOLUME	APPROX.-1/3	PROGRAM TIMER	OFF
CHANNEL	CH 03	ANTENNA MODE	CABLE
PROGRAM MEMORY	UNPROGRAMMED	TV/VIDEO	TV
VIDEO MENUS	NORMALIZED	TRILINGUAL MENU	ENGLISH
STEREO/SAP/MONO	STEREO		

## NOTES:

**Panasonic Consumer Electronics  
Company, Division of Matsushita  
Electric Corporation of America**  
One Panasonic Way  
Secaucus, New Jersey 07094

**Panasonic Sales Company,  
Division of Matsushita Electric  
of Puerto Rico Inc. ("PSC")**  
Ave. 65 de Infanteria, Km 9.5  
San Gabriel Industrial Park  
Carolina, Puerto Rico 00985  
Tel. (787) 750-4300  
FAX. (787) 768-2910

**Panasonic Canada Inc.**  
5770 Ambler Drive  
Mississauga, Ontario L4W 2T3  
Canada