

MAGNAVOX
Smart.Very smart.®

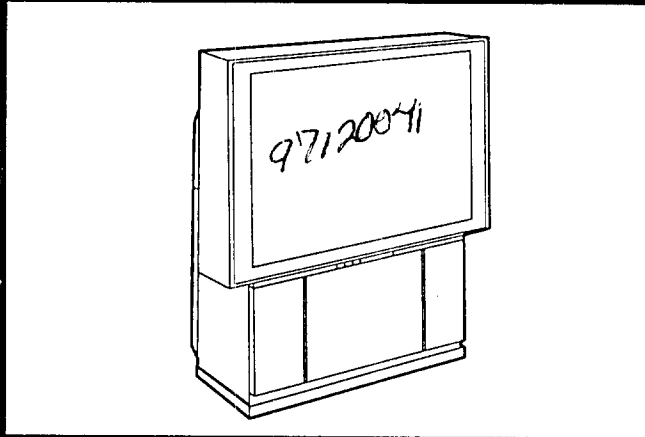

OWNER'S MANUAL

QUESTIONS ABOUT THIS PRODUCT?
CALL OUR INFORMATION CENTER.

800-531-0039

P5240W

IMPORTANT

Return Your
Warranty Registration Card
Within 10 Days.
See Why Inside

MAGNAVOX

Smart.Very smart:

**WARRANTY
REGISTRATION
CARD**

Return your Warranty Registration Card today to ensure you receive all the benefits you're entitled to.

Once your MAGNAVOX purchase is registered, you're eligible to receive all the privileges of owning a MAGNAVOX product. So complete and return the Warranty Registration Card enclosed with your purchase at once. And take advantage of these important benefits:

Warranty Verification

Registering your purchase within 10 days confirms your right to maximum protection under the terms and conditions of your MAGNAVOX warranty.

Owner Confirmation

Your completed Warranty Registration Card serves as verification of ownership in the event of product theft or loss.

Model Registration

Returning your Warranty Registration Card right away guarantees you'll receive all the information and special offers which you qualify for as the owner of your model.

MAGNAVOX
Smart.Very smart.®

**Congratulations on your purchase
-and welcome to the "family!"**

Dear MAGNAVOX product owner:

Thank you for your confidence in MAGNAVOX. You've selected one of the best-built, best-backed products available today. And we'll do everything in our power to keep you happy with your purchase for many years to come.

As a member of the MAGNAVOX "family," you're entitled to protection by one of the most comprehensive warranties and outstanding service networks in the industry.

What's more, your purchase guarantees you'll receive all the information and special offers which you qualify for, plus easy access to accessories from our convenient home shopping network.

And most important of all, you can count on our uncompromising commitment to your total satisfaction.

All of this is our way of saying welcome—and thanks for investing in a MAGNAVOX product.

Sincerely,

Robert Minkhorst
President and Chief Executive Officer

P.S. Remember, to get the most from your MAGNAVOX product, you must return your Warranty Registration Card within 10 days. So please mail it to us right now!

HURRY!
Registration
Needed
Within 10
Days.

KNOW THESE SAFETY SYMBOLS



⚡ This bolt of lightning indicates uninsulated material within your unit may cause an electrical shock. For the safety of everyone in your household, please do not remove product covering.

⚠ The exclamation point calls attention to features for which you should read the enclosed literature closely to prevent operating and maintenance problems.

WARNING TO PREVENT FIRE OR SHOCK HAZARD: DO NOT EXPOSE THIS EQUIPMENT TO RAIN OR MOISTURE

CAUTION: To prevent electric shock, match wide blade of plug to wide slot, and fully insert.

ATTENTION: Pour éviter les chocs électriques, introduire le rame le plus large de la fiche dans la borne correspondante de la prise et pousser jusqu'au fond.

For Customer Use:
Enter below the Serial No. which is located on the rear of the cabinet. Retain this information for future reference.
Model No. _____
Serial No. _____

11/2585

SAFETY INSTRUCTIONS - Read before operating equipment

This product was designed and manufactured to meet strict quality and safety standards. There are, however, some installation and operation precautions which you should be particularly aware of.

1. **Read Instructions** - All the safety and operating instructions should be read before the appliance is operated.
2. **Retain Instructions** - The safety and operating instructions should be retained for future reference.
3. **Heed Warnings** - All warnings on the appliance and in the operating instructions should be adhered to.
4. **Follow Instructions** - All operating and use instructions should be followed.
5. **Water and Moisture** - The appliance should not be used near water - for example, near a bathtub, washbowl, kitchen sink, laundry tub, in a wet basement or near a swimming pool, etc.
6. **Carts and Stands** - The appliance should be used only with a cart or stand that is recommended by the manufacturer.
- 6A.  An appliance and cart combination should be moved with care. Quick stops, excessive force, and uneven surfaces may cause the appliance and cart combination to overturn.
7. **Wall or Ceiling Mounting** - The appliance should be mounted to a wall or ceiling only as recommended by the manufacturer.
8. **Ventilation** - The appliance should be situated so that its location or position does not interfere with its proper ventilation. For example, the appliance should not be situated on a bed, sofa, rug, or similar surface that may block the ventilation openings; or, placed in a built-in installation, such as a bookcase or cabinet that may impede the flow of air through the ventilation openings.
9. **Heat** - The appliance should be situated away from heat sources such as radiators, heat registers, stoves, or other appliances (including amplifiers) that produce heat.
10. **Power Sources** - The appliance should be connected to a power supply only of the type described in the operating instructions or as marked on the appliance.
11. **Power-Cord Protection** - Power supply cords should be routed so that they are not likely to be walked on or pinched by items placed upon or against them, paying particular attention to cords and plugs, convenience receptacles, and the point where they exit from the appliance.

12. **Cleaning** - The appliance should be cleaned only as recommended by the manufacturer.
13. **Power Lines** - An outdoor antenna should be located away from power lines.
14. **Outdoor Antenna Grounding** - If an outside antenna is connected to the receiver, be sure the antenna system is grounded so as to provide some protection against voltage surges and built up static charges.
Section 810 of the National Electric Code, ANSI/NFPA No. 70-1984, provides information with respect to proper grounding of the masts and supporting structure grounding of the lead-in wire to an antenna discharge unit, size of grounding connectors, location of antenna-discharge unit, connection to grounding electrodes and requirements for the grounding electrode. See Fig. below.
15. **Non-use Periods** - The power cord of the appliance should be unplugged from the outlet when left unused for a long period of time.
16. **Object and Liquid Entry** - Care should be taken so that objects do not fall and liquids are not spilled into the enclosure through openings.
17. **Damage Requiring Service** - The appliance should be serviced by qualified service personnel when:
 - A. The power supply cord or the plug has been damaged; or
 - B. Objects have fallen, or liquid has been spilled into the appliance; or
 - C. The appliance has been exposed to rain; or
 - D. The appliance does not appear to operate normally or exhibits a marked change in performance; or
 - E. The appliance has been dropped, or the enclosure damaged.
18. **Servicing** - The user should not attempt to service the appliance beyond that described in the operating instructions. All other servicing should be referred to qualified service personnel.

Note to the CATV system installer: This reminder is provided to call the CATV system installer's attention to Article 820-40 of the NEC that provides guidelines for proper grounding and, in particular, specifies that the cable ground shall be connected to the grounding system of the building, as close to the point of cable entry as practical.

EXAMPLE OF ANTENNA GROUNDING AS PER NATIONAL ELECTRICAL CODE (NEC)

Example of Antenna Grounding as per NEC - National Electric Code

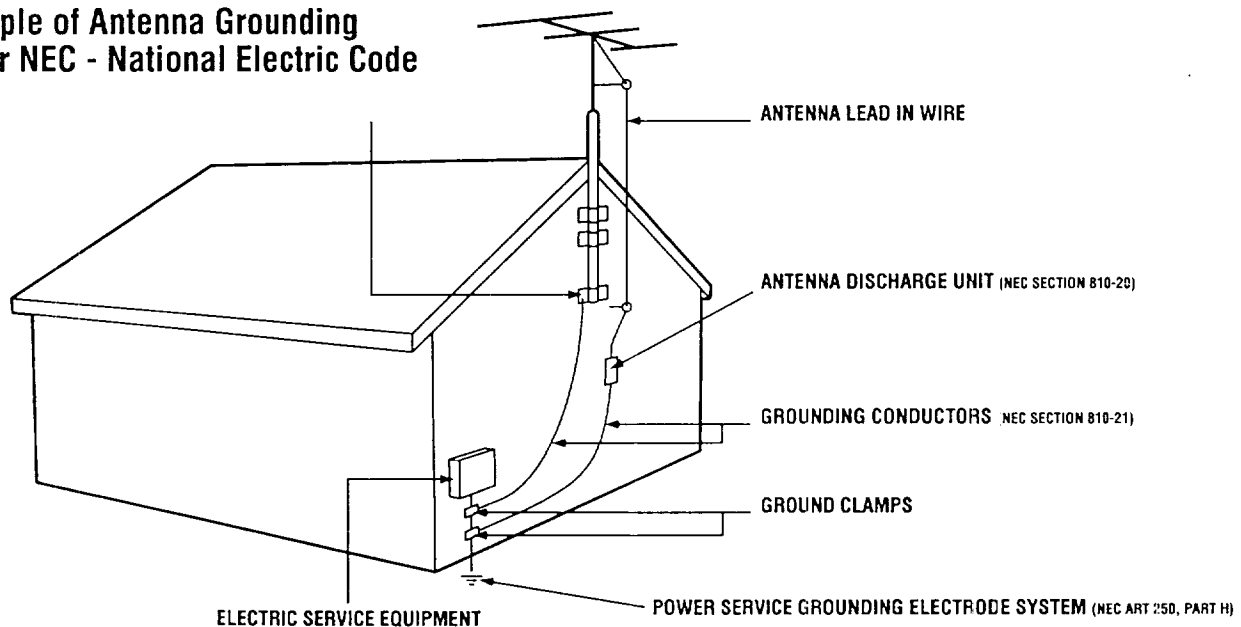

MAC3964



Getting Started

Welcome/Product Registration	2
Safety/Precautions	3
Table of Contents	4
Features and Model Information	5



On-Screen Features

PICTURE MENU

◇ Adjusting Color, Brightness, Sharpness, Tint, and Picture Controls	6
◇ Using the Clearview Control	7
◇ Adjusting the TV's Convergence Control	8
◇ Using the Flesh Correction Control	9
◇ Ghost Cancellation Feature Information	9

FEATURES MENU

◇ Selecting a Picture Source	10
◇ Setting the TV for Closed Captioning	11
◇ Setting the TV for Cable or Antenna Signals	12
◇ Adding Channels in Memory (Automatically)	13
◇ Adding Channels in Memory (Manually)	14
◇ Setting the TV Clock and Turn-On Timer	15
◇ Setting the Alternate Channel Control	16
◇ Using the Sleep Timer Control	16
◇ Adjusting the Channel Display Control	17
◇ Using the Time/Channel Reminder Control	17
◇ Using Parental Control to Censor Channels	18-19

SOUND MENU

◇ Adjusting Bass, Treble, and Balance Sound Controls	20
◇ Setting the Bass Boost Control	20
◇ Setting the TV for Stereo and SAP Programs	21
◇ Using the Stereo Surround Control	22
◇ Using the Volume Display Control	22
◇ Using the TV Speaker On/Off Control with the Audio Output jacks	23
◇ Surround Sound Speaker Connections and Variable Audio Output Control	24-25
◇ Using the TV's Audio/Video Input and Output Jacks	26-29



Remote Control Operation

Using the Remote Locator Feature	30-31
Setting the Smart Picture Control	32-33
Using Smart Sound Control	34
Using the Channel Guide Control	35
Setting the Remote to Work VCRs	36-37
Setting the Remote to Work Cable TV Converters	38-39
Setting the Remote to Work VCRs or Cable Converters - "Search Method"	40
Using the Remote's VCR buttons	41



Picture-In-Picture (PIP)

How to Use PIP (Connections)	42-43
How to Use PIP with the TV Remote	44-45
Selecting the Picture Source for PIP	46
Adjusting Picture-in-Picture Color and Tint	47
More PIP Connections (Cable Converter)	48



General Information

TV Help Menu	49
Accessory RF Switcher Information	49
Tips if Something Isn't Working	50
Glossary of TV Terms	51
Index	52
Factory Service Locations	53-54
Warranty	55
Accessories	56

SET-UP AND QUICK USE GUIDE

Use the simple Set-Up Guide (supplied with your TV information packet) for details on:

- Antenna Hook-ups
- First Time Set-Up (Automatic Settings)
- Basic TV and Remote Control Operation
- On-Screen Menu Use

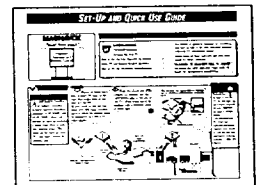



FEATURES

First Time Set Up which automatically sets the TV for local channels and the correct picture signal (antenna or cable). It even helps you make the necessary connections for the Picture-In-Picture (PIP) feature.

Infrared Remote Control which operates your TV set and a variety of wireless remote control VCRs and Cable TV Converters. A special "Locator" feature can also help you find the remote when it has been stuck out of sight or misplaced.

Standard TV broadcast (VHF/UHF) or Cable TV (CATV) channel capability.

Closed Captioning which allows the viewer to read TV program dialogue or voice conversations as on-screen text.

Automatic Programming of channels for quick and easy selection of favorite stations available in your area.

Picture-In-Picture (PIP) which can show a TV program and the direct video output from an accessory (VCR, etc.) onto the TV screen at the same time.

Parental Control for "Censoring" or blocking out channels to keep children from watching undesirable programming

Stereo-Ready TV with built-in audio amplifier and twin speaker system. Receives TV programs in both broadcast stereo sound or (SAP) bilingual broadcast.

On-Screen Features which display helpful information for the setting of TV controls (such as help messages, operating tips and glossaries).

Audio/Video jacks for direct connections with VCRs (and other accessories) for quality TV picture and sound playback.

Surround Sound external audio speaker connections.

Sleep-Timer which automatically turns the TV OFF at preset time intervals.

Smart Sound for the control of TV volume levels during program changes or commercial breaks.

Smart Picture allows you to choose from a list of TV video control categories set for a variety of viewing conditions and program sources.

Clock Timer feature which can turn ON the TV at any preset time - just like an alarm clock.

As you unpack your TV please note that the following items have been included with your set:

- Owner's Manual
- Warranty Registration Card
- Safety Tip Information
- Factory Service Center Address Listings
- Remote Control Transmitter
- Batteries for Remote Control Use
- Audio/Video Cables for Direct Input and Output Connections.

Please take a few minutes to complete your registration card. The serial number for the TV is on the back of the set.

To ensure that picture screen performance is of the highest quality, please avoid rubbing any object or material on the screen that could scratch or damage its surface.

Refer to the back of this manual for instructions on the cleaning and care of the TV.

PICTURE MENU CONTROL ADJUSTMENTS

COLOR, BRIGHTNESS, SHARPNESS, TINT, PICTURE

To adjust your TV color and picture controls, select a TV channel and follow the steps shown below:

BEGIN

- 1 Select **BRIGHTNESS, PICTURE, COLOR, TINT, or SHARPNESS** picture control.

With the PICTURE MENU on screen, move the RED highlight with the MENU (M)  buttons. Then press the MENU button.

- 2 Press the (+) or (-) buttons to adjust the selected control.

- 3 Press the STATUS button to clear the screen.



SMART HELP



Remember. When the bar scale is centered, control settings are at normal mid-range levels.

BRIGHTNESS Press (-) or (+) until dark parts of the picture show good detail.

PICTURE Press (-) or (+) until whitest parts of the picture are as bright as you prefer.

COLOR Press (-) or (+) to add or eliminate color.

TINT Press (-) or (+) to obtain natural skin tones. (Also see Flesh Correction on page 14 for more information).

SHARPNESS Press (-) or (+) to improve detail in the picture.

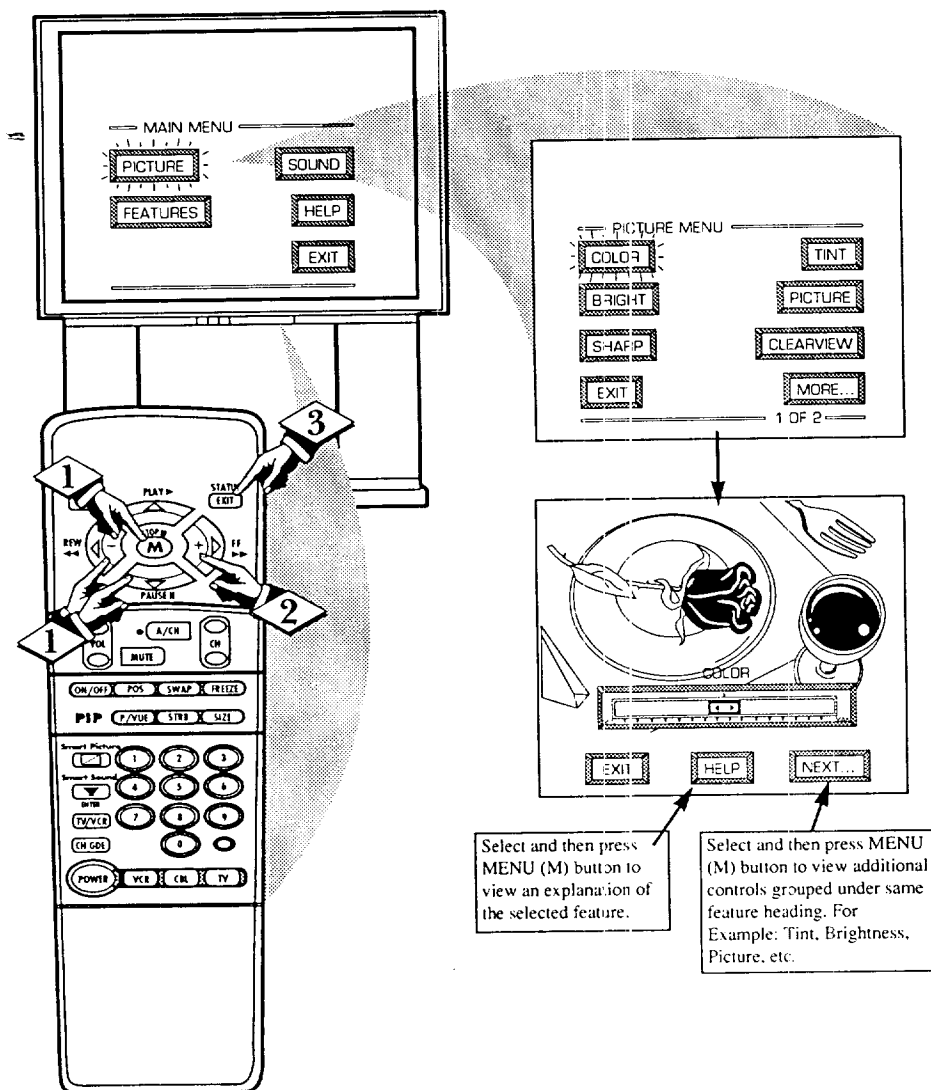



Select and then press MENU (M) button to view an explanation of the selected feature.

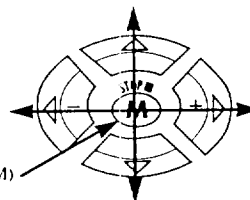

Select and then press MENU (M) button to view additional controls grouped under same feature heading. For Example: Tint, Brightness, Picture, etc.

HOW TO SELECT FEATURES (WITH BUTTONS ON THE REMOTE)



Press MENU (M) to select RED highlighted

Press MENU (M)   to move Up and Down within the Menu.

Press MENU (M)   to move from Side-to-Side within the Menu.



CLEARVIEW

Clearview is a sharpness feature which smoothes out background snow (or picture noise) without losing picture image detail or crispness.

BEGIN

- 1 Select CLEARVIEW control.

With the PICTURE MENU on screen, move the RED highlight with the MENU (M)  buttons. Then press the MENU button.

- 2 Press the MENU   buttons to move the RED highlight. Press the MENU button to select (✓) the ENHANCED mode.

- 3 Press the STATUS button to clear the screen.

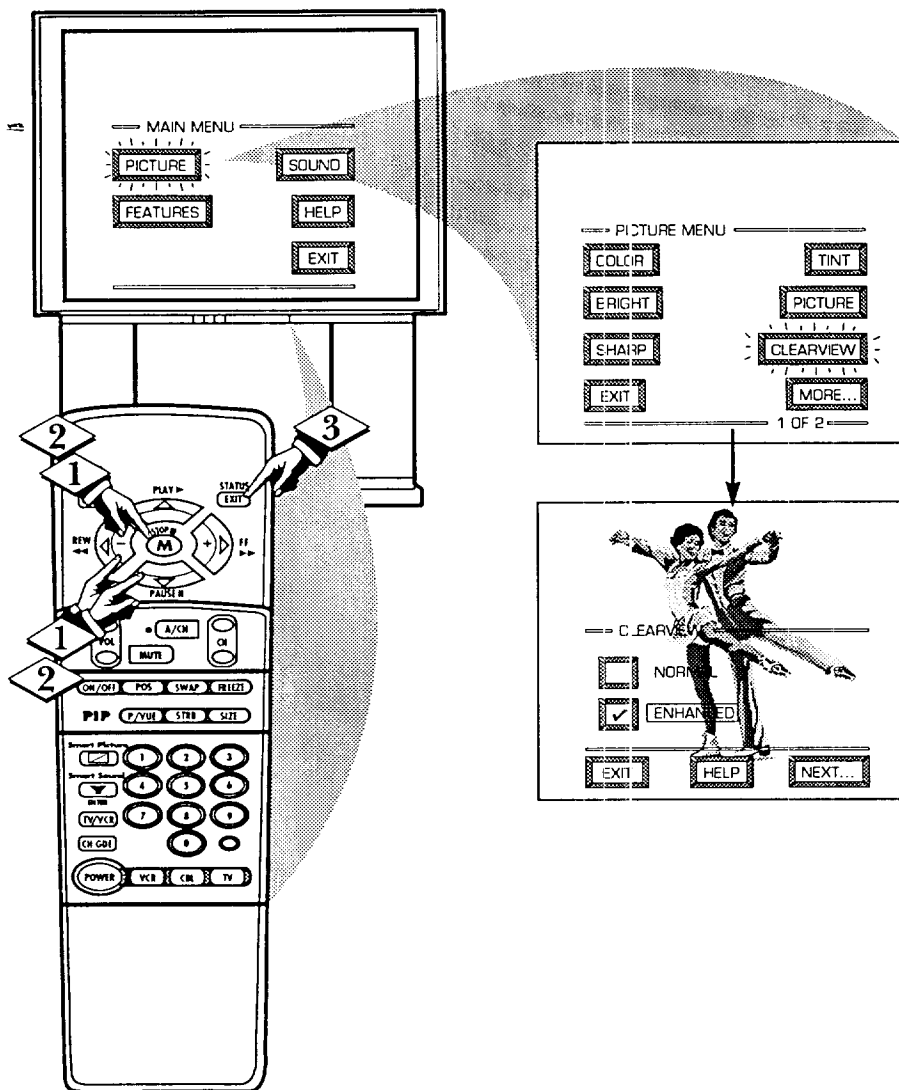

RED/BLUE CONVERGENCE

Convergence is the correct lining up of the red and blue light paths on the TV screen.

NOTE: If no color fringing (see Smart Help) shows, then no Convergence adjustments are necessary for your TV. -

BEGIN

- 1 Select CONVERGENCE control.

With PICTURE MENU (2 of 2) on screen, move the RED highlight with the MENU (M) buttons. Then press the MENU button.

- 2 If there is RED or BLUE color fringing on the White cross, press the MENU button to continue.

- 3 Press the MENU buttons to move the red or blue cross directly over the white cross on the TV screen.

The red or blue cross is properly adjusted when it is completely merged with the white cross. (No color appears around the edge of the white cross).

- 4 Press the STATUS button to clear the screen when convergence adjustments are complete.



SMART HELP



Remember. Convergence has been set at the factory for best viewing, but if one or more of the (red or blue) colors appear around the edges of objects (color fringing) follow the steps given in this section.

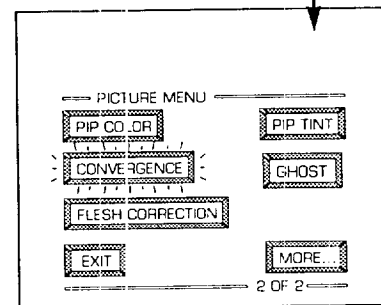
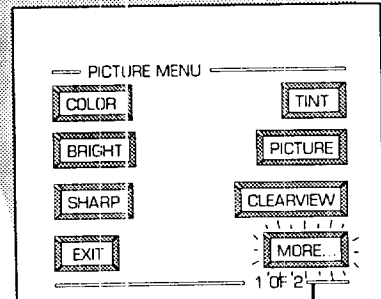
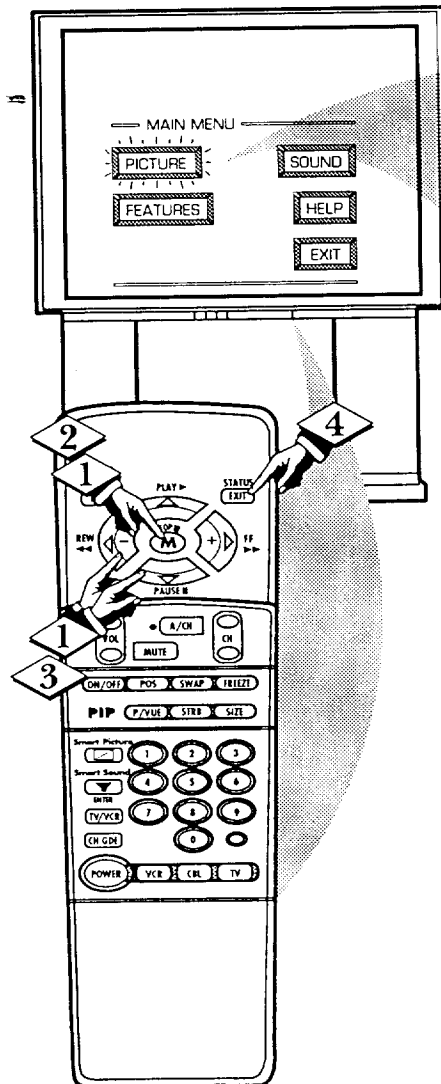

If there is RED or BLUE fringe on the WHITE cross, use this adjustment to improve the picture.

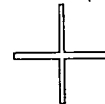

Press "M" to Continue
- or -
Press "M" to Return

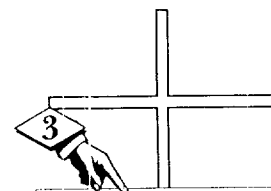

Use the left/right keys to merge the RED fringe into the WHITE cross. Press "M" to Continue.

PICTURE MENU CONTROLS (CONTINUED)



FLESH CORRECTION

Use the *Flesh Correction* control to keep skin tone hues (or facial tint) from varying from TV channel to TV channel.

BEGIN

- 1 Select **FLESH CORRECTION** control.

With **PICTURE MENU (2 of 2)** on screen, move the **RED** highlight with the **MENU (M)** buttons. Then press the **MENU** button.

- 2 Press the **MENU** **▲▼** buttons to move the **RED** highlight. Press the **MENU** button to turn the **FLESH CORRECTION** control **ON**.

- 3 Press the **STATUS** button to clear the screen.

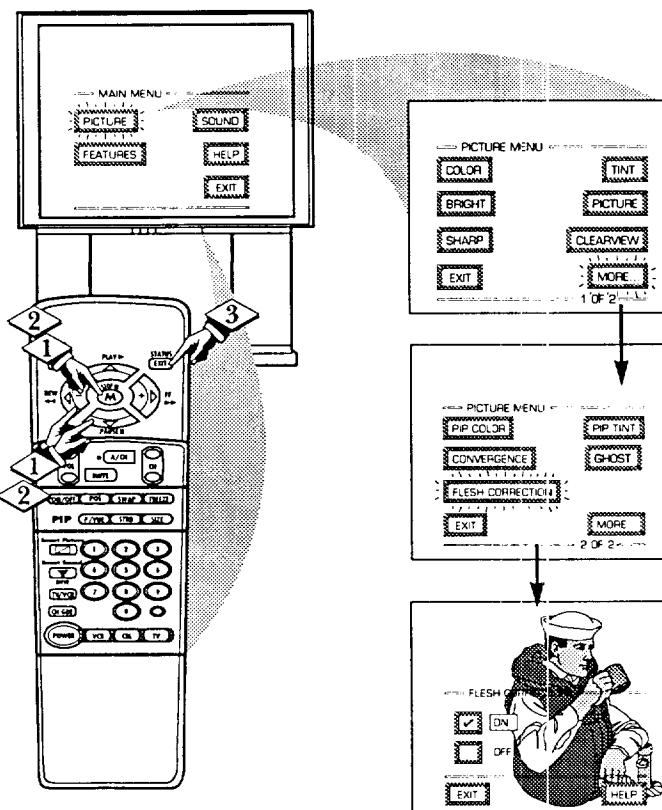

GHOST CANCELLATION

Wouldn't it be great to view your TV picture free of ghosts or other image problems? Well, your TV offers the first real step toward reducing or totally eliminating ghosting and other image interference. This should be especially good news for those home viewer's that currently use external or outdoor antennas to supply their picture.

Soon local stations will broadcast their TV programs with Ghost Cancellation information encoded in the TV signal. These encoded signals, when passed through an accessory device and the special circuitry provided in your TV, can dramatically reduce ghost line images and other interference problems.

Contact your dealer or call our Information Center number (615) 475-8869 for more details on this exciting new development in television broadcast technology.

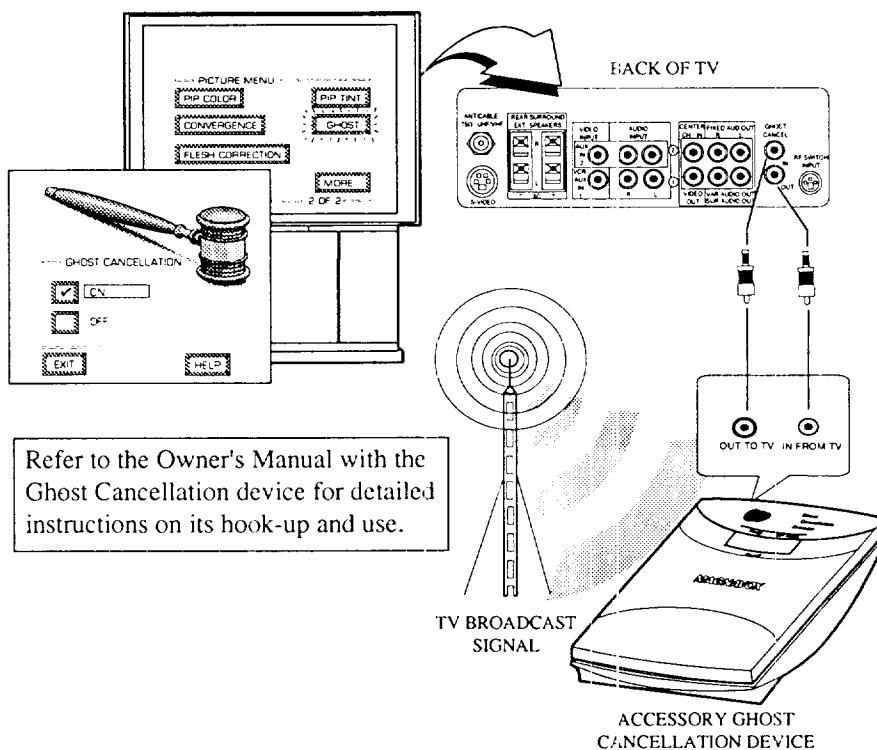

Refer to the Owner's Manual with the Ghost Cancellation device for detailed instructions on its hook-up and use.

PICTURE SOURCE

The picture for the TV can come through either the ANTENNA plug or the AUDIO/VIDEO INPUT jacks (on the rear of the TV). The Picture Source control simply tells the TV which one of these picture sources it is to show on the TV screen.

BEGIN

- 1 Select PICTURE SOURCE SELECT control.

With the FEATURES MENU on screen, move the RED highlight with the MENU (M) buttons. Then press the MENU button.

- 2 Press the MENU ▲▼ buttons to move the RED highlight. Press the MENU button to turn the desired PICTURE SOURCE control ON (✓).

ANTENNA- for a picture signal coming from the ANTENNA plug on the TV.

VCR/AUX 1- for a picture signal coming from the VCR/AUX 1 Video Input jack on the rear of the TV.

AUX 2- for a picture signal coming from the AUX/IN 2 Video Input jack on the rear of the TV.

AUX 3- for a picture signal coming from the Video Input jack on the front of the TV.

- 3

Press the STATUS button to clear the screen.



SMART HELP



Remember, the VCR/AUX 1, AUX 2, and AUX 3 modes must have a video signal source connected (to their INPUT plug) or the TV screen will be blank. (See page 26 for connection details).

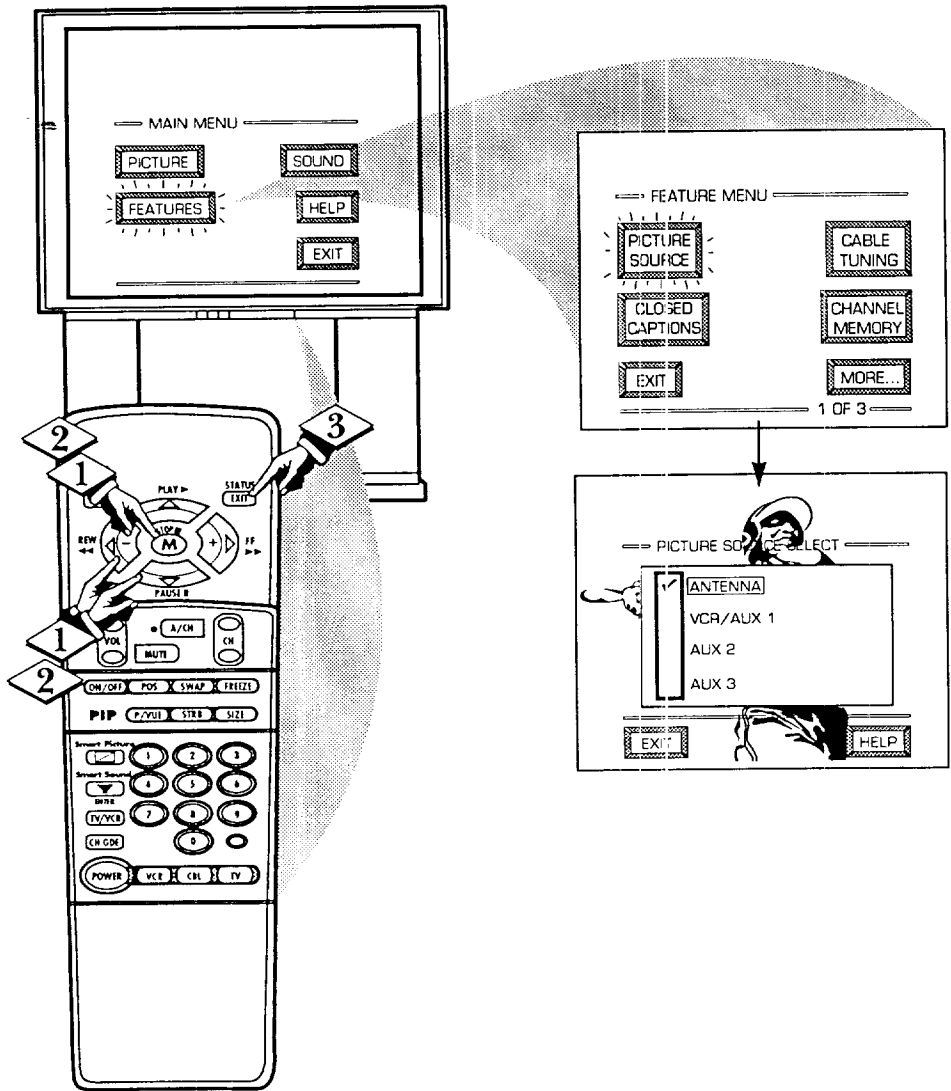

FEATURE MENU CONTROLS (CONTINUED)

CLOSED CAPTION

Closed Captioning (CC) allows you to read the voice content of television programs on the TV screen. Designed to help the hearing impaired this feature uses on-screen "text boxes" to show dialogue and conversations while the TV program is in progress.

BEGIN

- 1 Select **CLOSED CAPTIONING** control.

With the **FEATURES MENU** on screen, move the **RED** highlight with the **MENU (M)** buttons. Then press the **MENU** button.

- 2 Press the **MENU** buttons to move the **RED** highlight. Press the **MENU** button to select the desired Closed Caption mode - For Example: "ALWAYS ON" and "CAPTION 1".

CAPTION 1, 2, 3, 4:

dialogue (and descriptions) for the action on the captioned TV program shows on-screen. (See Important Note on this page.)

TEXT 1, 2, 3, 4:

often used for channel guide, schedules, or bulletin board information for CC programs.

- 3 After making your Caption mode selection, press the **STATUS** button to clear the TV screen. The selected Closed Caption mode will be active. To cancel, set the Closed Captioned feature to **OFF** when finished.



SMART HELP



Remember. Broadcast stations will often use spelling abbreviations, symbols, dropouts and other grammatical shortcuts in order to keep pace with the on-screen action. These type factors vary upon the source of the captioned text material and do not indicate a need for service on the part of the TV.

NOTE: Not all TV programs and product commercials are made for broadcast with Closed Caption (CC) information included. Neither are all Closed Caption modes (CAPTION 1-4; or TEXT 1-4) necessarily being used by a broadcast station during the transmission of a closed caption program. Usually "CAPTION 1" is the most used mode to view captioned material. Refer to your area's TV program listings for the stations and times of Closed Caption shows.

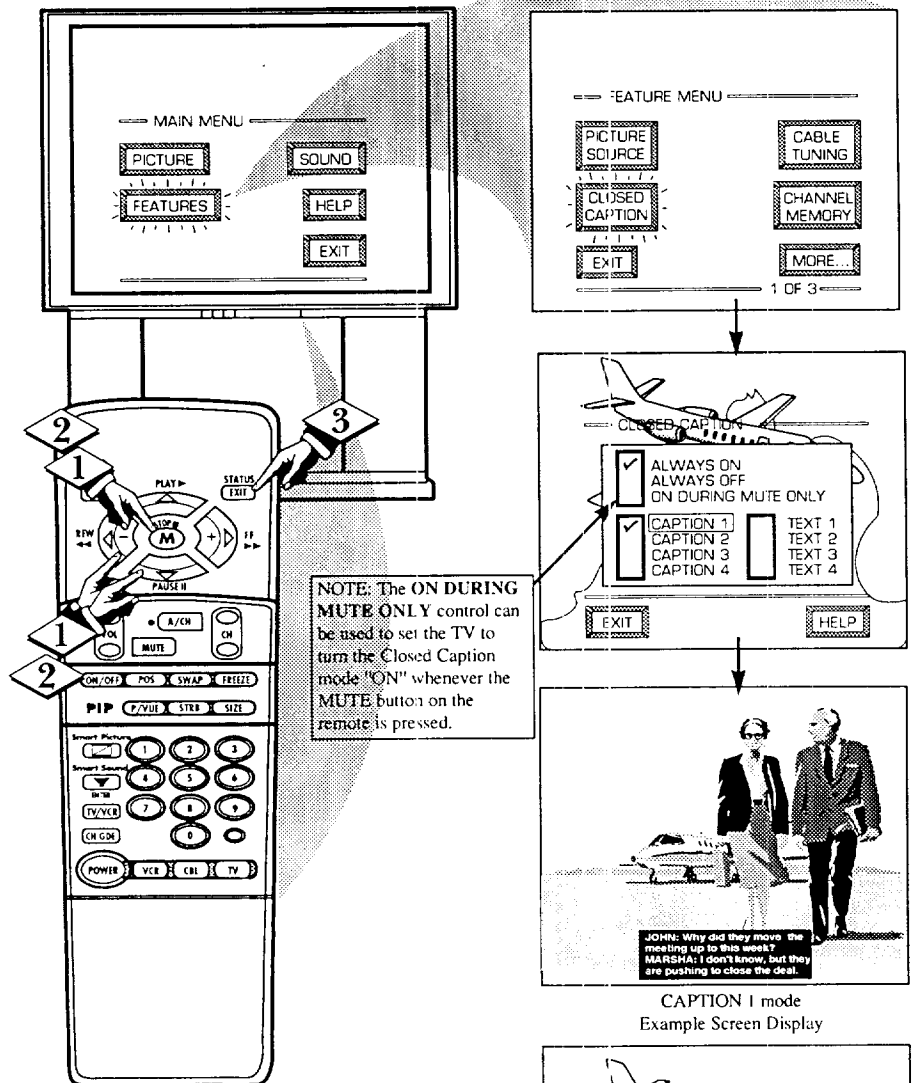

NOTE: The ON DURING MUTE ONLY control can be used to set the TV to turn the Closed Caption mode "ON" whenever the MUTE button on the remote is pressed.

CAPTION 1 mode
Example Screen Display

Closed Caption information will usually appear in black and white (although some broadcasters or networks may occasionally use color to highlight or draw attention to certain areas.)

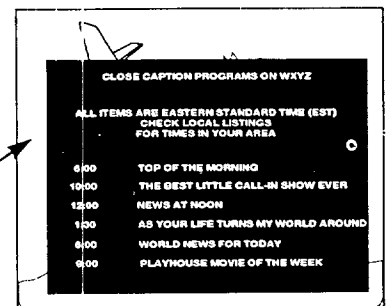

FULL SCREEN TEXT
will block TV screen from viewing

CABLE TUNING



You need to make sure the TV is set to pick up either Cable TV or Antenna signals. In other words, the TV needs to know if you connected a Cable TV signal or a normal antenna to its ANTENNA plug.

NOTE: If you went through First Time Setup (in your Quick Use Guide), this task has already been completed for you.

BEGIN

- 1 Select CABLE CHANNEL TUNING control.

With the FEATURES MENU on screen, move the RED highlight with the MENU (M)  buttons. Then press the MENU button.

- 2 Press the MENU   buttons to move the RED highlight. Press the MENU button to select (✓) the desired mode - For Example: CABLE.

CABLE- If you DO have Cable TV connected to the TV. Channels 1-125 available.

NORMAL- If you have an Antenna connected to the TV. Channels 2-69 available.

- 3 Press the STATUS button to clear the screen.

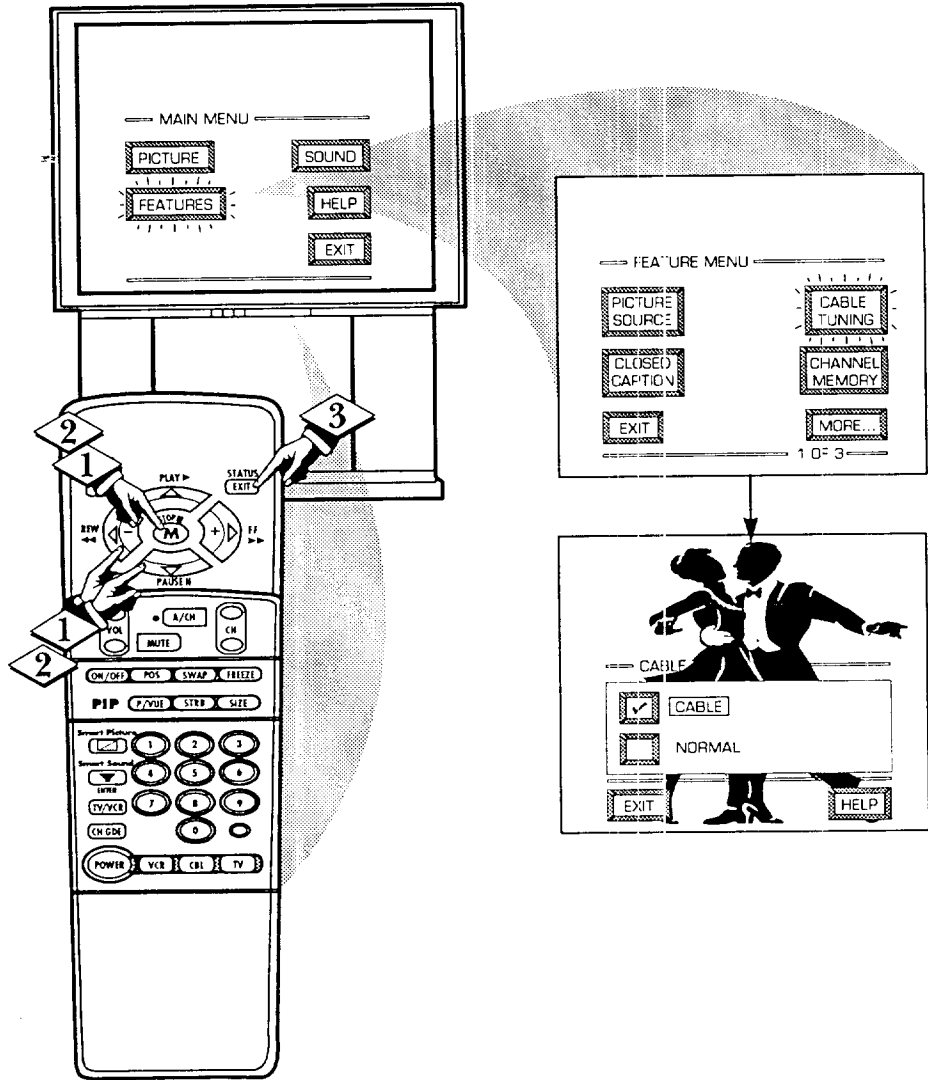

CHANNEL MEMORY AUTOPROGRAMMING

Your TV can automatically set itself for local area (or Cable TV) channels. This makes it easy for you to select only the TV stations in your area when the CHANNEL ▲▼ buttons are pressed.

NOTE: If you went through First Time Setup (in your Quick Use Guide), this task has already been completed for you.

BEGIN

- 1 Select CHANNEL MEMORY (START AUTOPROGRAMMING) control.

With the FEATURES MENU on screen, move the RED highlight with the MENU (M) buttons. Then press the MENU button.

- 2 Press the MENU button to turn AUTOPROGRAMMING ON.

The TV shows which channel numbers are "SAVED" (✓) as they are added into memory.

"Auto-programming CHANNEL MEMORY is finished" shows when the TV is through adding channels.

- 3 Press the STATUS or Menu (M) button to clear the screen.



SMART HELP



Try it out. Press the CHANNEL ▲▼ buttons and see which channels you can select.

Remember, an Antenna or Cable TV signal must first be connected to your TV so that channels can be saved.

If you want to delete any unwanted channels from the TV's memory, see "ADD/DELETE CHANNELS" on the next page.

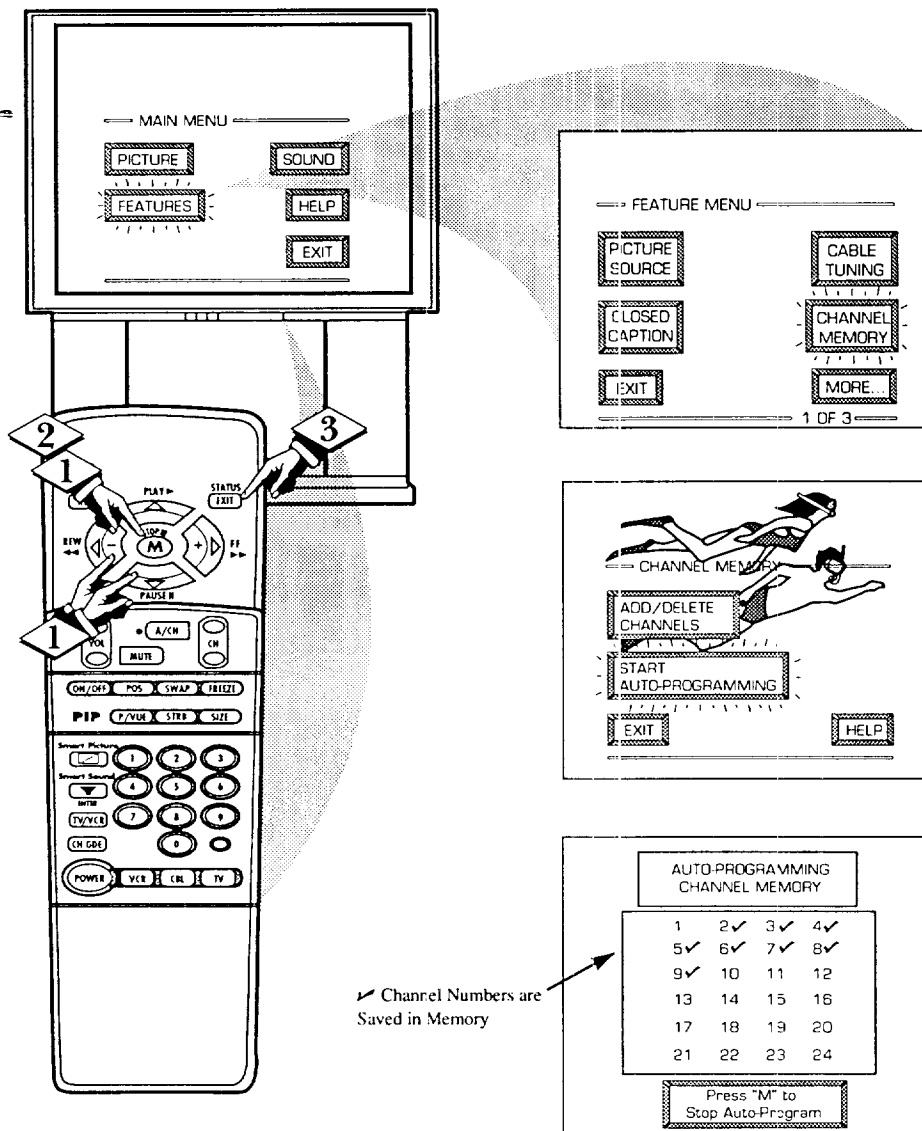

ADD/DELETE CHANNELS

AutoProgramming (see *previous page*) adds all the channels it can find (on your Antenna or Cable TV system) into the TV's memory. Add/Delete Channels makes it easy for you to add other channels, or drop unwanted channels, from the list of channels in the TV's memory.

BEGIN

- 1 Select CHANNEL MEMORY (ADD/DELETE CHANNELS) control.

With the FEATURES MENU on screen, move the RED highlight with the MENU (M) buttons. Then press the MENU button.

- 2 Press the CHANNEL or number buttons to select the channel you want to add or delete.

- 3 Press the MENU button to ADD the channel into the TV's memory.

Press the MENU button to DELETE the channel from memory.

Repeat steps 2 and 3 for each channel you wish to add or delete.

- 4 Press the STATUS or MENU button to clear the screen when through.

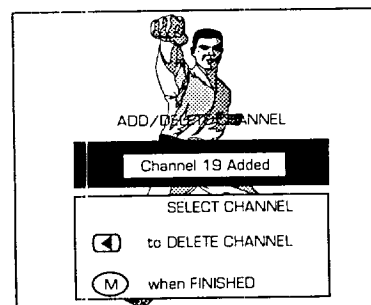
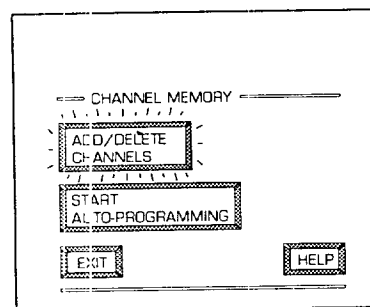
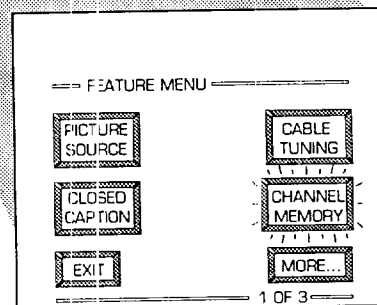
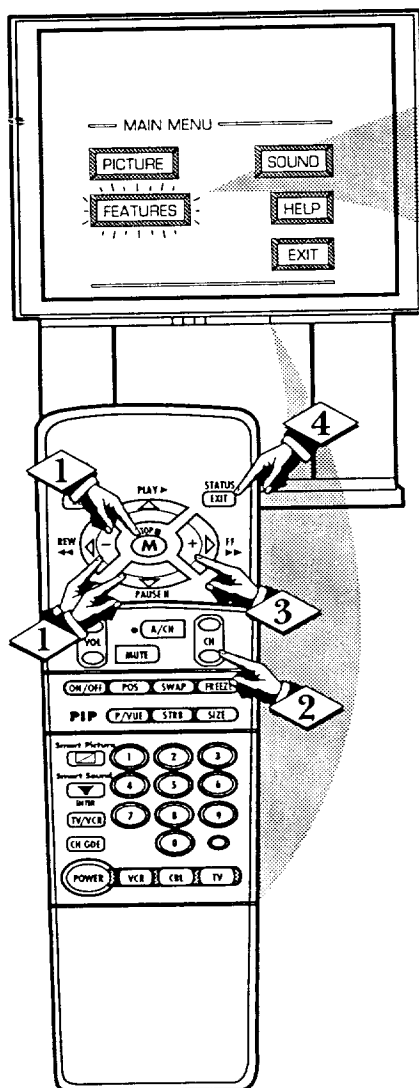

SMART HELP



Remember. You can also add the VCR/AUX, AUX 2, or AUX 3 modes just like a channel. Then by pressing the CHANNEL buttons the AUX(iliary) mode can quickly be selected to use the desired set of Input jacks on the TV (see page 26).

Note: VCR/AUX, AUX 2, and AUX 3 modes are located between the lowest and highest channel numbers within the ADD/DELETE CHANNEL control screen.

SET CLOCK

Your TV comes with an on-screen clock. During normal operation the clock appears on the screen with every channel change (and when the STATUS button is pressed).

NOTE: If you went through First Time Setup (in your Quick Use Guide), this task has already been completed for you.

BEGIN

- 1 Select SET CLOCK control.
- With FEATURES MENU (2 of 3) on screen, move the RED highlight with the MENU (M) buttons. Then press the MENU button.
- 2 Press the remote's number buttons to set the time clock.
- 3 Press the STATUS button to set the clock in operation and clear the screen.

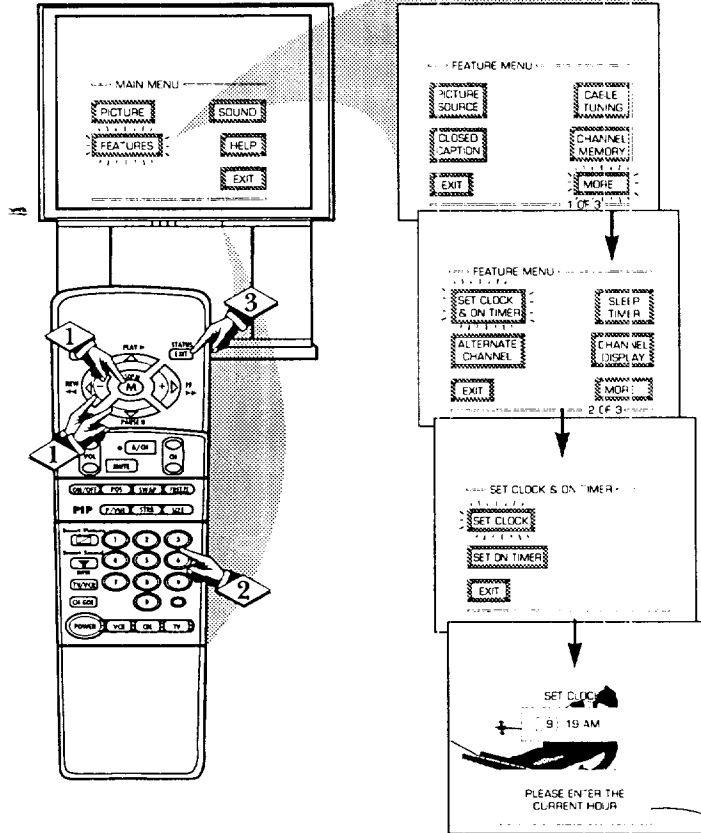

SMART HELP



Remember, be sure to press "0" first and then the hour number for single digit entries.

The remote's MENU (M) buttons can also be used to set the hours, minutes and AM/PM portions of the clock.

TV Clock settings may be lost when the TV is unplugged (or AC power to the set is interrupted.)

SET ON TIMER

Just like an alarm clock you can set the TV to turn itself on at the same time everyday.

BEGIN

- 1 Select SET ON TIMER control.
- With FEATURES MENU (2 of 3) on screen, move the RED highlight with the MENU (M) buttons. Then press the MENU button.
- 2 Press the MENU ▲▼ and MENU (M) buttons to highlight and select "ON" (✓).
- 3 Press the MENU ▲▼ and then the MENU (M) buttons to select "SET ON TIME".
- 4 Press the remote's number buttons to set the "TURN ON" time for the TV. (Press MENU ▲▼ for AM or PM.)
- 5 Press the STATUS button to set the "ON TIME" and clear the screen.

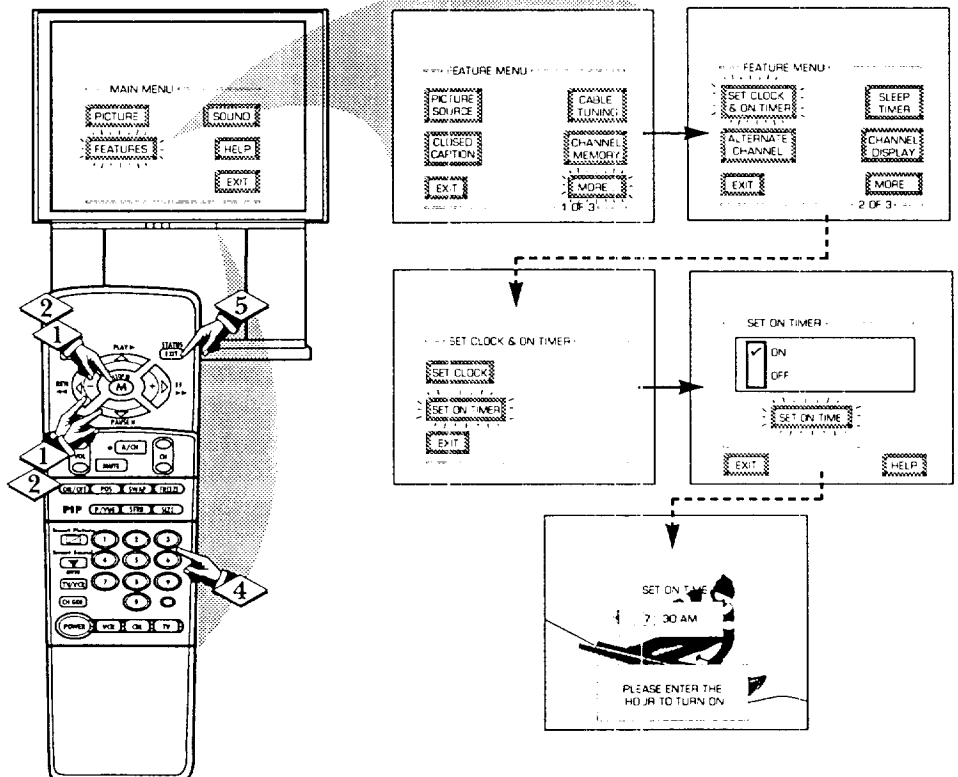

FEATURE MENU CONTROLS (CONTINUED)

ALTERNATE CHANNEL

A "ring" or series of previously viewed channels can be selected from the Alternate Channel (A/CH) button on your remote control. With this feature you can easily switch between different TV programs that currently interest you. The ALT. CHN. menu control allows you to set up to four channels in the viewing "ring".

BEGIN

- 1 Select **ALTERNATE CHANNEL** control. With FEATURES MENU (2 of 3) on screen, move the RED highlight with the MENU (M) buttons. Then press the MENU button.
- 2 Press the MENU and MENU (M) buttons to highlight and select (✓) the number of channels in the "ring" (either 2, 3, or 4 channels.)
- 3 Press **STATUS** button to clear the screen.

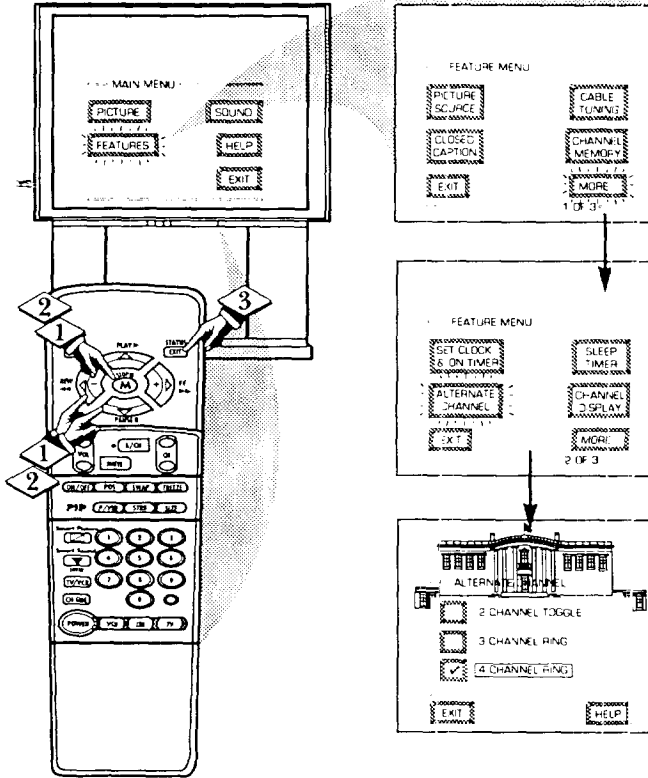

SMART HELP



Remember, to first use this feature press the A/CH and then the MENU button on the remote. Then select the desired channels with the number buttons on the remote. (For example for a "4" channel ring select: 02, 06, 11, and 22.) Then press the A/CH button on the remote to quickly select the channels in the "ring". Great for viewing evening news or sports programming.

2

6

11

22

Use number buttons to enter channels.
 Cancels change.

SLEEP TIMER

Have you ever fallen asleep in front of the TV only to have it wake you up at two in the morning with a test pattern screeching in your ears? Well, your TV can save you all that trouble by automatically turning itself off.

BEGIN

- 1 Select **SLEEP TIMER** control. With FEATURES MENU (2 of 3) on screen, move the RED highlight with the MENU (M) buttons. Then press the MENU button.
- 2 Press the MENU and MENU (M) buttons to pick the amount of time (15 minutes to 2 hours ahead) before the TV will turn itself off.
- 3 Press the **STATUS** or MENU (M) button to clear the screen after you have set the time for the TV to turn off.

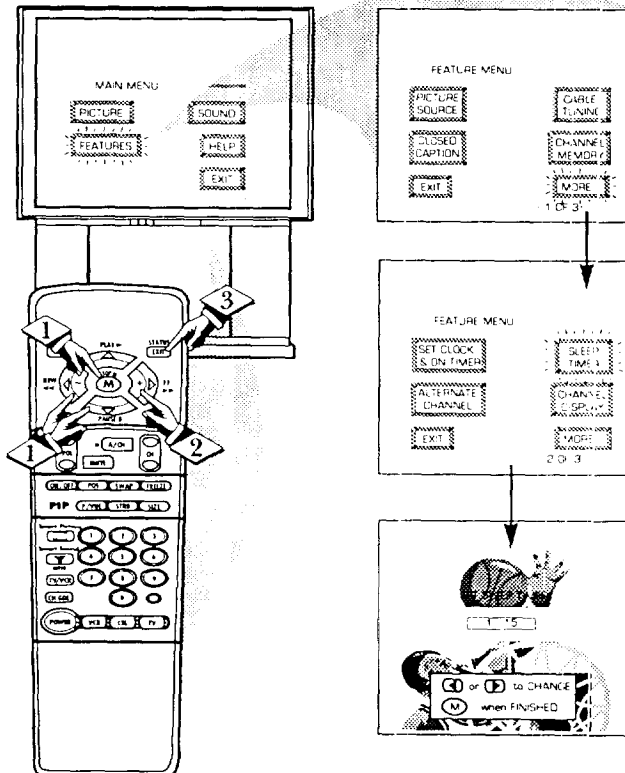

SMART HELP



Remember, to see how many minutes are left before the TV shuts itself off, reselect the SLEEP TIMER control screen.

To stop a SLEEP TIMER setting, reset the timer back to OFF. (Turning the TV off and on, or pressing a button during the last minute of a timer setting, will also cancel a setting.)

A few seconds before the TV is to shut off a message will come on the screen telling you **GOOD NIGHT.**

FEATURE MENU CONTROLS (CONTINUED)

CHANNEL DISPLAY

With the Channel Display control you can change the size and location of the on screen channel and clock information.

BEGIN

- 1 Select CHANNEL DISPLAY control.

With FEATURES MENU (2 of 3) on screen, move the RED highlight with the MENU (M) buttons. Then press the MENU button.

- 2 Press the MENU ▲▼ and MENU (M) buttons to highlight and select (↵) the LARGE or SMALL display control.

- 3 Press the STATUS button to clear the screen.

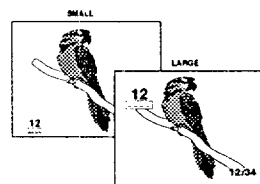
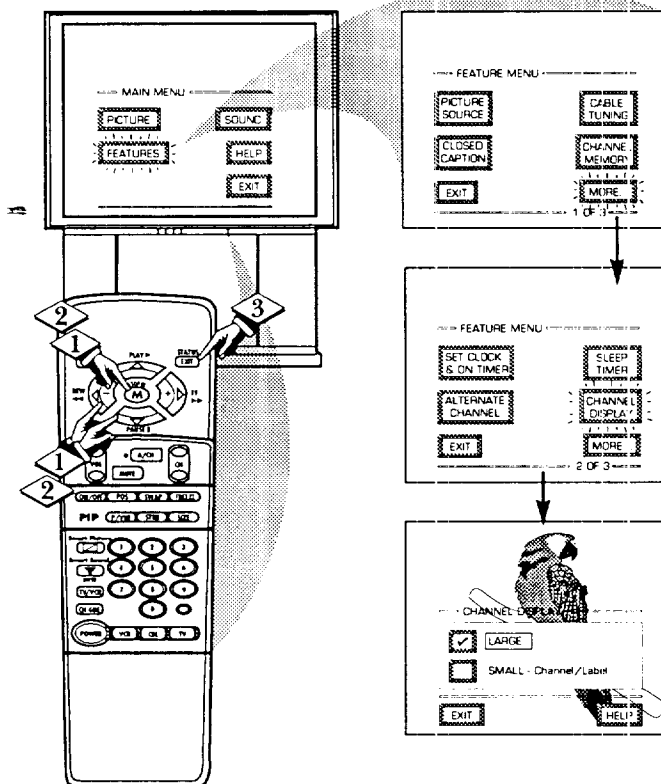

CHANNEL DISPLAY OPTIONS

SMART HELP



Try it out. Press the CHANNEL ▲▼ buttons and you should see the Display Size you selected.

Remember. The SMALL SIZE display shows only the channel number, not the time (or clock).

HALF HOUR REMINDER

With the Half Hour Reminder control the TV automatically shows you the current time and channel every thirty minutes.

BEGIN

- 1 Select HALF HOUR REMINDER control.

With FEATURES MENU (3 of 3) on screen, move the RED highlight with the MENU (M) buttons. Then press the MENU button.

- 2 Press the MENU ▲▼ and MENU (M) buttons to highlight and select (↵) the EVERY HALF HOUR item.

- 3 Press the STATUS button to clear the screen.

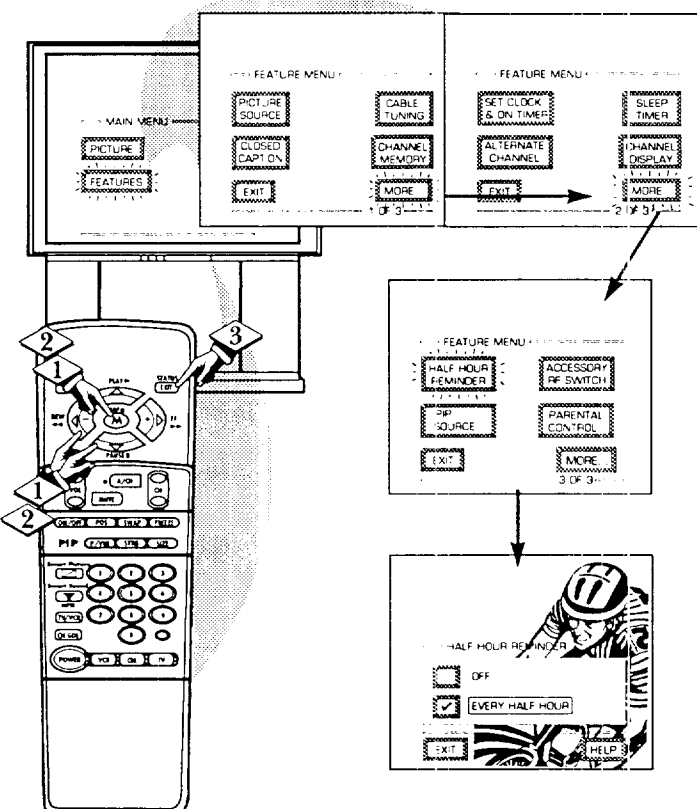

SMART HELP



Remember. The Time and Channel Reminders will show on the hour and the half-hour for about five seconds.

FEATURE MENU CONTROLS (CONTINUED)

PARENTAL CONTROL

Parental Control allows parents to block out, or "censor", any channels they think children should not watch. A channel placed under Parental Control cannot be viewed until a correct access code is used to unlock the channel for viewing.

First let's set your Parental Code:

BEGIN

1 Select the PARENTAL CONTROL.

With FEATURES MENU (3 of 3) on screen, move the RED highlight with the MENU (M) buttons. Then press the MENU button.

"BLOCK CHANNELS" and "SETUP CODE" show on screen.

2 Press the MENU ▲▼ and MENU (M) buttons to highlight and select the SETUP CODE item.

3 Press 0, 7, 1, 1 on the remote.

"XXXX" shows on the ACCESS CODE SETUP screen as you press the number buttons.

"INCORRECT ACCESS CODE - TRY AGAIN" will also show on the screen.

4 Press 0, 7, 1, 1 on the remote again.

"Next Enter Your New Access Code" shows on the screen.

5 Enter a new four digit number code using the remote.

"Access Code Changed" shows on the screen to let you know the new code has been set.

Continue to the next page to find out how to "block" channels from viewing.

NOTE: Your TV left the factory with the Parental Code set to "0000". If you are using your TV and the Parental Control for the first time, and don't want to SETUP a new Access code number, you can use the "0000" number to block channels - see next page. The "0711" Parental Code (shown on this page) is given as a default or way to reset the Code when the current Access number is not known.

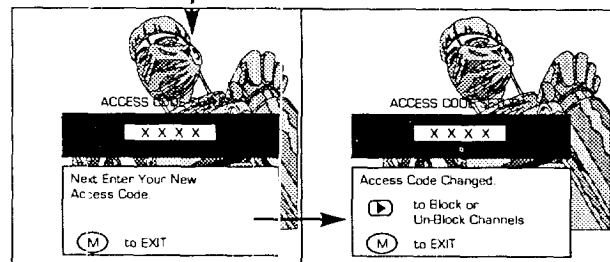
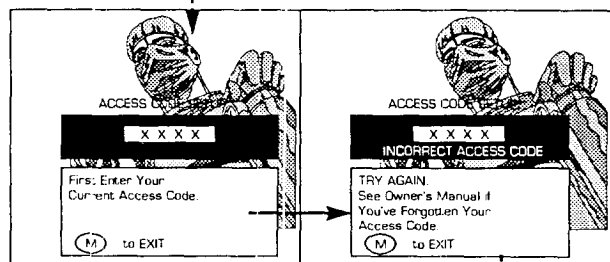
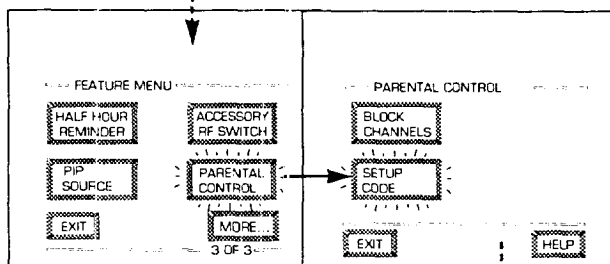
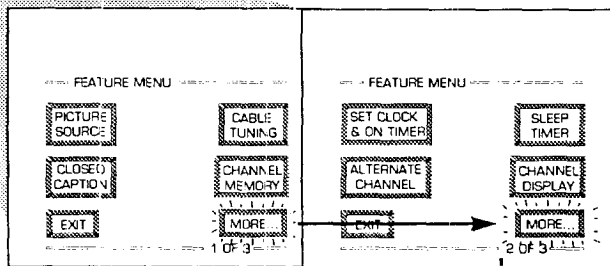
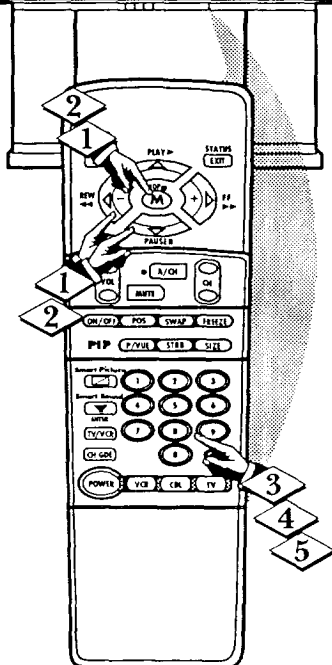
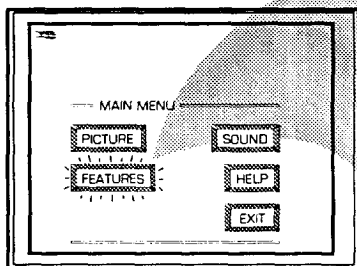

- Press MENU ► to go on and start to "block" channels
- Press MENU to return to the Parental Control Menu screen.
- Press STATUS to clear the screen.

SMART HELP



Parents - it isn't possible to unlock or defeat your Censor Code without changing to a new code number. So if your Code number changes, and you didn't change it yourself, then you will know that someone has altered the code and the blanked out channel has been viewed.

PARENTAL CONTROL

After your personal Parental Code number has been set (see previous page), you are now ready to select the channels you want to block out or censor.

BEGIN

- 1 Select the **BLOCK CHANNELS** control.
With FEATURES MENU (3 of 3) on screen, move the RED highlight with the MENU (M) (◀▶) buttons. Then press the MENU button.
- 2 Press the MENU ▲▼ and MENU (M) buttons to highlight and select the **BLOCK CHANNELS** item.
- 3 Enter the correct Parental Code number.
- 4 Press Channel ▲▼ or Channel Number buttons to select the channel you want to block.
- 5 Press the MENU ▶ button to "BLOCK VIEWING" on the selected channel. Press the MENU ◀ button to "ALLOW VIEWING" on a blocked channel.
Repeat steps 3 and 4 for any other channels you wish to block out.



SMART HELP



Remember, to make TV viewing easier all channels (and Audio/Video Input jacks) will be unblocked, once the correct Parental Code number has been entered.
When the TV is turned OFF and then back ON again, Parental Control is back in place for all channels.

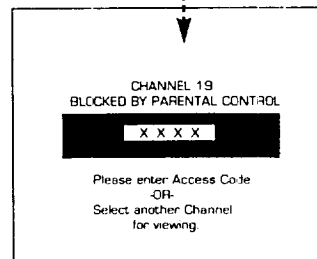
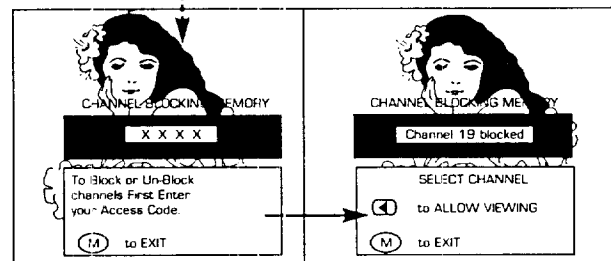
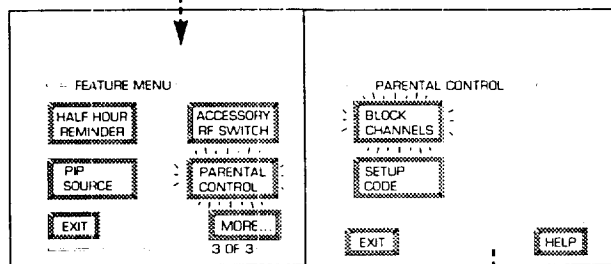
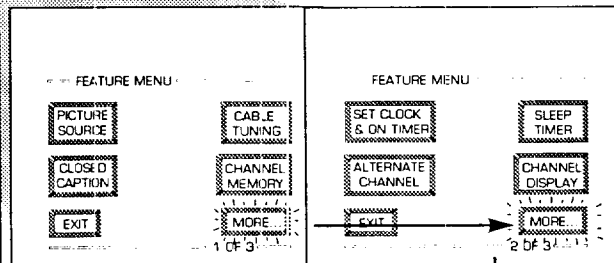
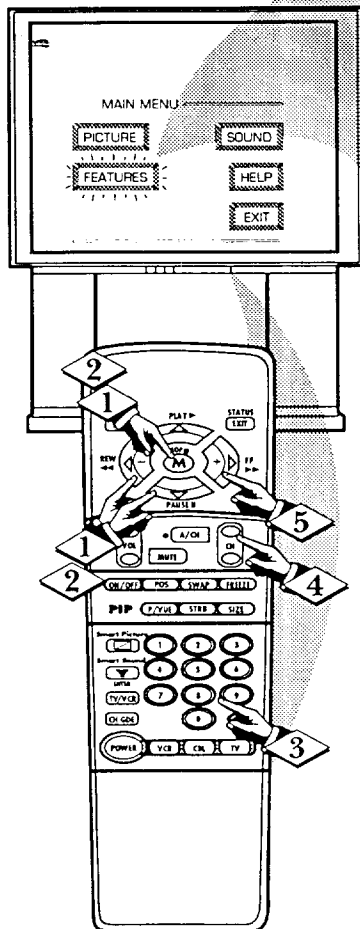

Note: You can also block out the use of the Audio/Video Input jacks on the TV. This stops the viewing of VCR programs which can be shown through the A/V IN jacks. Just select VCR/AUX 1, AUX 2, or AUX 3 (located between the lowest and highest channel numbers) on the Channel Blocking screen, and select "blocked".

BLOCKED CHANNEL SCREEN MESSAGE (Appears when an attempt to select a blocked channel is made and Parental Control is ON.)

SOUND MENU CONTROL ADJUSTMENTS

BASS, TREBLE, BALANCE

Your TV also has individual sound adjustment controls. The **BASS** (low frequency), **TREBLE** (high frequency), and **Speaker BALANCE** may all be used to adjust the sound playback of TV programs.

BEGIN

- 1 Select **BASS**, or **TREBLE**, or **BALANCE** sound control.

With the **SOUND MENU** on the screen, move the **RED** highlight with the **MENU (M)** buttons. Then press the **MENU** button.

- 2 Press the **(+)** or **(-)** buttons to adjust the sound control to levels you prefer.

- 3 Press the **STATUS** button to clear the screen.

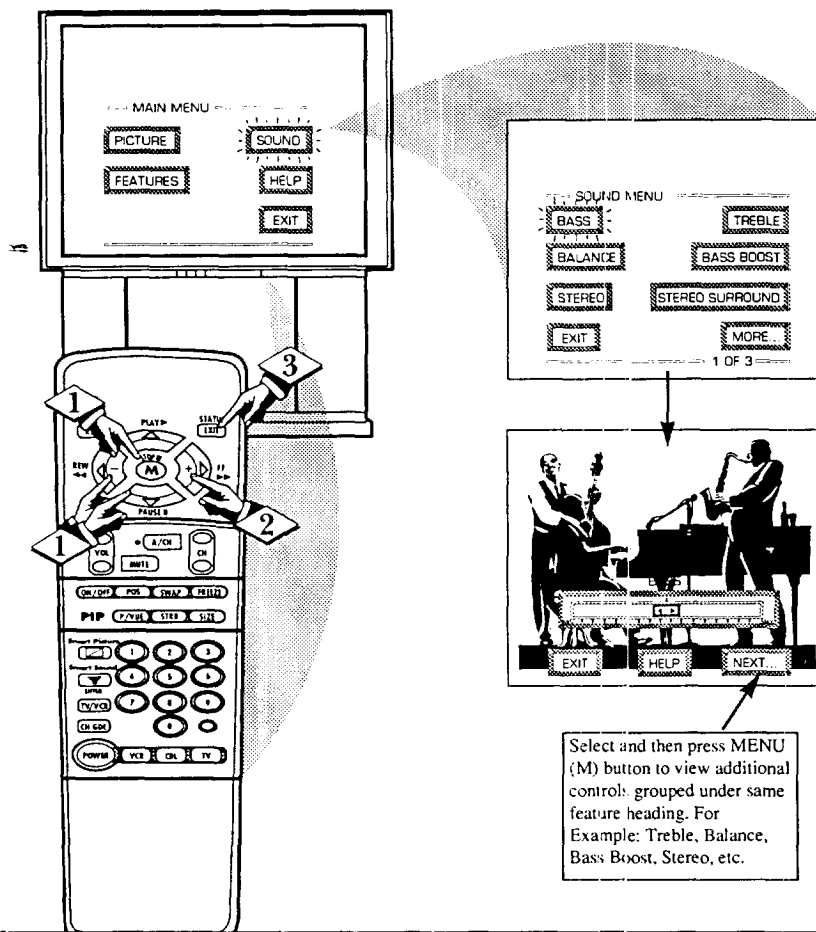

BASS BOOST

The **BASS BOOST** control increases the low frequency audio range of the TV. This creates a deeper, fuller playback sound which can be heard through the TV's speakers.

BEGIN

- 1 Select **BASS BOOST** sound control.

With the **SOUND MENU** on the screen, move the **RED** highlight with the **MENU (M)** buttons. Then press the **MENU** button.

- 2 Press the **MENU** and **MENU (M)** buttons to highlight and turn **ON** (✓) the **BASS BOOST** control.

- 3 Press the **STATUS** button to clear the screen.

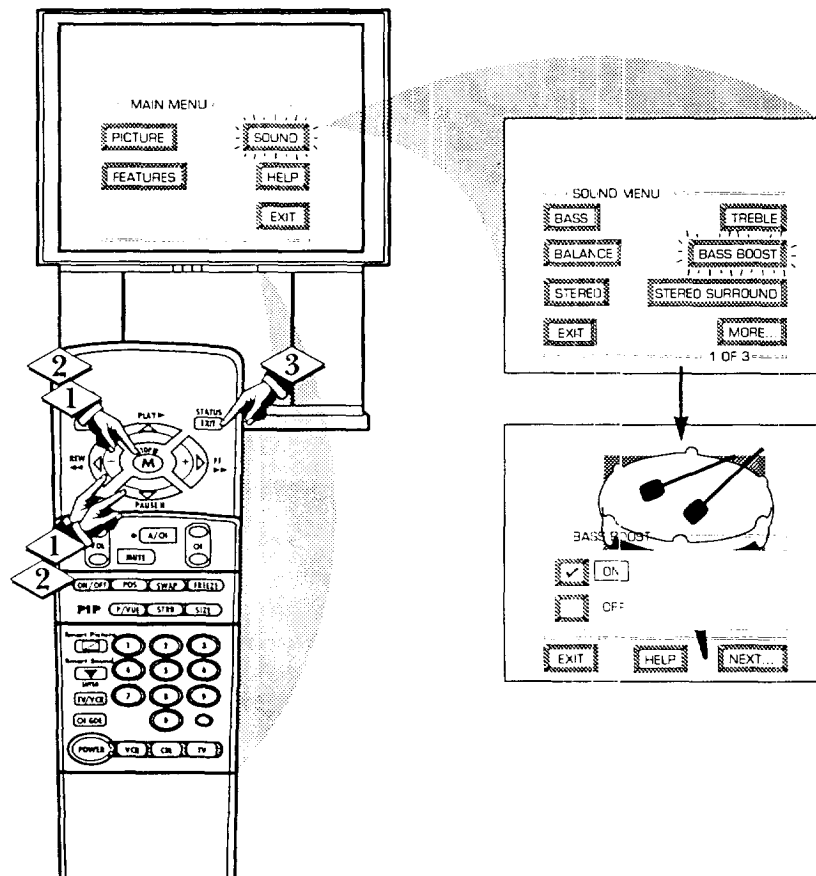

STEREO

Your TV is able to receive broadcast stereo TV programs. The TV is equipped with an amplifier and twin speaker system through which the stereo sound can be heard.

A RED stereo light (on the front of the TV) will come on when a stereo broadcast is received.

BEGIN

- 1 Select STEREO sound control.

With the SOUND MENU on the screen, move the RED highlight with the MENU (M) \blacktriangle \blacktriangledown buttons. Then press the MENU button.

- 2 Press the MENU \blacktriangle \blacktriangledown and MENU (M) buttons to highlight and turn ON (✓) the STEREO mode.

- 3 Press the STATUS button to clear the screen.

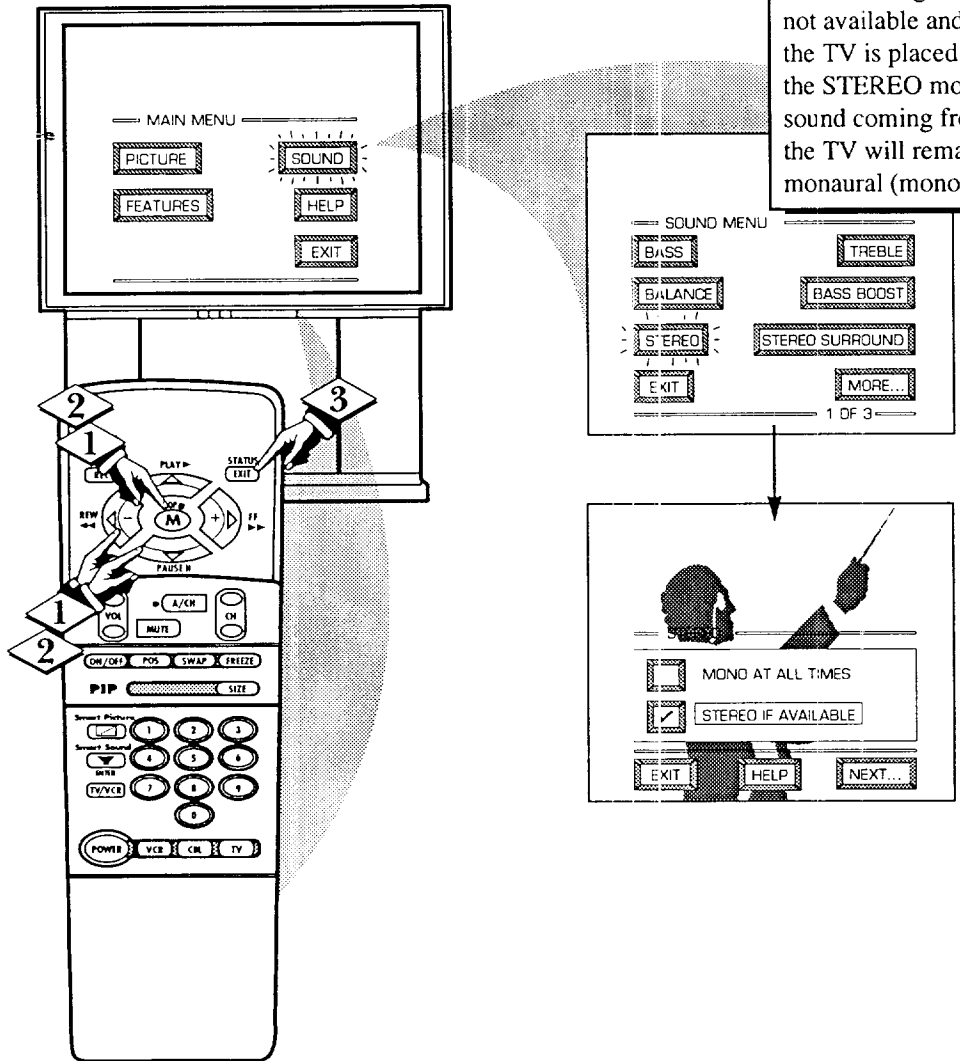

SECOND AUDIO PROGRAM

Second Audio Program (SAP) is part of the stereo broadcast system. Sent as an additional audio channel SAP can be heard apart from the current TV program sound. TV stations are free to use SAP for any number of purposes, but many experts believe it will be used for foreign language translations of TV shows (or for weather and news bulletins.)

NOTE: If a SAP signal is not present with a selected program, the SAP option can not be selected. "This program does not contain SAP information" will show on the TV screen.

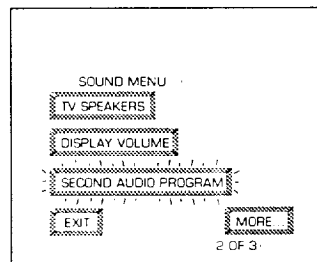

SECOND PROGRAM SOUND CAN ONLY BE SELECTED (✓) WHEN SAP INFORMATION IS PRESENT ON CURRENT CHANNEL.

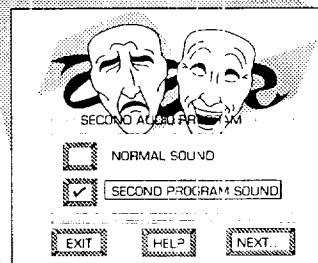

STEREO SURROUND

The Stereo Surround control can be used to add greater depth and dimension to both monaural (MONO) and STEREO TV sound.

BEGIN

- 1 Select STEREO SURROUND control.

With the SOUND MENU on the screen, move the RED highlight with the MENU (M) buttons. Then press the MENU button.

- 2 Press the MENU ▲▼ and MENU (M) buttons to highlight and turn ON (✓) the STEREO SURROUND control.

- 3 Press the STATUS button to clear the screen.

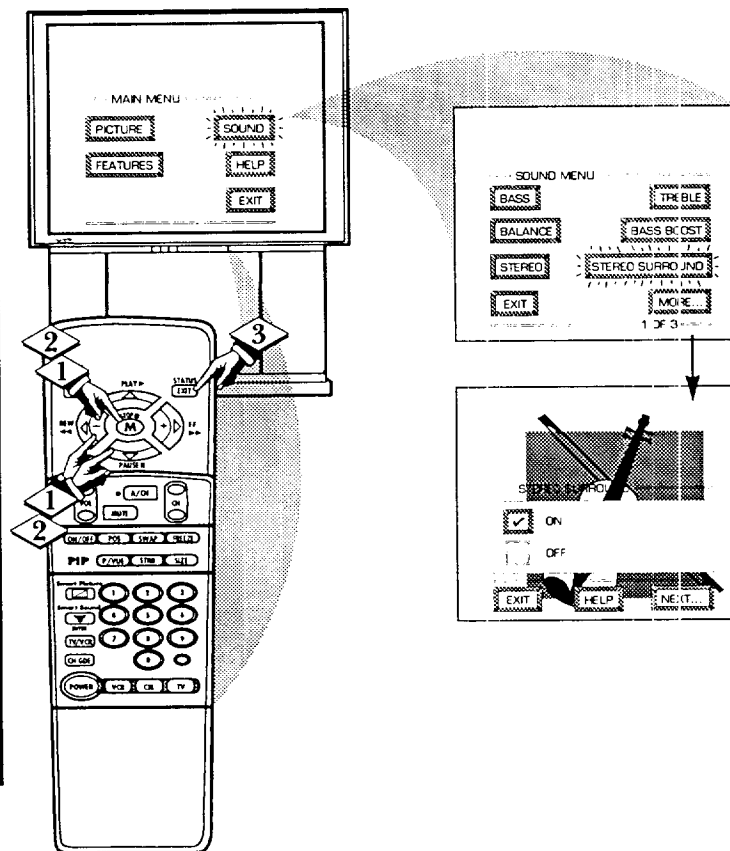

SMART HELP



Remember, with the Stereo Surround control turned ON even monaural (mono) audio source material can be heard through rear Surround Sound speaker connections (see page 24). Note: The monaural version of Surround Sound may be louder at the rear set of speakers than what is normally heard with true stereo signal Surround Sound, but this is normal

DISPLAY VOLUME

Use the DISPLAY VOLUME control to see the TV's volume level settings on the TV screen. Once set the Volume Display will be seen each time the VOLUME buttons (on the TV or remote) are pressed.

BEGIN

- 1 Select DISPLAY VOLUME control.

With SOUND MENU (2 of 3) on screen, move the RED highlight with the MENU (M) buttons. Then press the MENU button.

- 2 Press the MENU ▲▼ and MENU (M) buttons to highlight and turn ON (✓) the DISPLAY VOLUME control.

- 3 Press the STATUS button to clear the screen.

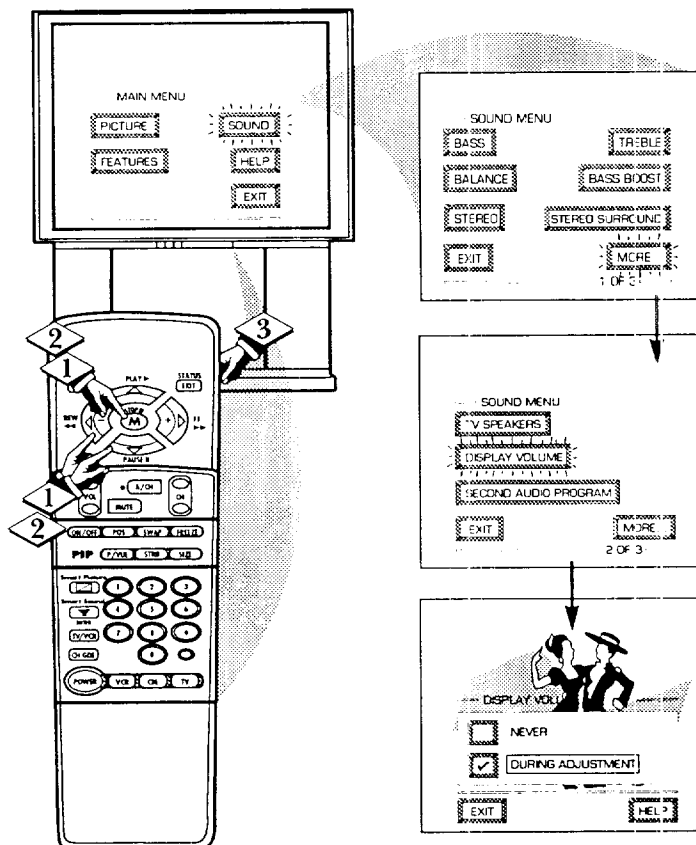

SMART HELP



Remember, "DURING ADJUSTMENT" means the volume level will be on screen whenever the Volume buttons are pressed.

TV SPEAKERS

Would you like to hear TV programs through your audio hi-fi system? The TV's Variable Audio Output jacks and TV Speaker On/Off control work together to offer you this TV sound option.

BEGIN

- 1 Connect the R(ight) and L(eft) VARIABLE AUDIO OUT jacks on the TV to the R and L Audio Input jacks on your amplifier or sound system.

Set the audio system's volume to normal listening level.

- 2 Turn the TV and audio system ON. You can now adjust the sound level coming from the audio system with the Volume ▲▼ buttons on the TV or remote.

- 3 To hear the TV sound from only the audio system speakers, select TV SPEAKERS control.

With SOUND MENU (2 of 3) on screen, move the RED highlight with the MENU (M) buttons. Then press the MENU button.

- 4 Press the MENU ▲▼ and MENU (M) buttons to highlight and turn OFF (✓) the TV SPEAKERS control.

You should now only hear TV sound coming from the audio system speakers.

- 5 Press the STATUS button to clear the screen.

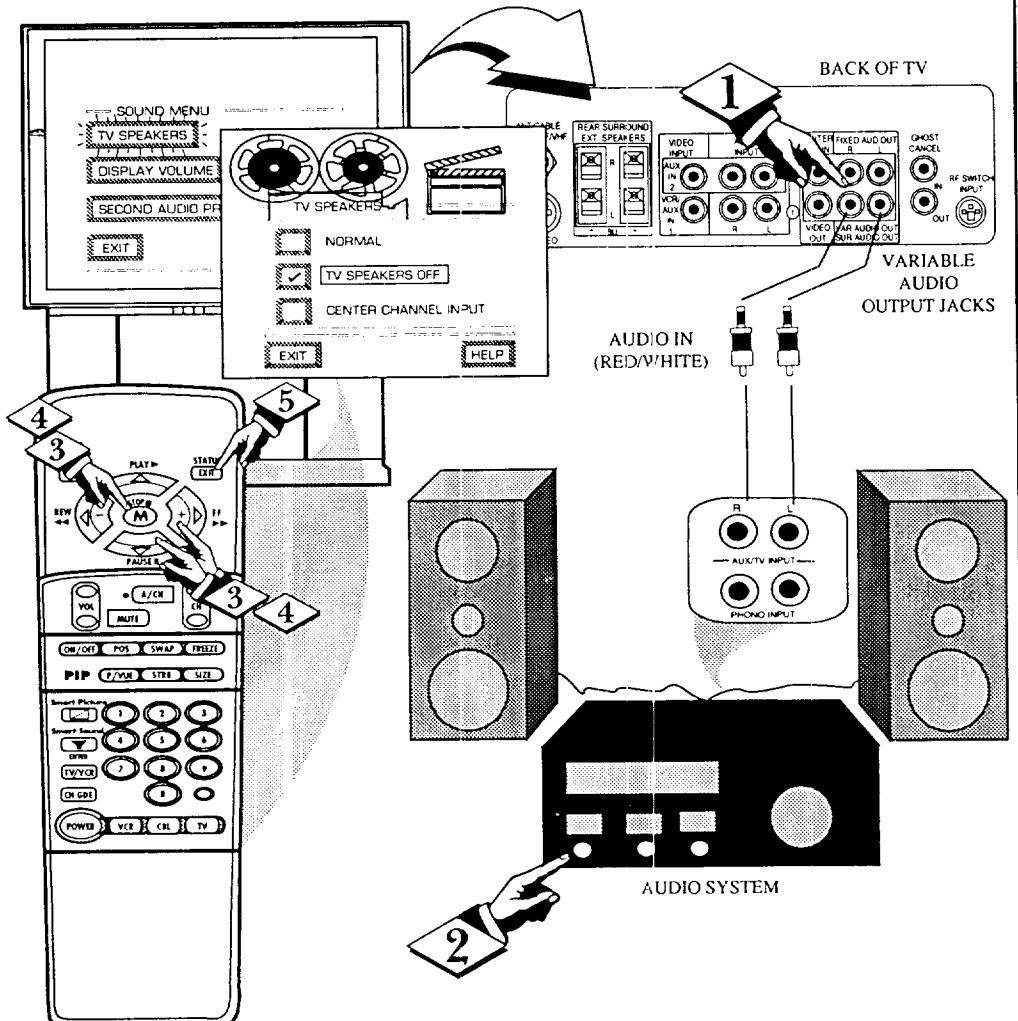

SMART HELP



Remember, the audio system may have to be in AUX(iliary) mode to play sound from the TV (Outputs).

Note: When the TV SPEAKER control is set to "NORMAL" (for TV speaker operation) make sure the VARIABLE AUDIO OUTPUT control (see next page) is also set to "STEREO" in order for the TV's AUDIO OUTPUT jacks to work properly.

SURROUND SOUND

By adding optional external speakers to the TV's sound system, you can create the feeling of reflected sound that surrounds you at a movie theater or concert hall.

BEGIN

- 1 Connect both external speakers to the speaker wire terminals on the TV.

Recommended speakers: 8ohm, 15 watt minimum. Be sure the (+) and (-) speaker wires are connected to the correct R(ight) and L(ef) speaker terminals on the TV.

- 2 Place the speakers so the viewing area is between the TV and the rear surround speakers. (See overhead view drawing.)

- 3 Turn TV ON and place the STEREO control to the "STEREO IF AVAILABLE" (⚡) position.

After setup whenever a stereo signal is received the audio will be heard in Surround Sound.

STOP

SMART HELP



Remember, Surround Sound will not work with only one speaker connected; or with monaural audio material (unless Stereo Surround control is turned ON - see page 22).

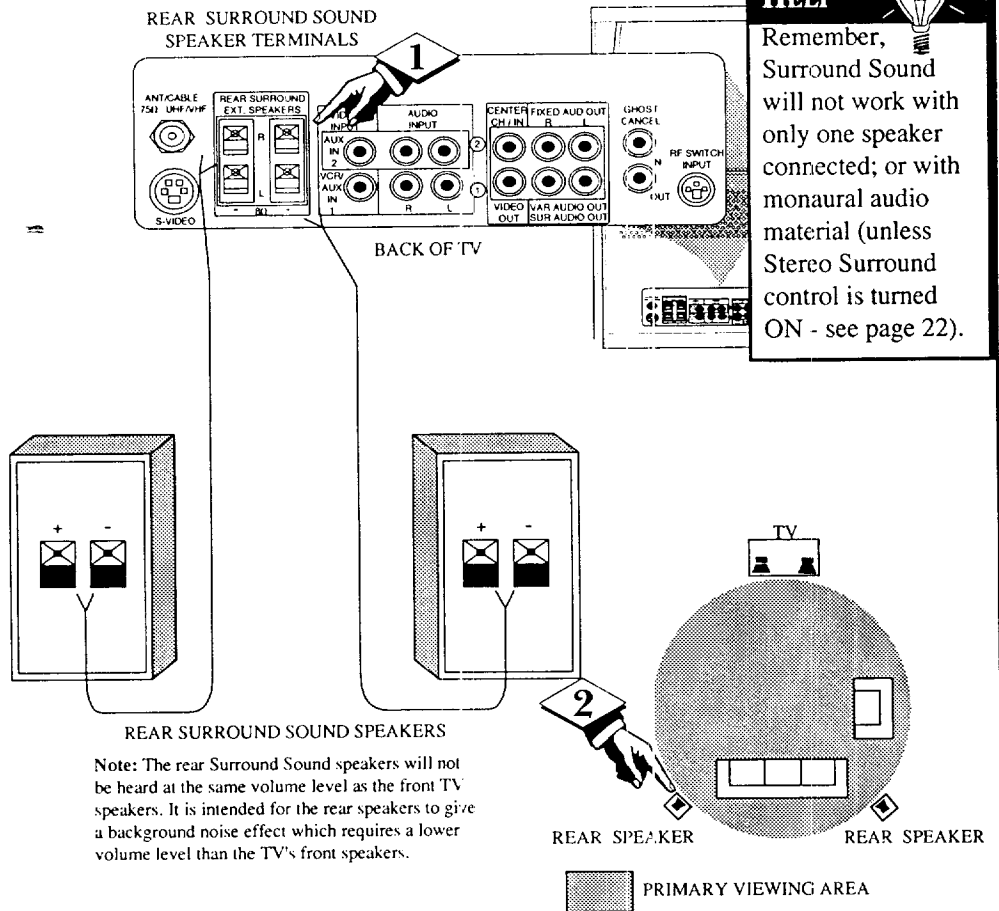

VARIABLE AUDIO OUTPUT

The TV's Variable Audio Output jacks can also be used for Surround Sound. Once they are connected to an external hi-fi system its speakers can be used for the playback of Surround Sound.

BEGIN

- 1 Connect the R(ight) and L(ef) VARIABLE AUDIO OUT jacks on the TV to the R and L Audio Input jacks on your amplifier or sound system.

- 2 Turn TV ON and place the VARIABLE AUDIO OUTPUT on screen control to the SURROUND (⚡) position. (Sound Menu 3 of 3).

Note: This will change the Left/Right channel audio line level signal at the Audio Output jacks to the same signal found at the TV's Surround Sound Speaker terminals.

STOP

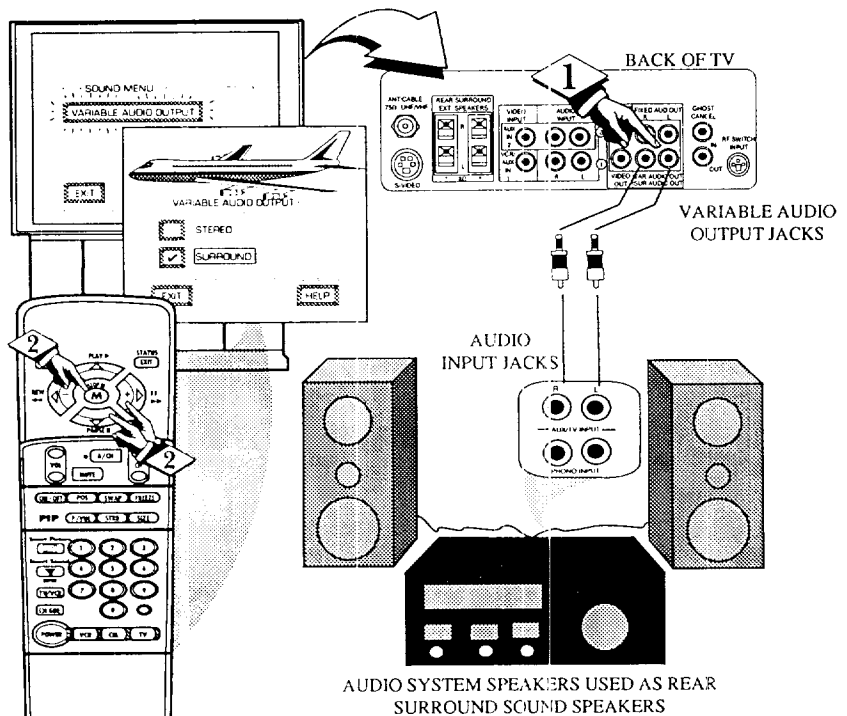

With the use of an optional Dolby Surround Prologic Amplifier you can receive the added sound dimension found only in Dolby Surround programs. Dolby Surround combines wide left-to-right stereo separation with solid center channel imaging, complemented by a front-to-back soundfield effect. The result for you the listener is to create a movie theater or concert hall "you are there" sound sensation.

BEGIN

- 1 Connect the **FIXED** Audio Output jacks on the TV to the **AUX INPUT** jacks on a Dolby Prologic Audio Amplifier system.
- 2 Connect the **CENTER CHANNEL** Input jack on the TV to the **CENTER PRE-AMP** jack on the Dolby Prologic Amplifier.
- 3 Connect the rear set of Surround Sound speakers to the (+,-) connections on the Dolby Surround Amplifier.
- 4 Turn the TV ON. Set TV Volume to normal listening level. Place the TV's TV SPEAKERS (Sound Menu 2 of 3) control to "CENTER CHANNEL INPUT".
Turn the Dolby Prologic Amplifier ON. Place its **SURROUND MODE** control to the **Dolby Prologic** mode.
- 5 The full effect of **DOLBY SURROUND** programs (either broadcast, VCR, or VDP) can now be heard through the TV and Amplifier system speakers.



SMART HELP



Remember. R(ight)/L(eft) channel stereo sound and rear Surround sound will be heard from the external (or Dolby Prologic Amplifier system) speakers. The TV's front cabinet speakers are used for true Center Channel sound necessary to complete the Dolby Prologic Surround arrangement.

You will need the following to set-up and use the designed SURROUND SOUND system shown below:

- One set of rear Surround Sound speakers
- One Dolby Prologic Audio Amplifier (with Center Pre-Amp Output and twin speakers)
- One DOLBY SURROUND encoded source (either playback - VCR, VDP, etc. - or broadcast).

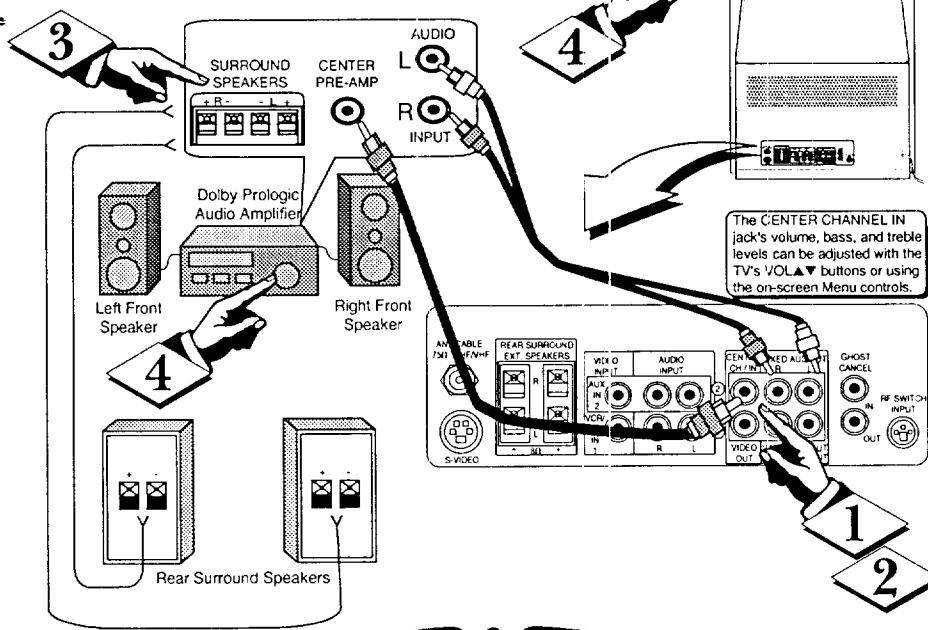

The CENTER CHANNEL IN jack's volume, bass, and treble levels can be adjusted with the TV's VOL ▲▼ buttons or using the on-screen Menu controls.

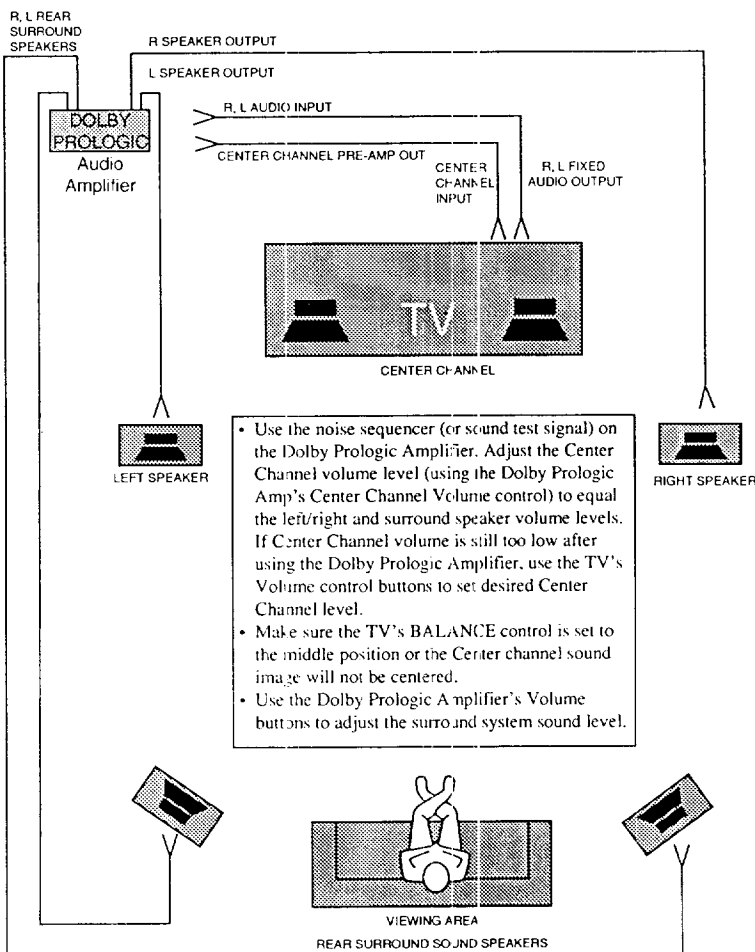

- Use the noise sequencer (or sound test signal) on the Dolby Prologic Amplifier. Adjust the Center Channel volume level (using the Dolby Prologic Amp's Center Channel Volume control) to equal the left/right and surround speaker volume levels. If Center Channel volume is still too low after using the Dolby Prologic Amplifier, use the TV's Volume control buttons to set desired Center Channel level.
- Make sure the TV's BALANCE control is set to the middle position or the Center channel sound image will not be centered.
- Use the Dolby Prologic Amplifier's Volume buttons to adjust the surround system sound level.

VCR/AUX INPUTS

The TV's Audio/Video Input jacks are for direct picture and sound connections between the TV and a VCR (or Video Disc Player, etc.) that has Audio/Video Output jacks.

To view the playback of a VCR tape by using the Audio/Video Input jacks on the TV:

BEGIN

1 Connect the VIDEO OUT jack from the VCR to the VCR/AUX VIDEO IN jack on the TV.

2 Connect the AUDIO OUT jacks R(ight) and L(eft) from the VCR to the VCR/AUX AUDIO IN jacks on the TV.

3 Select the "VCR/AUX 1" PICTURE SOURCE SELECT control on the TV.

With the FEATURES MENU on screen, move the RED highlight with the MENU (M) buttons. Then press the MENU button.

4 Press the MENU ▲▼ and MENU (M) buttons to highlight and select (✓) the VCR/AUX mode.

5 Turn the VCR ON and press PLAY to view the tape on the TV.



SMART HELP



Remember, after it is connected an easy way to select the VCR/AUX mode is to press the VCR button on the front of the TV (or the TV/VCR button on the remote.) Channels 3 and 4 can also be selected in this way.

Or if you have added VCR/AUX to the TV's channel memory (see page 14), just press the CHANNEL ▲▼ buttons to select the VCR/AUX mode.

PICTURE AND SOUND FROM
PLAYBACK OF VCR TAPE

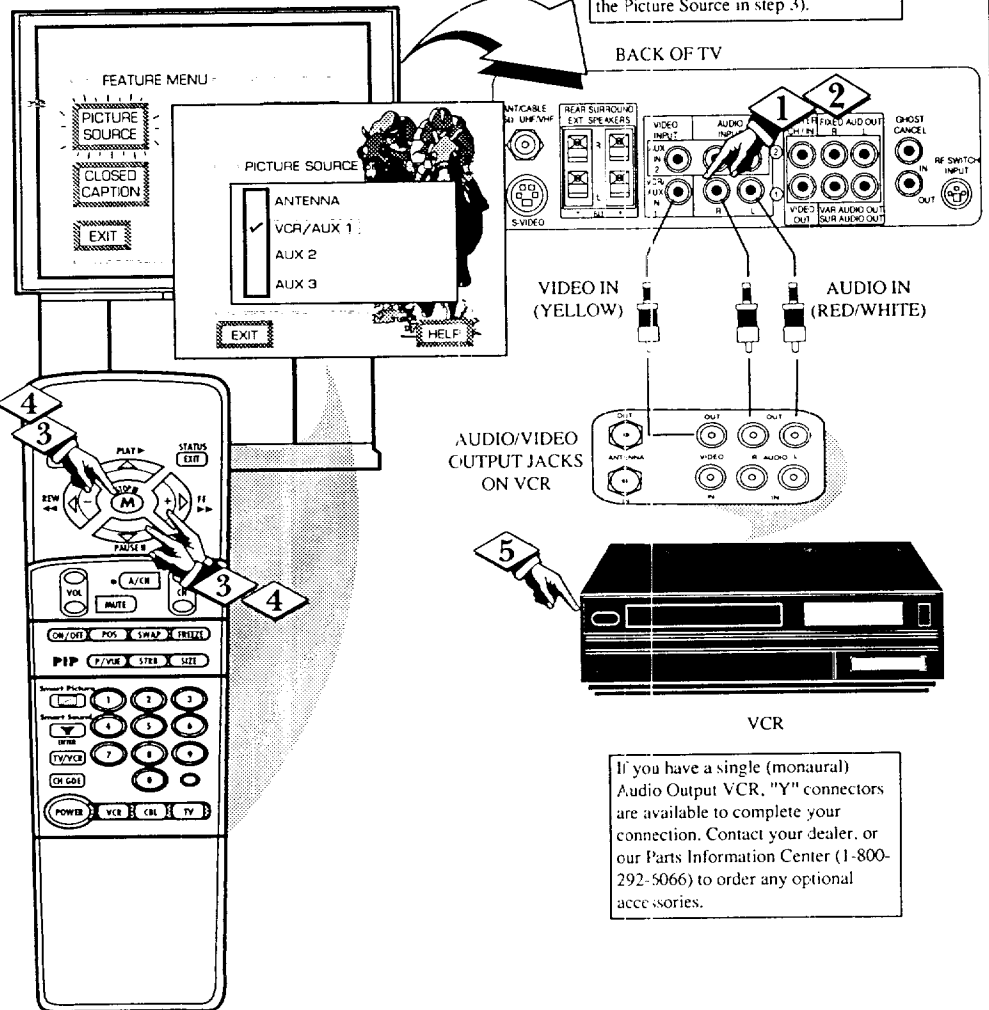

If you have a single (monaural) Audio Output VCR, "Y" connectors are available to complete your connection. Contact your dealer, or our Parts Information Center (1-800-292-5066) to order any optional accessories.

AUX 3 INPUTS

For more convenient Direct playback connections the TV's Front Audio/Video Input panel can be used. Located next to the TV's front control panel (under a small cover door) these Input jacks allow for quick and easy connections, particularly for the playback of Camcorder tape recordings.

To view the playback of a Camcorder recording using the Audio/Video Input jacks on the front of the TV:

BEGIN

- 1 Connect the VIDEO OUT jack from the Camcorder to the Front VIDEO IN jack on the TV.
- 2 Connect the AUDIO OUT jacks R(ight) and L(eft) from the Camcorder to the Front AUDIO IN jacks on the TV.
- 3 Select the "AUX 3" PICTURE SOURCE SELECT control on the TV.
With the FEATURES MENU on screen, move the RED highlight with the MENU (M) buttons. Then press the MENU button.
- 4 Press the MENU ▲▼ and MENU (M) buttons to highlight and select (↵) the AUX 3 mode.
- 5 Turn the Camcorder ON and press PLAY to view the tape on the TV.



SMART HELP

Remember, after it is connected an easy way to select the AUX 3 mode is to press the VCR button on the front of the TV (or the TV/VCR button on the remote.) Channels 3 and 4 can also be selected in this way.

Or if you have added AUX 3 to the TV's channel memory (see page 14), just press the CHANNEL ▲▼ buttons to select the VCR/AUX mode.

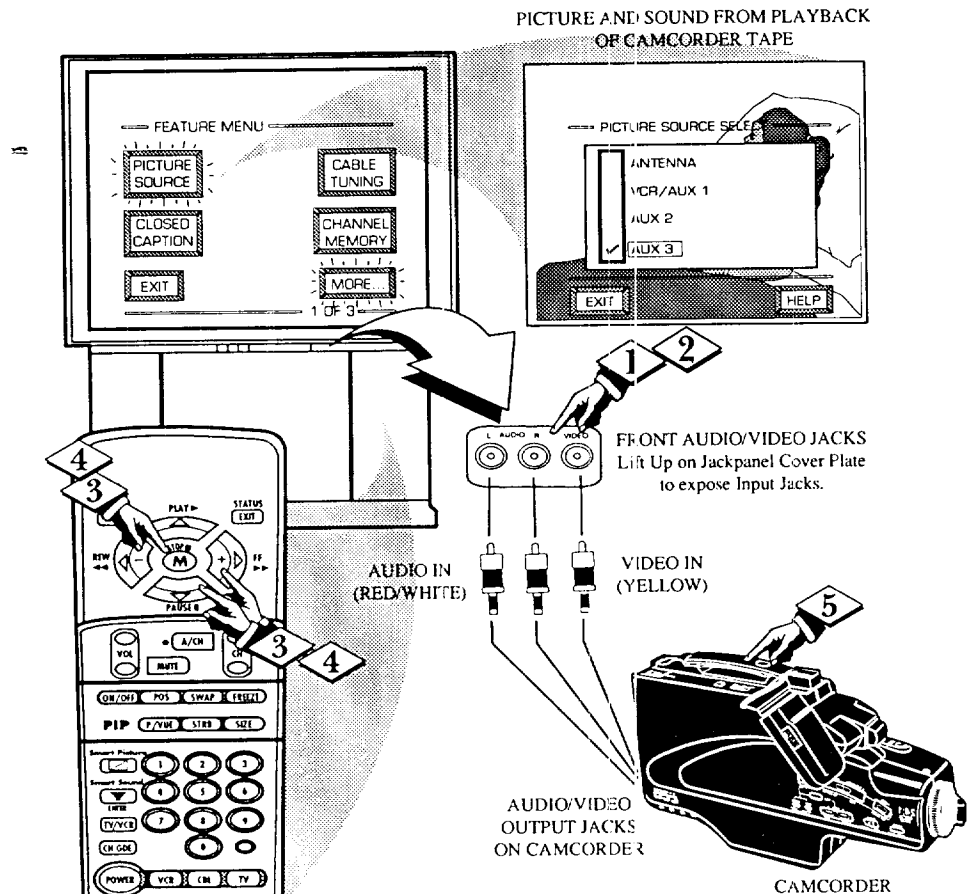

If you have a single (monaural) Audio Output Camcorder, "Y" connectors are available to complete your connection. Contact your dealer, or our Parts Information Center (1-800-292-6066) to order any optional accessories.

VCR/AUX1 - S-VIDEO INPUTS

The (Super)-Video connection on the rear of the TV can give you better picture detail and clarity, for the playback of S-VHS VCR tapes or Video Discs, than the normal antenna picture connections.

Note: The VCR (or Video Disc Player) must have a S-VIDEO OUT(put) jack in order for you to complete the connections shown on this page.

BEGIN

- 1 Connect the S-VIDEO (S-VHS) OUT jack from the VCR to the S-VIDEO jack on the TV.

The S-VIDEO connecting cable will be supplied with the S-VHS VCR (or Video Disc Player).

- 2 Connect the AUDIO OUT jacks R(ight) and L(ef) from the VCR to the AUX IN1 jacks on the TV.

- 3 Select the "S-VIDEO" PICTURE SOURCE control.

With the FEATURES MENU on screen, move the RED highlight with the MENU (M) buttons. Then press the MENU button.

The "S VIDEO" picture source option appears only when a S-VIDEO cable has been connected to the TV.

- 4 Turn the VCR ON and place it in the S-VIDEO (or S-VHS) playback mode. Insert S-VHS cassette tape and playback in a normal manner.



SMART HELP



Remember, after it is connected an easy way to select the S-VIDEO mode is to press the VCR button on the front of the TV (or the TV/VCR button on the remote.)

Or if you have added VCR/AUX to the TV's channel memory, just press the CHANNEL ▲▼ buttons to select the S-VIDEO mode.

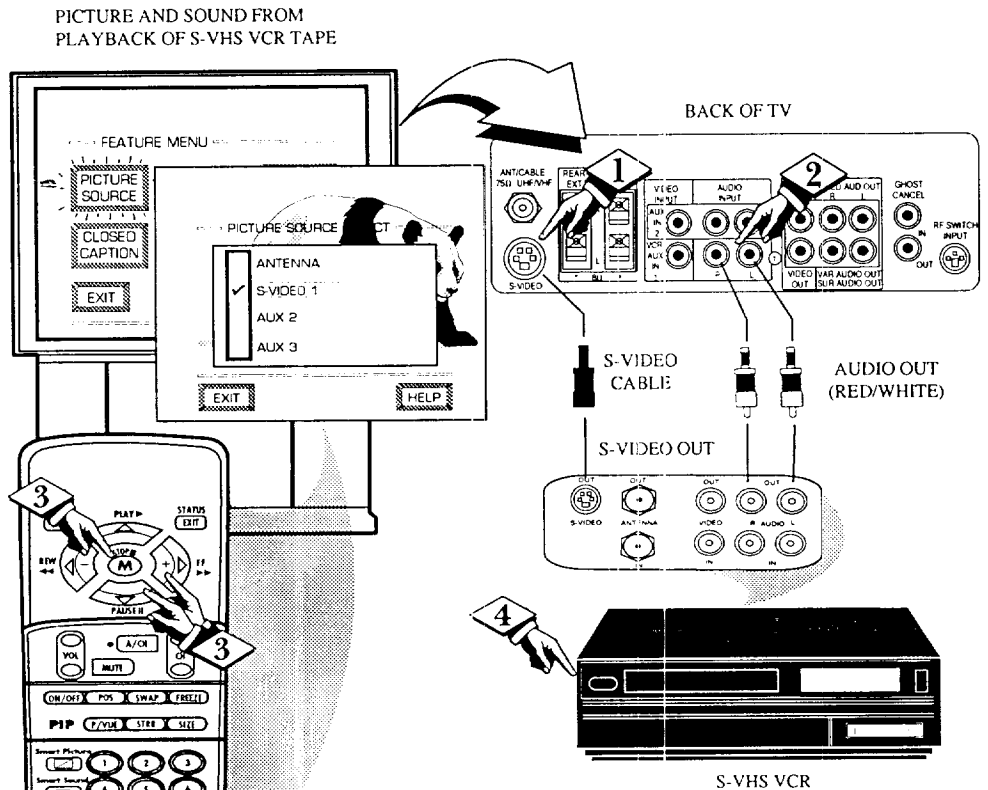

AUDIO/VIDEO OUTPUTS

The Audio/Video Output jacks on the TV can be used to record TV programs on VCRs which have Audio/Video Input jacks.

To record TV programs by using the Audio/Video jacks on the TV:

BEGIN

- 1 Connect the VIDEO OUT jack from the TV to the VIDEO IN jack on the VCR.
- 2 Connect the AUDIO OUT jacks R(ight) and L(eft) from the TV to the AUDIO IN jacks on the VCR.
- 3 Select the "ANTENNA" PICTURE SOURCE control on the TV.

With the FEATURES MENU on screen, move the RED highlight with the MENU (M) buttons. Then press the MENU button.

Select the channel on the TV that you want to record.

- 4 Turn the VCR ON. Put a cassette tape in the unit and place the VCR in the RECORD mode.



SMART HELP



Remember, If the VCR has an INPUT SELECTOR switch, place it in the LINE or CAMERA position.

Unattended Timer Recordings with a VCR are possible, but not recommended with this connection since the TV must be left ON for the VCR to record.

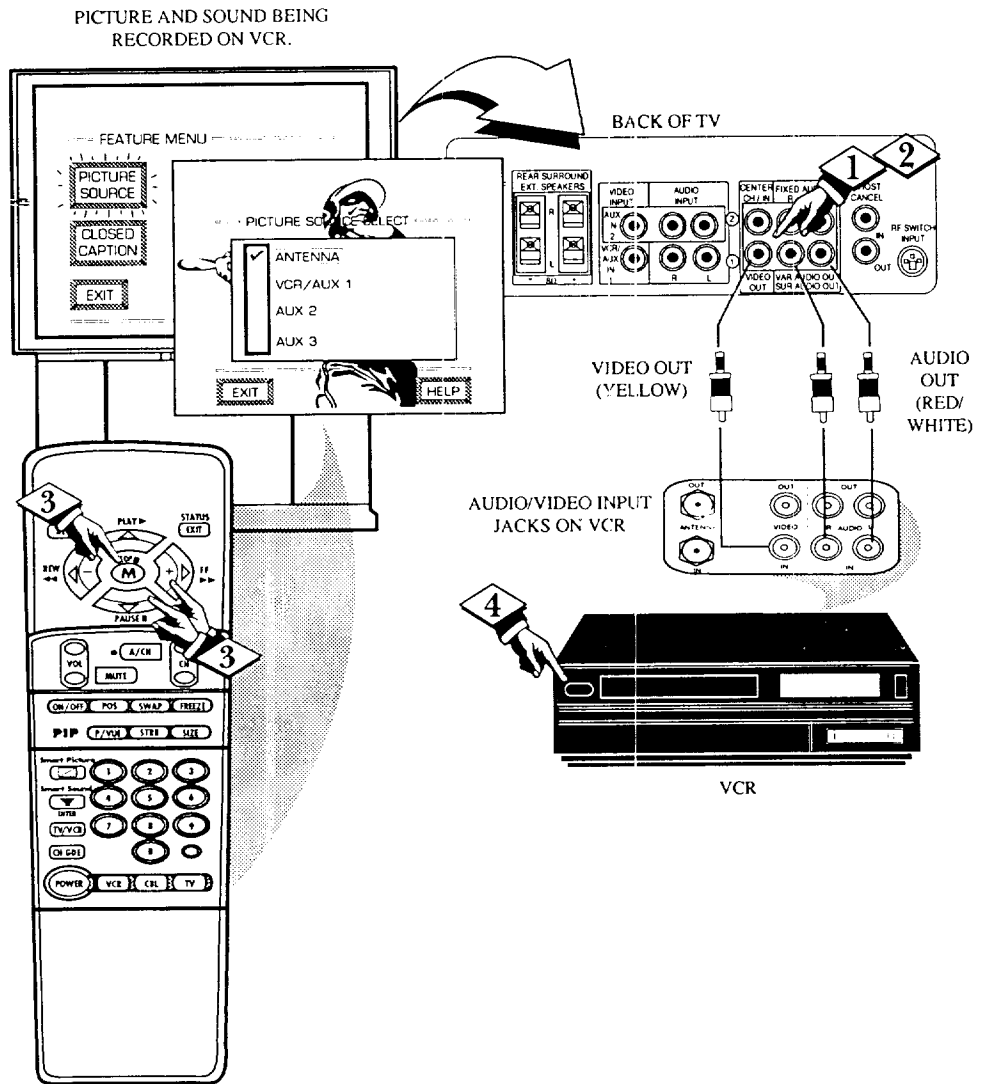

USING THE REMOTE LOCATOR FEATURE

Have you ever played hide and seek with your remote control? Are you tired of tearing the house apart trying to find if someone has stuffed the remote under the couch, put it on the shelves, or hid it in the desk? Well, your TV remote can save you all that looking by automatically signaling its location to you.

Here's how it works:

BEGIN

- 1 Press the **POWER** button on the set to turn the TV ON.

Note: Normally you can press any button on the front of the TV to turn the set ON. But for the remote locator to work you need to be sure to use the Power button at the TV.

A "locating remote" message shows on the TV screen.

- 2 Within a few seconds a chirping or beeping sound will begin to come from the remote control hand unit.

The remote will continue to signal its location for around 30 seconds. Normal TV program sound will not be heard while the remote locator is working.

- 3 Once you find the remote just press any button on the remote and the beeping sound will stop.

The remote is now ready for normal TV feature use.

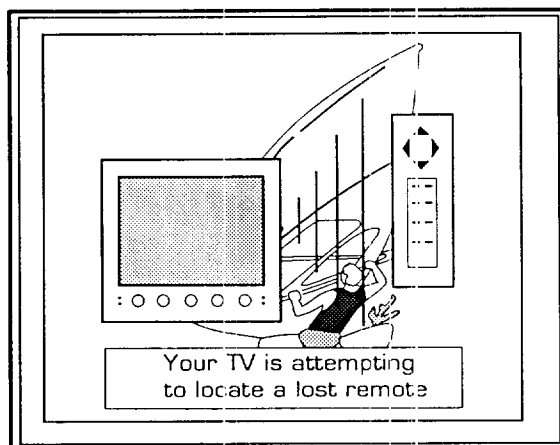

Remote Locator "homing" range is around 30 Feet.

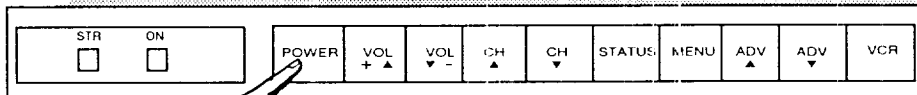

SMART HELP

Remember, the remote locator may not properly receive its "homing" signal from the TV if it has been placed on a metal shelf or counter material.

Also, since there's a special type of radio frequency "homing" signal receiver inside the remote we are required to notify you that any changes or modifications not expressly approved by Philips Consumer Electronics Company could void the user's authority to operate the remote equipment.



ADDRESS CODE PROGRAMMING OF REMOTE

For most homes this step would not be needed but for your information:

Up to 9 different remote locator address codes can be set on which the TV can send out its "homing" signal.

*This is done in case there is more than one TV (with a remote locator) present, and you want only one specific remote to be signaled when the TV is turned ON.**

To set a Locator Address Code:

BEGIN

- 1 With TV turned ON, press the **LOCATOR CODE** button on the remote. (Also be sure the TV **SYSTEM** button on the remote has been pressed.)

You will need a pencil or pen to press the recessed button.

The TV shows the present Remote Locator Code.

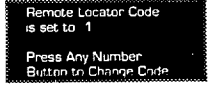

- 2 Press any number button (0-9) on the remote to set or change the Locator Code.

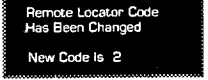

The remote will beep to let you know it has received the new Locator Code and then return to its normal operating mode.

SMART HELP



Remember, if batteries are replaced the Locator Code will need to be reentered.

When setting the Locator Code if any button, other than the number buttons, are pressed the remote will return to its normal operation mode.

*For owners who live in an apartment (townhouse or condominium) complex, this task may be necessary since the remote locator's signal can be sent and detected directly through adjoining walls.

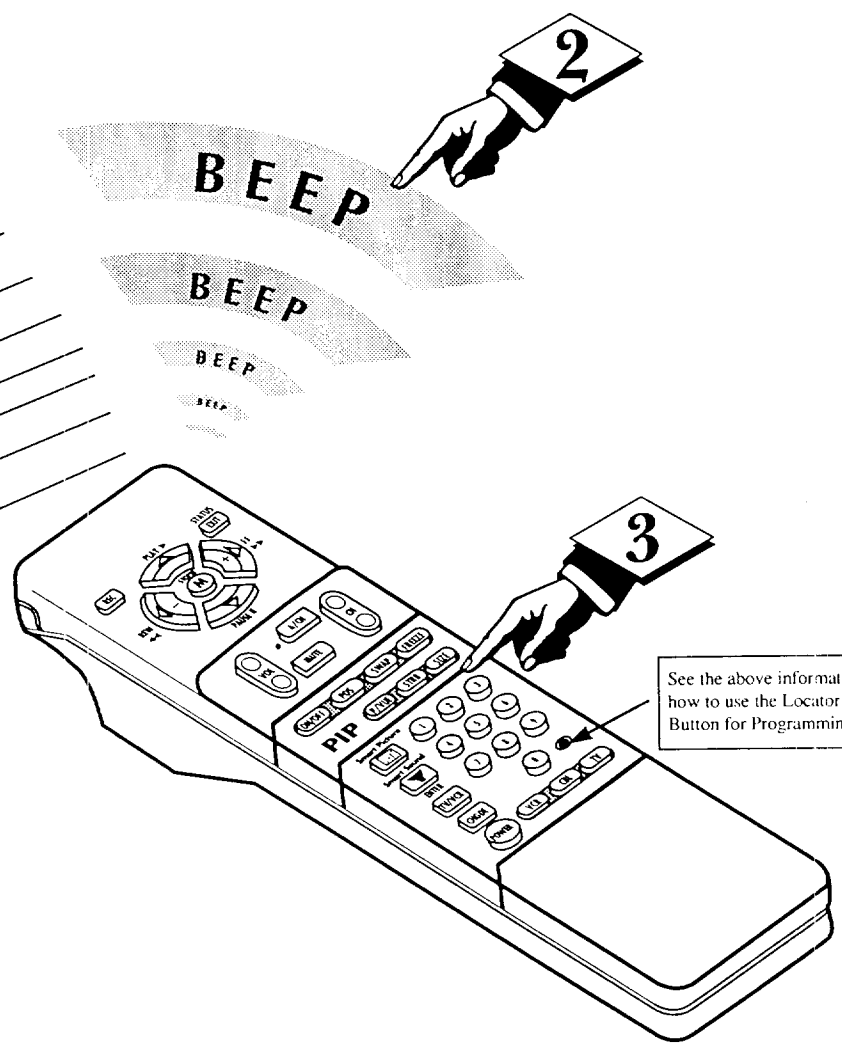

See the above information on how to use the Locator Code Button for Programming.

SMART PICTURE

Smart Picture quickly returns your TV to preset channel, picture, and sound level settings that have been placed in memory. Each Smart Picture category is preset at the factory for a different type of program or viewing condition, but you have the option to change the select controls to any levels you prefer. You can even rename or change the title of the Smart Picture category if you want.

BEGIN

- 1 Press the **SMART PICTURE** button on the remote.
List of "SMART PICTURE" categories shows on the TV screen.
- 2 Press the **SMART PICTURE** button repeatedly (or press the number button) to highlight one of the Smart Picture categories. (For example: Movies, Games, etc.)
Automatic factory preset levels for TV picture and sound controls are put in use for the selected category.
- 3 Press the **MENU** button to select the Smart Picture "SETUP" if you want to change the control settings for the selected category. (For example: "CUSTOM").
"SMART PICTURE MENU" shows on the screen with a list of picture and sound controls.
- 4 Press the **MENU** and **MENU** buttons to highlight and select the desired picture or sound control item.
Adjust any of the listed controls to the settings you would prefer for the currently selected Smart Picture category.
If you want SMART PICTURE to select a certain channel number for you, use the Picture Source Select - Antenna control to set the channel. (Smart Picture Menu 1 of 1).
- 5 After all control settings are finished, press the **STATUS** button

STOP

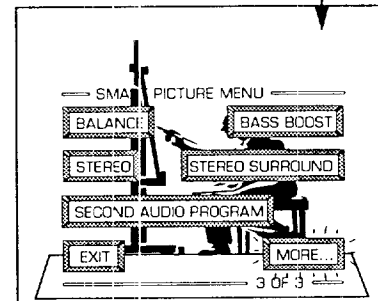
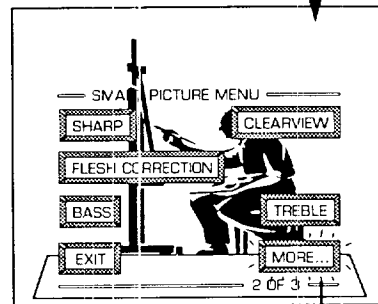
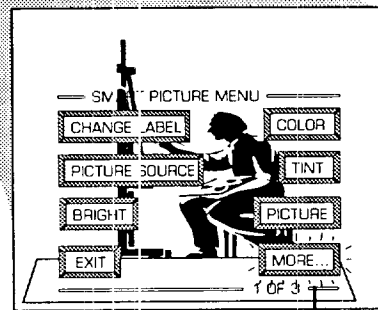
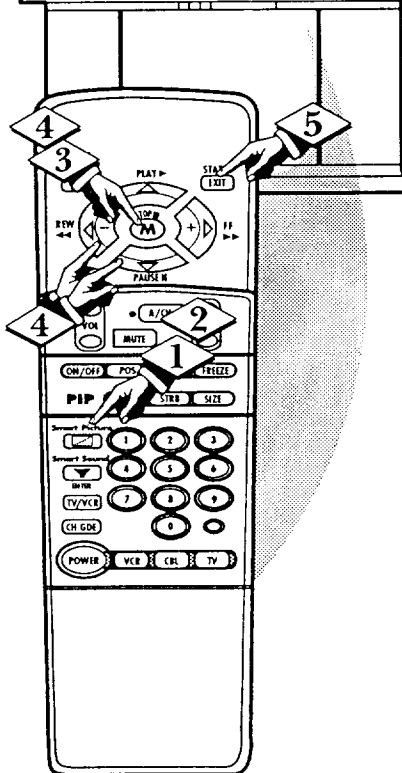
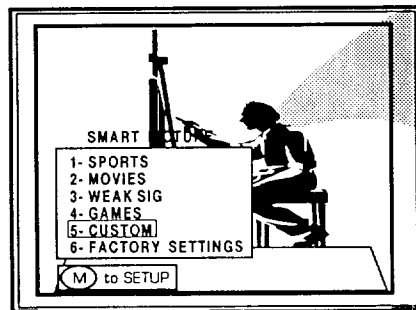



SMART PICTURE

To use the Smart Picture settings you placed in memory (see previous page):

BEGIN

1 Press the SMART PICTURE button on the remote.

List of "SMART PICTURE" categories shows on the TV screen.

2 Press the SMART PICTURE button repeatedly (or press the number button) to highlight the Smart Picture category you desire.

For example: press SMART PICTURE to select "CUSTOM". (See the "Change Label" section below on how to write new titles for the Smart Picture labels.)

3 The channel, picture and sound controls will automatically change to the settings you preset for that SMART PICTURE item.

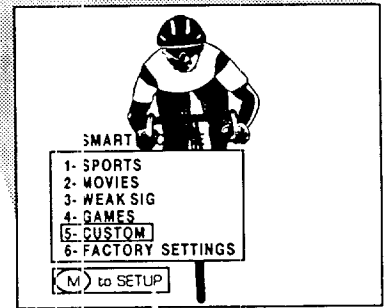
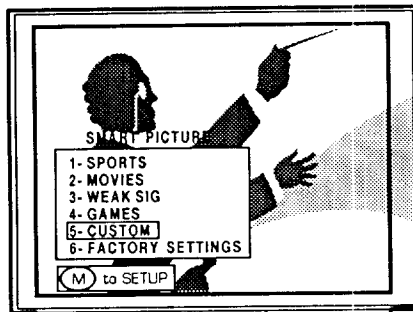

PICTURE AND SOUND CONTROLS CHANGE TO PRESET SMART PICTURE SETTINGS FOR SELECTED CATEGORY.

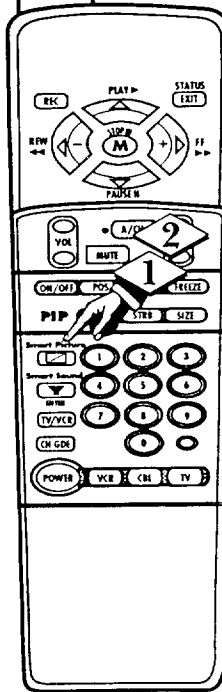

SMART HELP



Remember, the "FACTORY SETTINGS" item can be used at any time to return the TV to its factory preset picture and sound control levels.

CHANGE LABEL

The "CHANGE LABEL" control can be used to change the title of a SMART PICTURE setting into a name or label that may be easier for you to remember.

BEGIN

1 With the "SMART PICTURE LABEL" control on the screen, press the MENU ▲▼ buttons to spell out a new label or title for the selected SMART PICTURE.

2 Press the MENU ◀▶ buttons to move the red highlight to each letter space.

3 Press the STATUS button to clear the screen when the new label is finished.

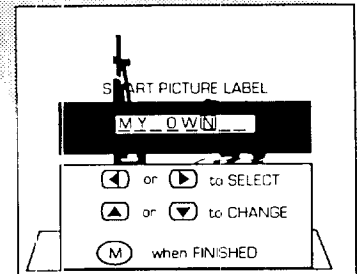
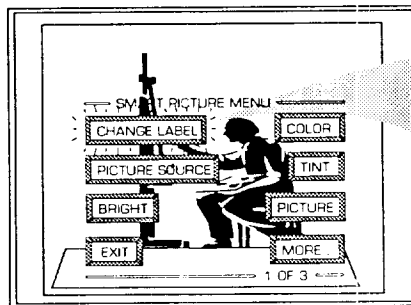

SMART SOUND

Are you tired of the sound of commercials following you into the next room or all through the house? Smart Sound allows you to preset a desired volume level that the TV sound will not go above. This makes for an even, more consistent sound by reducing the peaks and valleys that can occur during program changes or commercial breaks.

BEGIN

1 Press the Smart Sound button on the remote.

"SMART SOUND ON" shows on the TV screen.

2 Press the Smart Sound button repeatedly to turn the Smart Sound ON (or OFF.)

3 Press the STATUS button to clear the screen when completed.

STOP

SMART HELP



Remember, Smart Sound works for sound levels coming from either the Antenna/Cable input on the rear of the TV (RF audio); or the Auxiliary (VCR/AUX IN) audio inputs.

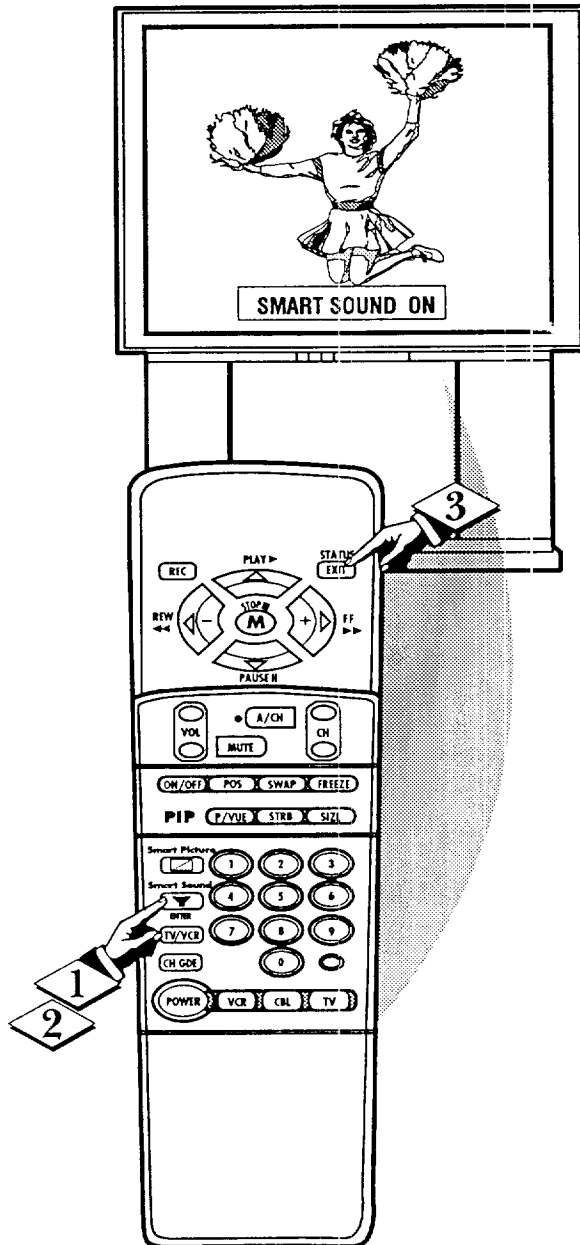

CHANNEL GUIDE

Do you ever have trouble remembering on which channel a particular station or network is located? The Channel Guide is a quick way to view and select channels from a list of Labeled channels.

A Label is a four letter callout you can set to appear with the on screen channel number. Example Label: WXYZ - for a TV station's call letters.

To select channels from the Channel Guide:

BEGIN

1 Press the CH GUIDE button on the remote.

A "CHANNEL GUIDE" shows on the screen with channel numbers and labels.

Keep pressing the CH GUIDE button to see what other labelled channels can be selected.

2 Press the number buttons on the remote to select the desired labelled channel.

Remember to press "0" first and then the number for single digit channels.

3 Press the MENU button to change a Label for a channel.

Press the MENU ▲▼ and MENU (M) buttons to highlight and select either:

"MANUAL" to create your own label for a channel.

"PRESETS" to choose from a list of prewritten channel labels.

(See instruction details on this page.)

4 Press the STATUS button to clear the screen.

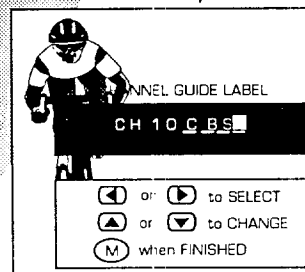
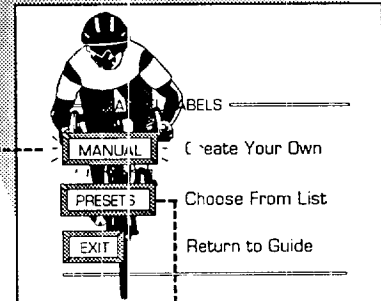
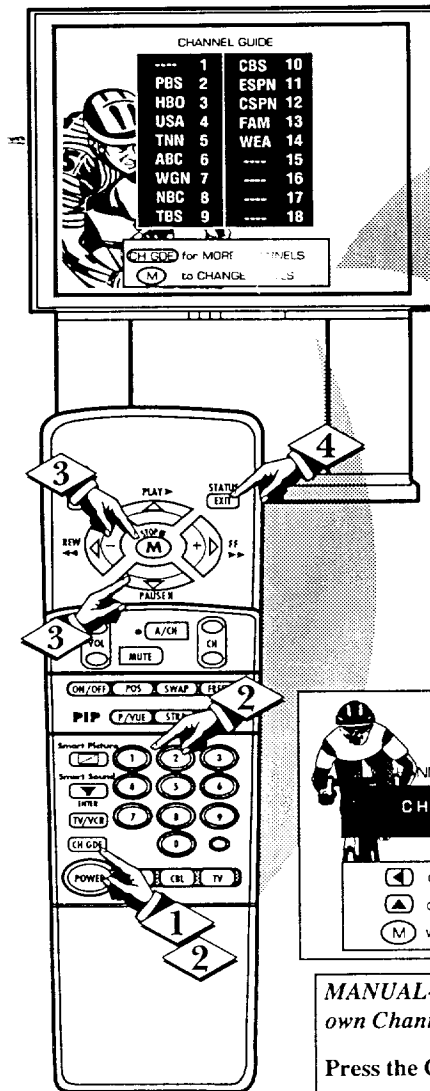

MANUAL- To create your own Channel Label:

Press the Channel ▲▼ or Number buttons to select desired station.

A red highlight shows the active letter space for the channel label.

Press the MENU ▲▼ buttons to pick any of the letters or symbols that are given for your use.

Press the MENU ◀▶ buttons to move the red highlight to the other letter spaces and repeat.

Press the STATUS button to clear the screen when finished.

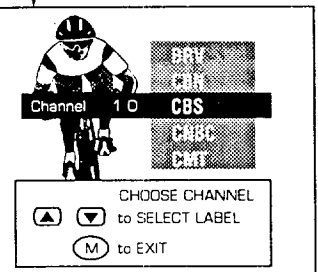

PRESETS-To pick a Label from the "LABEL" list:

Press the Channel ▲▼ or Number buttons to select desired station.

Press the MENU ▲▼ buttons to move up and down the Channel Label list.

Just stop on any label you might want to use.

The selected label automatically appears with channel changes and when the STATUS button is pressed.

Press the STATUS button to clear the screen when finished.

SETTING THE REMOTE TO WORK VCRs

Your remote control is set to work your TV and many infrared remote (IR) control VCRs. However, an easy one-time step may be necessary before the remote will work your VCR.

Try this initial check to see if going on to the following section is necessary.

BEGIN

- 1 Press the VCR System button on the remote.
- 2 Point remote toward VCR and press the POWER button.
- 3 Does the remote turn the VCR ON?
IF YES, and try the other VCR buttons on the remote. If they also work the VCR, then the remote is ready and no further steps are needed.
IF NO, continue...

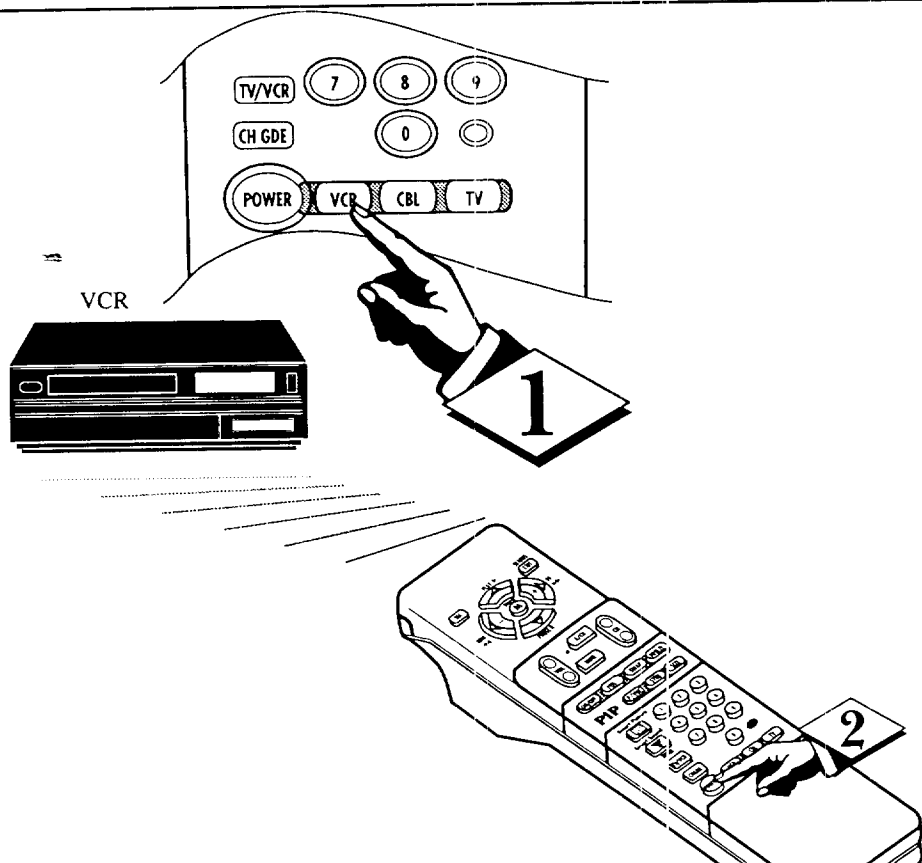

- 1 First look up a **TWO-DIGIT remote code number** for your brand VCR before going through the simple "1,2,3" steps (on the following page).

continue to next page

SMART HELP



Remember, if more than one number is listed, you may have to try more than the first two-digit code given in order to locate your VCR's remote code.

VCR BRAND	REMOTE CODE NO.	VCR BRAND	REMOTE CODE NO.
Akai	24, 25, 36	Multitech	27, 28
Audio Dynamics	14, 21, 29	NEC	14, 21, 29
Broksonic	31	Panasonic	01
Cannon	01	Pentax	02, 03
Capelhart	33	Philco	01, 02, 05, 27, 28
Craig	07, 30	Philips	00, 01, 05, 27, 28
Curtis Mathes	01, 32, 42, 43	Quasar	01
Daewoo	33	RCA	03, 04, 32, 42, 43, 44
DBX	14, 21, 29	Realistic	07, 11, 12, 23, 27, 28
Dynatech	27	Samsung	22, 30
Emerson	20, 31, 34, 40	Sansui	49
Fisher	06, 07, 08	Sanyo	07, 13
Funai	27, 28	Scott	19
GE	01	Sears	03, 08, 23
Goldstar	23	Sharp	11, 12
Go Video	45, 46	Shinton	35
Hitachi	03, 51	Sony	09, 10, 41
Instant Replay	01	Sound Design	27
JC Penney	01, 03, 23, 29	Sylvania	01, 02, 05
JVC	14, 47, 48	Symphonic	27
Kenwood	13, 14	Tatung	14
Lloyds	27	Teac	14, 27
Magnavox	00, 01, 02, 05, 27, 28	Teknika	26, 27
Magnin	30	Thomas	27
Marantz	29	TMK	20
Memorex	01, 07, 23, 27	Toshiba	18, 19
Minolta	03	Video Concepts	28
Mitsubishi	16, 17, 38, 39, 50	Yamaha	14, 29
Montgomery Ward	12	Zenith	15



Now that you have looked up the two-digit Remote Code Number for your brand of VCR (on previous page), you are ready to follow the four simple steps below.

Please read through steps 1-4 before beginning.

BEGIN

- 1 Press and release the REC (RECORD) button.
- 2 Within thirty seconds after releasing the REC button, press and release the VCR System button. Remote will begin to beep as it waits on your Code number entry in step 3.
- 3 Within thirty seconds after releasing the VCR System button, ENTER THE TWO DIGIT CODE NUMBER for the desired VCR. The remote is now ready to send commands to the VCR.
- 4 Point the remote at the VCR. Press the POWER button on the remote to turn the VCR ON.

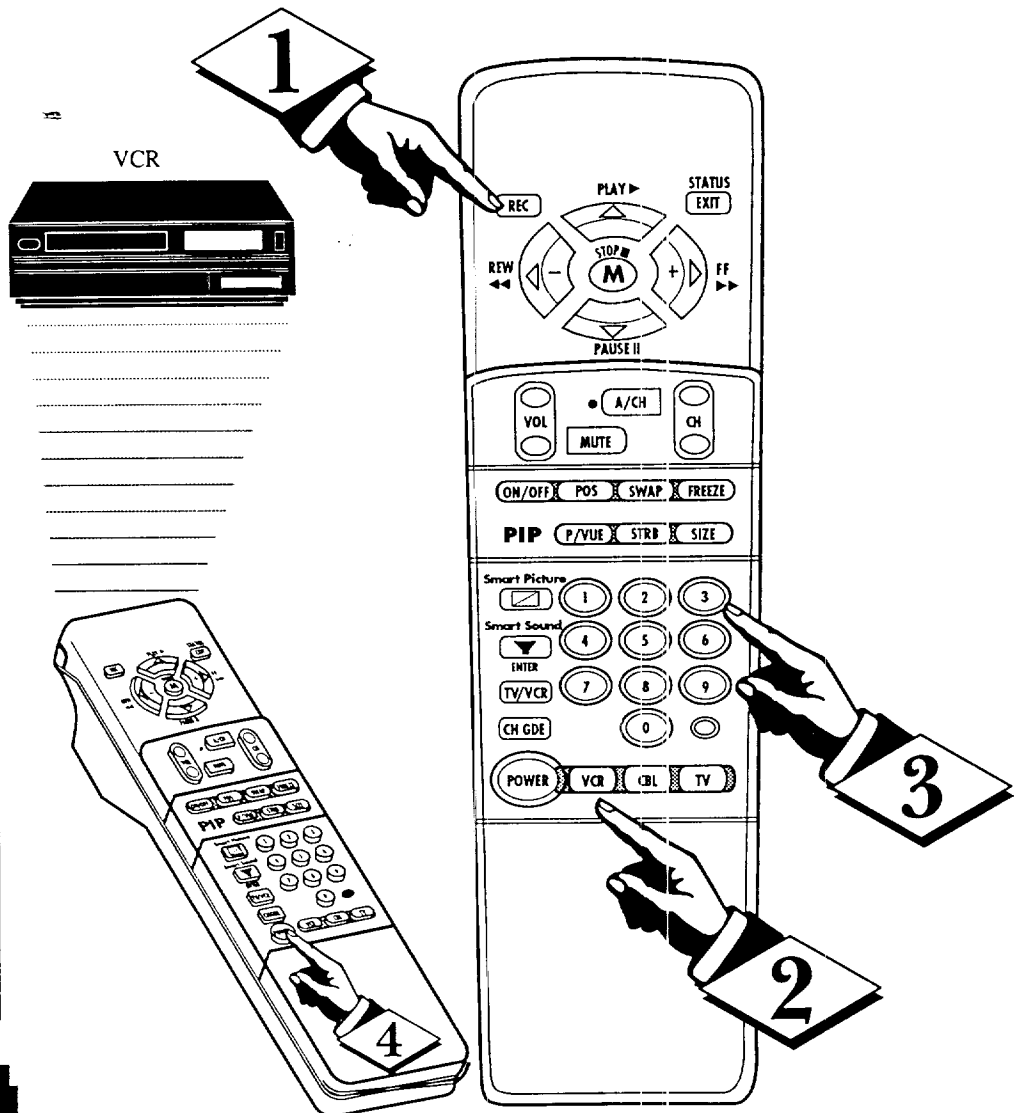

SMART HELP



Try it out. The Channel and VCR buttons on the remote should now operate the VCR.

Remember, if this doesn't work the first time, repeat steps using the same remote code number.

If after a second try the remote does not operate your VCR, and there are more code numbers listed for your brand VCR, use the next listed code number.

If after repeated attempts the code number method does not work your VCR, try the "VCR SEARCH" method on page 40.

SETTING THE REMOTE TO WORK CABLE TV CONVERTERS

Your remote control is set to work your TV and many infrared remote (IR) control Cable Converters. However, an easy one-time step may be necessary before the remote will work your Converter.

Try this initial check to see if going on to the following section is necessary.

BEGIN

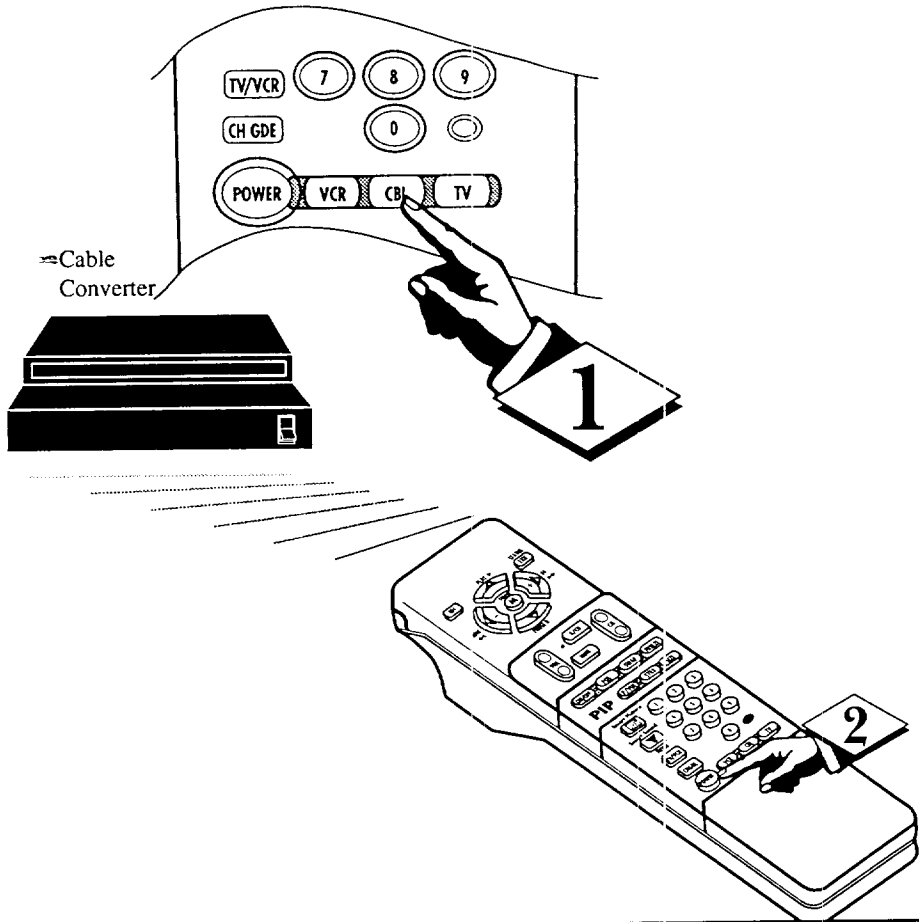

1 Press the CBL System button on the remote.

2 Point remote toward Cable Converter and press the POWER button.

3 Does the remote turn the Converter ON?
IF YES, and try the CH and CH number buttons on the remote. If they also work the Converter then the remote is ready and no further steps are needed.
IF NO, continue...

1 First look up a **TWO-DIGIT remote code number** for your brand Converter before going through the simple "1,2,3" steps (on the following page).

continue to next page

SMART HELP

Remember, if more than one number is listed, you may have to try more than the first two-digit code given in order to locate your Converter's remote code.

CONVERTER BRAND	REMOTE CODE NO.	CONVERTER BRAND	REMOTE CODE NO.
Archer	28	Rembrant	33
Diamond	23	Salora	52
Drake	37	Scientific Atlanta	08, 22, 47
Gemini	45	Sheritech	34
Hamlin	14, 15	Sylvania	16
Hitachi	25	Texscan	16, 48
Jerrold	01,02,03,04,05,30,46	Tocom	12,13, 53
Macom	29, 38	Toshiba	43
Magnavox	17,26, 31	Uniden Satellite	44, 54
NSC	49	Unika	50
Oak	06, 27, 39	Universal	36
Panasonic	18, 35	Video Tech	40
Philips	19, 20, 21, 24, 26	Video Way	51
Pioneer	09, 32	Viewstar	26
Regency	10, 11	Zenith	07, 41, 42



Now that you have looked up the two-digit Remote Code Number for your brand of Cable Converter (on previous page), you are ready to follow the four simple steps below.

Please read through steps 1-4 before beginning.

BEGIN

- 1 Press and release the REC (RECORD) button.
- 2 Within thirty seconds after releasing the REC button, press and release the CBL System button. Remote will begin to beep as it waits on your Code number entry in step 3.
- 3 Within thirty seconds after releasing the CBL System button, ENTER THE TWO DIGIT CODE NUMBER for the desired Converter. The remote is now ready to send commands to the Converter.
- 4 Point the remote at the Converter. Press the POWER button on the remote to turn the Converter ON.



SMART HELP



Try it out. The Channel and POWER buttons on the remote should now operate the Converter.

Remember, if this doesn't work the first time, repeat steps using the same remote code number.

If after a second try the remote does not operate your Converter, and there are more code numbers listed for your brand Converter, use the next listed code number.

If after repeated attempts the code number method does not work your Converter, try the "CONVERTER SEARCH" method on page 40.

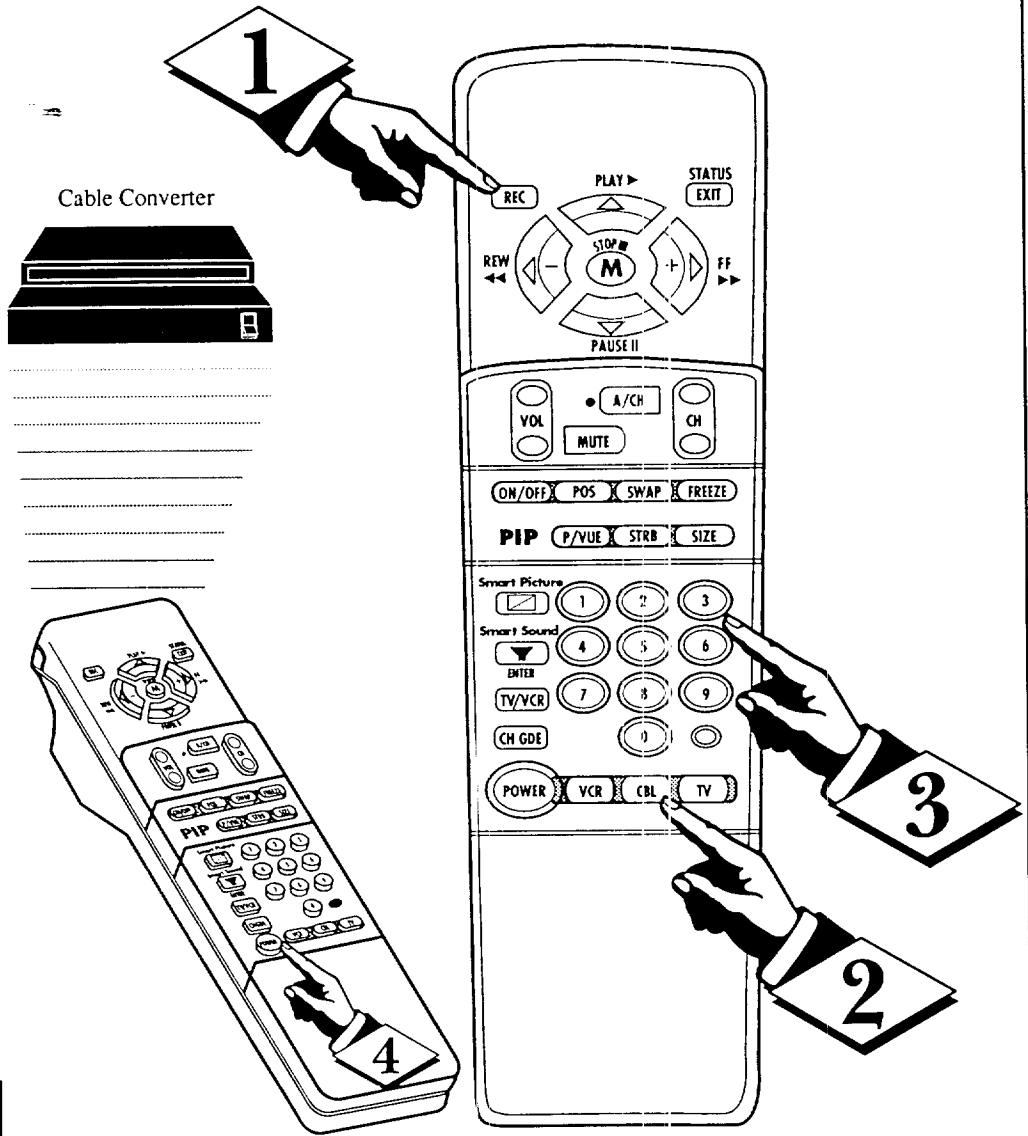

Your TV remote can be set to work your VCR or Cable Converter by what is called the **SEARCH** method.

If the "REMOTE CODE" number method shown in the previous section did not set your remote to work your VCR or Converter, then follow the easy steps listed below.

Please read through steps 1-4 before beginning.

BEGIN

- 1 Press the **POWER** button on the VCR or Converter to turn the unit ON.
- 2 Stand at least six feet away from the front of the VCR or Converter. **Point the remote** toward the unit. **HOLD DOWN** the **A/CH** and the desired **System (VCR or CBL-Converter)** buttons at the same time. **KEEP HOLDING** **BUTTONS DOWN**.
- 3 Watch the **Channel Indicator** on the unit. Channel Numbers will **SCAN UP** when the unit has been identified. This may take up to two minutes.
- 4 Release the **A/CH** and **System (VCR or CBL)** buttons as soon as channel numbers start to scan up. The code has been identified and the remote is ready to operate with the VCR or Converter.



SMART HELP



Remember, a minute or two can seem very long, but the code should be located within two minutes.

Don't let the VCR or Converter scan up more than five channels. The remote may pass up the right code and another two minute search cycle will have to be repeated.

If no channel change happens within two minutes, repeat steps 1-4. Should a channel change still not occur, the remote will not work with the desired unit.

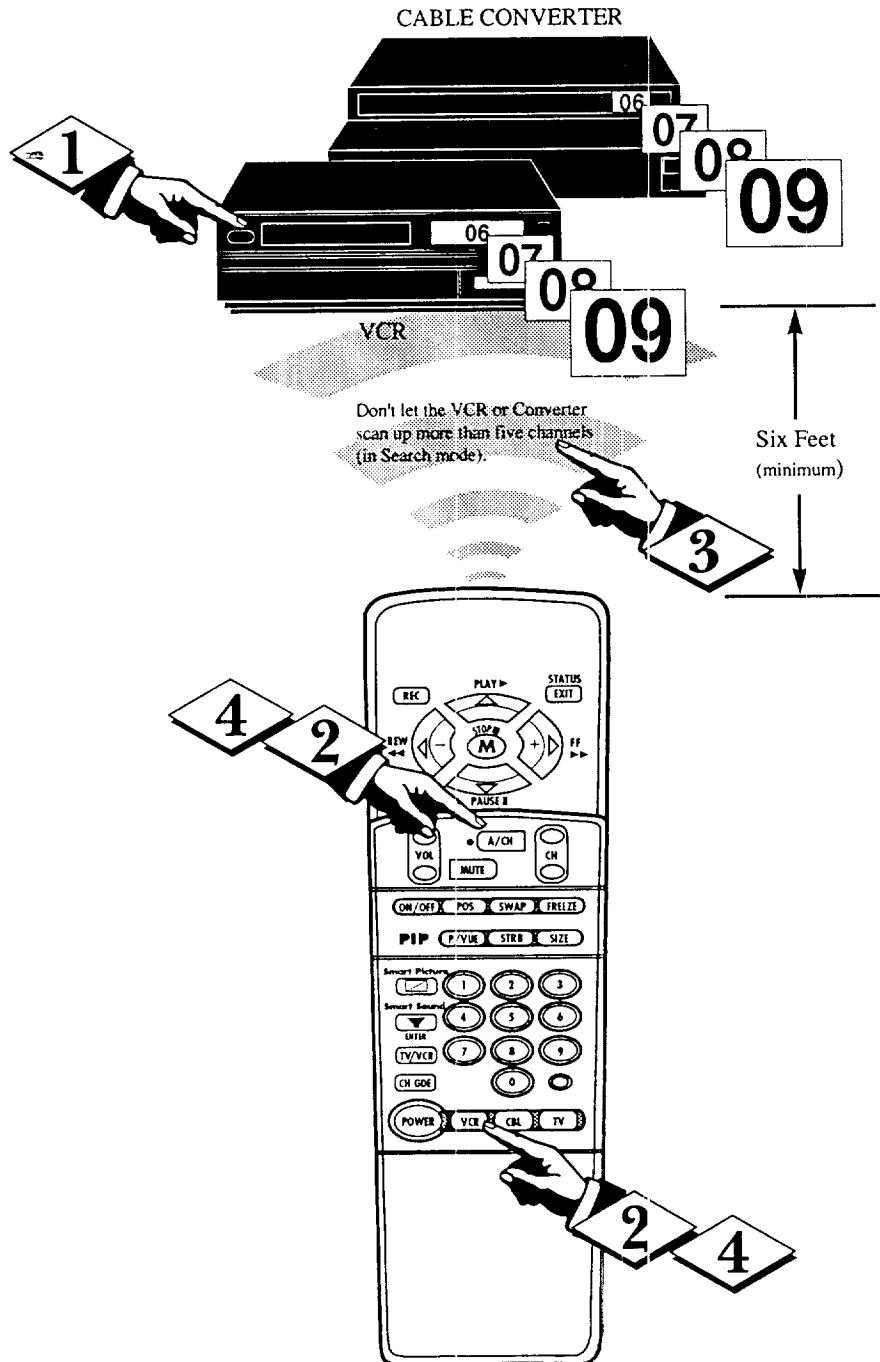

Remote will begin to beep when the A/CH and VCR or CBL System buttons are pressed.

USING THE REMOTE'S VCR BUTTONS



When using the TV remote with a VCR, first make certain it is set to control your VCR (by the REMOTE CODE or SEARCH method - see earlier section).

BEGIN

- 1 Press the VCR System button on the remote.
- 2 Point the top of the remote toward the front of the VCR (remote sensor window) when pressing buttons.



Record Button

Hold the RECORD button down, and then press the PLAY button to begin a VCR recording.

Rewind Button

Press to rewind tapes. For some VCRs you may need to press STOP button first then REWIND. In playback mode, hold button down to view picture moving rapidly in reverse.

Pause Button

Press to temporarily stop the tape during a playback, or recording. Press again to release Pause.

TV-VCR Button

Press to the VCR position ("VCR" indicator on the VCR will light) to view the playback of a tape. Press again to place in the TV position ("VCR" indicator on the VCR will go OFF) to view one program while recording another program. When used with the TV the TV/VCR button works as a source button. Each press cycles the TV between channels 3 and 4; the last view channel; and any AUXiliary Input mode (if it has been connected.) It is a quick one-button way to select these channels and modes (without directly entering the TV's Menu system.)

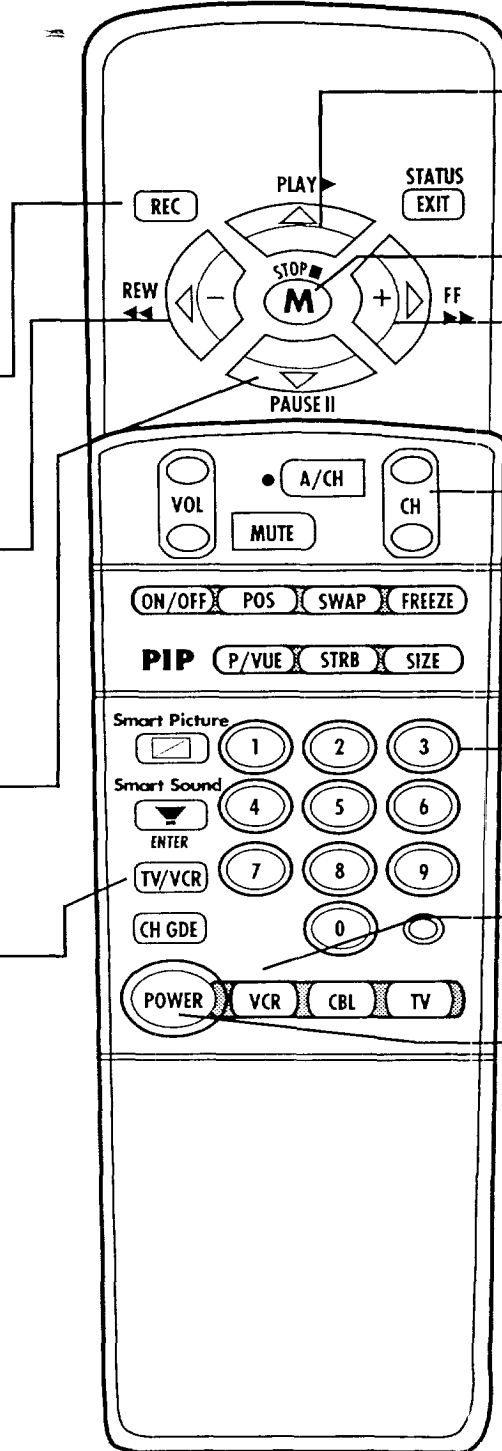

Play Button

Press to playback a tape. Hold down after pressing the RECORD button to start a recording.

Stop Button

Press to stop the tape.

Fast Forward Button

Press to rapidly advance the tape. For some VCRs you may need to press STOP first then FF. In Playback mode hold button down to view the picture moving rapidly in the forward direction.

Channel Scan Buttons

Press to scan up or down through VCR channel numbers.

Number Buttons

Press buttons for direct VCR channel selections.

VCR System Button

Press to send remote commands to the VCR.

Power Button

Press to turn the VCR ON and OFF.

SMART HELP



Remember, the VCR buttons on the remote will not operate your VCR if those features are not already found on your VCR remote control.

Note: All VCR functions (particularly Search, Rewind, Fast Forward, etc.) will operate the same as with the original VCR remote control provided with the VCR.

HOW TO USE THE PICTURE-IN-PICTURE (PIP) FEATURE

Picture in Picture (PIP) is the showing of two pictures on the TV screen at the same time. (One main screen picture and one small inset picture - or PIP).

Note: The PIP picture must be supplied by a VCR (or other accessory equipped with a VIDEO OUTPUT jack). If you already went through FIRST TIME SETUP (in the Quick-Use Guide), then the connections for PIP have been completed.

To see how channels selected on a VCR can be shown as PIP:

BEGIN

1 Connect the VIDEO OUT jack on the VCR to the VCR/AUX VIDEO IN jack (yellow) on the TV.

Also connect the AUDIO OUT (R and L) jacks from the VCR to the VCR/AUX AUDIO IN jacks (red and white) on the TV.

Also be sure the normal antenna connection between the VCR and TV are in place.

2 Move to the next page after the VCR to TV PIP connections are completed.

SMART HELP

For other possible PIP connections see page 48 for the "More PIP Connections" section.

If you have a single (monaural) Audio Output VCR, "Y" connectors are available to complete your connection. Contact your dealer, or our Parts Information Center (1-800-292-6066), for details.

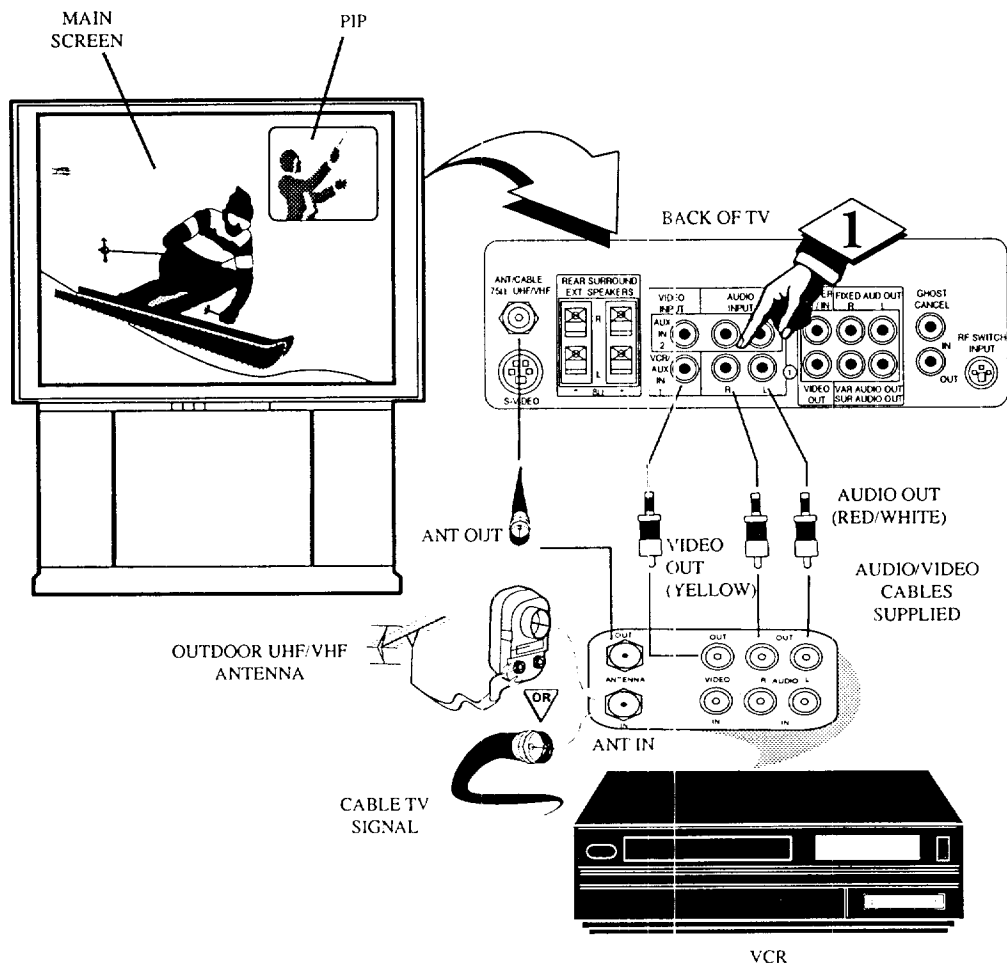



Now that you have completed the required connections on the previous page you are ready to follow the simple steps shown below.

3 Turn the VCR and TV ON.

Place the VCR in the TV mode -
Use the TV/VCR button on the VCR (or on the TV remote if it has been set to work with your VCR - see page 36.)

Place the TV's PIP INPUT control to "VCR/AUX" -

With FEATURES MENU (3 of 3) on screen, move the RED highlight with the MENU (M) buttons. Then press the MENU button.

Press the MENU and MENU (M) buttons to highlight and select the "VCR/AUX 1" item.

4 Select the channel on the VCR to view in the PIP window.

Select the channel on the TV to view on the main screen.

5 Press the PIP ON/OFF button on the remote.

The PIP window should show in one of the corners of the TV screen.



SMART HELP



Remember, if you see the same picture on the main screen and in the PIP window, you need to be sure the TV's PIP Picture Source control (page 46) is set to "VCR/AUX".

No sound will be heard with the PIP picture. See page 44 on how to "SWAP" the PIP picture with the main screen picture so that sound can be heard.

Also see the following page on how to operate other PIP features with the remote control.

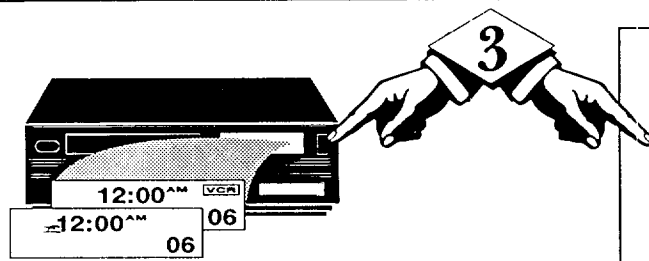

VCR IN "TV MODE"
(VCR Indicator Light will go out)

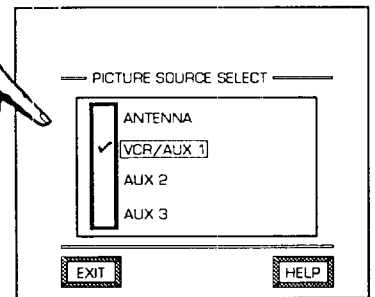

PIP INPUT CONTROL SET TO "VCR/AUX 1"

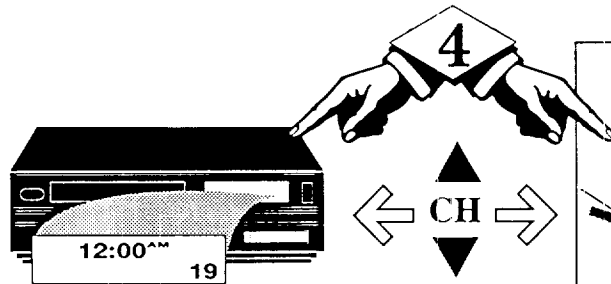

VCR - FOR PIP CHANNEL



TV - FOR MAIN SCREEN CHANNEL

VCR
SELECTED
CHANNEL

TV
SELECTED
CHANNEL

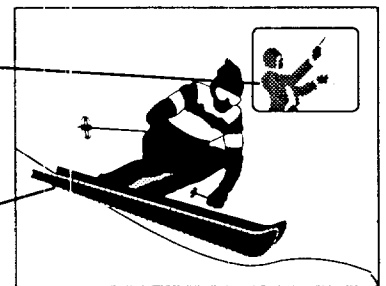

Be sure to point the remote at the front of the VCR when pressing VCR function buttons.

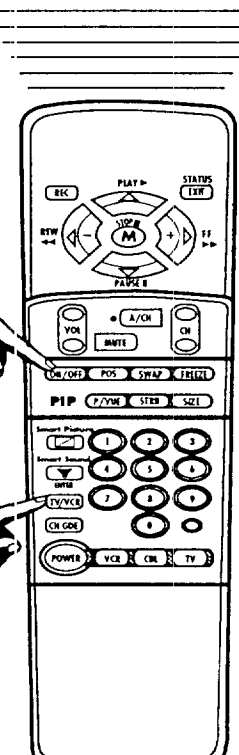

HOW TO USE PIP WITH THE TV REMOTE CONTROL

By using the PIP buttons on the remote the PIP picture can be moved and swapped with the main screen.

BEGIN

- 1 Press **PIP ON** button to show the PIP picture.

PIP screen appears in corner of TV screen. Press PIP ON again to remove PIP from the main screen.

- 2 Press **PIP POSITION** button on the remote to move the PIP picture (from corner to corner on the main screen).

- 3 Press **SWAP** to swap the main screen picture with the PIP picture.

Press SWAP again to return the main screen and PIP to their original positions. See the important reminder below.

- 4 Press **FREEZE** button to hold the current Main picture in the PIP window (Main picture is active).

If PIP is currently OFF the PIP will be automatically shown.

Press FRZ repeatedly to update the frozen PIP with current pictures. The frozen PIP cannot be swapped with the main screen.

Press the PIP ON/OFF button to drop the frozen PIP picture from the screen.

continue to next page

SMART HELP

Remember, if the TV is showing a "VCR/AUX" supplied picture on the main screen (when the TV and VCR are turned OFF), a blank screen will appear when the TV is turned back ON again.

If this happens, just press the CH(annel) ▲ or ▼ buttons to select a TV station for normal viewing.

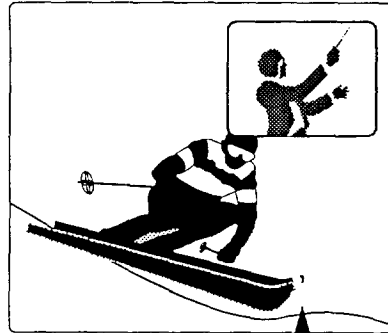

3. PIP SWAP

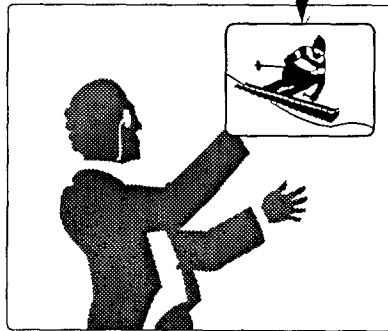

2. PIP POSITION

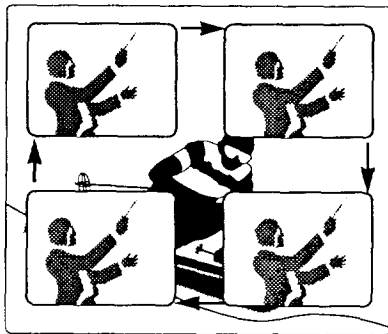

4. FREEZE

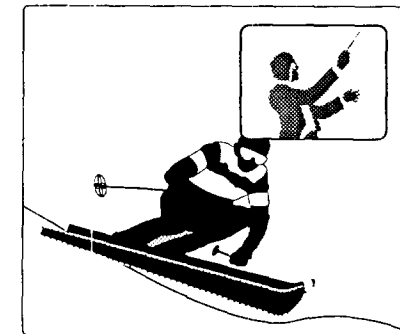
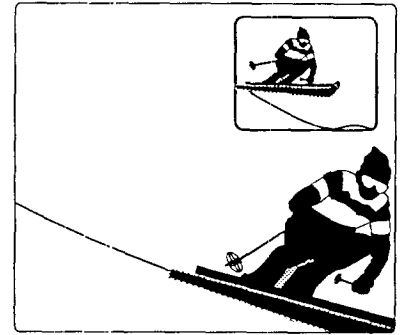

1. PIP ON / OFF



5. PIP SIZE



6. PIP STROBE

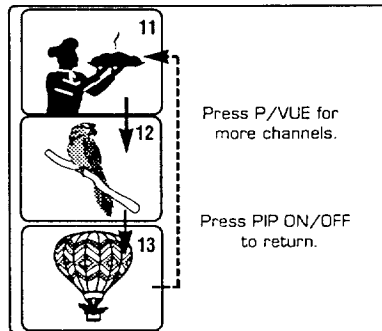
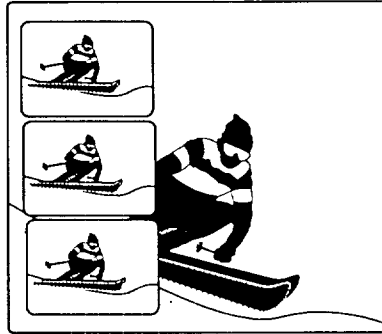

7. PIP PREVIEW

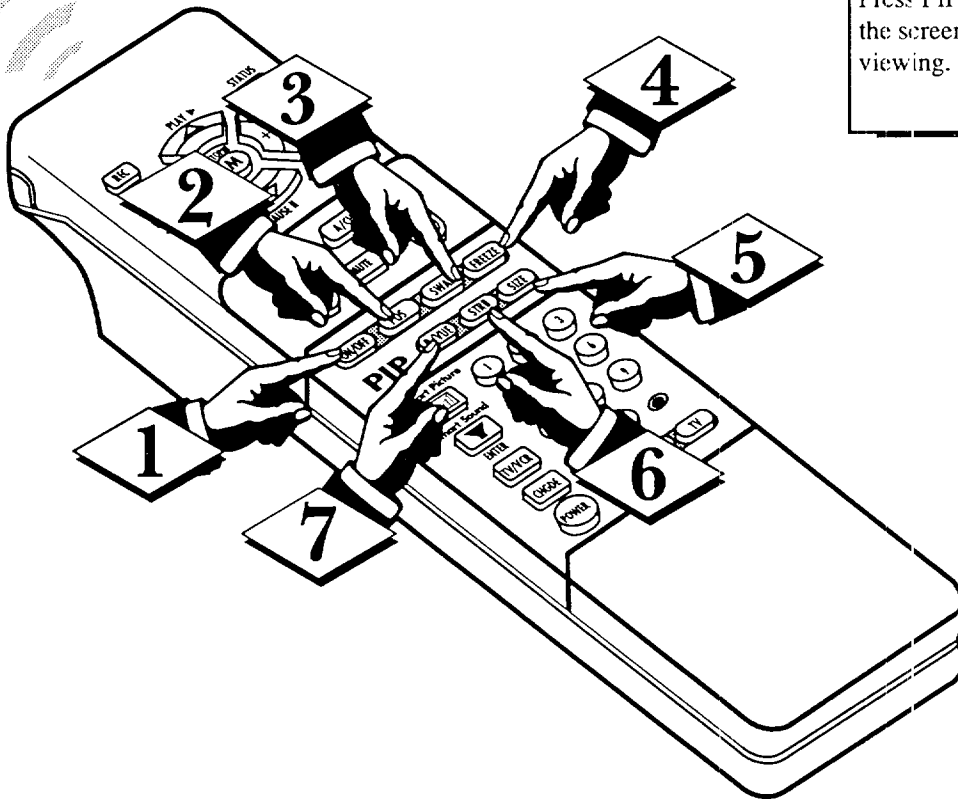

REMOTE WITH PIP (CONTINUED)

5 Press **SIZE** button to change the size of the PIP window shown on the TV screen.

Press the PIP SIZE button again to see and compare the large and small size PIP windows.

6 Press **STROBE** to see a series of three frozen scenes from the currently selected channel. Press **STRB** again and the series of pictures will be updated.

7 Press **PREVIEW** button to see what is showing on three channels. **P/VUE** starts with the current channel and shows the next two channels in memory.

Every few seconds each **P/VUE** picture will be updated with a current scene for that channel.

Press **P/VUE** again to go to the next three channels in memory and so on. Just press the number buttons to select any previewed channel.

Press **PIP ON/OFF** button to clear the screen and return to normal viewing.



SELECTING THE PICTURE SOURCE FOR PIP

PIP SOURCE

The picture for the PIP window can come through either the ANT/CABLE or VCR/AUX Inputs (on the rear of the TV). PIP Picture Source simply tells the TV which one of the input sources it is to show in the PIP window.

BEGIN

1 Select PIP SOURCE control.

With FEATURES MENU (3 of 3) on screen, move the RED highlight with the MENU (M) buttons. Then press the MENU button.

2 Press the MENU ▲▼ and MENU (M) buttons to highlight and select (✓) the desired input source (either ANTENNA, VCR/AUX 1, etc.).

ANTENNA- for a picture signal coming from the ANT/CABLE Input on the TV.

VCR/AUX1- for a picture signal coming from the VCR/AUX IN Video Input jack on the TV.

AUX 2- for a picture signal coming from the AUX 2 Video Input jack on the TV.

AUX 3- for a picture signal coming from the AUX 3 Video Input jack on the TV.

3 Press the STATUS button to clear the screen.

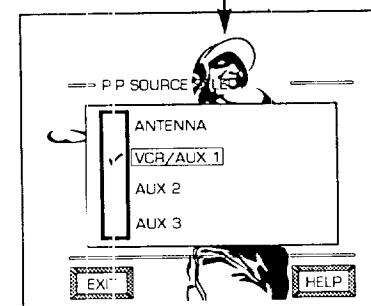
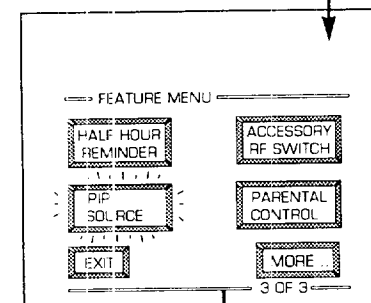
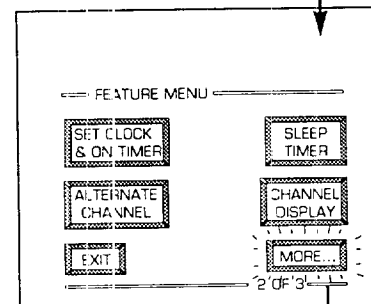
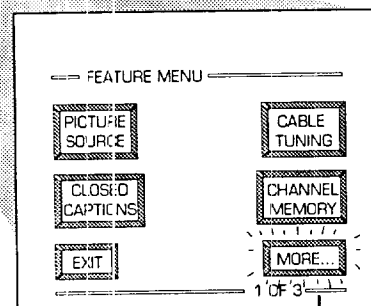
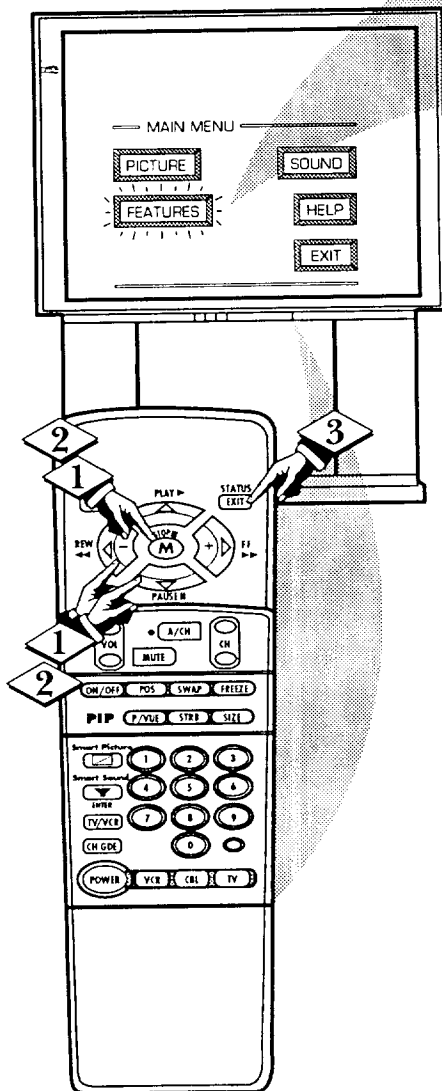

SMART HELP



Remember. The PIP screen will be blank unless a signal is connected to the selected source (for example: VCR/AUX 1 Input) on the rear of the TV.



PIP COLOR / PIP TINT

The Picture-In-Picture (PIP) Color and Tint controls are used to make fine tune adjustments to the color settings for PIP (when it is shown on the TV screen).

BEGIN

- 1 Select PIP COLOR (or PIP TINT) control.

With PICTURE MENU (2 of 2) on screen, move the RED highlight with the MENU (M) buttons. Then press the MENU button.

- 2 Press the MENU ▲▼ buttons to move the RED highlight. Press the MENU button to turn the PIP COLOR or TINT control ON.

The PIP automatically comes on to show the PIP window on the TV screen.

- 3 Press the (+) and (-) buttons to adjust the PIP for Color (or Tint) levels you prefer.

- 4 Press the STATUS button to clear the screen.



SMART HELP



Remember. Although there are separate COLOR and TINT controls for PIP, the adjustment levels for these controls depend on the TV's main picture. For example: If the main screen is showing a black and white picture, PIP would also be in black and white (even though its source is in color).

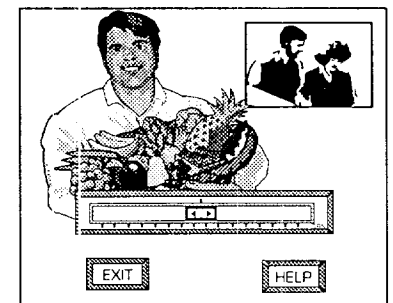
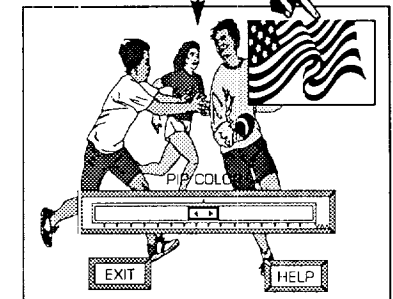
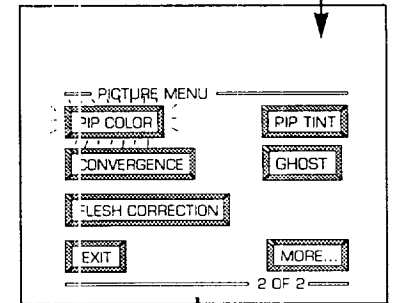
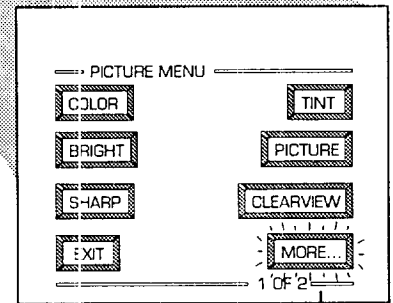
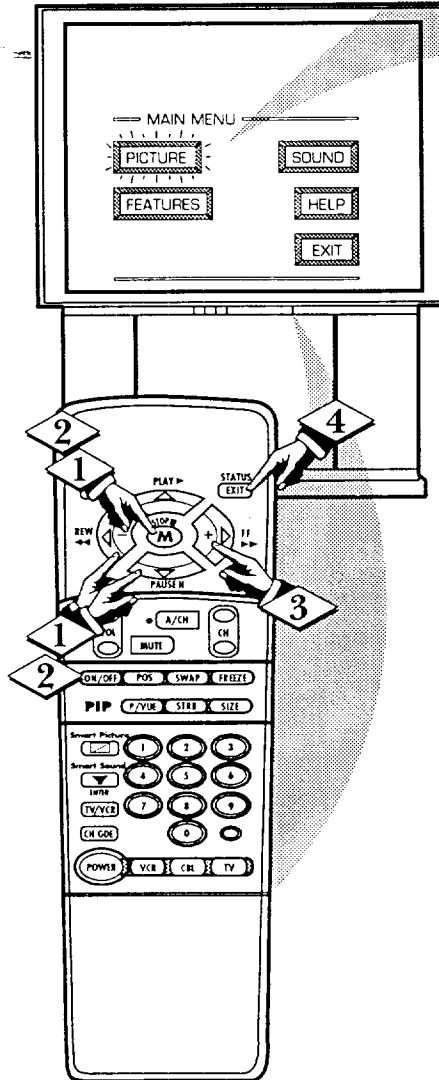

MORE PIP CONNECTIONS

PIP hookup with Cable Converter Box and VCR.

BEGIN

- 1 First use an optional signal splitter and connect the original cable TV signal to both the CABLE IN on the Cable Converter and the ANTENNA plug on the rear of the TV.
- 2 Connect the CABLE OUT on the Converter to the ANT. IN on the VCR.
- 3 Connect the VIDEO OUT jack on the VCR to the VIDEO IN jack on the TV.

Also connect the AUDIO OUT (R and L) jacks from the VCR to the AUDIO IN jacks on the TV.



SMART HELP



Remember to use the Cable TV Converter Box to select channels for PIP, the VCR must be set to the same channel as the channel selection switch on the rear of the Cable Converter (either channel 3 or 4).

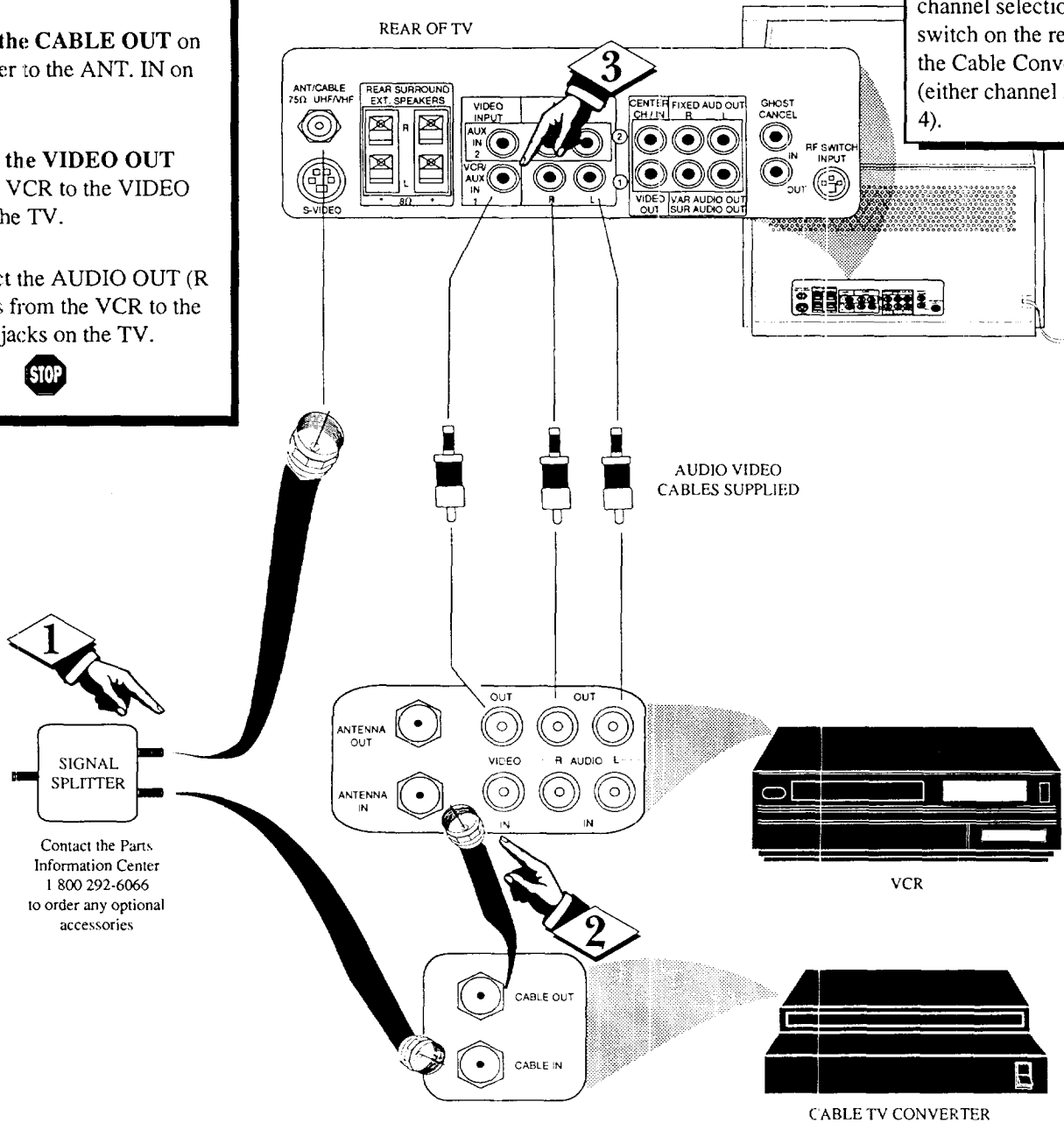

1



SIGNAL SPLITTER

Contact the Parts Information Center
1 800 292-6066
to order any optional accessories



The on screen **HELP** menu offers both **Operating Tips** and a list of **Glossary** definitions for different features on your TV. These items are given to provide you with more information and details on a select group of feature operations:-

BEGIN

- 1 Select "HELP" on the TV's Main Menu.
Press the remote's Menu  buttons to move UP/DOWN and from SIDE-TO-SIDE within the list of on-screen features.
Press MENU (M) to select the highlighted "HELP" item.
- 2 Press the MENU  and then the MENU (M) buttons to select either the OPERATING TIPS or GLOSSARY item.

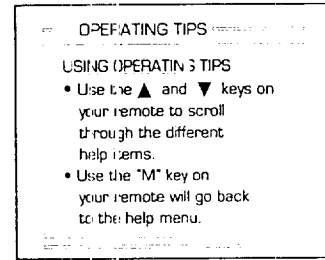
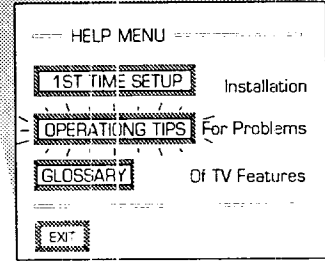
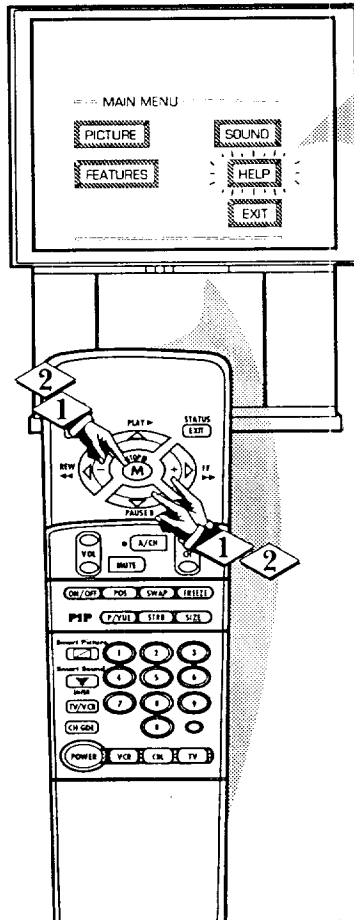

FOLLOW THE ON SCREEN DIRECTIONS TO VIEW OPERATING TIPS

RF SWITCHER INFORMATION

An optional RF Switcher is available that will allow an Antenna/Cable TV signal input and another video accessory (VCR, Video Disc Player, etc.) to be connected to the TV at the same time.

The accessory RF switcher can be purchased or ordered from your dealer. If your dealer does not carry the accessory, call the toll free Parts Information Center number:

1-800-292-6066

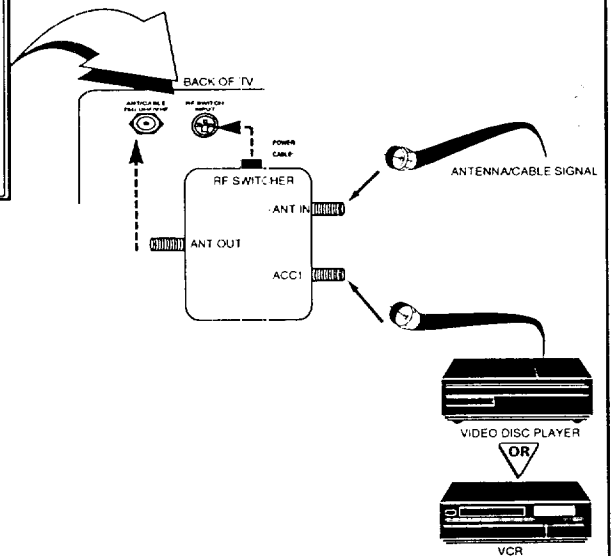
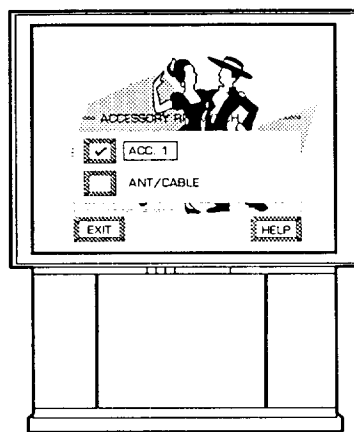



TIPS IF SOMETHING ISN'T WORKING

Please make these simple checks before calling for service. These tips can save you time and money since charges for TV installation and adjustment of customer controls are not covered under your warranty.

No Power

- Check the TV power cord. Unplug the TV, wait 1 minute, then reinsert plug into outlet and push POWER button again.
- Check to be sure outlet is not on a wall switch.

No Picture

- Check antenna connections on the rear of the TV. Are they properly secured to the antenna plug on the TV?
- Check the CABLE TUNING control for correct position.
- Check PICTURE SOURCE control for correct position VCR/AUX, AUX 2, or AUX 3 position without a signal source will result in a blank screen.
- Check the CLOSED CAPTIONS control. Some TEXT modes could block the screen.

No Sound

- Check the VOLUME and MUTE buttons on the TV and remote.
- Check the TV SPEAKER NORMAL/OFF control for the correct position.
- If attempting auxiliary equipment hook-ups, check audio jack connections and that the auxiliary equipment is on and in the proper operating modes.

Remote Does Not Work

- Check TV-VCR-CBL "System" buttons on the remote. Press the remote's TV System button to send commands to the TV; VCR System to sent to VCR; etc.
- Check batteries. Replace with AA Heavy Duty (Zinc Chloride) or Alkaline batteries if necessary.
- Clean the remote and the remote sensor window on the TV.

TV Displays Wrong Channel or No Channels Above 13

- Repeat channel selection.
- Add desired channel numbers (ADD/DELETE CHANNELS control) into TV memory.
- Check CABLE TUNING control for correct position.

QUESTIONS ABOUT THIS PRODUCT?
CALL OUR INFORMATION CENTER.

800-531-0039

This TV is equipped with protective circuitry that shuts the TV off in case of moderate power surges. Should this occur turn the TV back on by pressing the POWER button once or twice, or unplug and then replug the power cord at the AC outlet. This feature is NOT designed to prevent damage due to high power surges such as those caused by lightning, which is not covered by your warranty.

Cleaning and Care

- To avoid possible shock hazard be sure the TV is unplugged from the electrical outlet before cleaning.
- When cleaning the TV screen take care not to scratch or damage the screen surface (avoid wearing jewelry or using anything abrasive- do not use household cleaners). Wipe the front screen with a clean cloth dampened with water. Use even, easy, vertical strokes when cleaning.
- Specially designed screen cleaning kits are also available which contain anti-static cleaners and cloths designed to get into the ridges of the TV screen. If interested, ask your dealer about the MAG4600 Projection TV Screen Cleaning Kit or call our toll-free Accessory Parts ordering number 1-800-292-6066.
- Gently wipe the cabinet surfaces with a clean cloth or sponge dampened in a solution of cool clear water and a mild soap or detergent. Use a clean dry cloth to dry the wiped surfaces.
- Occasionally vacuum the ventilation holes or slots in the cabinet back.
- Never use thinners, insecticide sprays, or other chemicals on or near the cabinet, as they might cause permanent marring of the cabinet finish.



A/V Inputs * Connector plugs which allow the introduction of distinct audio and video signals into the TV from accessory VCRs, camcorders, etc. These plugs bypass the normal tuner or RF/Antenna signal circuitry.

Coaxial Cable * A single solid antenna wire normally matched with a metal plug (F-type) end connector that screws (or pushes) directly onto a 75 Ohm input found on the Television or VCR.

Display * An on screen message or graphics that help the user operate and adjust his Television feature controls. See On Screen Displays (OSD).

Direct Audio/Video Inputs * Located on the rear of the TV these connectors (RCA phono type plug) are used for the input of audio and video signals. Designed for use with VCRs (or other accessories) in order to receive higher picture resolution and offer sound connection options.

Identify * Method by which a remote control searches and finds an operating code for another product (such as a VCR or Cable Converter). Once the code has been "identified" then the TV remote can operate and send commands to the other product.

Multichannel Television Sound (MTS) * The broadcast standard that allows for stereo sound to be transmitted with the TV picture.

On Screen Displays (OSD) * Refers to the wording or messages generated by the television (or VCR) to help the user with specific feature controls (color adjustment, programming, etc.).

Menu * An on-screen listing of feature controls shown on the Television screen that are made available for user adjustments.

Picture -In-Picture (PIP) * Term used when two pictures are shown on the TV screen at the same time. The smaller PIP picture is supplied by a VCR (or other tuner/video playback source). The PIP picture can also be moved and swapped with the TV's main screen picture.

Pre-Amplifier * The control center of a hi-fi system. Not only amplifies source inputs, but also allows for source selection, volume, tone, balance and all other controls that affect the sound.

Programming * The procedure of adding or deleting channel numbers into the Television's memory circuits. In this way the Television "remembers" only the locally available or desired channel numbers and skips over any unwanted channel numbers.

Remote Sensor Window * A window or opening found on the Television control panel through which infrared remote control command signals are received.

Second Audio Program (SAP) * Another or additional audio channel provided for in the Multichannel Television Sound (MTS) broadcast standard. The most frequently proposed use for SAP is the simultaneous bilingual broadcast of TV program material.

Status * Allows the user to quickly confirm what channel number is currently being viewed. Status can also be used to clear the Television of on screen displays or information (rather than waiting for the displays to "time out" or automatically disappear from the screen).

S-Video Input * Allows direct connection of high-resolution video sources, such as a Super VHS videocassette recorder, Laser Disc player, etc. Provides optimum picture resolution, sharpness, and clarity.

Twin Lead Wire * The more commonly used name for the two strand 300 Ohm antenna wire used with many indoor and outdoor antenna systems. In many cases this type of antenna wire requires an additional adapter (or balun) in order to connect to the 75 Ohm Input terminals designed into the more recent Televisions and VCRs.

Variable Audio Output * An adjustable audio output which allows for volume variations at the source.



INDEX

Accessories/Optional	9, 24-25, 26-29, 42, 48, 49, *Q/U-1
Adapter Connector.....	42, 48, 49, *Q/U-1
Add/Delete Channels	13-14, *Q/U-2
Advance Buttons	*Q/U-2, 4
Audio Controls.....	20-22, 23-24, 34
Audio/Video Input	26-28, 42, 48 *Q/U-2
Automatic Programming	13, *Q/U-2
Alternate Channel	16
Battery Installation	*Q/U-3
Cable TV Connections/Settings	12, 42, 48 *Q/U-1, 2
Channel Guide	35
Channel/Time Display.....	15, 17, *Q/U-3
Channel Memory.....	13-14, *Q/U-2
Channel/Time Reminder.....	17
Clock Setting	15
Clock Timer.....	15
Closed Captioning	11
Color Controls	6, *Q/U-4
Convergence	8
Controls/TV.....	*Q/U-2, 3, 4
Controls/Remote	30-35, 36, 44-45 *Q/U-2, 3, 4
Exit	*Q/U-4
Features.....	5
First Time Set Up	*Q/U-2
Ghost Cancellation.....	9
Glossary/TV Terms	51
Help Menu.....	49, *Q/U-2, 4
Help Line Information.....	1, 50, *Q/U-1
Inputs/Audio and Video	26-28, 42, 48
Menu.....	*Q/U-2, 4
Minus(-)/Plus (+) Buttons.....	*Q/U-3, 4
Parental Control	18-19
Picture-In-Picture (PIP).....	42-48, *Q/U-2
Power Light Indicator.....	*Q/U-3
Precautions/Safety	2, 3, 50, 55, *Q/U-1
Programming Channels	13, *Q/U-2
Remote Control	30-35, 41, 44-45, *Q/U-2, 3, 4
Remote with VCRs.....	36-37, 40, 41
Requesting Service	50, 53-54, 55
RF Coaxial Cable	42, 48 *Q/U-1
RF Switcher	49
Reminder/Time and Channel.....	17
Remote Locator	30-31
Safety/Precautions	2, 3, 50, 55, *Q/U-1
Second Audio Program (SAP).....	21
Sensor Remote.....	*Q/U-3
Sleep Timer.....	16
Smart Picture	32-33
Smart Sound.....	34
Status Button	*Q/U-3, 4
Stereo Light Indicator.....	21, *Q/U-3
Surround Sound.....	24-25
Speaker Terminals	24
Time/Channel Display	17, *Q/U-3
Timer (Turn On)	15
VCR Button	26
VCR/TV Connections	26-29, 42, 48 *Q/U-1
Tips for Service	49, 50, 53-54, 55, 43
TV Speaker Control.....	23
Volume Display	22
Warranty	55

* Information contained in Quick-Use (Q/U) Guide - page listed

Philips Consumer Electronics Company Factory Service Center Locations

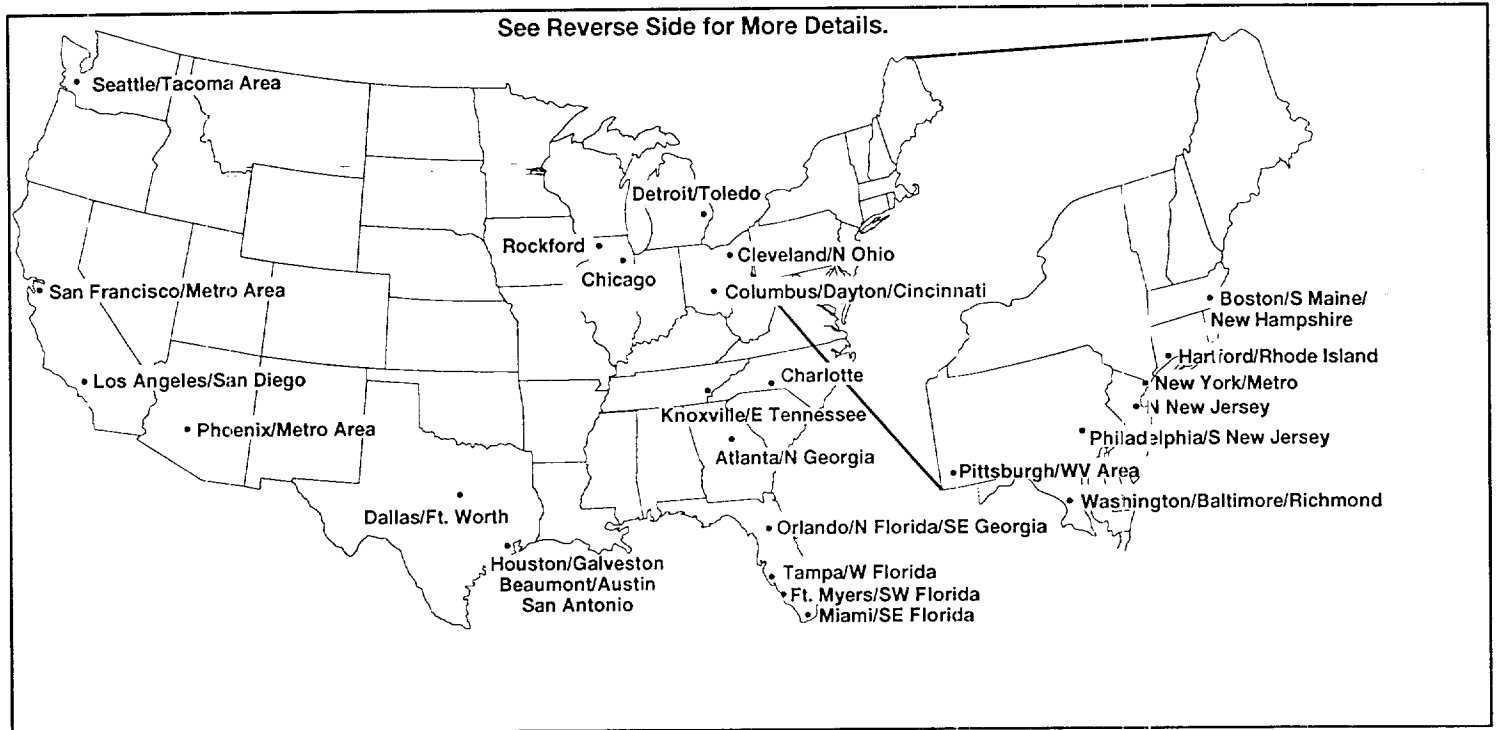

NOTE: If you reside in one of our Philips Factory Service Branch areas (see directory on back), you can contact the nearest Service Branch to obtain efficient and expedient repair for your product. If your product is In-Warranty, you should have proof-of-purchase to ensure No Charge Service. For Out-of-Warranty service, call the location nearest you.

NOTA: Si vous résidez dans une des régions desservies par une succursale de service après vente du fabricant Philips (voir liste ci-dessous), vous pourrez contacter la branche de service après vente la plus près de chez vous pour obtenir un service après vente rapide et efficace. Si le produit est sous garantie, il suffira de présenter une preuve d'achat pour bénéficier d'un service sans frais. Pour les produits non couverts par la garantie, contactez le centre le plus près de chez vous.

NOTA: Si Ud. reside en una de nuestras zonas para sucursales Philips de servicio al de fábrica (ver directorio más abajo), Ud. puede comunicarse con la sucursal de servicio más cercana para obtener una reparación oportuna y eficaz de su producto. Si su producto está todavía bajo garantía, Ud. debe presentar comprobante de compra para no ocasionar ningunos cargos por servicio. Para servicio después del vencimiento de la garantía, llame al lugar más cercano de los abajo indicados.

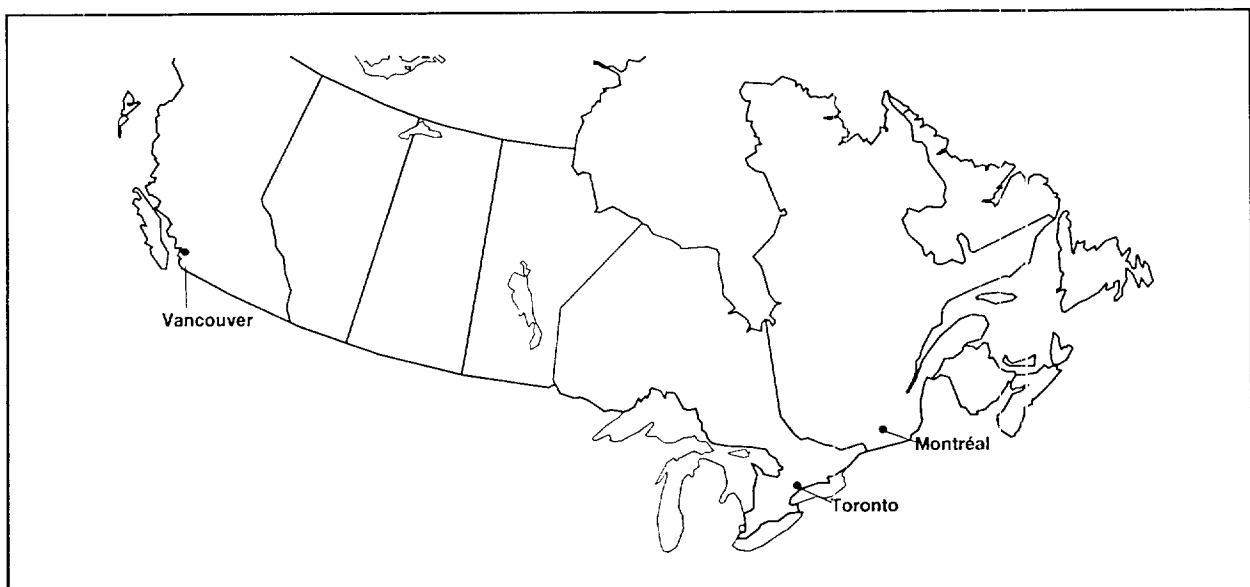

QUALITY SERVICE IS AS CLOSE AS YOUR TELEPHONE! SIMPLY LOOK OVER THE LIST BELOW FOR THE NUMBER OF A FACTORY SERVICE CENTER NEAR YOU. YOUR PRODUCT WILL RECEIVE EFFICIENT AND EXPEDIENT CARRY-IN, MAIL-IN, OR IN-HOME SERVICE, AND YOU WILL RECEIVE PEACE OF MIND, KNOWING YOUR PRODUCT IS BEING GIVEN THE EXPERT ATTENTION OF PHILIPS' FACTORY SERVICE. AND, IF THE PHONE NUMBER LISTED FOR YOUR AREA IS LONG DISTANCE, CALL 1-800-242-9225 FOR FACTORY SERVICE.

COMMENT OBTENIR NOTRE SERVICE APRÈS VENTE RAPIDE ET EFFICACE SOIT PAR COURRIER, À DOMICILE, OU EN SE PRÉSENTANT À UN CENTRE DE SERVICE PHILIPS. PLUS DE 600 CENTRES DE RÉCEPTION DE PRODUITS À RÉPARER À TRAVERS LE PAYS: CONTACTER LE CENTRE DE SERVICE AUX CONSOMMATEURS LE PLUS PROCHE POUR SAVOIR L'EMPLACEMENT DE CES DÉPÔTS DANS UN RAYON DE 50 À 75 MILES (80 KM À 120 KM) DU CENTRE DE SERVICE LOCAL.

CÓMO OBTENER UN SERVICIO OPORTUNO Y EFICIENTE POR CORREO, EN CASA O EN PERSONA PARA SU PRODUCTO A TRAVÉS DE UN CENTRO PHILIPS DE SERVICIO. MAS DE 600 SITIOS POR TODO EL PAIS PARA LA RECEPCION DE PRODUCTOS NECESITADOS DE REPARACIONES: COMUNICARSE CON EL CENTRO DE SERVICIO DE FABRICA MAS CERCAÑO PARA ESTOS LUGARES DENTRO DE UN RADIO DE 80 A 120 KM (50 A 75 MILLAS) DEL CENTRO DE SERVICIO LOCAL.

<p>Atlanta-Athens-- Macon-Chattanooga, TN-- North Georgia Area 1898 Leland Drive Marietta, GA 30067 (404) 952-3279</p> <p>Boston-Southern Maine-- Southern New Hampshire Area 1 North Avenue Burlington, MA 01803 (617) 272-4825</p> <p>Charlotte-Winston Salem-- Greensboro-Chapel Hill-- Raleigh-Spartanburg, SC Area 520-G Clanton Road Charlotte, NC 28217 (704) 529-6330</p> <p>Chicago-Gary Area 1360 W. Hamilton Parkway Itasca, IL 60143 (708) 775-0990</p> <p>Cleveland-Akron-- Youngstown Area 24090 Detroit Road Westlake, OH 44145 (216) 899-2040</p> <p>Columbus-Dayton-- Cincinnati Area 5164 Blazer Parkway Dublin, Ohio 43017 (614) 792-1495</p>	<p>Connecticut-Rhode Island-- Springfield, MA Area 1294 Blue Hills Avenue Bloomfield, CT 06002 (203) 726-9612</p> <p>Dallas-Ft. Worth Area 13375 Stemmons Freeway, Suite 200 Dallas, Texas 75234 (214) 243-4775</p> <p>Detroit/Toledo Area 25173 Dequindre Madison Heights, MI 48071 (810) 544-2110</p> <p>Knoxville-Greeneville-- Tri Cities-East Tennessee Area 6700 D. Papermill Road Papermill Plaza Knoxville, TN 37919 (423) 584-6614</p> <p>Ft. Myers-Naples-- Southwest Florida Area 11601 Cleveland Ave., Suite 15 Ft. Myers, FL 33907 (813) 278-4242</p> <p>Houston-Galveston-- Beaumont-Austin-- San Antonio Area 1110 North Post Oak Road Suite 100 Houston, TX 77055 (713) 682-3990</p>	<p>Los Angeles-San Diego Area 2910 E. LaPalma, Suite E Anaheim, CA 92806 (714) 238-7250</p> <p>Miami-Southeast Florida Area 2099 W. Atlantic Blvd. Pompano Beach, FL 33069 (305) 978-0467</p> <p>North NJ-Staten Island-- Rockland County, NY Area 140J Commerce Way Totowa, NJ 07512 (201) 890-7200</p> <p>New York Metro Area 116 Charlotte Avenue Hicksville, NY 11801 (516) 933-1780 Nassau County</p> <p>Orlando-Jacksonville--North Florida--Southeast Georgia Area 2452 Sand Lake Road Orlando, FL 32809 (407) 857-8998</p> <p>Philadelphia/S. New Jersey Area 352 Dunks Ferry Road Bensalem, PA 19020 (215) 638-7500</p> <p>Phoenix-Scottsdale-- Mesa-Tempe Area 5032 S. Ash Avenue, Ste. 101 Tempe, AZ 85282 (602) 897-7358</p>	<p>Pittsburgh, PA-Steubenville, OH-- Wheeling/Morgantown, WV Area 2891 Banksville Road Pittsburgh, PA 15216 (412) 563-8020</p> <p>Rockford-Kenosha-- Beloit-Madison Area 5602 N. Second Loves Park, IL 61111 (815) 654-7343</p> <p>San Francisco-Oakland-- San Jose Area 3370 Montgomery Drive Santa Clara, CA 95054 (408) 492-9013</p> <p>Seattle-Tacoma/Olympia Area 1055 Andover Park East Tukwila, WA 98188 (206) 575-6288</p> <p>Tampa-St. Petersburg-- Sarasota Area Center Point Business Park, Building B-1, Suite 100 1911 U.S. Hwy. 301 North Tampa, FL 33619 (813) 621-8181</p> <p>Washington, DC-Baltimore-- Richmond, VA Area 6671-J Santa Barbara Road Elkridge, MD 21227 (410) 796-0105</p>
--	--	---	--

HOW YOU CAN OBTAIN EFFICIENT AND EXPEDIENT CARRY-IN, MAIL-IN, OR IN-HOME SERVICE IN CANADA FOR YOUR PRODUCT THROUGH A PHILIPS CONSUMER SERVICE CENTER

COMMENT OBTENIR NOTRE SERVICE APRÈS VENTE RAPIDE ET EFFICACE SOIT PAR COURRIER, À DOMICILE, OU EN SE PRÉSENTANT À UN CENTRE DE SERVICE PHILIPS

CÓMO OBTENER UN SERVICIO OPORTUNO Y EFICIENTE POR CORREO, EN CASA O EN PERSONA EN EL CANADA PARA SU PRODUCTO A TRAVÉS DE UN CENTRO PHILIPS DE SERVICIO AL CONSUMIDOR

<p>TORONTO 601 Milner Avenue Scarborough, Ontario M1B 1M8 (416) 754-6064 (Tel.) (416) 292-5161 (Tel.) (416) 754-6290 (Fax)</p>	<p>MONTRÉAL 4977 Levy Street St. Laurent, Québec H4R 2N9 (514) 956-0120 (Tel.) (514) 956-0828 (Fax)</p>	<p>VANCOUVER 1741 Boundary Road Vancouver, B.C. V5M 3Y7 (604) 294-3441 (Tel.) (604) 294-3574 (Fax)</p>
---	--	---

LIMITED WARRANTY

PROJECTION TELEVISION

One Year Free Labor

One Year Free Service on Parts

Two Years Free Service on Cathode Ray Tube Parts / 30 Days Free Service on Projection Tv Screen

This product can be repaired in-home.

WHO IS COVERED?

You must have proof of purchase to receive warranty service. A sales receipt or other document showing that you purchased the product is considered proof of purchase.

WHAT IS COVERED?

Warranty coverage begins the day you buy your product. *For one year thereafter (30 days for the projection TV screen), all parts will be repaired or replaced, and labor and transportation are free. From one to two years from the day of purchase, you pay for the replacement or repair of all parts except the cathode ray tube and the "Clear-Vu" lens, and for all labor and transportation charges. After two years from the day of purchase, you pay for the replacement or repair of all parts except the "Clear Vu" lens (which is guaranteed against manufacturer's defects for the lifetime of the product), and for all labor and transportation charges.*

All parts, including repaired and replaced parts, are covered only for the original warranty period. When the warranty on the product expires, the warranty on all replaced and repaired parts also expires.

WHAT IS EXCLUDED?

Your warranty does not cover:

- labor charges for installation or setup of the product, adjustment of customer controls on the product, and installation or repair of antenna systems outside of the product.
- product repair and/or part replacement because of misuse, accident, unauthorized repair or other cause not within the control of Philips Consumer Electronics Company.
- reception problems caused by signal conditions or cable or antenna systems outside the unit.
- a product that requires modification or adaptation to enable it to operate in any country other than the country for which it was designed, manufactured, approved and/or authorized, or repair of products damaged by these modifications.
- incidental or consequential damages resulting from the product. (Some states do not allow the exclusion of incidental or consequential damages, so the above exclusion may not apply to you. This includes, but is not limited to, prerecorded material, whether copyrighted or not copyrighted.)

WHERE IS SERVICE AVAILABLE?

Warranty service is available in all countries where the product is officially distributed by Philips Consumer Electronics Company. In countries where Philips Consumer Electronics Company does not distribute the product, the local Philips service organization will attempt to provide service (although there may be a delay if the appropriate spare parts and technical manual(s) are not readily available).

MAKE SURE YOU KEEP...

Please keep your sales receipt or other document showing proof of purchase. Attach it to this owner's manual and keep both nearby. Also keep the original box and packing material in case you need to return your product.

BEFORE REQUESTING SERVICE...

Please check your owner's manual before requesting service. Adjustments of the controls discussed there may save you a service call.

TO GET WARRANTY SERVICE...

Repair must be performed by an authorized service center or a factory service center. *If you live near a factory service center (see enclosed list), you may contact that center to schedule a time for in-home repair. If you do not live near a factory service center, contact your dealer. If your dealer is an authorized service center, he will arrange repair. If your dealer is not an authorized service center, he will direct you to the authorized service center engaged by him to service the products he sells.*

(In U.S.A., Puerto Rico and U.S. Virgin Islands, all implied warranties, including implied warranties of merchantability and fitness for a particular purpose, are limited in duration to the duration of this express warranty. But, because some states do not allow limitations on how long an implied warranty may last, this limitation may not apply to you.)

(In Canada, this warranty is given in lieu of all other warranties. No other warranties are expressed or implied, including any implied warranties of merchantability or fitness for a particular purpose. Philips is not liable under any circumstances for any direct, indirect, special, incidental or consequential damages, howsoever incurred, even if notified of the possibility of such damages.)

IF YOU HAVE QUESTIONS...

In U.S.A., Puerto Rico, or the U.S. Virgin Islands, contact Philips Service Company at the address listed below.

In Canada, contact Philips Electronics Ltd. at:

4977 Levy Street
St. Laurent, Québec, H4R 2N9
(514) 956-0210

REMEMBER...

Please record the model and serial numbers found on the product below. Also, please fill out and mail your warranty registration card promptly. It will be easier for us to notify you if necessary.

MODEL # _____
SERIAL # _____

This warranty gives you specific legal rights. You may have other rights which vary from state to state.

Philips Service Company

401 East Andrew Johnson Highway
(423) 475-8869

Jefferson City, Tennessee 37760

EL4945E001 / MAC 4102 / 12-94

Optional Accessories

Prices subject to change without notice. Availability subject to change at time of purchase. When ordering accessories outside the U.S.A., please refer to the accessories material, address, and prices for that country.

Maximize your viewing pleasure with state-of-the-art accessories designed specifically for your

Projection Television. The

optional accessories shown in

this booklet may be purchased

from your local dealer, or may

be ordered direct from Phillips

Consumer Electronics

Company.

Call toll-free

1-800-292-6066

Or write

Phillips Consumer

Electronics Co.,

Accessories Marketing Dept.,

P.O. Box 967,

Greeneville, TN 37744-0967

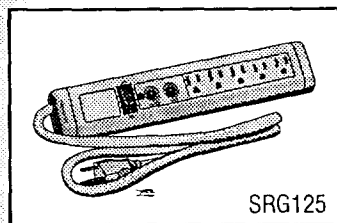

SRG125

TV/Cable Surge Protector

Your Cost \$19.95

Electrical fluctuations and power surges can damage your valuable electronic entertainment equipment. Protect your antenna, cable, and electrical lines with Magnavox Audio/Video Equipment Surge Protectors.

Features:

- Coaxial cable input/output
- Five grounded outlets
- Built-in LED and reset button

Screen Enhancer Cleaning Kit

4835 395 17265

Order the Screen Enhancer Cleaning Kit to maintain the quality and performance of your screen enhancer.

Your Cost \$17.90

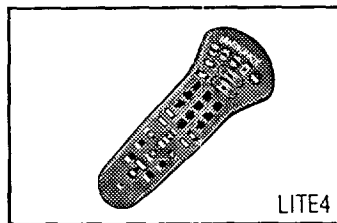

LITE4

Universal Night Lite™ Audio/Video Remote

Your Cost \$24.95

Replace your lost or broken remote control, or consolidate all your remotes into one. Plus, make remote easier to use in dimly-lit areas, with our Night Lite™ lighted keypad.

Features:

- Preprogrammed
- Autoscan and manual code setup
- On-screen capabilities
- Menu programming
- Spanish instructions included
- Toll-free customer assistance number included

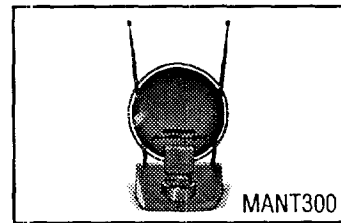

MANT300

Smart Amplifier Amplified VHF/UHF/FM Indoor Antenna

Your Cost \$34.95

Drastically improves VHF/UHF/FM reception on your TV or stereo. Simply attach antenna to your TV/stereo and enjoy crisper, clearer sound and improved picture quality. Adjustable UHF loop tilts and rotates for the best possible reception.

Features:

- 39" retractable dipoles
- 6' 75 ohm coax connection cable
- Matching transformer included
- Soft base prevents scratching surfaces
- Active antenna with amplifier with up to 20 dB gain
- LED power indicator on front of antenna: easy to see while watching TV
- Knob on top of antenna serves as gain and power switch
- AC/DC power adapter included
- 90-day warranty