

**Contents**

**Preface**

This section tells you about special features, safety information, and preparatory information for using this manual.

**Chapter 1: Setting Up**

This section shows you the steps necessary for installing and presetting for TV, and how to connect optional video and audio equipment.

**Chapter 2: Using Basic Features**

This section gives you basic information about operating and adjusting your TV.

**Chapter 3: Using Advanced Features**

This section shows you how to use Picture-in-Picture, pre-programmed Remote Commander and other useful features.

**Appendix**

This section gives you specifications and troubleshooting information.

- For a detailed table of contents, see page 3.

*Trinitron® Color TV*

*Operating Instructions*

Before operating your TV, please read this manual thoroughly and retain it for future reference.

- |           |           |
|-----------|-----------|
| KV-27TS29 | KV-27TW77 |
| KV-27TS32 | KV-27TW78 |
| KV-27TS36 | KV-32TW77 |
| KV-32TS36 | KV-32TW78 |
| KV-32TS46 | KV-2975M  |
| KV-2970M  |           |

**Owner's Record**

The model and serial numbers are located at the rear of the TV. Record these numbers in the spaces provided below. Refer to them whenever you call upon your Sony dealer regarding this product.

Model No. \_\_\_\_\_ Serial No. \_\_\_\_\_

# WARNING

To prevent fire or shock hazard, do not expose the unit to rain or moisture.

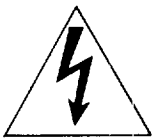
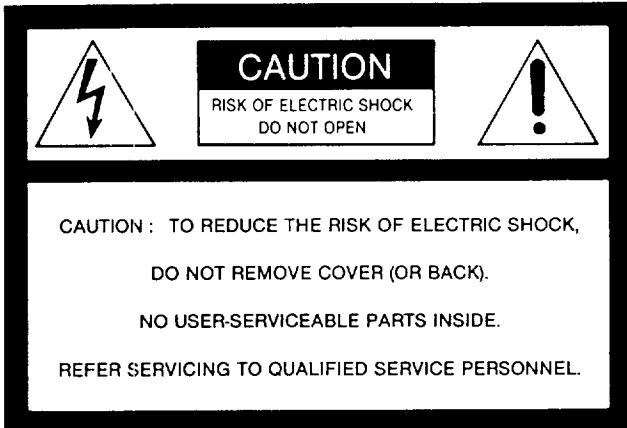

This symbol is intended to alert the user to the presence of uninsulated "dangerous voltage" within the product's enclosure that may be of sufficient magnitude to constitute a risk of electric shock to persons.



This symbol is intended to alert the user to the presence of important operating and maintenance (servicing) instructions in the literature accompanying the appliance.

## CAUTION:

TO PREVENT ELECTRIC SHOCK. DO NOT USE THIS POLARIZED AC PLUG WITH AN EXTENSION CORD. RECEPTACLE OR OTHER OUTLET UNLESS THE BLADES CAN BE FULLY INSERTED TO PREVENT BLADE EXPOSURE.

## Note to CATV system installer

This reminder is provided to call the CATV system installer's attention to Article 820-40 of the NEC that provides guidelines for proper grounding and, in particular, specifies that the cable ground shall be connected to the grounding system of the building, as close to the point of cable entry as practical.

Use of this television receiver for other than private viewing of programs broadcast on UHF or VHF or transmitted by cable companies for the use of the general public may require authorization from the broadcaster/cable company and/or program owner.

# Precautions

## Safety

- Operate the TV only on 120 V AC.
- One blade of the plug is wider than the other for safety purposes and will fit into the power outlet only one way. If you are unable to insert the plug fully into the outlet, contact your dealer.
- Should any liquid or solid object fall into the cabinet, unplug the TV and have it checked by qualified personnel before operating it any further.
- Unplug the TV from the wall outlet if you are not going to use it for several days or more. To disconnect the cord, pull it out by the plug. Never pull the cord itself.

## Installing

- To prevent internal heat build-up, do not block the ventilation openings.
- Do not install the TV in a hot or humid place, nor in a place subject to excessive dust or mechanical vibration.

## Cleaning

Clean the TV with a soft dry cloth. Never use strong solvents such as thinner or benzine which might damage the finish of the cabinet.

## Repacking

Keep the original carton and packing materials to use for safe transport of your TV in the future.

If you have any questions or problems concerning your TV, please contact your nearest Sony dealer.

For details concerning safety precautions, see the supplied leaflet "IMPORTANT SAFEGUARDS."

## CAUTION:

When using TV games, computers, and similar products with your TV, keep the brightness and contrast functions at low settings. If a fixed (non-moving) pattern is left on the screen for long periods of time at a high brightness or contrast setting, the image can be permanently imprinted onto the screen. These types of imprints are not covered by your warranty because they are the result of misuse.

This television receiver provides display of television closed captioning in accordance with § 15.119 of the FCC rules.

# Table of Contents

<b>Preface</b>	
Warning/Precautions .....	2
Introducing the Sony Trinitron® Color TV .....	4
Identifying your TV .....	4
Locating the Controls .....	6
<b>Chapter 1: Setting Up</b>	
Connecting TV Antenna/Cable .....	12
Using the On-Screen Menus .....	14
Changing the menu language .....	16
Turning the Cable Mode On or Off .....	17
Presetting TV Channels .....	18
Connecting Other Equipment .....	22
Video equipment .....	22
Audio system .....	26
Watching a video with your S video-equipped VCR .....	28
<b>Chapter 2: Using Basic Features</b>	
Watching TV Programs .....	29
Using Convenient Features .....	30
Muting the sound – MUTING .....	30
Keeping the displays on-screen	
– DISPLAY .....	30
Setting the sleep timer – SLEEP .....	30
Switching quickly between	
two channels – JUMP .....	30
Using Closed Caption .....	31
Adjusting Picture and Sound Quality .....	32
Adjusting the picture .....	32
Adjusting the sound .....	34
<b>Chapter 3: Using Advanced Features</b>	
Watching Two Pictures at Once	
(Picture-in-Picture) .....	38
Using the Timer-Activated Functions .....	44
Setting the clock – CURRENT TIME SET .....	44
Setting the ON/OFF TIMER .....	46
Setting CHANNEL BLOCK .....	48
Customizing the Screen Display .....	50
Setting channel captions – CH CAPTION .....	50
Viewing the captioned channels – CH GUIDE .....	52
Setting VIDEO LABEL .....	53
Using the Pre-Programmed	
Remote Commander .....	55
<b>Appendix</b>	
Specifications .....	58
Troubleshooting .....	59

# Introducing the Sony Trinitron® Color TV

## About the manual

This manual covers 11 different models. The menu displays are based on model KV-32TS36, one of the models with the most functions, and the Remote Commander illustrations are based on RM-Y118. If a particular function

does not apply to your model, this will be noted in the manual.

We highly recommend that you read this manual before using your TV. Keep the manual handy for future reference.

## Feature

With the following features, you can:

- Receive up to 125 cable channels for a total of 181 possible off-air cable channels with the **multi-band VHF/UHF/CATV tuner**.
- Receive the picture and sound of your VCR through the **VIDEO IN jacks**.
- Receive superior VCR playback pictures when you connect a VCR equipped with an S video output jack to the **S VIDEO IN jack**.
- Watch your portable camera images (8mm, video, etc.) by connecting to the **VIDEO IN jacks** on the front panel.
- Receive stereo programs and Second Audio Program (SAP) broadcasts with the built-in **Multichannel TV Sound (MTS) decoder**.
- Receive TV or video sound through an audio system by connecting to the **VARIABLE/FIX AUDIO OUT jacks**.
- Simulate the sound quality of a concert hall or movie theater with the **SURROUND system**.
- Watch another TV channel, video or cable image as a window picture by using **Picture-in-Picture**.

- Automatically preset all receivable channels with **AUTO PROGRAM**.
- Watch the closed caption and the text by using **Closed Caption**.

With the supplied Remote Commander, you can:

- Operate the TV, plus Sony and most other maker's video equipment or Sony multi disc player with the **Pre-Programmed feature**.
- Switch quickly between two channels by using **JUMP**.
- Set the TV to automatically shut off after desired time (30, 60, 90 minutes can be set) using the **SLEEP timer**.
- Set the internal clock to display the **CURRENT TIME** on-screen.

And enjoy other features giving you a high quality picture...

- **Colorpure Filter™** produces fine picture detail without color spill or color noise.
- The **New Dynamic Picture™ system** adjusts picture contrast automatically to produce more detail in both bright and dark areas of every scene.

## Identifying your TV

Check the model number of your set.

There are slight differences among 11 models covered by this manual.

Table of models  
YES: equipped  
NO: not equipped

Check the table below to see what your TV is equipped with before you start operating it.

	KV-27TS29 KV-2970M	KV-27TS32	KV-27TS35 KV-27TW78 KV-32TS46	KV-32TS36 KV-32TW77 KV-2975M	KV-27TW77 KV-32TW78
Picture-in-Picture feature	NO	NO		YES	
Pre-Programmed feature	NO	YES		YES	
SURROUND system	YES	YES		YES	
Front panel A/V jacks	NO	YES		YES	
S VIDEO IN jacks	NO	YES		YES	
Remote Commander	RM-Y116	RM-Y117		RM-Y118	

	KV-27TS29 KV-32TS36	KV-27TS35 KV-32TS46	KV-27TS32	KV-27TW77 KV-32TW78	KV-27TW78 KV-32TW77	KV-2970M KV-2975M
Model destination	U.S.A./Canada		U.S.A./Canada	U.S.A.		Central South America and other area
Closed caption	YES*		YES	YES		NO
Dual language	NO		YES	NO		YES

\*U.S.A. models only

## Design

KV-27TS29 KV-32TS36  
 KV-27TS32 KV-32TS46  
 KV-27TS36 KV-2975M  
 KV-2970M

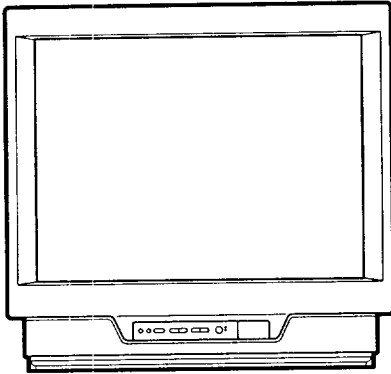

KV-27TW77 (Natural wood finish)  
 KV-27TW78 (Black)  
 KV-32TW77 (Natural wood finish)  
 KV-32TW78 (Black)

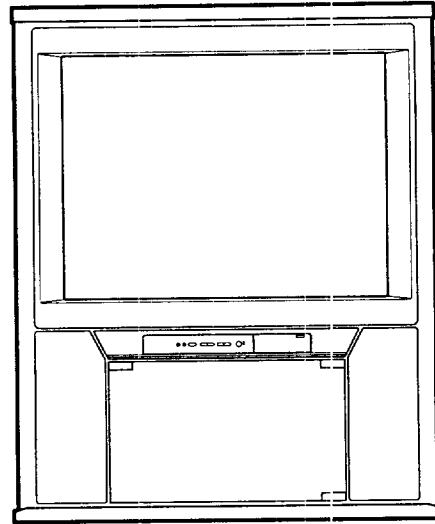

## Supplied Remote Commander

RM-Y118

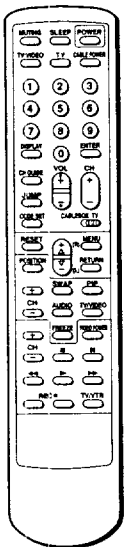

RM-Y117

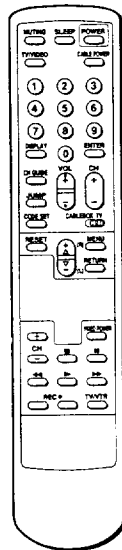

RM-Y116

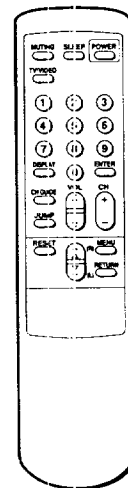

# Locating the Controls

## Screen Displays

For details, see the pages indicated by the numbered black circles ●.

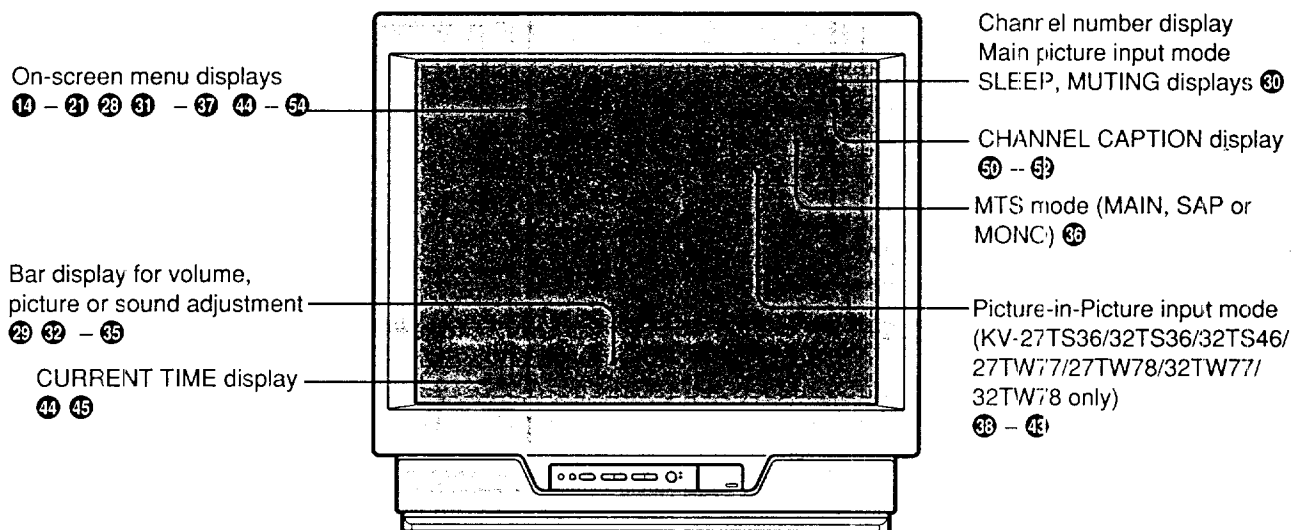

### KV-32TS36

(The screen displays, except for certain features as noted above, are the same for all models.)



# Front Panel

KV-27TS29  
KV-2970M

KV-27TS32 KV-27TS36  
KV-32TS36 KV-32TS46  
KV-2975M

KV-27TW77 KV-32TW77  
KV-27TW78 KV-32TW78

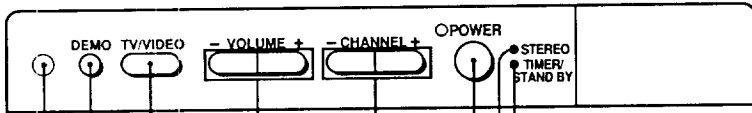
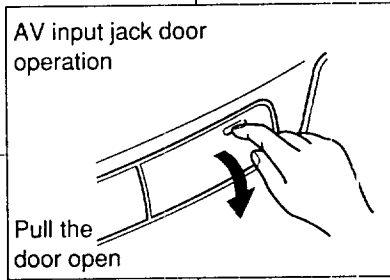
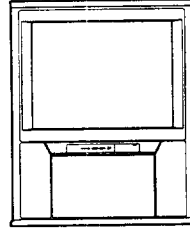
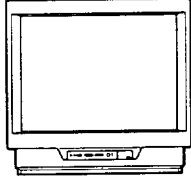
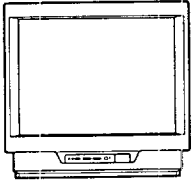

DEMO TV/VIDEO - VOLUME + - CHANNEL + OPOWER STEREO  
 TIMER/STAND BY  
 TIMER/STAND BY indicator  
 STEREO indicator  
 POWER button\*  
 CHANNEL +/- buttons\*  
 VOLUME +/- buttons\*  
 TV/VIDEO button\*  
 DEMO button\*\*  
 Remote control detector

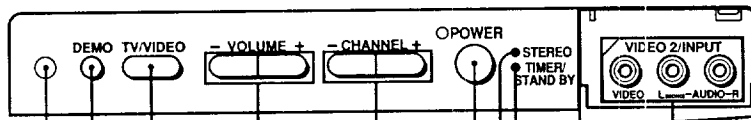

DEMO TV/VIDEO - VOLUME + - CHANNEL + OPOWER STEREO  
 TIMER/STAND BY VIDEO 2/INPUT  
 VIDEO L-AUDIO-R  
 VIDEO 2/INPUT jacks  
 TIMER/STAND BY indicator  
 STEREO indicator  
 POWER button\*  
 CHANNEL +/- buttons\*  
 VOLUME +/- buttons\*  
 TV/VIDEO button\*  
 DEMO button\*\*  
 Remote control detector

Locating the Controls

\* Buttons with the same function are also located on the Remote Commander (pp. 10 – 11).

\*\* If you press this button, functions and menus are displayed one by one. Press any button to stop DEMO.

# Locating the Controls

## Rear Panel

**KV-27TS29 KV-2970M**

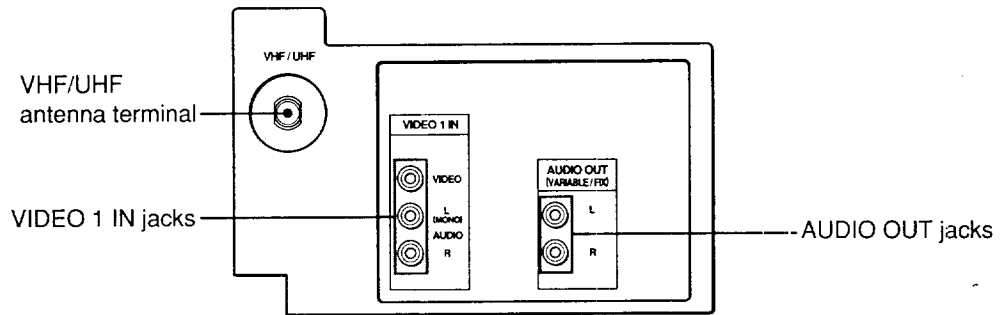

**KV-27TS36 KV-32TS36 KV-27TW77  
KV-27TW78 KV-32TW77 KV-32TW78  
KV-2975M**

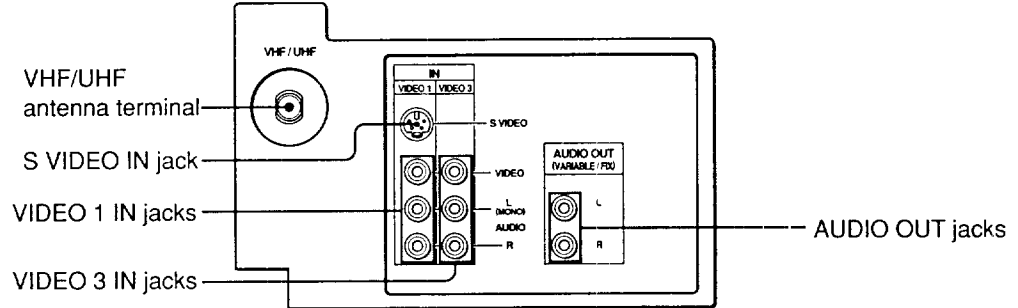

**KV-27TS32**

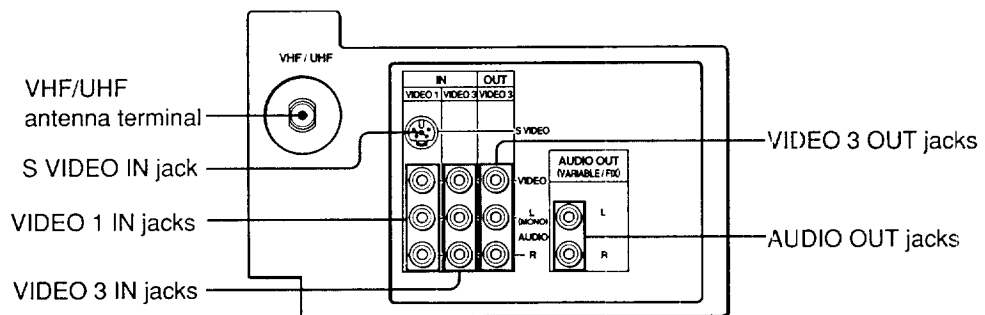

**KV-32TS46**

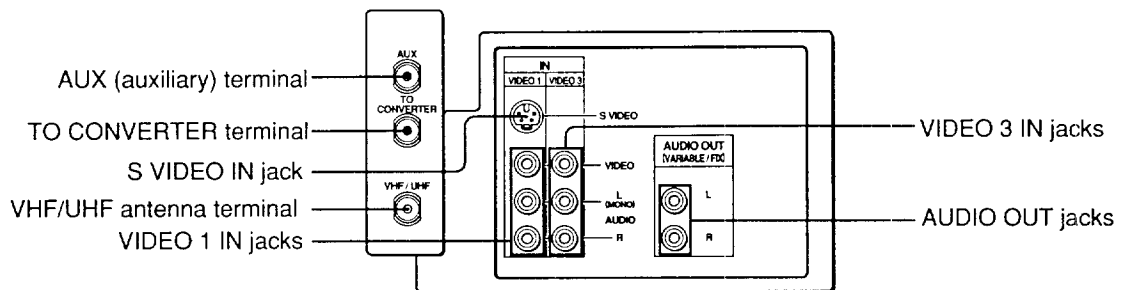





# Installing the Glass Door and VCR Shelf (KV-27TW77/27TW78/32TW77/32TW78 only)

Locating the Controls

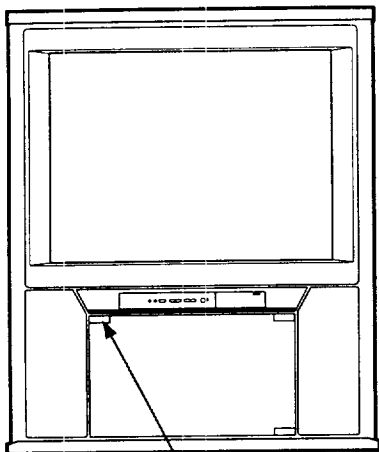

Push here to close.  
To open, push again.

Parts list			
①	Bottom Hinge		1
②	Top Hinge		1
③	Screw 4 x 4		4
④	Metal pin		4
⑤	Plate pad		1
⑥	Push plate		1

**1** Check that the projection of the screw through the hinge allows for proper installation of the hinge to the glass, then insert the bottom hinge ① into the bushing located on the cabinet bottom.

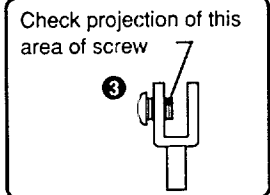
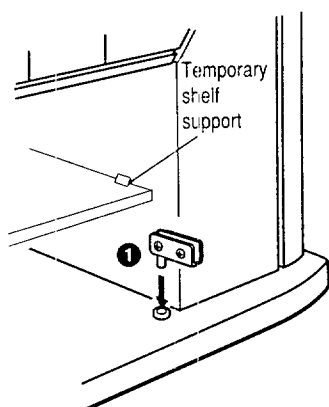

**2** Press the upper part of the temporary shelf supports while pulling shelf in opposite direction and detach the shelf, insert the metal pin shelf supports ④ and, aligning the grooves with the supports, insert the shelf.

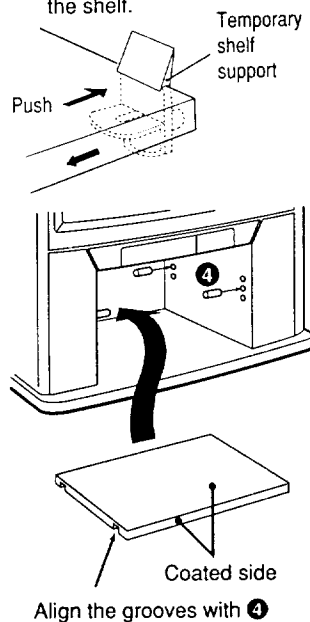

**3** Attach the top hinge ② to one end of the glass door, and tighten the screws. Attach plate pad ⑤ to the other end then push plate ⑥ over the plate pad.

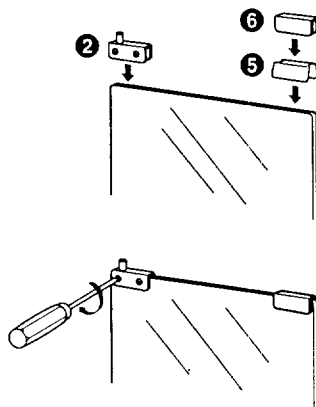

**4** Pushing the glass door hinge up into the hole located on the cabinet ceiling, slide the door into the bottom hinge, then tighten the screws.

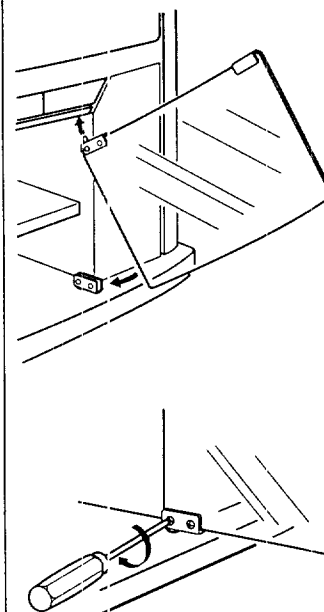

# Locating the Controls

## Remote Commander

For details, see the pages indicated by the numbered black circles ●.

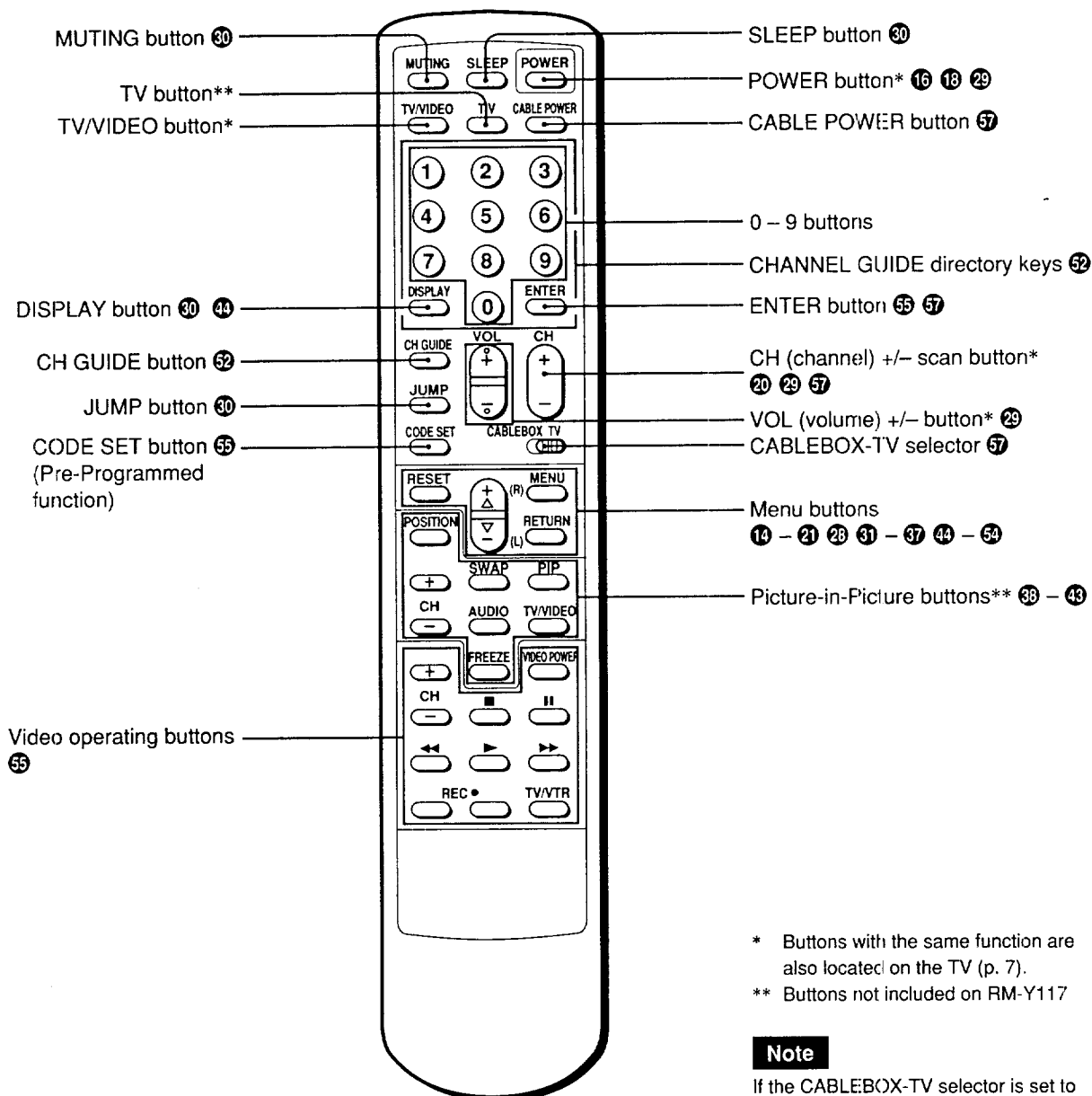

**RM-Y118:** KV-27TS36 KV-32TS36  
 KV-32TS46 KV-27TW77  
 KV-27TW78 KV-32TW77  
 KV-32TW78 KV-2975M  
**(RM-Y117:** KV-27TS32)

\* Buttons with the same function are also located on the TV (p. 7).  
 \*\* Buttons not included on RM-Y117

**Note**  
 If the CABLEBOX-TV selector is set to CABLEBOX, the Remote Commander is able to control a connected cable box, not the TV. Set the selector to TV to control the TV set with the Remote Commander (You can use POWER button at any case).

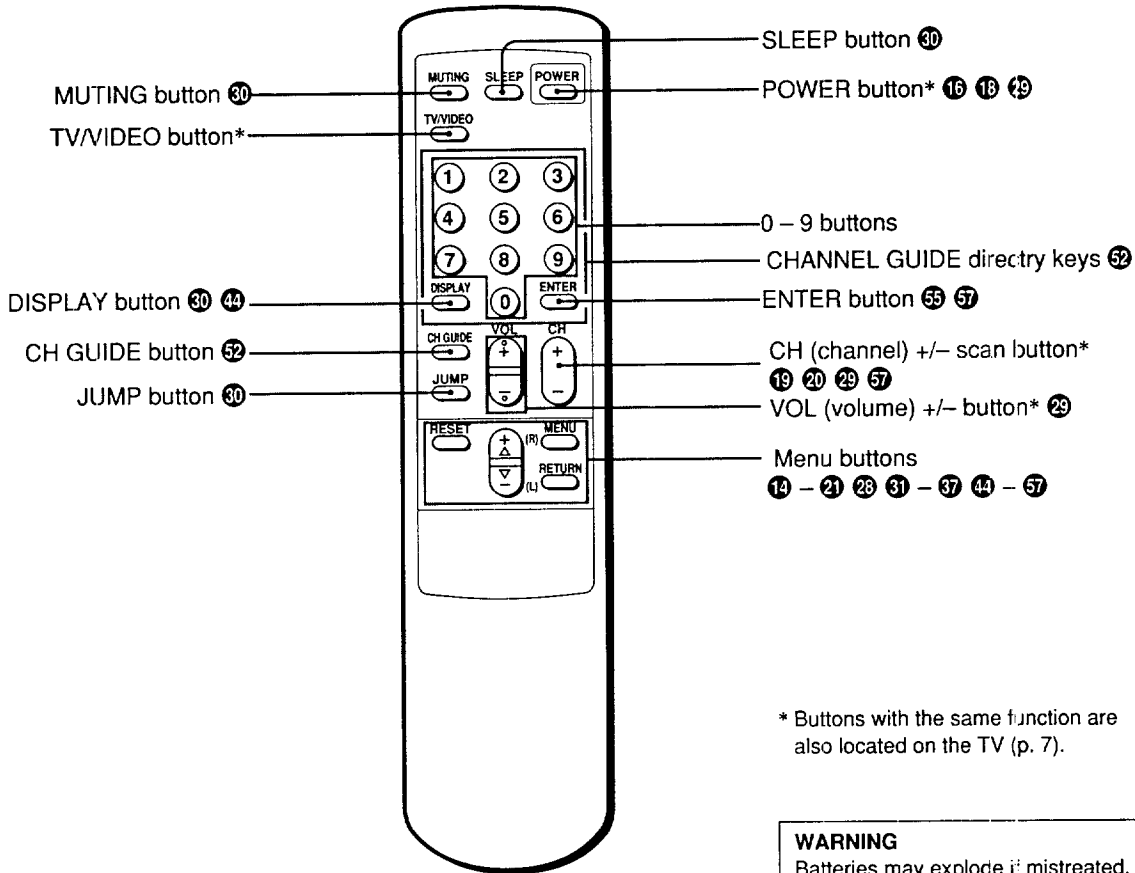

RM-Y116: KV-27TS29  
KV-2970M

\* Buttons with the same function are also located on the TV (p. 7).

**WARNING**

Batteries may explode if mistreated. Do not recharge, disassemble, or dispose of in fire.

**Installing Batteries**

(RM-Y116)

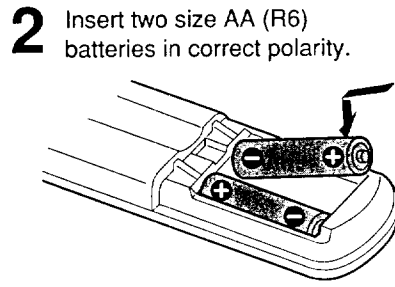
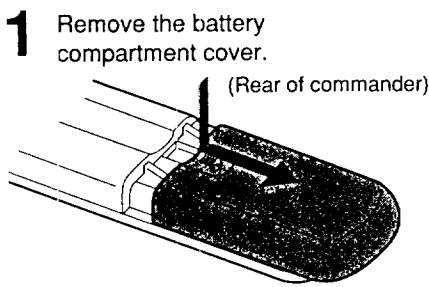

**Battery life**

With normal operation, batteries will last up to half a year. If the Remote Commander does not operate properly, the batteries might be exhausted. Replace both of them with new ones.

**To avoid damage from possible battery leakage**

Remove the batteries if you do not plan to use the Remote Commander for a fairly long time.

(RM-Y117, RM-Y118)

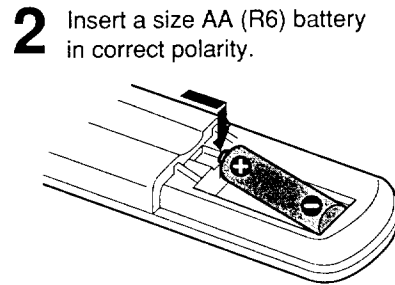
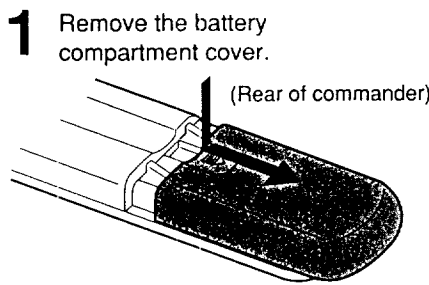

# Chapter 1: Setting Up

## Connecting TV Antenna/Cable

Although you can use either an indoor or outdoor antenna with the TV, an outdoor antenna will provide you with better picture quality. You can receive cable TV by connecting a cable supplied by your local cable company.

### Connecting VHF, UHF or VHF/UHF Combination Antenna\*, or CATV Cable

#### 75-ohm coaxial cable (round)

- 1 Check your antenna cable type and prepare the end of the cable using the F-type connector.

Attach an F-type connector (not supplied).

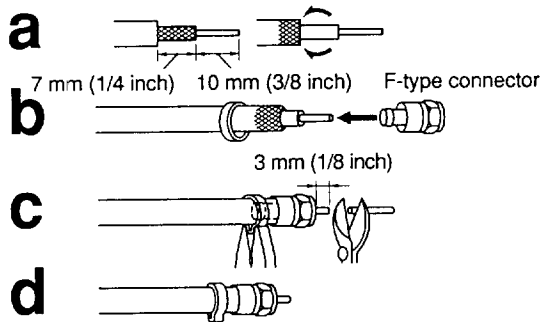

- 2 Plug the connector into the VHF/UHF terminal at the rear of the TV.

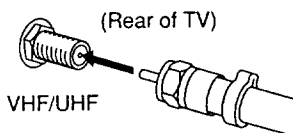

\* Most combination antennas are equipped with a signal splitter. Remove the splitter and attach the appropriate connector.

#### 300-ohm twin-lead cable (flat)

- 1 Check your antenna cable type and prepare the end of the cable using the 300-ohm twin-lead cable.

Attach an antenna connector (not supplied).

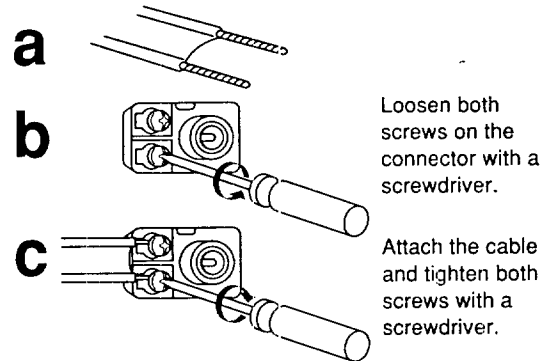

- 2 Plug the connector into the VHF/UHF terminal at the rear of the TV.

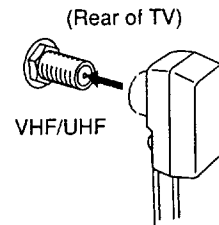

For better picture quality, connect optional antenna cable so that the 300-ohm twin-lead cable can be separated a distance from the TV.

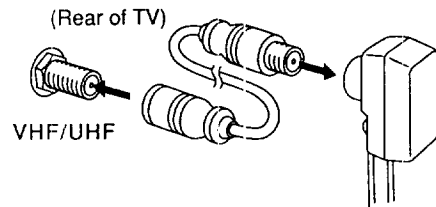

## Connecting both VHF and UHF antennas

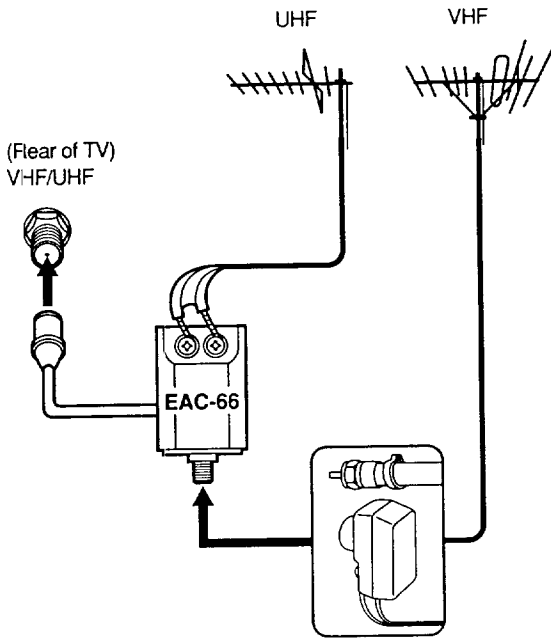

Use an EAC-66 U/V mixer (not supplied).

- 1** Prepare the VHF antenna cable using the appropriate connector (p.12).
- 2** Connect the cable to the U/V mixer.
- 3** Connect the U/V mixer to the VHF/UHF terminal.

### When you use the U/V mixer

Snow and noise may appear in the picture when viewing cable TV channels over 37 (W+1).

## Connecting both VHF/UHF antennas and a CATV cable (KV-32TS46 only)

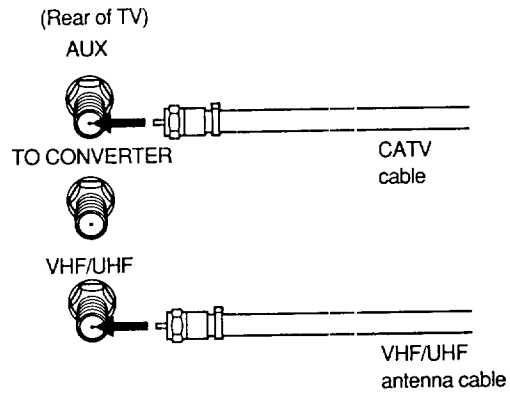

### Note

Do not connect anything to the TO CONVERTER terminal in this case.

## Connecting a cable with a pay cable TV system converter/decoder\* (KV-32TS46 only)

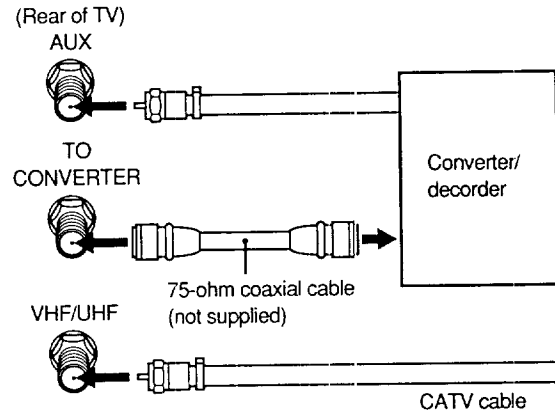

Pay cable TV systems use scrambled or encoded signals require special converters (decoders) in addition to the normal cable connection.

\* The special converter/decoder will be supplied by the cable company.

# Using the On-Screen Menus

The following flow chart shows the different levels of on-screen menus that you can use to make various adjustments and settings. See the indicated pages for instructions on using each feature.

## For picture quality adjustment

Main menu

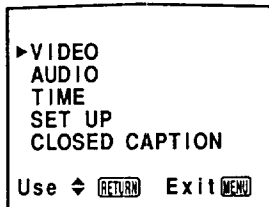

VIDEO menu (pp. 32–33)

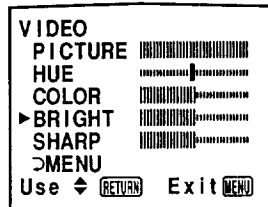

Adjustment bar

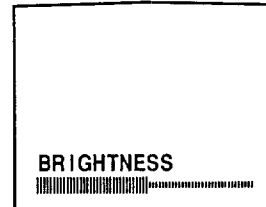

## For sound quality adjustment

Main menu

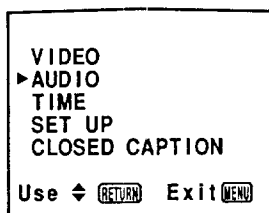

AUDIO menu (pp. 34–37)

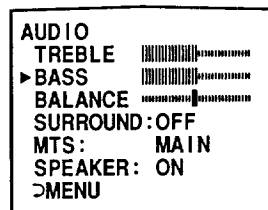

Adjustment bar

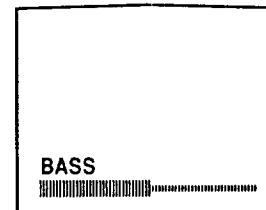

AUDIO OUT screen (p. 37)

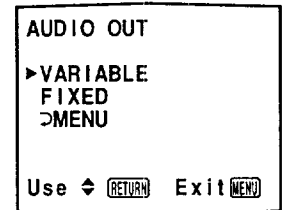

## For time-related settings

Main menu

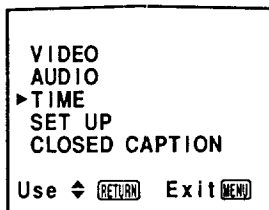

TIME menu

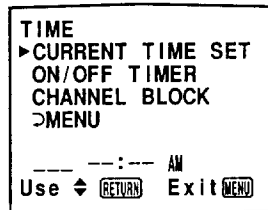

CURRENT TIME SET screen (pp. 44–45)

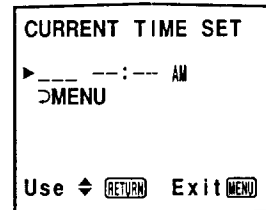

## For language setting (p. 16) (KV-27TS32 only)

Main menu

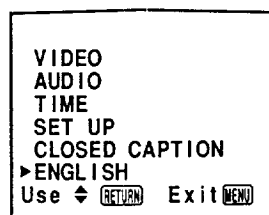

ON/OFF TIMER screen (pp. 46–47)

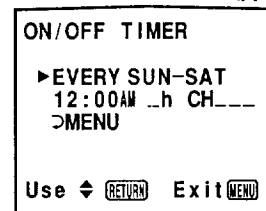

CHANNEL BLOCK screen (pp. 48–49)

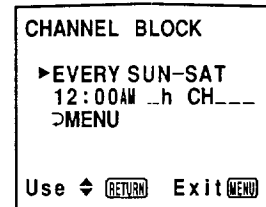

## For language setting (p.16) (KV-2970M/2975M only)

Main menu

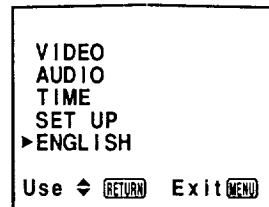



### For presetting and other functions

Main menu

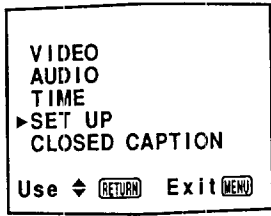

SET UP menu

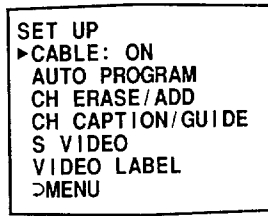

CABLE ON/OFF screen (p. 17)

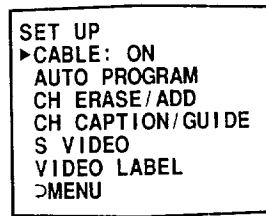

### For closed caption setting

Main menu

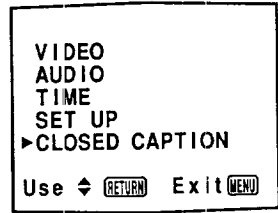

CLOSED CAPTION screen (p. 31)

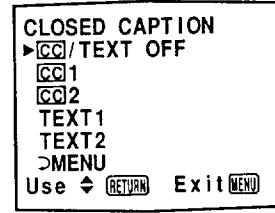

AUTO PROGRAM screen (p. 18)

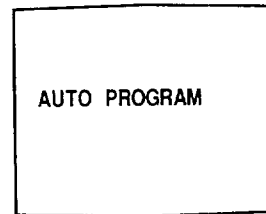

CHANNEL ERASE/ADD screen (pp. 19-21)

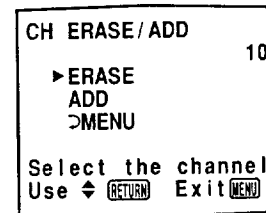

CHANNEL CAPTION/GUIDE screen (pp. 50-51)

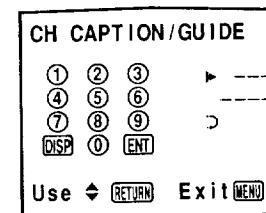

S VIDEO ON/OFF screen (p. 28)

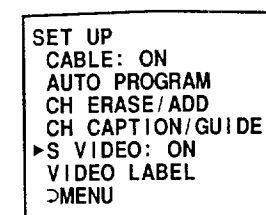

VIDEO LABEL screen (pp. 53-54)

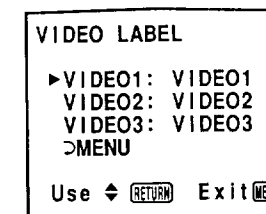

## Navigating through the Menus

Remote Commander

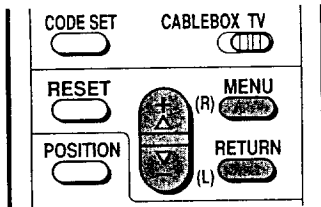

### To display the main menu

Press MENU.

### To return to the previous menu

Press Δ+ or ∇- to select "MENU."  
Then press RETURN.

### To return to the main menu

Repeat the above, until you reach the main menu.

### To return to the normal screen

Press MENU on the Remote Commander.

### Note

The menus disappear automatically if you do not press a button within 90 seconds.

The menu you cannot select appears in black.

# Using the On-Screen Menus

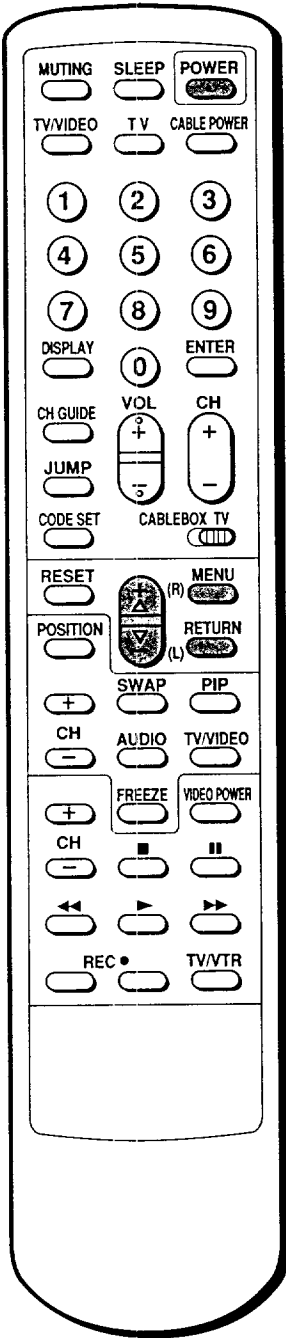

RM-Y118

To return to the normal screen  
Press MENU.

## Changing the Menu Language (KV-27TS32/2970M/2975M only)

The menu language is factory-set to ENGLISH. Follow these instructions to change the menu language to Spanish or back to English.

**1** Press POWER on the TV or the Remote Commander to turn the TV on.

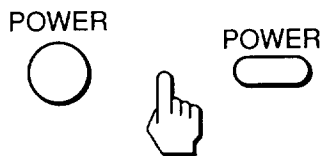

**2** Press MENU.  
*The main menu appears.*



```

▶VIDEO
AUDIO
TIME
SET UP
CLOSED CAPTION
ENGLISH
Use ⏏ (RETURN) Exit (MENU)
    
```

**3** Press Δ+ or ∇- to select ENGLISH.  
Then press RETURN.



```

VIDEO
AUDIO
TIME
SET UP
CLOSED CAPTION
ENGLISH
Use ⏏ (RETURN) Exit (MENU)
    
```

**4** Press Δ+ or ∇- to select language.  
*Each time you press Δ+ or ∇-,  
ESPAÑOL and ENGLISH menus appear.*

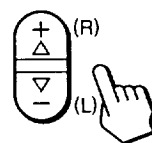

```

VIDEO
AUDIO
HORA
AJUSTES
CLOSED CAPTION
ESPAÑOL
Usar ⏏ (RETURN) Salir (MENU)
    
```

```

VIDEO
AUDIO
TIME
SET UP
CLOSED CAPTION
ENGLISH
Use ⏏ (RETURN) Exit (MENU)
    
```

### Note

Certain parts of the ESPAÑOL menus remain in English.

**5** Press RETURN.  
*The language is selected.*



```

VIDEO
AUDIO
HORA
AJUSTES
CLOSED CAPTION
▶ESPAÑOL
Usar ⏏ (RETURN) Salir (MENU)
    
```

Spanish menu



# Turning the Cable Mode On or Off

All of the controls are on the Remote Commander.

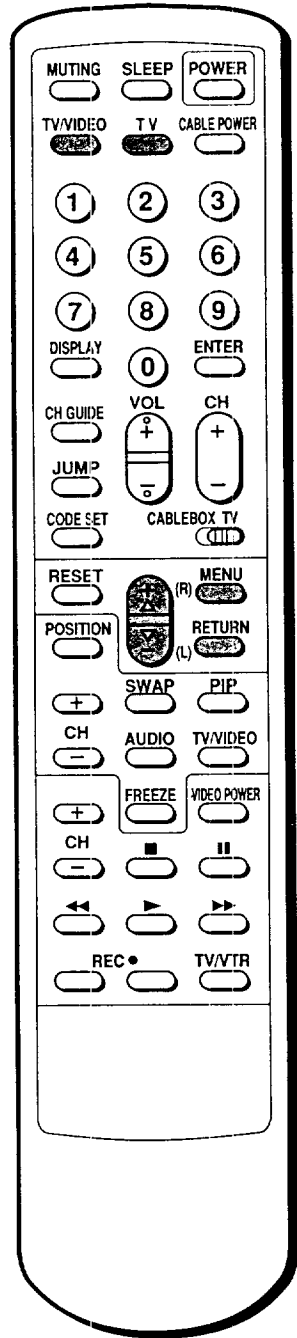

RM-Y118

To return to the normal screen  
Press MENU.

If you have cable connected to your TV (pp.12-13), follow the steps below to turn the cable connection on or off. CABLE is preset to ON when you use your TV for the first time. Then turn CABLE to OFF to preset or watch VHF or UHF channels (pp.18-21 and 29).

**1** Press MENU.  
The main menu appears.



```

▶VIDEO
AUDIO
TIME
SET UP
CLOSED CAPTION
Use ◀ RETURN Exit MENU
    
```

**2** Press Δ+ or ▽- to select SET UP.

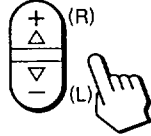

```

VIDEO
AUDIO
TIME
▶SET UP
CLOSED CAPTION
Use ◀ RETURN Exit MENU
    
```

Press RETURN.  
The SET UP menu appears, and the cursor points to "CABLE".



```

SET UP
▶CABLE: ON
AUTO PROGRAM
CH ERASE/ADD
CH CAPTION/GUIDE
S VIDEO
VIDEO LABEL
>MENU
    
```

**Note**

If the CABLE display appears in black, the TV is in VIDEO mode and you cannot select CABLE. Press TV or TV/VIDEO to change to TV mode.

**3** Press RETURN again.



```

SET UP
▶CABLE: ON
AUTO PROGRAM
CH ERASE/ADD
CH CAPTION/GUIDE
S VIDEO
VIDEO LABEL
>MENU
    
```

Press Δ+ or ▽- to select ON or OFF alternately.

```

SET UP
CABLE: ON
AUTO PROGRAM
CH ERASE/ADD
CH CAPTION/GUIDE
S VIDEO
VIDEO LABEL
>MENU
    
```



```

SET UP
CABLE: OFF
AUTO PROGRAM
CH ERASE/ADD
CH CAPTION/GUIDE
S VIDEO
VIDEO LABEL
>MENU
    
```

Press RETURN.  
The setting is completed.

Using the On-Screen Menus  
Turning the Cable Mode On or Off

# Presetting TV Channels

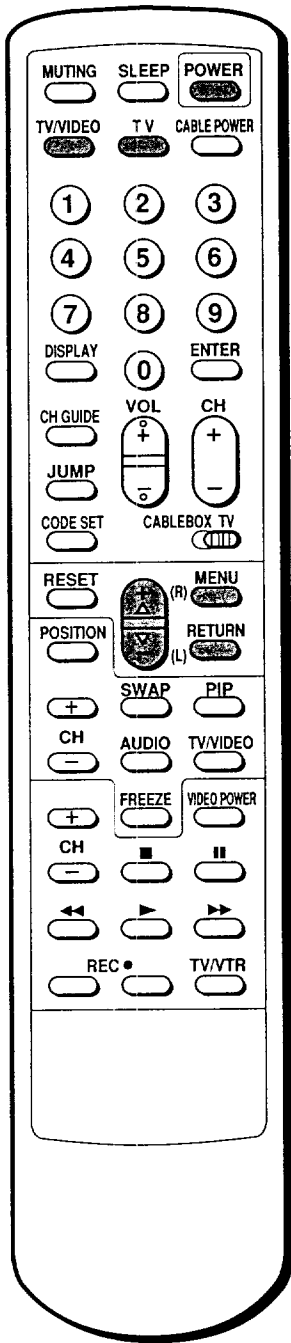

RM-Y118

Channels that can be received on this TV:

VHF	UHF	Cable
2-13	14-69	1-125

## Presetting TV Channels Automatically

**1** Press POWER on the TV or the Remote Commander to turn the TV on.

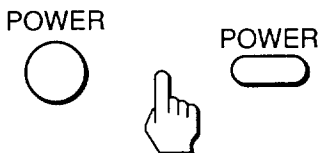

**2** Set the cable connection on or off, depending on if you want to preset cable or VHF/UHF channels.  
(Follow the steps in "Turning the Cable Mode On or Off", p.17)

**3** Press MENU.  
The main menu appears.

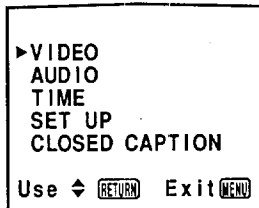

**4** Press Δ+ or ∇- to select SET UP.  
Then press RETURN.  
The SET UP menu appears.

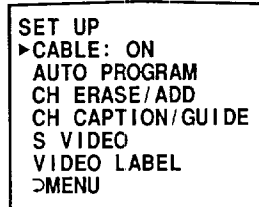

### Note

If the AUTO PROGRAM display appears in black, the TV is in video mode and you cannot select AUTO PROGRAM. Press TV or TV/VIDEO to change to TV mode.

**5** Press Δ+ or ∇- to select AUTO PROGRAM.  
Then press RETURN.

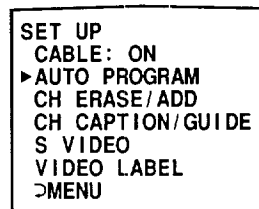
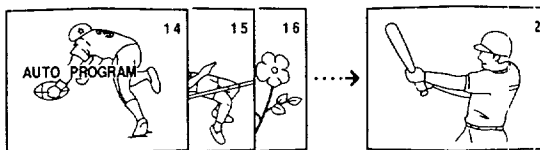

"AUTO PROGRAM" appears on the screen and receivable channels (other than the channels already preset) are preset in numerical sequence. The channels previously preset will not remain in the TV's memory.  
When no more channels can be found, the programming stops and the lowest numbered channel is displayed.

To erase unnecessary channels, or to add channels that could not be preset automatically because their signal was too weak, follow the steps in "Erasing Unnecessary Channels — CHANNEL ERASE" (pp.19–20) and "Presetting Only Desired Channels — CHANNEL ADD" (p. 21).

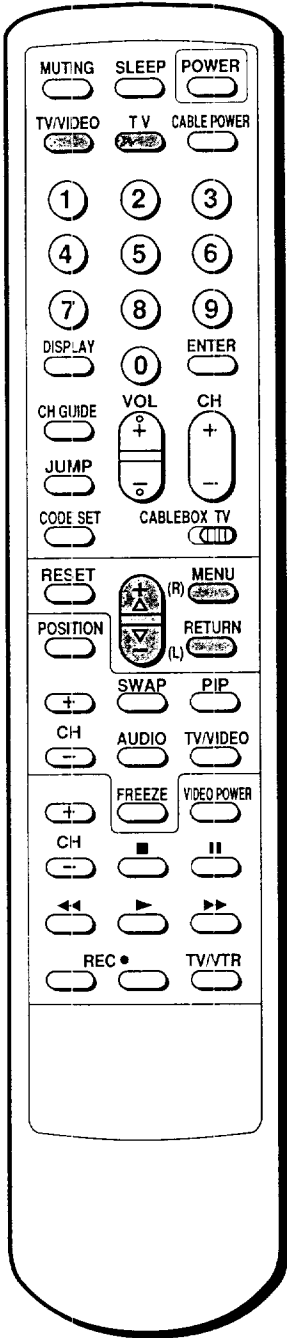

RM-Y118

## Erasing Unnecessary Channels—CHANNEL ERASE

Use this feature to erase unnecessary TV channels, so that when you press CH +/-, the channel(s) are skipped.

**1** Press MENU.  
*The main menu appears.*

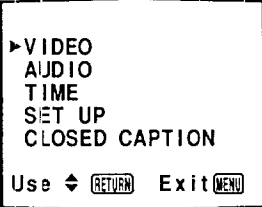

**2** Press  $\Delta+$  or  $\nabla-$  to select SET UP.

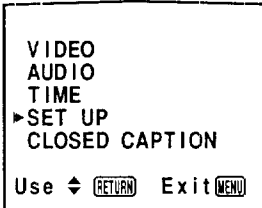
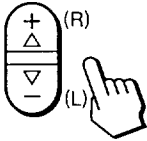

Press RETURN.  
*The SET UP menu appears.*

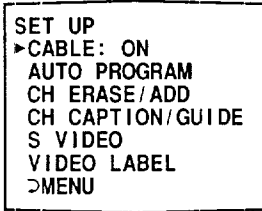

**3** Press  $\Delta+$  or  $\nabla-$  to select CH ERASE/ADD.

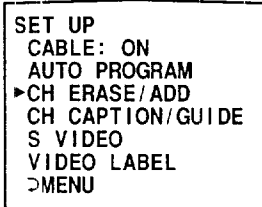
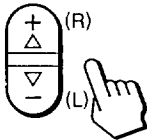

Press RETURN.  
*The CH ERASE/ADD screen appears, and the cursor points to "ERASE".*

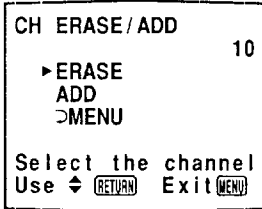

### Note

If CH ERASE/ADD display appears in black, the TV is in video mode and you cannot select CH ERASE/ADD. Press TV or TV/VIDEO to change to TV mode.



Presetting TV Channels

# Presetting TV Channels

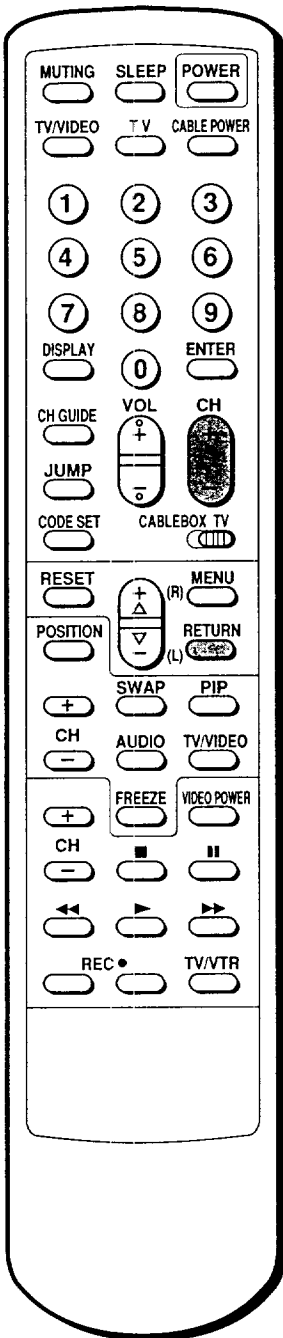

RM-Y118

**To return to the normal screen**  
Press MENU.

**Note**

When you erase a VHF or UHF channel, the cable TV channel with the same number is also erased, and vice versa.

**4** Press the CH +/- button to select the channel you want to erase.  
For example, to erase channel 8, press CH +/- until 8 appears.

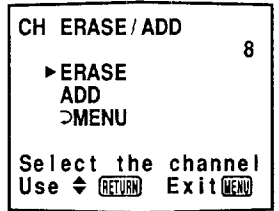
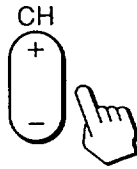

Press RETURN.

A "-" sign appears in front of the channel number display, indicating that the channel is erased from the channel scan memory.

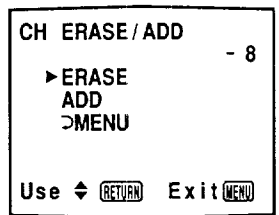

The next time you press the CH +/- buttons, channel 8 will be skipped.

**To erase other channels**  
Repeat step 4.

**Cable TV channel chart\***

Cable TV systems use letters or numbers to designate channels. To tune in a channel, refer to the chart below.

Number on this TV	Corresponding cable TV channel
1	A-8
5	A-7
6	A-6
14	A
15	B
16	C
17	D
18	E
19	F
20	G
21	H
22	I
23	J
24	K
25	L
26	M
27	N
28	O
29	P
30	Q
31	R
32	S

Number on this TV	Corresponding cable TV channel
33	T
34	U
35	V
36	W
37	W+1
38	W+2
39	W+3
⋮	⋮
93	W+57
94	W+58
95	A-5
96	A-4
97	A-3
98	A-2
99	A-1
100	W+59
101	W+60
102	W+61
⋮	⋮
123	W+82
124	W+83
125	W+84

\* This designation of cable TV channels conforms to the EIA/NCTA recommendation. Check with your local cable TV company for more complete information on the available channels.

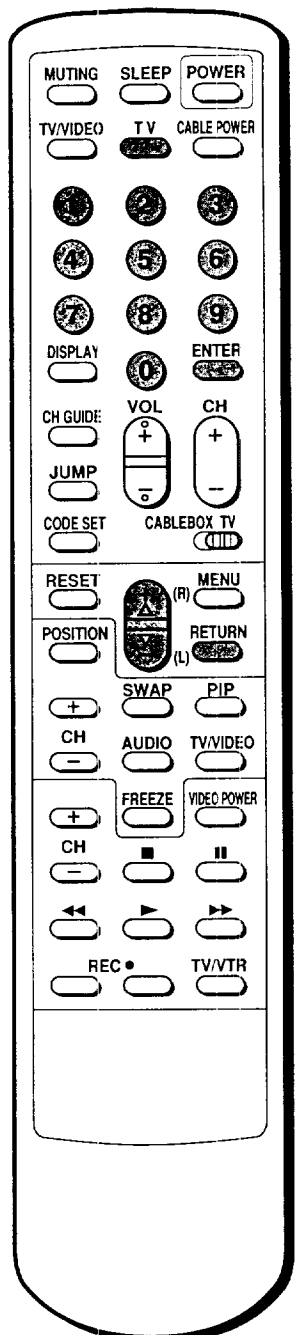

RM-Y118

## Presetting Only Desired Channels—CHANNEL ADD

Use this feature to add channels one by one to the channel scan memory.

### 1-3 (Follow steps 1-3 in "Erasing Unnecessary Channels—CHANNEL ERASE," p.19.)

**Note**

If the CH ERASE/ADD display appears in black, the TV is in video mode and you cannot select CHANNEL ERASE/ADD. Press TV or TV/VIDEO to change to TV mode.

### 4 Press $\Delta$ + or $\nabla$ - to select ADD.

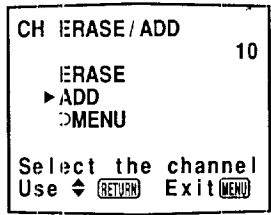
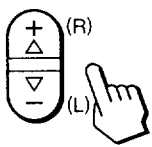

### 5 Press 0-9 and ENTER to select the channel you want to add. For example, to add channel 25, press 2, 5 and ENTER.

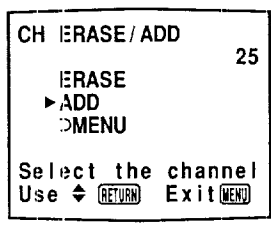
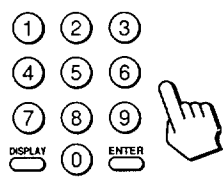

Press RETURN.

A "+" sign appears in front of the channel number display, indicating that the channel is added to the channel scan memory.

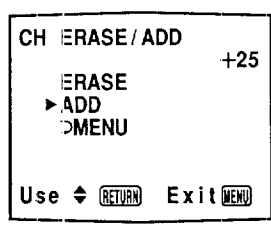

**To add other channels**  
Repeat step 5.

**To return to the normal screen**  
Press MENU.

**Note**

If you add a VHF or UHF channel, the cable TV channel with the same number is also added, and vice versa.



Presetting TV Channels

# Connecting Other Equipment

## Video Equipment

- After connecting, you will be able to...
- Play back video tapes
  - Watch two TV programs at once using a window picture (Picture-in-Picture, pp. 38-43)

### Connecting a VCR with an S video output jack (except for KV-27TS29)

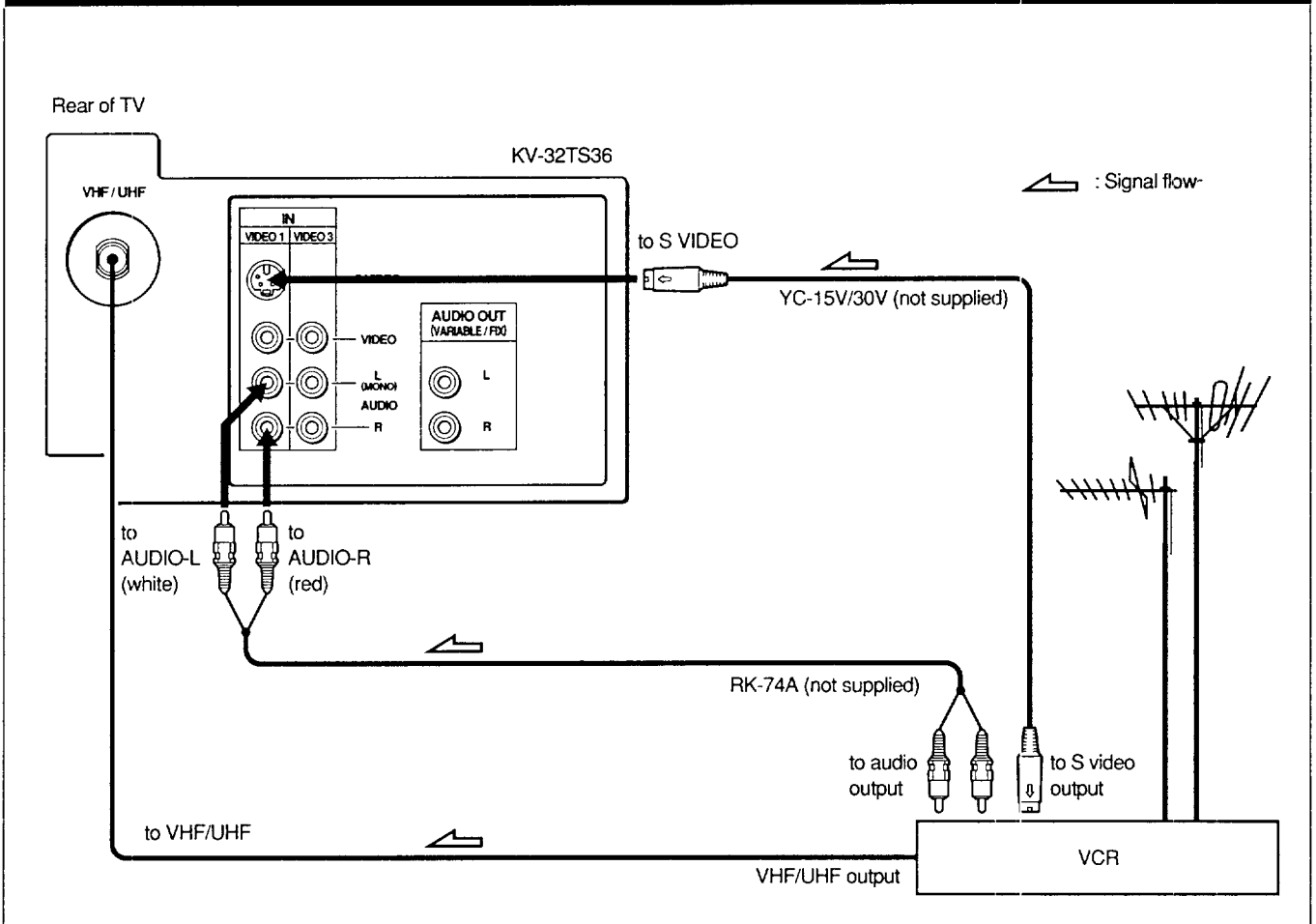

### Notes

- If you connect a monaural VCR, connect the audio output of the VCR to the L (MONO) jack of VIDEO 1 IN on the TV. The monaural sound will be heard from both speakers.
- For operating instructions, refer to the instruction manual furnished with the VCR.
- If the picture or sound is affected, move the VCR away from the TV.
- If S VIDEO is set to OFF, you cannot watch VCR playback pictures from the S VIDEO IN. To set S VIDEO to ON, see "Watching a Video with Your S Video-Equipped VCR", p.28.

### About S video input

Video input and output signals can be separated into Y (luminance or brightness) and C (chroma or color) signals. Usually these two signals are combined in a VCR and sent as one signal to a TV. Separation of the Y and C signals prevents them from interfering with one another, thereby improving picture (especially color) quality. This TV is equipped with an S video input jack through which these separated signals can be input directly. This way you can connect your S video-equipped VCR separately from a non-S video VCR.



## Connecting video equipment not equipped with an S video output jack

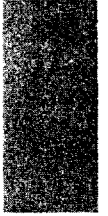
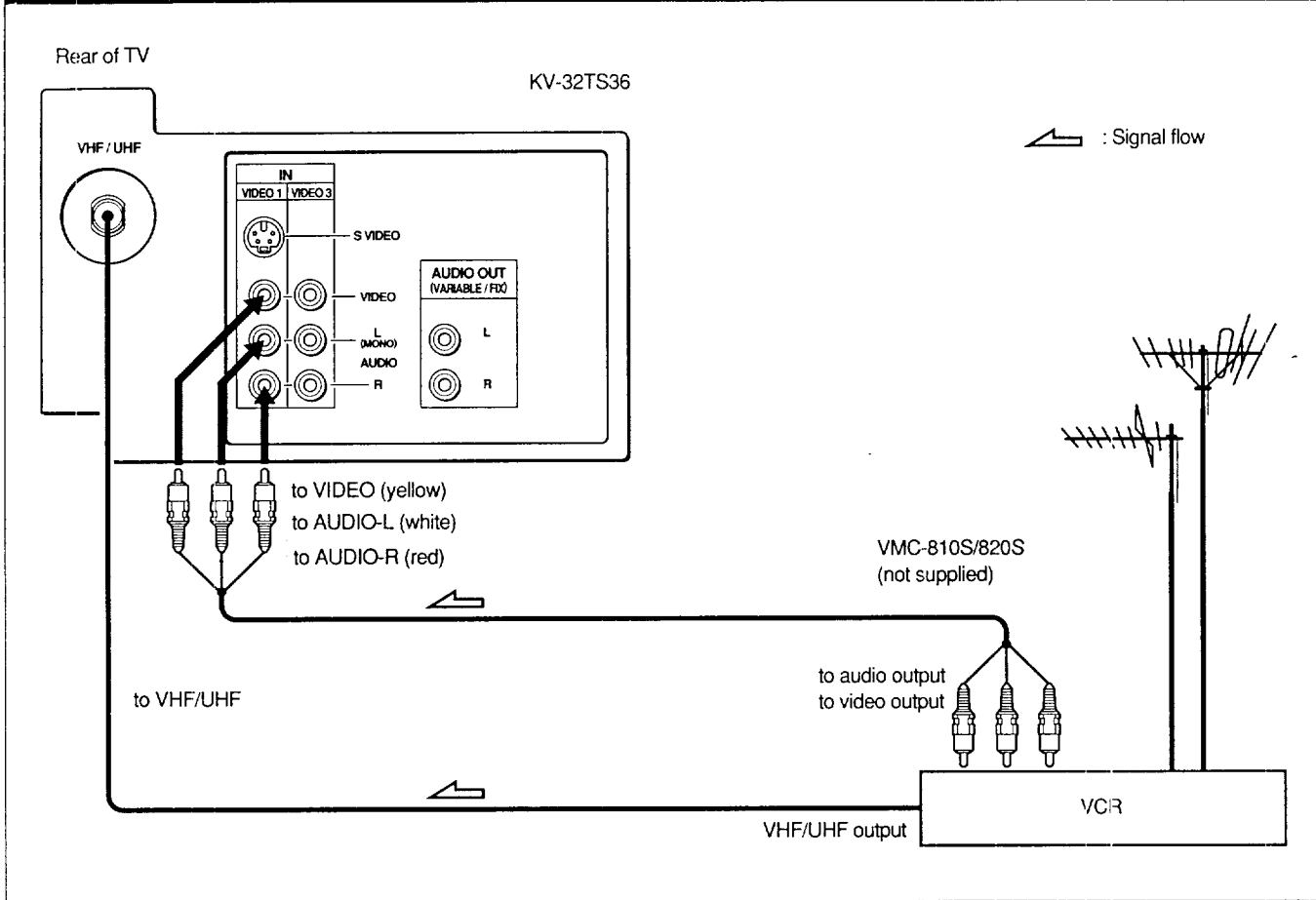

Connecting Other Equipment

### Preparing for use

- 1 Turn on the TV.
- 2 Press the TV/VIDEO button on the TV or on the Remote Commander so that VIDEO appears on the screen.

**When you cannot obtain a clear picture and/or sound**  
 Make sure that the TV/VTR on the VCR is set to TV.  
 Reselect the channel you want to view with the controls on the TV or the Remote Commander.

### Operating your equipment (except for KV-27TS29/2970M)

When using a Sony VCR, Multi-disc player or other manufacture's infrared remote control VCR, you can operate most of the equipments by using the supplied pre-programmed Remote Commander (p. 55).

#### To return to TV mode

Press the TV or TV/VIDEO button so that a channel number appears on the screen.

# Connecting Other Equipment

## Connecting two VCRs for tape editing (KV-27TS32 only)

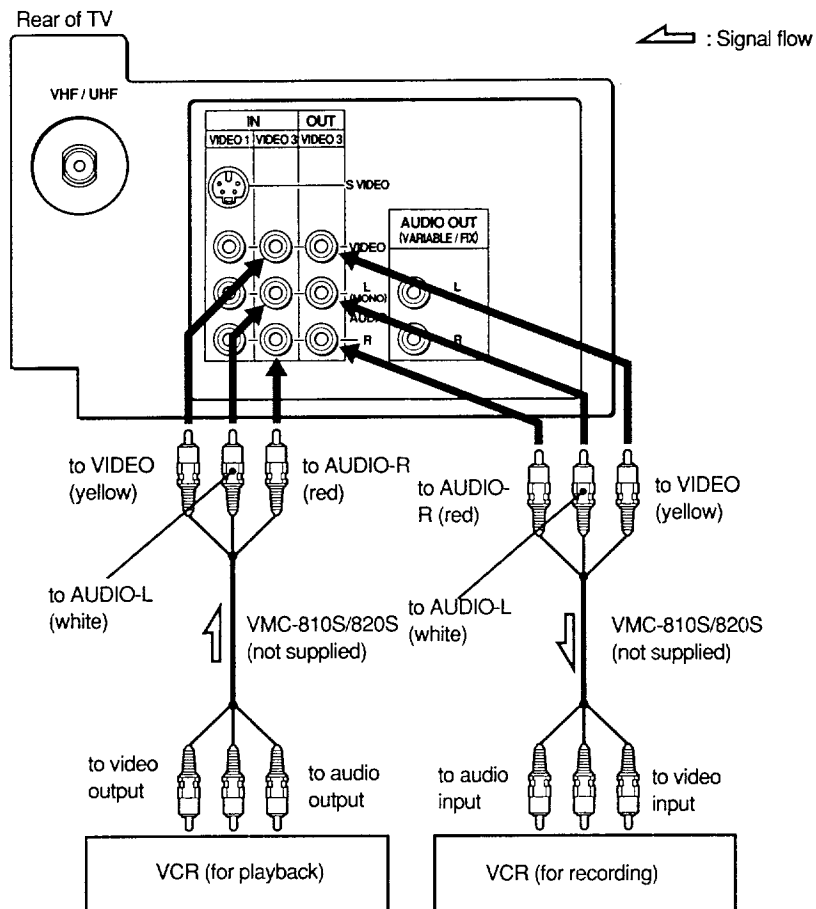

### Watching a different image while duplicating

You can duplicate your recorded tapes by connecting two VCRs.

The VIDEO 3 OUT jacks only output the signal from the VIDEO 3 IN jacks. Connect a VCR for playback to VIDEO 3 IN jacks, and a VCR for recording to the VIDEO 3 OUT jacks. You can watch a TV program or images from VIDEO 1 IN or VIDEO 2 IN during duplicating.

### To watch a different input image

Press TV/VIDEO on the TV or on the Remote Commander to select the input image you want to watch.





## Connecting camcorders (except for KV-27TS29/2970M)

### Playing back recorded tapes

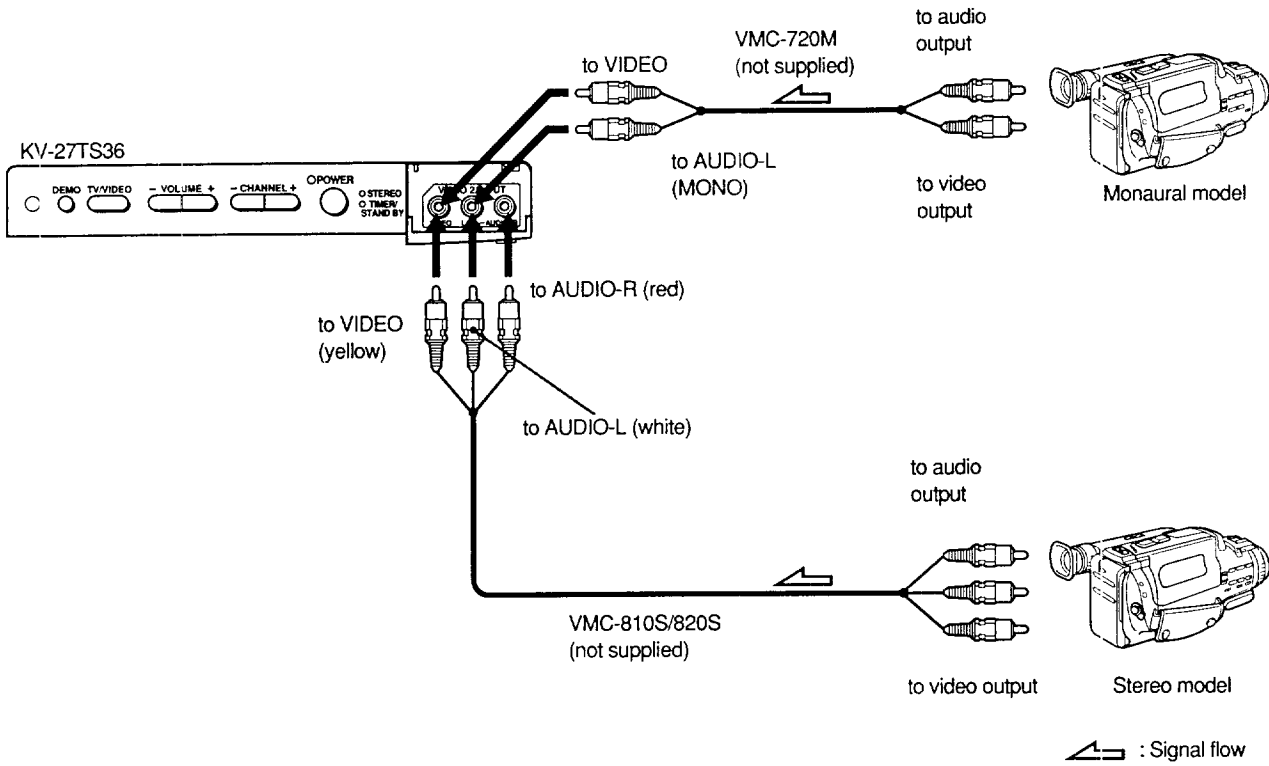

Connecting Other Equipment

### Preparing for use

Same as p. 23.

# Connecting Other Equipment

## Audio System

### Listening to TV or connected VCR sound through an audio system

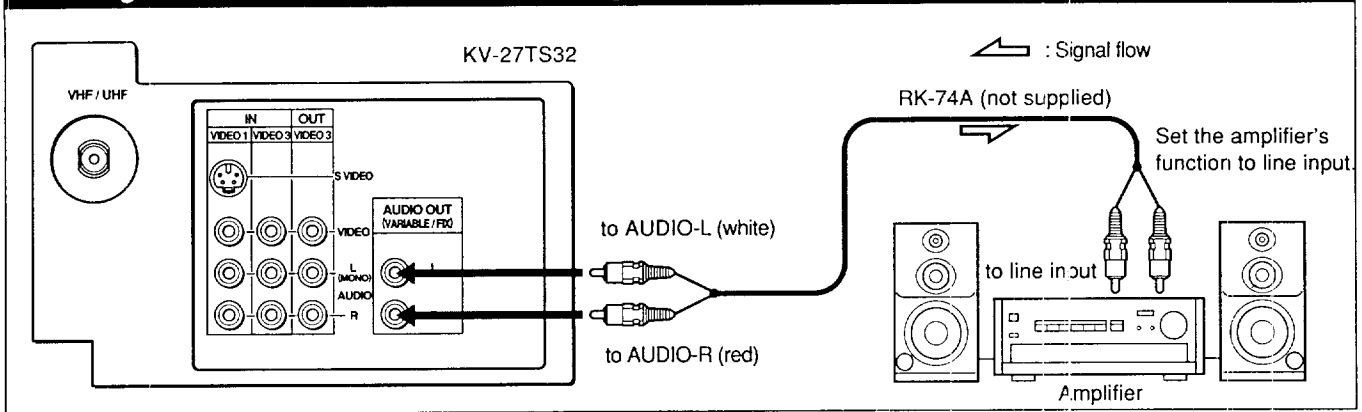

### Preparing for use

Display the mode set menu and set SPEAKER to OFF to cut off the TV speaker sound (p. 37), and listen to the TV's sound solely through the audio system speakers.

### Note

By setting AUDIO OUT variable, you can adjust the bass, treble and balance, or select surround or an MTS (Multichannel TV Sound) mode, using the on-screen menus (pp. 34–36).

## Connecting active super woofer (supplied with KV-32TS46 only)

### Preparing for use

To enjoy the active super woofer sound, make sure the connections are made as illustrated on the next page.

The woofer volume varies according to the TV volume. Adjust the woofer level control properly.

The active super woofer outputs the signal input to its AUDIO IN jacks. If you connect an audio system to the active super woofer's AUDIO OUT jacks, you can enjoy the sound from the audio system and the active super woofer simultaneously.

To make the active super woofer stable, attach the felt feet (supplied) to the bottom.

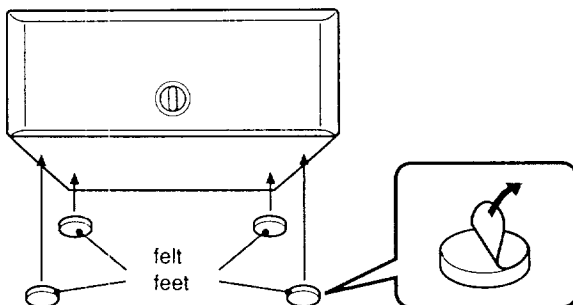

### Notes

- Do not place the woofer on the TV set. To enjoy good sound, place the woofer on a hard object avoiding soft objects like carpets, sofas, etc.
- If you do not use the TV for more than 20 seconds, the active super woofer is turned off automatically to save on power consumption.
- When you release MUTING, the sound of the woofer is heard before that of the TV. This is normal.
- If you set SPEAKER to OFF in the AUDIO menu and select FIX in the AUDIO OUT menu (p.37), the volume of the woofer may be excessive. We recommend that you set SPEAKER to ON when you use the active super woofer.
- You should only connect the KV-32TS46 to the AC outlet on the active super woofer.

### Active Super Woofer Specification

Input: 500 mVrms (100% modulation)  
 Output: 500 mVrms (100% modulation)  
 Impedance: 20 kilohms  
 Speaker output: 9 W (100 Hz)  
 Dimensions: 435 × 165 × 164 mm (W × H × D)  
 (17 1/4 × 6 1/2 × 6 1/2 in.)  
 Mass: 3.9 kg  
 (8 lbs 10 oz)

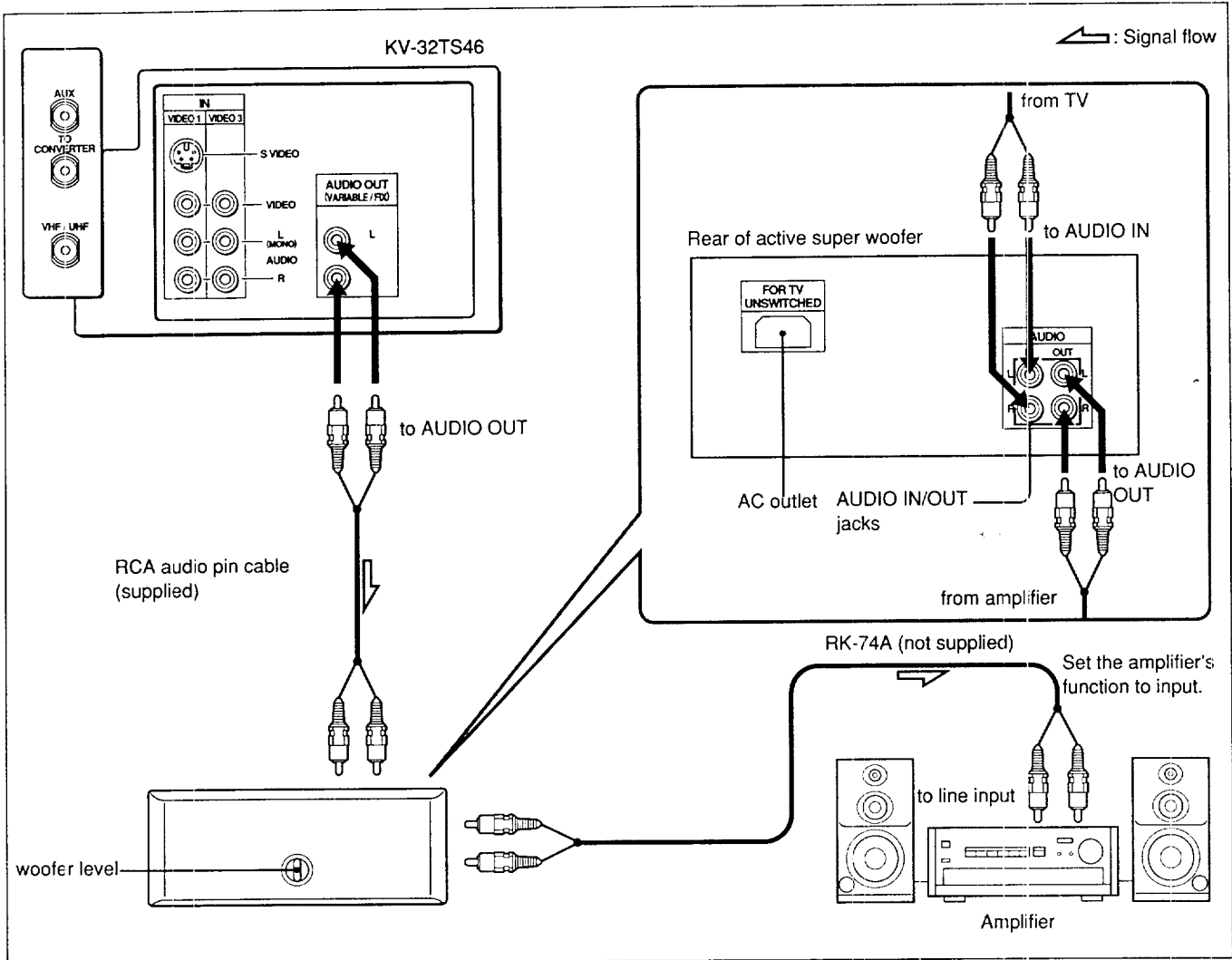

Connecting Other Equipment

### Using TV stand

When you place the active super woofer on a TV stand (not supplied), remove the rear panel of the stand.

Sony or other manufacture's stand

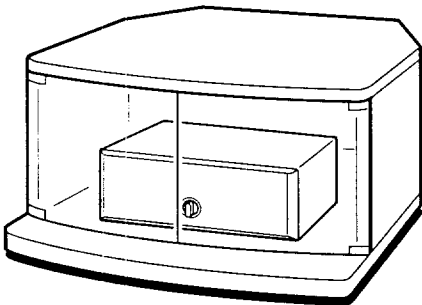

### Note

For good sound quality, avoid placing the stand in front of a curtain or close to a wall.

# Connecting Other Equipment

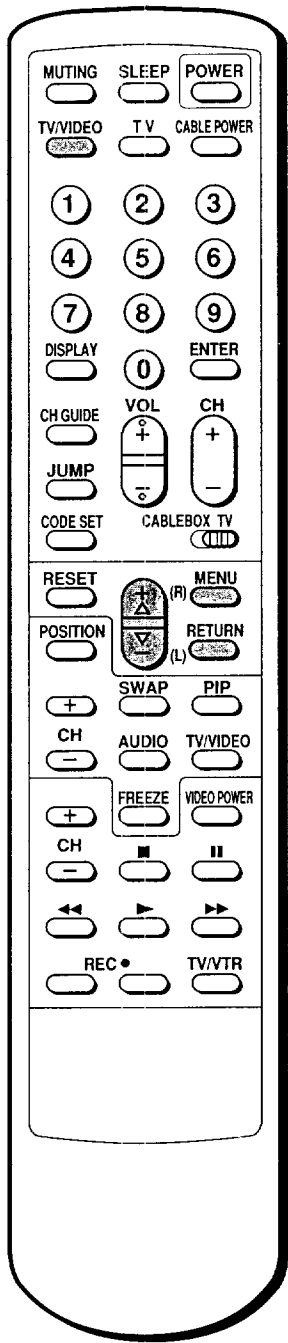

RM-Y118

To return to the normal screen  
Press MENU.

**Note**

If you set S VIDEO to ON, the TV automatically receives S video signals whenever a VCR with S video is connected.

## Watching a Video with Your S Video-Equipped VCR (except for KV-27TS29/2970M)

Use this feature to set S VIDEO to ON or OFF depending on the kind of video equipment you have connected to the TV. For instructions on connecting video equipment, see pp.22-25.

**Note**

If the TV is in TV, VIDEO 2 or VIDEO 3 mode, the S VIDEO display appears in black and cannot be selected. Press TV/VIDEO to change to VIDEO 1 mode.

**1** Press MENU.  
The main menu appears.

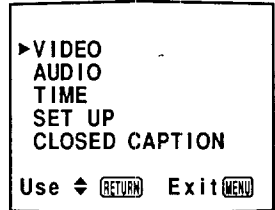

**2** Press  $\blacktriangle+$  or  $\blacktriangledown-$  to select SET UP.

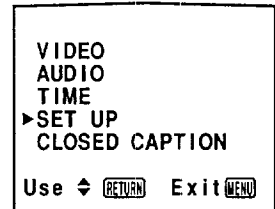
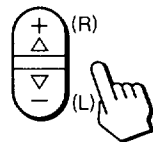

Press RETURN.  
The SET UP menu appears.

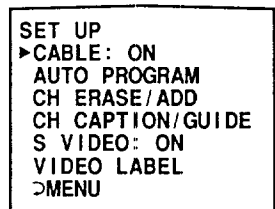

**3** Press  $\blacktriangle+$  or  $\blacktriangledown-$  to select S VIDEO. Then press RETURN.

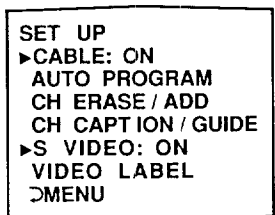
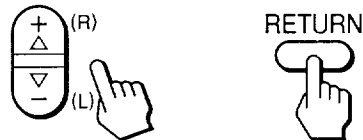

Press  $\blacktriangle+$  or  $\blacktriangledown-$  to select ON or OFF alternately.

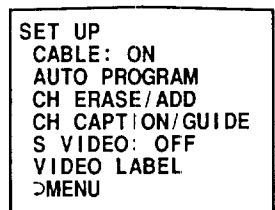
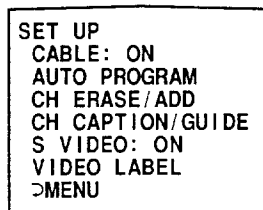

Press RETURN.  
The setting is completed.

# Chapter 2: Using Basic Features Watching TV Programs

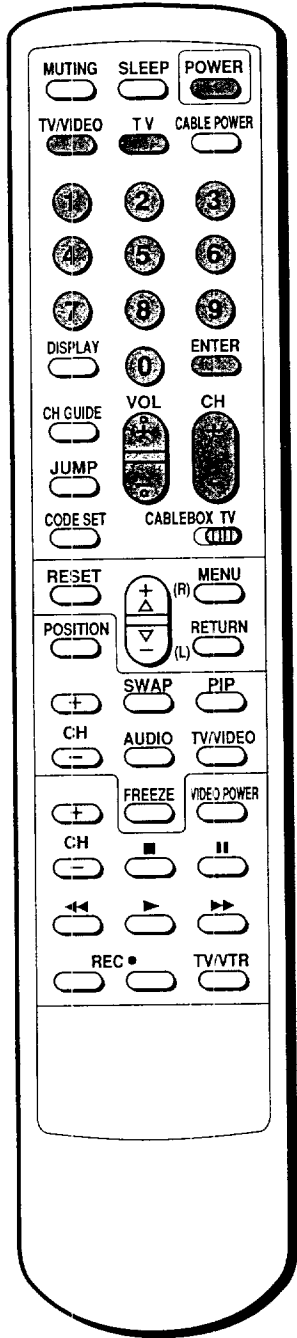

RM-Y118

**1** Press **POWER** on the TV or the Remote Commander to turn the TV on.  
The **TIMER/STAND BY** indicator blinks until the picture appears.

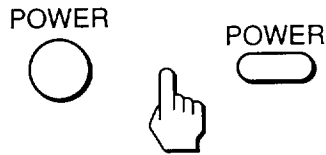

**2** Turn the cable mode on or off to select the type of channel you want to watch, VHF/UHF or cable TV.  
(Follow the steps in "Turning the Cable Mode On or Off," p. 17.)

If "VIDEO" or "S VIDEO" is displayed on the screen, press the **TV** or **TV/VIDEO** button so that the channel number appears.

**3** Select a channel in one of the following two ways:

**To scan the preset channels\* in numerical sequence**

Press **CH +/-**.

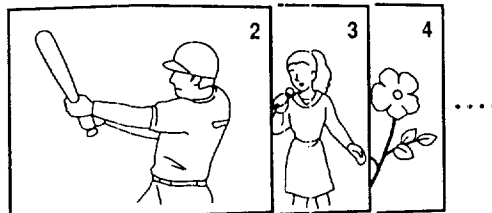
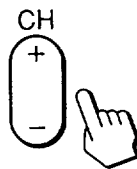

\* For more information on presetting channels, see pp. 18 – 21.

**To select a channel directly**

Press **0 – 9** and **ENTER**.

For example, to select channel 14, press **1**, **4** and **ENTER**.

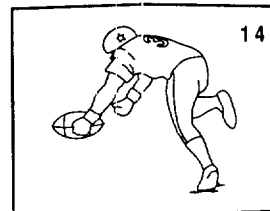
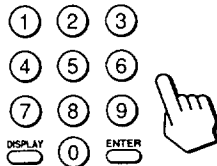

**4** Press **VOL +/-** to adjust the volume.

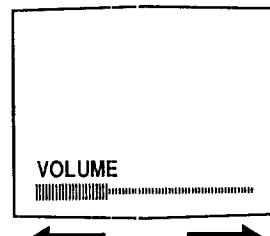
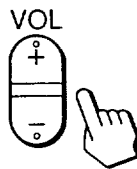

The display will disappear automatically after 3 seconds.

Press **+** to increase the volume.  
Press **-** to decrease the volume.

**To turn off the TV**

Press **POWER** on the TV or the Remote Commander again.

Connecting Other Equipment  
Watching TV Programs

# Using Convenient Features

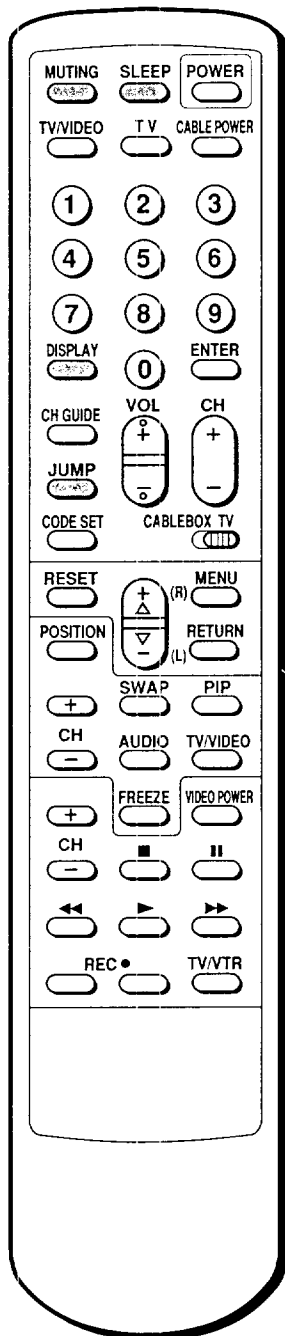

RM-Y118

## Muting the Sound — MUTING

Press MUTING.  
The display "MUTING" will appear on the screen.

MUTING



**To restore the sound**  
Press MUTING again, or press VOL +.

## Keeping the Displays On-Screen — DISPLAY

**To display the channel**  
Press DISPLAY.  
All the existing displays appear: channel number, channel caption (if set), MTS mode ("SAP" only), window picture input mode and the current time ("AM" or "PM" disappears after about three seconds).

DISPLAY



**To cancel the display**  
Press DISPLAY again.  
The channel display will disappear.

## Using the Sleep Timer — SLEEP

The sleep timer turns off the TV automatically after the amount of time you select.

Press SLEEP.  
Each time you press SLEEP, the time increments "30", "60", "90" and "OFF" mode appear in sequence.

SLEEP



SLEEP 30
SLEEP 60
SLEEP 90
SLEEP OFF

The SLEEP display appears about one minute before the TV turns off.

**To cancel the setting**  
Press SLEEP until "OFF" mode appears.  
The "SLEEP OFF" display appears for about three seconds.  
OR  
Turn the TV off.  
The sleep timer setting is cancelled.

## Switching Quickly Between Two Channels—JUMP

Press JUMP once to recall the channel you were watching previously. Press JUMP again to switch back. Use this feature to keep track of two programs alternately.

JUMP



# Using Closed Caption

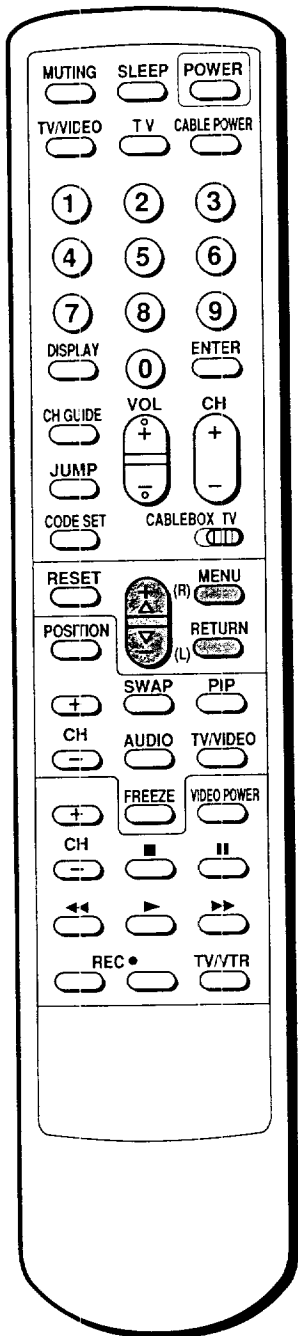

RM-Y118

The Closed Caption system checks for errors before captions or text appear. If an error is found, the mistake does not appear; a white box appears instead. In most cases, this allows you to read the caption without difficulty. Of course, not all errors can be found, and in some cases mistakes may appear. Poor reception of any TV station can cause poor reception of the Closed Caption signal causing errors or missing captions.

- 1 Press MENU.  
The main menu appears.

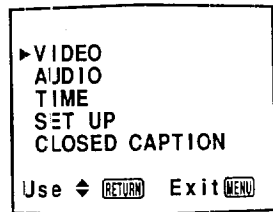

- 2 Press  $\blacktriangle$ + or  $\blacktriangledown$ - to select CLOSED CAPTION.  
Then press RETURN.  
The CLOSED CAPTION screen appears.

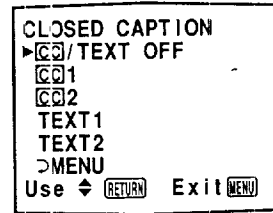
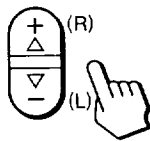

- 3 Press  $\blacktriangle$ + or  $\blacktriangledown$ - to select closed caption mode.

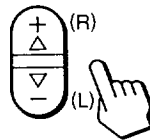

Select CC1 or CC2 to view Captions. A Caption is a printed version of the dialogue or sound effects of a program. (The mode should be set to CC1 for most programs.)

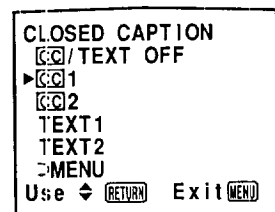

Select TEXT1 or TEXT2 to view Text. Text is information that is presented using the half to full television screen. It is usually not related to the program.

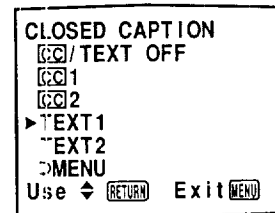

Select CC/TEXT OFF if you do not want to use the CLOSED CAPTION mode.

Press RETURN.  
The setting is completed.

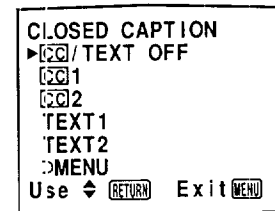

Using Convenient Features  
Using Closed Caption

# Adjusting Picture and Sound Quality

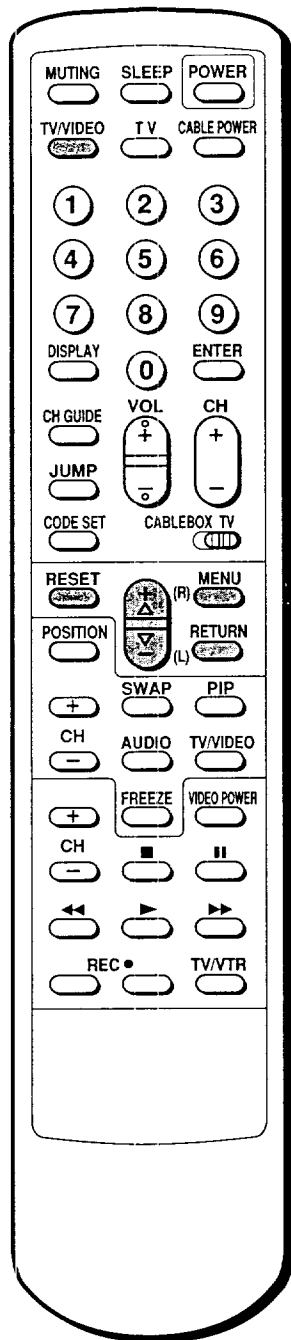

RM-Y118

## Adjusting the Picture

You can adjust the picture (and sound, pp. 34–37) for each input mode (TV, VIDEO 1, VIDEO 2, VIDEO 3) by pressing TV/VIDEO on the TV or on the Remote Commander to select the input mode before making the adjustments. These adjustments are retained in memory even when you turn off the TV until you change the adjustments again. (except for KV-27TS29/2970M)

- 1 Press MENU.  
The main menu appears, and the cursor points to "VIDEO".

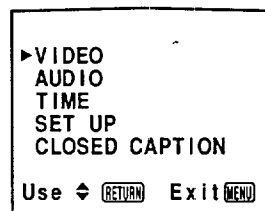

- 2 Press RETURN.  
The VIDEO menu appears.

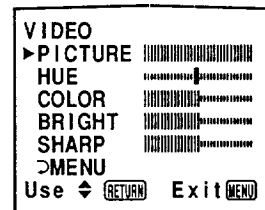

- 3 Press  $\blacktriangle+$  or  $\blacktriangledown-$  to select the item you want to adjust.  
For example, to adjust the picture brightness, select BRIGHT.

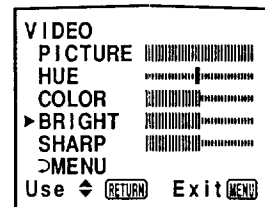
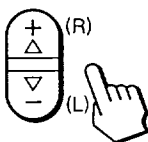

Press RETURN.  
The adjustment bar appears.

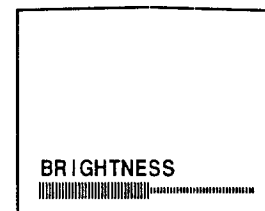





**4** Press  $\Delta$ + or  $\nabla$ - to make the adjustment.

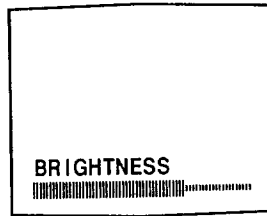
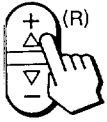

Brighter  $\rightarrow$

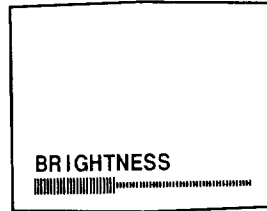
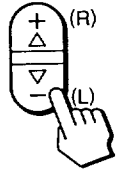

$\leftarrow$  Darker

Press RETURN.  
The new setting appears in the VIDEO menu.

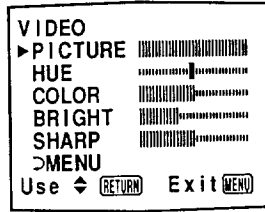

**To adjust other items**  
Repeat steps 3-4.

	Press $\nabla$ to	Press $\Delta$ to
PICTURE	decrease picture contrast with soft color	increase picture contrast with vivid color
HUE	make skin tones become purplish	make skin tones become greenish
COLOR	decrease color intensity	increase color intensity
BRIGHTNESS	darken the picture	brighten the picture
SHARPNESS	soften the picture	sharpen the picture

The menus and adjustment bars will disappear automatically after 90 seconds if you do not press any other buttons during that time.

**To return to the normal screen**  
Press MENU.

**To restore the factory (mid-level) setting**  
Go to the VIDEO menu and press RESET.  
All the settings except for PICTURE will be restored to the mid-level setting.

# Adjusting Picture and Sound Quality

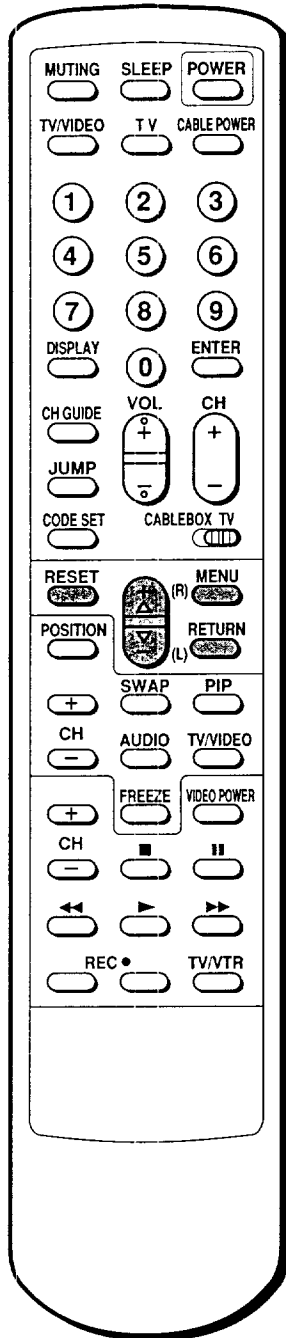

RM-Y118

## Adjusting the Sound

- 1 Press MENU.  
*The main menu appears.*

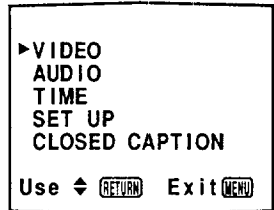

- 2 Press  $\blacktriangleup$  or  $\blacktriangledown$  to select AUDIO.

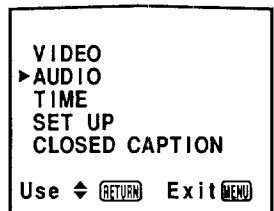
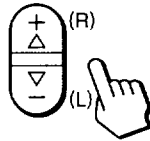

- Press RETURN.  
*The AUDIO menu appears.*

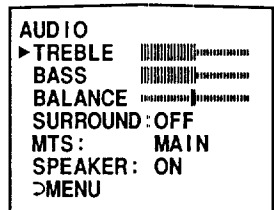

- 3 Press  $\blacktriangleup$  or  $\blacktriangledown$  to select the sound quality (TREBLE, BASS or BALANCE) that you want to adjust. For example, to adjust the bass response, select BASS.

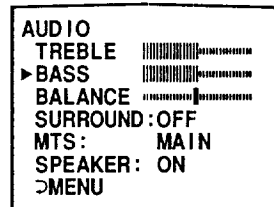
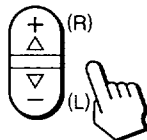

- Press RETURN.  
*The adjustment bar appears.*

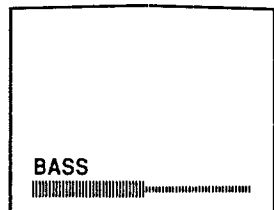



**4** Press  $\Delta+$  or  $\nabla-$  to make the adjustment.

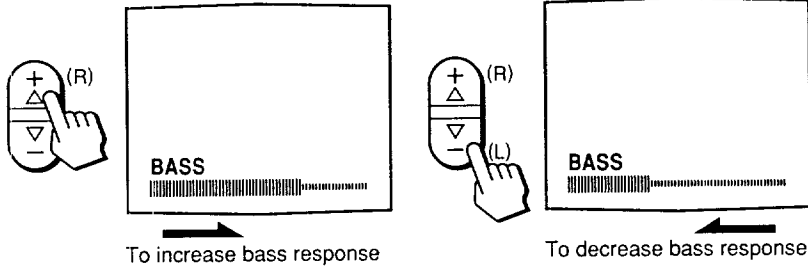

Press RETURN.  
The new setting will appear in the AUDIO menu.

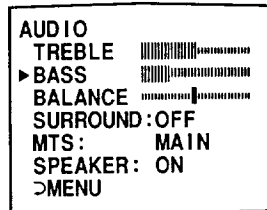

**To adjust other items**  
Repeat steps 3–4.

	Press $\nabla-$ to:	Press $\Delta+$ to:
TREBLE	decrease the treble response	increase the treble response
BASS	decrease the bass response	increase the bass response
BALANCE	emphasize the left speaker's volume	emphasize the right speaker's volume

The menus and adjustment bars will disappear automatically after 90 seconds if you do not press any buttons during that time.

### Listening to surround sound—SURROUND

## 1-2 (Follow steps 1–2 in "Adjusting the Sound", p. 34.)

**3** Press  $\Delta+$  or  $\nabla-$  to select SURROUND.  
Then press RETURN.

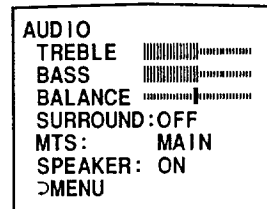

**4** Press  $\Delta+$  or  $\nabla-$  to select ON or OFF modes alternately.  
Then press RETURN.

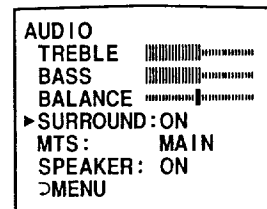

**To restore the factory (mid-level) settings**  
Go to the AUDIO menu and press RESET.  
The settings for MTS and SPEAKER will not be affected (pp. 36–37).

**To return to the normal screen**  
Press MENU.



SURROUND gives sound reproduction with the atmosphere of a movie theater or a concert hall.

# Adjusting Picture and Sound Quality

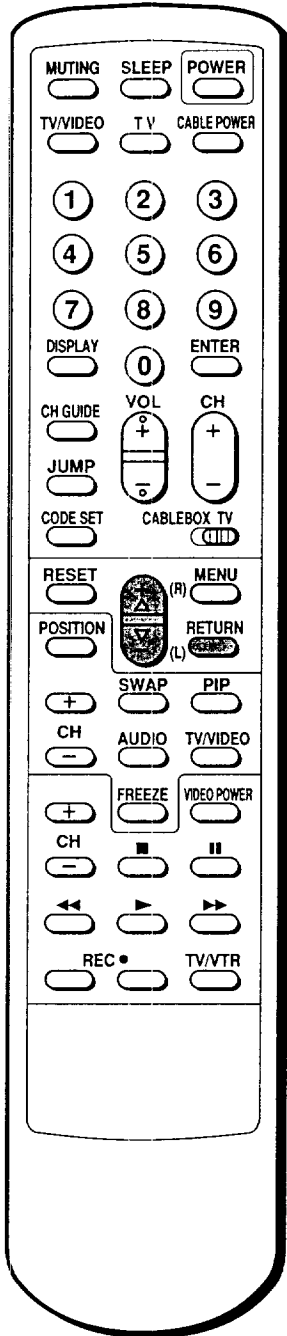

RM-Y118

## Receiving Multichannel TV Sound programs—MTS

**1-2** (Follow steps 1–2 in "Adjusting the Sound," p. 34.)

**3** Press  $\Delta$ + or  $\nabla$ - to select MTS. Then press RETURN.

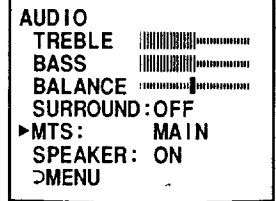

**4** Press  $\Delta$ + or  $\nabla$ - to select MAIN, SAP or MONO modes alternately.

Select the MAIN mode to listen to STEREO sound.

*The STEREO indicator on the TV will light up whenever a stereo broadcast is received.*

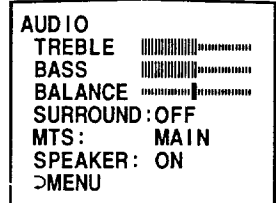
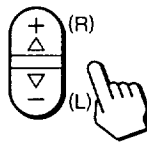

Select the SAP mode to listen to Second Audio Programs.

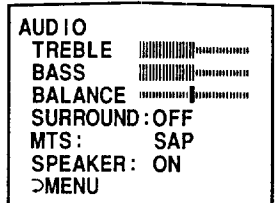
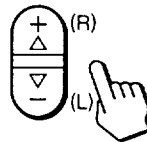

### Note

During SAP mode, the sound of non-SAP programs will be muted.

Select the MONO mode to eliminate excessive noise during stereo broadcasts, caused by a weak signal.

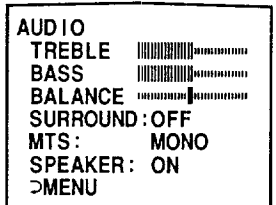
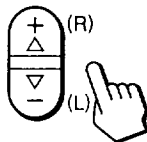

**5** Press RETURN.  
*The mode is selected.*



## Turning the speaker on or off

Use this feature to turn the TV speaker off when you connect an audio system (p. 26–27).

# 1-2

(Follow steps 1–2 in “Adjusting the Sound,” p. 34.)

**3** Press  $\Delta+$  or  $\nabla-$  to select SPEAKER. Then press RETURN.

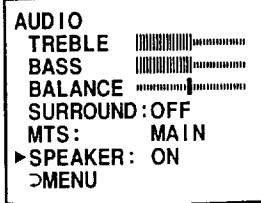
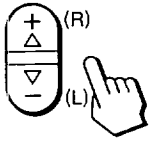

**4** Press  $\Delta+$  or  $\nabla-$  to select ON or OFF modes alternately.

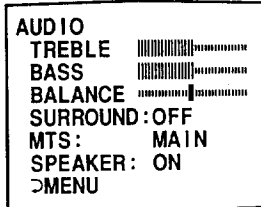
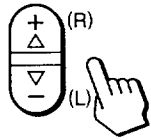

**If you select ON mode:**  
The setting is completed.

**If you select OFF mode:**

**1** Press RETURN.  
The AUDIO OUT menu appears.

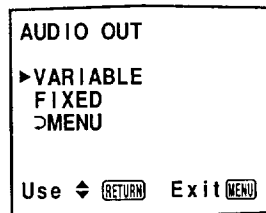

**2** Press  $\Delta+$  or  $\nabla-$  to select VARIABLE or FIXED.

VARIABLE: Sound output varies according to the TV volume.

FIXED : Sound output is always invariable.

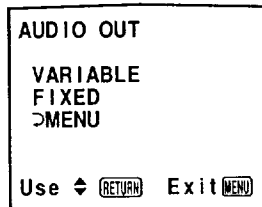
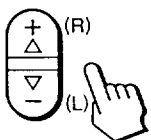

To return to the normal screen  
Press MENU.

# Watching Two Pictures at Once (Picture-in-Picture)

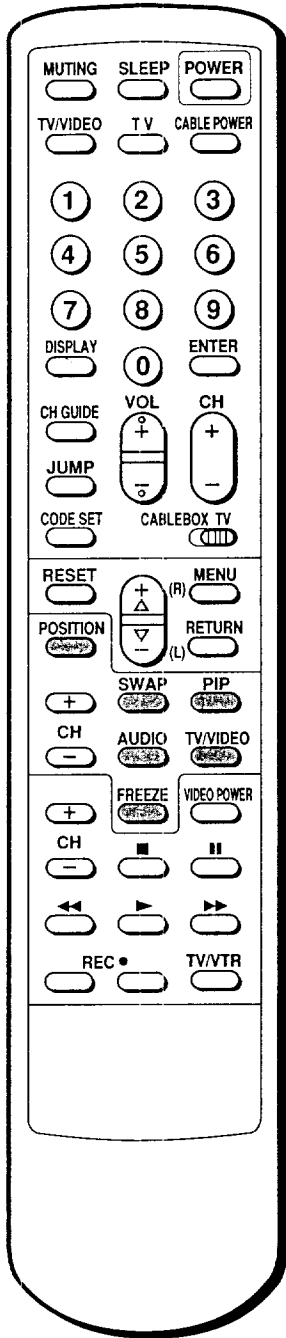

RM-Y118

**Note**

To operate your VCR with the supplied Remote Commander, See "Using the Pre-Programmed Remote Commander", pp. 55-57.

You can watch both the main picture and a window picture simultaneously by using the Picture-in-Picture (PIP) function. Model KV-32TS46 is equipped with two-tuner PIP, allowing you to watch two TV channels at once. Other models are equipped with one-tuner PIP. To watch two different TV channels, you must first connect a VCR to the TV, to watch a second TV channel through the VCR tuner. (See "Connecting Other Equipment", pp. 22-27.)

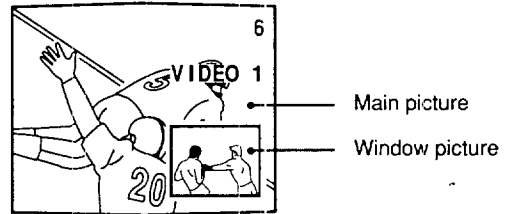

**Picture-in-Picture special features**

When watching the main picture and a window picture, you can:

- Swap the main and window pictures (SWAP).
- Change the position of the window picture (POSITION).
- Display a still picture as a window (FREEZE).
- Choose the sound from the main or window picture (AUDIO).

**Displaying a window picture—PIP**

Press PIP to display a window picture



Input-source mode or TV channel for the main picture

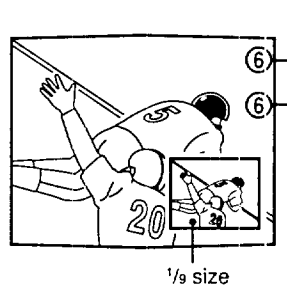

Input-source mode or TV channel for the window picture

Press PIP again to display a smaller window picture

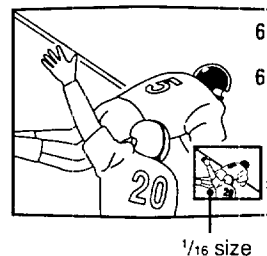

**To remove the window picture**  
Press PIP once more.



## Changing the window picture input mode

**1** Press PIP to display a window picture.

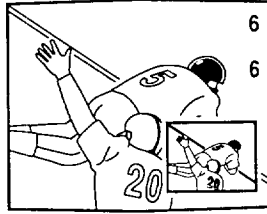

**2** Press TV/VIDEO in the Picture-in-Picture control area to select the input mode.

Each time you press TV/VIDEO, "TV", "VIDEO 1", "VIDEO 2" and "VIDEO 3" appear in sequence.

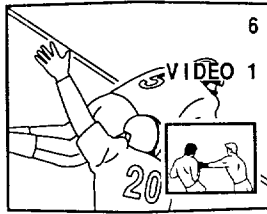

A window picture will appear in the same input mode as the last time you used PIP.

### To receive the window picture sound

Press AUDIO.

The  display appears for a few seconds, indicating that the window picture sound is being received.



### To restore the main picture sound

Press AUDIO again.

### Notes

- If the main picture is not receiving an image, the window picture may be in black and white.
- When you turn PIP on or when you turn the TV on with PIP mode, the window picture will appear at the bottom right of the screen.
- The window picture may be affected by the condition of the main picture.
- The window picture sound is also output from the VARIABLE/FIX AUDIO OUT jacks.



Watching Two Pictures at Once (Picture-in-Picture)

# Watching Two Pictures at Once (Picture-in-Picture)

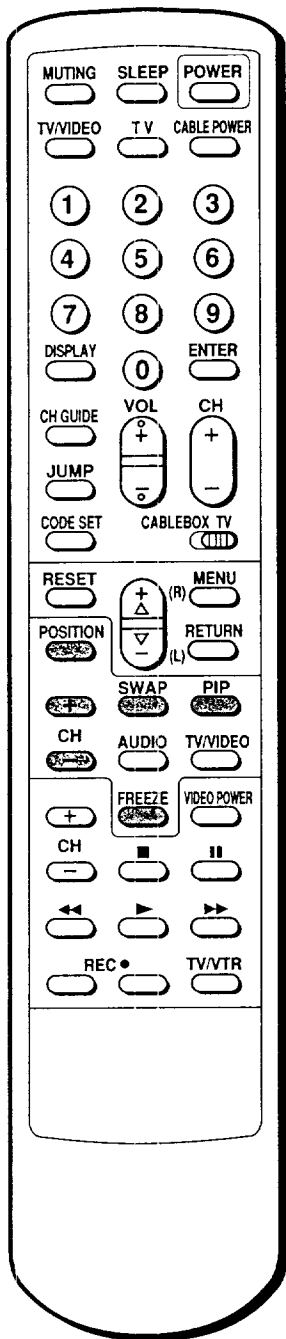

RM-Y118

## Changing TV channels in the window picture

**1** Press PIP to display a window picture.

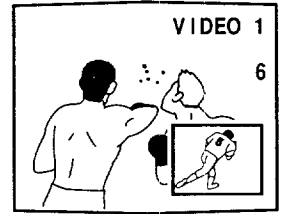

**2** Press CH +/- in the PIP control area.

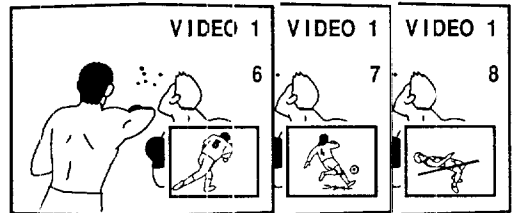
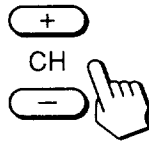

## Changing the position of the window picture—POSITION

**1** Press PIP to display a window picture.

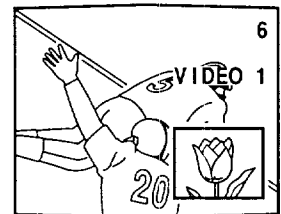

**2** Press POSITION.  
Each time you press POSITION, the window picture will move counterclockwise on the screen, as illustrated below.

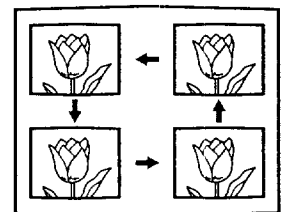





## Displaying a still picture — FREEZE

Use the FREEZE function to display a still picture as a window. This function is useful when you want to write down a recipe from a cooking program, a displayed address or a phone number and so on.

- 1** Press PIP to display a window picture.

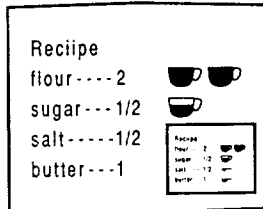

- 2** Press FREEZE.  
*The window picture image remains still on the screen.*

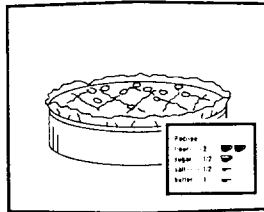

To restore the normal picture  
Press FREEZE again.

## Swapping the main and window pictures — SWAP

- 1** Press PIP to display a window picture.

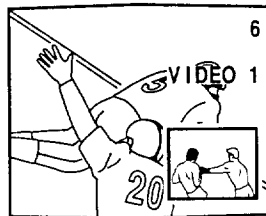

- 2** Press SWAP.  
*Each time you press SWAP, the images from the main and window pictures switch places.*

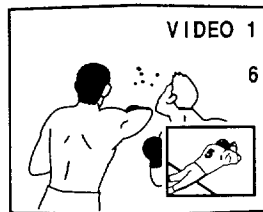

Watching Two Pictures at Once (Picture-In-Picture)

# Watching Two Pictures at Once (Picture-in-Picture)

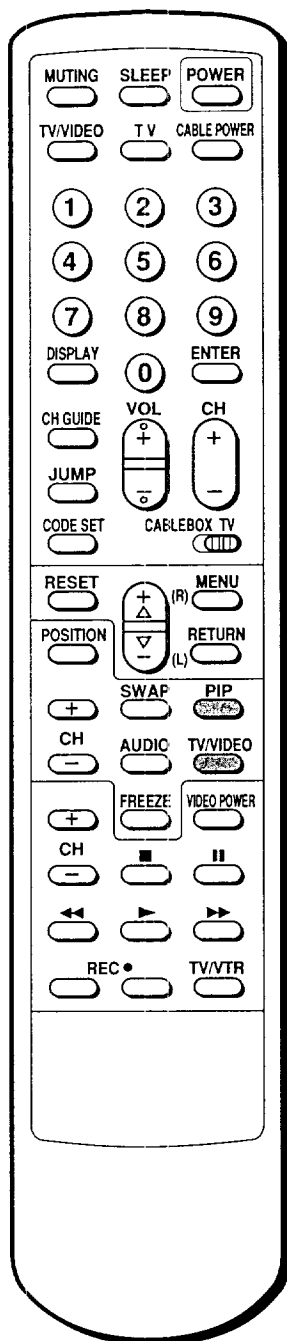

RM-Y118

## Displaying a pay cable TV channel as a window picture

To display a pay cable TV channel as a window picture, connect your decoder box as illustrated below.

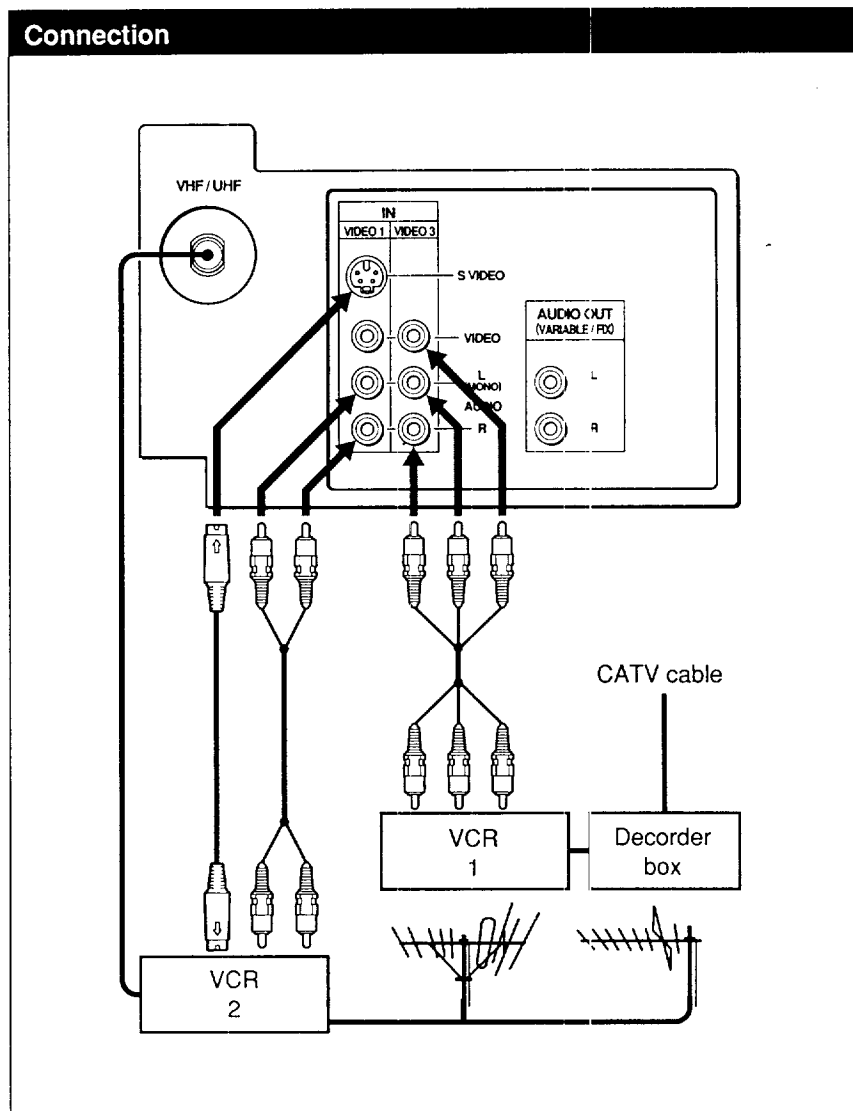

### Note

The channels being received through the AUX terminal cannot be displayed as a window picture. (KV-32TS46 only)

After making the connections, turn the cable mode on by following the steps "Turning the Cable Mode On or Off", p. 17. Then continue with steps below.

**1** Press PIP to display a window picture.

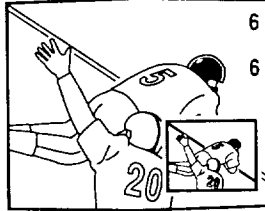

**2** Press TV/VIDEO in the Picture-in-Picture control area to select the input mode.  
*Each time you press TV/VIDEO, "TV", "VIDEO 1", "VIDEO 2" and "VIDEO 3" appear in sequence.*

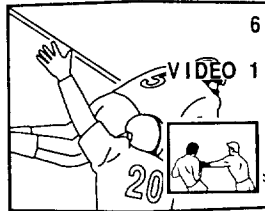

**3** Put your VCR on an inactive channel (CH 3 or 4).

**4** Change pay cable TV channels with the decoder box.



Watching Two Pictures at Once (Picture-in-Picture)

# Using the Timer-Activated Functions

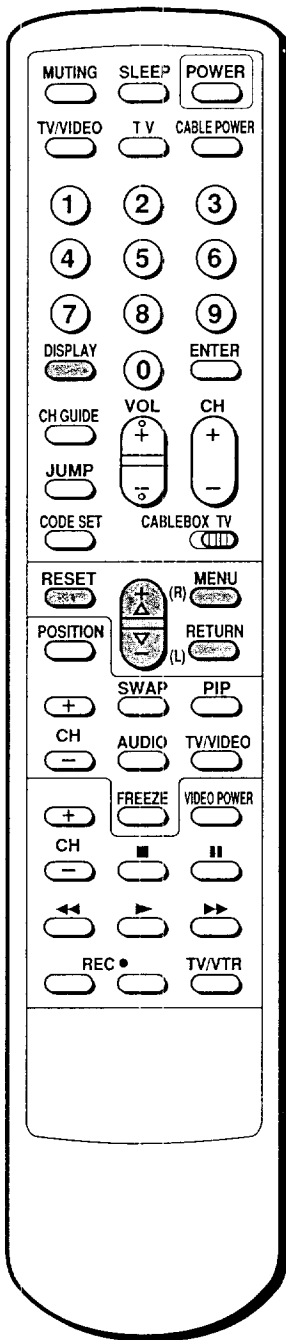

RM-Y118

## Setting the Clock—CURRENT TIME SET

Follow these instructions to set the current time. The correct time must be set in order to use the timer-activated functions (ON/OFF TIMER, CHANNEL BLOCK).

EXAMPLE: Set the time to 3:15 PM, Monday.

- 1** Press MENU.  
*The main menu appears.*



▶ VIDEO  
AUDIO  
TIME  
SET UP  
CLOSED CAPTION

Use ◀ RETURN Exit MENU

- 2** Press Δ+ or ▽- to select TIME.

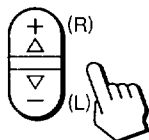

VIDEO  
AUDIO  
▶ TIME  
SET UP  
CLOSED CAPTION

Use ◀ RETURN Exit MENU

Press RETURN.

*The TIME menu appears, and the cursor points to "CURRENT TIME SET".*



TIME  
▶ CURRENT TIME SET  
ON/OFF TIMER  
CHANNEL BLOCK  
▷MENU

---:--:-- AM  
Use ◀ RETURN Exit MENU

- 3** Press RETURN.  
*The CURRENT TIME SET screen appears.*



CURRENT TIME SET

▶ ---:--:-- AM  
▷MENU

Use ◀ RETURN Exit MENU

- 4** Press RETURN again.  
*"Set the day." appears on the screen.*



CURRENT TIME SET

SUN 12:00 AM  
▷MENU

Set the day.

Use ◀ RETURN Exit MENU



**5** Press  $\Delta+$  or  $\nabla-$  to set the day.  
*Each time you press  $\Delta+$  or  $\nabla-$ , the day changes consecutively.*

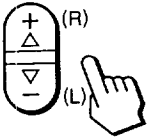

Press RETURN.  
*"Set the time." appears on the screen.*

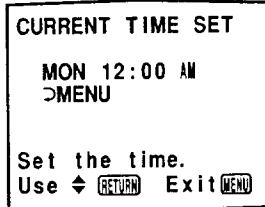

**6** Press  $\Delta+$  or  $\nabla-$  to set the hour.  
*Each time you press  $\Delta+$  or  $\nabla-$ , the hour changes starting with "12:00 AM."*

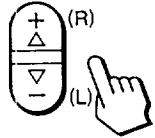

Press RETURN.

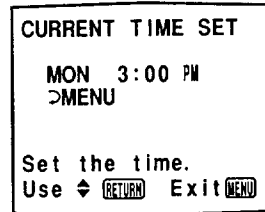

**7** Press  $\Delta+$  or  $\nabla-$  to set the minutes.  
*Each time you press  $\Delta+$  or  $\nabla-$ , the minutes change in sequence.*

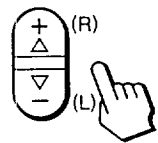

Press RETURN.  
*The setting is completed, and the clock starts.*

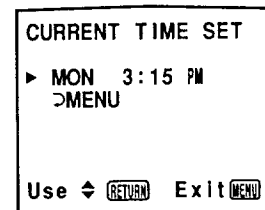
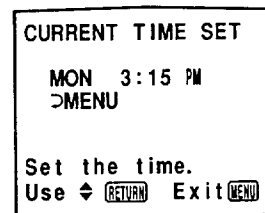

**To reset the time**  
 Press RESET while in the CURRENT TIME screen, and repeat steps 4-7.

**To display the time**  
 Press DISPLAY.

**To return to the normal screen**  
 Press MENU.

**Notes**

- The internal clock of this TV operates on a 12-hour cycle. If a 24-hour cycle number (for instance, 13:00) is entered, it will be cleared when you press RETURN.

12:00 AM stands for midnight.  
 12:00 PM stands for noon.

- All the settings including CURRENT TIME SET will be erased if you unplug the TV or a power failure occurs. Reset the current time by following steps 1-7.



# Using the Timer-Activated Functions

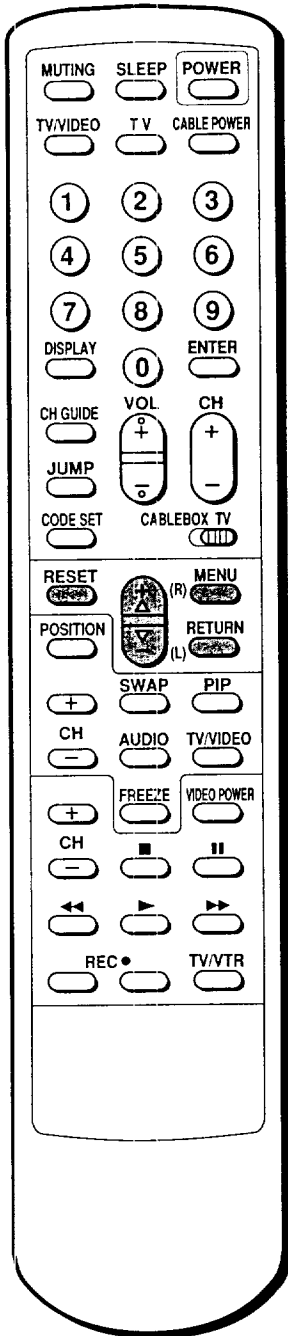

RM-Y118

## Setting the ON/OFF TIMER

With this function you can set your favorite program to appear on the screen at the time that you set.

EXAMPLE: Set the timer to turn on the TV every Monday through Friday at 3:15 PM for 2 hours, on channel 21.

- 1 Press MENU.  
*The main menu appears.*

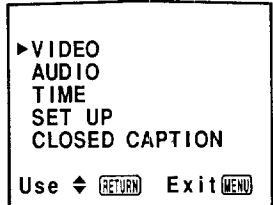

- 2 Press  $\blacktriangleup$  or  $\blacktriangledown$  to select TIME.  
Then press RETURN.  
*The TIME menu appears.*

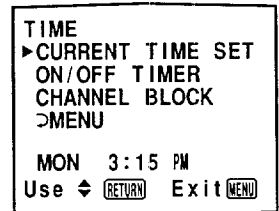
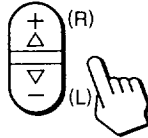

- 3 Press  $\blacktriangleup$  or  $\blacktriangledown$  to select ON/OFF TIMER.  
Then press RETURN.  
*The ON/OFF TIMER screen appears.*

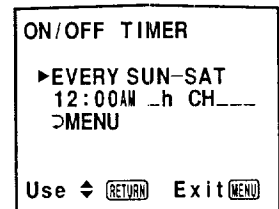
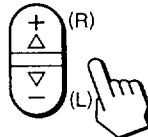

### Note

If the ON/OFF TIMER display appears in black, the current time has not been set and you cannot select ON/OFF TIMER. To set the clock, see "Setting the Clock—CURRENT TIME SET", pp. 44–45.

- 4 Press RETURN again.  
*"Set the day." appears on the screen.*

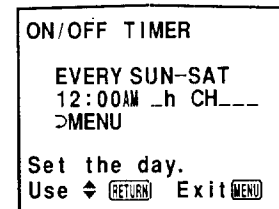



**5** Press  $\Delta+$  or  $\nabla-$  to set the day.  
 Each time you press  $\Delta+$  or  $\nabla-$ , the days of the week change as shown in Fig. 1.  
 Then press RETURN.  
 "Set the time." appears on the screen.

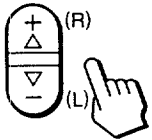

ON/OFF TIMER  
 EVERY MON-FRI  
 12:00AM \_h CH\_---  
 >MENU  
 Set the time.  
 Use  $\blacktriangleleft$  (RETURN) Exit (MENU)

**6** Press  $\Delta+$  or  $\nabla-$  to set the hour that you want the TIMER to start.  
 Each time you press  $\Delta+$  or  $\nabla-$ , the hour changes in sequence.  
 Then press RETURN.

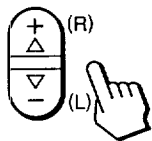

ON/OFF TIMER  
 EVERY MON-FRI  
 3:00PM \_h CH\_---  
 >MENU  
 Set the time.  
 Use  $\blacktriangleleft$  (RETURN) Exit (MENU)

**7** Press  $\Delta+$  or  $\nabla-$  to set the minutes.  
 Each time you press  $\Delta+$  or  $\nabla-$ , the minutes change in sequence.  
 Then press RETURN.  
 "Set the duration." appears on the screen.

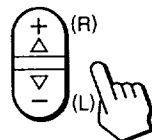

ON/OFF TIMER  
 EVERY MON-FRI  
 3:15PM \_h CH\_---  
 >MENU  
 Set the duration.  
 Use  $\blacktriangleleft$  (RETURN) Exit (MENU)

**8** Press  $\Delta+$  or  $\nabla-$  to set the duration of time.  
 Each time you press  $\Delta+$  or  $\nabla-$ , the duration changes from "1" to "6" in sequence.  
 Then press RETURN.  
 "Select the channel" appears on the screen.

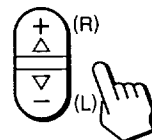

ON/OFF TIMER  
 EVERY MON-FRI  
 3:15PM 2h CH\_---  
 >MENU  
 Select the channel  
 Use  $\blacktriangleleft$  (RETURN) Exit (MENU)

**9** Press  $\Delta+$  or  $\nabla-$  to set the channel that you want the TV to tune in.  
 Each time you press  $\Delta+$  or  $\nabla-$ , the channel number changes from 1 to 125 in sequence.

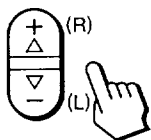

Press RETURN.  
 The setting is completed, and the TIMER indicator on the front of the TV lights up.



ON/OFF TIMER  
 EVERY MON-FRI  
 3:15PM 2h CH 21  
 >MENU  
 Select the channel  
 Use  $\blacktriangleleft$  (RETURN) Exit (MENU)

ON/OFF TIMER  
 ▶EVERY MON-FRI  
 3:15PM 2h CH 21  
 >MENU  
 Use  $\blacktriangleleft$  (RETURN) Exit (MENU)

**To clear the ON/OFF TIMER setting**  
 Press RESET while in the CN/OFF TIMER screen.

**To return to the normal screen**  
 Press MENU.

**Notes**

- While the TIMER is set, the TIMER indicator on the TV is on.
- One minute before the timer goes off, the "TV will turn off" display will appear on the screen.
- All the settings including ON/OFF TIMER will be erased if you unplug the TV or a power failure occurs. Reset the ON/OFF TIMER by following steps 1-9.
- If you have not set the clock correctly, the ON/OFF TIMER will not operate at the proper time. To set the clock, see "Setting the Clock-CURRENT TIME SET", pp. 44-45.

**Fig. 1**  
**Selecting the day(s) of the week**  
 When you press  $\Delta+$ , the days of the week appear in the following order.

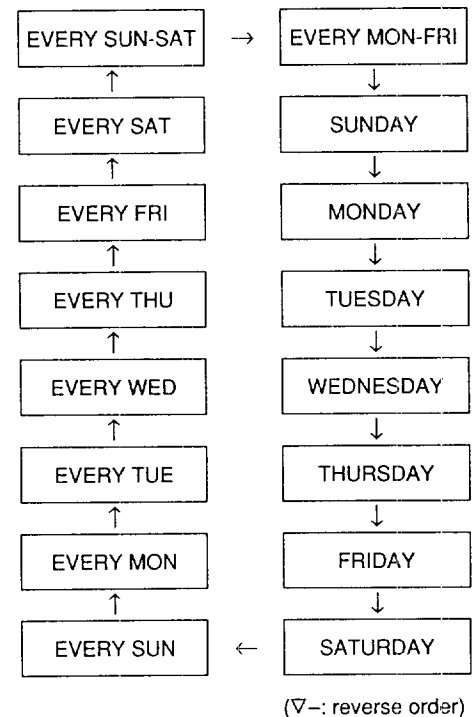

Using the Timer-Activated Functions

# Using the Timer-Activated Functions

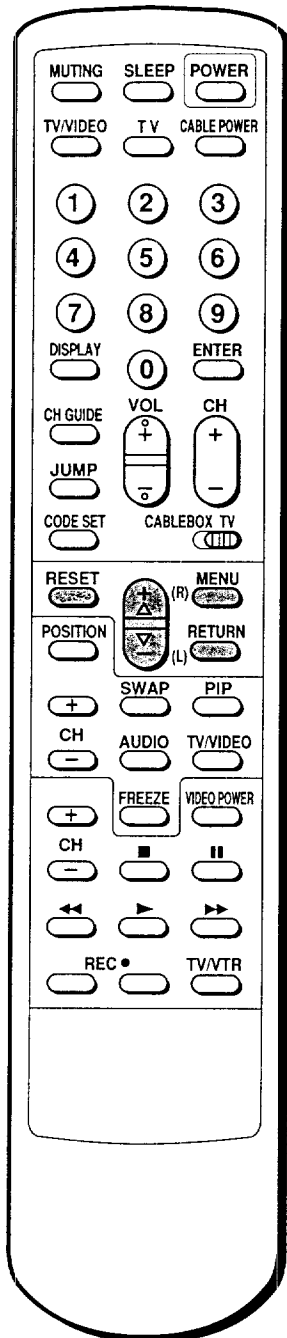

RM-Y118

## Setting CHANNEL BLOCK

Use this function to block a channel from appearing on the screen during the time you specify. You can use this function to prevent children from watching undesirable programs.

EXAMPLE: Set CHANNEL BLOCK every Sunday at 8:45 PM for one hour, on channel 38.

- 1 Press MENU.  
*The main menu appears.*

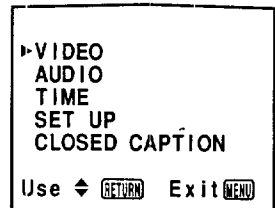

- 2 Press  $\blacktriangleup$  or  $\blacktriangledown$  to select TIME.  
Then press RETURN.  
*The TIME menu appears.*

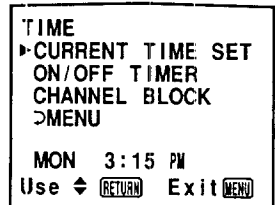
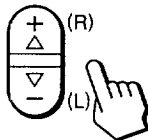

- 3 Press  $\blacktriangleup$  or  $\blacktriangledown$  to select CHANNEL BLOCK.  
Then press RETURN.  
*The CHANNEL BLOCK screen appears.*

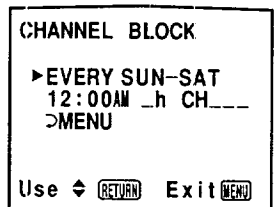
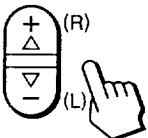

### Note

If the CHANNEL BLOCK display appears in black, the current time has not been set and you cannot select CHANNEL BLOCK. To set the clock, see "Setting the Clock—CURRENT TIME SET", pp. 44–45.

- 4 Press RETURN again.  
*"Set the day." appears on the screen.*

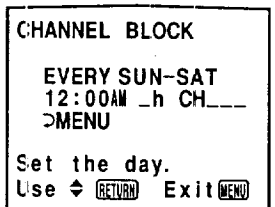



- 5** Press  $\Delta+$  or  $\nabla-$  to set the day.  
 Each time you press  $\Delta+$  or  $\nabla-$ , the days of the week change as shown in Fig. 1. (See p. 47.)  
 Then press RETURN.  
 "Set the time." appears on the screen.

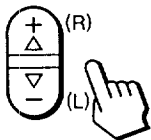

```

CHANNEL BLOCK
EVERY SUNDAY
12:00AM _h CH___
>MENU

Set the time.
Use  $\blacktriangleleft$  (RETURN) Exit (MENU)
  
```

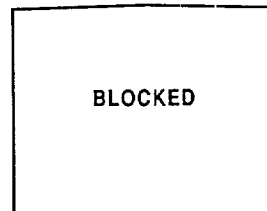

If you select a channel which has been blocked, the message of "BLOCKED" appears.

- 6** Press  $\Delta+$  or  $\nabla-$  to set the hour.  
 Each time you press  $\Delta+$  or  $\nabla-$ , the hour changes in sequence.  
 Then press RETURN.

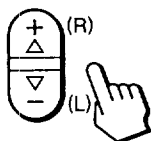

```

CHANNEL BLOCK
EVERY SUNDAY
8:00PM _h CH___
>MENU

Set the time.
Use  $\blacktriangleleft$  (RETURN) Exit (MENU)
  
```

**To clear the BLOCK setting**  
 Press RESET while in the CHANNEL BLOCK screen.

**To return to the normal screen**  
 Press MENU.

**Notes**

- If you set a new CHANNEL BLOCK by following steps 1-9, the original setting will be erased.
- If you have not set the clock correctly, CHANNEL BLOCK will not operate at the proper time. To set the clock, see "Setting the Clock—CURRENT TIME SET", pp. 44-45.

- 7** Press  $\Delta+$  or  $\nabla-$  to set the minutes.  
 Each time you press  $\Delta+$  or  $\nabla-$ , the minutes change in sequence.  
 Then press RETURN.  
 "Set the duration." appears on the screen.

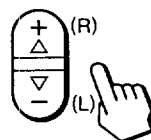

```

CHANNEL BLOCK
EVERY SUNDAY
8:45PM _h CH___
>MENU

Set the duration.
Use  $\blacktriangleleft$  (RETURN) Exit (MENU)
  
```

- 8** Press  $\Delta+$  or  $\nabla-$  to set the duration of time that you want the TV remain blocked.  
 Each time you press  $\Delta+$  or  $\nabla-$ , the duration changes from 1 to 6 in sequence.  
 Then press RETURN.  
 "Select the channel" appears on the screen.

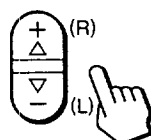

```

CHANNEL BLOCK
EVERY SUNDAY
8:45PM 1h CH___
>MENU

Select the channel
Use  $\blacktriangleleft$  (RETURN) Exit (MENU)
  
```

- 9** Press  $\Delta+$  or  $\nabla-$  to set the channel that you want to block.  
 Each time you press  $\Delta+$  or  $\nabla-$ , the channel number changes from 1 to 125 in sequence.

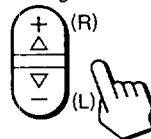

Press RETURN.  
 The setting is completed.



```

CHANNEL BLOCK
EVERY SUNDAY
8:45PM 1h CH 38
>MENU

Select the channel
Use  $\blacktriangleleft$  (RETURN) Exit (MENU)
  
```

```

CHANNEL BLOCK
▶EVERY SUNDAY
8:45PM 1h CH 38
>MENU

Use  $\blacktriangleleft$  (RETURN) Exit (MENU)
  
```

# Customizing the Screen Display

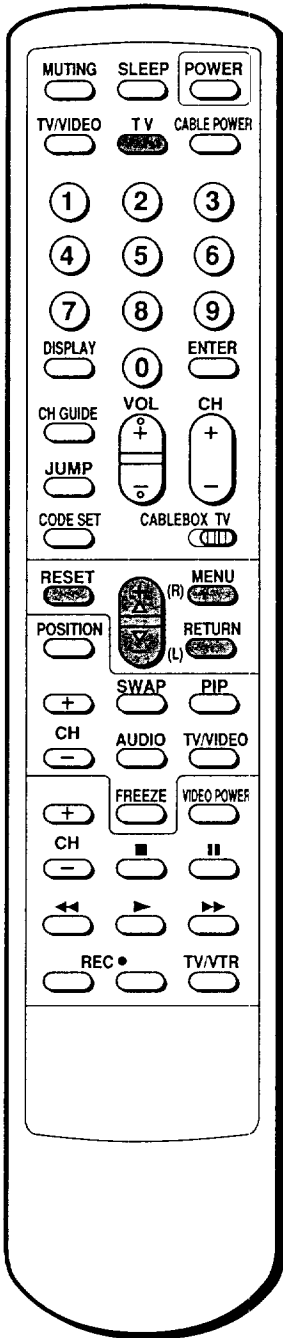

RM-Y118

## Setting Channel Captions — CH CAPTION

Use this feature to caption up to 12 channel number displays with the matching channel call letters.

EXAMPLE: Caption channel 20 with ESPN at the caption position number 4.

- 1 Press MENU.  
*The main menu appears.*

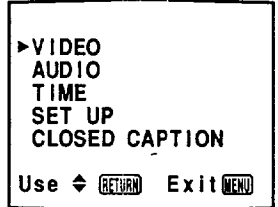

- 2 Press  $\blacktriangleup$  or  $\blacktriangledown$  to select SET UP.  
Then press RETURN.  
*The SET UP menu appears.*

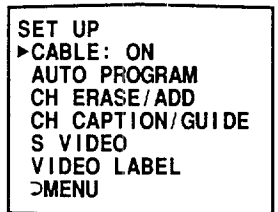
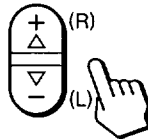

- 3 Press  $\blacktriangleup$  or  $\blacktriangledown$  to select CH CAPTION/GUIDE.  
Then press RETURN.  
*The CH CAPTION/GUIDE screen appears.*

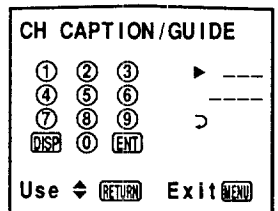
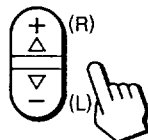

### Note

If the CH CAPTION display appears in black, the TV is in video mode and you cannot select CH CAPTION/GUIDE. Press TV or TV/VIDEO to change to TV mode.

- 4 Press RETURN again.  
*"Select a position." appears on the screen.*

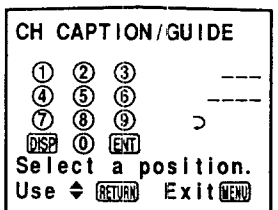



- 5** Press  $\Delta+$  or  $\nabla-$  to select a caption position number.  
 Each time you press  $\Delta+$  or  $\nabla-$ , the caption position number is marked in sequence.  
 Then press RETURN.  
 "Select the channel" appears on the screen.

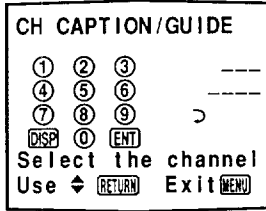
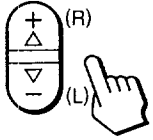

**To erase unneeded captions**  
 Call the caption setting screen by following steps 1-5, and press RESET.

**To return to the normal screen**  
 Press MENU.

- 6** Press  $\Delta+$  or  $\nabla-$  to select the channel you want to caption.  
 Each time you press  $\Delta+$  or  $\nabla-$ , the channel number changes from 1 to 125.  
 Then press RETURN.  
 "Select the letter." appears on the screen.

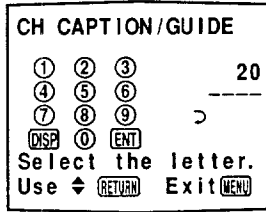
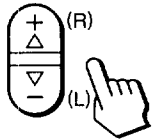

- 7** Press  $\Delta+$  or  $\nabla-$  to select the first letter.  
 Each time you press  $\Delta+$  or  $\nabla-$ , "0-9", "A-Z", "&", "|", "-", and "\_ (blank space)" appear in sequence.

Then press RETURN.

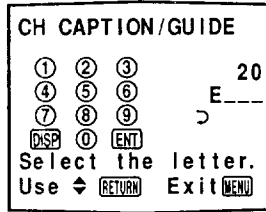
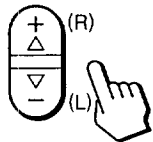

- 8** Repeat step 7 to select each remaining letter.  
 (For a 3-letter caption, leave a space by pressing RETURN only.)

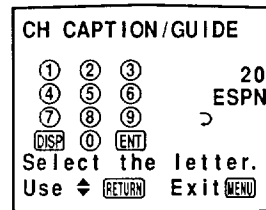
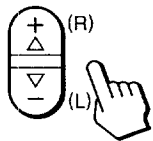

- 9** Press RETURN.  
 The setting is completed.

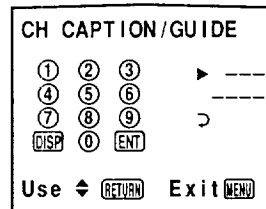

**To caption other channels**  
 Repeat steps 4-9.



Customizing the Screen Display

# Customizing the Screen Display

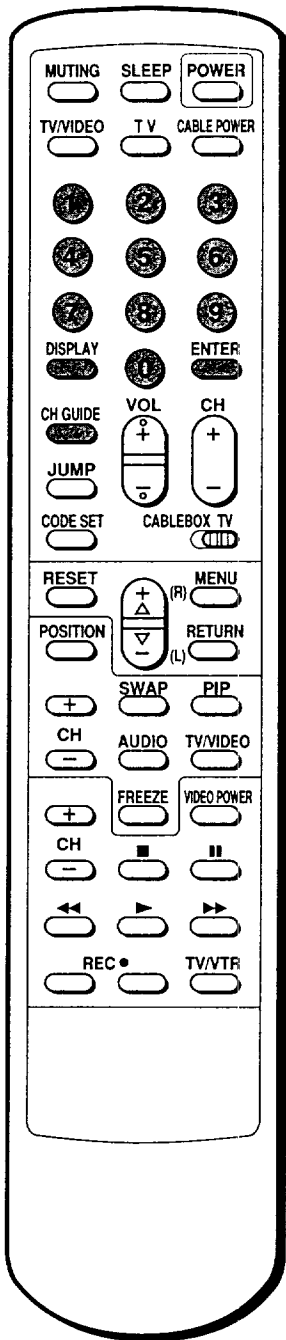

RM-Y118

## Viewing the Captioned Channels — CH GUIDE

Use this feature to display the captions you set, and to select a channel directory for viewing.

- 1 Press CH GUIDE.  
A directory appears, corresponding to the directory keys on the Remote Commander.

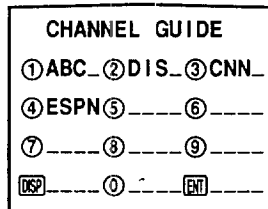

To cancel the CHANNEL GUIDE screen  
Press CH GUIDE again.

- 2 Press the directory key of the channel you want to watch.

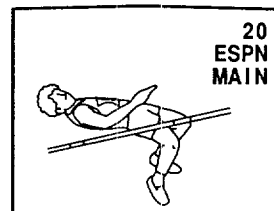
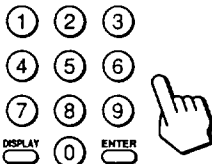

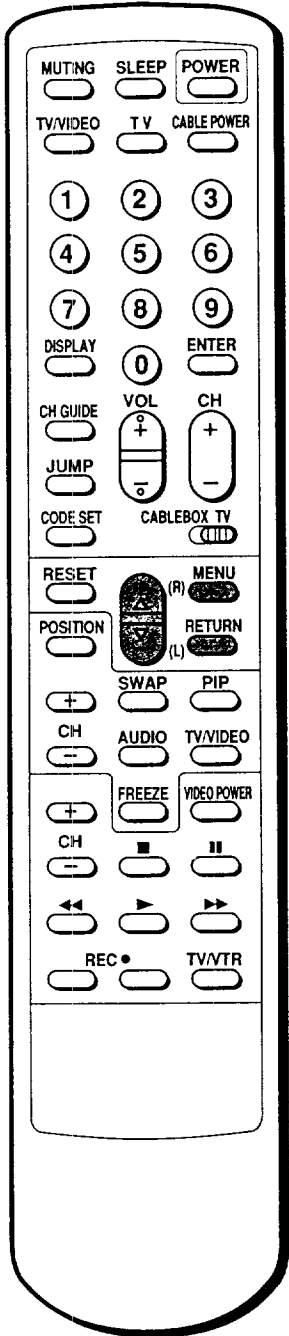

RM-Y118

### Setting VIDEO LABEL (except for KV-27TS29/2970M)

Use this feature to label each input mode in order to identify the equipment connected to each input terminal.

EXAMPLE: Label VIDEO 1 IN as VHS.

- 1 Press MENU.  
*The main menu appears.*

MENU



```

▶VIDEO
AUDIO
TIME:
SET UP
CLOSED CAPTION

```

Use ◀ RETURN Exit MENU

- 2 Press Δ+ or ▽- to select SET UP.

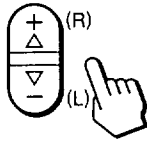

```

VIDEO
AUDIO
TIME:
▶SET UP
CLOSED CAPTION

```

Use ◀ RETURN Exit MENU

- Press RETURN.  
*The SET UP menu appears.*

RETURN



```

SET UP
▶CABLE: ON
AUTO PROGRAM
CH ERASE/ADD
CH CAPTION/GUIDE
S VIDEO: ON
▶VIDEO LABEL
>MENU

```

- 3 Press Δ+ or ▽- to select VIDEO LABEL.

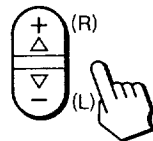

```

SET UP
CABLE: ON
AUTO PROGRAM
CH ERASE/ADD
CH CAPTION/GUIDE
S VIDEO: ON
▶VIDEO LABEL
>MENU

```

- Press RETURN.  
*The VIDEO LABEL screen appears.*

RETURN



```

VIDEO LABEL
▶VIDEO1: VIDEO1
VIDEO2: VIDEO2
VIDEO3: VIDEO3
>MENU

```

Use ◀ RETURN Exit MENU



Customizing the Screen Display

# Customizing the Screen Display

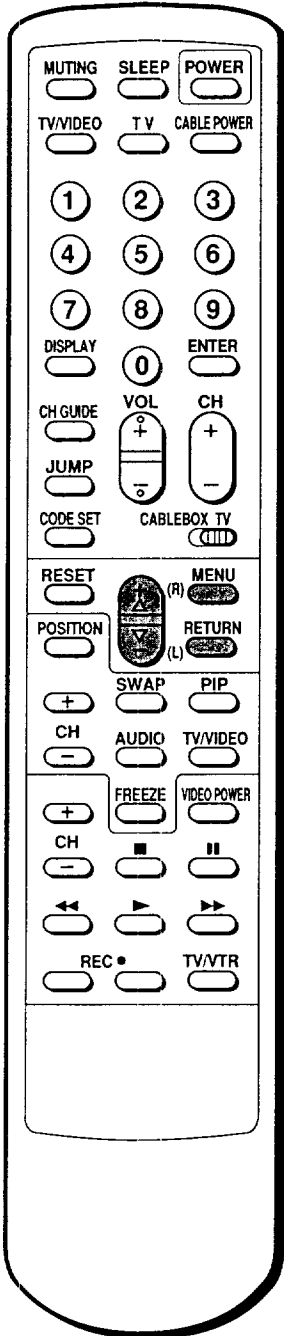

RM-Y118

To return to the normal screen  
Press MENU.

**4** Press  $\Delta+$  or  $\nabla-$  to select the input mode you want to label.

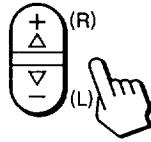

Press RETURN.

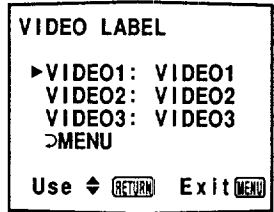

**5** Press  $\Delta+$  or  $\nabla-$  to select VHS.

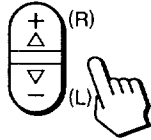

Each time you press  $\Delta+$ , the label changes:

**VIDEO 1**

VIDEO 1  $\rightarrow$  S VIDEO  $\rightarrow$  BETA  $\rightarrow$  8 mm  $\rightarrow$  VHS  $\rightarrow$  LD

**VIDEO 2**

VIDEO 2  $\rightarrow$  BETA  $\rightarrow$  8 mm  $\rightarrow$  VHS  $\rightarrow$  LD

**VIDEO 3**

VIDEO 3  $\rightarrow$  BETA  $\rightarrow$  8 mm  $\rightarrow$  VHS  $\rightarrow$  LD

( $\nabla-$ : reverse order)

Press RETURN.

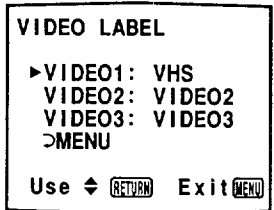
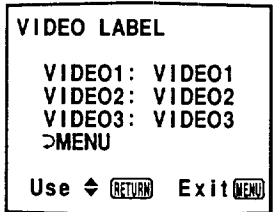

**To label other input modes**  
Repeat steps 4–5.

# Using the Pre-Programmed Remote Commander (except for KV-27TS29/2970M)

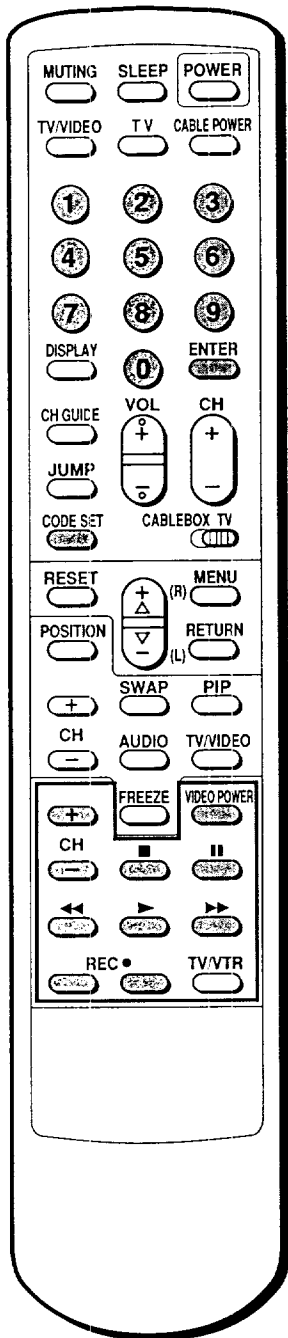

RM-Y118

You can operate your video equipment and cable converter box that has an infrared remote detector with this supplied pre-programmed Remote Commander.

## Operating Sony or Non-Sony Video Equipment—Pre-Programmed Function

With the supplied Remote Commander, you can operate a Sony video cassette recorder (Beta, 8 mm, VHS) or a multi disc player as well as most non-Sony video equipment connected to your TV by following the steps below.

- 1 While pressing CODE SET, press 0 - 9 to enter the manufacturer's code number (see chart on p. 56). For example, to operate a Sony 8 mm VCR, press 0, 2 and ENTER.

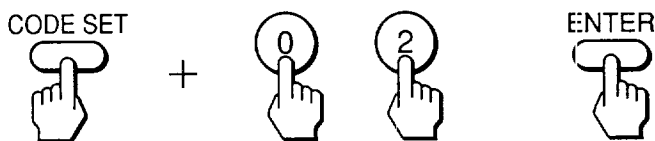

- 2 Use the video operating buttons on the Remote Commander to operate the video equipment.

### Operating a VCR

To turn on or off  
 To change channels (when watching TV programs through the VCR's tuner)  
 To record  
 To play  
 To stop  
 To fast forward  
 To rewind the tape  
 To pause  
 To search the picture forward and backward

Press VIDEO POWER.  
 Press CH +/-.

Press ● (2 buttons simultaneously).  
 Press ►.  
 Press ■.  
 Press ►►.  
 Press ◄◄.  
 Press ||.  
 Press ►► or ◄◄ during playback.

### Operating a Video Disc Player

To play  
 To stop  
 To pause  
  
 To search the picture forward and backward

Press ►.  
 Press ■.  
 Press ||.  
*To resume normal playback, press again.*  
 \*This function is effective only for CAV (standard-play disc). With CLV (extended-play disc), the TV will go into the standby mode if || is pressed.  
 Keep pressing ►► or ◄◄ during playback.  
*To resume normal playback, release the button.*



Customizing the Screen Display Using the Pre-Programmed Remote Commander

# Using the Pre-Programmed Remote Commander

## Manufactures and Code Numbers (VCR/video disc player)

Manufacturer	Code Numbers
SONY	01, 02, 03, 04
CANON	05
EMERSON	22, 30, 33
FISHER	10, 11, 12, 15
FUNAI	29
GENERAL ELECTRIC	05, 08
GOLDSTAR	25
HITACHI	07, 08
JVC	16
MAGNAVOX	05, 06, 09
MITSUBISHI	18, 19, 26, 27
MULTITECH	29
NEC	16, 23, 31
PANASONIC	05, 06
PHILCO	05, 06
PHILIPS	05, 06, 09
QUASAR	05, 06
RCA	07, 08
SAMSUNG	24, 32
SANYO	11, 15
SCOTT	21
SHARP	13, 14
SHINTOM	34
SYLVANIA	05, 06, 09
SYMPHONIC	29
TEKNIKA	28, 29
TOSHIBA	20, 21
TOTE VISION	25
ZENITH	17

### Notes

- If more than one code number is listed for manufacturers other than Sony, try entering them one by one, until you come to the correct code for your equipment.
- If the video equipment does not have a certain function, the corresponding button on this Remote Commander will not operate.
- In some rare cases, you may not be able to operate your non-Sony video equipment with the supplied Remote Commander. This is because your equipment may use a code that is not provided with this Remote Commander. In this case, please use the equipment's own remote control unit.

### CAUTION

When you remove the batteries from the Remote Commander, all the settings will revert to the Sony Beta setting. Reset the codes by following the steps on p. 55.

The code numbers for Sony equipment are assigned as follows:

- 01 ..... Beta, ED Beta VCR
- 02 ..... 8 mm VCR
- 03 ..... VHS VCR
- 04 ..... Video disc player



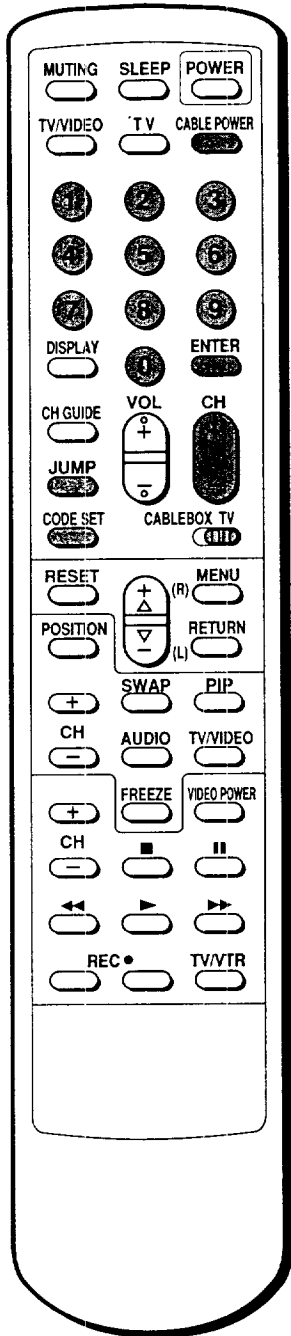

RM-Y118

## Operating a Cable Converter Box

Follow these instructions to set the manufacturer's code which will enable you to operate a connected cable converter box with the pre-programmed Remote Commander.

EXAMPLE: Operate a connected Zenith cable converter box.

- 1 Set the CABLEBOX-TV selector to CABLEBOX.



### Notes

- If more than one code number is listed, try entering them one by one until you come to the correct code for your equipment.
- If you enter a new code number, the code number you previously entered at that setting is erased.
- In some rare cases, your equipment may use a code that is not provided with this Remote Commander and you may not be able to operate your cable converter box with the supplied Remote Commander. In this case, use the equipment's own remote control unit.

- 2 While pressing CODE SET, press 6 and 8 (Zenith's code number -see chart below) and ENTER.

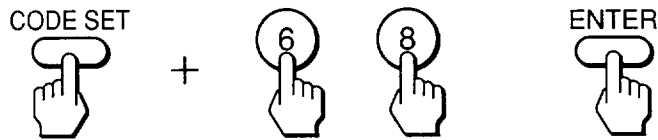

- 3 Use CABLE POWER and the TV control buttons (0 -- 9, ENTER, JUMP and CH +/-) to operate the cable converter box.

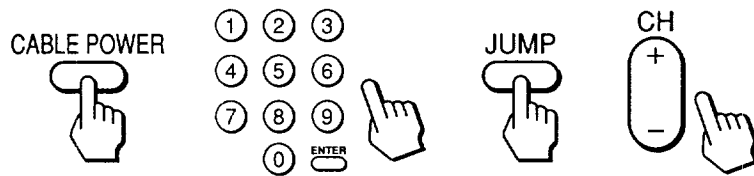

### To operate the TV

Set the CABLEBOX-TV selector to TV, then use the TV control buttons to control the TV.

### For more details on operating the cable box

Refer to the operating instructions that come with the cable box.

### Manufactures and Code Numbers (cable box)

Manufacturer	Code number
JERROLD	60, 61, 62, 63, 64, 65
PIONEER	69, 70
SCIENTIFIC ATLANTA	66, 67
TOCOM	71, 72
ZENITH	68

**Television system** American TV standards

**Channel coverage** VHF: 2–13  
UHF: 14–69  
Cable TV: 1–125

**Picture tube** Microblack™ Trinitron® tube  
27-inch picture measured diagonally  
29-inch picture tube measured diagonally (KV-27TS29/27TS32/27TS36/27TW77/27TW78/2970M/2975M)

32-inch picture measured diagonally  
34-inch picture tube measured diagonally (KV-32TS36/32TS46/32TW77/32TW78)

**Antenna** 75-ohm external antenna terminal for VHF/UHF

**Input** VIDEO and S VIDEO  
S VIDEO IN (S terminal)  
Y: 1 Vp-p, 75-ohms unbalanced, sync negative  
C: 0.286 Vp-p (Burst signal)

Video  
7  
r  
Audio  
(  
li

**Output** AUDIO  
More  
max  
More  
Imped

**Speaker output** 5 W × 2

**Power requirements** 120 V A

**Power consumption**

KV-27TS29	16
KV-27TS32	16
KV-27TS36	17
KV-32TS36	19
KV-32TS46	20
KV-27TW77	17
KV-27TW78	17
KV-32TW77	19
KV-32TW78	19
KV-2970M	16
KV-2975M	17

standby mode

**Dimensions/Weight**

	Dimensions (w/h/d)	Mass
KV-27TS29	661 × 603 × 522 mm (26 <sup>1</sup> / <sub>8</sub> × 23 <sup>3</sup> / <sub>4</sub> × 20 <sup>5</sup> / <sub>8</sub> in.)	42.3 kg (93 lbs 5 oz)
KV-27TS32	661 × 603 × 522 mm (26 <sup>1</sup> / <sub>8</sub> × 23 <sup>3</sup> / <sub>4</sub> × 20 <sup>5</sup> / <sub>8</sub> in.)	42.3 kg (93 lbs 5 oz)
KV-27TS36	661 × 603 × 522 mm (26 <sup>1</sup> / <sub>8</sub> × 23 <sup>3</sup> / <sub>4</sub> × 20 <sup>5</sup> / <sub>8</sub> in.)	42.3 kg (93 lbs 5 oz)
KV-32TS36	781 × 712 × 612 mm (30 <sup>3</sup> / <sub>4</sub> × 28 <sup>1</sup> / <sub>8</sub> × 24 <sup>1</sup> / <sub>8</sub> in.)	71 kg (156 lbs 9 oz)
KV-32TS46	781 × 712 × 612 mm (30 <sup>3</sup> / <sub>4</sub> × 28 <sup>1</sup> / <sub>8</sub> × 24 <sup>1</sup> / <sub>8</sub> in.)	71 kg (156 lbs 9 oz)
KV-27TW77	750 × 1041 × 655 mm (29 <sup>5</sup> / <sub>8</sub> × 41 × 25 <sup>7</sup> / <sub>8</sub> in.)	83.6 kg (184 lbs)
KV-27TW78	750 × 1041 × 655 mm (29 <sup>5</sup> / <sub>8</sub> × 41 × 25 <sup>7</sup> / <sub>8</sub> in.)	83.6 kg (184 lbs)
KV-32TW77	895 × 1117 × 700 mm (35 <sup>1</sup> / <sub>4</sub> × 44 × 27 <sup>5</sup> / <sub>8</sub> in.)	108.6 kg (239 lbs)
KV-32TW78	895 × 1117 × 700 mm (35 <sup>1</sup> / <sub>4</sub> × 44 × 27 <sup>5</sup> / <sub>8</sub> in.)	108.6 kg (239 lbs)
		42.3 kg (93 lbs 5 oz)
		42.3 kg (93 lbs 5 oz)

Model RM-Y116 (1)  
3) batteries

Model RM-Y117 (1)  
3) battery  
32TS36/32TS46/27TW77/  
/32TW78)  
Model RM-Y118 (1)  
3) battery

Refer

3

3S, VMC-720M,  
3K-74A

change without

# Troubleshooting

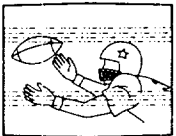
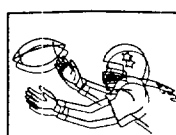
Symptom	Possible causes and remedies
Poor or no picture (screen not lit), good sound	<ul style="list-style-type: none"> <li>• Adjust PICTURE.</li> <li>• Adjust BRIGHTNESS.</li> <li>• Check antenna/cable connections.</li> </ul>
Good picture, no sound	<ul style="list-style-type: none"> <li>• Press VOLUME + on the TV or VOL + on the Remote Commander.</li> <li>• Press MUTING on the Remote Commander.</li> <li>• Check that the MTS setting is set correctly.</li> <li>• Check that the TV/VIDEO button is set correctly.</li> <li>• Check that SPEAKER is set to ON.</li> </ul>
No picture (screen not lit), no sound	<ul style="list-style-type: none"> <li>• Is POWER switched on ?</li> <li>• Check the power cord connection.</li> <li>• Check that the TV/VIDEO button is set correctly.</li> <li>• Check that S VIDEO is set to ON.</li> </ul>
No color	<ul style="list-style-type: none"> <li>• Is it a color program ?</li> <li>• Adjust COLOR.</li> </ul>
Snow and noise only	<ul style="list-style-type: none"> <li>• Is it an active or the correct channel ?</li> <li>• Check the CABLE setting.</li> <li>• Check antenna/cable connections.</li> </ul>
 <p>Dotted lines or stripes</p>	<p>This is often caused by local interference. (e.g. cars, neon signs, hairdryers etc.) Adjust the antenna for minimum interference.</p>
 <p>Double images or ghosts</p>	<p>Reflections from nearby mountains or buildings often cause this problem. A highly directional outdoor antenna or a CATV cable may improve the picture.</p>
<p>Try another channel. It could be station trouble.</p>	

If the problem persists, contact your nearest service facility.



Specifications  
Troubleshooting

