

Technics

Compact disc changer
SL-PD967/SL-PD867/
SL-P9066

Operating Instructions

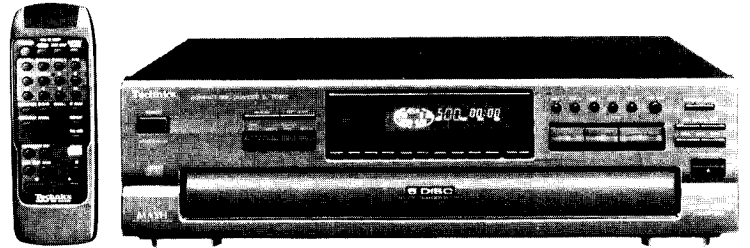

The photograph shows the SL-PD867 model.

COMPACT
disc
DIGITAL AUDIO

Before connecting, operating or adjusting this product, please read these instructions completely.

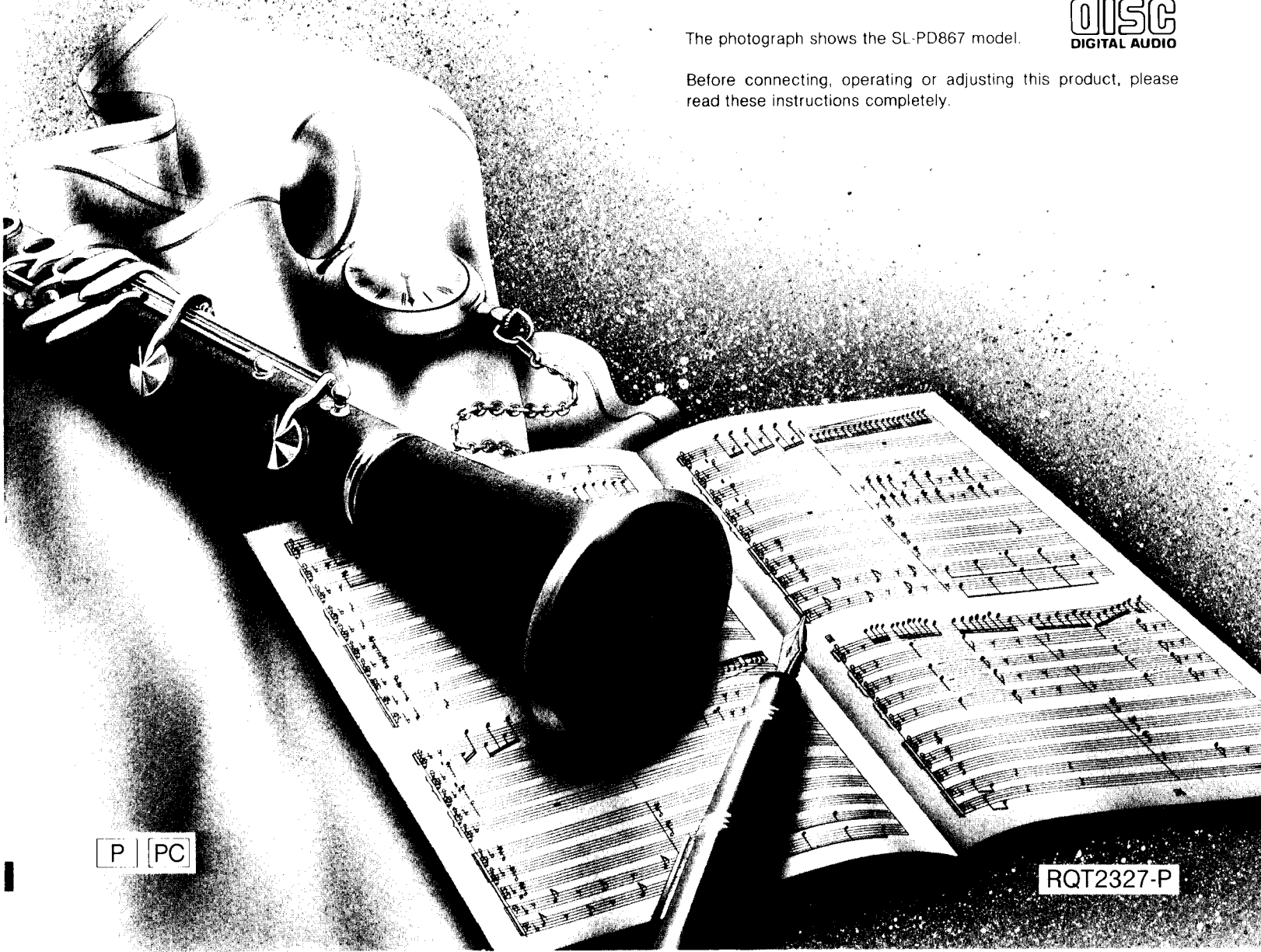

Dear Customer

Thank you for purchasing this Technics product. For optimum performance and safety, please read these instructions carefully.

These operating instructions are applicable to the SL-PD967, SL-PD867 and SL-P9066 models. These operating instructions, however, fundamentally explain the operation of SL-PD967 model.

The model number and serial number of this product can be found on either the back or the bottom of the unit. Please note them in the space provided below and retain them for future reference.

MODEL NUMBER
SERIAL NUMBER

Table of Contents

Before use

Precautions	4
Front panel controls	5
Connections	6

Operations

Basic operations	7
Sequential play	7
To directly access a desired track	8
To exchange discs during play	8
To temporarily stop play	8
To stop play	8
Program play	9
Using the remote control transmitter	
SL-PD967/SL-PD867 only	10
Random play	10
One disc random play	10
Full random play	10
Delete play	11
Using the remote control transmitter	
SL-PD967/SL-PD867 only	12
Spiral play	12
ID scan function	13
Search function	13
Skip function	14
To skip discs	14
To skip tracks	14
Repeat function	15
Time mode selection	15
Edit guide function	16
Pitch control function SL-PD967 only	17
Auto cue function SL-PD967 only	18

Reference

Concerning compact discs	18
Troubleshooting guide	19
Product service	19
Cautions concerning the moving of this unit	Back cover
Technical specifications	Back cover

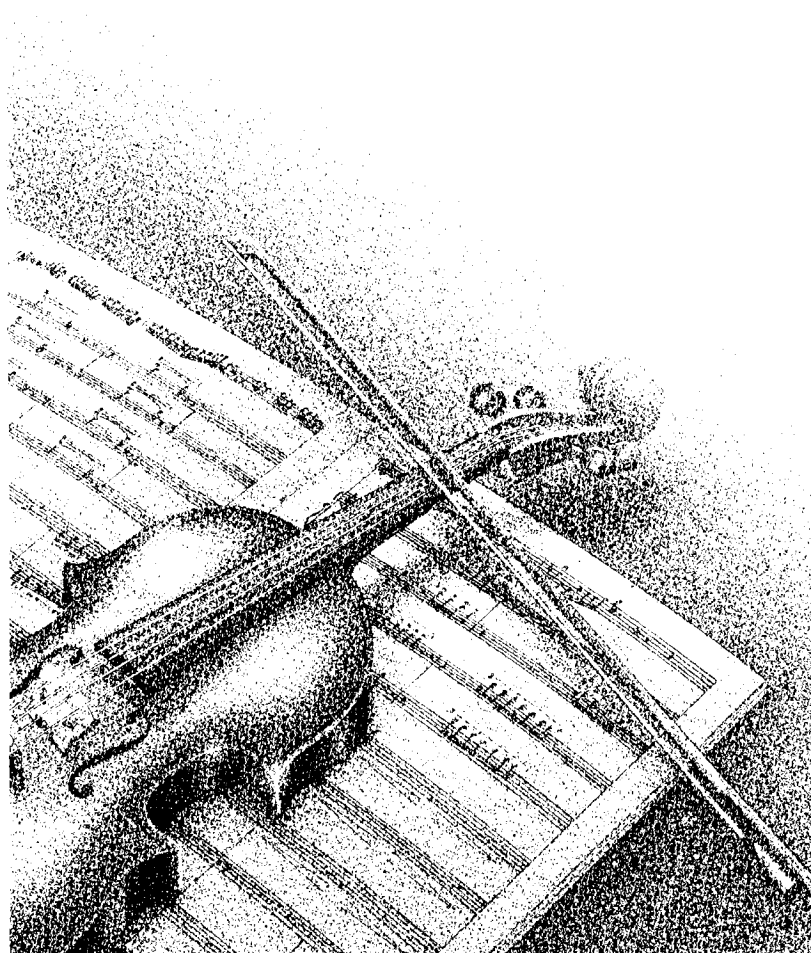

This device complies with Part 15 of the FCC Rules. Operation is subject to the following two conditions: (1) This device may not cause harmful interference, and (2) this device must accept any interference received, including interference that may cause undesired operation.

CAUTION:

This equipment has been tested and found to comply with the limits for a Class B digital device, pursuant to Part 15 of the FCC Rules. These limits are designed to provide reasonable protection against harmful interference in a residential installation. This equipment generates, uses and can radiate radio frequency energy and, if not installed and used in accordance with the instructions, may cause harmful interference to radio communications. However, there is no guarantee that interference will not occur in a particular installation. If this equipment does cause harmful interference to radio or television reception, which can be determined by turning the equipment off and on, the user is encouraged to try to correct the interference by one of the following measures:

- Reorient or relocate the receiving antenna.
- Increase the separation between the equipment and receiver.
- Connect the equipment into an outlet on a circuit different from that to which the receiver is connected.
- Consult the dealer or an experienced radio/TV technician for help.

Any unauthorized changes or modifications to this equipment would void the user's authority to operate this device.

CAUTION:
**TO PREVENT ELECTRIC SHOCK MATCH
WIDE BLADE OF PLUG TO WIDE SLOT,
FULLY INSERT.**

WARNING:
**TO REDUCE THE RISK OF FIRE OR
ELECTRIC SHOCK, DO NOT EXPOSE THIS
APPLIANCE TO RAIN OR MOISTURE.**



**CAUTION: TO REDUCE THE RISK OF ELECTRIC
SHOCK, DO NOT REMOVE SCREWS.
NO USER-SERVICEABLE PARTS
INSIDE.
REFER SERVICING TO QUALIFIED
SERVICE PERSONNEL.**



The lightning flash with arrowhead symbol, within an equilateral triangle, is intended to alert the user to the presence of uninsulated "dangerous voltage" within the product's enclosure that may be of sufficient magnitude to constitute a risk of electric shock to persons.



The exclamation point within an equilateral triangle is intended to alert the user to the presence of important operating and maintenance (servicing) instructions in the literature accompanying the appliance.

Precautions

Before using this unit please read these operating instructions carefully. Take special care to follow the warnings indicated on the unit itself as well as the safety suggestions listed below. Afterwards keep them handy for future reference.

Safety

- 1. Power Source** -- The unit should be connected to power supply only of the type described in the operating instructions or as marked on the unit.
- 2. Polarization** -- If the unit is equipped with a polarized AC power plug (a plug having one blade wider than the other), that plug will fit into the AC outlet only one way. This is a safety feature. If you are unable to insert the plug fully into the outlet, try reversing the plug. If the plug should still fail to fit, contact your electrician to replace your obsolete outlet. Do not defeat the safety purpose of the polarized plug.
- 3. Power Cord Protection** -- AC power supply cords should be routed so that they are not likely to be walked on or pinched by items placed upon or against them. Never take hold of the plug or cord if your hand is wet, and always grasp the plug body when connecting or disconnecting it.
- 4. Nonuse Periods** -- When the unit is not used, turn the power off. When left unused for a long period of time, the unit should be unplugged from the household AC outlet.

Installation

Environment

- 1. Water and Moisture** -- Do not use this unit near water – for example, near a bathtub, washbowl, swimming pool, or the like. Damp basements should also be avoided.
- 2. Condensation** -- Moisture may form on the lens in the following cases...
 - immediately after a heater has been turned on.
 - in a steamy or very humid room.
 - when the unit is suddenly moved from a cold environment to a warm one.If moisture forms inside this unit, it may not operate properly. To correct this problem, turn on the power and wait about one hour for the moisture to evaporate.
- 3. Heat** -- The unit should be situated away from heat sources such as radiators and the like. It also should not be placed in temperatures less than 5°C (41°F) or greater than 35°C (95°F).

Placement

- 1. Ventilation** -- The unit should be situated so that its location or position does not interfere with its proper ventilation. Allow 10 cm (4") clearance from the rear of the unit.
- 2. Foreign Material** -- Care should be taken so that objects do not fall into and liquids are not spilled into the unit. Do not subject this unit to excessive smoke, dust, mechanical vibration, or shock.
- 3. Magnetism** -- The unit should be situated away from equipment or devices that generate strong magnetism.
- 4. Stacking** -- Do not place heavy objects, other than system components, on top of the unit.
- 5. Surface** -- Place the unit on a flat, level surface.

- 6. Carts and Stands** -- The unit should be used only with a cart or stand that is recommended by the manufacturer.

The unit and cart combination should be moved with care.

Quick stops, excessive force, and uneven surfaces may cause the unit and cart combination to overturn.



- 7. Wall or Ceiling Mounting** -- The unit should not be mounted to a wall or ceiling, unless specified in this operating instructions.

Maintenance

Clean the cabinet, panel and controls with a soft cloth lightly moistened with mild detergent solution.

Do not use any type of abrasive pad, scouring powder or solvent such as alcohol or benzine.

Service

- 1. Damage Requiring Service** -- The unit should be serviced by qualified service personnel when:
 - (a) The AC power supply cord or the plug has been damaged; or
 - (b) Objects have fallen or liquid has been spilled into the unit; or
 - (c) The unit has been exposed to rain; or
 - (d) The unit does not appear to operate normally or exhibits a marked change in performance; or
 - (e) The unit has been dropped, or the enclosure damaged.
- 2. Servicing** -- The user should not attempt to service the unit beyond that described in the operating instructions. All other servicing should be referred to qualified service personnel.

CAUTION:

- This digital apparatus does not exceed the Class B limits for radio noise emissions from digital apparatus set out in the Radio Interference Regulations of the Canadian Department of Communications.
- THIS PRODUCT UTILIZES A LASER.
USE OF CONTROLS OR ADJUSTMENTS OR PERFORMANCE OF PROCEDURES OTHER THAN THOSE SPECIFIED HEREIN MAY RESULT IN HAZARDOUS RADIATION EXPOSURE.
DO NOT OPEN COVERS AND DO NOT REPAIR YOURSELF.
REFER SERVICING TO QUALIFIED PERSONNEL.

Front panel controls

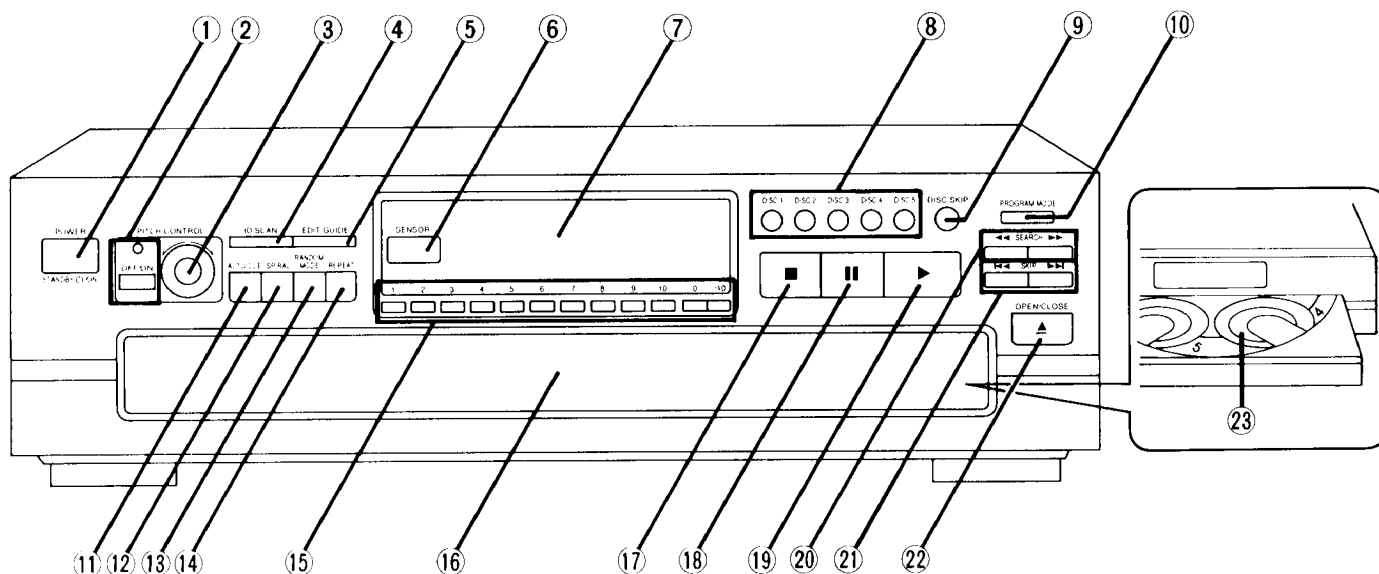

No.	Name	Ref. page
1	Power “STANDBY ⏻ /ON” switch (POWER, STANDBY ⏻ /ON)	7
	Press to switch the unit from on to standby mode or vice versa. In standby mode, the unit is still consuming a small amount of power.	
2	Pitch control button/indicator (PITCH CONTROL, OFF/ON) SL-PD967 only	17
3	Pitch control knob (PITCH CONTROL, -, +) SL-PD967 only	17
4	ID scan button (ID SCAN)	13
5	Edit guide button (EDIT GUIDE)	16
6	Remote control signal sensor (SENSOR)	
7	Display	
8	Disc buttons (DISC 1–5)	7
9	Disc skip button (DISC SKIP)	7,14
10	Program mode button (PROGRAM MODE)	9,11
11	for SL-PD967 Auto cue button (AUTO CUE)	18
	for SL-PD867/SL-P9066 Time mode button (TIME MODE)	15

No.	Name	Ref. page
12	Spiral button (SPIRAL)	12
13	Random mode button (RANDOM MODE)	10
14	Repeat button (REPEAT)	15
15	Numeric buttons (1–10, 0, >10)	8
16	Loading drawer	7
17	Stop button (■)	8
18	Pause button (⏸)	8
19	Play button (▶)	8
20	Search buttons (◀◀ SEARCH ▶▶)	13
21	Skip buttons (◀◀ SKIP ▶▶)	14
22	Loading drawer open/close button (▲ OPEN/CLOSE)	7
23	Disc trays (1–5)	7

Connections

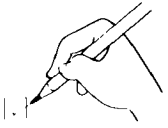

Please check and identify the supplied accessories

AC power supply cord [1]
(For USA SJA175-1)
(For Canada SJA175)

Stereo connection cable [1]
(SJP2249-6)

SL-PD967/SL-PD867 only

Remote control transmitter [1]
(RAK-SL122WH)

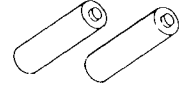
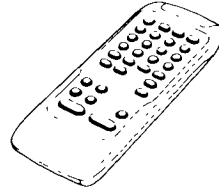
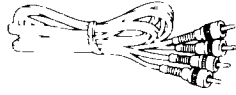
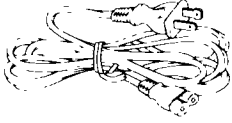

Batteries [2]
(UM-4, "AAA", R03)



For instructions on preparation and operation of the remote control transmitter, refer to the separate booklet titled "How to use the remote control transmitter"

Before connecting the changer to your audio system, make sure that the power of the changer and all other system components are turned off

Stereo connection cable

White (L) 
Red (R) 

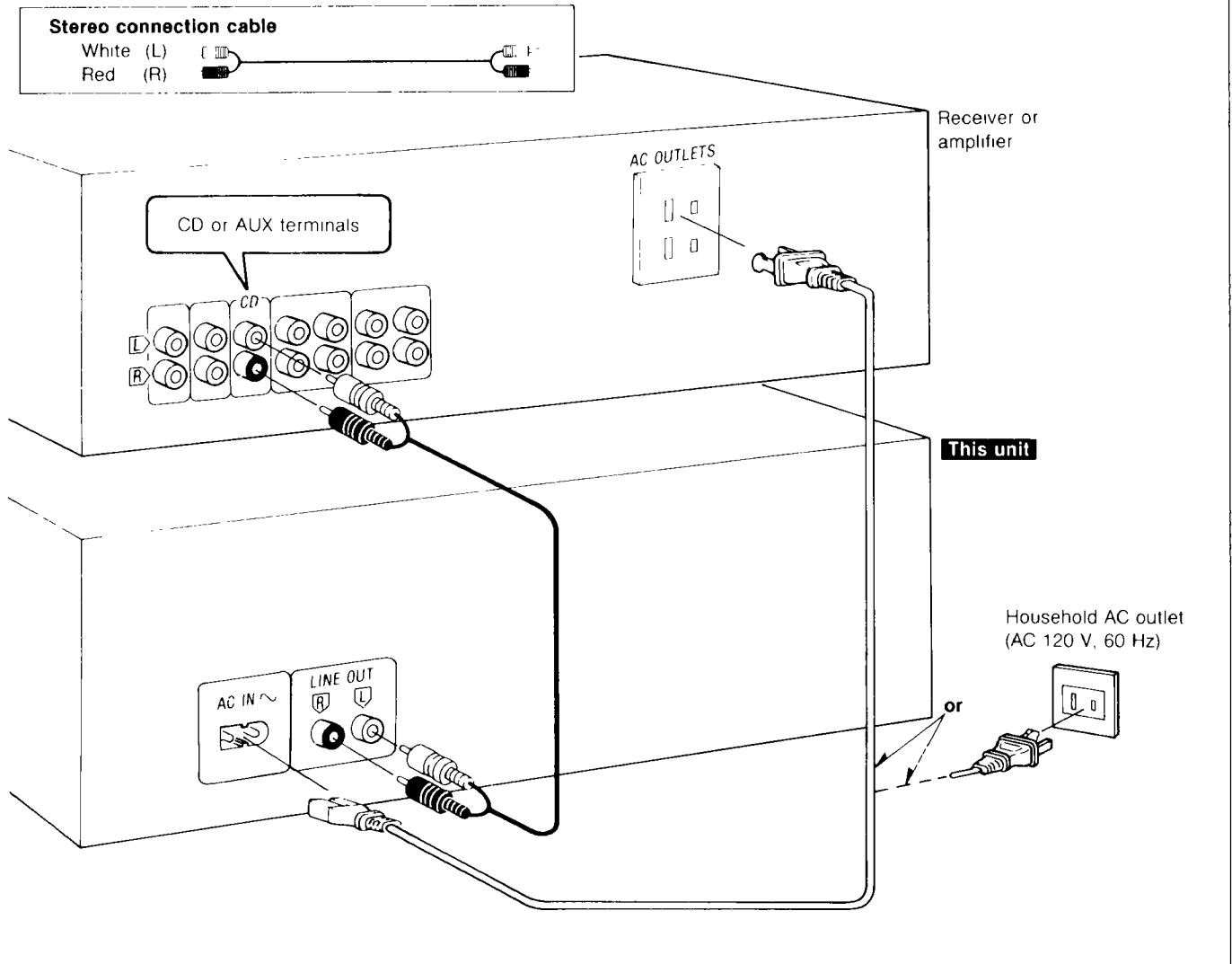

Basic operations

Sequential play

All of the discs will be played, beginning from track 1 on the selected disc.

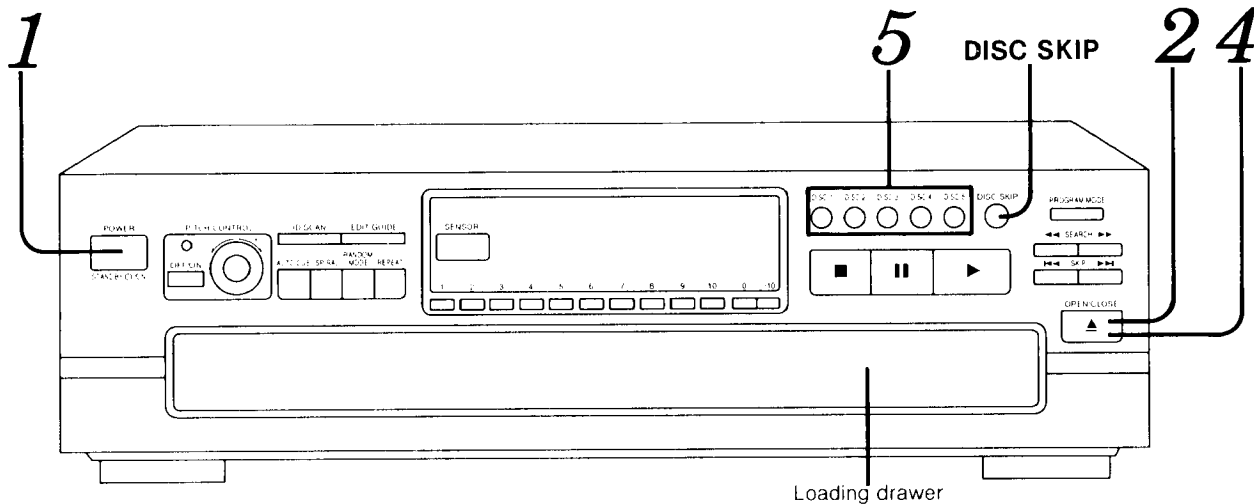

The explanation below is an example of operation in the case where all five disc trays in the changer are holding CDs.

1 **POWER** Press **POWER**.
The unit will switch on.

2 **OPEN/CLOSE** Press **OPEN/CLOSE** to open the loading drawer.
Indicates that the loading drawer is open.

Numbers of the trays in which discs are loaded.

3 **Load the disc(s) on the disc tray(s).**
The discs can be loaded two at a time by pressing **DISC SKIP** to rotate the carousel.

Note
Do not load 3" (8 cm) and 5" (12 cm) discs on the same disc tray.

CAUTION
Do not touch the loading drawer and carousel while they are in motion, and do not attempt to rotate the carousel by hand; doing so could result in incorrect operation of the unit and/or damage to the discs.

4 **OPEN/CLOSE** Press **OPEN/CLOSE** again to close the loading drawer.
Note
Do not attempt to close the drawer by hand.

Current play position (The numeral illuminates with a red color.)

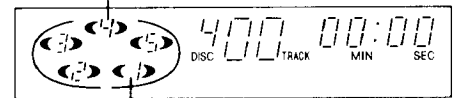

Illuminates when a disc is in the disc tray. If there is no disc in the disc tray, the indication disappears when the disc tray comes to the play position.

5 Press the desired disc button (1–5).
Play will begin from the selected disc.
If a disc is not on the selected disc tray, the changer plays the disc at the next number.

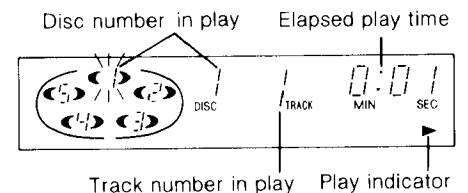

SL-PD967 only
The illumination of a disc button indicates that there is a disc in the corresponding tray. During play, the illumination color will change to green.

The changer plays all the tracks on all the discs in order and stops automatically when the last track on the last disc finishes playing. The first disc will then be at the playing position.

Basic operations (continued)

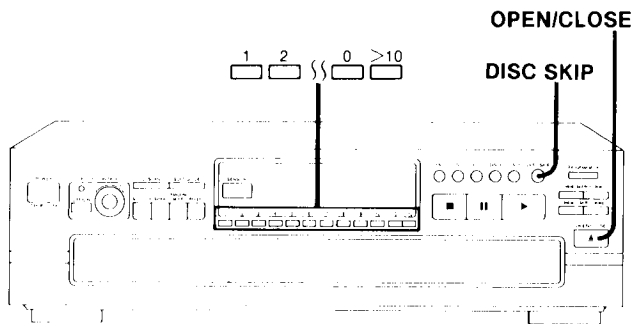

To directly access a desired track

Press the numeric button(s) to select the track.

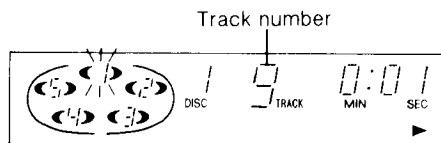

- To select a track between 1 and 10:**
Press the corresponding number on the numeric button.
- To select a two-digit track number over 10:**
First press >10, and then press the numbers for the two digits.
- For example; number 20:**
Press >10, then 2, and then 0.

To exchange discs during play

While playing a disc, it is possible to change the other discs without interrupting play.

1. Press **OPEN/CLOSE** to open the loading drawer.

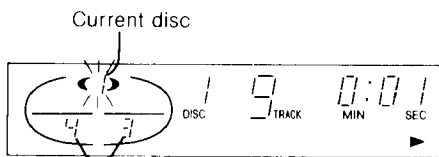

Discs which can be changed.

2. Press **DISC SKIP** to rotate the disc trays and exchange the discs.
The carousel will move by one disc tray. Pressing again moves the carousel in the opposite direction by two disc trays.
3. Press **OPEN/CLOSE** to close the loading drawer.

Note

If you play a disc with the loading drawer open, discs other than the current disc cannot be played.

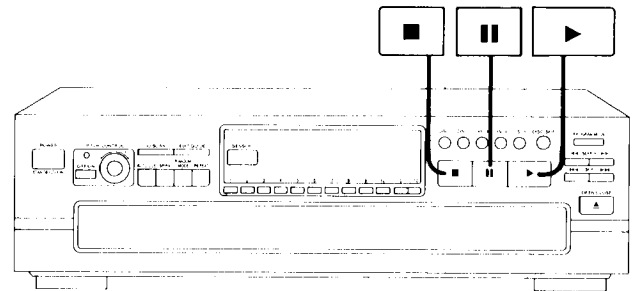

To temporarily stop play



Press **||**.

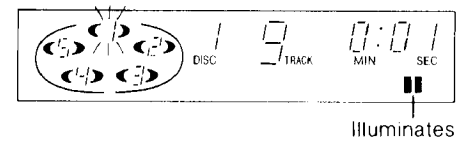

Press **▶** to resume play.

To stop play

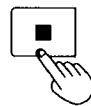

Press **■**.

The display will show the total number of tracks and the total playing time of the current disc.

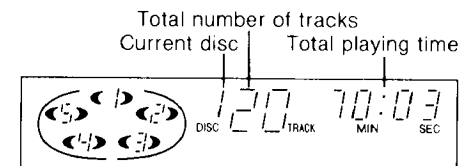

The total playing time displayed includes the silent sections between tracks. For this reason, it may be a few seconds longer than the playing time indicated on the disc.

Press **▶** to resume play.

CAUTION

Do not move this changer with a compact disc inside the unit. If a disc comes off the disc tray, it might be scratched or the changer might become incapable of playing. (Refer to "Cautions concerning the moving of this unit" on the back cover.)

Program play

You can program up to 32 selections from the five discs in any order as you desire.

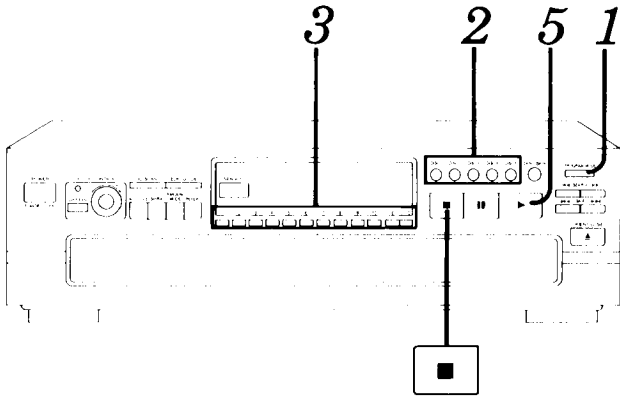

1/ **PROGRAM MODE** [In the stop mode]
 Press **PROGRAM MODE** so that the "PGM" indicator illuminates.

Each time the button is pressed, the display will change in the following order:
 RGM → DEL → (off).

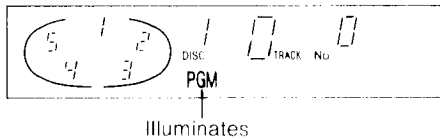

2/ Press the desired disc button (1–5).

For example:
 To select disc 3, press DISC 3.



Specified disc number

The "AL" indication shows that all the tracks on the disc are selected.

To program by means of disc numbers only, repeat the above operation. (The count will increase by one for each operation.)

3/ Press the numeric button(s) to specify the track number.

For example:
 To select track number 20, press >10, then 2, and then 0.

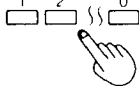

Specified track number Program order

4/ Repeat steps 2 and 3 until you have completed the desired entry.

If you enter non-existing disc(s) or track(s) soon after the loading drawer is closed or when it is open, the corresponding indicator illuminates and the entry is included in the count. In the play mode, the changer will cancel the non-existing entry.

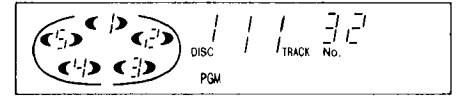

If you attempt a 33rd selection, the "—F" (full) indication will be displayed.

5/ Press **▶** to start play.

To enter additional selections during play, repeat steps 2 and 3.



To clear the entire programmed contents

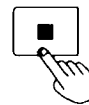

[In the stop mode]

Press **■**.

The display will indicate as below.

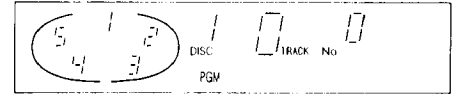

To cancel program mode

PROGRAM MODE [In the stop mode]

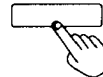

Press **PROGRAM MODE** twice.

The changer will return to sequential play mode.

The programmed contents will remain stored in the memory until they are cleared, even after the program mode is canceled. Therefore, after using program play, it is possible to cancel the program mode and use another play mode (except delete play) and then still use the same program play again at a later time. In addition, if the disc is replaced with another one, program play will be carried out using the new disc. If non-existing entries occur at this time, they will be canceled.

For your reference:

The program mode and the programmed contents will remain stored in the memory even after the unit is switched off. However, if the power cord is unplugged or the power supply is otherwise interrupted for an extended length of time, the contents of the memory will be erased.

Program play (continued)

Using the remote control

transmitter **SL-PD967/SL-PD867 only**

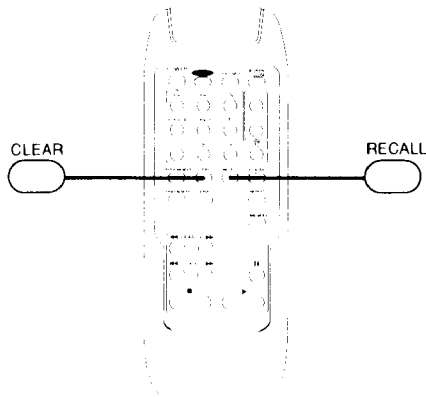

To confirm the programmed contents



Press RECALL.

Each time you press RECALL, the display shows the programmed disc and track number in the sequence you have entered.

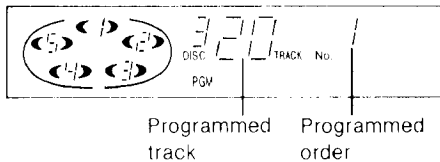

To clear a single item of the programmed contents



Press CLEAR.

Each time you press CLEAR, you will cancel last entry in the order you have entered.

To clear an entry in the middle of the program sequence, press RECALL repeatedly until the display shows the selection to be cleared, and then press CLEAR.

Random play

All of the tracks will be played one time each in random order. There are two types of random play as described below.

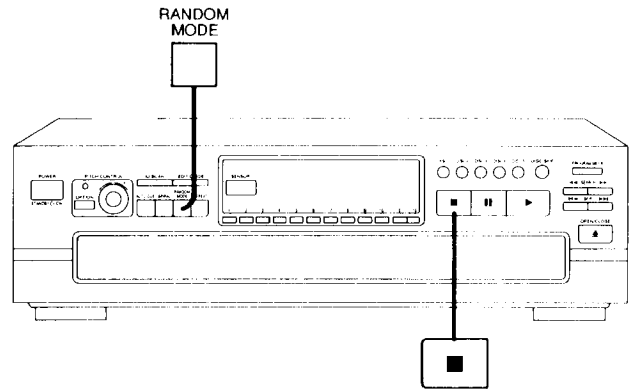

One disc random play

The changer will play all tracks on the current disc in a random order. Then it will choose a new disc randomly, excluding the discs already played, and play all tracks on that disc in a random order.

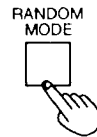

[In the stop or play mode]

Press **RANDOM MODE** so that the "1 DISC RND" indicator illuminates.

Each time the button is pressed, the display will change in the following order: 1 DISC RND → FULL RND → (off).

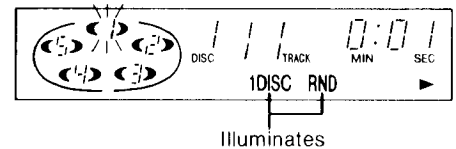

Full random play

Each track to be played back is selected randomly from all of the tracks on all of the discs, excluding the tracks that have already been played.

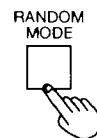

[In the stop or play mode]

Press **RANDOM MODE** so that the "FULL RND" indicator illuminates.

Each time the button is pressed, the display will change in the following order: 1 DISC RND → FULL RND → (off).

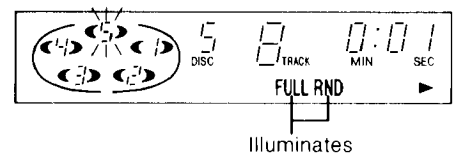

The changer will stop automatically when all the tracks on all discs have been played once.

To cancel random play mode

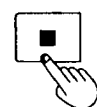

Press **■**.

The "1 DISC (or FULL) RND" indicator will go out.

Delete play

You can select up to 32 selections that you do not want to hear and put them in the changer's memory. Then you can enjoy sequential, one disc random, or full random play of only your favorite tracks.

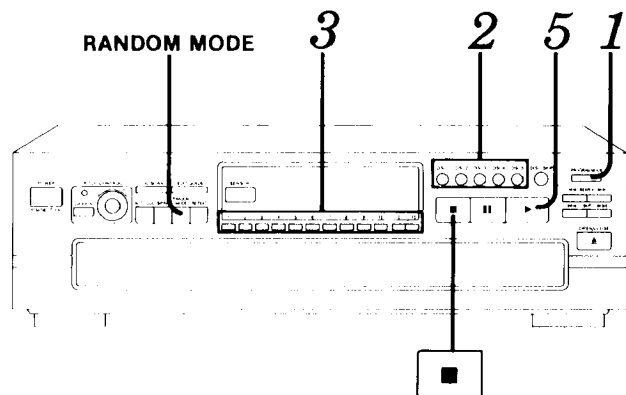

1/ **PROGRAM MODE** [In the stop mode]
Press PROGRAM MODE twice so that the "DEL" indicator illuminates.

Each time the button is pressed, the display will change in the following order:
 RGM → DEL → (off).

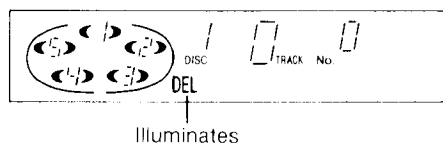

2/ **Press the disc button (1-5).**
For example:

To delete disc 3, press DISC 3.

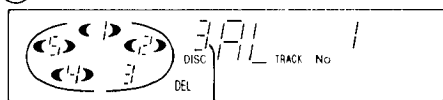

Specified disc number

The "AL" indication shows that all the tracks on the disc are selected.

To delete by means of disc numbers only, repeat the above operation. (The count will increase by one for each operation.)

3/ **Press the numeric button(s) to specify the track number.**
For example:

To delete track number 20, press >10, then 2, and then 0.

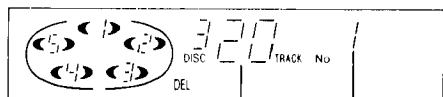
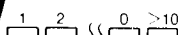

Specified track number Order you have entered

4/ **Repeat steps 2 and 3 until you have completed the desired entry.**

If you enter non-existing disc(s) or track(s) soon after the loading drawer is closed or when it is open, the corresponding indicator illuminates and the entry is included in the count. In the play mode, the changer will cancel the non-existing entry.

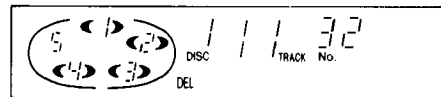

If you attempt a 33rd selection, the "-F" (full) indication will be displayed.

5/ **Press ▶ to start play.**

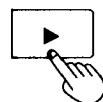

To enter additional selections to be deleted during play, repeat steps 2 and 3.

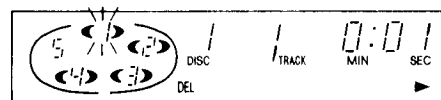

For random play while deleting unwanted tracks

[Proceed through step 4 above, and then:]

To activate one disc random play, press RANDOM MODE.
 To activate full random play, press RANDOM MODE twice.

To clear the entire contents to be deleted

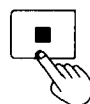

[In the stop mode]

Press ■.

The display will indicate as below.

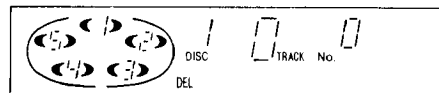

To cancel delete mode

PROGRAM MODE



[In the stop mode]

Press PROGRAM MODE.

The changer will return to sequential play mode.

The contents to be deleted will remain stored in the memory until they are cleared, even after the delete mode is canceled.

Therefore, after using delete play, it is possible to cancel the delete mode and use another play mode (except program play) and then still use the same delete play again at a later time.

In addition, if the disc is replaced with another one, delete play will be carried out using the new disc. If non-existing entries occur at this time, they will be canceled.

For your reference:

The delete mode and the contents to be deleted will remain stored in the memory even after the unit is switched off.

However, if the power cord is unplugged or the power supply is otherwise interrupted for an extended length of time, the contents of the memory will be erased.

Delete play (continued)

Using the remote control transmitter **SL-PD967/SL-PD867 only**

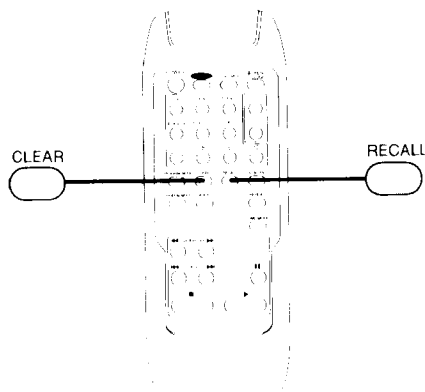

To confirm the selections to be deleted



Press RECALL.

Each time you press RECALL, the display shows the selected disc and track number in the sequence you have entered.

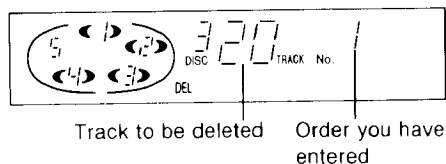

To clear a selection to be deleted

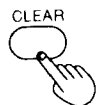

Press CLEAR.

Each time you press CLEAR, you will cancel last entry in the order you have entered.

To clear a selection in the middle of the sequence, press RECALL repeatedly until the display shows the selection to be cleared, and then press CLEAR.

Spiral play

The changer plays the first tracks on all the loaded discs in sequence, followed by the second tracks on all the discs, and so on. (Refer to the illustration below.)

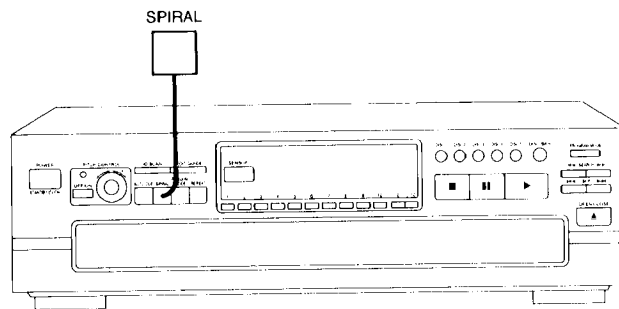

Example: When starting from disc 1

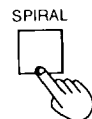
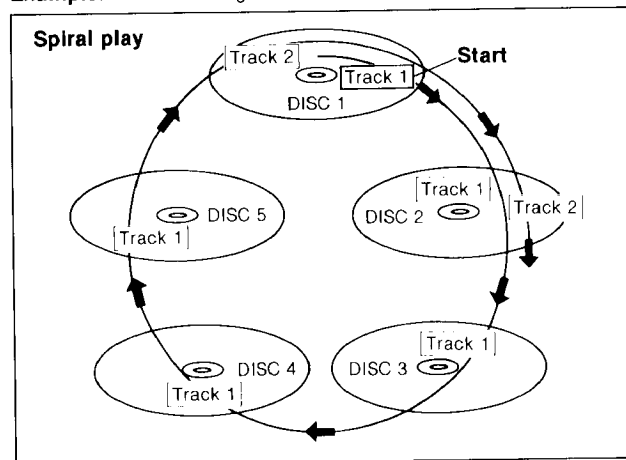

[In the stop or play mode]

Press SPiRAL.

Spiral play will begin with the first track on the disc situated at the playing position.

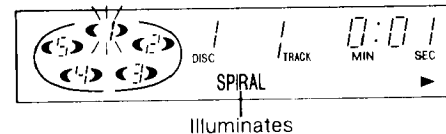

The changer will stop automatically when all the tracks on all discs have been played once.

For your reference:

When a disc with fewer tracks finishes playing, that disc will be skipped and the changer will continue playing the remaining track on the other discs in spiral sequence.

To cancel spiral play mode

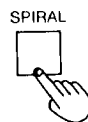

Press SPiRAL again.

The "SPiRAL" indicator will go out.

The changer will return to sequential play mode from the current track on the current disc which is playing.

ID scan function

This function is convenient to use when searching for a desired track.

The function will search from the beginning of the track for a loud section, and will play 10 seconds of the track centering around that point.

The order of scanning is the same as for play mode.

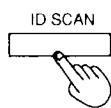
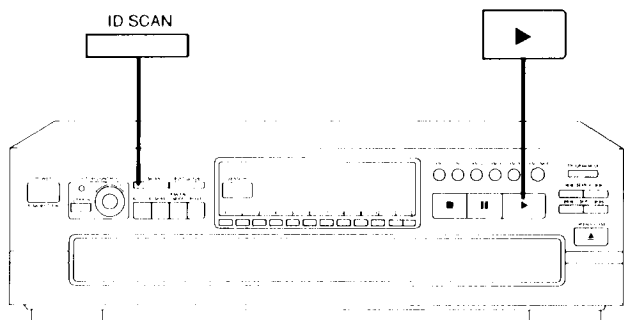

Press ID SCAN.
ID scan will start.

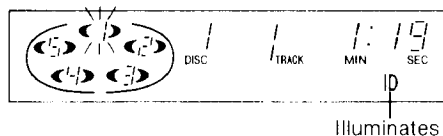

When the desired track has been found:

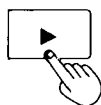

Press ►.
The changer will play the track from the beginning.

To cancel ID scan

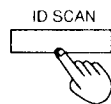

Press ID SCAN while this function is in operation.
The "ID" indicator will go out.

The changer will continue to play from track being played.

Search function

You can search rapidly forward or backward on the disc for specific sections.

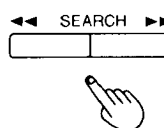
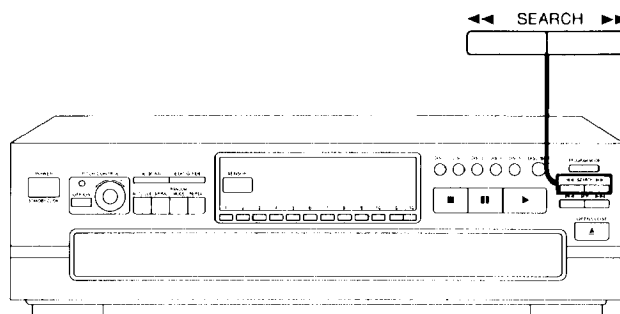

[In the play or pause mode]
Press and hold ◀◀ or ▶▶.
◀◀: You can search backward.
▶▶: You can search forward.

Release the button when you reach the desired point.
The changer will return to the previous mode (play or pause).

In sequential play mode:

You can search forward over discs and backward within the current disc.

In other play modes:

You can search forward or backward only within the current track.

For your reference:

The search function will begin slowly, and then, if the button is held pressed for longer than 3 seconds, it will change to high-speed search.

In the play mode, the sound level decreases by 12 dB (1/4).

Skip function

To skip discs

Use this function to skip discs when selecting a disc to which you wish to listen, and when loading and unloading the discs.

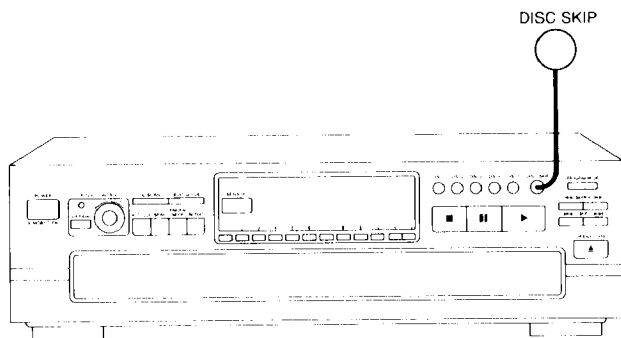

You can use this function in stop, sequential play, one disc random play and delete play modes.

Press DISC SKIP to rotate the disc tray.

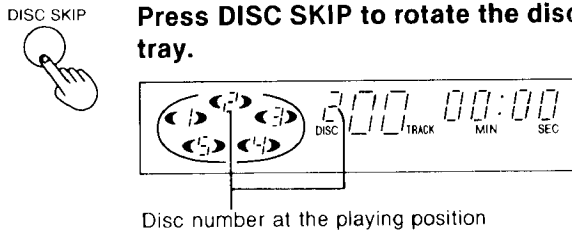

In stop mode:

When the loading drawer is closed, pressing DISC SKIP changes the disc tray to the next one.

When the loading drawer is open, pressing DISC SKIP moves the carousel by two disc trays.

In play mode:

When the loading drawer is closed, pressing DISC SKIP changes the disc and the changer plays the track on next disc.

If a disc is not on the selected disc tray, the changer plays the disc at the next number.

When the loading drawer is open, pressing DISC SKIP moves the carousel by one disc tray. Pressing again moves the carousel in the opposite direction so that you can change all discs except the one being played.

To skip tracks

Use this function to skip tracks when selecting a track to which you wish to listen.

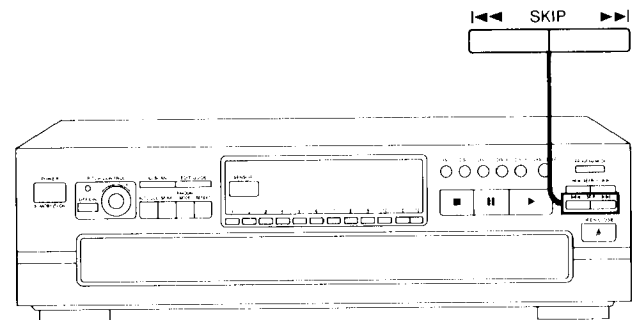

Press either SKIP (◀◀ or ▶▶) until you reach the desired track.

◀◀: You can skip backward.
▶▶: You can skip forward.

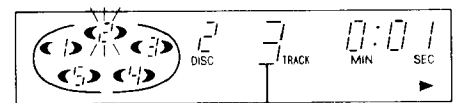

Track number at the playing position

In sequential/program/delete play mode:

In sequential play mode, you can skip only within the current disc. In program play mode, you can skip from one track to another in the programmed sequence.

In delete play mode, you can skip tracks only within the current disc excluding the tracks to be deleted.

◀◀: You can skip to the beginning of the track being played. If you press this button again quickly, you can skip to the beginning of the previous track.

Remember that in a backward skip, the current track is included in the count.

▶▶: You can skip as many tracks as the number of times you press the button.

In random play mode:

◀◀: You can skip to the beginning of the current track.

▶▶: You can skip to the beginning of a next track in random order.

In spiral play mode:

◀◀: You can skip to the beginning of the current track.

▶▶: You can skip to the beginning of the track on the next disc.

You can also skip tracks when the changer is in the stop mode (except during random play and spiral play) or pause mode.

Repeat function

Play will continue endlessly in accordance with the specific play mode selected.

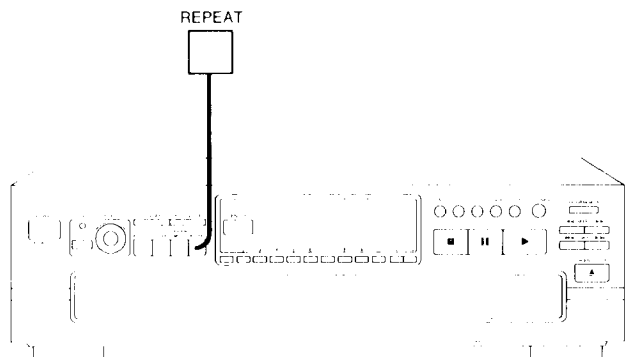

REPEAT



[Before or during play]

Press REPEAT.

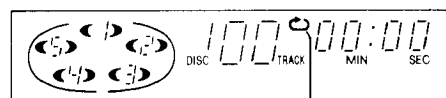

Illuminates

In sequential play mode:

All tracks of all discs will be played repeatedly.

In program play mode:

The changer plays only the programmed selections in the programmed sequence repeatedly.

In delete play mode:

The changer plays the discs and tracks excluding the selections to be deleted repeatedly.

In random play mode:

When the changer has played all the tracks on all the loaded discs, it will select a new random sequence and play continuously. The sequence differs each time.

In spiral play mode:

The changer plays all tracks of all discs repeatedly in the sequence of spiral play.

To cancel repeat mode

REPEAT



Press REPEAT again.

The "⏮" indicator will go out.

Time mode selection

The various time information of the current disc can be displayed.

SL-PD967: Only available from the remote control.

SL-P9066: Only available from the main unit.

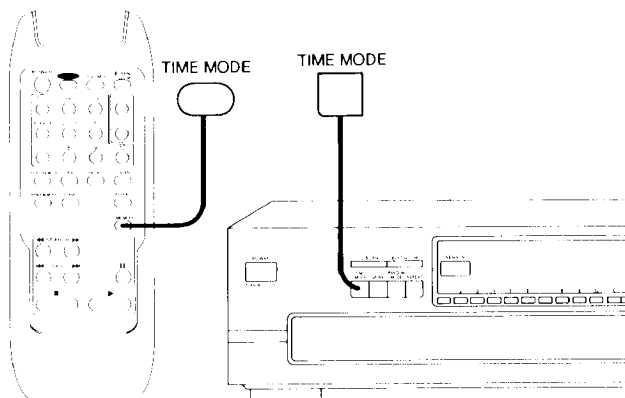

TIME MODE

TIME MODE

TIME MODE



[In the play or pause mode]

Press TIME MODE.

The information will change (as described below) each time you press the button.

① Track number and elapsed play time of the current track

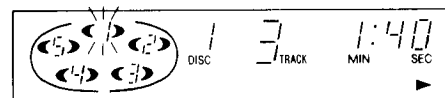

② Total remaining time on the disc

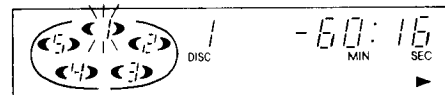

③ Track number and remaining time of the current track

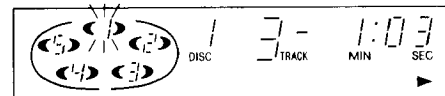

④ Total elapsed play time on the disc

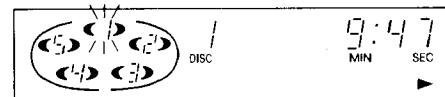

In all play modes:

When track number 21 or greater is playing, display ③ shows "----".

In program/delete/random/spiral mode:

The displayed information will alternate between displays ① and ③ each time the button is pressed.

During operation of the edit guide function:

The remaining play time on side A or side B will be shown in display ②, and the elapsed play time for side A or side B will be shown in display ④.

When you stop playing and then start play again, the display will return to display ①.

Edit guide function

When recording, the changer will automatically program the tracks for tape sides A and B in accordance with the length of the tape so that none of the tracks will be interrupted before they are completed.

In addition, the program will also include a silent interval of approximately 4 seconds between tracks.

Example: Recording from a disc containing seven tracks on to a 60-minute tape.

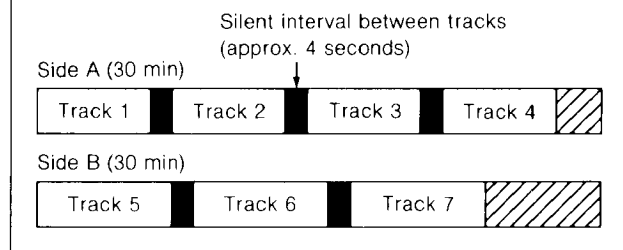

2/ Prepare the tape deck for recording.

Set the Dolby NR, reverse mode, recording level, etc., as instructed in the Operating Instructions for the tape deck.

Note

Set so that recording is possible from the beginning of the tape.

3/ EDIT GUIDE

Press EDIT GUIDE to select the tape length.

Each time you press the button, the display showing the tape length changes as follows. Choose the length of the tape you will use.

C-46 ⇨ C-60 ⇨ C-90 ⇨ C---

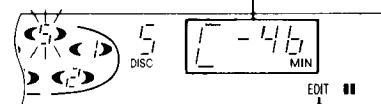

Illuminates

More precise time settings are also possible.

(Refer to the instructions at right.)

The display shows the data of the tracks to be recorded as follows:

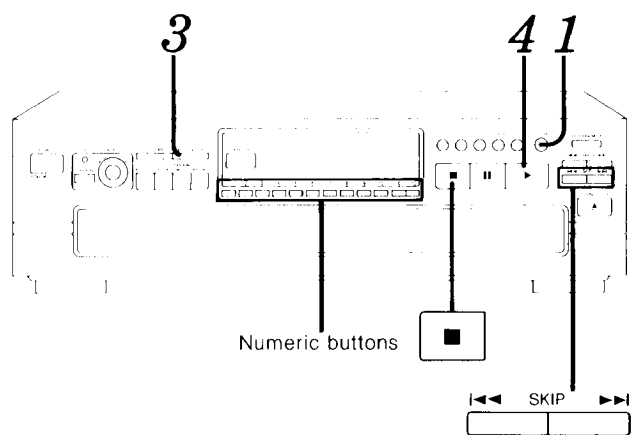

1/ Press DISC SKIP to select the disc to be recorded.

DISC SKIP

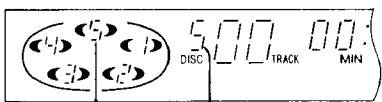

Specified disc number

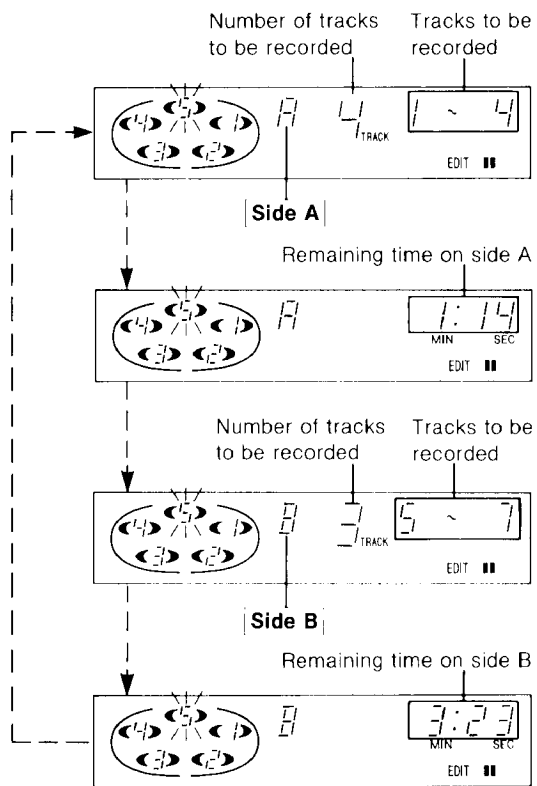

In this example, disc 5 can be recorded with tracks 1-4 on side A and tracks 5-7 on side B of the cassette tape.

Pitch control function

SL-PD967 only

4

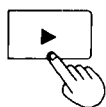

[Start recording on the tape deck and then immediately:]

Press ►.

When the last track set for recording on side A is finished, the changer will enter the pause mode. Set the tape to the position from which recording will begin on side B, and then perform step 4 once again.

When all the programmed tracks on the specified disc finish playing, the changer will automatically stop. The edit guide mode will be canceled at the same time.

To enter a desired recording time other than 46, 60 or 90 minutes:

1. Select "C--" in step 3.
2. Enter the total recording time in minutes (1-99) using the numeric buttons.

For example:

To use 52-minute tape, press 5 then 2.

You can also specify the tape length pressing the SKIP button. Press either ◀◀ or ▶▶ from each step C-46, C-60, C-90 or C--.

For example:

To use 52-minute tape, select C-46 and then press and hold ▶▶ until the display shows "52".

The maximum allowable playing time for editing is 99 minutes.

To stop recording

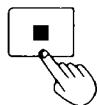

Press ■ and then press the stop button on the tape deck.

Note

Depending on the disc, a little of the beginning of the next track may be recorded onto the end of the track.

The playback pitch can be changed as desired within a range of $\pm 12.5\%$. (The tempo and the pitch of the sound will change simultaneously.)

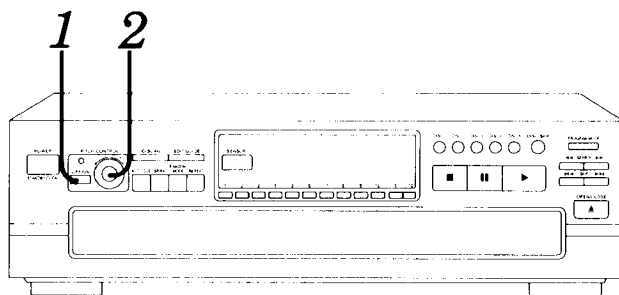

1

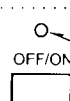

Press OFF/ON.

The pitch control indicator on this unit will illuminate.

2



Turn the knob in the "–" or "+" direction.

–: Pitch decreases
+: Pitch increases

The pitch will change while the knob is being held, and the changed values will show on the display.

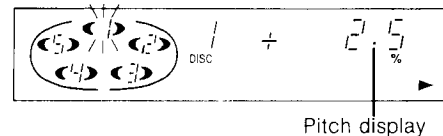

Pitch display

If the knob is released, the pitch will stop changing, and after approximately 2 seconds the pitch display will change back to the time display.

Pitch changing steps:

The +5.9% position is a half tone-sharp (♯).

The –5.6% position is a half tone-flat (♭).

To fine-tune the pitch

Turn the knob and then immediately turn it back to the original position. In this case, the pitch will change by 0.1% only.

To play in 0% standard pitch

Press OFF/ON so that the pitch control indicator will switch off. Even after the pitch control indicator has been switched off, the pitch setting will remain in memory.

For your reference:

- The pitch can be adjusted by turning the knob even if the pitch control indicator is switched off. The playback sound will not change if this is done. To play back at the setting pitch, press OFF/ON to make the pitch control indicator illuminate.
- While changing the pitch, the time display will show the playback position only. This will not match the actual playback time.
- The pitch value and the on/off setting of the pitch control will remain stored in the memory even after the unit is switched off. However, if the power cord is unplugged or the power supply is otherwise interrupted for an extended length of time, the memory will be erased.

Auto cue function

SL-PD967 only

The auto cue function allows the unit to wait in a standby condition at the beginning of each track so as to start play right when you are ready.

When each track finishes playing, the unit skips to the beginning of the next track and switches to the play standby mode.

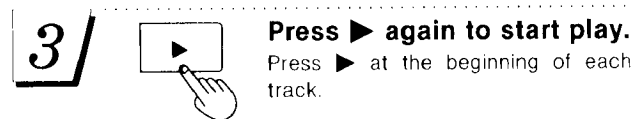
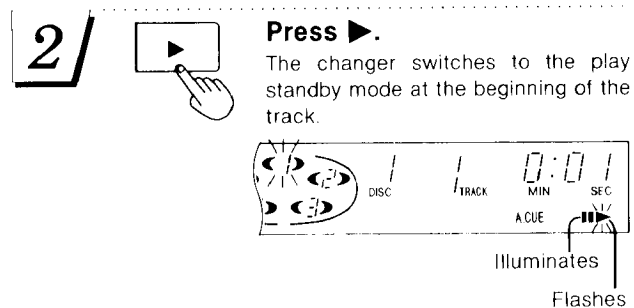
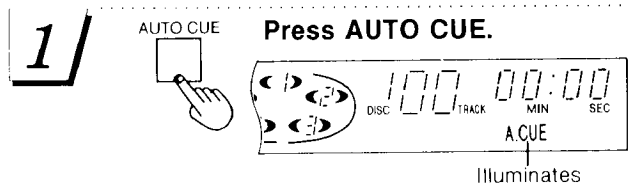
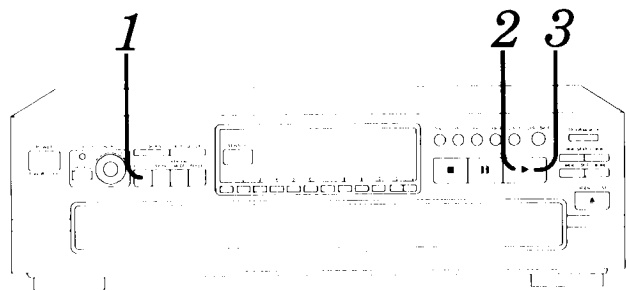

To cancel auto cue mode

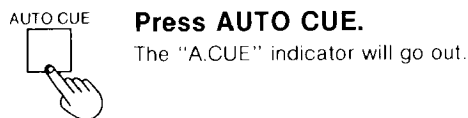

Note

The auto cue function may not cause the unit to wait exactly at the beginning of a track if the track begins with a very soft passage or if there is a lot of background noise.

Concerning compact discs

With this changer, you can only play compact discs having this mark:



Handling precautions

To open the compact disc case, gently press the sides of the top and pull up.

To remove the disc from the case, press the center holder and lift the disc, holding by the edges.

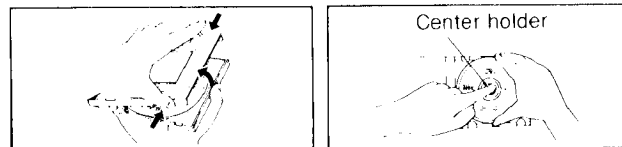

To return the disc to the case, insert the disc with the label facing up and press downward at the center.

Hold compact discs by the edges so as not to soil the surface with fingerprints. Fingerprints, dirt and scratches can cause skipping and distortion.

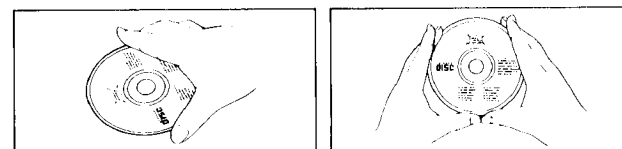

Do not use record cleaning sprays, benzene, thinner, static electricity prevention liquids or any other solvent on a disc.

If the surface is soiled, wipe gently with a soft, damp (water only) cloth.

Always move the cloth directly outward from the center of the disc, not in a circular motion as with standard phonograph records.

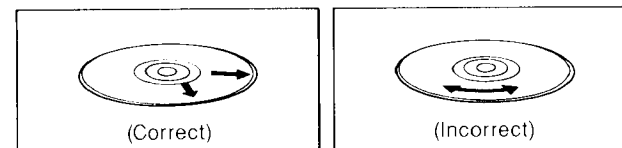

If you are taking the disc from a cold to a warm environment, moisture may form on the disc. Wipe this off with a soft, dry, lint-free cloth before using the disc.

Do not write on the label side with a ball-point pen or other writing instrument.

Storage precautions

Be sure to store discs in their cases to protect them from dust, scratches, and warping.

Do not place or store discs in the following places:

- 1) Locations exposed to direct sunlight
- 2) Humid or dusty locations
- 3) Locations directly exposed to a heat vent or heating appliance
- 4) In the glove compartment or on the rear deck of an automobile

Troubleshooting guide

Before requesting service for this unit, check the chart below for a possible cause of the problem you are experiencing. Some simple checks or a minor adjustment on your part may eliminate the problem and restore proper operation.

If you are in doubt about some of the check points, or if the remedies indicated in the chart do not solve the problem, refer to the directory of authorized service centers (enclosed with this unit) to locate a convenient service center, or consult your Technics dealer for instructions.
(In U.S.A. consult MSC Authorized Servicers for detailed instructions.)

Problem	Probable cause(s)	Suggested remedy
Changer will not play.	A disc(s) or other foreign object(s) has fallen inside the changer. Moisture has collected in the changer.	<ul style="list-style-type: none"> • Open the loading drawer, and then remove the object. • Switch on and allow the changer to dry out for about one hour before using it. • Make sure the label is facing upward. • Wipe the disc with a soft cloth. • Replace the disc with a new one.
The disc in the changer does not play.	The disc is upside down. The disc is dirty. The disc is scratched. The disc is warped. The disc is not within specified standards.	<ul style="list-style-type: none"> • Press the OPEN/CLOSE button to close the loading drawer. • Wipe the disc with a soft cloth. • Replace the disc with a new one. • Use the changer further away from the tuner or TV. • If the tuner or TV's antenna is the indoor type, use an outdoor one. • Program a track.
Play stops before changing to the next disc.	The loading drawer is open.	
A certain music passage can't be played correctly.	The disc is dirty. The disc is scratched.	
There is noise from the tuner or disturbance on the TV screen.	Caused by high-frequency signals from this changer.	
When program play is started, an error message (- E) appears on the display.	Play was started without a track being programmed.	
An error message (- E) appears on the display, and the changer stops operating.	The mechanism of the changer has been improperly adjusted.	<ul style="list-style-type: none"> • Turn the unit off and then back on again. However, if the loading drawer is fully open, take out the compact disc(s) at the front position and then turn the unit off and then back on again.
The loading drawer stops in the middle of opening.		

Product service

Do not attempt to remove the cover(s) or repair the unit yourself.
Refer servicing to qualified personnel only.

Product information

For product service, product information or assistance in product operation, refer to the servicenter directory.

Cautions concerning the moving of this unit

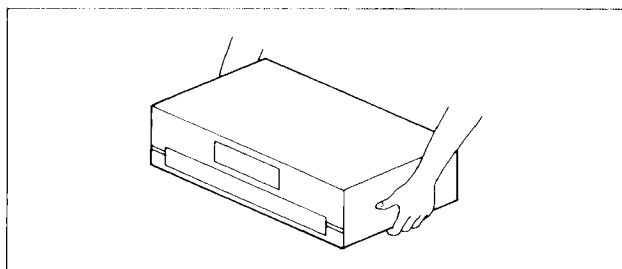

CAUTION

Before moving the changer to another location, be sure to carry out the "Preparations for moving the unit" described below.

Failure to do so will expose the compact discs and the changer to the risk of severe damage.

Preparations for moving the unit

All of the discs must be removed so that the trays are completely empty.

Use the following procedure.

- 1 Press **POWER** to switch off the unit.
- 2 Press **POWER** to switch on the unit.
(If there is a disc in the play section, it will be returned to the disc tray at this time.)
- 3 Press **OPEN/CLOSE** to open the loading drawer.
- 4 Press **DISC SKIP** to rotate the disc trays and remove the discs from all disc trays.
- 5 Press **OPEN/CLOSE** to close the loading drawer.
- 6 Press **POWER** to switch off the unit.

If you have pressed a wrong button by mistake, return to step 1.

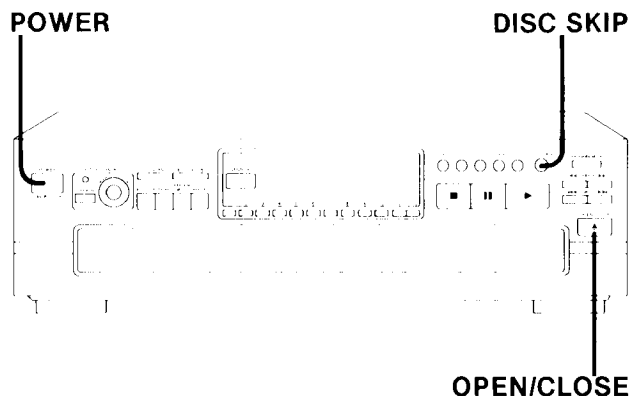

Technical specifications

AUDIO

No. of channels	2 (left and right, stereo)
Frequency response	2-20,000 Hz, ± 1 dB
Output voltage	2 V (at 0 dB)
Dynamic range	92 dB
S/N	100 dB
Total harmonic distortion	0.007% (1 kHz, 0 dB)
Wow and flutter	Below measurable limit
DA converter	MASH (1 bit)
Output impedance	Approx. 1 k Ω
Load impedance	More than 10 k Ω

PICKUP

Wavelength	780 nm
------------	--------

GENERAL

Power consumption	[SL-PD967] 12 W [SL-PD867/SL-P9066] 11 W
Power supply	AC 120 V, 60 Hz
Dimensions (W \times H \times D)	[SL-PD967] 430 \times 125 \times 377 mm (16-15/16" \times 4-15/16" \times 14-27/32") [SL-PD867/SL-P9066] 430 \times 125 \times 370 mm (16-15/16" \times 4-15/16" \times 14-9/16")
Weight	4.6 kg (10.1 lb.)

Note:

Specifications are subject to change without notice.
Weight and dimensions are approximate.

MASH is a trademark of NTT.

Panasonic Company, Division of
Matsushita Electric Corporation of America
One Panasonic Way
Secaucus, New Jersey 07094

Panasonic Sales Company, Division of
Matsushita Electric of Puerto Rico, Inc.
San Gabriel Industrial Park
65th Infantry Ave. Km. 9.5
Carolina, P.R. 00630

Panasonic Company (West) of America, Division of
Matsushita Electric Corporation of America
6550 Katella Ave.
Cypress, CA 90630

Matsushita Electric of Canada Limited
5770 Ambler Drive, Mississauga,
Ontario L4W 2T3