

Technics®

AV Control Stereo Receiver SA-GX790/GX690 SA-GX490/GX390/GX290

Operating Instructions

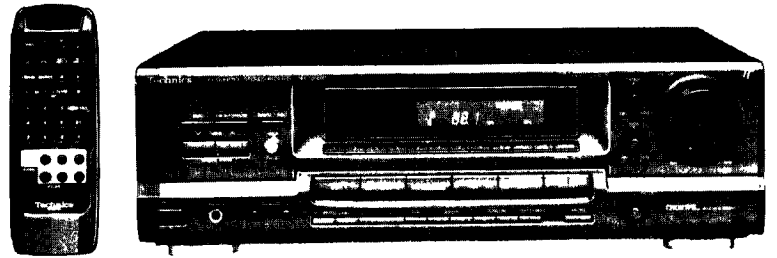

The photographs show SA-GX490.
The configuration of the ventilation holes differs according to area.

Before connecting, operating or adjusting this product,
please read these instructions completely.

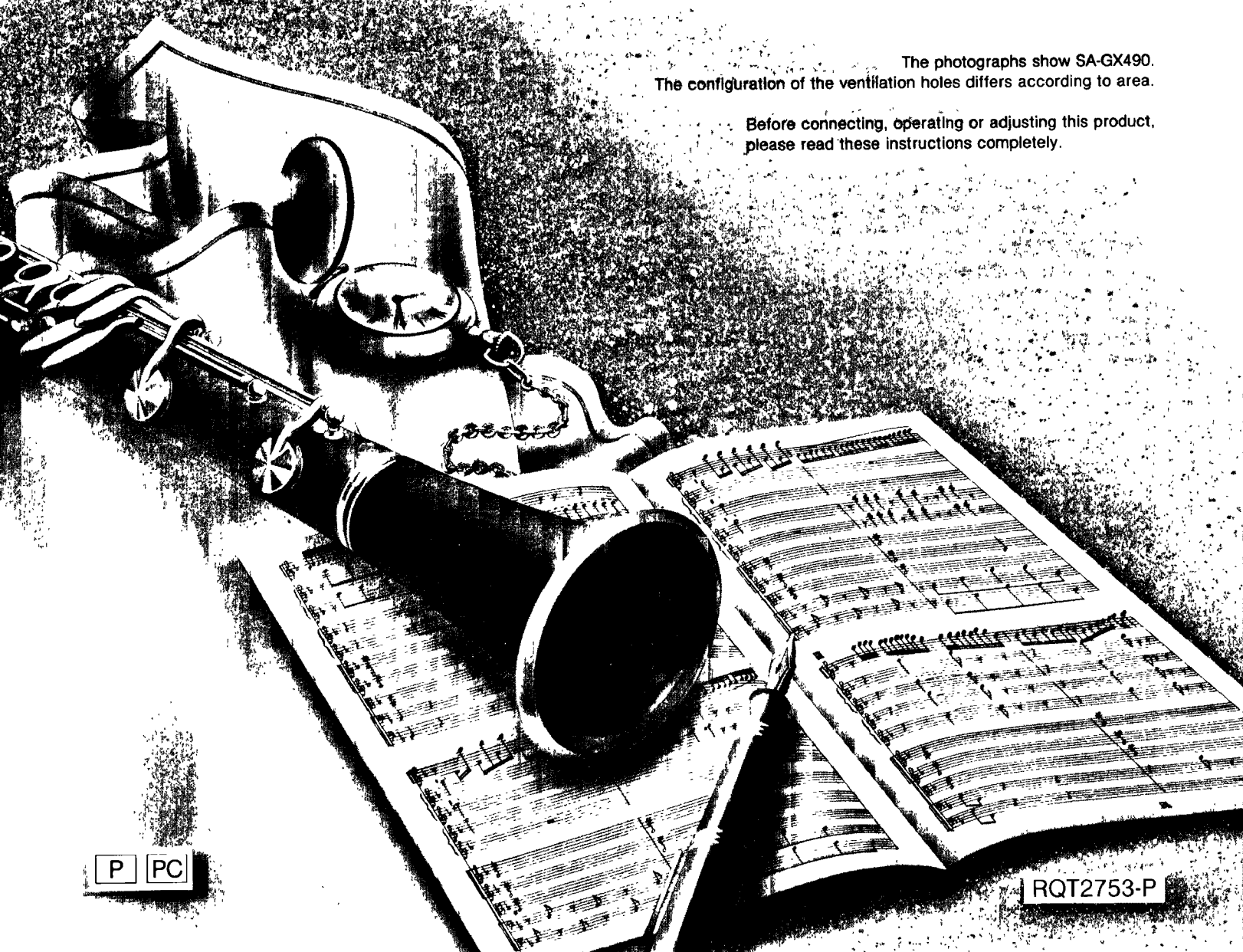

P PC

RQT2753-P

Dear Customer

Thank you for purchasing this Technics product. For optimum performance and safety, please read these instructions carefully.

These operating instructions are applicable to models SA-GX790, SA-GX690, SA-GX490, SA-GX390 and SA-GX290, however, are intended primarily for model SA-GX490.

Table of contents

Precautions	3
Accessories	4
Front panel controls	5
Equipment connections	6
Antenna connections	8
Speaker connections	9
Basic operations	12
If sound output stops during use or if you are unsure what to do	13
To adjust the tone quality	13
To mute the sound level	13
To adjust the sound balance	13
To emphasize low frequency sound SA-GX790/GX690 only	13
To listen through headphones	13
To switch the VCR to the front or rear "VCR 2" terminal SA-GX790 only	13
Listening to radio broadcasts	14
Direct access tuning	14
Sequential tuning	14
Preset tuning	15
Enjoying sound with DOLBY PRO LOGIC	17
SURROUND	17
3 STEREO	17
Setting the center mode	17
Adjusting speaker output level	18
Adjusting the delay time SA-GX790/GX690 only	19
Enjoying with SURROUND or 3 STEREO	19
Enjoying sound with SFC SA-GX790/GX690 only	20
Adjusting field of sound	20
Making a recording	21
Recording on the tape deck	21
Recording on the VCR (VCR 1)	21
About the HELP function	22
About the On-Screen Display function SA-GX790 only	22
Product service	22
Troubleshooting guide	23
Technical specifications	Back cover

The model number and serial number of this product can be found on either the back or the bottom of the unit.

Please note them in the space provided below and retain them for future reference.

MODEL NUMBER

SERIAL NUMBER

THIS PHRASE IS APPLIED ONLY FOR U.S.A.:

CAUTION:

Any unauthorized changes or modifications to this equipment would void the user's authority to operate this device.

WARNING:

TO REDUCE THE RISK OF FIRE OR ELECTRIC SHOCK, DO NOT EXPOSE THIS APPLIANCE TO RAIN OR MOISTURE.

CAUTION:

TO PREVENT ELECTRIC SHOCK MATCH WIDE BLADE OF PLUG TO WIDE SLOT, FULLY INSERT.



CAUTION
RISK OF ELECTRIC SHOCK
DO NOT OPEN



CAUTION: TO REDUCE THE RISK OF ELECTRIC SHOCK, DO NOT REMOVE SCREWS. NO USER-SERVICEABLE PARTS INSIDE. REFER SERVICING TO QUALIFIED SERVICE PERSONNEL.



The lightning flash with arrowhead symbol, within an equilateral triangle, is intended to alert the user to the presence of uninsulated "dangerous voltage" within the product's enclosure that may be of sufficient magnitude to constitute a risk of electric shock to persons.



The exclamation point within an equilateral triangle is intended to alert the user to the presence of important operating and maintenance (servicing) instructions in the literature accompanying the appliance.

Precautions

Before using this unit please read these operating instructions carefully. Take special care to follow the warnings indicated on the unit itself as well as the safety suggestions listed below. Afterwards keep them handy for future reference.

Safety

- 1. Power Source** -- The unit should be connected to power supply only of the type described in the operating instructions or as marked on the unit.
- 2. Polarization** -- If the unit is equipped with a polarized AC power plug (a plug having one blade wider than the other), that plug will fit into the AC outlet only one way. This is a safety feature. If you are unable to insert the plug fully into the outlet, try reversing the plug. If the plug should still fail to fit, contact your electrician to replace your obsolete outlet. Do not defeat the safety purpose of the polarized plug.
- 3. Power Cord Protection** -- AC power supply cords should be routed so that they are not likely to be walked on or pinched by items placed upon or against them. Never take hold of the plug or cord if your hand is wet, and always grasp the plug body when connecting or disconnecting it.
- 4. Nonuse Periods** -- When the unit is not used, turn the power off. When left unused for a long period of time, the unit should be unplugged from the household AC outlet.

Installation

Environment

- 1. Outdoor Antenna Grounding** -- If an outside antenna is connected to the receiver, be sure the antenna system is grounded so as to provide some protection against voltage surges and built-up static charges. Section 810 of the National Electrical Code, ANSI/NFPA No. 70-1990, provides information with respect to proper grounding of the mast and supporting structure, grounding of the lead-in wire to an antenna discharge unit, size of grounding conductors, location of antenna-discharge unit, connection to grounding electrodes, and requirements for the grounding electrode. See figure below.

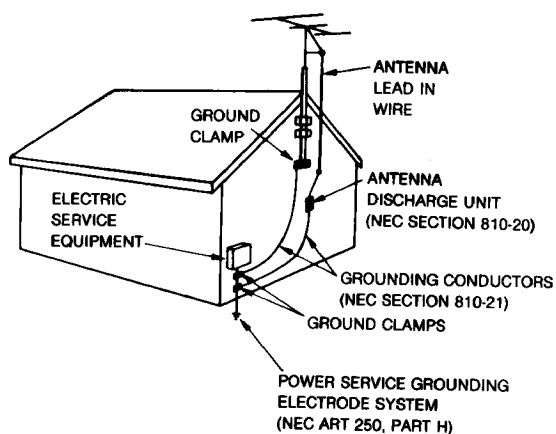

- 2. Water and Moisture** -- Do not use this unit near water -- for example, near a bathtub, washbowl, swimming pool, or the like. Damp basements should also be avoided.
- 3. Heat** -- The unit should be situated away from heat sources such as radiators and the like. It also should not be placed in temperatures less than 5°C (41°F) or greater than 35°C (95°F).

Placement

- 1. Ventilation** -- The unit should be situated so that its location or position does not interfere with its proper ventilation. Allow 10 cm (4") clearance from the rear of the unit.
- 2. Foreign Material** -- Care should be taken so that objects do not fall into and liquids are not spilled into the unit. Do not subject this unit to excessive smoke, dust, mechanical vibration, or shock.
- 3. Magnetism** -- The unit should be situated away from equipment or devices that generate strong magnetism.
- 4. Stacking** -- Do not place heavy objects, other than system components, on top of the unit.
- 5. Surface** -- Place the unit on a flat, level surface.
- 6. Carts and Stands** -- The unit should be used only with a cart or stand that is recommended by the manufacturer. The unit and cart combination should be moved with care. Quick stops, excessive force, and uneven surfaces may cause the unit and cart combination to overturn.
- 7. Wall or Ceiling Mounting** -- The unit should not be mounted to a wall or ceiling, unless specified in this operating instructions.



Maintenance

Clean the cabinet, panel and controls with a soft cloth lightly moistened with mild detergent solution.

Do not use any type of abrasive pad, scouring powder or solvent such as alcohol or benzene.

Service

- 1. Damage Requiring Service** -- The unit should be serviced by qualified service personnel when:
 - (a) The AC power supply cord or the plug has been damaged; or
 - (b) Objects have fallen or liquid has been spilled into the unit; or
 - (c) The unit has been exposed to rain; or
 - (d) The unit does not appear to operate normally or exhibits a marked change in performance; or
 - (e) The unit has been dropped, or the enclosure damaged.
- 2. Servicing** -- The user should not attempt to service the unit beyond that described in the operating instructions. All other servicing should be referred to qualified service personnel.

Precautions

Listening caution



Selecting fine audio equipment such as the unit you've just purchased is only the start of your musical enjoyment. Now it's time to consider how you can maximize the fun and excitement your equipment offers. This manufacturer and the Electronic Industries Association's Consumer Electronics Group want you to get the most out of your equipment by playing it at a safe level. One that lets the sound come through loud and clear without annoying blaring or distortion—and, most importantly, without affecting your sensitive hearing.

We recommend you to avoid prolonged exposure to excessive noise.

Sound can be deceiving. Over time your hearing "comfort level" adapts to higher volumes of sound. So what sounds "normal" can actually be loud and harmful to your hearing. Guard against this by setting your equipment at a safe level BEFORE your hearing adapts.

To establish a safe level:

- Start your volume control at a low setting.
- Slowly increase the sound until you can hear it comfortably and clearly, and without distortion.

Once you have established a comfortable sound level:

- Set the dial and leave it there.

Taking a minute to do this now will help to prevent hearing damage or loss in the future. After all, we want you listening for a lifetime.

Accessories

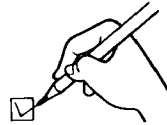

Please check and identify the supplied accessories

- AC power supply cord 1 pc.
(For USA: SJA172-A or SJA172-1)
(For Canada: SJA172-A or SJA172)

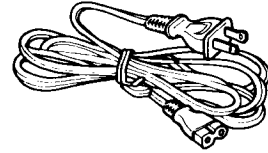

- AM loop antenna set (RSA0010)
 - AM loop antenna 1 pc.
 - AM loop antenna holder 1 pc.
 - Screw 1 pc.

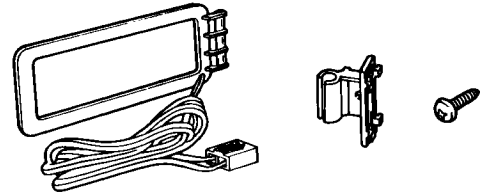

- FM indoor antenna (RSA0006) 1 pc.

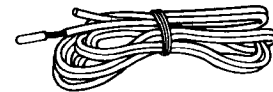

- Remote control transmitter 1 pc.
For SA-GX490/ GX390/GX290 (RAK-SA164WH) **For SA-GX790/GX690** (RAK-SA603MH)

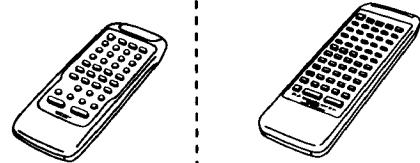

For details on remote control transmitter operation, refer to "How to use the remote control transmitter" in the separate booklet.

- Batteries (UM-4, "AAA", R03) 2 pcs.



Front panel controls

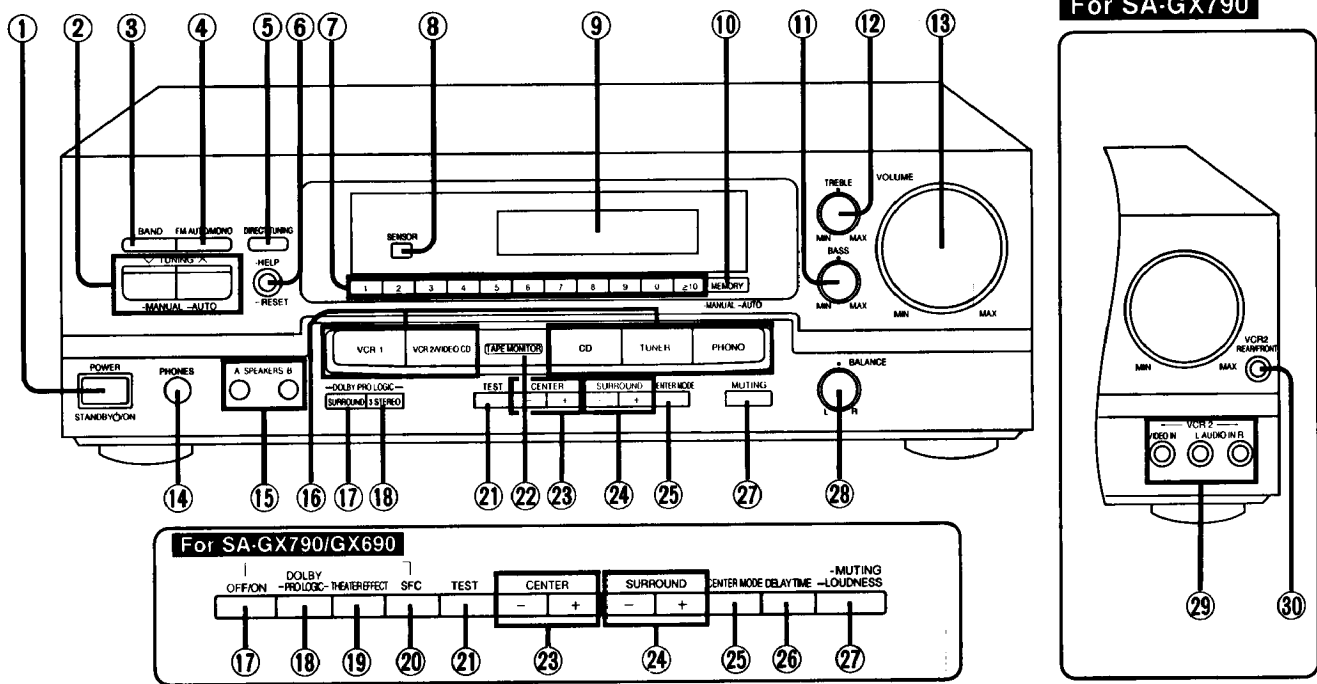



No.	Name	Ref. page
①	Power switch (POWER)	12
②	Tuning control (TUNING)	14
③	Band select button (BAND)	14
④	FM mode select button (FM AUTO/MONO)	14
⑤	Direct tuning button (DIRECT TUNING)	14
⑥	Help/reset button (-HELP - RESET)	13,22
⑦	Numeric buttons (1-0, ≥10)	14,16
⑧	Remote control signal receptor	-
⑨	Display	-
⑩	Memory button (MEMORY)	15,16
⑪	Bass control (BASS)	13
⑫	Treble control (TREBLE)	13
⑬	Volume control (VOLUME)	12
⑭	Headphone jack (PHONES)	13
⑮	For SA-GX790/GX690/GX490 Speaker select buttons (SPEAKERS)	10,12
	For SA-GX390/GX290 Speaker ON/OFF button (SPEAKERS)	12
⑯	Input select buttons	12,19,21,22
⑰	For SA-GX490/GX390/GX290 Surround ON/OFF button (SURROUND)	17,18,19
	For SA-GX790/GX690 DOLBY PRO LOGIC/SFC OFF ON button (OFF/ON)	19,20

No.	Name	Ref. page
⑱	For SA-GX490/GX390/GX290 3 stereo ON/OFF button (3 STEREO)	17,18,19
	For SA-GX790/GX690 DOLBY PRO LOGIC mode select button (PRO LOGIC)	17,18,19
⑲	Theater effect ON/OFF button (THEATER EFFECT) SA-GX790 only	19
⑳	SFC mode select button (SFC) SA-GX790/GX690 only	20
㉑	Test signal ON/OFF button (TEST)	18
㉒	Tape monitor button (TAPE MONITOR)	12,21
㉓	Center level adjust button (CENTER)	18,20
㉔	Surround level adjust button (SURROUND)	18,20
㉕	Center mode select button (CENTER MODE)	17
㉖	Delay time adjust button (DELAY TIME) SA-GX790/GX690 only	19
㉗	For SA-GX490/GX390/GX290 Muting button (MUTING)	13
	For SA-GX790/GX690 Muting/loudness button (-MUTING - LOUDNESS)	13
㉘	Balance control (BALANCE)	13
㉙	VCR 2 front input terminals (VCR 2) SA-GX790 only	13,21
㉚	VCR 2 input select button (VCR 2 REAR/FRONT) SA-GX790 only	13,21

Equipment connections

Connecting audio equipment

Stereo connection cable (not included)

White (L)  Red (R) 

Note

Do not place books, etc., on top of this unit or block the heat radiation vents in any way.

CD changer (or CD player) (not included)

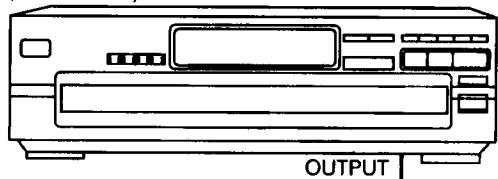

Tape deck (not included)

REC (IN)
PLAY (OUT)

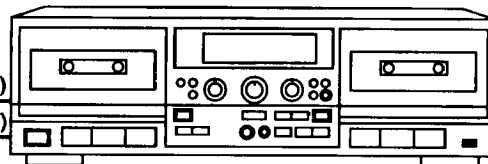

Only for turntable
with ground terminal

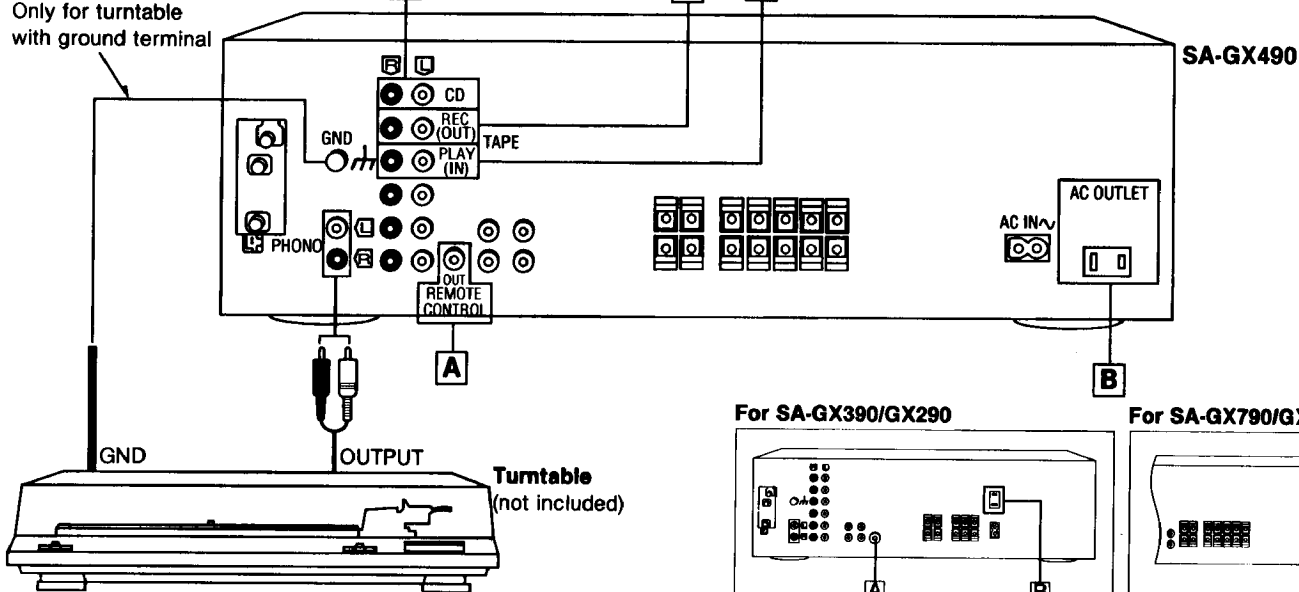

For SA-GX390/GX290

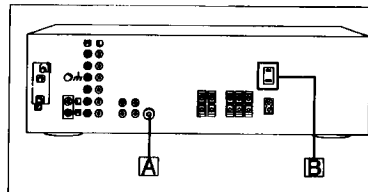

For SA-GX790/GX690

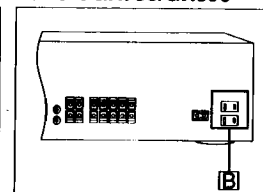

A For SA-GX490/GX390/GX290

"REMOTE CONTROL OUT" terminal

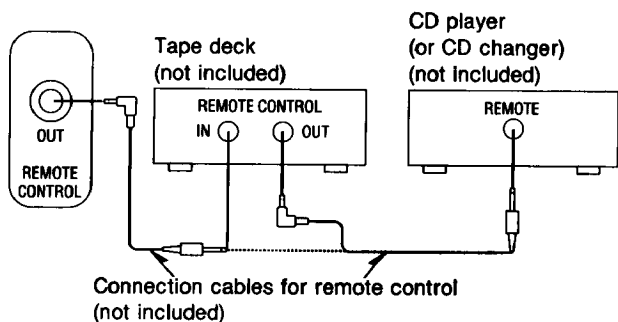

Connect the connection cable for remote control to a Technics tape deck and/or CD changer (or CD player) which has the appropriate remote control terminal as shown above.

If a tape deck is not being used, the CD changer (or CD player) can be connected directly (dotted line).

Note

For a tape deck and/or CD changer (or CD player) with a remote control sensor, this connection is not necessary.

B "SWITCHED" AC outlet(s)

For SA-GX490

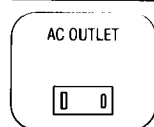

For SA-GX390/GX290

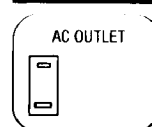

For SA-GX790/GX690

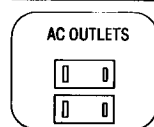

Power to these outlets is controlled by the power switch of this unit. Audio equipment rated up to the indicated power ratings can be connected here.



For SA-GX790/GX690

Cooling fan

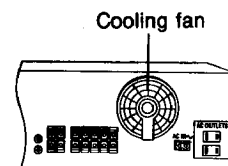
The cooling fan operates at high power output levels only.



Connecting video equipment

Stereo connection cable (not included)
 White (L) 
 Red (R) 

Second VCR (for playback only)
 (not included)

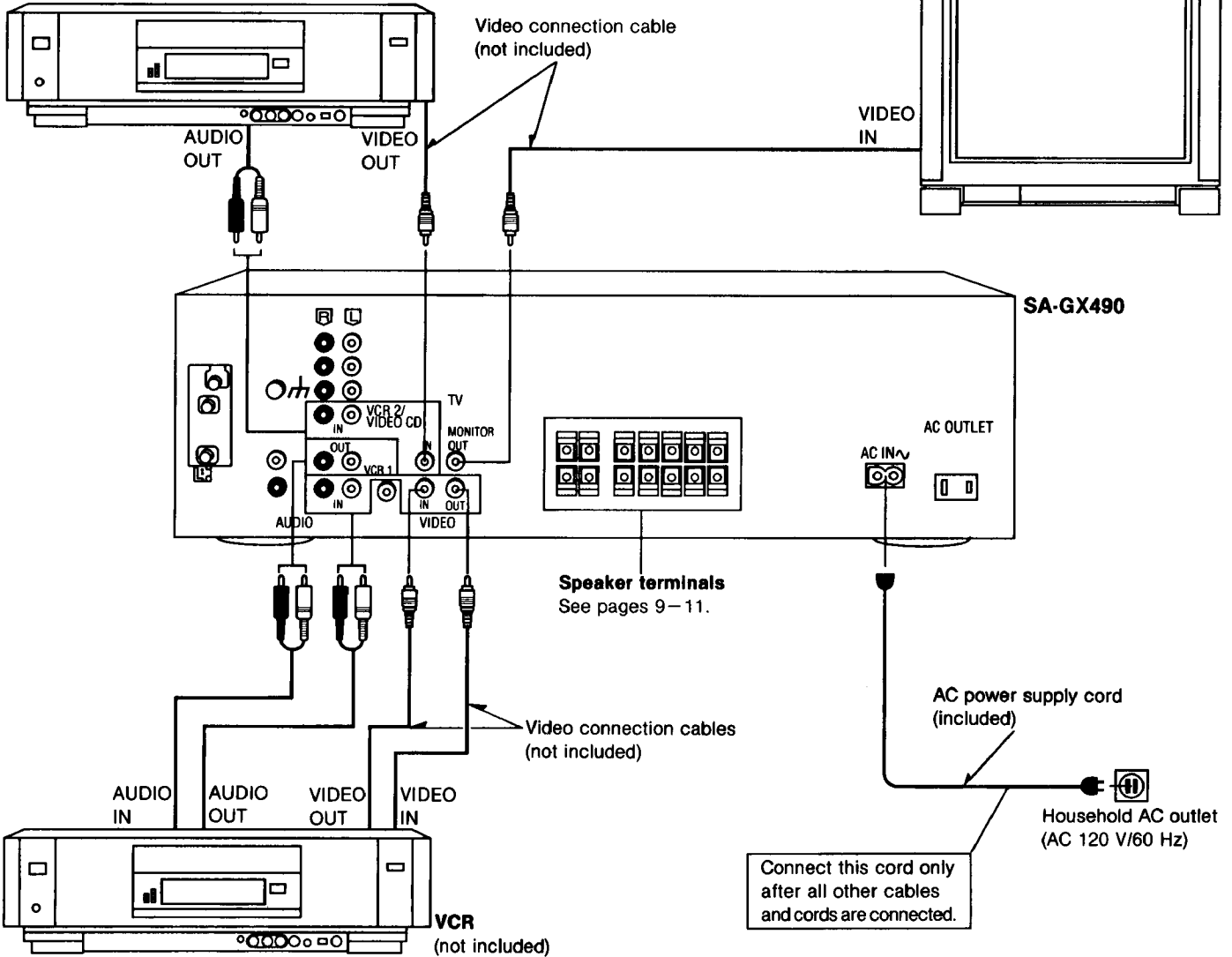

Connecting a video CD changer

For SA-GX690/GX490/GX390/GX290

Connect the video CD changer to the "VCR 2/VIDEO CD" terminals.

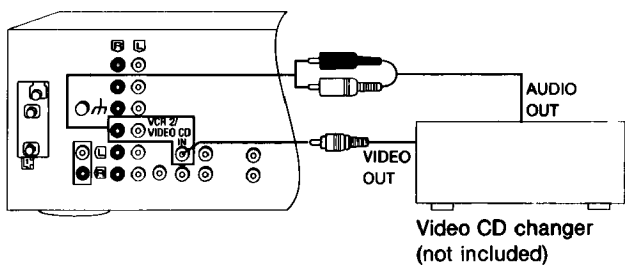

For SA-GX790

Connect the video CD changer to the "CD/VIDEO CD" terminals.

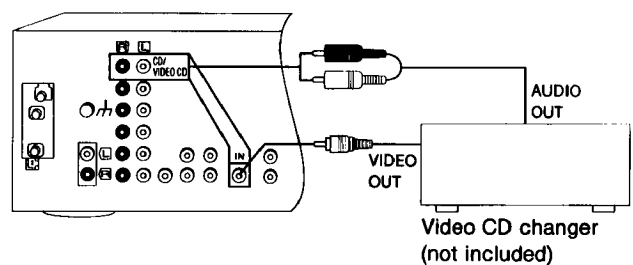

Antenna connections

FM indoor antenna (included)

This antenna is normally sufficient for reception of FM broadcasts.

FM indoor antenna (included)

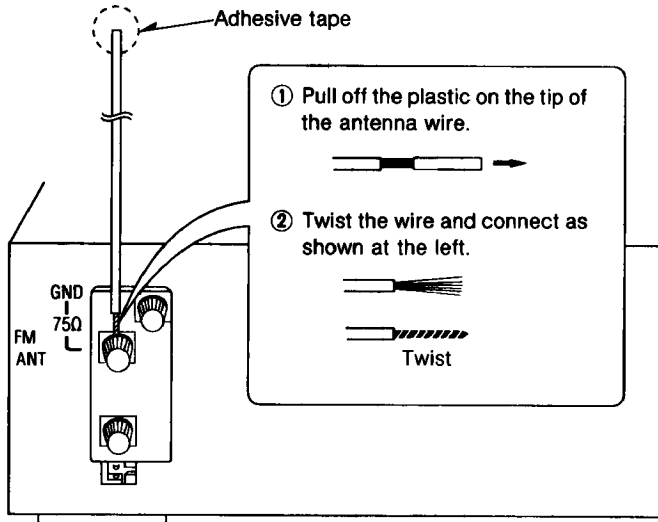

Attach to a wall (using a tape) facing in the direction of best reception.

For best reception sound quality

An FM outdoor antenna is recommended. Disconnect the antenna if an FM outdoor antenna is installed.

FM outdoor antenna (not included)

The outdoor antenna should be used when using the main unit in mountainous areas or in spaces enclosed by reinforced concrete where the FM indoor antenna (included) does not provide satisfactory reception.

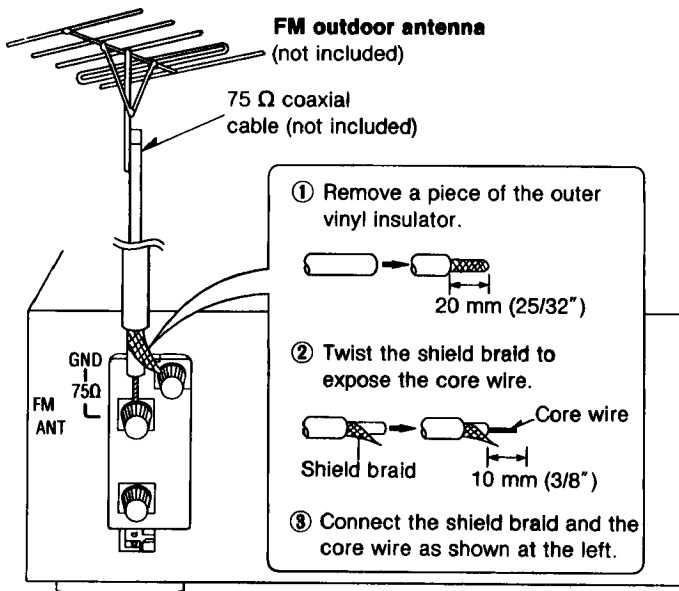

Note

An outdoor antenna should be installed by a qualified technician only.

AM loop antenna (included)

This antenna is normally sufficient for reception of AM broadcasts.

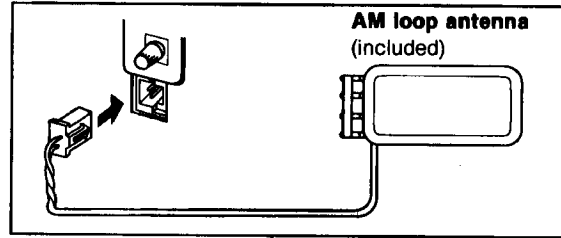

Install the AM loop antenna holder (included) at the rear panel of this unit and then attach the AM loop antenna to the AM loop antenna holder (facing in the direction of best reception).

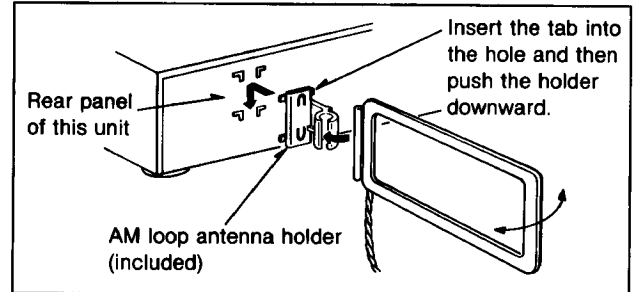

Pay attention to the following points when mounting the antenna.

- Do not mount it horizontally (Doing so will impair reception).
- Do not mount it close to power cords, speaker wires or metal surfaces (Doing so will result in noise).
- Do not mount it close to a tape deck. When the tape deck is being used, chirping or beeping sounds may result.

When mounting the antenna to a column, a wall or rack

Mount it vertically.

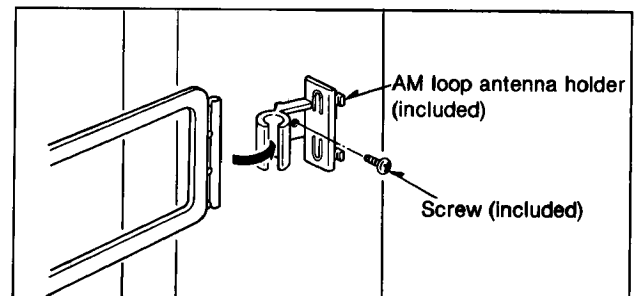

AM outdoor antenna (not included)

The outdoor antenna should be used when using the main unit in mountainous areas or in spaces enclosed by reinforced concrete where the AM loop antenna (included) does not provide satisfactory reception.

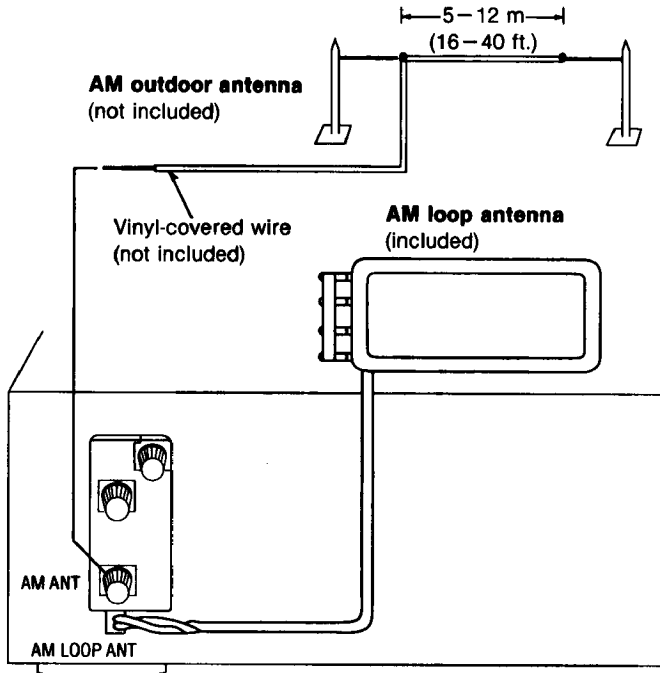

Stretch 5-12 m (16-40 ft.) of vinyl-covered wire horizontally across a window frame or other convenient location, keeping it as high as possible from the ground.

When the unit is not in use, disconnect the outdoor antenna to prevent possible damage that may be caused by lightning. Never use an outdoor antenna during an electrical storm.

Note

Be sure to connect the AM loop antenna even when an outdoor antenna is used.

Placement of speakers

As well as enjoying normal stereo reproduction with the left and right front speakers, a center speaker and surround speakers can also be connected to the main unit in order to enjoy the sound performance of Dolby Pro Logic Systems and the SFC function.

The illustration below shows where to place the speakers so as to best enjoy sound with Dolby Pro Logic systems and the SFC function.

We recommend that surround speakers be placed on the side of or slightly behind the listener, and about one meter higher than ear level.

However the position should be adjusted to your personal preference, because the effect varies to some degree depending upon the type of music and the music source.

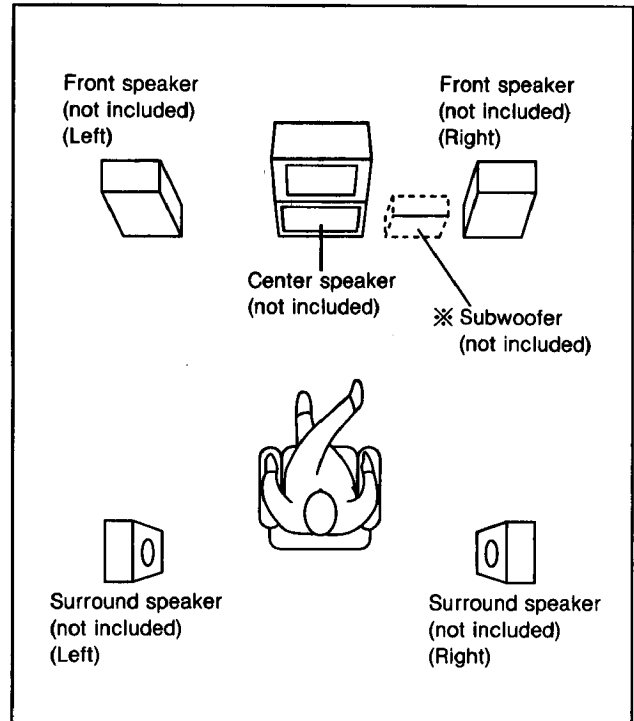

※ The subwoofer can be placed in any position.

Connection of front speakers

To connect to the "A" terminals

For SA-GX790/GX690/GX490

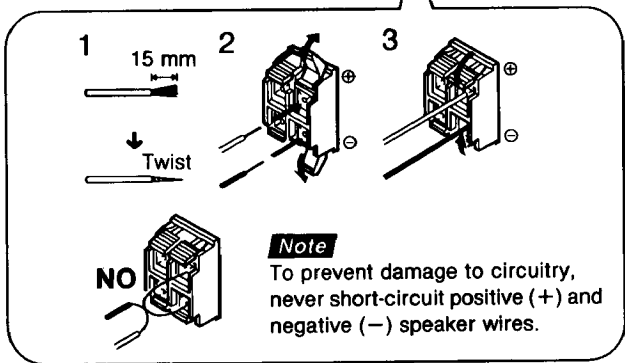
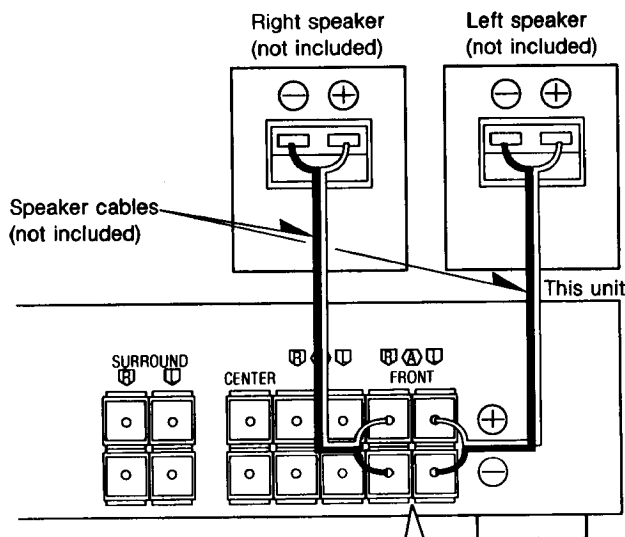

To connect to the "B" terminals

SA-GX790/GX690/GX490 only

For connection to a second pair of speakers.

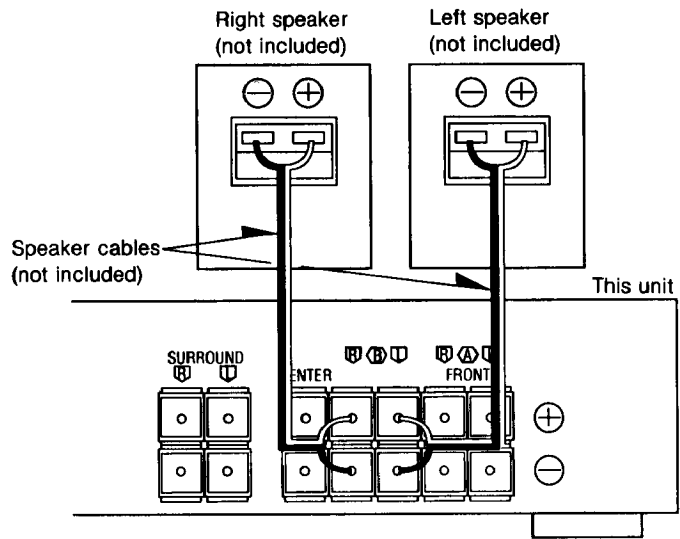

Speaker impedance

For SA-GX790/GX690/GX490

When only the "A" or only the "B" speakers are connected:

For SA-GX490	8 Ω
For SA-GX790/GX690	4-8 Ω

Note (SA-GX790/GX690 only)

If connecting speakers of less than 8 Ω, be sure to set the impedance on the main unit to LOW as described below.

POWER ON

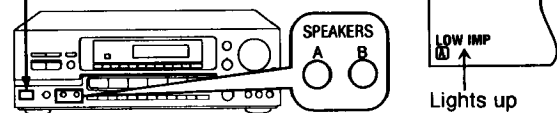

Hold down either button A or button B for 4 seconds or more.

(Hold down once again for 4 seconds or more to turn it off.) Note that when this indicator is lit up, speakers A and B cannot be used at the same time.

To change a speaker:

e.g. To use speaker B, press A and the [A] indicator goes out, press B to activate speaker B.

When both the "A" and the "B" speakers are connected simultaneously: For SA-GX790/GX690/GX490 8 Ω

For SA-GX390/GX290

The impedance of any speaker used with this unit must be 8 Ω.

For SA-GX390/GX290

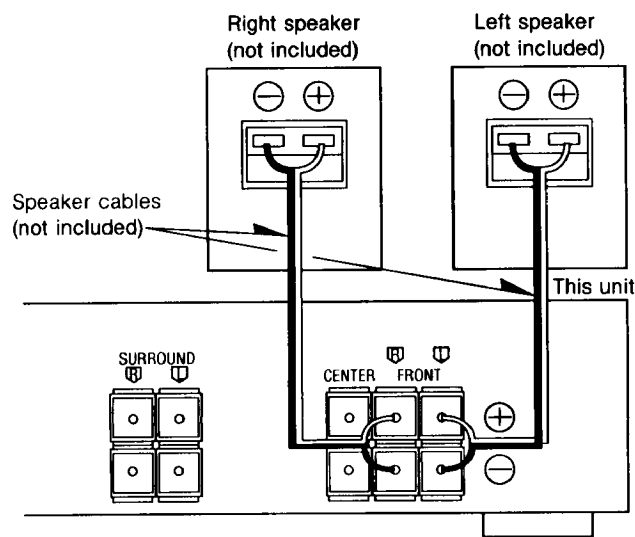

Connection of surround speakers

For SA-GX790/GX690/GX490

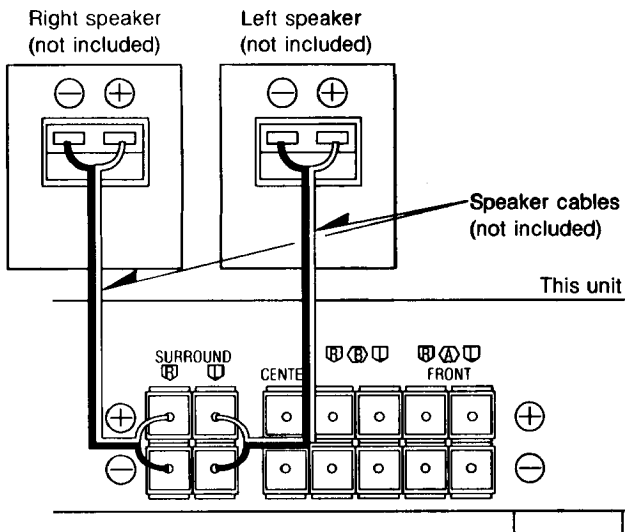

For SA-GX390/GX290

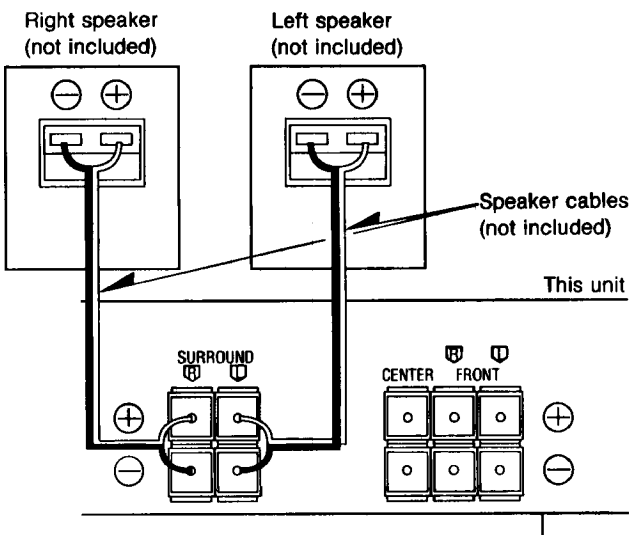

Note

1. Before sound can be heard, both surround speakers must be connected.
2. Do not connect the surround speakers to the front speaker terminals. The surround speakers may be damaged if connected to the front terminals due to the output power difference between the front and surround terminals.

Speaker Impedance

The impedance of any speaker used with this unit must be 4–8 Ω.

Connection of center speaker

Note

Before sound can be heard, the SURROUND mode or 3 STEREO mode (of the Dolby Pro Logic system) must be on.

For SA-GX790/GX690
GX490

For SA-GX390/GX290

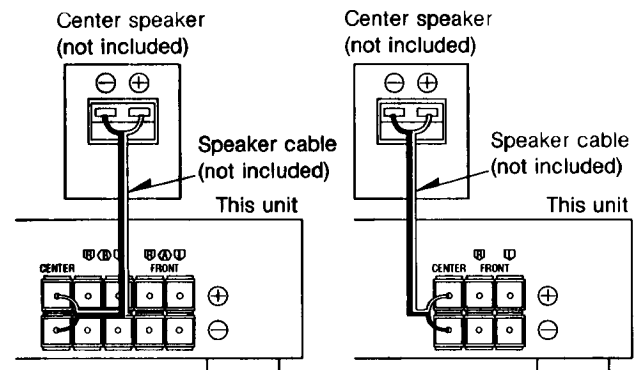

Speaker impedance

The impedance of any speaker used with this unit must be 8 Ω.

Connection of subwoofer

SA-GX790/GX690 only

The subwoofer is connected when bass sounds are inadequately reproduced because front speakers are too small.

When connected, the subwoofer can be placed in any position.

Note

This unit has no amplifier section designed especially for the subwoofer, so it is necessary to purchase a subwoofer with a built in amplifier or buy the two separately.

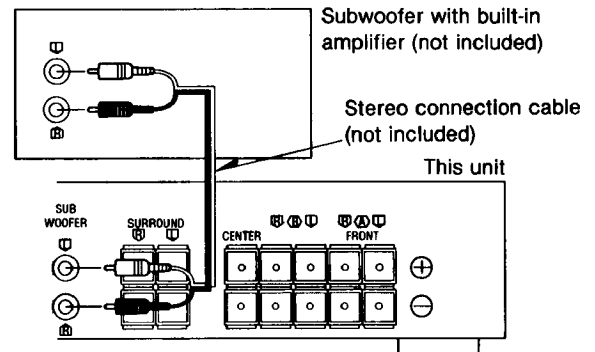

Connecting a subwoofer which does not have a built-in amplifier

Connect an optional amplifier to the "SUBWOOFER" terminals of this unit and then connect a subwoofer to the speaker terminals of the amplifier.

For your reference:

The level of sound output from the subwoofer will always be at 80 Hz or less, regardless of the settings of the speaker select buttons on this unit, thus the intensity of the low frequency range will be maintained.

When adjusting the volume of the subwoofer

After setting the volume control on the subwoofer or on the amplifier which is connected to the subwoofer, make any further adjustments with the volume control on this unit.

Basic operations

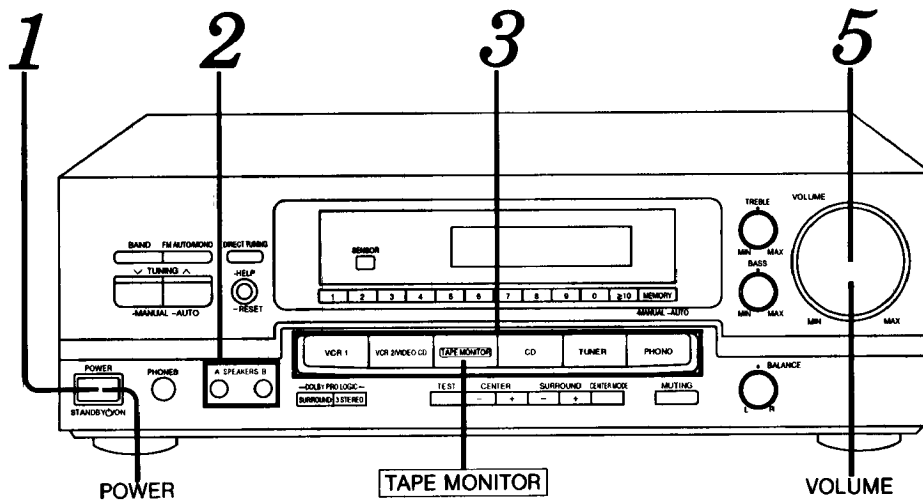

- Before operation, set VOLUME to the "MIN" position.
- When viewing a video, turn on the power supply for the TV and set the TV to video mode.

1 Press **POWER**.

2 For SA-GX790/GX690/GX490
A SPEAKERS B Press **A and/or B** to select the speaker system(s) to be used.

A and B refer to the speaker terminals at the rear of the unit.

Caution
Before selecting your speaker system, make sure impedance is correct in the speakers you want to use. (See page 10.)

Lights up

If the button is pressed once more, the indicator will switch off and no sound will be heard from the speakers.

For SA-GX390/GX290
SPEAKERS Press **SPEAKERS** and check the "ON" indication lights up.

Lights up

If the button is pressed once more, the indicator will switch off and no sound will be heard from the speakers.

3 Press to select the desired source.

Source	Button	
	SA-GX690/GX490/ GX390/GX290	SA-GX790
Video tapes (VCR 1)	VCR 1	VCR 1
Video tapes (VCR 2)	VCR 2/VIDEO CD	VCR 2
Video CD	VCR 2/VIDEO CD	CD/VIDEO CD
Tape	TAPE MONITOR	TAPE MONITOR
	The tape monitor indicator will light up.	
Compact discs	CD	CD/VIDEO CD
Radio broadcasts	TUNER	TUNER
Phono discs	PHONO	PHONO

The selected video source is output from the "TV (MONITOR OUT)" terminal on the back of the unit.

Video source

4 Start the desired source.
(Refer to the appropriate operating instructions for details.)

5 Turn **VOLUME** to adjust the volume level.

After listening is finished
Be sure to reduce the volume level, and switch the power to the standby condition by pressing POWER.

When the tape monitor indicator is lit or flashing
This indicates that the tape monitor function of this unit is ON. To listen to sources other than a tape, be sure to press **TAPE MONITOR** and check the indicator goes out.

Lit or flashing

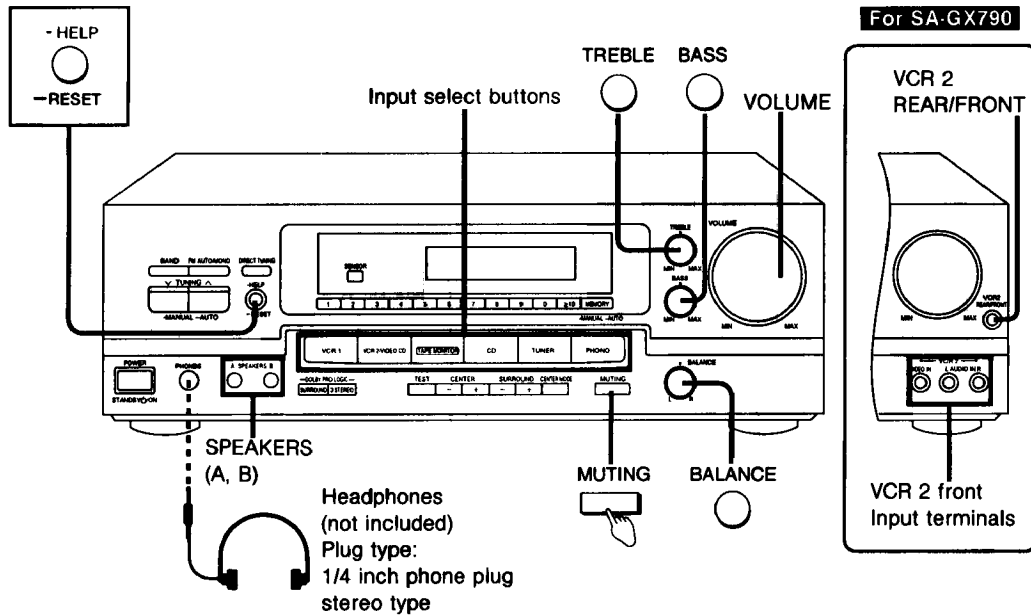

If sound output stops during use or if you are unsure what to do

-HELP



Press -HELP. (Touch only.)

The help function can be used to display operations you are expected to do. For details, see page 22.

To adjust the tone quality

TREBLE



Turn **TREBLE** to adjust the high frequency sound.

BASS



Turn **BASS** to adjust the low frequency sound.

To mute the sound level

For SA-GX490/GX390/GX290

MUTING

Press MUTING.

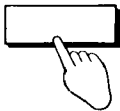

For SA-GX790/GX690

-MUTING
-LOUDNESS

Press -MUTING. (Touch only.)



The message "MUTING ON NOW" runs repeatedly from right to left across the display as long as the muting function is on.

Press once again to return to the previous volume level.

To adjust the sound balance

BALANCE



Turn **BALANCE** to adjust the left/right sound balance.

To emphasize low frequency sound

SA-GX790/GX690 only

-MUTING
-LOUDNESS

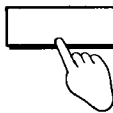

Press -LOUDNESS until the "LOUDNESS" lights up.

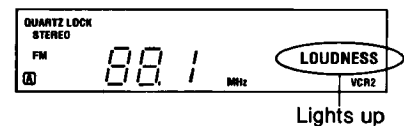

Lights up

To return to the previous condition, hold down the button until the "LOUDNESS" indication turns off.

To listen through headphones

Use **VOLUME** to reduce the volume level, and connect the headphones.

For SA-GX790/GX690/GX490

If you do not want sound from the speakers, press **SPEAKERS (A)** and **(B)** and check the speaker select indicators go out.

For SA-GX390/GX290

If you do not want sound from the speakers, press **SPEAKERS** and check the "ON" indication goes out.

Note

Avoid listening for prolonged periods of time to prevent hearing damage.

To switch the VCR to the front or rear "VCR 2" terminal SA-GX790 only

1. Press **VCR 2** (Input select button).
2. Press **VCR 2 REAR/FRONT**.

(Either "REAR" and "FRONT" will appear on the display and will change each time you press the button.)

Listening to radio broadcasts

Direct access tuning

Specify the frequency using the numeric buttons to directly tune to the desired broadcast station.

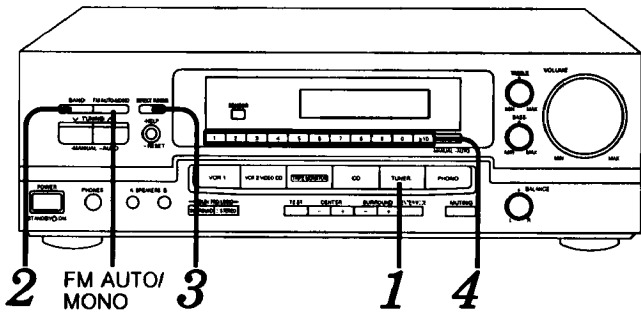

- 1 **TUNER** Press **TUNER**.
- 2 **BAND** Press **BAND** to select "FM" or "AM".

Lights up
- 3 **DIRECT TUNING** Press **DIRECT TUNING**.

Flashes

While cursor display is flashing (approx. 10 seconds)
- 4 **1 2 3 4 5 6 7 8 9 0** Press the appropriate numeric buttons to enter the frequency.

Tuning intervals
 FM: 0.1 MHz
 AM: 10 kHz

If the desired FM frequency is 107.9 MHz

1 → 0 → 7 → 9

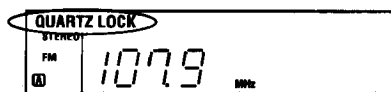

Lights up when tuned

If the frequency has been input correctly, the displayed frequency will blink once.

Note

1. If no button is pressed while the cursor display is flashing, the display will return to the frequency which is currently being received. To re-specify the frequency, repeat the procedure from step 3.
2. If the frequency has not been input correctly, "ERROR" indication will be displayed. In this case, re-enter the frequency.

Sequential tuning

If the frequency is not known, use the tuning buttons to search for it.

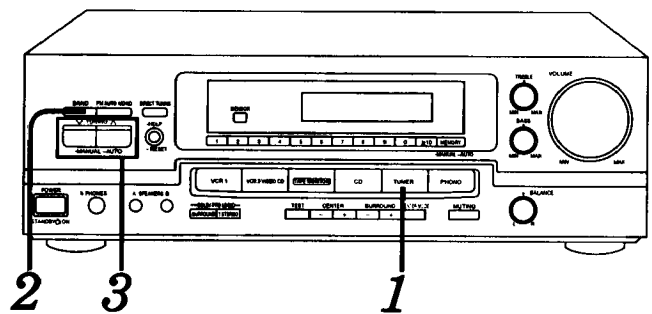

- 1 **TUNER** Press **TUNER**.
- 2 **BAND** Press **BAND** to select "FM" or "AM".

Lights up
- 3 **TUNING** Press **∇** or **∧** to tune to the desired broadcast.

Tuning Intervals
 FM: 0.2 MHz
 AM: 10 kHz

If either button is held down for an instant until the frequency begins to scroll, the broadcast stations can be tuned in automatically when a broadcast station is found.

Note

Tuning may stop automatically if any jamming is encountered.

When the FM stereo broadcast is received

This unit will automatically switch to FM stereo reception and the "STEREO" indication will light up.

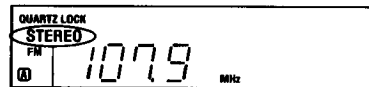

Lights up when a stereo broadcast is tuned in

If noise is excessive in the FM stereo mode

Press FM AUTO/MONO. (The FM stereo indicator will switch off.) The broadcast will be monaural, but noise will be reduced. If the button is pressed once more, the stereo mode will be resumed.

Preset tuning

By presetting the desired broadcast stations into the memory channels of this unit, broadcast stations can be selected simply by pressing numeric button(s). (Refer to page 16 for tuning.)

Before presetting

How many broadcast stations can be preset?

A total of 30 FM and AM stations can be preset.

How is presetting done?

The two following methods are available.

① Automatic memory presetting

Automatic memory presetting allows this unit to automatically search for broadcast stations and then preset them into memory.

With this function, searching proceeds from the frequency currently being displayed and continues through higher frequencies, (up to 107.9 MHz for FM, up to 1710 kHz for AM) and broadcast stations are preset in the order in which they are located.

With this method, the channels that can be preset into the memory are set as follows for different bands (FM or AM).

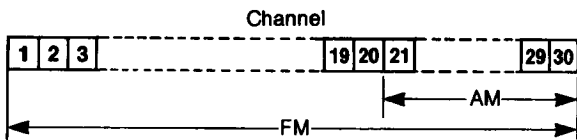

For FM broadcast stations 1-30
For AM broadcast stations 21-30

If the FM stations (channels 1-30) are preset and then the AM stations (channels 21-30) are preset

Because this unit can accommodate a total of 30 preset channels, the settings for FM channels 21-30 will be replaced by the AM settings which were subsequently preset, and the channel allotment will be as shown below.

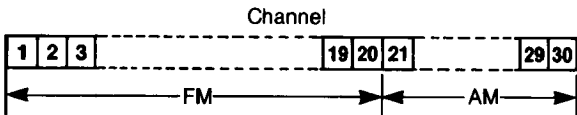

For FM broadcast stations 1-20
For AM broadcast stations 21-30

② Manual memory presetting

The desired broadcast stations can be preset into the desired channels by the user.

This can also be used as a method for changing selected broadcast stations that were preset in "Automatic memory presetting".

Please remember this

If a new broadcast station is preset into a channel, the setting for the broadcast station which was previously entered in that channel will be automatically erased.

Automatic memory presetting

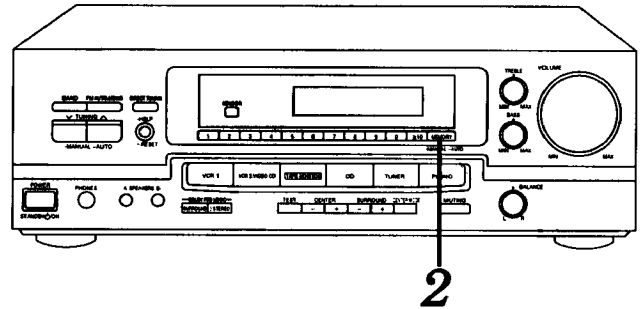

Set to the frequency from which you want to start automatic memory presetting. (See page 14.)



Press MEMORY until the frequency begins to change.

(Automatic memory presetting will start.)

During automatic memory presetting, the memory indicator will flash while the frequency scrolls.

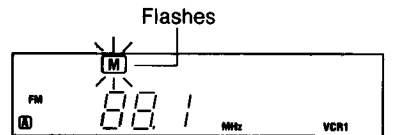

To stop, press MEMORY once again.

When a broadcast station is preset

The memory indicator and the preset channel number will be displayed for approximately 1 second.

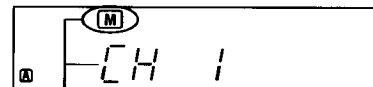

Lights up

When presetting is completed

The last broadcast station to be preset will be displayed.

Note

Frequencies may not be preset correctly in cases where the broadcast waves are too strong or too weak. In such cases, carry out presetting manually.

Preset tuning (continued)

Manual memory presetting

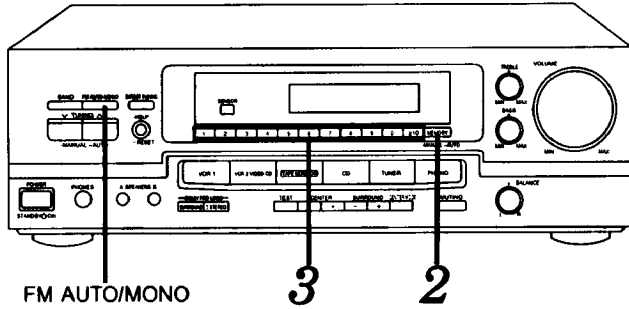

1/ Set to the desired broadcast.
 (See page 14.)
 If interference or static is keeping you from enjoying an FM broadcast, press FM AUTO/MONO and change to monaural. You can preset the memory in monaural just as in stereo.

2/ Press MEMORY. (Touch only.)

Diagram showing a hand touching the 'MEMORY' button. Below it, the display shows 'QUARTZ LOCK STEREO' with an 'M' icon, 'FM 107.9 MHz', and 'Lights up'.

To cancel the memory function, press MEMORY again.

3/ Specify the desired channel to be preset using the numeric button(s) (completes presetting).

Diagram showing a hand pointing to the '1' and '2' buttons on the numeric keypad.

To designate channels 1–9
 Press the appropriate (1–9) preset-tuning button.
To designate channels 10–30
 (Example: Channel 12)

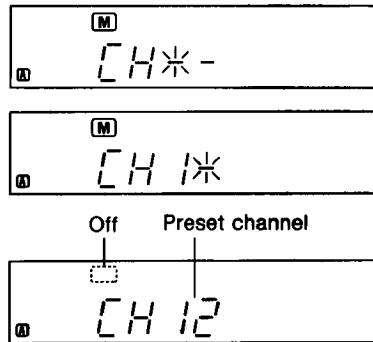
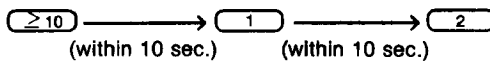

Once completed step 3, the display reverts back to step 1.

To continue presetting

Repeat steps 1 through 3.

To listen to preset broadcast stations

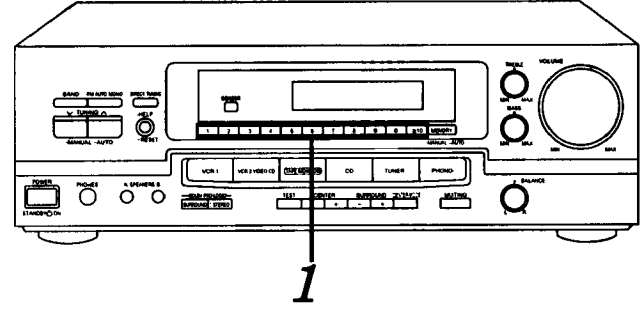

1/ Specify the preset channel using the numeric button(s).

Diagram showing a hand pointing to the '1' and '2' buttons on the numeric keypad.

To designate channels 1–9
 Press the appropriate (1–9) preset-tuning button.
To designate channels 10–30
 (Example: Channel 12)

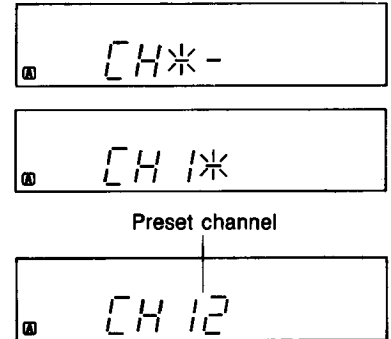
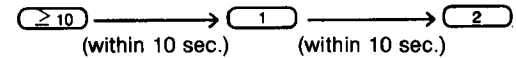

After the preset channel is displayed, the frequency of the selected channel is displayed.

To confirm the channel number of the broadcast station being received

Press TUNER.
 (The channel number will be displayed for about one second.)

Note

The channel number is not displayed if you change the reception frequency or FM mode setting.

For your reference

Even if the power is switched to standby or the power cord is disconnected from the household AC outlet, the memory will retain its contents for approximately one month.

If frequency presettings are accidentally erased

Make the presettings once again.
 The power cord should remain connected for one hour or more for the memory back-up to be effective.

Enjoying sound with DOLBY PRO LOGIC

By combining front, center and surround speakers, you can enjoy the SURROUND mode which conveys a feeling of presence or the 3 STEREO mode which conveys a feeling of orientation.

SURROUND

By reproducing the feeling of depth and movement of sound, video software or compact discs recorded with Dolby Surround provide the listener with a feeling of presence like that of a movie theater.

Also, to enjoy a theater like sound with all the emotion of Dolby Pro Logic and a full stereo effect, this stereo comes with a THEATER EFFECT function which spreads out the sound as actually happens at the theater.

To enjoy SURROUND, be sure to connect the surround speakers.

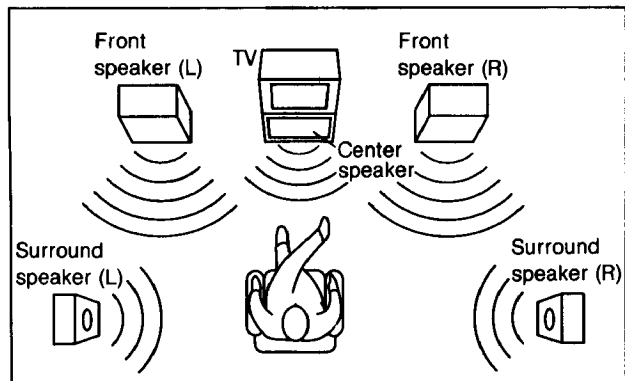

3 STEREO

You can enjoy audio/visual sources with clear sound, more presence and a good feeling of orientation. 3 STEREO can be used with non DOLBY SURROUND recordings.

To enjoy 3 STEREO, be sure to connect the center speaker.

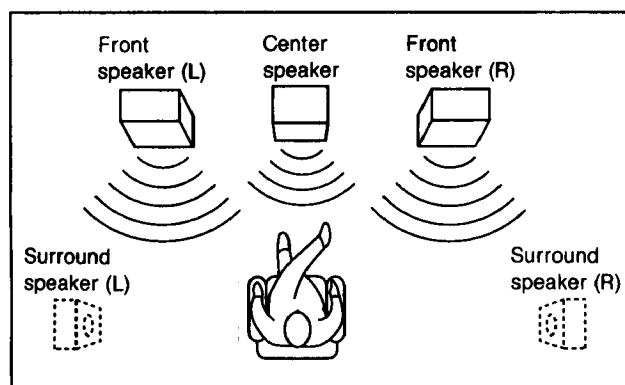

Manufactured under license from Dolby Laboratories Licensing Corporation. Additionally licensed under Canadian patent number 1,037,877.

"Dolby", "Pro Logic" and the double-D symbol are trademarks of Dolby Laboratories Licensing Corporation.

Setting the center mode

For Dolby Pro Logic systems, center mode setting is necessary to play back bass sounds effectively.

Set the center mode in accordance with the size of your center speaker.

For SA-GX490/GX390/GX290

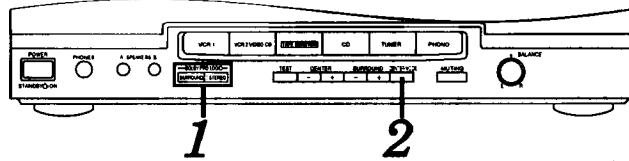

For SA-GX790/GX690

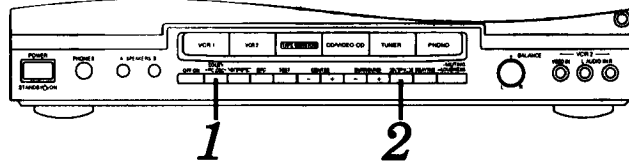

1 For SA-GX490/GX390/GX290
Press **SURROUND** or **3 STEREO** to turn on the desired mode.

or
Pressing the same button again turns off the activated listening mode.

For SA-GX790/GX690

Press **PRO LOGIC** to turn on the Dolby Pro Logic systems and select the desired mode.

When the button is pressed, the current mode is displayed.

Pressing it again changes the Dolby Pro Logic mode.

For SURROUND mode For 3 STEREO mode

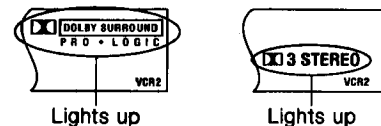

2 Press **CENTER MODE** to select the correct center mode.

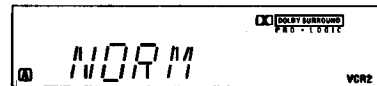

When the button is pressed, the current center mode is displayed.

Pressing it again changes the center mode.

NORM (NORMAL)

When the center speaker is smaller than the front speakers

WIDE (WIDEBAND)

When the center speaker is the same or larger size as the front speakers

PHAN (PHANTOM) SURROUND only

When no center speaker is connected.

Note

In the PHANTOM mode, the sound which would have been sent to the center speaker will be divided equally between both the left and right front speakers.

Adjusting speaker output level

In order to reproduce the movement of the sound and its clear orientation, it is important to adjust the output level of each speaker. Adjust output to the correct levels while listening to the test signal.

For SA-GX490/GX390/GX290

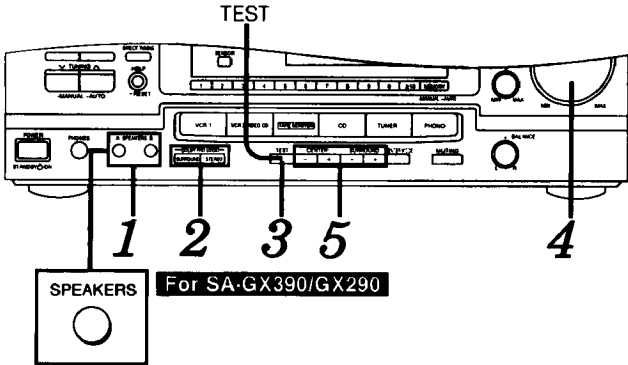

For SA-GX790/GX690

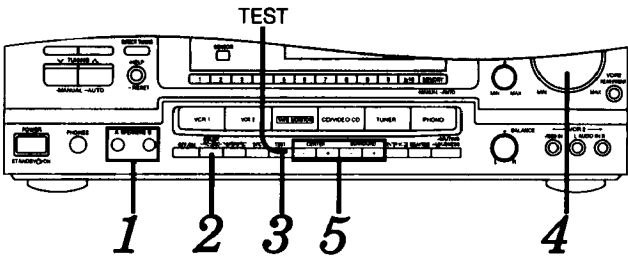

1 For SA-GX790/GX690/GX490
Press A or B to select the speaker system to be used.



or



For SA-GX390/GX290
Press SPEAKERS and check the "ON" indication lights up.

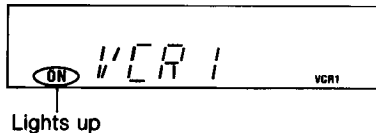

2 For SA-GX490/GX390/GX290
Press SURROUND or 3 STEREO to turn on the desired mode.



or



Pressing the same button again turns off the activated listening mode.

For SA-GX790/GX690

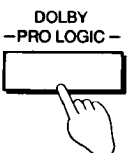

Press PRO LOGIC to turn on the Dolby Pro Logic systems and select the desired mode.

3 Press TEST to output a test signal.

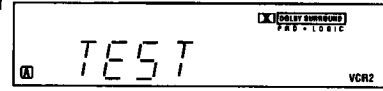
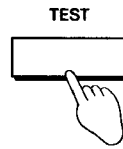

The test signal is emitted in the following order:

For SURROUND mode

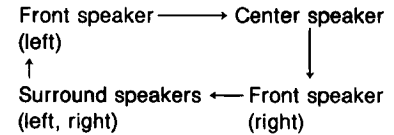

Note

The test signal is not emitted from the center speaker when the center mode is on PHANTOM.

For 3 STEREO mode

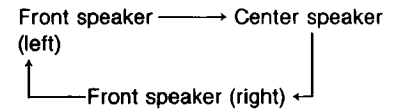

4 Turn VOLUME to set the volume level normally used for enjoying the source.

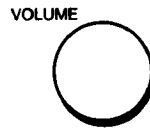

5 Press CENTER (-) or (+) or SURROUND (-) or (+) to adjust the output level balance.

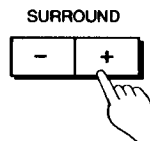
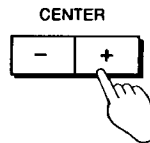

Adjust the output level of each speaker from the listening position until they are all identical.
- : Decrease the output level.
+ : Increase the output level.

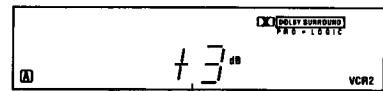

Output level can be varied within a range of -12 dB to +12 dB according to that output from the front speakers.

Note

1. The test signal is output only by the speaker you are now adjusting and does not repeat the sequence until adjustments are complete.
2. Remember you cannot adjust output level of the surround speakers if you selected the 3 stereo mode in step 2.

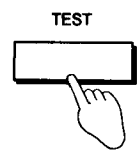

To stop the test signal
Press TEST.

Adjusting the delay time

SA-GX790/GX690 only

When enjoying with SURROUND only

Adjust the sound from the surround speakers until the proper effect is produced.

The diagram below shows SA-GX790.

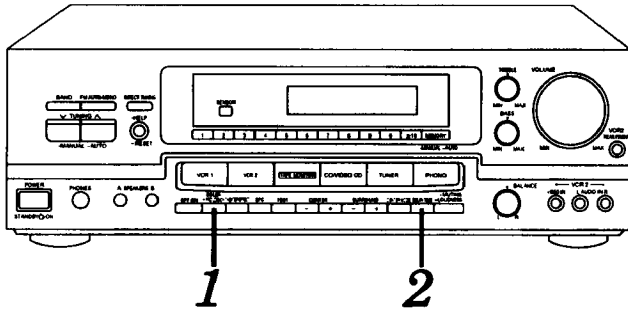

1 **DOLBY -PRO LOGIC-** Press **PRO LOGIC** to turn on the Dolby Pro Logic systems and select the **SURROUND** mode.

2 **DELAY TIME** Press **DELAY TIME** to set to the suitable time. When the button is pressed, the current delay time is displayed, pressing it again changes the delay time.

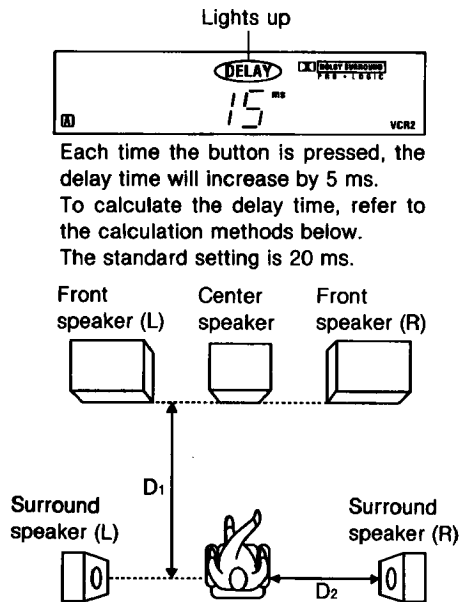

D_1 : Distance from front speakers
 D_2 : Distance from surround speakers

- If D_1 is equal to or less than D_2
Set to 15 ms.
- If D_2 is less than D_1
Start at 15 ms and increase by 5 ms for every 5 feet of difference between D_1 and D_2 .

Enjoying with SURROUND or 3 STEREO

For SA-GX490/GX390/GX290

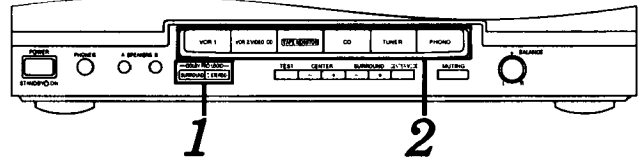

For SA-GX790/GX690

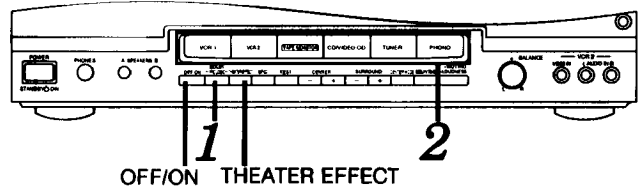

1 **For SA-GX490/GX390/GX290**
SURROUND Press **SURROUND** or **3 STEREO** to turn on the desired mode.
or
3 STEREO Pressing the same button again turns off the activated listening mode.

For SA-GX790/GX690
DOLBY -PRO LOGIC- Press **PRO LOGIC** to turn on the Dolby Pro Logic systems and select the desired mode.

2 **VCR 1** **VCR 2** **PHONO** Select the desired source.

3 Start the desired source.
Note
 When employing SURROUND, use software recorded in Dolby Surround.

OFF/ON To turn off the Dolby Pro Logic systems
 Press OFF/ON.
 Press once again to turn it on.

To enjoy THEATER EFFECT SA-GX790 only

Use video software recorded in Dolby surround.

Note
 The THEATER EFFECT works only when the surround mode is ON.

THEATER EFFECT Select the surround mode with the above procedure, and then press THEATER EFFECT.

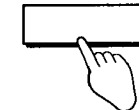

Lights up

Press once again to turn it off.

Enjoying sound with SFC SA-GX790/GX690 only

The SFC function gives presence and spread thereby enhancing and enriching the music or movie.
The diagram shows SA-GX790.

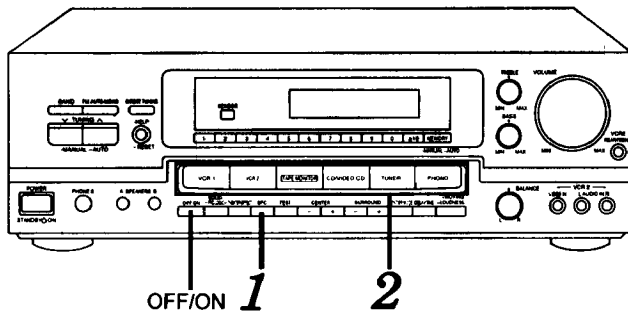

1 **SFC**
Press SFC to turn on the SFC function and select the desired mode.
When the button is pressed, the current mode is displayed. Pressing it again changes the SFC mode.

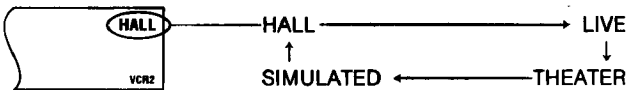

HALL
This mode imparts a reflection and spread which will make you feel as if you are in a large concert hall.

LIVE
Primarily for vocal pieces, this mode adds gloss to the vocals and you'll feel as though you were hearing a live stage performance.

THEATER
You can clearly perceive the directions and source of the movie. Real ambience of sound can also be recreated naturally using this mode.
THEATER mode can be used with stereo sources not encoded with DOLBY SURROUND.

Note
When using Dolby surround encoded source materials, select the DOLBY PRO LOGIC SURROUND.

SIMULATED
Choose this mode if little or no sound will be heard from the surround speakers.
You can feel as if you were in a more expanded space adding to the actual sound from the source.
This mode also adds effect to monaural sources by outputting the sound from surround speakers.

Note
You can adjust center speaker volume only in the theater mode. The center speaker is not used in the hall, and simulated modes.

2 **Select the desired source.**

3 **Start the desired source.**

OFF/ON
To turn off the SFC function
Press OFF/ON.
Press once again to turn it on.

Adjusting field of sound

With this unit, you can adjust speaker volume and select delay time. Adjust the field of sound while listening to a source.

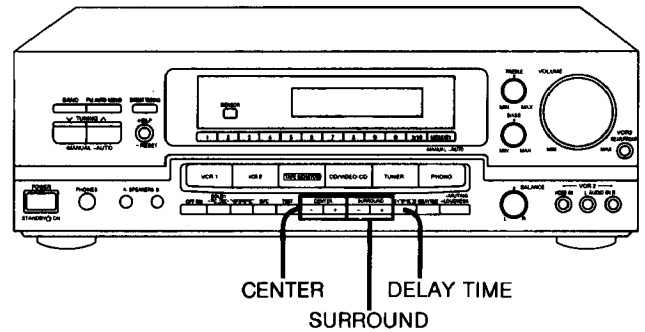

To adjust center speaker volume

CENTER **In the theater mode only**
Press **CENTER (-)** or **(+)**.

To adjust surround speaker volume

SURROUND **Press SURROUND (-) or (+).**

- : Decrease the output level.
+ : Increase the output level.

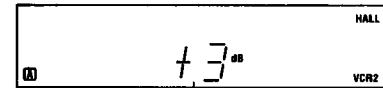

Output levels can be varied within a range of -12 dB to +12 dB according to that output from the front speakers.

To adjust the delay time

DELAY TIME **Press DELAY TIME to set to the suitable time.**
When the button is pressed, the current delay time is displayed, pressing it again changes the delay time.

As the time display increases, the feeling of the sound becomes wider.

Making a recording

Recording on the tape deck

Before recording, prepare the tape deck for recording (recording level adjustment, etc.). See the tape deck's operating instructions for details.

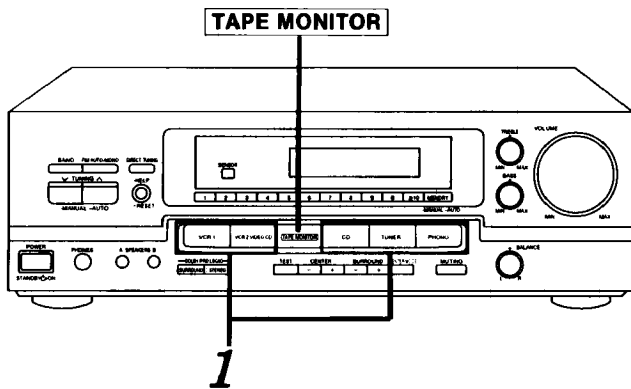

1 Select the audio/video source to be recorded.

2 Begin recording. Follow your tape deck's operating instructions.

3 Begin the audio/video source to be recorded.

To check the sound recorded while a recording is being made

With a tape deck with 3 head system, it is possible to check the sound recorded on the tape.

Press **TAPE MONITOR** on this unit and set the monitor button on the tape deck to "TAPE".

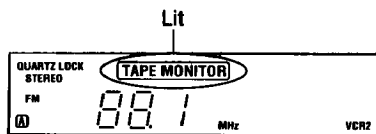

Press **TAPE MONITOR** once again to turn it off.

Recording on the VCR (VCR 1)

Before recording, prepare the VCR (VCR1) for recording (recording level adjustment, input selector setting, etc.). See the VCR's operating instructions for details.

Recording from VCR 2

For SA-GX790 only

There are VCR 2 terminals on both the front and rear of this unit. It is easier to carry out dubbing from a camcorder if it is connected to the front terminals.

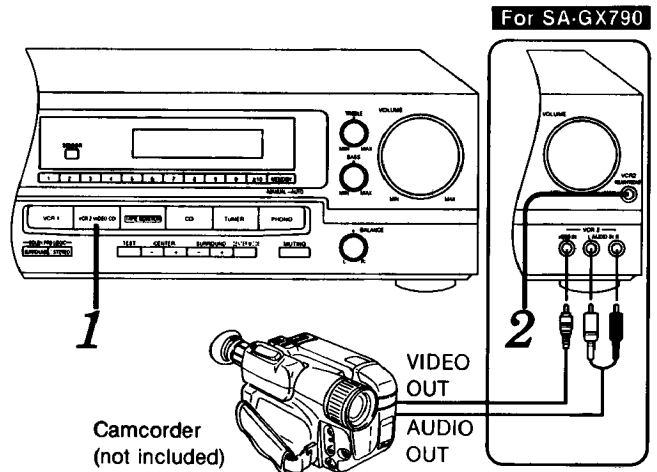

1 **For SA-GX690/GX490/GX390/GX290** Press **VCR 2/VIDEO CD**.

For SA-GX790 Press **VCR 2**.

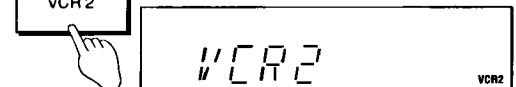

SA-GX790 only

2 Press **VCR 2 REAR/FRONT** to select the VCR for playback.

3 Begin recording on the VCR 1 and playback the tape on the VCR 2.

Follow your VCR's operating instructions.

For SA-GX690/GX490/GX390/GX290

For your reference

If a video CD changer is connected to the "VCR 2/VIDEO CD" terminals, recording from the video CD changer is possible by following the above procedure.

Making a recording

Recording on the VCR (VCR 1)

Recording from an audio source

Note

Recording from the tape deck is not possible.

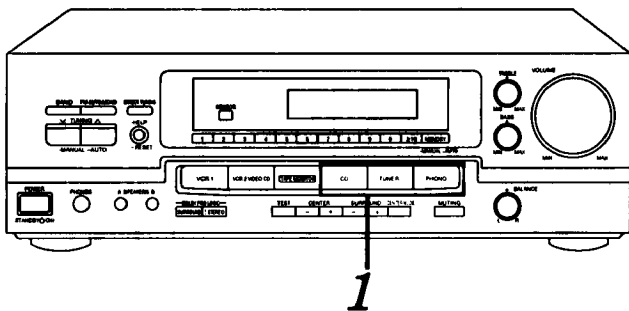

1 Select the audio source to be recorded.

2 Begin recording on the VCR 1.
Follow your VCR's operating instructions.

3 Begin the audio source to be recorded.

For SA-GX790

For your reference

If a video CD changer is connected to the "CD/VIDEO CD" terminals, you can record a picture from the video CD changer by following the above procedure.

Precautions in recording a audio source

If not recording the picture from VCR2 or a video CD player, either turn the unit OFF or select VCR1.

The unit is set such that video signals input at video input terminals "VCR2" and "VIDEO CD" are output from the "VCR1" video output terminal on the back of the stereo.

Therefore, when recording an audio source, if the VCR2 source or video CD player is playing, the picture will be recorded through VCR1.

About the HELP function

If you make a mistake in operation or if sound output stops due to some operation which was performed, the HELP function displays information which can be useful for indicating the method by which this condition can be remedied.

If "ERROR" or scrolling characters (for instance, "TAPE MONITOR ON NOW") appears on the display during operation, carry out the following operation.

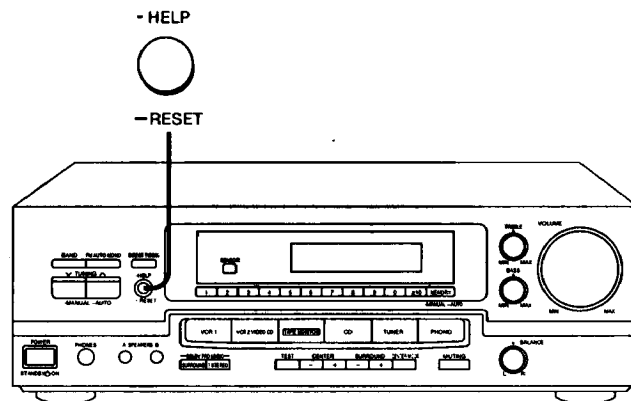

- HELP

Press -HELP. (Touch only.)

The method for remedying this situation will be displayed.

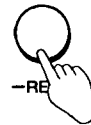

For your reference

If the above button is pressed for 2 second or more until "RESET" appears on the display, the operation settings for the unit will be initialized to the settings made at the time of shipment.

However, any broadcasting stations which have been preset into memory will not be erased at this time.

About the On-Screen Display function SA-GX790 only

The On-Screen Display function can provide a wide range of information on a TV screen making the operation even easier. For example, by using the amplifier button(s), the state of each setting will display. If there is no sound and you do not understand the operation, press the HELP button to use the unit diagram displayed on the TV to display the applicable method.

Refer to the included supplemental instruction manual for details on the On-Screen Display functions.

Product service

Do not attempt to remove the cover(s) or repair the unit yourself.

Refer servicing to qualified personnel only.

Product information

For product service, product information or assistance in product operation, refer to the servicenter directory.

Troubleshooting guide

Before requesting service for this unit, check the chart below for a possible cause of the problem you are experiencing. Some simple checks or a minor adjustment on your part may eliminate the problem and restore proper operation.

If you are in doubt about some of the check points, or if the remedies indicated in the chart do not solve the problem, refer to

the directory of authorized service centers (enclosed with this unit) to locate a convenient service center, or consult your Technics dealer for instructions.

(In U.S.A. consult MSC Authorized Servicenters for detailed instructions.)

Problem	Probable cause(s)	Suggested remedy
While listening to FM broadcasts		
An unusual hissing noise is heard when listening to the broadcast in stereo, but not heard when listening monaurally.	A slight noise may be heard because the method used for modulation of FM stereo broadcasts is different than that used for monaural broadcasts.	<ul style="list-style-type: none"> • Try reducing the treble sound by using the treble control. • Try changing the location, height and/or direction of the antenna. • If an indoor antenna is being used, change to an outdoor antenna. • Try using an antenna with more elements.
Noise is excessive in both stereo and monaural broadcasts.	Poor location and/or direction of the antenna Transmitting station is too far away.	<ul style="list-style-type: none"> • Try changing the location, height and/or direction of the antenna. • If an indoor antenna is being used, change to an outdoor antenna. • Try using an antenna with more elements.
The FM stereo indicator or the quartz lock indicator flickers, without completely illuminating.	Poor location and/or direction of the antenna Transmitting station is too far away.	<ul style="list-style-type: none"> • Try changing the location, height and/or direction of the antenna. • If an indoor antenna is being used, change to an outdoor antenna. • Try using an antenna with more elements.
Excessive distortion in the sound of stereo broadcasts.	Nearby building or mountain	<ul style="list-style-type: none"> • Try using an antenna with more elements.
While listening to AM broadcasts		
An unusual "beat" sound is heard.	The unit is being used at the same time as the television set. Interference from adjacent broadcast signals	<ul style="list-style-type: none"> • Turn off the television set, or use this unit farther away from it. • Try reducing the treble sound by using the treble control.
A low-pitched "hum" sound is heard when the broadcast is tuned.	The AM loop antenna connection wires are too close to the power cord.	<ul style="list-style-type: none"> • Place the antenna connection wires and the power cord farther apart.
A strange hissing noise is produced continuously or intermittently.	Caused by the "discharge phenomenon" and the "oscillation phenomenon" of electric appliances (such as fluorescent lights, TV, small series-type motors, rectification equipment, etc.).	<ul style="list-style-type: none"> • Try placing this unit farther away from such equipment.
Problems noted at all times		
Power will not switch ON.	The power cord plug is not completely inserted.	<ul style="list-style-type: none"> • Confirm that the power cord plug is connected completely.
No sound is heard.	Both A and B speakers are turned OFF.	<ul style="list-style-type: none"> • Press the HELP button. (The display will scroll through the causes of the problem.) Use this display as a guide to remedy the problem. • Check to be sure that all connection wires are correctly connected. • Check to be sure that the correct selector is pressed.
	The tape monitor function is ON.	
	The muting function is ON.	
	Connections are incomplete or incorrect to the speaker systems, etc.	
Sound stops during a performance, or no sound is heard when the power is switched ON. (The word "OVERLOAD" appears on the display.)	The incorrect input selector has been pressed.	<ul style="list-style-type: none"> • Switch off the power, and after determining and correcting the cause, switch ON the power once again. • Use a speaker system of the proper impedance rating.
	The protection circuitry has functioned because the positive and negative speaker connection wires are "shorted". Speaker systems with an impedance less than the indicated rated impedance of this unit are used or under severe use, such as loud volume, excessive power and in an excessively hot environment.	
The word "ERROR" appears on the display.	When the Dolby Pro Logic system is ON, both A and B speakers are turned ON.	<ul style="list-style-type: none"> • Press the HELP button. (The display will scroll through the causes of the problem.) Use this display as a guide to remedy the problem.
	When both A and B speakers are being used simultaneously, the Dolby Pro Logic system is turned ON.	

Technical specifications (IHF'78)

■ AMPLIFIER SECTION

Rated minimum sine wave

RMS power output

20 Hz—20 kHz both channels driven

0.05% total harmonic distortion

[SA-GX790]

120 W per channel (8 Ω)

[SA-GX690/GX490]

100 W per channel (8 Ω)

40 Hz—20 kHz both channels driven

0.8% total harmonic distortion

[SA-GX390/GX290]

70 W per channel (8 Ω)

1 kHz continuous power output both channels driven

0.05% total harmonic distortion

[SA-GX790] 125 W per channel (8 Ω)

[SA-GX690/GX490] 105 W per channel (8 Ω)

1 kHz continuous power output both channels driven

0.8% total harmonic distortion

[SA-GX390/GX290] 73 W per channel (8 Ω)

Total harmonic distortion

rated power at 20 Hz—20 kHz

[SA-GX790/GX690/GX490] 0.05% (8 Ω)

rated power at 40 Hz—20 kHz

[SA-GX390/GX290] 0.8% (8 Ω)

half power at 1 kHz

[SA-GX790/GX690/GX490] 0.03% (8 Ω)

[SA-GX390/GX290] 0.07% (8 Ω)

Power output at the Dolby Pro Logic operation 0.8% at 1 kHz,

Front [SA-GX790/GX690] 2 × 100 W (8 Ω)

[SA-GX490] 2 × 80 W (8 Ω)

[SA-GX390/GX290] 2 × 50 W (8 Ω)

Center [SA-GX790/GX690] 100 W (8 Ω)

[SA-GX490] 80 W (8 Ω)

[SA-GX390/GX290] 50 W (8 Ω)

Surround [SA-GX790/GX690] 100 W (8 Ω)

[SA-GX490] 80 W (8 Ω)

[SA-GX390/GX290] 50 W (8 Ω)

Low frequency damping factor 30 (8 Ω)

Load impedance

Front [SA-GX390/GX290] 8 Ω

A or B [SA-GX790/GX690] 4—8 Ω

[SA-GX490] 8 Ω

A and B [SA-GX790/GX690/GX490] 8 Ω

Center 8 Ω

Surround 4—8 Ω

Dynamic headroom

[SA-GX790/GX690/GX490] 2 dB (8 Ω)

SMPTE intermodulation distortion

0.3% (8 Ω)

Frequency response

PHONO RIAA standard curve ±0.8 dB

CD/VIDEO CD, VCR 1, VCR 2, TAPE

[SA-GX790] 7 Hz—70 kHz, ±3 dB

CD, VCR 1, VCR 2/VIDEO CD, TAPE

[SA-GX690/GX490] 7 Hz—70 kHz, ±3 dB

[SA-GX390/GX290] 10 Hz—70 kHz, ±3 dB

Input sensitivity

PHONO 0.4 mV (3 mV, IHF'66)

CD/VIDEO CD, VCR 1, VCR 2, TAPE

[SA-GX790] 27 mV (200 mV, IHF'66)

CD, VCR 1, VCR 2/VIDEO CD, TAPE

[SA-GX690/GX490/GX390/GX290]

27 mV (200 mV, IHF'66)

S/N (IHF A)

PHONO [SA-GX790/GX690/GX490]

70 dB (80 dB, IHF'66)

[SA-GX390/GX290]

70 dB (78 dB, IHF'66)

CD/VIDEO CD, VCR 1, VCR 2, TAPE

[SA-GX790] 75 dB (85 dB, IHF'66)

CD, VCR 1, VCR 2/VIDEO CD, TAPE

[SA-GX690/GX490]

75 dB (85 dB, IHF'66)

[SA-GX390/GX290]

75 dB (83 dB, IHF'66)

Input impedance

PHONO 47 kΩ

CD/VIDEO CD, VCR 1, VCR 2, TAPE

[SA-GX790] 22 kΩ

CD, VCR 1, VCR 2/VIDEO CD, TAPE

[SA-GX690/GX490/GX390/GX290] 22 kΩ

Tone controls

BASS 50 Hz, +10 to -10 dB

TREBLE 20 kHz, +10 to -10 dB

Loudness control (volume at -30 dB)

[SA-GX790/GX690] 50 Hz, +9 dB

■ FM TUNER SECTION

Frequency range 87.9—107.9 MHz

Sensitivity 11.2 dBf (2 μV, IHF '58)

50 dB quieting sensitivity

MONO 18.3 dBf (4.5 μV, IHF '58)

STEREO 38.3 dBf (45 μV, IHF '58)

Total harmonic distortion

MONO 0.2%

STEREO 0.3%

S/N

MONO 75 dB

STEREO 70 dB

Frequency response

20 Hz—15 kHz, +1 dB, -2 dB

Alternate channel selectivity 65 dB

Capture ratio 1 dB

Image rejection at 98 MHz 45 dB

IF rejection at 98 MHz 80 dB

Spurious response rejection at 98 MHz

75 dB

AM suppression 50 dB

Stereo separation

1 kHz 40 dB

10 kHz 30 dB

Carrier leak

19 kHz -35 dB

38 kHz -50 dB

Antenna terminal(s) 75 Ω (unbalanced)

■ AM TUNER SECTION

Frequency range 530—1710 kHz

Sensitivity 20 μV, 330 μV/m

Selectivity 55 dB

Image rejection at 1000 kHz 40 dB

IF rejection at 1000 kHz 60 dB

■ VIDEO SECTION

Output voltage at 1 V input

(unbalanced) 1 ± 0.1 Vp-p

Maximum input voltage 1.5 Vp-p

■ GENERAL

Power consumption

[SA-GX790] 290 W, 370 VA

(In standby condition: 2W)

[SA-GX690] 280 W, 365 VA

(In standby condition: 2W)

[SA-GX490] 255 W, 330 VA

(In standby condition: 2W)

[SA-GX390/GX290] 225 W, 290 VA

(In standby condition: 2W)

Power supply AC 120 V, 60 Hz

Dimensions (W × H × D)

[SA-GX790/GX690] 430 × 158 × 352 mm

(16-15/16" × 6-7/32" × 13-27/32")

[SA-GX490/GX390/GX290]

430 × 136 × 352 mm

(16-15/16" × 5-11/32" × 13-27/32")

Weight [SA-GX790/GX690] 9.8 kg (21.6 lb.)

[SA-GX490] 8.6 kg (19 lb.)

[SA-GX390/GX290] 7.6 kg (16.8 lb.)

Notes:

1. Specifications are subject to change without notice. Weight and dimensions are approximate.

2. Total harmonic distortion is measured by the digital spectrum analyzer.

Matsushita Consumer Electronics Company, Division of Matsushita Electric Corporation of America
One Panasonic Way Secaucus, New Jersey 07094

Panasonic Sales Company, Division of Matsushita Electric of Puerto Rico, Inc. ("PSC")
Ave. 65 de Infantería, Km. 9.5
San Gabriel Industrial Park, Carolina, Puerto Rico 00985

Matsushita Electric of Canada Limited
5770 Ambler Drive, Mississauga, Ontario L4W 2T3

RQT2753-P

H1194C0