

Compact Disc Player

Operating Instructions



CDP-CX151

WARNING

To prevent fire or shock hazard, do not expose the unit to rain or moisture. To avoid electrical shock, do not open the cabinet. Refer servicing to qualified personnel only.

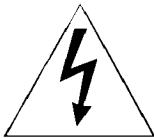
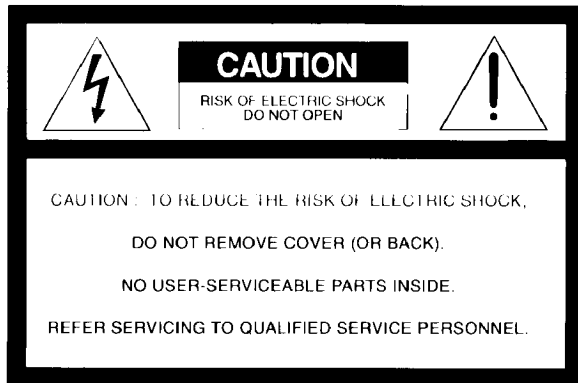

This symbol is intended to alert the user to the presence of uninsulated "dangerous voltage" within the product's enclosure that may be of sufficient magnitude to constitute a risk of electric shock to persons.



This symbol is intended to alert the user to the presence of important operating and maintenance (servicing) instructions in the literature accompanying the appliance.

INFORMATION

This equipment has been tested and found to comply with the limits for a Class B digital device, pursuant to Part 15 of the FCC Rules. These limits are designed to provide reasonable protection against harmful interference in a residential installation. This equipment generates, uses, and can radiate radio frequency energy and, if not installed and used in accordance with the instructions, may cause harmful interference to radio communications. However, there is no guarantee that interference will not occur in a particular installation. If this equipment does cause harmful interference to radio or television reception, which can be determined by turning the equipment off and on, the user is encouraged to try to correct the interference by one or more of the following measures:

Reorient or relocate the receiving antenna.

Increase the separation between the equipment and receiver.

- Connect the equipment into an outlet on a circuit different from that to which the receiver is connected.
- Consult the dealer or an experienced radio/TV technician for help.

CAUTION

You are cautioned that any changes or modification not expressly approved in this manual could void your authority to operate this equipment.

Owner's Record

The model and serial numbers are located at the rear of the unit.

Record the serial number in the space provided below. Refer to them whenever you call upon your Sony dealer regarding this product.

Model No. CDP-CX151

Serial No. _____

This equipment is intended for home entertainment purposes only. The warranty shall be invalidated if used in commercial environments, such as by disc jockeys, etc., even within the Warranty Period.

Welcome!

Thank you for purchasing the Sony Compact Disc Player. Before operating the unit, please read this manual thoroughly and retain it for future reference.

About This Manual

The instructions in this manual are for model CDP-CX151.

Conventions

- Instructions in this manual describe the controls on the player. You can also use the controls on the remote if they have the same or similar names as those on the player.
- The following icons are used in this manual:



Indicates that you can do the task using the remote.



Indicates tips for making the task easier and hints.

TABLE OF CONTENTS

Getting Started

Unpacking	4
Hooking Up the System	4

Playing CDs

Inserting CDs	6
Playing CDs	7
Using the Display	8
Locating a Specific Disc	9
Specifying the Next Disc to Play	9
Locating a Specific Track or a Point in a Track	10
Playing Repeatedly	10
Playing in a Random Order (Shuffle Play)	11
Creating Your Own Programs (Program Play)	12
Playing Using a Timer	14

Storing Information About CDs (Custom Files)

What You Can Do With the Custom Files	15
Labeling Discs (Disc Memo)	15
Storing Specific Tracks (Delete Bank)	16
Grouping Discs (Group File)	17

Additional Information

Precautions	20
Notes on CDs	20
Troubleshooting	21
Specifications	21

Index	22
-------------	----

Unpacking

Check that you received the following items:

- Audio connecting cord (1)
- Remote commander (remote) (1)
- Sony SUM-3 (NS) batteries (2)
- CD booklet holder (1) and labels (2)

How to use the CD booklet holder

The CD booklet holder helps you locate the disc easily. After you have inserted discs into the player, you can put the CD booklet (which comes with a CD) in the supplied holder. Put 2 CD booklets facing back to back into a pocket. Stick the number label on each pocket, matching the number of the disc slot where you have inserted the disc. You can put up to 100 CD booklets into the holder.

Inserting batteries into the remote

You can control the player using the supplied remote. Insert two size AA (R6) batteries by matching the + and - on the batteries. When using the remote, point it at the remote sensor  on the player.

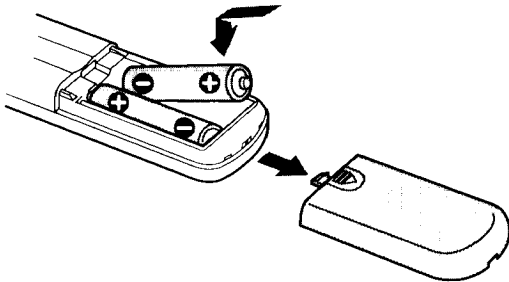

When to replace batteries

With normal use, the batteries should last for about six months. When the remote no longer operates the player, replace all the batteries with new ones.

Notes

- Do not leave the remote near an extremely hot or humid place.
- Do not drop any foreign object into the remote casing, particularly when replacing the batteries.
- Do not expose the remote sensor to direct sunlight or lighting apparatuses. Doing so may cause a malfunction.
- If you do not use the remote for an extended period of time, remove the batteries to avoid possible damage from battery leakage and corrosion.

Hooking Up the System

Overview

This section describes how to hook up the CD player to an amplifier. Be sure to turn off the power of each component before making the connections.

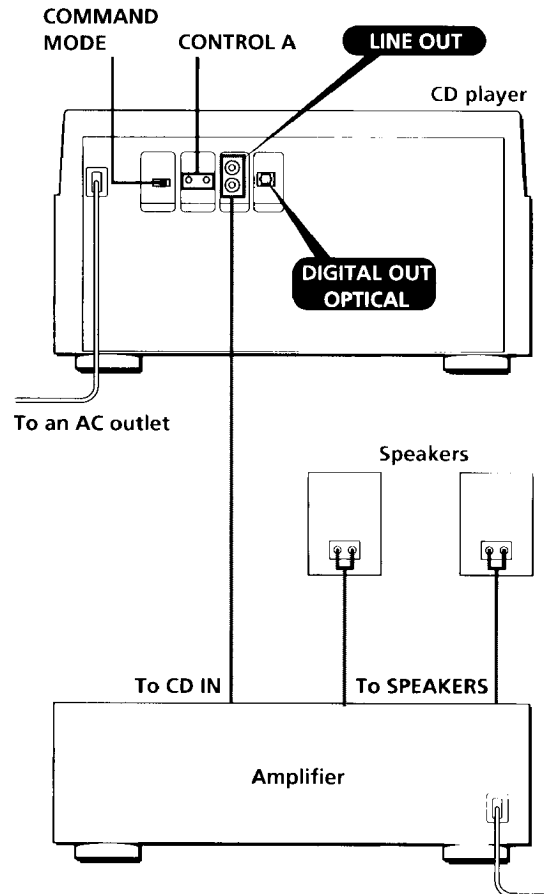

What cords will I need?

Audio cord (supplied) (1)



Hookups

When connecting the audio cord, be sure to match the color-coded cord to the appropriate jacks on the components: Red (right) to Red and White (left) to White. Be sure to make connections firmly to avoid hum and noise.

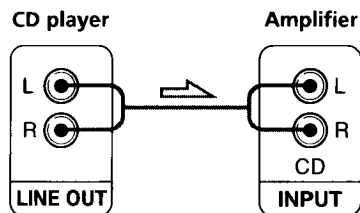

- If you have a digital component such as a digital amplifier, D/A converter, DAT or MD

Connect the component via the DIGITAL OUT (OPTICAL) connector using the optical cable (not supplied). Take off the cap and plug in the optical cable.

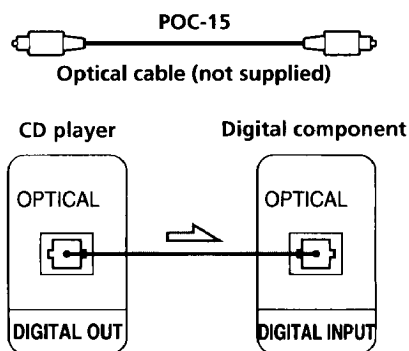

Note

When you connect via the DIGITAL OUT (OPTICAL) connector, noise may occur when you play CD software other than music, such as a CD-ROM.

💡 When to use the CONTROL A connectors and the COMMAND MODE selector

You can control two or three of these players by connecting them to the controller unit, which will be available in the future, via the CONTROL A connectors. When making the CONTROL A connection, set the COMMAND MODE selector to the appropriate position. For normal use, leave the selector at the CD1 position which is set at the factory.

Connecting the AC power cord

Connect the AC power cord to a wall outlet.

Where do I go next?

Now you are ready to use your player.

Before playing a CD, turn on the amplifier and select the CD player position.

Inserting CDs

You can insert up to 100 discs into this player.

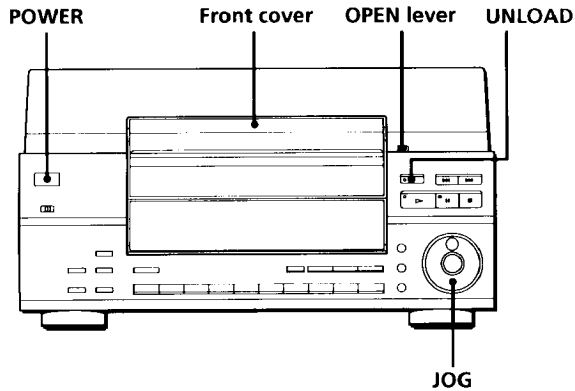

- 1 Press POWER to turn on the player.
- 2 Slide the OPEN lever toward you and lift up the front cover.

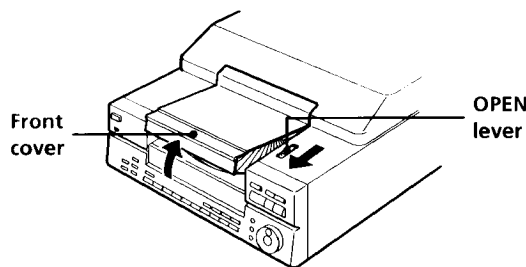

- 3 Press UNLOAD. The UNLOAD button indicator and "UNLOAD" in the display flash. After the rotary table turns, both indicator and indication light up.

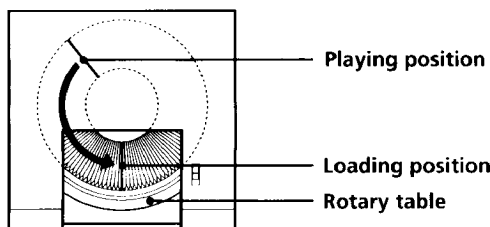

- 4 Find the disc slit where you want to insert a disc while checking the disc number (written beside the slit and also indicated in the display). If you want to move the slit toward you, turn the JOG dial.

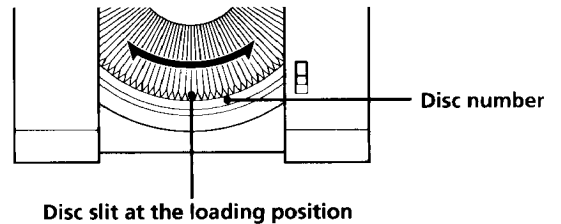

The disc number at the loading position and the Disc Memo (see page 15) appear in the display. As you turn the JOG dial, the disc number and the Disc Memo change.

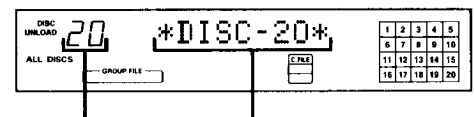

Disc number at the loading position Disc Memo or disc number

When the disc does not have the Disc Memo, the disc number (e.g., *DISC-20*) appears instead of the Disc Memo. This disc number disappears if you do not play the disc for more than a minute. However, the disc number appears again when you play the disc.

- 5 Insert a disc with the label side facing right.

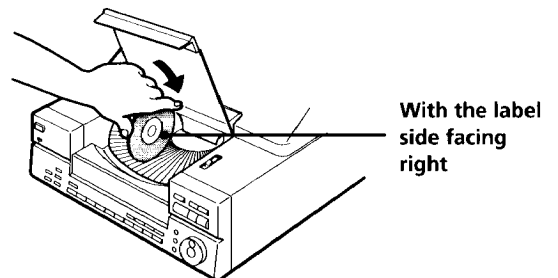

After inserting the disc, you can label the disc to locate it easily (see "Labeling Discs (Disc Memo)" on page 15).

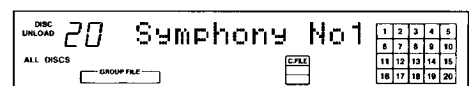

- 6 Repeat Steps 4 and 5 to insert more discs.

- 7 Close the front cover by pressing the right edge of the cover until it clicks.

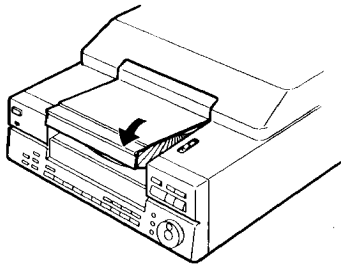

Always close the front cover except when you insert or remove discs.

💡 When the UNLOAD indicator lights up
 "UNLOAD" appears in the display and the current disc slit comes to the loading position. You can turn the rotary table, but cannot play CDs at this time.

💡 The supplied CD booklet holder helps you locate a disc
 You can store up to 100 CD booklets. Insert booklets and stick the number label on the film of a pocket and the booklet so that you can locate the disc easily.

💡 When you drop something inside the player
 Slide the bottom cover to detach it. Remove the foreign object, then slide the cover back in.

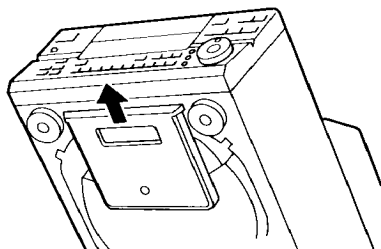

Note
 When you insert an 8 cm (3-inch) CD, be sure to attach a Sony CSA-8 adaptor (not supplied) to the disc.

Removing CDs

After following Steps 1 to 4 of "Inserting CDs" on page 6, remove the discs. Then close the front cover.

💡 When you replace a disc in a slit
 Custom Files (see page 15) remain even if you remove a disc. If you replace the disc with a new one, "DISC CHANGED" appears in the display. Erase or change the Custom File information if necessary.

Playing CDs

You can play all the tracks on a disc in the original order (Continuous Play). You can also play up to 100 discs consecutively.

Before you begin, make sure you have connected the player to an amplifier correctly and firmly as indicated on pages 4 and 5, and have inserted the discs correctly as indicated on page 6.

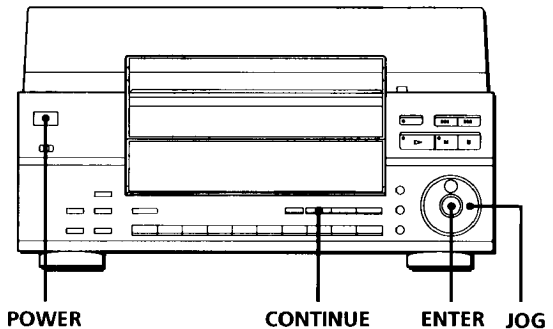

- 1 Turn on the amplifier and select the CD player position.
- 2 Press POWER to turn on the player.
- 3 Press CONTINUE to select ALL DISCS or 1 DISC. Each time you press CONTINUE, "ALL DISCS" and "1 DISC" appear in the display alternately.

When you select	The player plays
ALL DISCS	All discs in the player consecutively in the order of disc number. Empty disc slits are skipped.
1 DISC	Only one disc you have selected



- 4 Turn the JOG dial while checking the disc numbers or Disc Memo (see page 15) in the display to select the first disc (ALL DISCS) or the disc you want (1 DISC).
 The next disc number changes as you turn the JOG dial.



- 5 Press ENTER.
 The selected disc is set to the playing position, and the player plays all the discs from the selected one (ALL DISCS) or all the tracks once (1 DISC).
 Adjust the volume on the amplifier.

Playing CDs

To stop playback
Press ■.

When you want to	Press
Pause	⏸
Resume play after pause	▶ or ⏸
Go to the next disc 	DISC SKIP + once. Hold down the button to skip discs.
Go back to the preceding disc 	DISC SKIP - once. Hold down the button to skip discs.
Go to the next track	⏮
Go back to the preceding track	⏭
Stop play and release the disc from the playing position	UNLOAD

When you turn off the player

The player remembers the last playing disc and the play mode (Continuous, Shuffle (see page 11) or Program (see page 12)). When you turn on the player again, therefore, the player plays the same disc in the same play mode.

Using the Display

You can check information about the disc using the display.

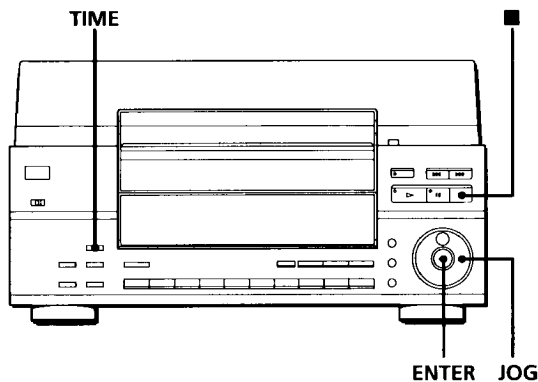

Checking the total number and playing time of the tracks

Select the disc you want to check, and press ENTER in the Continuous Play mode. As the player starts play automatically, press ■ to stop, and then TIME. The display shows the current disc number, total number of tracks, total playing time and music calendar.

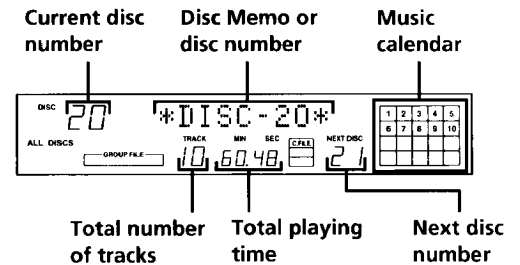



When you want to check another disc

Press DISC SKIP on the remote in the stop mode to select the disc you want to check. The total number of tracks and the total playing time of the selected disc appear for a while.

Checking the remaining time

Each time you press TIME while playing a disc, the display changes as shown in the table below. The track numbers in the music calendar disappear after they are played.

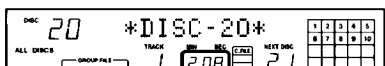
Press TIME	To check
Once	Remaining time on the current track 
Twice	Remaining time on the current disc* 
Three times	Playing time and number of the current track 

* This information is available only in the Continuous Play mode. If you have deleted tracks (see page 16), "-- --" appears instead of the remaining time.

Locating a Specific Disc

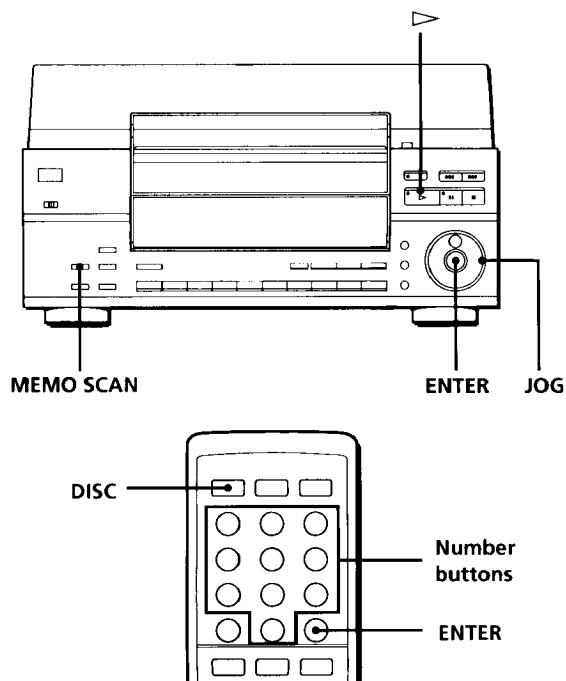

Selecting a disc with the player

Turn the JOG dial until the disc number you want appears in the display. Press ENTER to start play.

Selecting a disc directly with the remote

- 1 Press DISC on the remote.
- 2 Press the number button of the disc.

To select a disc with a number over 10

Press the 10's digit first, then the 1's digit. To enter 0, use the button 10/0.

Example: To enter number 30

Press 3, then 0 (10/0)

To enter number 100, press 0 (10/0) twice.

- 3 Press ENTER to start play.

Locating a disc by scanning each Disc Memo (Memo Scan)

You can locate a disc you want to play quickly by scanning the Disc Memos (see page 15) in the display and start playing.

Note that you cannot use this function in the ALL DISCS Shuffle and Program Play modes.

- 1 Press MEMO SCAN until "MEMO SCAN" appears in the display.
The Disc Memos scroll in the display.
- 2 Press \triangleright or ENTER when the Disc Memo of the disc you want to play appears.
The disc is set to the playing position, and the player starts playing.

You can jump to the next or preceding Disc Memo while scanning

Press \lll or \ggg .

Specifying the Next Disc to Play

You can specify the next disc to play while playing a disc in the continuous play mode.

While playing a disc, turn the JOG dial until the disc number you want appears in the display.

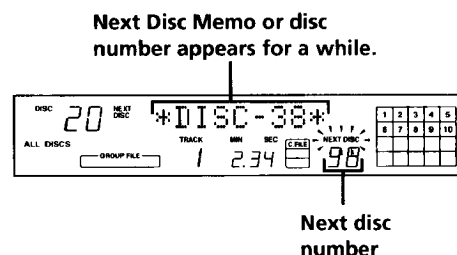

After the current disc is played, the next disc you have specified starts playing.

If you want to skip to the next disc right away, press ENTER while playing the current disc.



To cancel the disc you have specified

Press CONTINUE twice.

Locating a Specific Track or a Point in a Track

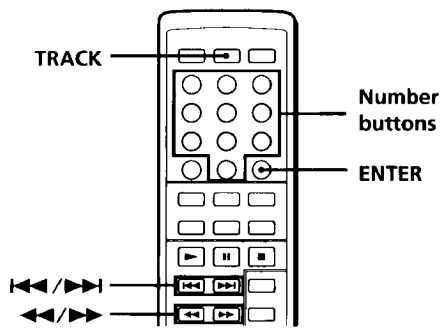
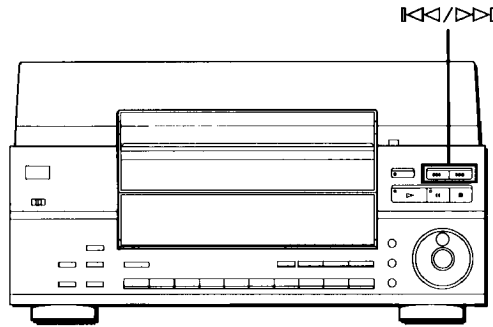
You can quickly locate any track while playing a disc using the **⏮/⏭** (AMS: Automatic Music Sensor) buttons or number buttons on the remote. You can also locate a specific point in a track while playing a disc.



To locate	Press
the next or succeeding tracks	⏭ repeatedly until you find the track
the current or preceding tracks	⏮ repeatedly until you find the track
a specific track directly 	<ol style="list-style-type: none"> 1 Press TRACK. 2 Press the number button of the track. 3 Press ENTER.
a point in a track while monitoring the sound 	⏭ (forward) or ⏮ (backward) and hold down until you find the point
a point in a track quickly by observing the display during pause 	⏮/⏭ and hold down until you find the point. You will not hear the sound during the operation.

When you directly locate a track with a number over 10

Press the 10's digit first, then the 1's digit. To enter 0, use the button 10/0.

Note

If "7 7" appears in the display, the disc has reached the end while you were pressing **⏭**. Press **⏮** or **⏮/⏭** to go back.

Playing Repeatedly

You can play discs/tracks repeatedly in any play mode. The player stops after repeating the tracks five times in each play mode.

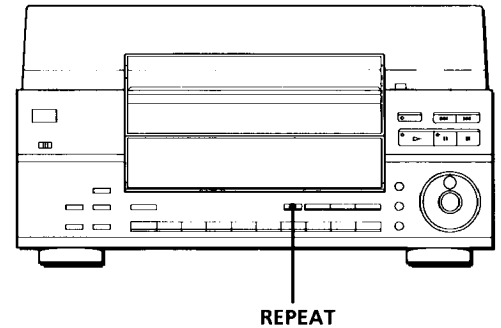

Press REPEAT while playing a disc. "REPEAT" appears in the display. The player repeats the discs/tracks as follows:

When the disc is played in	The player repeats
Continuous Play (ALL DISCS) (page 7)	All tracks on all discs
Continuous Play (1 DISC) (page 7)	All tracks on the current disc
Shuffle Play (ALL DISCS) (page 11)	All tracks on all discs in random orders
Shuffle Play (1 DISC) (page 11)	All tracks on the current disc in random orders
Program Play (page 12)	The same program

To cancel Repeat Play

Press REPEAT again. "REPEAT OFF" appears for a while, and "REPEAT" disappears from the display.

Playing in a Random Order (Shuffle Play)

You can have the player “shuffle” the tracks and play in a random order. The player shuffles all the tracks on all discs or on the disc you specified.

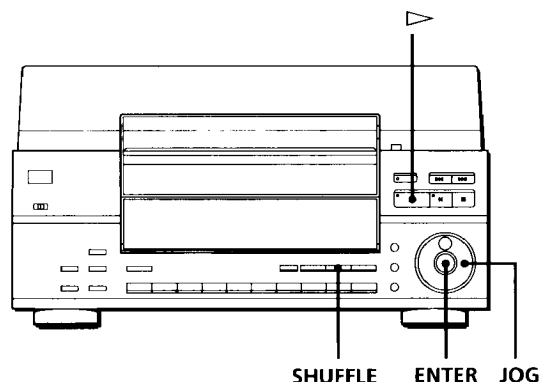

Shuffle Play on all discs

You can play all tracks on all discs in a random order.

- 1 Press SHUFFLE repeatedly until “ALL DISCS” appears in the display.
- 2 Press . ALL DISCS Shuffle Play starts. “ ” appears in the display while the player is “shuffling” the discs or tracks.

To cancel Shuffle Play

Press CONTINUE.

You can start Shuffle Play while playing

Press SHUFFLE, and Shuffle Play starts from the current track.

Notes

- You cannot specify the next disc to play during ALL DISCS Shuffle Play.
- Even if you press or turn off the player during ALL DISCS Shuffle Play, the player remembers which discs/ tracks are played and which are not. Therefore, if you want to start ALL DISCS Shuffle Play again from the beginning, be sure to repeat the procedure from Step 1.

Shuffle Play on one disc

You can play all tracks on the specific disc in a random order.

- 1 Press SHUFFLE repeatedly until “1 DISC” appears in the display.
- 2 Turn the JOG dial to select the disc.
- 3 Press ENTER. 1 DISC Shuffle Play starts on the selected disc. “ ” appears in the display while the player is “shuffling” the tracks.

To cancel Shuffle Play

Press CONTINUE.

You can directly select a disc

See “Selecting a disc directly with the remote” on page 9.

You can go to the next disc during 1 DISC Shuffle Play

Press DISC SKIP +.

You can specify the next disc to play during 1 DISC Shuffle Play

Turn the JOG dial to specify the next disc. After all the tracks on the current disc are played in a random order, the next disc starts playing. If you want to skip to the next disc right away, press ENTER while playing the current disc.

You can start Shuffle Play while playing

Press SHUFFLE, and Shuffle Play starts from the current track.

Creating Your Own Programs (Program Play)

You can arrange the order of the tracks and/or discs and create 3 different programs and programs are stored automatically. A program can contain up to 32 "steps" — one "step" may contain a track or a whole disc.

You can make programs using the controls on the remote as well as ones on the player. However, the programming procedures are different.

Creating a program using the player

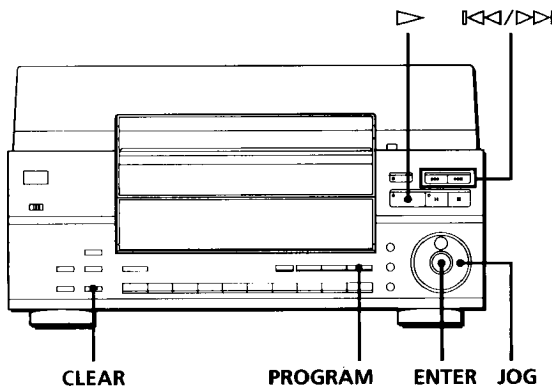

1 Press PROGRAM until the program number you want (PROGRAM 1, 2 or 3) appears in the display. If a program is already stored in the selected program number, the last step of the program appears in the display. When you want to erase the whole program, hold down CLEAR until "ALL CLEAR" appears in the display (see page 14).

2 Turn the JOG dial to select the disc.



3 To program a whole disc, skip this step. Press **⏮/⏭** to select a track.



4 Press ENTER or PROGRAM.

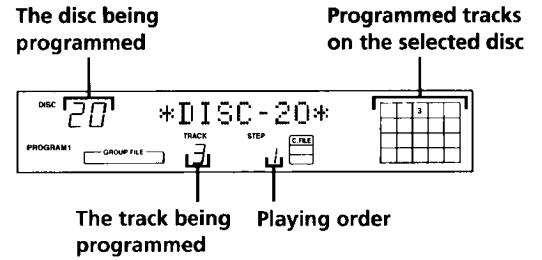

5 To program other discs/tracks, do the following:

To program	Repeat Steps
Other discs	2 and 4
Other tracks on the same disc	3 to 4
Other tracks on other discs	2 to 4

6 Press **▶** to start Program Play.

To cancel Program Play
Press CONTINUE.

Creating a program using the remote

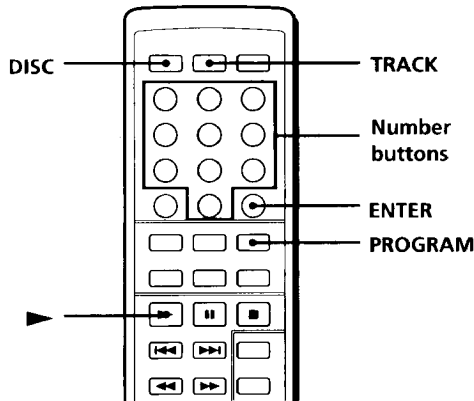

1 Press PROGRAM until the program number you want (PROGRAM 1, 2 or 3) appears in the display. If a program is already stored in the selected program number, the last step of the program appears in the display. When you want to erase the whole program, hold down CLEAR until "ALL CLEAR" appears in the display (see page 14).

2 Press DISC.



3 Press the number button of the disc.

To select a disc with a number over 10

Press the 10's digit first, then the 1's digit. To enter 0, use the button 10/0 (see page 9).

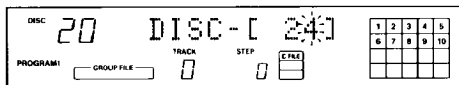

4 Press ENTER.

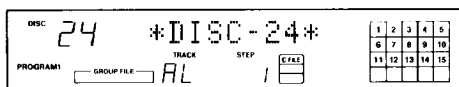

5 To program a whole disc, skip this step and go to Step 8. Press TRACK.

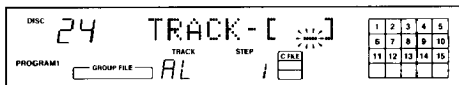

6 Press the number button of the track.

To select a track with a number over 10

Press the 10's digit first, then the 1's digit. To enter 0, use the button 10/0 (see page 9).



7 Press ENTER.

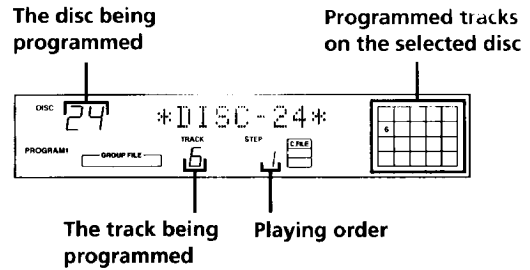

8 To program other discs/tracks, do the following:

To program	Repeat Steps
Other discs	2 to 4
Other tracks on the same disc	5 to 7
Other tracks on other discs	2 to 7

9 Press ► to start Program Play.

To cancel Program Play

Press CONTINUE.

The programs remain even after Program Play ends
When you press ►, you can play the same program again. The programs are stored in the player's memory for about a month with the power turned off.

When you press PROGRAM during Continuous or Shuffle Play
The program you played last time appears and will be played after the current track.

The programs remain until you erase them
If you replace discs, the programmed disc and track numbers remain. So, the player plays only the existing disc and track numbers. However, the disc and track numbers that are not found in the player or on the disc are deleted from the program, and the rest of the program is played in the programmed order.

Note

If "PROGRAM FULL" appears in the display, it means that you have already programmed 32 steps and cannot program any more track or disc.

Checking the programmed order

You can check your program before or after you start playing.

Press CHECK.

Each time you press this button, the display shows the track or disc number in the programmed order. After the last track or disc in the program, the display shows "END" and returns to the original display.

Changing the programmed order

You can change your program before you start playing.

To	You need to
Erase a track or disc	Press CHECK until the track or disc you do not want appears in the display, then press CLEAR.
Erase the last track or disc in the program	Press CLEAR. Each time you press the button, the last track or disc will be cleared.
Add tracks or discs to the end of the program	Follow the programming procedure
Change the whole program completely	Hold down CLEAR until "ALL CLEAR" appears in the display to erase the whole program, then create a new program following the programming procedure.

Erasing the programs stored in memory

- 1 Press PROGRAM repeatedly in the stop mode until the program number (PROGRAM 1, 2 or 3) you want to erase appears in the display.
- 2 Hold down CLEAR until "ALL CLEAR" appears in the display.

Playing Using a Timer

You can start playing a disc at any time you want by connecting a timer (not supplied). Please also refer to the instructions for the timer if you need help.

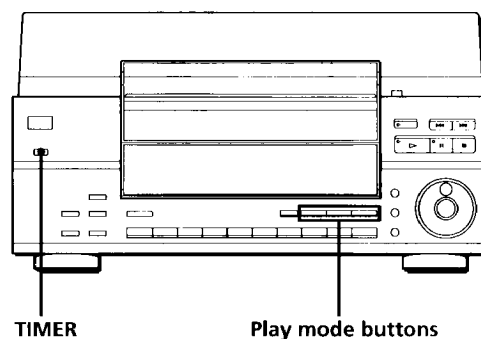

- 1 Press one of the play mode buttons to select the play mode you want.
- 2 Set TIMER on the player to PLAY.
- 3 Set the timer to the time you want. The player turns off. When the set time comes, the player turns on and starts playing.
- 4 After you have used the timer, set TIMER on the player to OFF.

What You Can Do With the Custom Files

The player can store 3 types of information called "Custom Files" for each disc. Once you have stored Custom Files for a disc, the player automatically recalls what you have stored whenever you select the disc. Note that Custom Files will be erased if you do not use the player for about 1 month.

You can store this information:

When you use	You can
Disc Memo (page 15)	Label the disc using up to 12 characters
Delete Bank (page 16)	Delete unwanted tracks and store only the tracks you want
Group File (page 17)	Group discs up to 10 groups to locate them easily

The Custom File indication lights up when you store information and when you select discs with information.

Where are Custom Files stored?

Custom Files are stored not on the disc, but in the player's memory. It means you cannot use Custom Files when you play the disc on other players. Also, since the player stores Custom Files with each disc slit, so you cannot use Custom File when you insert a disc in another slit.

When you replace a disc in a slit

Custom Files remain even if you remove the disc. If you replace the disc with a new one, "DISC CHANGED" appears in the display. Erase or change the Custom File information if necessary.

Erasing Custom Files

You can erase any unwanted Custom Files as follows:

To erase all Custom Files of one disc

Press UNLOAD to turn on the indicator, then select the disc containing the Custom Files you want to erase. Hold down ERASE until "1 DISC ERASE" appears in the display, and all Custom Files of the disc will be erased.

To erase all Custom Files of all discs

Turn off the player. While holding down ERASE and FILE, press POWER to turn on the player. "ALL ERASE" appears in the display, and all Custom Files will be erased.

Labeling Discs (Disc Memo)

You can label discs using up to 12 characters and have the player display the Disc Memo every time you select the disc. The Disc Memo can be anything you like, such as a title, musician's name, category or date of purchase.

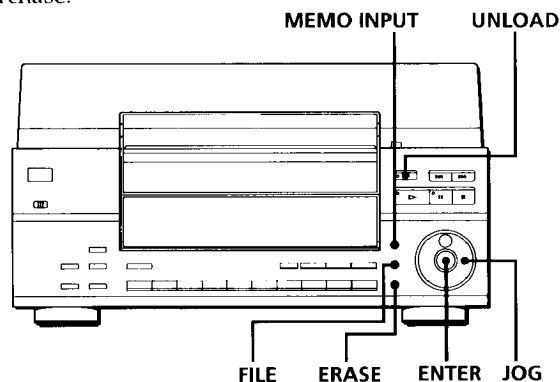

- 1 Press CONTINUE, then UNLOAD to turn on the indicators.
- 2 Turn the JOG dial to select the disc to which you want to assign a Disc Memo.
- 3 Press MEMO INPUT until you find the letter type you want. Each time you press the button, the display shows capital letters (ABC), small letters (abc) and numbers (123) in this order.
- 4 Turn the JOG dial until the character you want appears in the display. When you turn the JOG dial clockwise, the characters appear in the following order. Turn the JOG dial counterclockwise to go back to the previous character.

(space) A B C D E F G H I J K L M N O P Q R S T U
 V W X Y Z & a b c d e f g h i j k l m n o p q r s t u v
 w x y z ä ö ü ; : () [] % \$ # 0 1 2 3 4 5 6 7 8 9 10 →
 ← * / ! ? ' " , . -



(Continued)

Storing Information About CDs (Custom Files)

- 5** Press ENTER.
The selected character lights up, and the flashing cursor moves to the next position.
To insert a space, press CLEAR.

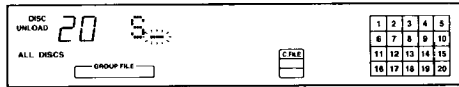

If you have made a mistake

Press ◀◀ or ▶▶ until the letter you want to change flashes, then enter the right letter.

- 6** Repeat Steps 4 and 5 to input more characters.
When you want to change the letter type, go back to Step 3.

To stop labeling a disc

While assigning a Disc Memo, hold down MEMO INPUT.

If you are assigning a Disc Memo while playing a disc, or in the stop mode (the UNLOAD button indicator is not lit), press ■.

- 7** Press FILE to store the Disc Memo.
The Disc Memo appears in the display.

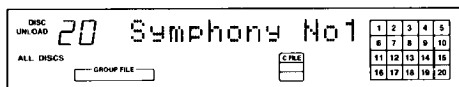
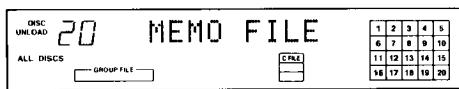

Repeat Steps 2 to 7 to assign a Disc Memo to other discs.

Erasing the Disc Memo

- Press UNLOAD to turn on the indicator, then select the disc containing the Disc Memo you want to erase.
- Press MEMO INPUT.
The first letter of the Disc Memo flashes.
- Press ERASE to erase the Disc Memo.
"FILE ERASE" appears in the display.

Storing Specific Tracks (Delete Bank)

You can delete unwanted tracks and store only the tracks you want. When you select the disc containing a Delete Bank, you can play only the remaining tracks.

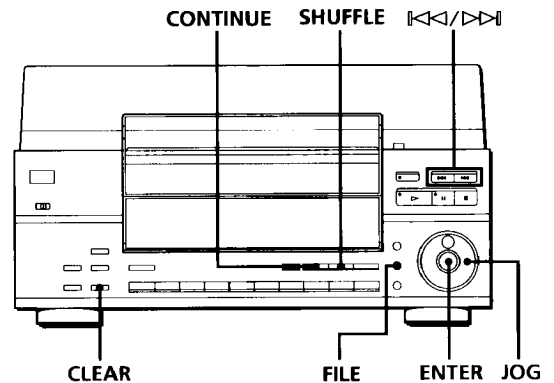

- Press CONTINUE or SHUFFLE repeatedly to select the 1 DISC mode, then turn the JOG dial to select the disc.
- Press ENTER, then ■.
The disc is set to the playing position, and the music calendar shows the tracks on the current disc.
- Press ◀◀ or ▶▶ to select the tracks you want to delete.
- Press CLEAR.
The track number you have selected disappears from the music calendar.
- Repeat Steps 3 and 4 to delete more tracks.
- Press FILE.
"DELETE FILE" appears for a while, and "DELETE" in the Custom File indication lights up in the display.



You can delete the currently playing track

Press CLEAR while an unwanted track is playing, then press FILE.



You can recover all the tracks temporarily

Hold down CLEAR in the stop mode until "ALL SELECT" appears in the display.

💡 You can make a Delete Bank using the remote . In the 1 DISC Shuffle Play mode, press TRACK and enter the track number to be deleted, then press ENTER. The track number disappears from the music calendar. Repeat this procedure to delete more tracks, then press FILE to store the remaining tracks as a Delete Bank. To recover a track you have deleted, press TRACK, enter the track number again, then press ENTER.

Note

The deleted tracks are skipped even in the Shuffle or Program Play mode (when the whole disc containing a Delete Bank is programmed as one step).

Erasing the Delete Bank

- 1** Play the disc containing a Delete Bank you want to erase.
- 2** Press FILE.
- 3** While "DELETE FILE" is lit in the display, press ERASE. "FILE ERASE" appears, and the Delete Bank for the selected disc will be erased.

Grouping Discs (Group File)

You might find that too many discs make it hard to find the disc you want. This player has a feature that lets you group discs. When you insert a disc to which you have assigned a group, the group number indication (e.g., Group 1) appears in the display. The player has 10 preset groups, such as "JAZZ" and "POPS," and each group can contain up to 100 discs. You can also put a disc into multiple groups. You can enjoy Continuous, Shuffle, or Repeat Play only within a certain group (Group Play). You can also scan groups (Group Scan) or discs in a specific group to find the group or the disc you want quickly.

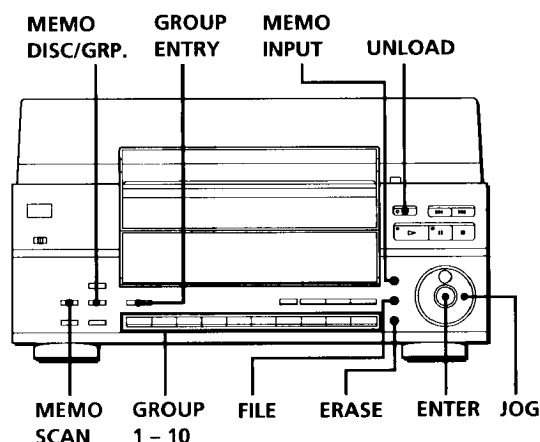

Assigning group names

Before you group discs, find the group you want. Each group name appears in the display when you press the corresponding GROUP 1 - 10 button.

Press GROUP	To display
1	Group 1 JAZZ
2	Group 2 POPS
3	Group 3 CLASSICAL
4	Group 4 ROCK
5	Group 5 R & B
6	Group 6 BALLADE
7	Group 7 C & W
8	Group 8 FOR FATHER
9	Group 9 FOR MOTHER
10	Group 10 FOR CHILD

(Continued)

Storing Information About CDs (Custom Files)

If you want to change the group names, do the following:

- 1 Press one of GROUP 1 – 10 to select the group. The preset group name appears in the display.
- 2 While the group name is lit in the display, press MEMO INPUT until you find the letter type you want. The first letter of the group name flashes. Each time you press the button, the display shows capital letters (ABC), small letters (abc) and numbers (123) cyclically.
- 3 Turn the JOG dial to select a character, then press ENTER. The selected character lights up, and the flashing cursor moves to the next position.
- 4 Repeat Step 3 to enter more characters.
- 5 Press FILE. The group name is stored. You can enter up to 12 characters for a group name. See also “Labeling Discs (Disc Memo)” on page 15 for details.

Putting discs into groups

- 1 Press CONTINUE and then UNLOAD.
- 2 Turn the JOG dial to select the disc which you want to put into a group.
- 3 Press GROUP ENTRY. “GROUP ENTRY” appears in the display, and the navigation display asks you to select one of the groups.
- 4 Press one of GROUP 1 – 10 to select a group. The group name appears for a while, then “GROUP FILE” appears, and the group number indication lights up in the display.

 **You can put the currently playing disc into a group**
While playing the disc, follow Steps 3 and 4 above.

Playing discs in a group (Group Play)

You can enjoy Continuous or Shuffle Play within a group.



- 1 Before you start playing, select the play mode by pressing CONTINUE or SHUFFLE.

When you select	The player plays
Continuous Play	All discs in the group consecutively
ALL DISCS Shuffle Play	All tracks on all discs in the group in random order
1 DISC Shuffle Play	All tracks on the specified disc in the group in random order

- 2 Press one of GROUP 1 – 10 to select the group. Group Play starts from the disc which is located closest to the playing position. If the disc in the playing position is put into the selected group, the play starts from that disc.
- 3 When you want to start Group Play from the disc you want, turn the JOG dial to select the disc, then press ENTER. (You can skip this step if you do not have any particular disc to start with.) Group Play starts from the selected disc.

To cancel Group Play

Press ■. “GROUP OFF” appears in the display.

 **You can start Group Play with the remote** 
Before you start playing, press GROUP, the number button of the group you want to play, then ENTER.

 **You can switch the display indication between the group name and the Disc Memo during Group Play**
Each time you press MEMO DISC/GRP., the group name and the current Disc Memo appear in the display alternately.

Notes

- If “–NO ENTRY–” appears in the display, no disc has been put into the selected group.
- If “–ENTRY END–” appears in the display, all the disc numbers in the group are checked while turning the JOG dial to specify the next disc. Turn the dial counterclockwise to display the disc numbers in reverse order.

Locating a disc within a group by scanning each Disc Memo

You can locate a disc you want to play within a specific group quickly by scanning the Disc Memo in the display and start Group Play.

Note that you cannot use this function in the ALL DISCS Shuffle and Program Play mode.

- 1 Press one of GROUP 1 – 10 to select the group. The group name appears in the display.
- 2 Press MEMO SCAN repeatedly until “MEMO SCAN” appears in the display. The Disc Memos of the discs in the selected group scroll in the display.
- 3 Press ENTER or ▷ when the Disc Memo of the disc you want appears. Group Play starts from the selected disc.

 **You can jump to the next or preceding Disc Memo while scanning**

Press ◀◀ or ▶▶.

Locating a group by scanning each group name (Group Scan)

You can locate a group you want to play quickly by scanning the group names in the display and start Group Play.

Note that you cannot use this function in the ALL DISCS Shuffle and Program Play mode.

- 1 Before you start playing, press MEMO SCAN repeatedly until “GROUP SCAN” appears in the display. The group names scroll in the display.
- 2 Press ENTER or ▷ when the group name you want appears. Group Play starts.

 **You can jump to the next or preceding group while scanning**

Press ◀◀ or ▶▶.

Deleting discs from a group

- 1 Press CONTINUE and then UNLOAD.
- 2 Turn the JOG dial to select the disc which you want to delete from a group.
- 3 Press GROUP ENTRY. “GROUP ENTRY” appears in the display, and the navigation display asks you to select one of the groups.
- 4 Press one of GROUP 1 – 10 to select a group. The group name appears for a while, then “GROUP FILE” appears, and the group number indication lights up in the display.
- 5 While “GROUP FILE” is lit in the display, press ERASE. “FILE ERASE” appears, and the group number indication disappears from the display.

 **You can delete the currently playing disc from a group**

While playing the disc, follow Steps 3 to 5 above.

Precautions

On safety

- As the laser beam used in this unit is harmful to the eyes, do not attempt to disassemble the cabinet. Refer servicing to qualified personnel only.
- Should any solid object or liquid fall into the cabinet, unplug the player and have it checked by qualified personnel before operating it any further.

On power sources

- Before operating the player, check that the operating voltage of the player is identical with your local power supply. The operating voltage is indicated on the nameplate at the rear of the player.
- The player is not disconnected from the AC power source (mains) as long as it is connected to the wall outlet, even if the player itself has been turned off.
- If you are not going to use the player for a long time, be sure to disconnect the player from the wall outlet. To disconnect the AC power cord (mains lead), grasp the plug itself; never pull the cord.
- Should the AC power cord (mains lead) need to be changed, have it done at a qualified service shop only.

On placement

- Place the player in a location with adequate ventilation to prevent heat build-up in the player.
- Do not place the player on a soft surface such as a rug that might block the ventilation holes on the bottom.
- Do not place the player in a location near heat sources, or in a place subject to direct sunlight, excessive dust or mechanical shock.

On operation

- If the player is brought directly from a cold to a warm location, or is placed in a very damp room, moisture may condense on the lenses inside the player. Should this occur, the player may not operate properly. In this case, press UNLOAD to turn on the UNLOAD button indicator and leave the player turned on for about an hour until the moisture evaporates.

On adjusting volume

- Do not turn up the volume while listening to a portion with very low level inputs or no audio signals. If you do, the speakers may be damaged when a peak level portion is played.

On cleaning

- Clean the cabinet, panel and controls with a soft cloth slightly moistened with a mild detergent solution. Do not use any type of abrasive pad, scouring powder or solvent such as alcohol or benzine.

On transportation

- When transporting the player for a short distance, press UNLOAD to turn on the UNLOAD button indicator, then turn the power off. Do not turn the player upside down while transporting it with discs inside.
- When transporting the player for a long distance, press UNLOAD to turn on the UNLOAD button indicator, then remove all the discs from the player and turn the power off.

If you have any questions or problems concerning your player, please consult your nearest Sony dealer.

Notes on CDs

On handling CDs

- To keep the disc clean, handle the disc by its edge. Do not touch the surface.
- Do not stick paper or tape on the disc.

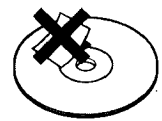

Not this way

- Do not expose the disc to direct sunlight or heat sources such as hot air ducts, nor leave it in a car parked in direct sunlight as there can be considerable rise in temperature inside the car.
- After removing a disc from the disc slot, store the disc in its case.

On cleaning

- Before playing, clean the disc with a cleaning cloth. Wipe the disc from the center out.



- Do not use solvents such as benzine, thinner, commercially available cleaners or anti-static spray intended for vinyl LPs.

Troubleshooting

If you experience any of the following difficulties while using the player, use this troubleshooting guide to help you remedy the problem. Should any problem persist, consult your nearest Sony dealer.

There is no sound.

- ➔ Check that the player is connected securely.
- ➔ Make sure you operate the amplifier correctly.

The CD does not play.

- ➔ There is no CD in a slit ("NO DISC" appears). Insert a CD.
- ➔ Insert the CD with the label side facing right.
- ➔ Clean the CD (see page 20).
- ➔ Moisture has condensed inside the player. Press UNLOAD to turn on the UNLOAD button indicator and leave the player turned on for about an hour (see page 20).

The rotary table does not rotate.

- ➔ Press UNLOAD to turn on the UNLOAD button indicator.

The disc number, which is indicated instead of the Disc Memo, has disappeared.

- ➔ The disc number (e.g., *DISC-20*) disappears if you do not play the disc for more than a minute. However, this is not a malfunction. The disc number appears again when you play the disc.

The remote does not function.

- ➔ Remove obstacles in the path of the remote and the player.
- ➔ Point the remote at the remote sensor  on the player.
- ➔ Replace all the batteries in the remote with new ones if they are weak.
- ➔ Set the COMMAND MODE selector on the rear panel to the CD1 position.

The player functions incorrectly.

- ➔ The microcomputer chips may be operating incorrectly. Turn the power off, then turn it back on to reset the player.

Specifications

Compact disc player

Laser	Semiconductor laser
Wavelength	780 – 790 nm
Frequency response	2 Hz to 20 kHz \pm 0.3 dB
Signal-to-noise ratio	More than 107 dB
Dynamic range	More than 98 dB
Harmonic distortion	Less than 0.0027%
Channel separation	More than 100 dB

Outputs

	Jack type	Maximum output level	Load impedance
LINE OUT	Phono jacks	2 V (at 50 kilohms)	Over 10 kilohms
DIGITAL OUT (OPTICAL)	Optical output connector	-18 dBm	Wave length: 660 nm

General

Power requirements

Where purchased	Power requirements
USA	120 V AC, 60 Hz
Australia	240 V AC, 50 Hz

Power consumption 15 W

Dimensions (approx.) (w/h/d)
 When the front cover is closed
 430 × 240 × 470 mm (17 × 9 1/2 × 18 5/8 in.) incl. projecting parts
 When the front cover is open
 430 × 380 × 470 mm (17 × 15 × 18 5/8 in.) incl. projecting parts

Mass (approx.) 9.0 kg (19 lbs 14 oz)

Supplied accessories

Audio cord (2 phono plugs – 2 phono plugs) (1)
 Remote commander (remote) (1)
 Sony SUM-3 (NS) batteries (2)
 CD booklet holder (1)
 Labels (2)

Design and specifications are subject to change without notice.

Index

A, B

- AMS 10
- Automatic Music Sensor. *See* AMS

C

- Connecting 4
- Continuous Play 7
- Custom Files
 - Delete Bank 16
 - Disc Memo 15
 - Group File 17
 - what you can do with 15

D

- Delete Bank 16
- Disc Memo 15

E, F

- Erasing
 - Custom Files 15
 - Delete Bank 17
 - Disc Memo 16
 - Group File 19
 - programs 14

G

- Group File 17
- Group Play 18
- Group Scan 19

H

- Handling CDs 20
- Hookups
 - overview 4

I

- Inserting CDs 6

J, K

- JOG dial 6

L

- Labeling a disc 15
- Locating
 - a specific track 10
 - a specific point 10
 - by monitoring 10
 - by observing the display 10
 - discs 9
 - directly 10
 - using AMS 10

M, N, O

- Memo Scan 9

P, Q

- Playback
 - Continuous Play 7
 - Group Play 18
 - Program Play 12
 - Repeat Play 10
 - Shuffle Play 11
 - using a timer 14
- Program
 - changing 14
 - checking 14
 - erasing 14

R

- Remaining time 8
- Remote control 4
- Repeating 10
- Rotary table 6

S

- Searching. *See* Locating
- Selecting a disc 9
- Shuffle Play
 - on all discs 11
 - on one disc 11
- Specifying the next disc 9
- Storing
 - information about CDs 15
 - specific tracks 16

T

- Timer play 14
- Total playing time 8
- Troubleshooting 21

U, V, W, X, Y, Z

- Unpacking 4

Names of controls

Buttons

- CHECK 14
- CLEAR 14
- CONTINUE 7
- DISC 9
- DISC SKIP 8
- ERASE 15
- ENTER 7
- FILE 16
- GROUP 18
- GROUP ENTRY 18
- GROUP 1 – 10 17
- MEMO DISC/GRP. 18
- MEMO INPUT 15
- MEMO SCAN 9, 19
- Number 9
- PROGRAM 12
- REPEAT 10
- SHUFFLE 11
- TIME 8
- TRACK 10
- UNLOAD 6
- ⏪/⏩ 10
- ▷ 8
- ⏸ 8
- 8
- ⏮/⏭ 10

Connectors

- CONTROL A 5
- DIGITAL OUT OPTICAL 5

Switches

- POWER 6
- TIMER 14

Others

- COMMAND MODE selector 5
- Disc slits 6
- Display 8
- Front cover 6
- JOG dial 6
- LINE OUT jack 5
- OPEN lever 6
- Rotary table 6
- 4

