

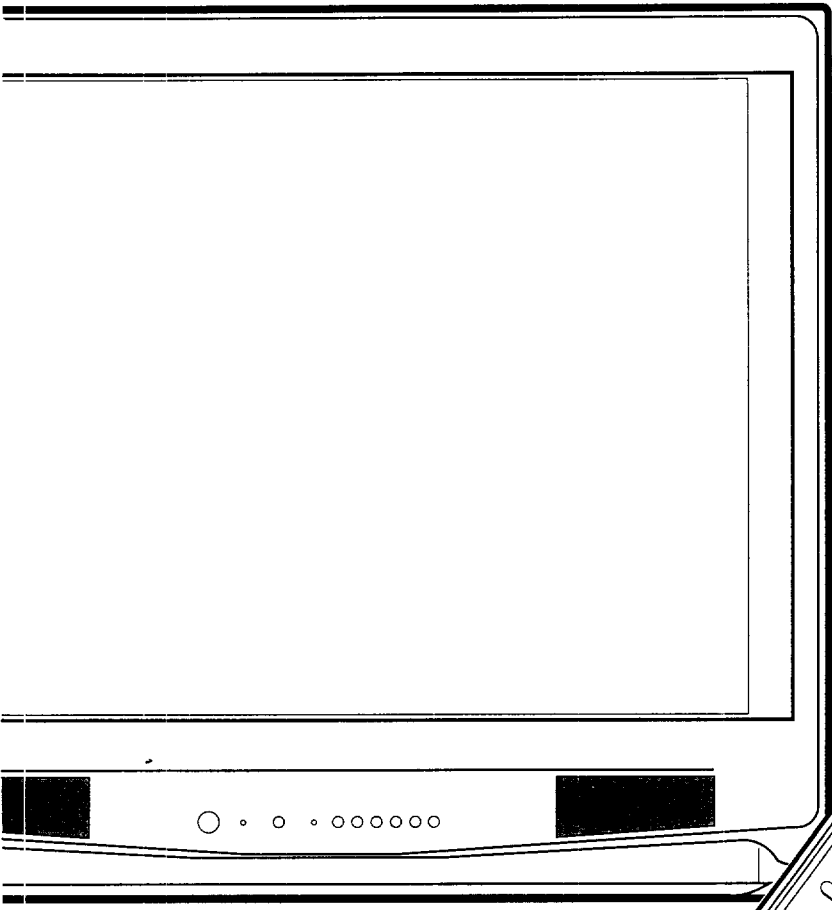

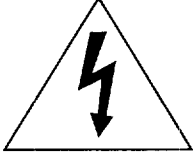

CS-31205
CS-31305
CS-31309
CK-31304

Television Owner's Guide



| | | |
|---|---|---|
|  | CAUTION RISK OF ELECTRIC SHOCK DO NOT OPEN |  |
| <p>CAUTION: TO REDUCE THE RISK OF ELECTRIC SHOCK, DO NOT REMOVE COVER (OR BACK). NO USER-SERVICEABLE PARTS INSIDE. REFER SERVICING TO QUALIFIED SERVICE PERSONNEL.</p> | | |

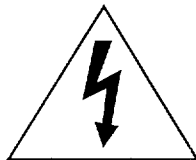

The lightning flash with arrowhead symbol, within an equilateral triangle, is intended to alert the user to the presence of uninsulated "dangerous voltage" within the product's enclosure that may be of sufficient magnitude to constitute a risk of electric shock.



The exclamation point within an equilateral triangle is intended to alert the user to the presence of important operating and maintenance (servicing) instructions in the literature accompanying the appliance.

► **Warning:** Don't leave stationary images, such as those generated from stock market reports or video games, on-screen for more than 10 minutes. Still patterns such as these can scar the TV, causing permanent damage to the picture tube.

WARNING:

TO PREVENT FIRE OR SHOCK HAZARD, DO NOT EXPOSE THIS APPLIANCE TO RAIN OR MOISTURE.

CAUTION:

TO PREVENT ELECTRIC SHOCK HAZARD, DO NOT USE THIS UNIT'S (POLARIZED) PLUG WITH AN EXTENSION CORD, RECEPTACLE OR OTHER OUTLET UNLESS THE BLADES CAN BE FULLY INSERTED TO PREVENT BLADE EXPOSURE.

NOTE TO CATV SYSTEM INSTALLER:

THIS REMINDER IS PROVIDED TO CALL THE CATV SYSTEM INSTALLER'S ATTENTION TO ARTICLE 820-40 OF THE NEC THAT PROVIDES GUIDELINES FOR PROPER GROUNDING AND, IN PARTICULAR, SPECIFIES THAT THE CABLE GROUND SHALL BE CONNECTED TO THE GROUNDING SYSTEM OF THE BUILDING, AS CLOSE TO THE POINT OF CABLE ENTRY AS PRACTICAL.



Table of Contents

| | |
|---|-----------|
| Important Safeguards | 3 |
| Preface: Welcome to Mitsubishi | 5 |
| Summary of Special Features | 6 |
| Unpacking Your TV | 7 |
| What's in Each Chapter | 8 |
| Some Conventions Used in this Guide | 9 |
| Chapter 1: Getting to Know Your TV | 11 |
| Overview of the Control Panel | 12 |
| Overview of the Remote Control | 14 |
| Getting ready to use the remote control | 14 |
| Remote control buttons and functions | 16 |
| Chapter 2: Connecting Your TV | 21 |
| Overview of the Back Panel | 22 |
| Basic Connections | 24 |
| TV + antenna or cable without a decoder box | 25 |
| TV + cable with a decoder box | 26 |
| TV + separate UHF and VHF antennas | 27 |
| TV + VCR + antenna or cable without a decoder box | 28 |
| TV + VCR + cable with a decoder box | 31 |
| TV + audio system | 34 |
| Chapter 3: Operating Your TV | 35 |
| Getting Started | 36 |
| Using the remote control to operate cable boxes and other brands of VCRs | 37 |
| Turning the TV on/off | 41 |
| Selecting the input source | 42 |
| Changing channels | 43 |
| Understanding the on-screen menus | 46 |
| Setting the clock | 47 |
| Memorizing channels | 49 |
| Adding and deleting channels | 50 |
| Renaming the input | 51 |
| Selecting the menu language | 52 |
| Using video mute | 53 |
| Adjusting the sound | 54 |
| Adjusting the picture | 56 |
| Using the closed caption decoder | 57 |

| | |
|--|--------------------------|
| Using the Advanced Features | 59 |
| Setting the timer | 60 |
| Using the parental lock | 61 |
| Using the Super Quick View tuning | 65 |
| Selecting an advanced PIP function (CS-31305, CS-31309, and CK-31304 only) | 66 |
| Chapter 4: Using the Special Features | 67 |
| Understanding the On-Screen Displays | 68 |
| Using the Off-Timer | 69 |
| Setting the off-timer | 70 |
| Changing or canceling the off-timer | 71 |
| Using the Advanced Picture-in-Picture (PIP) Modes (CS-31305, CS-31309, and CK-31304 only) | 72 |
| Selecting the PIP image | 73 |
| Selecting the PIP source | 74 |
| Changing channels while using the PIP modes | 74 |
| Exchanging the PIP image and the main image | 75 |
| Moving the PIP image | 75 |
| Freezing the PIP image | 76 |
| Using the Snap-shot feature | 77 |
| Using the Replay feature | 78 |
| Chapter 5: Troubleshooting | 79 |
| Caution and Care | 82 |
| Calling for Service | 83 |
| Appendix: Procedure for Bypassing the Parental Lock | 85 |
| Index | 87 |
| Warranty | Inside Back Cover |

IMPORTANT SAFEGUARDS

PLEASE READ ALL THESE INSTRUCTIONS REGARDING YOUR TV RECEIVER AND RETAIN FOR FUTURE REFERENCE. FOLLOW ALL WARNINGS AND INSTRUCTIONS MARKED ON THE TV RECEIVER.

1. **Read Instructions**
All the safety and operating instructions should be read before the appliance is operated.
2. **Retain Instructions**
The safety and operating instructions should be retained for future reference.
3. **Heed Warnings**
All warnings on the appliance and in the operating instructions should be adhered to.
4. **Follow Instructions**
All operating and use instructions should be followed.
5. **Cleaning**
Unplug this TV receiver from the wall outlet before cleaning. Use a damp cloth for cleaning.

Warning:
Do not use liquid or aerosol cleaners to clean your TV. Cleaners may permanently damage your screen.

6. **Attachments**
Do not use attachments not recommended by the TV receiver manufacturer as they may cause hazards.
7. **Water and Moisture**
Do not use this TV receiver near water — for example, near a bath tub, wash bowl, kitchen sink, or laundry tub, in a wet basement, or near a swimming pool, and the like.
8. **Accessories**
Do not place this TV receiver on an unstable cart, stand, tripod, bracket, or table. The TV receiver may fall, causing serious injury to a child or adult, and serious damage to the appliance. Use only with a cart, stand, tripod, bracket, or table recommended by the manufacturer, or sold with the TV receiver. Any mounting of the appliance should follow the manufacturer's instructions, and should use a mounting accessory recommended by the manufacturer.

An appliance and cart combination should be moved with care. Quick stops, excessive force, and uneven surfaces may cause the appliance and cart combination to overturn.



9. **Ventilation**
Slots and openings in the cabinet are provided for ventilation and to ensure reliable operation of the TV receiver and to protect it from overheating, and these openings must not be blocked or covered. The openings should never be blocked by placing the TV receiver on a bed, sofa, rug, or other similar surface. This TV receiver should never be placed near or over a radiator or heat register. This TV receiver should not be placed in a built-in installation such as a bookcase or rack unless proper ventilation is provided or the manufacturer's instructions have been adhered to.
10. **Power Sources**
This TV receiver should be operated only from the type of power source indicated on the marking label. If you are not sure of the type of power supplied to your home, consult your appliance dealer or local power company. For TV receivers intended to operate from battery power, or other sources, refer to the operating instructions.
11. **Grounding or Polarization**
This TV receiver is equipped with a polarized alternating-current line plug (a plug having one blade wider than the other). This plug will fit into the power outlet only one way. This is a safety feature. If you are unable to insert the plug fully into the outlet, try reversing the plug. If the plug should still fail to fit, contact your electrician to replace your obsolete outlet. Do not defeat the safety purpose of the polarized plug.
12. **Power-Cord Protection**
Power-supply cords should be routed so that they are not likely to be walked on or pinched by items placed upon or against them, paying particular attention to cords at plugs, convenience receptacles, and the point where they exit from the appliance.
13. **Lightning**
For added protection for this TV receiver during a lightning storm, or when it is left unattended and unused for long periods of time, unplug it from the wall outlet and disconnect the antenna or cable system. This will prevent damage to the TV receiver due to lightning and power-line surges.

14. Power Lines

An outside antenna system should not be located in the vicinity of overhead power lines or other electric light or power circuits, or where it can fall into such power lines or circuits. When installing an outside antenna system, extreme care should be taken to keep from touching such power lines or circuits as contact with them might be fatal.

15. Overloading

Do not overload wall outlets and extension cords as this can result in a risk of fire or electric shock.

16. Object and Liquid Entry

Never push objects of any kind into this TV receiver through openings as they may touch dangerous voltage points or short-out parts that could result in a fire or electric shock. Never spill liquid of any kind on the TV receiver.

17. Outdoor Antenna Grounding

If an outside antenna or cable system is connected to the TV receiver, be sure the antenna or cable system is grounded so as to provide some protection against voltage surges and built-up static charges.

Section 810 of the National Electrical Code, ANSI/NFPA No.70, provides information with regard to proper grounding of the mast and supporting structure, grounding of the lead-in wire to an antenna discharge unit, size of grounding conductors, location of antenna discharge unit, connection to grounding electrodes, and requirements for the grounding electrode.

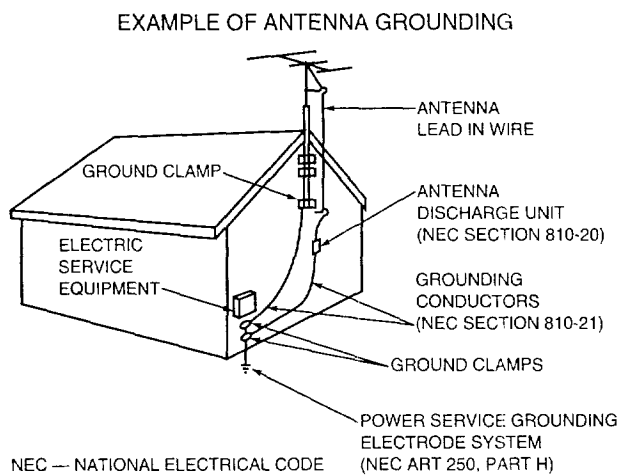

18. Servicing

Do not attempt to service this TV receiver yourself as opening or removing covers may expose you to dangerous voltage or other hazards. Refer all servicing to qualified service personnel.

19. Damage Requiring Service

Unplug this TV receiver from the wall outlet and refer servicing to qualified service personnel under the following conditions:

- (a) When the power-supply cord or plug is damaged.
- (b) If liquid has been spilled, or objects have fallen into the TV receiver.
- (c) If the TV receiver has been exposed to rain or water.
- (d) If the TV receiver does not operate normally by following the operating instructions. Adjust only those controls that are covered by the operating instructions as an improper adjustment of other controls may result in damage and will often require extensive work by a qualified technician to restore the TV receiver to its normal operation.
- (e) If the TV receiver has been dropped or the cabinet has been damaged.
- (f) When the TV receiver exhibits a distinct change in performance — this indicates a need for service.

20. Replacement Parts

When replacement parts are required, be sure the service technician has used replacement parts specified by the manufacturer or have the same characteristics as the original part. Unauthorized substitutions may result in fire, electric shock or other hazards.

21. Safety Check

Upon completion of any service or repairs to this TV receiver, ask the service technician to perform safety checks to determine that the TV receiver is in safe operating condition.

►Warning:

Do not leave stationary images, such as stock market reports or video games, on-screen for more than 10 minutes. Still patterns such as these can scar the TV, causing permanent damage to the picture tube.



Congratulations on your purchase of this Mitsubishi TV. Your TV is designed for superb viewing pleasure as well as continued reliability.

To familiarize you with your TV and owner's guide, we suggest that you read through the preface, which provides the following important information:

- ◆ **Summary of Special Features**
- ◆ **Unpacking Your TV**
- ◆ **What's in Each Chapter**
- ◆ **Some Conventions Used in this Guide**

Mitsubishi has strived to create your TV so that it will bring you years of viewing enjoyment. Similarly, your owner's guide is designed with a "user friendly" philosophy that will help you take advantage of all of your equipment's features.

Once again, thank you for selecting our product and welcome to Mitsubishi!

◆ Summary of Special Features

Your top rated Mitsubishi TV delivers:

- **181-Channel Capacity** --- programs up to 181 channels, ensuring your continued viewing pleasure as cable services continue to expand.
- **Two-Speaker Sound System** --- a special speaker system that produces clear stereo sound.
- **Expanded Sound Capability** --- allows you to connect the TV to an external audio system for enhanced listening pleasure.

In addition to the standard features found on most advanced TVs, Mitsubishi is proud to offer the following distinctive features:

- **Remote Control with TV/VCR/CABLE Function** --- uses a single remote control transmitter for the television, certain Mitsubishi VCRs, and also some VCRs and cable boxes from other manufacturers.
- **On-Screen Displays** --- appear whenever you adjust your TV, showing you the status of your TV's various functions.
- **On-Screen Menu** --- simplifies the television's features with easy to follow instructions.
- **Closed Caption Decoder** --- decodes hidden text information included with TV shows and displays the text on-screen.
- **Extended Data Services** --- (also known as "XDS,") allows broadcasters to supply you with channel information, program information, and the time of day. You can display this information on-screen.
- **Picture-in-Picture Mode** --- allows you to view two different sources at the same time. (CS-31305, CS-31309, and CK-31304 only.)

Each of these features will be explained in more detail in Chapter 3, "Operating Your TV," and Chapter 4, "Using the Special Features."

◆ Unpacking Your TV

What you will find

As you unpack your new TV, please check to be sure that along with the TV, the following items are included:

- an owner's guide containing a warranty,
- a registration card,
- a remote control transmitter, and
- a set of two AA size batteries for the remote control.

A few suggestions

Before you hook up your new TV, please take a few minutes to:

- ❶ Complete the registration card. The registration card asks for the TV's serial number, which you'll find on the back of the unit.
- ❷ Keep the box and packing materials for future use.
- ❸ File your sales receipt.
- ❹ Place the TV on a stable surface with sufficient lighting to do the hook-up.

◆ What's in Each Chapter

Here's what you will find in this owner's guide:

Chapter 1, "Getting to Know Your TV," introduces you to the location and functions of the buttons and controls of your TV.

Chapter 2, "Connecting Your TV," explains how to connect a VCR, antenna, decoder box and other equipment to your TV.

Chapter 3, "Operating Your TV," provides the step-by-step instructions you need in order to use your TV.

Chapter 4, "Using the Special Features," explains how to use some of the special features of the TV.

Chapter 5, "Troubleshooting," summarizes the problems you may have along with suggestions for remedying these problems.

The appendix explains a procedure that allows you to bypass the parental lock.

You'll also find a detailed index at the back of the book.

◆ Some Conventions Used in this Guide

Mitsubishi has gone to great effort to provide users with an easy-to-follow, useful owner's guide. You will find that different types of information are treated in different ways.

Users should read information labeled **Important** and information that is boxed and labeled **Warning**. The owner's guide uses these terms sparingly, and you should carefully read all information highlighted in this manner.

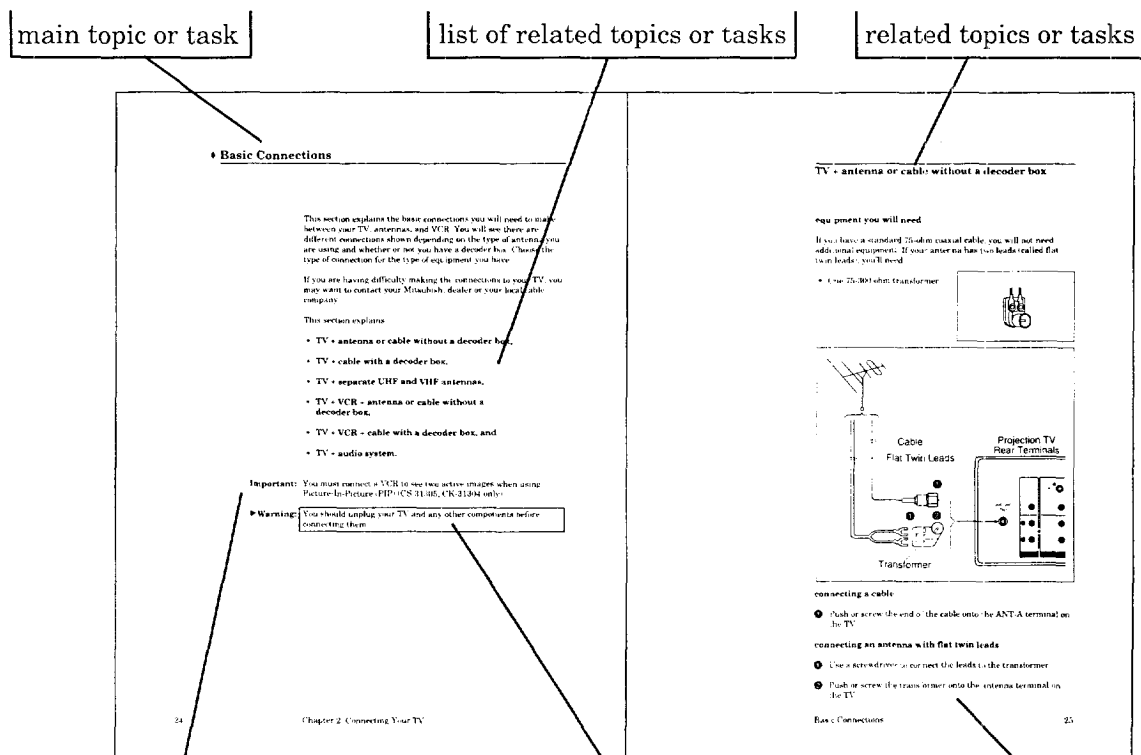

>Important:

This cue indicates information critical to the operation of your new TV.

▶Warning

This cue alerts you to information describing dangerous situations that could ruin your equipment or cause electrical shock.

①, ②, etc.

The step-by-step instructions on how to accomplish a particular task are signaled by white numbers on a black background.



Now that you've unpacked your TV, read through the safety information, and glanced at the overview explaining how this owner's guide is organized, it's time to become familiar with the buttons and controls you'll be using when you operate the TV. This chapter will introduce the range of options available when using the buttons on the remote control or on the control panel of the TV. It also offers some general guidelines for using the remote control.

Most functions can be controlled by using either the control panel or the remote control, but certain specialized functions require the use of one or the other. This chapter, which will familiarize you with the full range of button functions, contains the following sections:

- ◆ **Overview of the Control Panel**
- ◆ **Overview of the Remote Control**

◆ Overview of the Control Panel

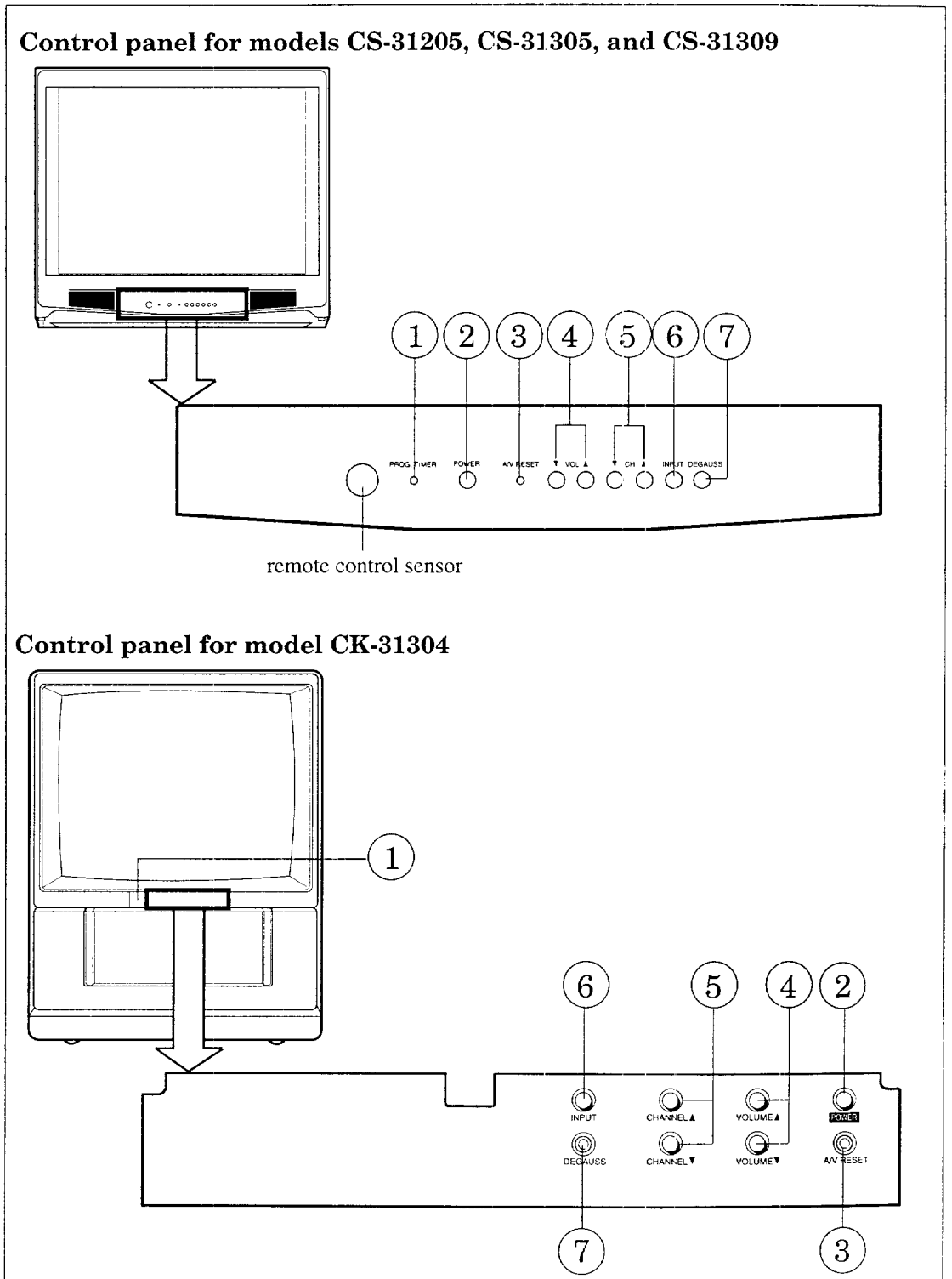

- ① **power / program timer indicator**
This indicator lights up in green when you turn the TV on; it lights up in red when the timer is set and the TV's power is off; it lights in orange if the timer is set and the TV's power is on.
- ② **power button (POWER)**
Use this button to turn the TV on or off. When you turn the TV on, the power indicator will light in green.
- ③ **A/V reset button (A/V RESET)**
Press this button to reset all audio and video functions to their normal level or setting, except: volume, reception mode, speaker, and closed captioning.
- ④ **volume controls (VOL)**
Press the ▲ button to turn up the volume and the ▼ button to turn down the volume.
- ⑤ **channel controls (CH)**
Use the ▲ button to switch to a channel with a higher number and the ▼ button to switch to a channel with a lower number.
- ⑥ **input button (INPUT)**
Use this button to select the input source you want to view:
 - TV, or
 - Input.
- ⑦ **degauss button (DEGAUSS)**
If there is color impurity in your TV's picture, press this button.

◆ Overview of the Remote Control

Getting ready to use the remote control

installing the batteries

- ❶ Take the box containing two AA size batteries from the packing bag.
- ❷ Remove the back cover of the remote control by pushing in the direction of the arrow.
- ❸ Load the batteries as indicated in the illustration, making sure that they are positioned correctly (+ to +, and - to -).
- ❹ Replace the back cover of the remote control.

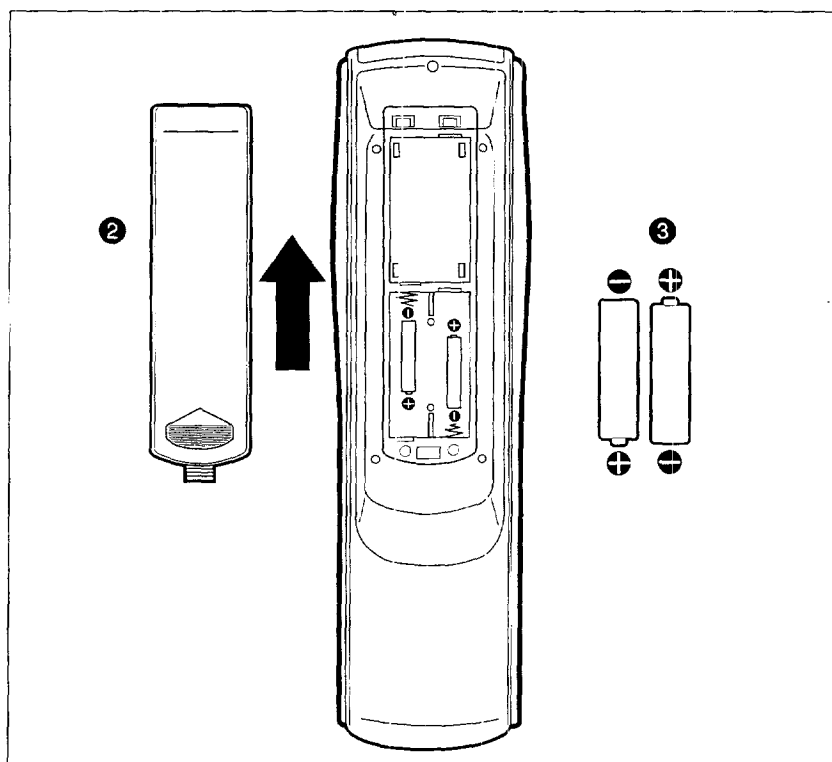

For best results, use Duracell AA (MN1500) batteries.

some do's and don'ts

To ensure that your remote control will continue working properly, follow these guidelines:

- Don't press two or more buttons at the same time, unless specifically instructed to do so in this owner's guide.
- Don't allow the remote control to get wet or become heated.
- Avoid dropping the remote control on a hard surface.
- When cleaning the remote control, don't use any harsh chemicals. Use only a soft, slightly moistened cloth.

general instructions

When using the remote control to operate the TV, VCR, or cable box, follow these procedures:

- ❶ Be within 20 feet of the desired equipment.
- ❷ Point the top of the remote control toward the equipment.
- ❸ Press the appropriate button or sequence of buttons.

guidelines for using batteries

- Don't use a new battery with an old one.
- Don't heat, take apart, or throw batteries into a fire.

The following section explains more about the range of options available when using the remote control.

Remote control buttons and functions

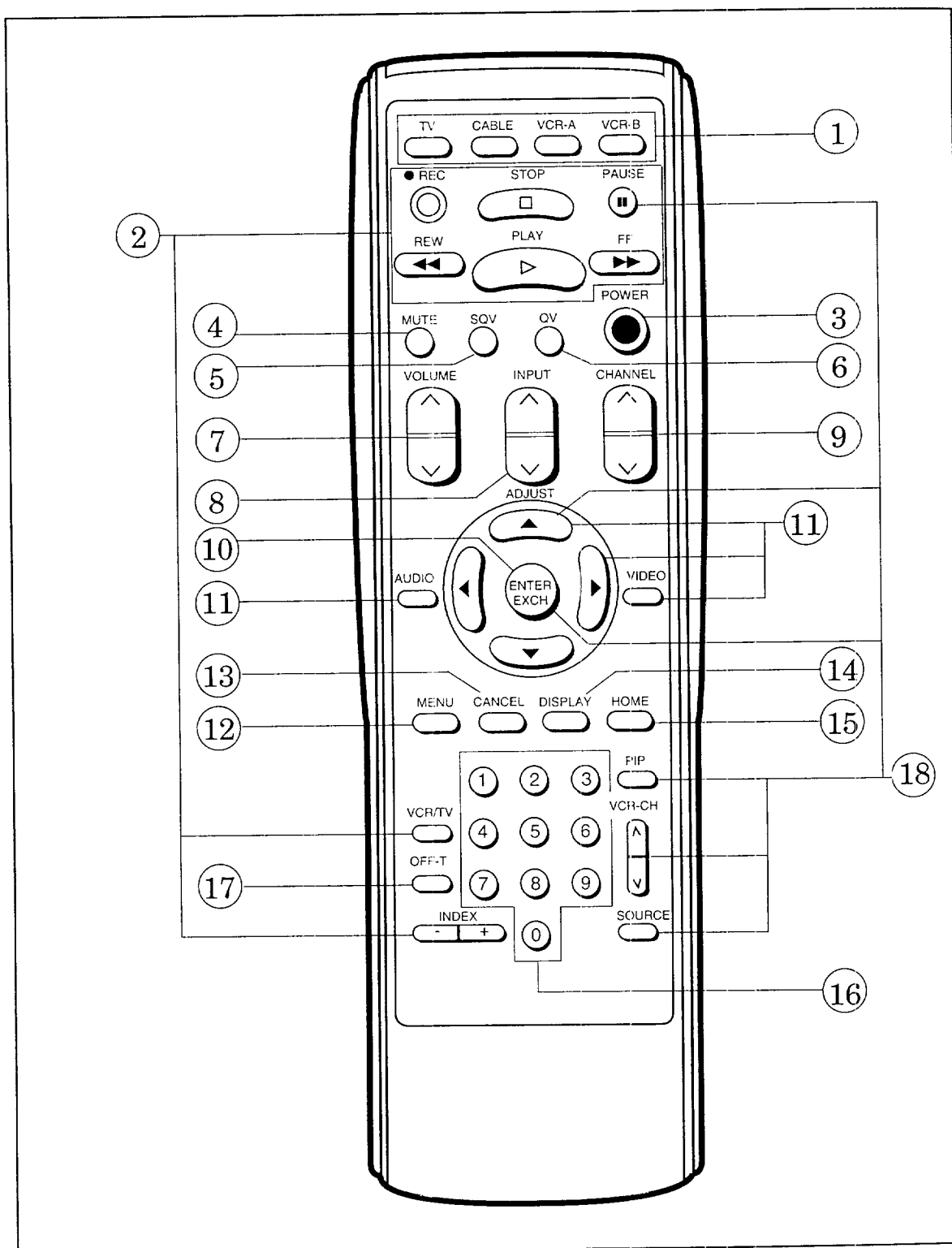

- ① **select buttons**
Use these buttons to select the component you wish to operate: the TV, a cable decoder box, or a VCR. These buttons are also used to set up your remote control for your particular brand of cable box or VCR.
- ② **VCR buttons**
These buttons can be used to control VCRs. The remote control is pre-set to operate Mitsubishi VCRs, and it can be programmed to operate VCRs from other manufacturers. (The CS-31205 remote control does not have index buttons.)
- ③ **power button (POWER)**
Use this button to turn the TV on or off. When you turn the TV on, the power indicator lights in green.
- ④ **mute control (MUTE)**
Use this button to turn the sound off completely or to restore it to its original volume.
- ⑤ **super quick view button (SQV)**
Press this button to view the channels that you have programmed into super quick view memory. (See page 45.)
- ⑥ **quick view button (QV)**
Press this button to instantly switch to the channel that you memorized as the quick view channel. (See page 45.)
- ⑦ **volume control (VOLUME)**
Press the top part of the button to turn up the volume; press the bottom part of the button to turn down the volume.
- ⑧ **input button (INPUT)**
Use this button to select the input source you wish to view:
 - TV, or
 - Input.
- ⑨ **channel control (CHANNEL)**
Press the top part of this button to change to a channel with a higher number; press the bottom part to change to a channel with a lower number.
- ⑩ **enter and exchange button (ENTER/EXCH)**
Use this button after selecting a channel number or after selecting an item from the on-screen menu system. You will also use this button with the PIP modes (CS-31305, CS-31309, and CK-31304 only).

Remote control buttons and functions (cont.)

⑪ **audio and video controls**

These buttons are used together to adjust audio and video functions (other than volume) with a two-step process: you use the audio or video button to select a function, then you use the adjust up/down buttons or right/left buttons to adjust it.

- **audio function button (AUDIO)** --- Use this button to select one of the following audio functions:
 - stereo/SAP/mono,
 - bass,
 - treble,
 - balance,
 - surround off/simulate/hall, or
 - speaker on/off.
- **video function button (VIDEO)** --- Use this button to select one of the following video functions:
 - tint,
 - color,
 - contrast,
 - brightness,
 - sharpness,
 - color temperature high/middle/low, or
 - closed captioning.
- **adjust buttons (ADJUST ▲ ▼), right/left buttons (◀▶)**
After selecting the audio or video function, use the ADJUST buttons (▲ ▼) or right/left buttons (◀▶) to adjust the function you've selected. These buttons can be used to:
 - turn the function on or off (e.g., speaker),
 - increase or decrease the function (e.g., color),
 - shift from one end of a scale to the other (e.g., balance), or
 - select a position (e.g., stereo).

You will also use the adjust buttons with the Picture-in-Picture features (CS-31305, CS-31309, and CK-31304 only) and to select items on the on-screen menus. (The CS-31205 remote control does not have right/left buttons.)

⑫ **menu button (MENU)**

Use this button to display the on-screen menu system, which gives you access to your TV's features.

⑬ **cancel button (CANCEL)**

This button is used to cancel a channel number, to clear a channel from super quick view memory, and to clear the settings of on-screen menus.

- ⑭ **display button (DISPLAY)**
Use this button to view an on-screen summary of the current TV settings and the displays related to Extended Data Services (XDS).
- ⑮ **home button (HOME)**
Press this button to return to regular TV viewing from the on-screen displays and menus. This button can also be used to turn off captions.
- ⑯ **number buttons (0-9)**
Use these buttons to select a channel number and to enter the parental lock code.
- ⑰ **off-timer button (OFF-T)**
Use this button to program the TV to turn off automatically at a later time.
- ⑱ **picture-in-picture controls (CS-31305, CS-31309, and CK-31304 only)**
Use these buttons to control the special picture-in-picture (PIP) modes. (For more information, see pages 72-78.)
- **PIP button (PIP)** --- Press this button to begin displaying the PIP image, to change the image's size, or to cancel it.
 - **VCR channel button (VCR-CH)** --- If you use a VCR as the source for the PIP image, use this button to change the channel of the PIP image.
 - **source button (SOURCE)** --- Press this button to switch the source of the PIP image between the TV and the external input.
 - **pause button (PAUSE)** --- Press this button to freeze the PIP image or to return the image to a "live" picture. You can also use this button with the Snapshot and Replay features.
 - **enter and exchange button (ENTER/EXCH)** --- Press this button to exchange the contents of the PIP image and the main image.
 - **adjust (up/down) buttons, right/left buttons** --- Press these buttons to move the PIP image on the screen.



CHAPTER TWO
Connecting Your TV

This chapter offers step-by-step instructions for completing the most common hook-ups. It contains the following sections:

- ◆ **Overview of the Back Panel**
- ◆ **Basic Connections**

◆ Overview of the Back Panel

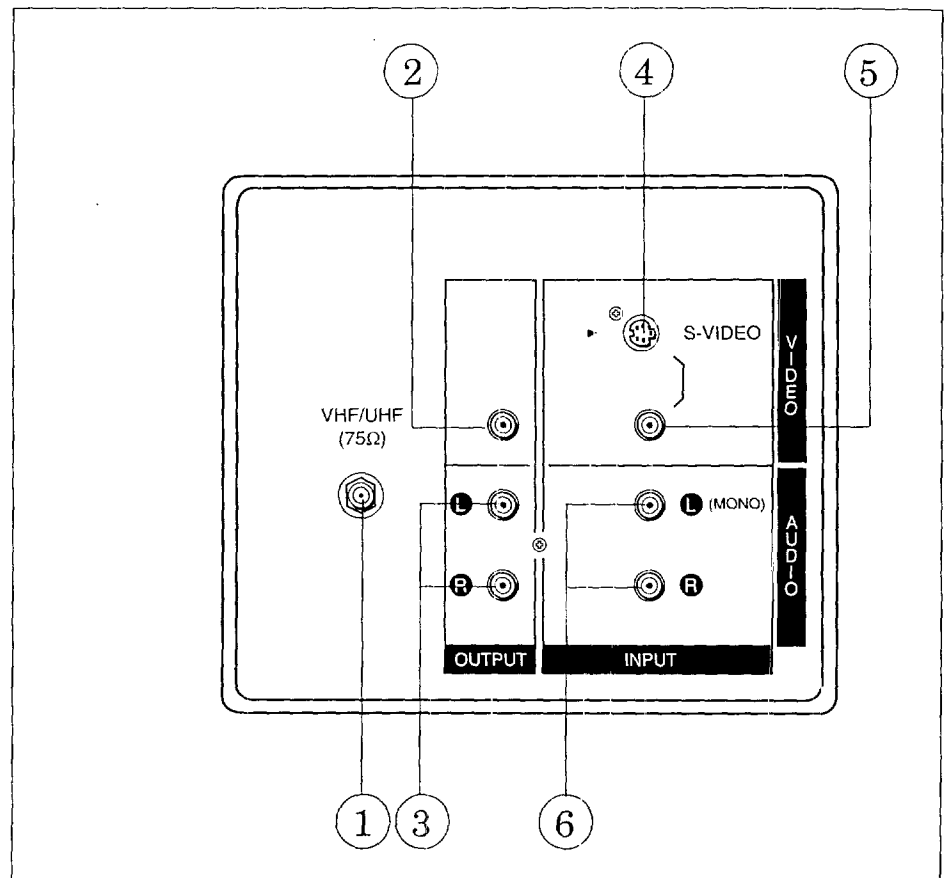

① **antenna terminal**

Connect a cable antenna or a VHF/UHF antenna here.

② **video output terminal**

Use these terminals to “send out” the TV’s video signal to a VCR, a video copy processor, etc.

③ **audio output terminals**

Use these terminals to “send out” the TV’s audio signal to a VCR, a video copy processor, etc.

>**Important:** Never connect one piece of equipment to both the TV’s input terminals and the TV’s output terminals. If you do, the TV will turn off as a safety precaution.

④ **S-VIDEO input terminal**

Use these terminals to “bring in” a Super VHS (S-VHS) signal from a VCR or disc player into the TV.

▷ **Important:** If you connect Super VHS equipment, this input will automatically be the input for viewing your VCR.

⑤ **video input terminal**

Use this terminal to “bring in” a video signal from a VCR or another component into the TV.

⑥ **audio input terminals**

Use these terminals to “bring in” an audio signal from a VCR or other equipment into your TV.

◆ Basic Connections

This section explains the basic connections you will need to make between your TV, antennas, and VCR. You will see there are different connections shown depending on the type of antenna you are using and whether or not you have a decoder box. Choose the type of connection for the type of equipment you have.

If you are having difficulty making the connections to your TV, you may want to contact your Mitsubishi dealer or your local cable company.

This section explains:

- **TV + antenna or cable without a decoder box,**
- **TV + cable with a decoder box,**
- **TV + separate UHF and VHF antennas,**
- **TV + VCR + antenna or cable without a decoder box,**
- **TV + VCR + cable with a decoder box, and**
- **TV + audio system.**

▷ **Important:** You must connect a VCR to see two active images when using Picture-In-Picture (PIP) (CS-31305, CS-31309, and CK-31304 only).

▶ **Warning:** You should unplug your TV and any other components before connecting them.

TV + antenna or cable without a decoder box

equipment you will need

If you have a standard 75-ohm coaxial cable, you will not need additional equipment. If your antenna has two leads (called flat twin leads), you'll need:

- One 75-300 ohm transformer.

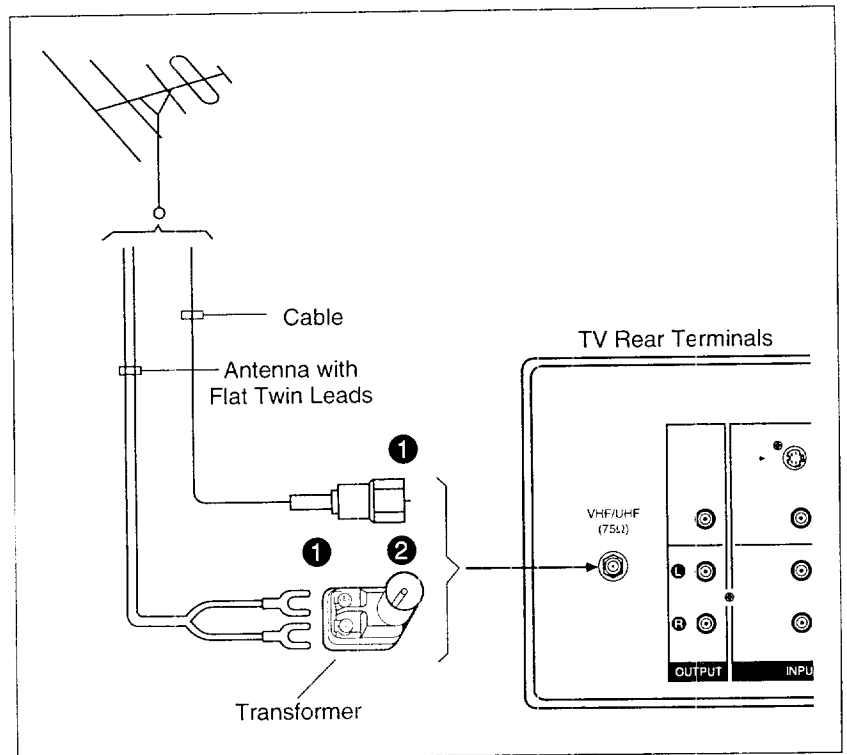
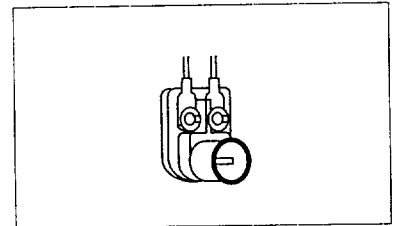

connecting a cable

- 1 Push or screw the end of the cable onto the ANT-A terminal on the TV.

connecting an antenna with flat twin leads

- 1 Use a screwdriver to connect the leads to the transformer.
- 2 Push or screw the transformer onto the antenna terminal on the TV.

TV + cable with a decoder box

equipment you will need

Use this hook-up if you need a decoder box to descramble cable channels. When you complete this hook-up, you should set up your remote control to operate your cable box (see page 37).

To complete the hook-up, you'll need:

- One length of 75 ohm coaxial cable.

procedure

- 1 Connect the incoming cable to the IN terminal on the decoder box.
- 2 Connect the coaxial cable to the OUT terminal on the back of the decoder box; connect the other end of this cable to the antenna terminal on the back of the TV.

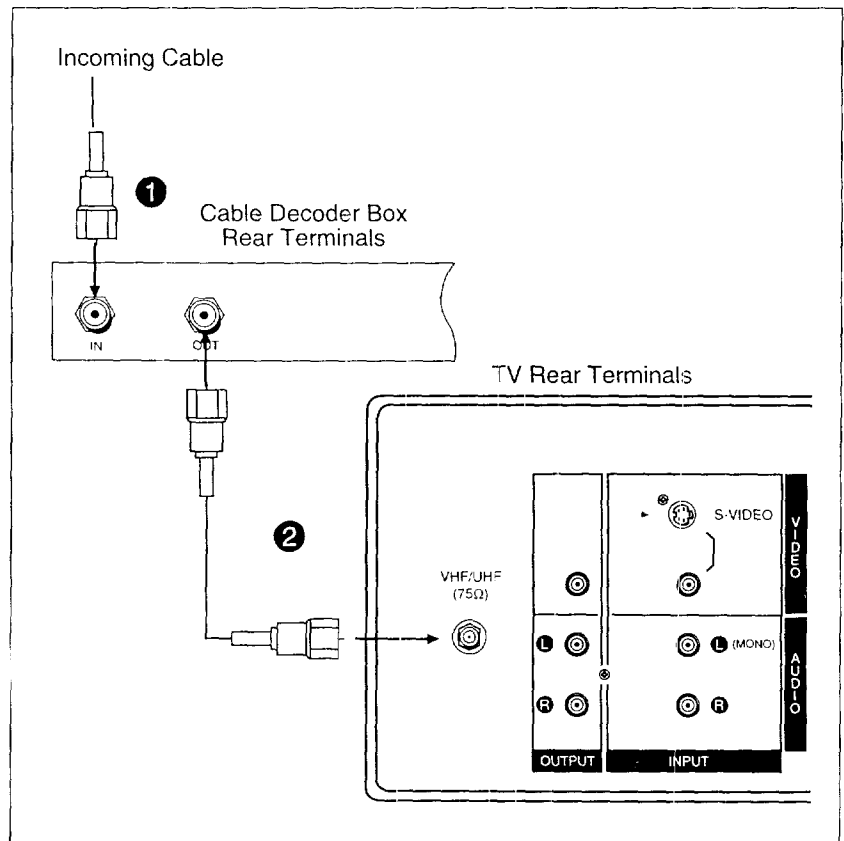
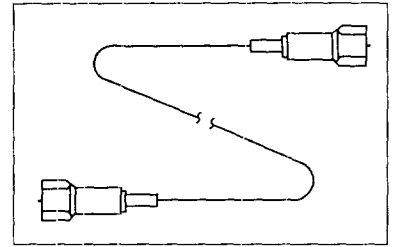

TV + separate UHF and VHF antennas

equipment you will need

If UHF and VHF signals are brought into your home with two separate antennas, you'll need to combine the antennas in order to connect them to the TV. To do this you will need a UHF/VHF combiner. (There are different combiners for different kinds of leads. Check with your local electronics store for the kind of combiner you need.)

- Pictured to the right is a standard combiner.

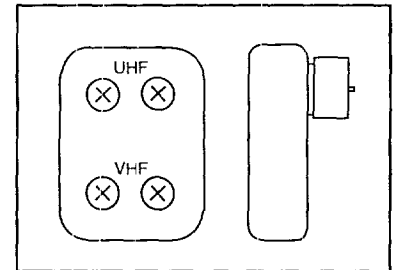

To connect separate UHF and VHF antennas to your TV:

- 1 Connect the UHF and VHF antenna leads to the appropriate terminals on the UHF/VHF combiner.
- 2 Press the combiner onto the antenna terminal on the rear of the TV.

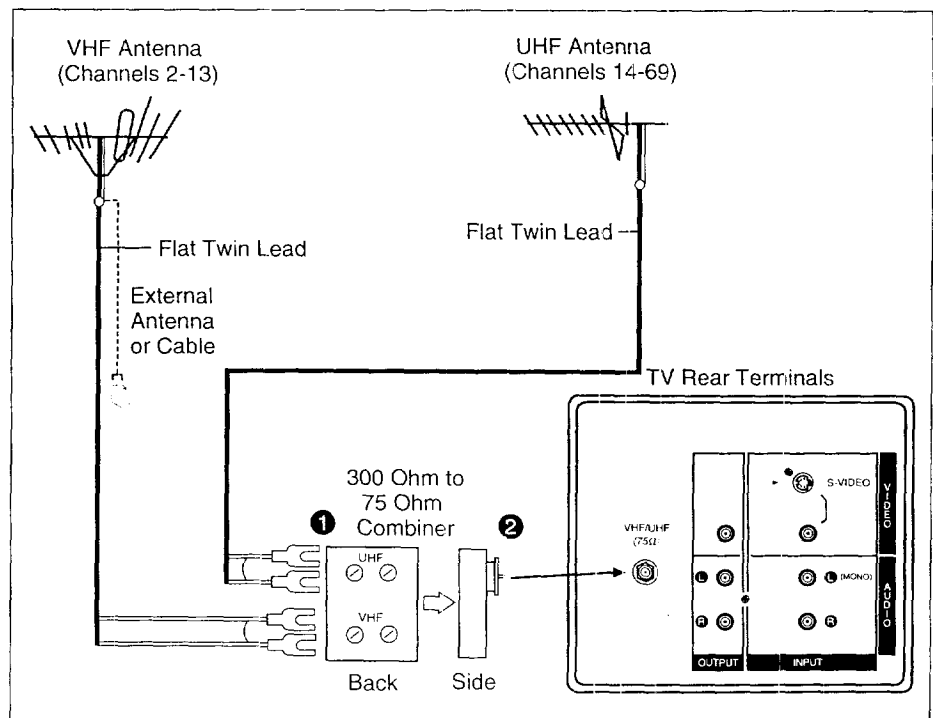

TV + VCR + antenna or cable without a decoder box

equipment you will need

You may want to connect a VCR along with your antennas or cable. To complete this hook-up, you may need the following equipment:

- One 75 ohm coaxial cable,

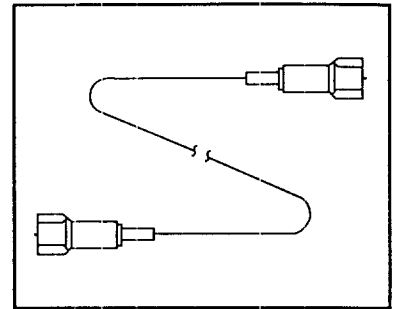

- One set of RCA pin-type audio cables,

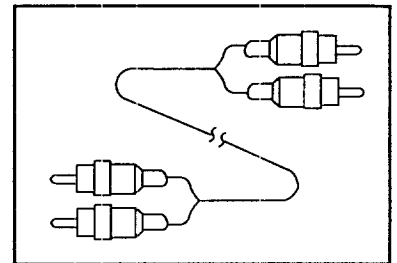

- One RCA pin-type video cable, (if connecting a standard VCR), or

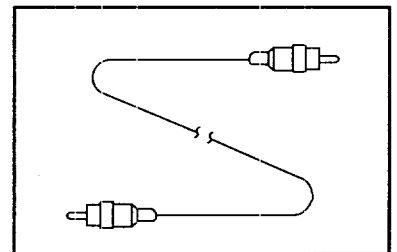

- One S-Video cable for Super VHS VCRs.

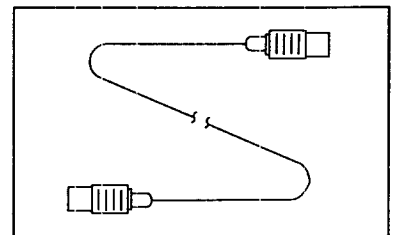

procedure

(See illustration on the following page.)

- ❶ Connect the incoming cable or antenna to the ANTENNA IN terminal on the VCR.
- ❷ Connect one end of a coaxial cable to the ANTENNA OUT terminal on the VCR.
- ❸ Connect the other end of the coaxial cable to the antenna terminal on the TV.
- ❹ Connect an RCA pin-type video cable to the VIDEO OUT terminal on the back of the VCR. Connect the other end of this cable to the VIDEO INPUT terminal on the back of the television.

Important: If you are connecting a Super VHS (S-VHS) VCR, use an S-Video cable instead of an RCA pin-type video cable. Connect this S-Video cable to the S-VIDEO OUT terminal on the VCR. Connect the other end of this cable to the S-VIDEO INPUT terminal on the back of the TV.

- ❺ Connect a set of RCA pin-type audio cables to the AUDIO OUT terminals on the back of the VCR. Use the red cable to connect the right (R) channel and the white cable for connecting the left (L) channel.

- ❻ Connect the other ends of these cables to the AUDIO INPUT terminals on the back of the TV.

Important: If your VCR is monaural (non-stereo), you only need to connect a single RCA pin-type audio cable. Connect the cable to the VCR, then connect the other end to the L (LEFT) audio input on the back of the TV.

Important: If your VCR has a video channel switch, set it to "OFF/AV." See your VCR's owner's guide for details.

- ❼ Start playing a tape on your VCR.
- ❽ Use the INPUT button on your TV's remote control to select Input-1.

TV + antenna or cable without a decoder box (cont.)

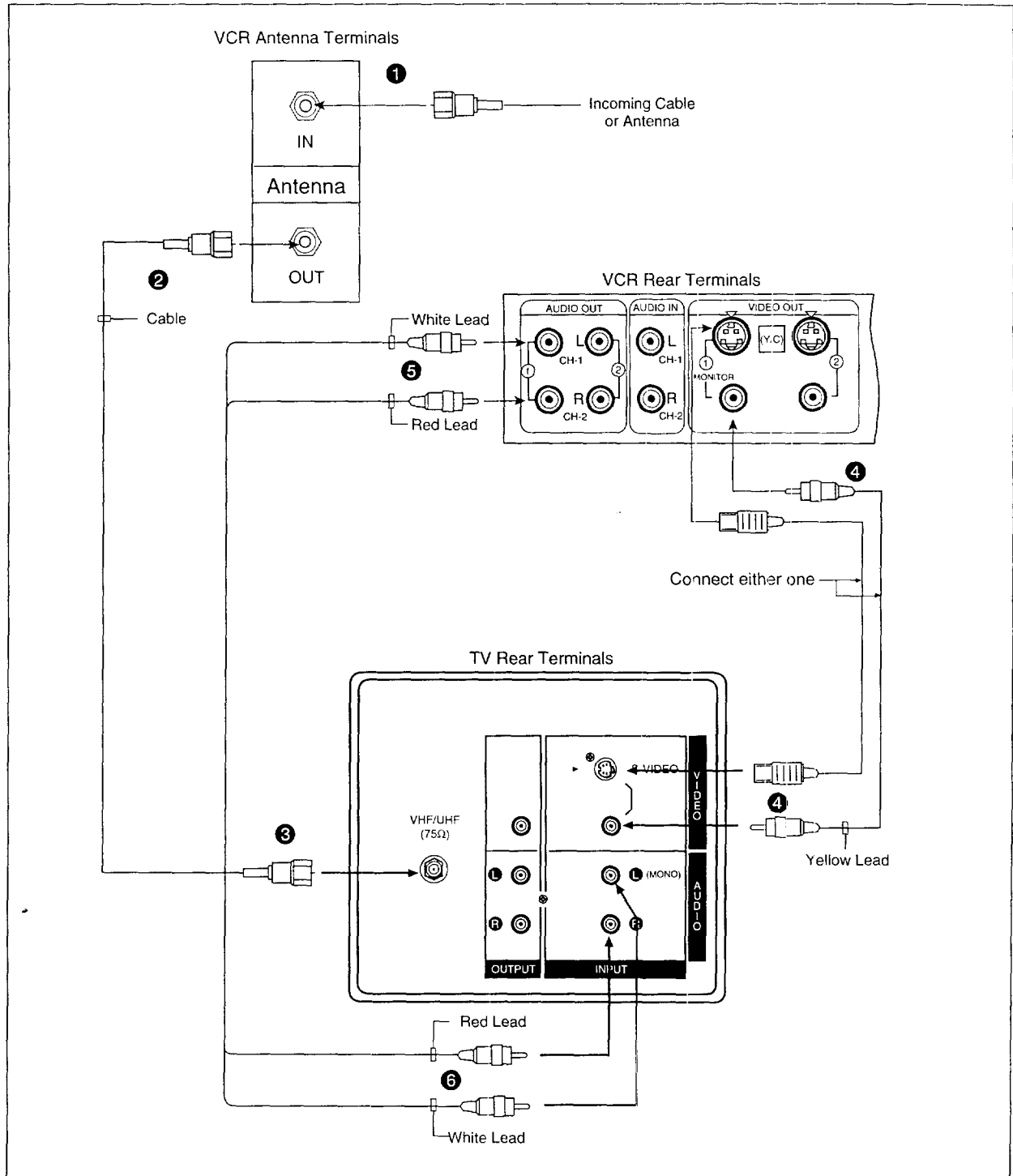

TV + VCR + cable with a decoder box

equipment you will need

This hook-up will allow you to watch a non-scrambled channel while you are recording another channel. When you complete this hook-up, you should set up your remote control to operate your cable box (see page 37).

To complete the hook-up, you will need:

- One two-way splitter,
- Three lengths of 75 ohm coaxial cable,
- One set of RCA pin-type audio cables,
- One RCA pin-type video cable, (if connecting a standard VCR), or
- One S-Video cable for Super VHS VCRs.

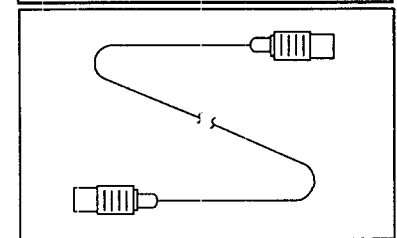
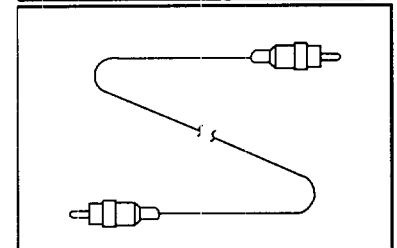
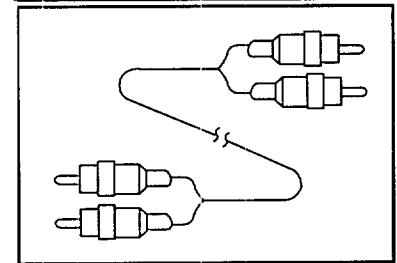
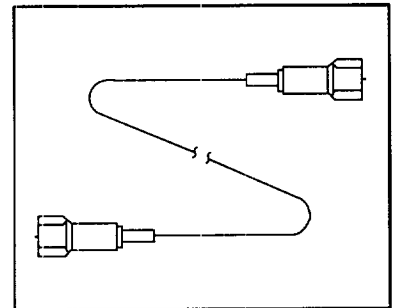
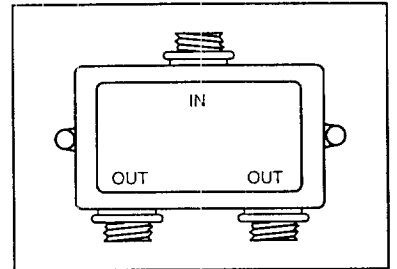

TV + VCR + cable with a decoder box (cont.)

procedure

- ❶ Connect the incoming cable to the IN terminal on the two-way splitter.
- ❷ Connect a coaxial cable to one of the OUT terminals on the two-way splitter. Connect the other end of this cable to the antenna terminal on the back of the TV.
- ❸ Connect a second coaxial cable to the other OUT terminal on the two-way splitter. Connect the other end of this cable to the IN terminal on the decoder box.
- ❹ Connect a third coaxial cable to the OUT terminal on the back of the decoder box; connect the other end of this cable to the ANTENNA-IN terminal on the back of the VCR.
- ❺ Connect an RCA pin video cable to the VIDEO OUT terminal on the back of the VCR. Connect the other end of this cable to the VIDEO INPUT terminal on the back of the TV.

▷ **Important:** If you are connecting a Super VHS (S-VHS) VCR, use an S-Video cable instead of an RCA pin-type video cable. Connect this S-Video cable to the S-VIDEO OUT terminal on the VCR. Connect the other end of this cable to the S-VIDEO INPUT terminal on the back of the TV.

- ❻ Connect a set of RCA pin-type audio cables to the AUDIO OUT terminals on the back of the VCR. Use the red cable to connect the right (R) channel and the white cable for connecting the left (L) channel.
- ❼ Connect the other ends of these cables to the AUDIO INPUT terminals on the back of the TV.

▷ **Important:** If your VCR is monaural (non-stereo), you only need to connect a single RCA pin-type audio cable. Connect the cable to the VCR, then connect the other end to the L (LEFT) audio input on the back of the TV.

▷ **Important:** If your VCR has a video channel switch, set it to "OFF/AV." See your VCR's owner's guide for details.

- ❽ Start playing a tape on your VCR
- ❾ Use the INPUT button on your TV's remote control to select Input-1.

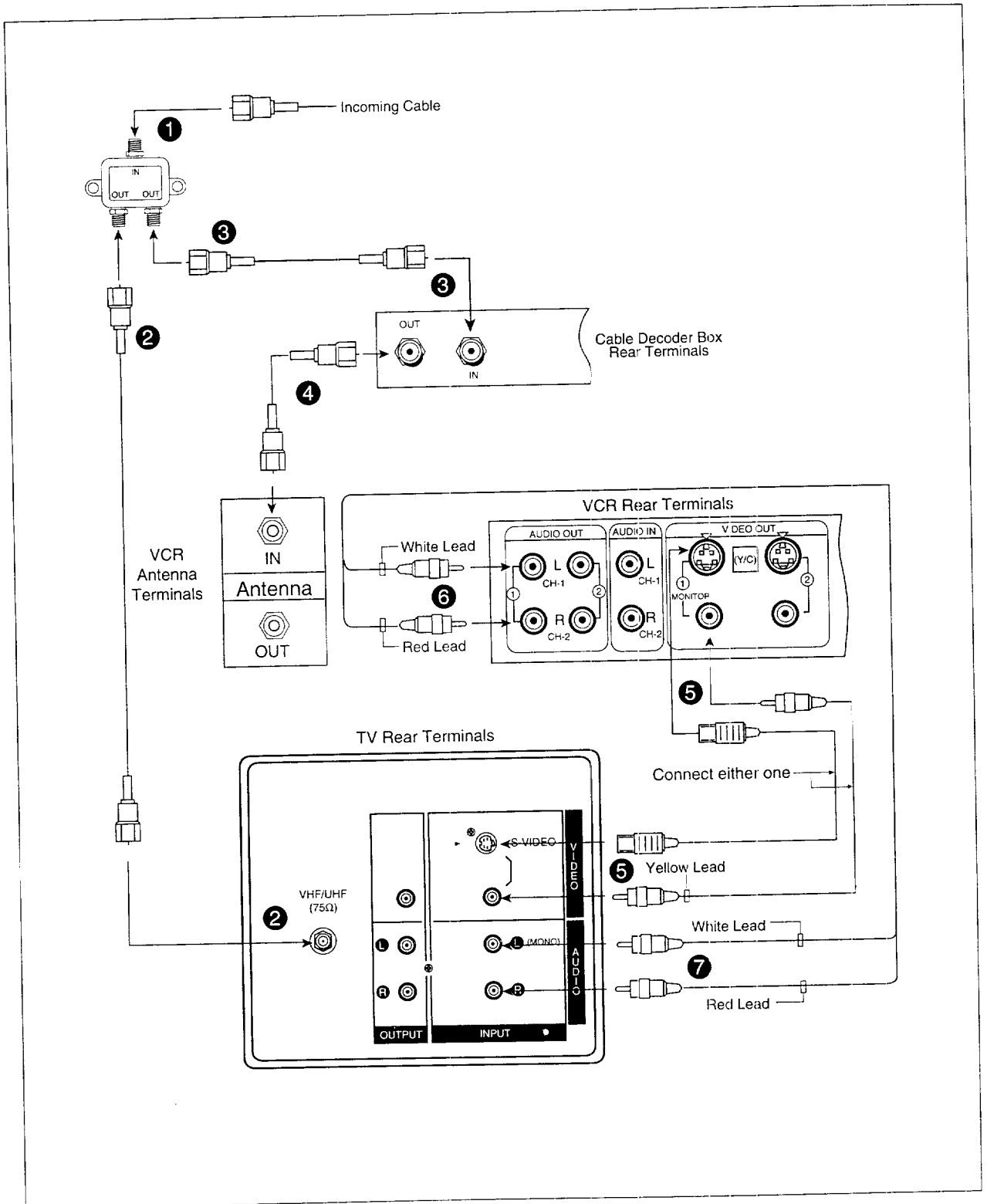

TV + audio system

equipment you will need

To hook up an audio system, you will need:

- One set of RCA pin audio cables.

procedure

- 1 Connect the audio cables to the AUDIO OUTPUT terminals on the back of the TV. Use the red cable to connect the right (R) channel and the white cable to connect the left (L) channel.
- 2 Connect the other ends of these cables to the AUX IN terminals on the back of the audio system.
- 3 Turn off the television's speakers. To do this, press the AUDIO function button on the remote control until you see the "Speaker" display. Set the speakers to "External" by pressing the adjust (up/down) buttons. See "Adjusting the sound," on page 54.
- 4 Set the audio system's input to the "AUX" position.

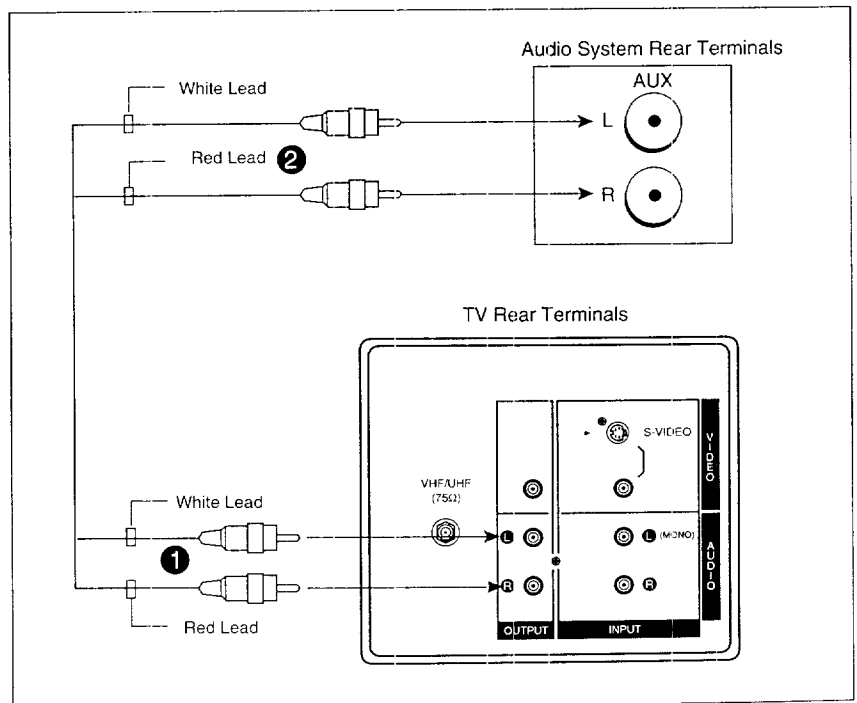
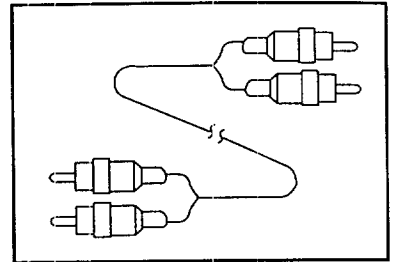



CHAPTER THREE
Operating Your TV

Now that your TV is connected to the cable, antenna, or external components, it's time to enjoy your equipment. This chapter will explain how to operate the TV, first focusing on functions that are basic and easy and then explaining some advanced features.

This chapter explains:

- ◆ **Getting Started**
- ◆ **Using the Advanced Features**

◆ Getting Started

This section is designed to get you started enjoying your new TV. If you follow these procedures one by one, you will soon begin discovering everything your television can do.

You'll find information on:

- **Using the remote control to operate cable boxes and other brands of VCRs,**
- **Turning the TV on/off,**
- **Selecting the input source,**
- **Changing channels,**
- **Understanding the on-screen menus,**
- **Setting the clock,**
- **Memorizing channels,**
- **Adding and deleting channels,**
- **Renaming the input,**
- **Selecting the menu language,**
- **Using video mute,**
- **Adjusting the sound,**
- **Adjusting the picture, and**
- **Using the closed caption decoder.**

Using the remote control to operate cable boxes and other brands of VCRs

operating Mitsubishi components

This TV's remote control comes programmed to operate Mitsubishi TVs and VCRs. The select buttons (across the top of the remote control) determine which component the remote control will operate.

The following buttons are available when using this TV:

- power button
- pause button
- mute control
- super quick view button
- quick view button
- volume control
- input button
- channel control
- enter button
- audio and video controls
- menu button
- cancel button
- display button
- home button
- off-timer button
- number buttons
- PIP controls (CS-31305, CS-31309, and CK-31304 only)
- VCR buttons

operating VCRs or cable boxes from other manufacturers

The remote control is pre-set to operate Mitsubishi VCRs, but it can also operate VCRs from other manufacturers as well. If you have a VCR from another manufacturer, or if you have a cable box, you should "set up" the remote control.

Each layer on the remote control (CABLE, VCR-A or VCR-B) can be set for either a cable box or a VCR.

setting up the remote control to operate your VCR.

- ❶ Turn off your VCR.
- ❷ Press one of the select buttons across the top of the remote control to choose the layer that you want to "set up." You can choose between VCR-A, VCR-B or CABLE.
- ❸ While holding in the POWER button on the remote control, enter the code number listed in the chart on the following page for your brand of VCR. Be sure to enter both digits of the code number. If more than one number is listed, try the first one.
- ❹ Release the POWER button.
- ❺ Press the POWER button again. Your VCR should turn on. If the VCR turns on, your remote control is now set to operate your VCR.

Using the remote control to operate cable boxes and other brands of VCRs (cont.)

If your VCR does not turn on, repeat the instructions, trying each code number listed for your brand of VCR. If none of those code numbers work, try each number, 01 through 20.

| If your VCR is this brand... | ...enter this code | If your VCR is this brand... | ...enter this code |
|------------------------------|--------------------|------------------------------|--------------------|
| Mitsubishi (A) | 01 | Philips | 03, 10, 11 |
| Mitsubishi (B) | 02 | Quasar | 03 |
| Canon | 03 | RCA | 08, 13, 20 |
| Emerson | 04, 05 | Sanyo | 14 |
| Funai | 06 | Scot | 15 |
| GE | 03 | Sharp | 16 |
| Goldstar | 07 | Sony | 17, 18 |
| Hitachi | 08 | Sylvania | 03, 10, 11 |
| JVC | 09 | Symphonic | 06 |
| Magnavox | 03, 10, 11 | Teknika | 04, 06 |
| Multitech | 06 | Toshiba | 15 |
| NEC | 12 | Totevision | 07 |
| Panasonic | 03 | Zenith | 19 |
| Philco | 03, 10 | | |

setting up the remote control to operate your cable box

- ➊ Turn on your cable box.
- ➋ Press one of the select buttons across the top of the remote control to choose the layer that you want to “set up.” You can choose between VCR-A, VCR-B or CABLE.
- ➌ While holding in the POWER button on the remote control, enter the code number listed in the chart on the following page for your brand of cable box. Be sure to enter both digits of the number. If more than one number is listed, try the first one.
- ➍ Release the POWER button.
- ➎ Press the POWER button again. Your cable box should turn off. If the cable box turns off, your remote control is now set to operate your cable box. If your cable box does not turn off, repeat the instructions above, trying each number listed for your brand of cable box. If none of these numbers work, try each number, 51 through 99.

▷**Important:** You may need to press the CHANNEL button to turn your cable box back on.

| If your cable box is this brand... | ...enter this code | If your cable box is this brand... | ...enter this code |
|------------------------------------|----------------------------|------------------------------------|---|
| Zenith | 51 | Tocom | 67, 68, 72 |
| Hamlin | 52, 53, 69 | Panasonic | 63, 70 |
| Jerrold | 54, 57, 58, 59, 60, 85, 87 | Macom | 71 |
| G.I. | 55, 56 | Philips | 73, 74, 75, 76, 77, 93, 94, 95, 96, 97, 98, 99 |
| Oak | 61, 62, 82 | Regency | 79 |
| Pioneer | 64, 65, 84 | | |
| Scientific Atlanta | 66, 86, 88, 89, 91, 92 | | |

- ▷ **Important:** Sometimes manufacturers will change their products, or they may use more than one code. If this is the case, your remote may not be able to operate your VCR or cable box.
- ▷ **Important:** Each layer (CABLE, VCR-A or VCR-B) can be set for either a cable box or a VCR.
- ▷ **Important:** When you replace the batteries in your remote control, the remote will return to its initial setting.

using your remote control to operate your VCR

After you have set up your remote control for your particular brand of VCR, you can use the remote to operate your VCR.

- ❶ Use the select buttons across the top of the remote control to choose the layer you “set up” to operate the VCR: VCR-A, VCR-B, or CABLE.
- ❷ Point the remote control at the VCR and press the desired buttons.

If you are using a Mitsubishi VCR, you will be able to use all of the buttons on the remote control to operate your VCR except for MUTE, VOLUME and the PIP function buttons, which will always operate the TV itself.

If you are using another brand of VCR, you can use the POWER, CHANNEL, REC, STOP, PAUSE, REW, PLAY and FF buttons to operate your VCR.

Using the remote control to operate cable boxes and other brands of VCRs (cont.)

using your remote control to operate your cable box

After you have set up your remote control for your particular brand of cable box, you can use the remote to operate your cable box.

- ❶ Use the select buttons across the top of the remote control to choose the layer you “set up” to operate the cable box: VCR-A, VCR-B or CABLE.
- ❷ Point the remote control at the cable box and press the desired buttons.

Only the POWER and CHANNEL buttons can be used when operating your cable box.

Turning the TV on/off

- ▷ **Important:** Before using the remote control to operate the TV, press the “TV” select button on the remote control.

Use the POWER button on either the control panel or the remote control to turn the TV on and off. The power indicator will light up in green when you turn the TV on.

- ▷ **Important:** Even with the power turned off, there is a small amount of current that continues to flow into the TV. This maintains any changes to the settings and operates the built-in clock and timing functions. Unplugging the set will erase these settings, requiring you to set them again. Unplug the TV only when it won't be used for a long time.

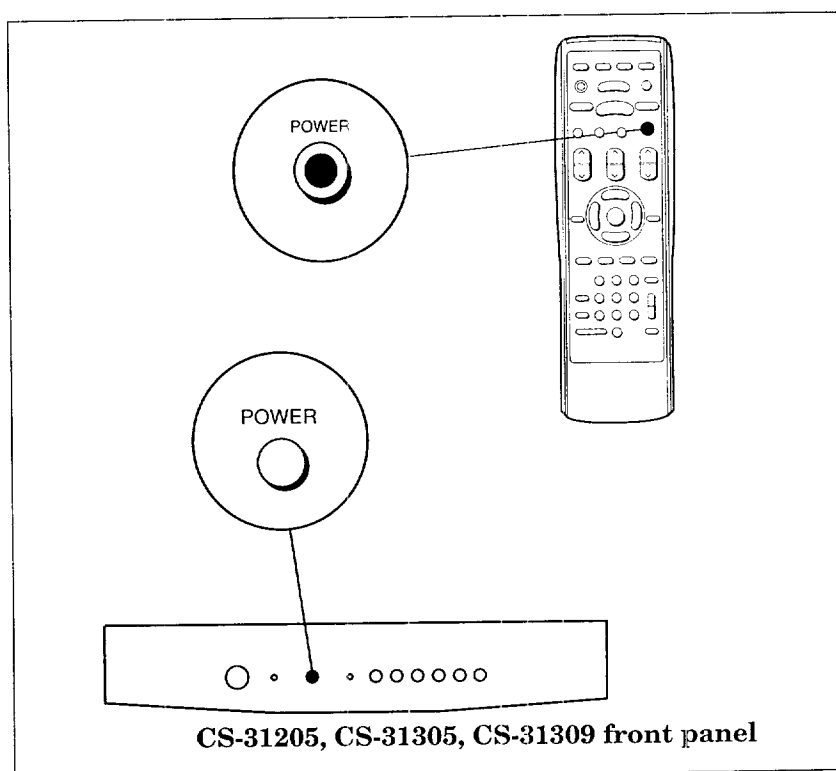

When you turn on your TV for the first time, the screen may be displaying the “Select Language” menu. You should select the on-screen language you want to use. For more information, see page 52, “Selecting the menu language.”

Selecting the input source

Press the INPUT button on the control panel or on the remote control to select the input source you wish to view: TV or Input.

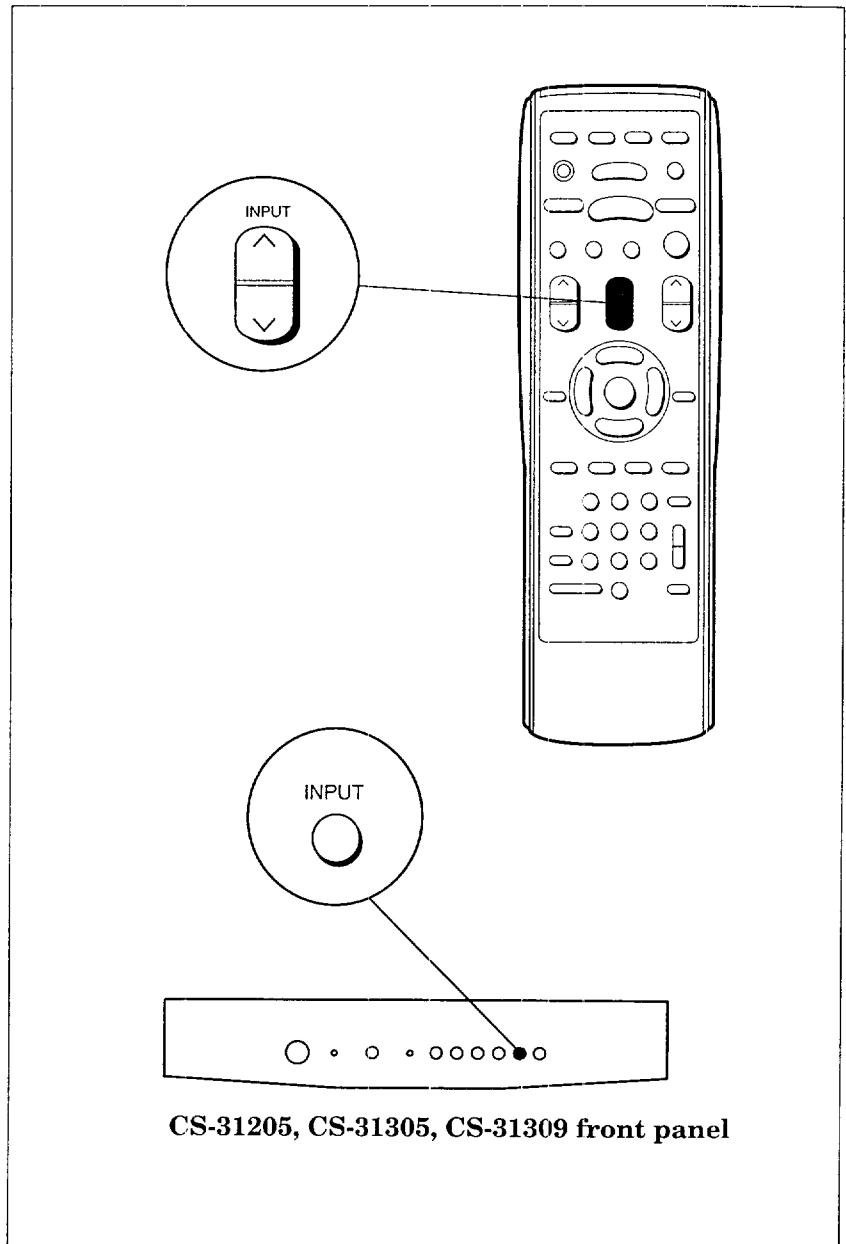

Changing channels

Your TV offers you four ways of changing channels once their numbers have been programmed into channel memory:

- selecting a channel sequentially using the channel controls,
- directly accessing a channel by pressing the number buttons,
- using the Quick View option to switch to a particular memorized channel, and
- using the Super Quick View function to switch between channels on a user-chosen list.

To change channels faster, use either of the following procedures:

- Enter three digits for every channel number, using zeros where needed. (For example, enter “004” to view channel 4 and “028” to view channel 28.)
- Press the ENTER button after selecting the number of the channel. (For example, press “4” and “ENTER” to view channel 4.)

▷ **Important:** Cable channel numbers 0 and greater than 126 are unassigned. TV stations 0, 1 and 70 through 999 are unassigned. If these channel numbers are pressed, the channel remains unchanged.

Changing channels (cont.)

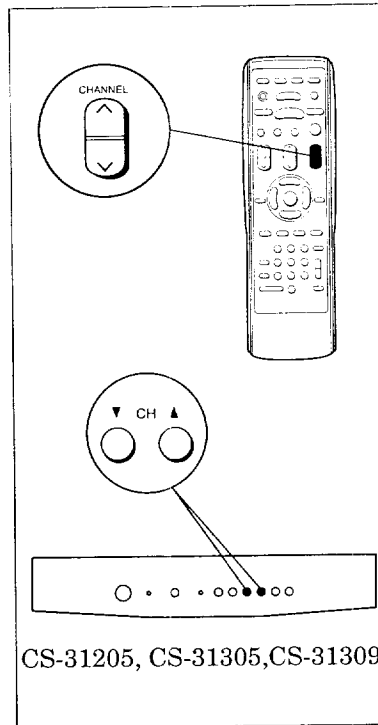

changing channels sequentially

To change channels:

- 1 Press one of the channel controls (CH, CHANNEL) on the control panel or on the remote control. The TV will automatically tune to the next memorized channel.

▷ **Important:** You cannot change channels sequentially until available channels have been programmed into memory. (See “Memorizing channels,” page 49.)

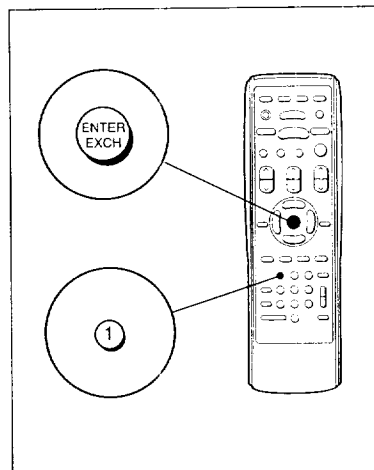

changing channels directly

To move directly to a particular channel without going through the programmed channels in between:

- 1 Use the remote control to select the number of the channel you want to view.
- 2 Press the ENTER button.

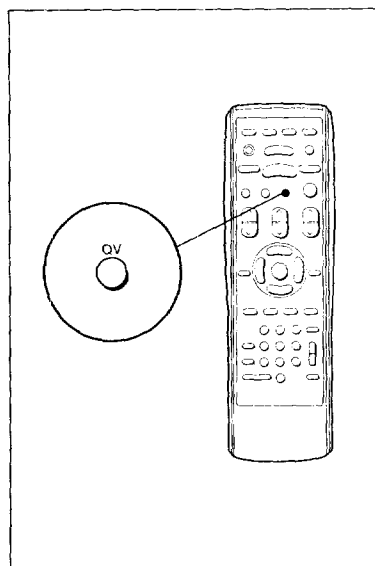

using the Quick View option

Quick View allows you to memorize a particular channel and switch to it quickly.

- 1 Tune to the channel you wish to memorize.
- 2 Press and hold the QV button for about 3 seconds. When you release the button, the channel number will appear on the screen, indicating that you have memorized that channel.
- 3 After you've changed to another channel, press the quick view (QV) button to immediately return to the memorized channel.

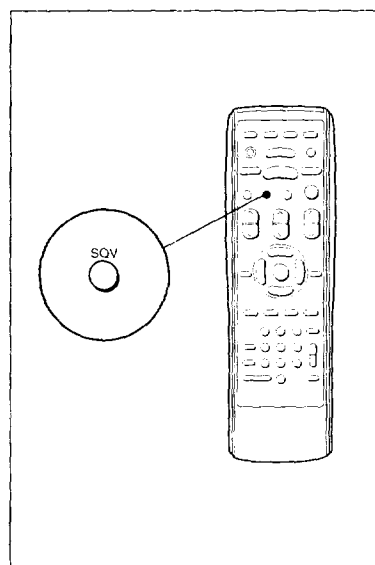

using the Super Quick View option

To view selected channels programmed into Super Quick View memory:

- 1 Enter the desired channels into Super Quick View memory. (See "Using the Super Quick View tuning," page 65.)
- 2 Press the SQV button repeatedly to view the desired channels in sequence.

Understanding the on-screen menus

One of the distinctive features of this TV is an on-screen menu system that provides step-by-step instructions for using some of the TV's special capabilities.

When using any of the on-screen menus, please keep the following in mind:

- The on-screen menus will clear if no item is selected within 5 minutes.
- Unavailable menu items are indicated by light blue letters, instead of the normal white letters.
- Some on-screen menu items must be set before other items are available. For example, "Set the timer" will only be available if "Set the clock" has been set.
- You can exit the on-screen menus any time by pressing the MENU button repeatedly. You will then return to regular TV viewing.
- You can also exit the on-screen menus by pressing the HOME button on the remote control.

Setting the clock

Your TV contains an internal clock to indicate the current time. If there is a broadcaster in your area that is sending the current time along with its regular broadcast signal, then your TV can automatically set its clock with this signal. Otherwise, you can set the clock yourself.

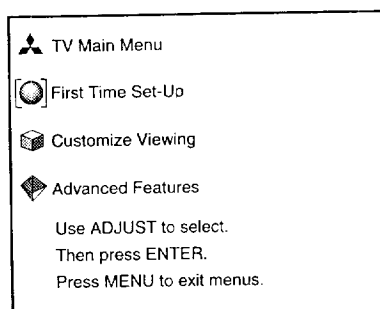

1 Press the MENU button on the remote control. The TV Main Menu will appear on the screen.

2 Select "First Time Set-Up" using the ADJUST buttons; then, press the ENTER button.

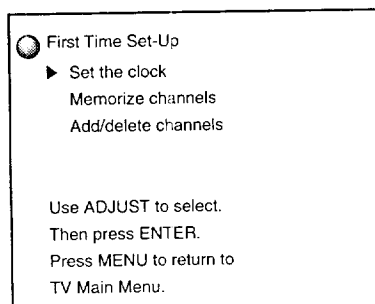

3 You will see the "First Time Set-Up" screen. Select "Set the clock" using the ADJUST buttons; then, press the ENTER button.

4 If you want your TV to set its clock automatically, use the ADJUST buttons to set "Auto clock" to "On"; if you want to set the clock yourself, set "Auto clock" to "Off."

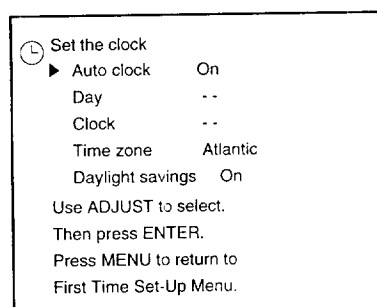

using automatic clock setting

- Set "Auto clock" to "On" using the ADJUST buttons; press the ENTER button.

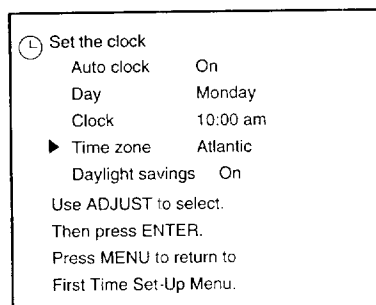

- Use the ADJUST buttons to select the "Time zone" you are in; then, press the ENTER button. The available time zones are: Atlantic, Eastern, Central, Mountain, Pacific, Alaska and Hawaii.

Setting the clock (cont.)

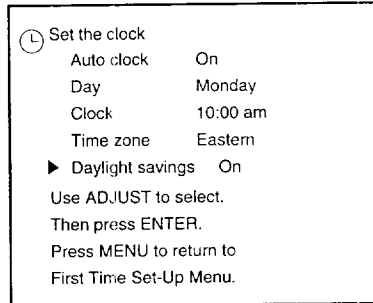

- If you follow daylight savings time, set “Daylight savings” to “On” using the ADJUST buttons. If you do not follow daylight savings time, set it to “Off.” Press the ENTER button.
- At this point, you have prepared the TV to set its clock automatically. The screen will return to the “First Time Set-Up” menu.

► **Important:** The TV can only set the clock automatically when there is a broadcaster in your area that is sending the current time via Extended Data Services (XDS). The clock will start just after the TV receives the XDS signal.

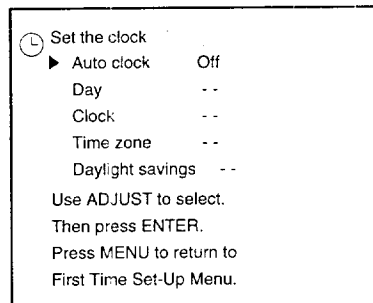

setting the clock yourself

- Set “Auto clock” to “Off” using the ADJUST buttons. Press the ENTER button.

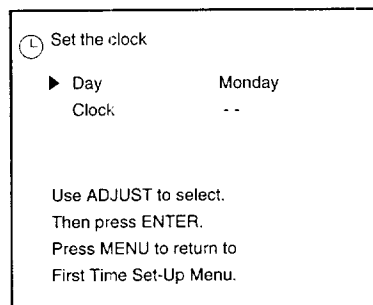

- Select the “Day” using the ADJUST buttons. Press the ENTER button.

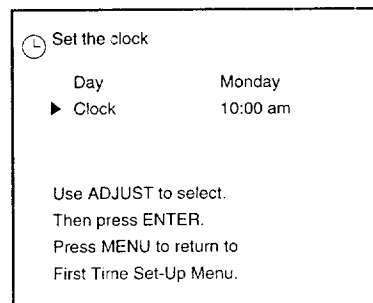

- Set the “Clock” using the ADJUST buttons.
- After you have set the “Day” and “Clock,” press the ENTER button to start the clock.

The screen will return to the “First Time Set-Up” menu.

Memorizing channels

You can use the menus to automatically memorize the channels your TV can receive. Once channels are memorized, you can scan through them using the channel controls on the remote control or on the front panel.

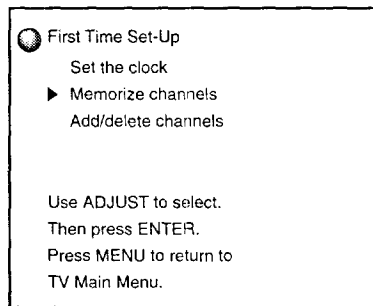

1 Press the MENU button on the remote control. The TV Main Menu will appear on the screen.

2 Select "First Time Set-Up" using the ADJUST buttons; then, press ENTER.

3 Select "Memorize channels" using the ADJUST buttons; then, press ENTER.

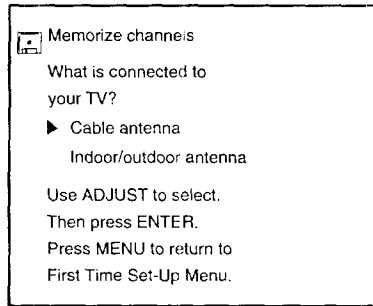

4 Use the ADJUST buttons to choose the type of antenna you connected: Cable antenna or Indoor/outdoor antenna. Press ENTER.

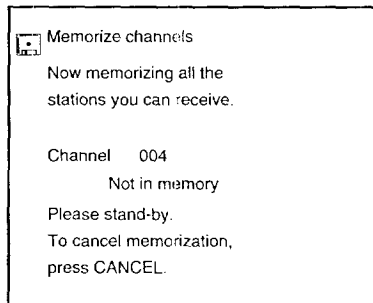

5 You will see a message that channel memorization is in progress. A channel being added to memory will be labeled "In memory." Channels not being added will be labeled "Not in memory." You can stop channel memorization at any time by pressing CANCEL.

▷ **Important:** Channel controls will work only after channels have been memorized. After memorization, use the channel controls (CH, CHANNEL) to automatically advance to the next memorized channel. Use the number buttons to select individual channels.

Adding and deleting channels

After all available channels have been programmed automatically, channels with weaker signals can be added or deleted with the following procedure.

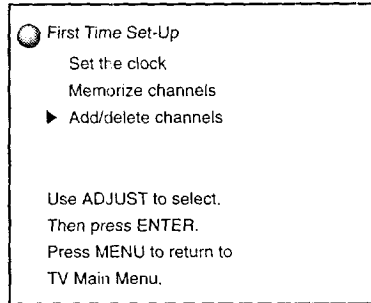

- 1 Press the MENU button on the remote control. The TV Main Menu will appear on the screen.
- 2 Select "First Time Set-Up" using the ADJUST buttons; then, press ENTER.
- 3 Select "Add/delete channels" using the ADJUST buttons; then, press ENTER.

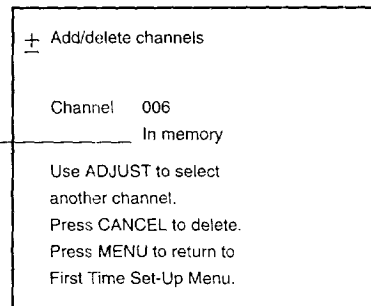

Either "In memory" or "Not in memory" will appear.

- 4 The "Add/delete channels" screen will appear. Use the ADJUST buttons to select the channel you would like to add or delete.

(You can also use the CHANNEL button on the remote control to change channels.)

- 5 If a channel is labeled "In memory," use the CANCEL button to remove it from memory. If a channel is labeled "Not in memory," use the ENTER button to add it to memory.
- 6 When you are finished adding and deleting channels, press the HOME button to return to normal TV viewing.

Renaming the input

This feature allows you to rename the external input. For example, you might want to name the input “VCR” or “DISC.” The name you give the input will appear on the on-screen display.

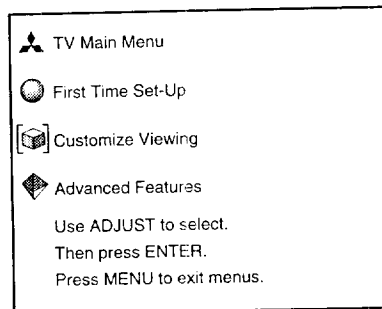

1 Press the MENU button on the remote control. The TV Main Menu will appear on the screen.

2 Select “Customize Viewing” using the ADJUST buttons; press ENTER.

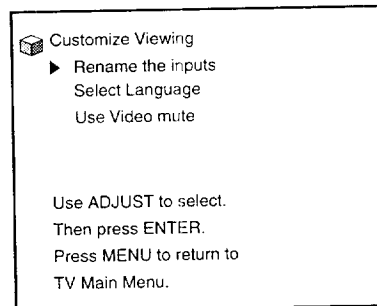

3 You will see the “Customize Viewing” screen. Select “Rename the input” using the ADJUST buttons; press ENTER.

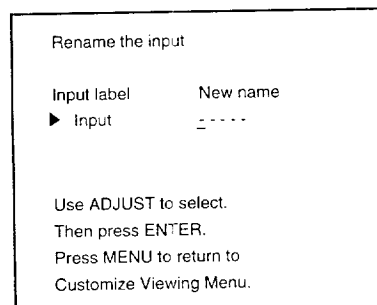

4 Set the new name using the ADJUST buttons and the ENTER button.

You can rename the inputs using letters (A–Z), numbers (0–9), or symbols (: / . , () ! " # \$ % & ' blank + ; < = > ? blank -).

When you press the CANCEL button while setting the name, the cursor will move one position to the left. You can clear the entire name by pressing CANCEL when the cursor is at the left-most position.

5 After you have finished naming the input, press the MENU button; the screen will return to the “Customize Viewing” menu.

Selecting the menu language

This TV allows you to display the on-screen menus in one of three languages: English, Spanish, or French.

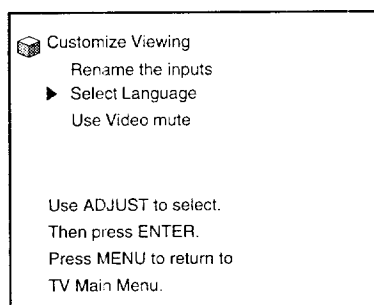

1 Press the MENU button on the remote control. The TV Main Menu will appear on the screen.

2 Select "Customize Viewing" using the ADJUST buttons; press ENTER.

3 Select "Select Language" using the ADJUST buttons; press ENTER.

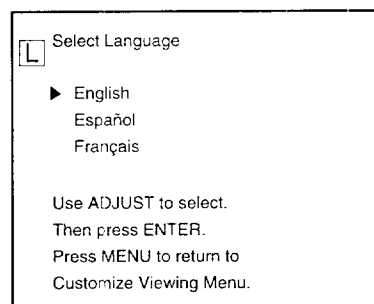

4 Use the ADJUST buttons to select the language you want.

5 Press the ENTER or MENU button to return to the "Customize Viewing" menu.

Using video mute

When you use the video mute function, your TV will display a blue screen whenever it is receiving a very weak TV signal or a weak signal from a VCR. If you want to try viewing a weak signal, you can turn the video mute off.

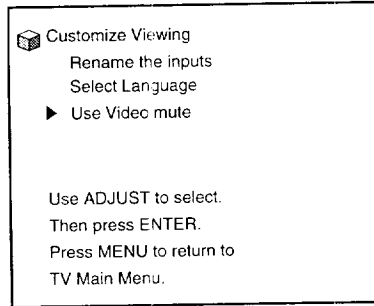

❶ Press the MENU button on the remote control. The TV Main Menu will appear on the screen.

❷ Select “Customize Viewing” using the ADJUST buttons; press ENTER.

❸ Select “Use Video mute” using the ADJUST buttons; press ENTER.

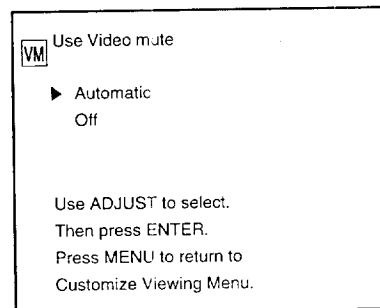

❹ Using the ADJUST buttons, select “Automatic” to turn video mute on or “Off” to turn video mute off.

❺ Press the ENTER or MENU button to return to the “Customize Viewing” menu.

Adjusting the sound

You can customize all of your TV's sound functions with a set of buttons; you select a function with the AUDIO button, then you adjust the function with the ADJUST buttons or right/left buttons. You use the ADJUST buttons to:

- select a position (e.g., stereo),
- increase or decrease the function (e.g., bass), or
- shift from one end of a scale to the other (e.g., balance).

After adjusting the sound, an on-screen display will indicate the function and level you've selected.

what you will adjust:

"Listen to: Stereo/SAP/Mono" allows you to change the audio reception mode to stereo, separate audio programming (S.A.P.), or monaural (mono), depending on the type of broadcast you are receiving. As you change this setting, remember the following:

- The "Stereo" setting allows you to receive both mono and stereo broadcasts.
- The separate audio programming ("S.A.P.") setting offers you the option of listening to a separate audio program. For example, a station may broadcast news, weather, or a foreign language soundtrack on the S.A.P. program.
- The "Mono" setting reduces unwanted background noise when the TV is receiving a weak stereo broadcast signal. When you use the "Mono" setting, you will hear the broadcast in monaural even when the broadcast signal is in stereo.

▷ **Important** An on-screen display appears when programs are broadcast in stereo or when separate audio programming (S.A.P.) is available.

"Bass" controls the volume of low frequency sound.

"Treble" controls the volume of high frequency sound.

"Balance" adjusts the level of sound between the left and right speakers.

"Surround: Off/Simulate/Hall" allows you to simulate or expand stereo sound.

- "Off" does not change the sound.
- "Simulate" gives you a pseudo-stereo effect when receiving monaural sound broadcasts.
- "Hall" makes stereo sound seem wider and extend around behind you.

“Speaker: On/Off” turns the TV speakers on or off. Set this function to “On” for normal operation. Set it to “Off” if you connected your TV to an audio system.

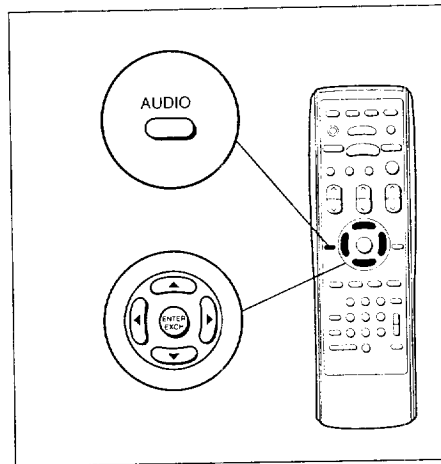

adjusting the audio functions

- 1 Use the AUDIO button on the remote control to select one of the functions.
- 2 Use the ADJUST (up/down) buttons or right/left buttons on the remote control to adjust the function.

Adjusting the picture

You can customize all of your TV's picture functions with a set of buttons: you select a function with the VIDEO button, then you can adjust the function with the ADJUST buttons or the right/left buttons. You use the ADJUST buttons to:

- shift from one end of a scale to the other (e.g., tint),
- increase or decrease the function (e.g., color),
- select a position (e.g., closed captioning).

After adjusting the picture, an on-screen display will indicate the function and level you've selected.

what you will adjust:

"Tint" adjusts the proportion of red to green that determines the delicate tones of color.

"Color" determines the intensity of the color.

"Contrast" controls the level of white-to-black in the picture.

"Brightness" controls the light level of the image on screen.

"Sharpness" adjusts the detail and clarity of the picture.

"Color temp(erature): Low/Middle/High" is used to change the relative warmth of the picture.

" CC" (closed captioning): 1/2/3/4/Text 1/Text 2/Text 3/Text 4/When muting/Off" is used to display text information on the TV screen. For details, please see "Using the closed caption decoder," on page 57.

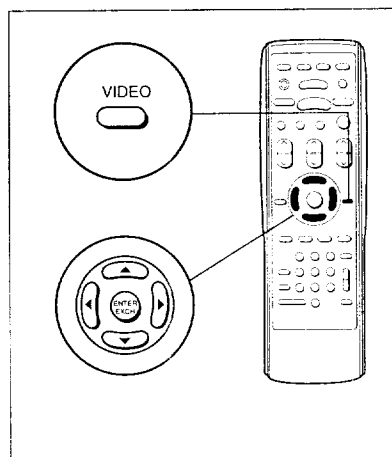

adjusting the video functions

- 1 Use the VIDEO button on the remote control to select one of the functions.
- 2 Use the ADJUST (up/down) button or right/left buttons on the remote control to adjust the function.

Using the closed caption decoder

Many broadcasters now supply closed captioning information along with their regular broadcasts. Your TV can decode that information and display it on your TV screen.

There are two types of captioning that broadcasters can send: “standard” and “text.” Standard captioning is related to the program that is being shown. Standard captioning usually follows the dialogue of the characters on-screen.

Text captioning does not usually relate to the program being shown. It often contains information such as weather or news. Text captioning often blocks out the program you are watching.

Your TV can decode four different “standard captioning” signals and four different “text captioning” signals on each TV channel. However, each station may be broadcasting only one or two captioning signals, or none at all.

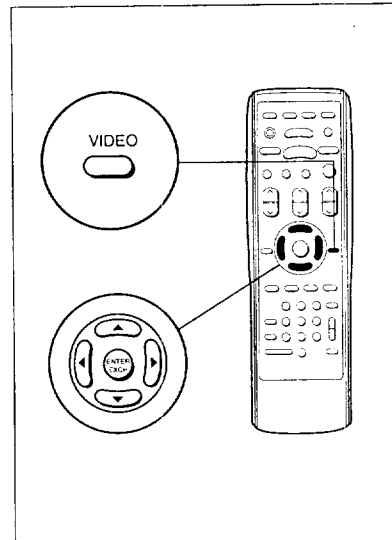

To use the closed caption decoder:

- 1 Repeatedly press the VIDEO button on the remote control until the closed captioning (CC) display appears on the screen.
- 2 Press the ADJUST buttons or right/left buttons on the remote control to select the captioning signal you wish to display:
CC 1/ CC 2/ CC 3/ CC 4/
CC Text 1/ CC Text 2/
CC Text 3/ CC Text 4/
CC When muting/ Off.

You can choose to display one of four “standard captioning” signals (indicated by the symbol CC and a number); to display one of four “text captioning” signals (indicated by the word “Text” and a number); to display captions when muting; or to turn the captions off.

If you select “When muting,” the standard captioning signal CC 1 will appear whenever you use the MUTE button.

Using the closed caption decoder (cont.)

uses for closed captioning

Closed captioning was initially designed so that those with hearing difficulties can enjoy viewing television more. However, closed captioning can also be used in other ways, such as:

- helping children learn to read,
- learning a foreign language, and
- using the television without disturbing others.

▷ **Important:** If you cannot display any captions on the screen, please keep in mind that not all broadcasters, video tapes, or laserdiscs supply closed caption signals.

Additionally, captions will not appear if you are playing a video tape that is worn or deteriorated, or if you are switching from STILL mode or SEARCH mode to PLAY mode on a Laser Disc player that cannot decode closed captioned signals when using these features.

◆ Using the Advanced Features

This section explains how to use some of the more advanced functions. You'll learn about:

- **Setting the timer,**
- **Using the parental lock,**
- **Using the Super Quick View tuning, and**
- **Selecting an advanced PIP function (CS-31305, CS-31309, and CK-31304 only).**

Setting the timer

This special feature allows you to program the TV to turn on automatically at a preset time. To set the timer:

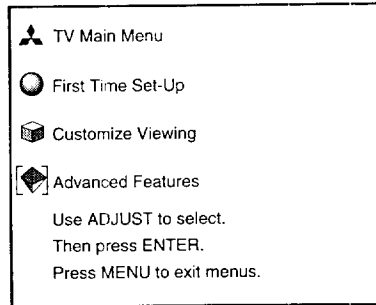

① Press the MENU button on the remote control. The TV Main Menu will appear on the screen.

② Select “Advanced Features” using the ADJUST buttons; press ENTER.

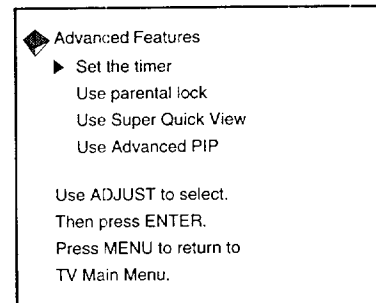

③ You will see the “Advanced Features” screen. Select “Set the timer” using the ADJUST buttons; press ENTER.

④ Use the ADJUST buttons and the ENTER button to set Day, Start time, and Channel.

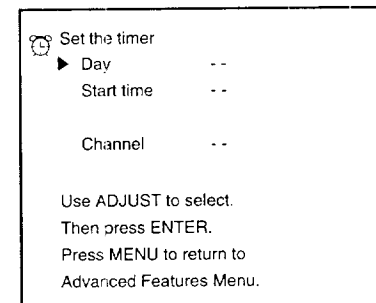

After setting the timer, make sure that the program timer indicator is lit. The indicator will light in orange when the TV is turned on and light in red when the TV is turned off. The indicator will light up in green when using the menus, or when you have locked the TV.

If you press the CANCEL button while setting the timer, the cursor will move to the previous item. To clear the timer, press the CANCEL button with the cursor at the “Day” position.

➤ **Important:** When the timer turns the TV on, the display will flash as a warning. If you do not press any TV function buttons for about 5 minutes, the TV will automatically turn off. Press a TV function button (such as the display button) to keep the TV on and turn off the flashing display.

Using the parental lock

This special feature allows you to lock the entire TV during a certain time period or lock up to ten individual channels. (You cannot lock the TV and lock individual channels at the same time.) When you turn on the lock, you enter a 4-digit secret code that will allow you to turn off the lock later.

If you try to turn on a locked TV or view a locked channel, you will see a message asking you to enter the secret code. If you don't enter the code within five minutes, the TV will turn off or tune to an unlocked channel.

If you enter the secret code, the message will disappear and the lock will be turned off temporarily. However, the TV or channels will be locked again after you turn off the TV. This will continue until you turn the lock off permanently. To turn the lock off permanently, follow the procedure later in this section.

using parental lock

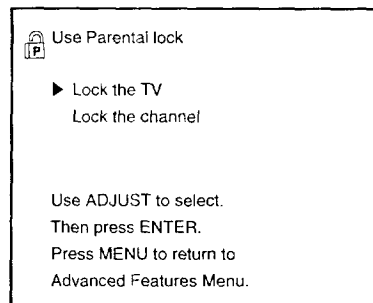
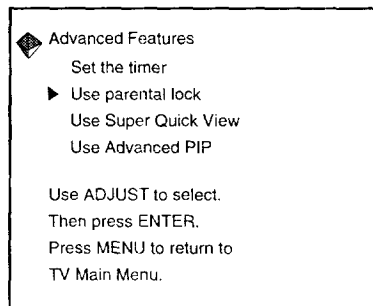

- 1 Press the MENU button. The TV Main Menu will appear.
- 2 Select "Advanced Features" using the ADJUST buttons; then, press ENTER.
- 3 Select "Use parental lock" using the ADJUST buttons; then, press ENTER.
- 4 Select "Lock the TV" or "Lock the channel" using the ADJUST buttons; then, press ENTER.

▶ **Important:** If you turn the parental lock on, you cannot use the timer.

Using the parental lock (cont.)

locking the TV

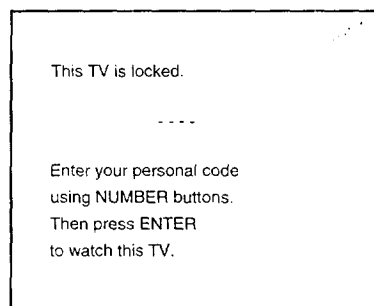
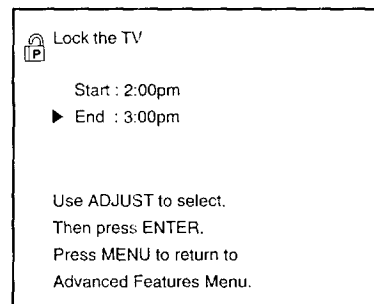
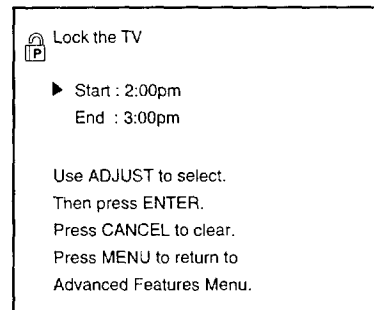
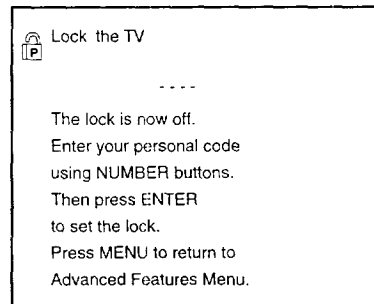

- The message for locking the TV will appear.
- Enter a four-digit secret code using the number buttons (0-9); then, press the ENTER button.
- Use the ADJUST buttons to select "Start"; press ENTER.
- Use the ADJUST buttons to set the time at which you want the TV lock to turn on. Press ENTER.
- Use the ADJUST buttons to set the time at which you want the TV lock to turn off. Press ENTER. If you want the TV lock to be in effect all the time, set the same "End" time as you set for the "Start" time.
- Press HOME to exit the menus.
- When you turn on a locked TV, you will be asked to enter your four-digit secret code. Enter the code to temporarily disable the lock. The lock will be enabled again when you turn the TV off.

▷**Important:** The TV lock will work if the clock has not been set.

locking channels

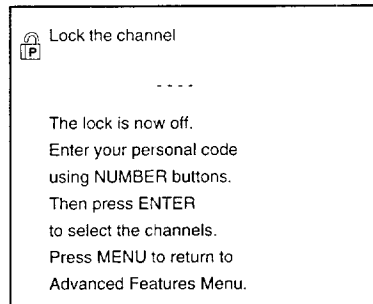

- The message for locking a channel will appear.
- Enter a four-digit secret code using the number buttons (0-9); press ENTER.

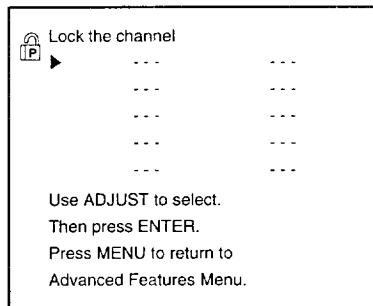

- You will see the channel lock set-up screen. Use the ADJUST buttons to select a position. Press ENTER.

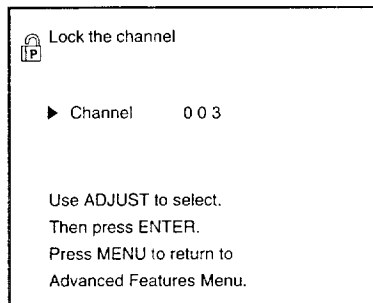

- Use the ADJUST button to choose the channel you want to lock. Press ENTER.
- Repeat the steps above to lock additional channels. When you are finished, press the HOME button to turn off the menus.

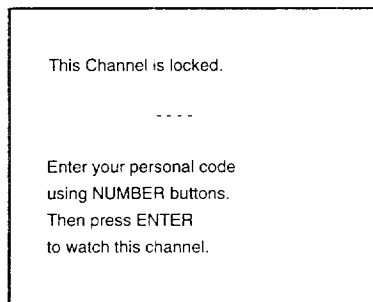

- When you try to view a locked channel, you will be asked to enter your four-digit secret code. Enter the code to temporarily disable the lock. The lock will be enabled again when you turn the TV off.

Using the parental lock (cont.)

canceling or changing parental lock

- 1 Press the MENU button. The TV Main Menu will appear on the screen.
- 2 Select “Advanced Features” using the ADJUST buttons; press ENTER.
- 3 Select “Use parental lock” using the ADJUST buttons; press ENTER.
- 4 Enter the four digits of your secret code using the number buttons (0-9); press ENTER.
- 5 If you were using the TV lock, press the CANCEL button to turn off the TV lock.
- 6 If you were using the channel lock, use the ADJUST button to place the cursor next to the channel whose lock you want to cancel. Press ENTER.
- 7 Press the CANCEL button to unlock that channel, or use the ADJUST buttons to change the channel to a new one.
- 8 Press the MENU button to return to the “Advanced Features” menu.

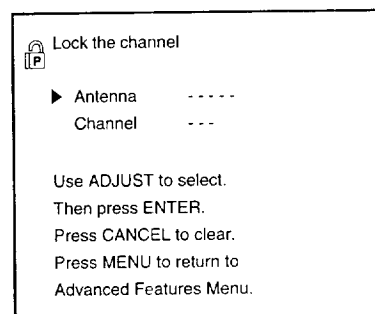
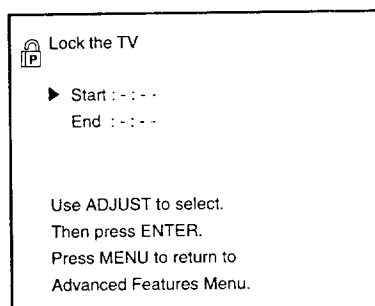
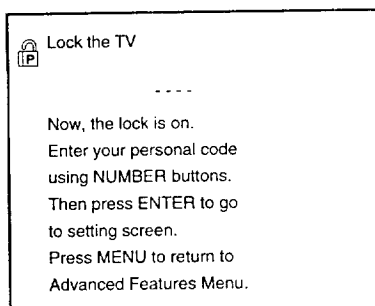

➤ **Important:** If you forget your four-digit secret code, please see page 85.

Using the Super Quick View tuning

Super-Quick-View allows you to cycle through a list of up to ten channels with the SQV button. You use the menus to add channels to the list or to remove channels from the list. You can also add channels to the list using only the remote control.

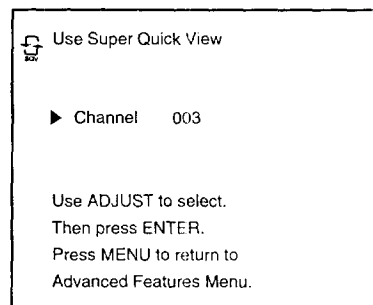
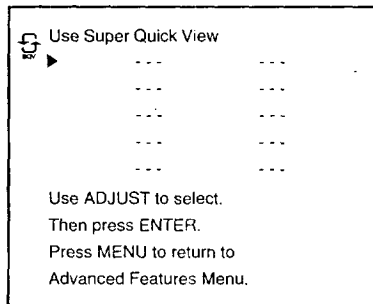
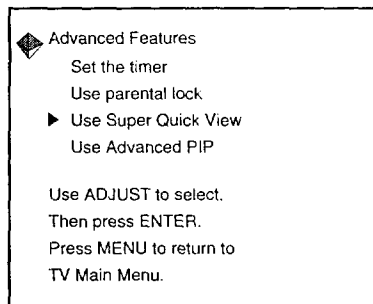

customizing the Super Quick View list with the menus

- 1 Press the MENU button on the remote control. The TV Main Menu will appear on the screen.
- 2 Select "Advanced Features" using the ADJUST buttons; press ENTER.
- 3 Select "Use Super Quick View" using the ADJUST buttons; then, press the ENTER button.
- 4 Use the ADJUST buttons to select a position in the list; press ENTER.
- 5 Use the ADJUST buttons, CHANNEL buttons or number buttons to add a channel to the list; press ENTER. You can clear a channel by pressing the CANCEL button. Repeat these steps to add channels to the Super Quick View memory.
- 6 Press the MENU button to exit this menu.

adding channels to the list with the remote control

- 1 Use the channel controls to tune the TV to the channel you want to add to the list.
- 2 Press and hold the SQV button for about 2 seconds. When you release the button, the letters "SQV" will appear under the channel number, indicating that the channel has been programmed into Super Quick View memory.

Selecting an advanced PIP function (CS-31305, CS-31309, and CK-31304 only)

When you are using the PIP features, there are special functions you can use. Before using these advanced functions, you need to choose one in the menu. These advanced functions are:

- TV Still,
- Snap-shot, or
- Replay.

In “TV Still,” the PIP image switches between still and moving. In “Snap-shot,” you can view and move several frozen PIP images. In “Replay,” you can view still PIP images in sequence for a “strobe” animation effect. These images will appear in sets of three (from a total of seven stored images) at the speed you select. (See “Using the Advanced Picture-in-Picture (PIP) Modes,” page 72.)

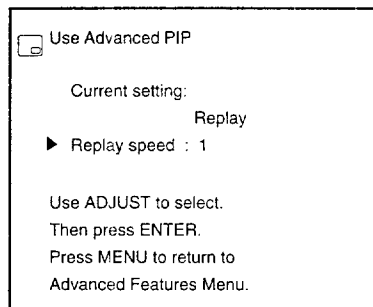
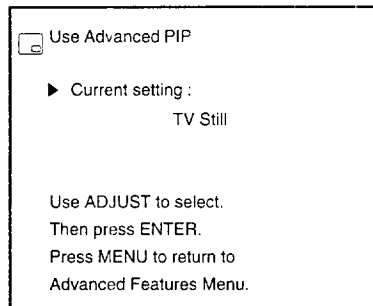
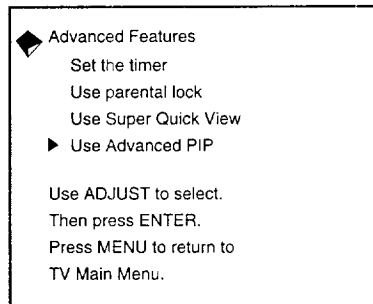

- 1 Press the MENU button on the remote control. The TV Main Menu will appear on the screen.
 - 2 Select “Advanced Features” using the ADJUST buttons; press ENTER.
 - 3 Select “Use Advanced PIP” using the ADJUST buttons; press ENTER.
 - 4 Use the ADJUST buttons to select the advanced feature you would like to use: TV Still, Snap-shot, or Replay. Press ENTER.
- When you select “Replay,” the next option will be “Replay speed.” Use the ADJUST buttons to set the replay speed from 1 to 9. (1=short interval and 9=long interval.) Press ENTER. (See “Using the Replay feature” on page 78 for more information.)
- 5 Press the MENU button to return to the “Advanced Features” menu.



CHAPTER FOUR
Using the Special Features

In addition to the basic and advanced features explained in the previous chapter, this TV offers the user several special features not generally available on other brand TVs. This chapter will explain how to use these distinctive features. It contains the following topics:

- ◆ **Understanding the On-Screen Displays**
- ◆ **Using the Off-Timer**
- ◆ **Using the Advanced Picture-in-Picture (PIP) Modes (CS-31305, CS-31309, and CK-31304 only)**

◆ Understanding the On-Screen Displays

Your TV provides an on-screen summary of the current settings for the TV, as well as the information related to Extended Data Services (XDS). XDS allows broadcasters to supply you with channel information, program information, and the current time. To view this information, press the display button (DISPLAY) on the remote control repeatedly. This section describes the displays in the order that they occur.

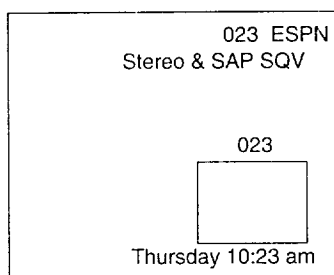

The first setting shows:

- channel number,
- the call letters for this channel,
- stereo and/or SAP are available for reception on this channel,
- this channel is programmed into Super Quick View memory,
- PIP input source (when a PIP image is showing),
- current day of the week, and
- time.

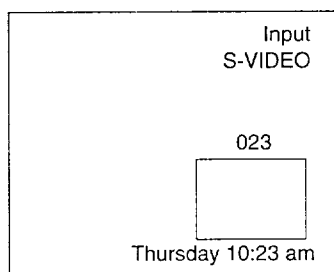

The second setting shows:

- the external input source (or input name),
- an S-Video cable has been connected,
- PIP input source (when a PIP image is showing),
- current day of the week, and
- time.

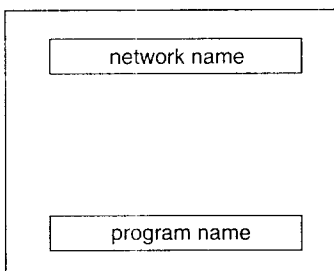

The third setting shows where the network name and program name will appear if a broadcaster is supplying information via XDS.

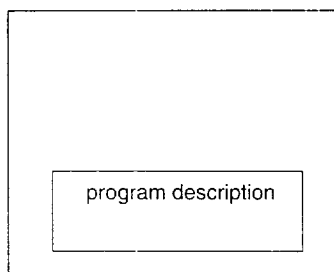

The fourth setting shows where the program description will appear if a broadcaster is supplying that information via XDS.

➤ **Important:** If the channel you are watching does not supply information via XDS, an error message will appear (“No name available,” “No description available”), and the “call letters” will not appear.

◆ Using the Off-Timer

This special function allows you to set the TV to turn off automatically. You can set the TV to turn off after a period of time ranging from 10 to 120 minutes in ten minute intervals. In this section you'll learn:

- **Setting the off-timer, and**
- **Changing or canceling the off-timer.**

Setting the off-timer

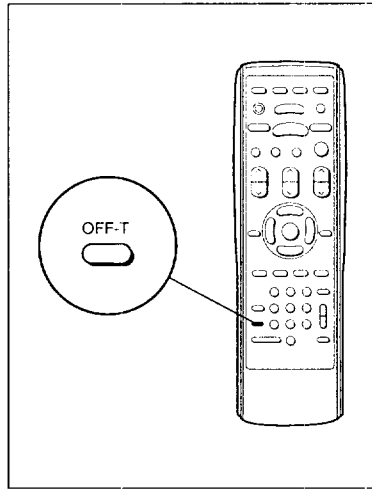

- 1 Press the off-timer button (OFF-T) on the remote control.

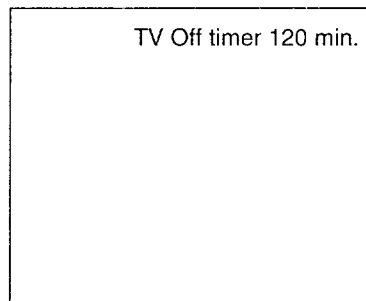

- 2 Select how long you want the TV to stay on by repeatedly pressing the off-timer button (OFF-T). The time will decrease in 10 minute intervals each time you press the button.

- 3 If you later want to check on how much time is left in the off-timer, press the off-timer button (OFF-T) once. The on-screen display reads "off-timer" and shows the amount of time remaining.

▷ **Important:** During the last minute before the TV is set to turn off, "Off-timer 1 min." will flash in red to remind you that the off-timer is set.

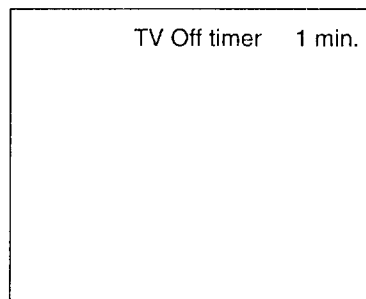

Changing or canceling the off-timer

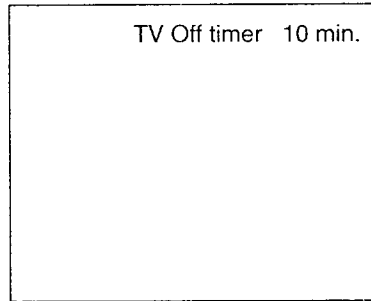

- ① Press the off-timer button (OFF-T) on the remote control. An on-screen display will indicate the amount of time remaining until the TV will turn off.
- ② Continue pressing the off-timer button (OFF-T) repeatedly to change the remaining time or cancel the off-timer. The off-timer is canceled when “— —” appears instead of the remaining time.

◆ Using the Advanced Picture-in-Picture (PIP) Modes (CS-31305, CS-31309, and CK-31304 only)

The special features of this TV include the advanced picture-in-picture (PIP) modes, which allow you to view and manipulate the images of two different sources at the same time. In this section you'll learn about:

- **Selecting the PIP image,**
- **Selecting the PIP source,**
- **Changing channels while using the PIP modes,**
- **Exchanging the PIP image and the main image,**
- **Moving the PIP image,**
- **Freezing the PIP image,**
- **Using the Snap-shot feature, and**
- **Using the Replay feature.**

▷ **Important:** You must have a VCR connected to the TV to see two different live pictures when using PIP.

Selecting the PIP image

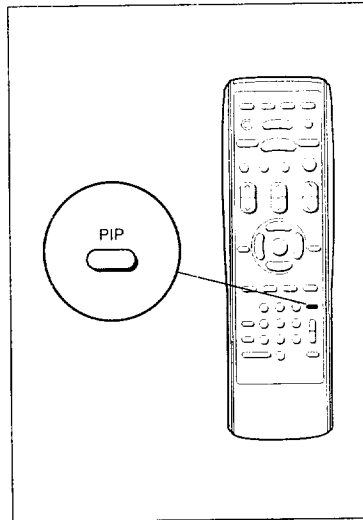

- 1 Select the number of the TV channel you want to view by using the channel control (CHANNEL).
- 2 Press the PIP button. A PIP image will appear in the bottom right corner of the screen.

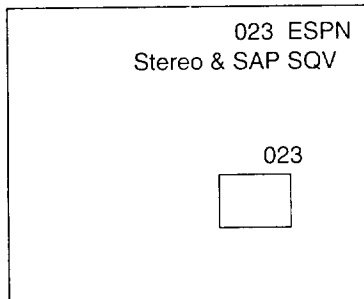
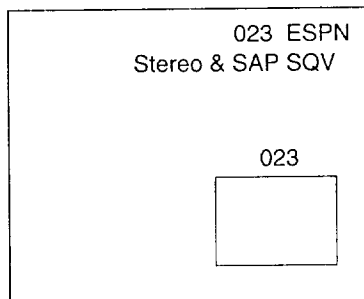

- 3 Press the PIP button again, within 10 seconds; the PIP image will change to a smaller size.

(If you wait longer than 10 seconds, the PIP image will disappear when you press the PIP button.)

- 4 Press the PIP button once again to cancel the PIP image.

- ▷ **Important:** When the main image is black and white, the PIP image will also appear in black and white.
- ▷ **Important:** If you move the PIP image and then turn it off, it will remain in its new position when you turn it on again.

Selecting the PIP source

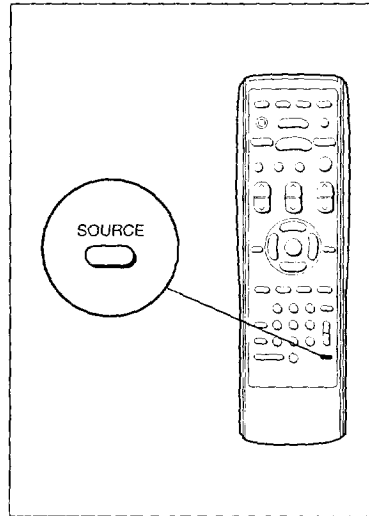

- 1 Turn your VCR on and select a channel on the VCR that is different than the channel you see on your TV screen.
- 2 Press the source button (SOURCE) on the remote control repeatedly to select the source of the PIP image: TV or Input.
- 3 The PIP image will change as follows.

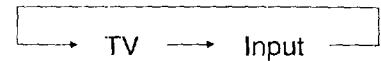

▷ **Important:** To change the input of the background (main) image while a PIP image is on the screen, press the input button (INPUT) on the control panel or on the remote control.

Changing channels while using the PIP modes

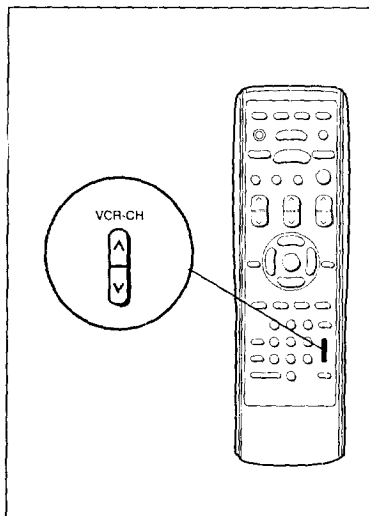

You can use the buttons on the remote control to change the channels of both the main image and the small PIP image, as if your TV had two-tuners.

To do this:

- 1 Point the remote at the VCR and press the VCR channel button (VCR-CH) on the remote control to change the channel of the PIP image.
- 2 Press the CHANNEL button on the remote control to change the channel of the main image.

▷ **Important:** When the source of both the main image and the PIP image is the TV, the VCR channel (VCR-CH) button will not change the channels of the main image or the PIP image.

▷ **Important:** You must have set up the "VCR-A" layer of your remote for this button to work correctly. (See pages 37–40.)

Exchanging the PIP image and the main image

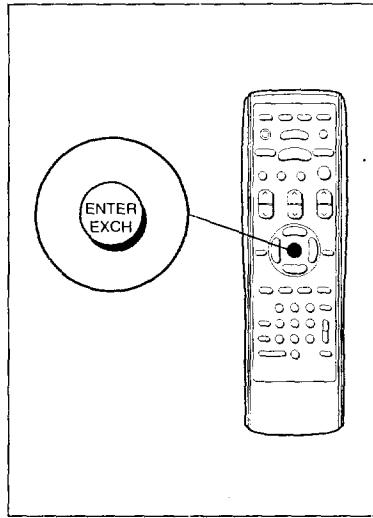

Press the ENTER button to exchange the contents of the main (background) image and the PIP image.

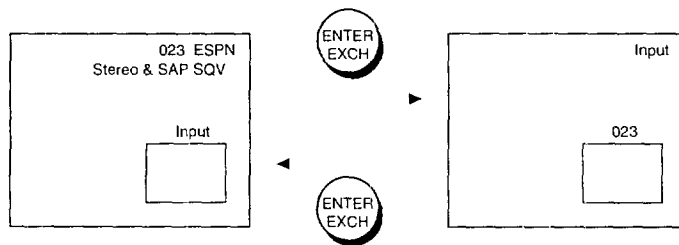

Moving the PIP image

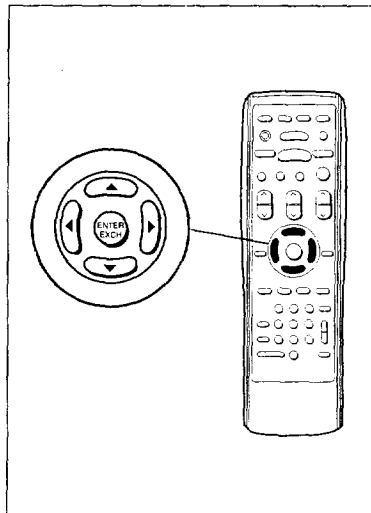

Press the ADJUST (up/down) buttons or right/left buttons to move the PIP image.

➤ **Important:** If you move the PIP image and then turn it off, it will remain in its new position when you turn it on again.

Freezing the PIP image

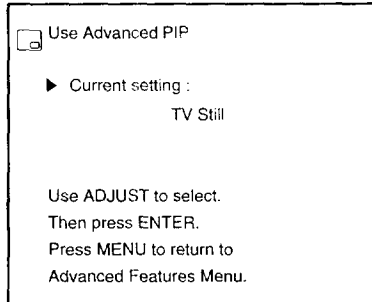

- 1 Select "Use Advanced PIP" in the "Advanced Features" menu and set it to "TV Still." (See "Selecting an advanced PIP function," page 66.)
- 2 Use the MENU button to return to the normal picture.

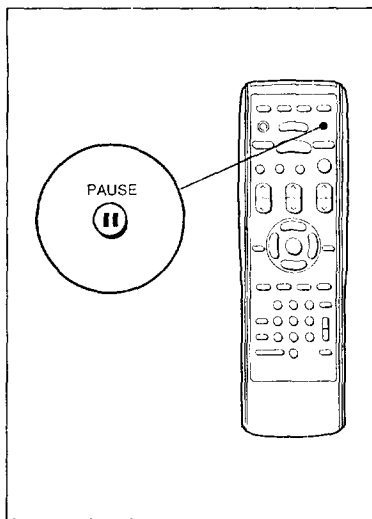

- 3 Press the PAUSE button to freeze the PIP image on the screen.
- 4 Press PAUSE again to return the PIP image to a "live" picture.

▷ **Important:** When you press the pause button while viewing the normal picture, the PIP image will appear and be frozen.

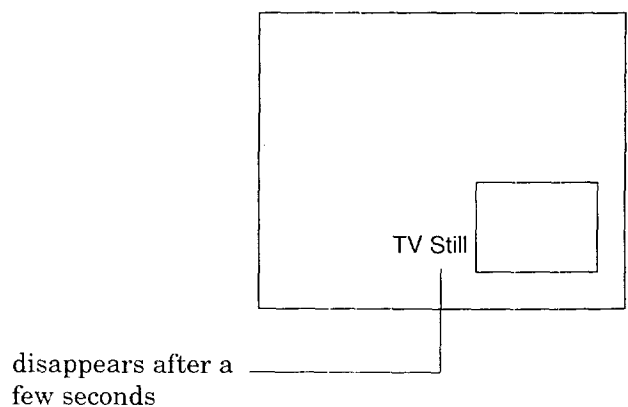

Using the Snap-shot feature

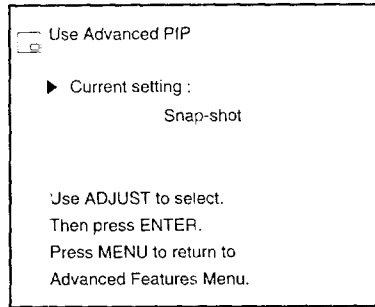

1 Select "Use Advanced PIP" in the "Advanced Features" menu and set it to "Snap-shot." (See "Selecting an advanced PIP function," page 66.)

2 Use the MENU button to return to the normal picture.

3 Press the PAUSE button once; a frozen PIP image and a moving PIP image will appear.

4 Press the PAUSE button again; a third PIP image will appear, moving. The previous two PIP images will be frozen.

5 Each time you press the PAUSE button, the PIP images will shift upwards one by one: the top image will be replaced by the second image, the second image will be replaced by the third, and a new moving image will appear in the third space.

6 To cancel the PIP image, press the PIP button twice.

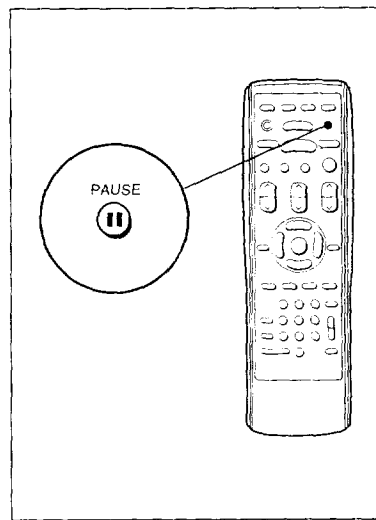

if the PIP image is off

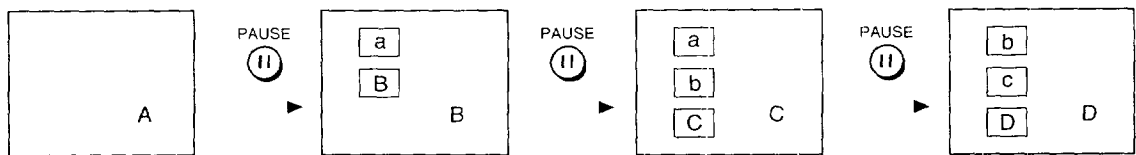

if the PIP image is on

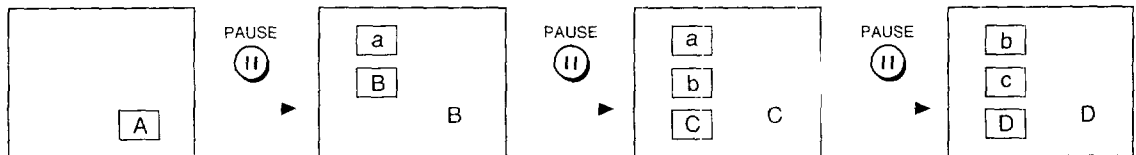

*A, B, C, D: the moving images

*a, b, c, d: the frozen images of A, B, C, and D at the instant the PAUSE button is pressed.

Using the Replay feature

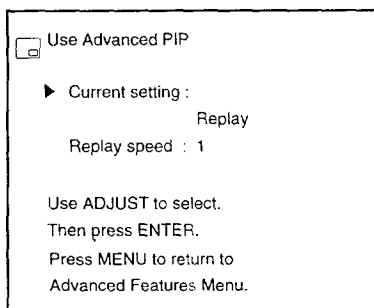

1 Select "Use Advanced PIP" in the "Advanced Features" menu and set it to "Replay." (See "Selecting an advanced PIP function," page 66.)

2 Set the replay speed between 1 (short interval) and 9 (long interval).

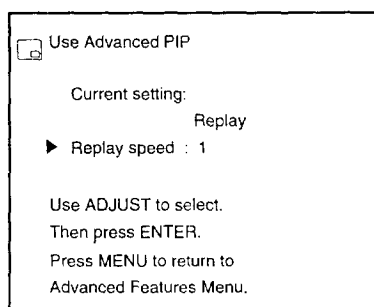

3 Use the MENU button to return to the normal picture.

4 Press the PAUSE button. The TV will memorize seven frames of video from the main image and display the first three of these frames as PIP images. (The interval between the frames is determined by the replay speed set in step 2.)

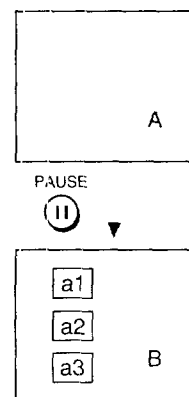
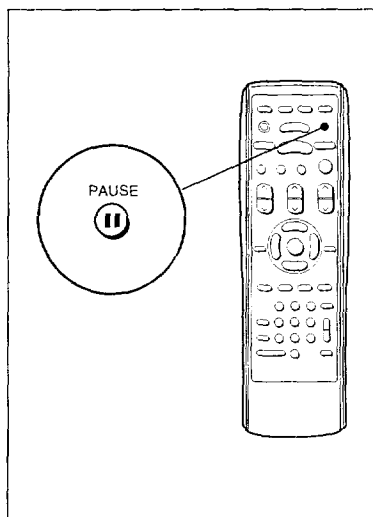

5 Each time you press the PAUSE button, the memorized frames will shift upwards.

6 To cancel the PIP images, press the PIP button twice.

*a1 - a7 : memorized frames

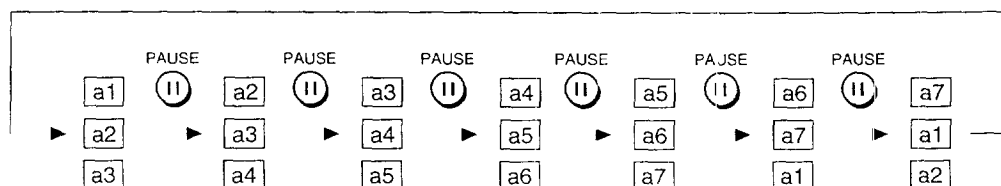



CHAPTER FIVE
Troubleshooting

Even though you're now familiar with the basic and advanced operations of the TV, you may run into trouble from time to time as you become accustomed to the TV. This chapter offers solutions to some of the common problems you may encounter. We suggest that you consult this chart before contacting a Mitsubishi service representative.

Troubleshooting (cont.)

| Problems | Possible Solutions | For More Information |
|---|---|--|
| <ul style="list-style-type: none">• The remote control doesn't work. | <ul style="list-style-type: none">• Check that the batteries are installed correctly.• Check that the select button is set to "TV."• Be sure that you are pointing the top of the remote control toward the TV from a distance of no more than 20 feet. | <ul style="list-style-type: none">• See "Getting ready to use the remote control" in Chapter 1 for an explanation of how to install batteries in the remote control.• See "Remote control buttons and functions" in Chapter 1, which explains where the select buttons are located.• See "Getting ready to use the remote control" in Chapter 1, which contains pointers for using the remote control. |
| <hr/> | | |
| <ul style="list-style-type: none">• The TV takes several seconds to respond to button commands. | <ul style="list-style-type: none">• Use the ENTER button to avoid delays. | <ul style="list-style-type: none">• See "Changing channels" in Chapter 3, which explains the function of the ENTER button. |
| <hr/> | | |
| <ul style="list-style-type: none">• You can't access a channel. | <ul style="list-style-type: none">• Be sure that the channel you want to view is programmed into memory.• Check that the TV is tuned to the correct input source (antenna) for that channel. | <ul style="list-style-type: none">• See "Memorizing channels" in Chapter 3, which explains how to program channels into the TV's memory.• See "Selecting the input source" in Chapter 3, which explains how to change the input source. |

| Problems | Possible Solutions | For More Information |
|--|--|---|
| <ul style="list-style-type: none"> On-screen displays appear each time you adjust a function. | <ul style="list-style-type: none"> This is part of the normal operation of the TV. | <ul style="list-style-type: none"> See “Understanding the On-Screen Displays” in Chapter 4 for a full explanation of the on-screen displays. |
| <ul style="list-style-type: none"> There’s no sound even when the volume is turned up. | <ul style="list-style-type: none"> Check that the MUTE button isn’t on. The TV’s reception mode may be set to “separate audio program” (S.A.P.). | <ul style="list-style-type: none"> See “Remote control buttons and functions” in Chapter 1, which explains the location and function of the MUTE button. See “Adjusting the sound” in Chapter 3, which explains how to select the appropriate reception mode. |
| <ul style="list-style-type: none"> You forget the code you used to set the parental lock. | <ul style="list-style-type: none"> Use the alternate procedure that doesn’t require the use of the code. | <ul style="list-style-type: none"> See the Appendix, “Procedure for Bypassing the Parental Lock.” |
| <ul style="list-style-type: none"> You can’t program the TV to turn on automatically. | <ul style="list-style-type: none"> The TV may be locked. | <ul style="list-style-type: none"> See “Using the parental lock” under “Using the Advanced Features” in Chapter 3. |
| <ul style="list-style-type: none"> The sound doesn’t match the image on screen. | <ul style="list-style-type: none"> The TV’s reception mode may be set to “separate audio program” (S.A.P.). | <ul style="list-style-type: none"> See “Adjusting the sound” in Chapter 3, which explains how to select the appropriate reception mode. |
| <ul style="list-style-type: none"> There is a large black rectangle on the screen. | <ul style="list-style-type: none"> The TV has been set to “text” mode, but there is no text information being broadcast. | <ul style="list-style-type: none"> See “Using the closed caption decoder” under “Getting started” in chapter 3. |

Caution and care

► **Warning:** Don't leave stationary images, such as those generated from stock market reports or video games, on-screen for more than 10 minutes. Still patterns can scar the TV causing permanent damage to the picture tubes.

▷ **Important:** If you plan to place speakers next to the TV, make sure they are magnetically shielded. Ordinary speakers will cause distortion in the picture due to their strong magnets. This distortion, however, will not harm the picture tubes.

For maximum enjoyment and safe operation of your MITSUBISHI Color TV, please read the "IMPORTANT SAFEGUARDS" carefully and apply them properly.

▷ **Important:** To keep your TV from toppling in the event of an earthquake, you can use the clamp attached to the back of the television to secure it to the wall. Simply run a cord or rope through the clamp, then attach the rope to the wall directly behind the television.

▷ **Important:** Make sure your fingers are out of the way before closing the glass doors of this unit (CK-31304 only).

Calling for service

If you are unable to correct a problem with your TV, consult your MITSUBISHI dealer or MITSUBISHI Authorized Warranty Service Center.

Do not adjust any controls not described in this owner's guide.

Do not remove the protective back cover of this unit.

If you see one of the following display on your screen, you should not change any settings. These are special displays used by the factory.

```
▶ Initial
Hotel      : Off
Power res  : Off
Ant        : 1
Input      : 1
When mute  : On
```

```
▶ Initial      3 dia      : On
E2RESET       CCD        : On
Hotel         : Off      Auto clock : On
Power res     : Off      System1A  : Off
Ant           : 1        PIP         : On(or Off)
Input         : 1        Mntr. fix  : Off
When mute     : On
```

```
VCH
0 0 COL 63
```

If one of these displays appears, make sure that all of the on/off settings are the same as the illustrations above and then turn the TV off. If any of the settings are different from the illustration above, turn the TV off and consult your MITSUBISHI dealer or MITSUBISHI Authorized Warranty Service Center.



Cut along dotted line and file after reading.

After you lock the TV, you will need the secret code in order to:

- view the locked TV, or
- cancel the lock.

If you forget the code, you can view the locked TV without entering the code. To do this, simply press the buttons on your remote labeled “QV” and “9” at the same time.

▷**Important:** Unlocking with this procedure is only temporary. To cancel the lock completely, follow the procedure below:

- ➊ Press the “QV” button and the “9” button on the remote control at the same time. This will unlock the TV.
- ➋ Press the MENU button to view the main menu. Use the ADJUST button to select “Advanced Features.” Press ENTER.
- ➌ Use the ADJUST button to select “Use Parental Lock.”
- ➍ Use the ADJUST button to choose the lock you want to turn off. If the TV is locked, select “Lock the TV”, OR:
If the channel was locked, select “Lock the Channel”.
- ➎ If you selected “Lock the TV”, you must press the CANCEL button to clear both the start and the end time. Then press HOME to return to viewing the TV, OR: If you selected “Lock the Channel”, you must press the ADJUST, ENTER and CANCEL buttons to clear every channel from the screen. Then press HOME to return to viewing the TV.

A

- A/V reset button 13
- adding channels 50
- adjust buttons 18, 19
- advanced features 59
- advanced PIP 66
- antenna
 - connecting 25, 27
 - terminal 22
- audio
 - adjusting 54
 - button 18
 - input 23
 - output 22
 - system, connecting 34
- auto clock 47

B

- back panel 22
- balance 54
- bass 54
- batteries 14
- brightness 56

C

- cable
 - connecting 25, 26, 28, 31
- cable box
 - codes 39
 - connecting 26, 31
- cancel button 18
- care 82
- CC 56, 57
- channel
 - adding/deleting 50
 - changing 43
 - changing PIP 74
 - control 13, 17
 - lock 63
 - memorizing 49
 - programming 49
- clock, setting 47
- closed captions 56, 57
- color 56
- color temperature 56

connecting

- antenna 25, 27
 - audio system 34
 - cable 25, 26, 28, 31
 - decoder box 26, 31
 - TV 21
 - VCR 28, 31
- contrast 56
- control panel, overview 12

D

- decoder box
 - codes 39
 - connecting 26, 31
- degauss button 13
- deleting channels 50
- display button 19
- displays 68

E

- enter button 17, 19
- español 52
- exchange button 17, 19
- exchanging, PIP image 75

F

- features
 - advanced 59
 - special 6, 67
- français 52
- freezing PIP 76
- front panel 12

H

- home button 19

I

- important safeguards 3
- input button 13, 17
- input
 - audio/video 23
 - renaming 51
 - selecting 42
- installing batteries 14

L

- language, selecting 52
- lock
 - bypassing 85
 - channel 63
 - TV 62

M

- memorizing channels 49
- menu button 18
- menu language, selecting ... 52
- menus, understanding 46
- mono 54
- moving the PIP image 75
- mute control 17
- mute, video 53

N

- number buttons 19

O

- off-timer 68
- off-timer button 19
- on-screen displays 68
- on/off, turning your TV 41
- outputs, audio/video 22
- overview
 - back panel 22
 - control panel 12
 - remote control 14

P

- parental lock 61
- pause button 19
- picture, adjusting 56
- PIP (Picture-in-picture) 72
 - advanced functions 66
 - button 19
 - channel 74
 - exchanging images 75
 - freezing 76
 - moving 75
 - replay 78
 - selecting 73
 - snap-shot 77
 - source 74

| | | | |
|-------------------------------|--------|------------------------------|--------|
| power button | 13, 17 | T | |
| program timer indicator | 13 | text | 57 |
| programming channels | 49 | time, setting | 47 |
| | | timer | 60 |
| Q | | timer indicator | 13 |
| quick view | 45 | timer, off | 69 |
| quick view button | 17 | tint | 56 |
| | | treble | 54 |
| R | | troubleshooting | 79 |
| rear panel | 22 | turning your TV on/off | 41 |
| remote control | | TV lock | 61 |
| buttons | 16 | TV, connecting | 21 |
| overview | 14 | TV, unpacking | 7 |
| using | 37 | | |
| renaming the input | 51 | U | |
| replay | 78 | unpacking your TV | 7 |
| reset, A/V | 13 | | |
| | | V | |
| S | | VCR | |
| s-video input | 23 | buttons | 17 |
| S.A.P | 54 | codes | 38 |
| safeguards, important | 3 | connecting | 28, 31 |
| select buttons | 17 | VCR-CH button | 19 |
| service | 83 | video | |
| setting the clock | 47 | adjusting | 56 |
| sharpness | 56 | button | 18 |
| snap-shot | 77 | input | 23 |
| sound, adjusting | 54 | mute | 53 |
| source button | 19 | output | 22 |
| source, PIP | 74 | volume control | 13, 17 |
| special features | 6, 67 | | |
| SQV button | 17 | W | |
| stereo | 54 | wake-up timer | 60 |
| super quick view | 45, 65 | | |
| super quick view button | 17 | X | |
| surround | 54 | XDS | 68 |

**mitsubishi color television or color monitor
limited warranty**

MITSUBISHI ELECTRONICS AMERICA, INC. ("MELA") warrants to the original purchaser of this television or monitor if purchased from an authorized MITSUBISHI Audio/Video Dealer that, should it prove defective by reason of improper workmanship and/or material:

- a. **Picture Tube.** For two years from the date of purchase at retail, we will repair or replace, at our option, any defective picture tube without charge for the tube.
- b. **Other Parts.** For one year from the date of original purchase at retail, we will repair or replace, at our option, any defective part without charge for the part.
- c. All parts used for replacement are warranted for the remainder of the original warranty period.
- d. **Labor.** For one year from the date of original purchase at retail, we will provide the labor for a warranty repair by an authorized MITSUBISHI service center without charge.
- e. **Notice.** To obtain warranty service, you must notify an authorized MITSUBISHI service center of any defect within the applicable warranty time period.

1. TO OBTAIN WARRANTY SERVICE DURING THE FIRST YEAR:

a. Contact your nearest authorized MITSUBISHI service center, whose name and address can be obtained from your MITSUBISHI dealer or by writing or calling MELA at the address and telephone number provided below.

b. Warranty service will be provided in your home or, if required, at an authorized service shop, provided that your television is located within the geographic territory customarily covered by an authorized MITSUBISHI service center. If not, you must either deliver your television to an authorized service location at your own expense, or pay for any travel and/or transportation costs the service center may charge to and from your home. Actual service labor will be provided without charge.

c. Proof of purchase date from an authorized MITSUBISHI Dealer is required when requesting warranty service. Present your sales receipt or other document which establishes proof and date of purchase. **THE RETURN OF THE OWNER REGISTRATION CARD IS NOT A CONDITION OF WARRANTY COVERAGE.** However, please return the Owner Registration Card so that we can contact you should a question of safety arise which could affect you.

2. AFTER THE FIRST YEAR, to obtain warranty service for a defective picture tube, you are responsible for delivering the television or monitor to an authorized MITSUBISHI service center at your own expense.

3. THIS WARRANTY DOES NOT COVER damage caused by: modification, alteration, repair or service of this product by anyone other than an authorized MITSUBISHI service center; physical abuse to, or misuse of, the product; operation in a manner contrary to the instructions which accompany the product; freight damage; or any damage caused by acts of God such as lightning or fluctuation in electrical power. This warranty also excludes all costs arising from installation, adjustment of user controls, external antenna systems, service of products purchased or serviced outside the U.S.A., initial technical adjustments (set-up) and user-required maintenance. Consult the operating instructions furnished with the product for information regarding user controls.

4. ANY EXPRESS WARRANTY NOT PROVIDED HEREIN, AND ANY REMEDY WHICH, BUT FOR THIS PROVISION, MIGHT ARISE BY IMPLICATION OR OPERATION OF LAW, IS HEREBY EXCLUDED AND DISCLAIMED. THE IMPLIED WARRANTIES OF MERCHANTABILITY AND OF FITNESS FOR ANY PARTICULAR PURPOSE ARE EXPRESSLY LIMITED TO A TERM OF ONE YEAR.

5. UNDER NO CIRCUMSTANCES SHALL MELA BE LIABLE TO PURCHASER OR ANY OTHER PERSON FOR ANY INCIDENTAL, SPECIAL OR CONSEQUENTIAL DAMAGES, WHETHER ARISING OUT OF BREACH OF WARRANTY, BREACH OF CONTRACT, OR OTHERWISE.

6. Some states do not allow limitations on how long an implied warranty lasts, or the exclusion or limitation of incidental, special, or consequential damages, so the above limitations or exclusions may not apply to you.

7. This warranty gives you specific legal rights and you may also have other rights which vary from state to state.

8. BEFORE REQUESTING SERVICE, please review the instruction booklet to insure proper installation and correct customer control adjustment. If the problem persists, contact your nearest MITSUBISHI Dealer for name(s) of authorized MITSUBISHI Service Center(s). If you are unable to obtain this information, please call 1-800-332-2119, or write us at the address below.

MITSUBISHI ELECTRONICS AMERICA, INC.

P.O. Box 5025

Norcross, GA 30091-5025



RETAIN THIS PORTION FOR YOUR RECORDS

SERIAL NO. _____

CUSTOMER NAME _____

STREET ADDRESS _____

CITY _____ STATE _____ ZIP _____

PHONE () _____ PURCHASE DATE _____ / _____ / _____
MO DAY YR

PLACE OF PURCHASE _____



MITSUBISHI ELECTRONICS AMERICA, INC.
6100 Atlantic Boulevard
Norcross, GA 30071-1305

© 1995 Mitsubishi Electronics America, Inc.

871C907C8

Printed in U.S.A