



MITSUBISHI

CS-13103

CS-13103C

CS-20103M

CS-20203C

CS-13104

CS-20103

CS-20203

Television

Owner's

Guide

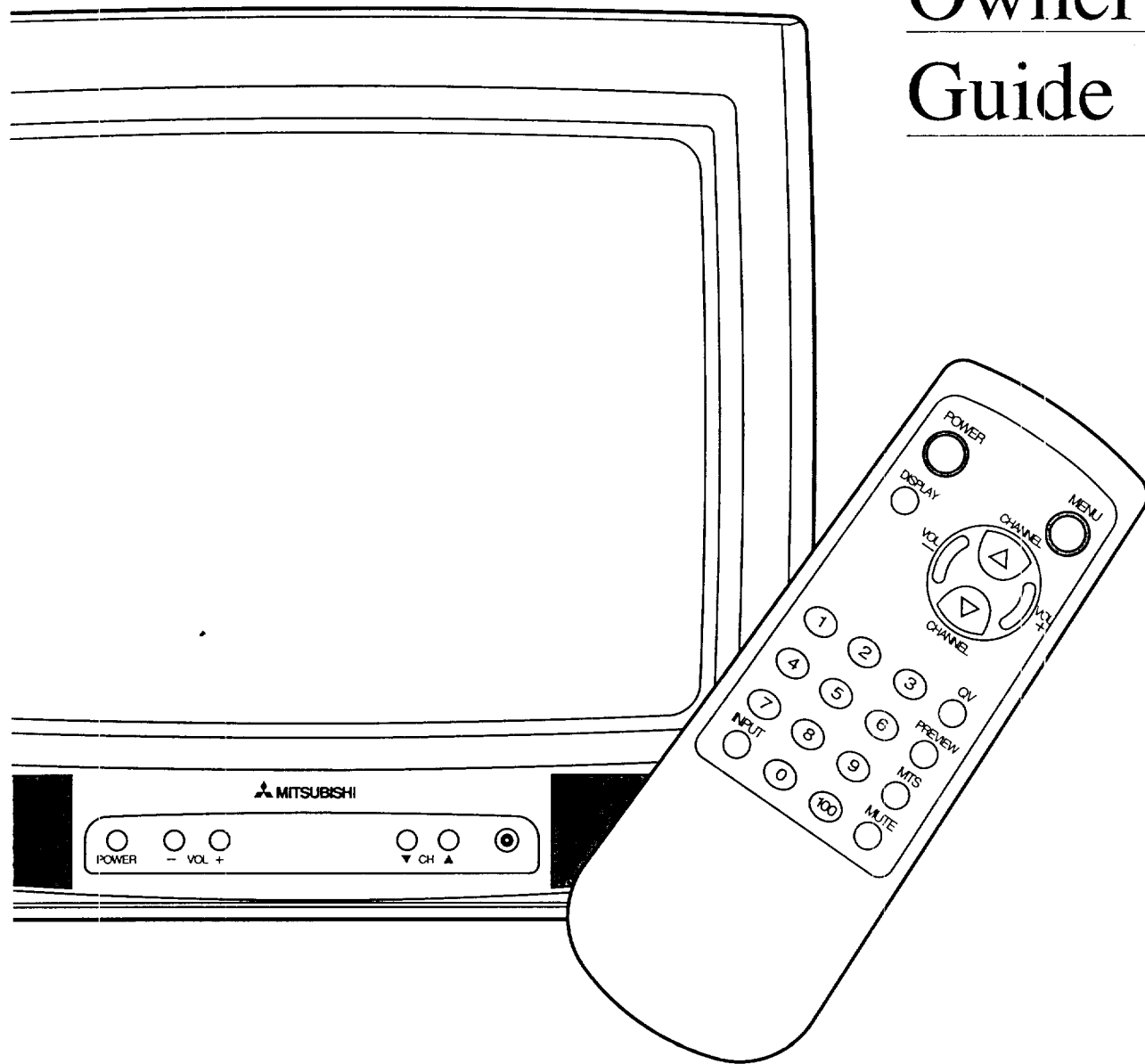

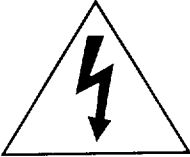
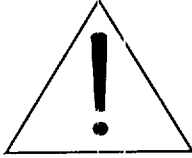
	CAUTION RISK OF ELECTRIC SHOCK DO NOT OPEN	
<p>CAUTION: TO REDUCE THE RISK OF ELECTRIC SHOCK, DO NOT REMOVE COVER (OR BACK). NO USER-SERVICEABLE PARTS INSIDE. REFER SERVICING TO QUALIFIED SERVICE PERSONNEL.</p>		

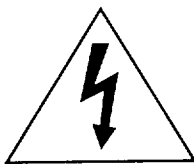

The lightning flash with arrowhead symbol, within an equilateral triangle, is intended to alert the user to the presence of uninsulated "dangerous voltage" within the product's enclosure that may be of sufficient magnitude to constitute a risk of electric shock.



The exclamation point within an equilateral triangle is intended to alert the user to the presence of important operating and maintenance (servicing) instructions in the literature accompanying the appliance.

WARNING:

TO REDUCE THE RISK OF FIRE OR ELECTRIC SHOCK, DO NOT EXPOSE THIS APPLIANCE TO WET LOCATIONS.

CAUTION:

TO PREVENT ELECTRIC SHOCK HAZARD, DO NOT USE THIS UNIT'S (POLARIZED) PLUG WITH AN EXTENSION CORD, RECEPTACLE OR OTHER OUTLET UNLESS THE BLADES CAN BE FULLY INSERTED TO PREVENT BLADE EXPOSURE.

NOTE TO CATV SYSTEM INSTALLER:

THIS REMINDER IS PROVIDED TO CALL THE CATV SYSTEM INSTALLER'S ATTENTION TO ARTICLE 820-40 OF THE NEC THAT PROVIDES GUIDELINES FOR PROPER GROUNDING AND, IN PARTICULAR, SPECIFIES THAT THE CABLE GROUND SHALL BE CONNECTED TO THE GROUNDING SYSTEM OF THE BUILDING, AS CLOSE TO THE POINT OF CABLE ENTRY AS PRACTICAL.

IMPORTANT SAFEGUARDS

PLEASE READ ALL THESE INSTRUCTIONS REGARDING YOUR TV RECEIVER AND RETAIN FOR FUTURE REFERENCE. FOLLOW ALL WARNINGS AND INSTRUCTIONS MARKED ON THE TV RECEIVER.

- 1. Read Instructions**
All the safety and operating instructions should be read before the appliance is operated.
- 2. Retain Instructions**
The safety and operating instructions should be retained for future reference.
- 3. Heed Warnings**
All warnings on the appliance and in the operating instructions should be adhered to.
- 4. Follow instructions**
All operating and use instructions should be followed.
- 5. Cleaning**
Unplug this TV receiver from the wall outlet before cleaning. Use a damp cloth for cleaning.
- 6. Attachments**
Do not use attachments not recommended by the TV receiver manufacturer as they may cause hazards.
- 7. Water and Moisture**
Do not use this TV receiver near water — for example, near a bath tub, wash bowl, kitchen sink, or laundry tub, in a wet basement, or near a swimming pool, and the like.
- 8. Accessories**
Do not place this TV receiver on an unstable cart, stand, tripod, bracket, or table. The TV receiver may fall, causing serious injury to a child or adult, and serious damage to the appliance. Use only with a cart, stand, tripod, bracket, or table recommended by the manufacturer, or sold with the TV receiver. Any mounting of the appliance should follow the manufacturer's instructions, and should use a mounting accessory recommended by the manufacturer.



An appliance and cart combination should be moved with care. Quick stops, excessive force, and uneven surfaces may cause the appliance and cart combination to overturn.

9. Ventilation

Slots and openings in the cabinet are provided for ventilation and to ensure reliable operation of the TV receiver and to protect it from overheating, and these openings must not be blocked or covered. The openings should never be blocked by placing the TV receiver on a bed, sofa, rug, or other similar surface. This TV receiver should never be placed near or over a radiator or heat register. This TV receiver should not be placed in a built-in installation such as a bookcase or rack unless proper ventilation is provided or the manufacturer's instructions have been adhered to.

10. Power Sources

This TV receiver should be operated only from the type of power source indicated on the marking label. If you are not sure of the type of power supply to your home, consult your appliance dealer or local power company. For TV receivers intended to operate from battery power, or other sources, refer to the operating instructions.

11. Grounding or Polarization

This TV receiver is equipped with a polarized alternating-current line plug (a plug having one blade wider than the other). This plug will fit into the power outlet only one way. This is a safety feature. If you are unable to insert the plug fully into the outlet, try reversing the plug. If the plug should still fail to fit, contact your electrician to replace your obsolete outlet. Do not defeat the safety purpose of the polarized plug.

12. Power-Cord Protection

Power-supply cords should be routed so that they are not likely to be walked on or pinched by items placed upon or against them, paying particular attention to cords at plugs, convenience receptacles, and the point where they exit from the appliance.

13. Lightning

For added protection for this TV receiver during a lightning storm, or when it is left unattended and unused for long periods of time, unplug it from the wall outlet and disconnect the antenna or cable system. This will prevent damage to the TV receiver due to lightning and power-line surges.

14. Power Lines

An outside antenna system should not be located in the vicinity of overhead power lines or other electric light or power circuits, or where it can fall into such power lines or circuits. When installing an outside antenna system, extreme care should be taken to keep from touching such power lines or circuits as contact with them might be fatal.

15. Overloading

Do not overload wall outlets and extension cords as this can result in a risk of fire or electric shock.

16. Object and Liquid Entry

Never push objects of any kind into this TV receiver through openings as they may touch dangerous voltage points or short-out parts that could result in a fire or electric shock. Never spill liquid of any kind on the TV receiver.

17. Outdoor Antenna Grounding

If an outside antenna or cable system is connected to the TV receiver, be sure the antenna or cable system is grounded so as to provide some protection against voltage surges and built-up static charges.

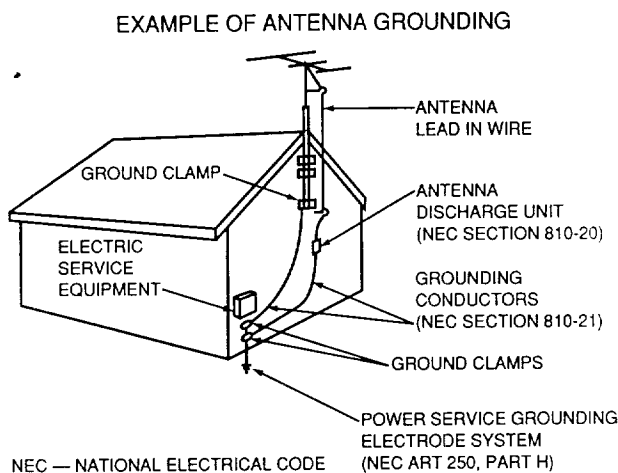

Section 810 of the National Electrical Code, ANSI/NFPA No. 70, provides information with regard to proper grounding of the mast and supporting structure, grounding of the lead-in wire to an antenna discharge unit, size of grounding conductors, location of antenna discharge unit, connection to grounding electrodes, and requirements for the grounding electrode.

18. Servicing

Do not attempt to service this TV receiver yourself as opening or removing covers may expose you to dangerous voltage or other hazards. Refer all servicing to qualified service personnel.

19. Damage Requiring Service

Unplug this TV receiver from the wall outlet and refer servicing to qualified service personnel under the following conditions:

- When the power-supply cord or plug is damaged.
- If liquid has been spilled, or objects have fallen into the TV receiver.
- If the TV receiver has been exposed to rain or water.
- If the TV receiver does not operate normally by following the operating instructions.
Adjust only those controls that are covered by the operating instructions as an improper adjustment of other controls may result in damage and will often require extensive work by a qualified technician to restore the TV receiver to its normal operation.
- If the TV receiver has been dropped or the cabinet has been damaged.
- When the TV receiver exhibits a distinct change in performance — this indicates a need for service.

20. Replacement Parts

When replacement parts are required, be sure the service technician has used replacement parts specified by the manufacturer or have the same characteristics as the original part. Unauthorized substitutions may result in fire, electric shock or other hazards.

21. Safety Check

Upon completion of any service or repairs to this TV receiver, ask the service technician to perform safety checks to determine that the TV receiver is in safe operating conditions.



Table of Contents

Important Safeguards	i
Preface: Welcome to Mitsubishi	1
Special features	1
Unpacking your TV	2
Chapter One: Getting to Know Your TV	3
Overview of the remote control	3
Overview of the control panel	4
Chapter Two: Connecting Your TV	5
Locating the terminal and inputs	5
Connecting the indoor antenna	5
Connecting a VHF/UHF combined antenna	6
Connecting separate VHF/UHF antennas	6
Connecting cable without a cable box	7
Connecting cable with a cable box	7
Connecting a VCR	8
Chapter Three: Operating Your TV	9
Using the remote	9
Using the menus	9
Selecting the on-screen language	10
Memorizing channels	10
Adding and deleting channels	11
Adjusting the video settings	12
Adjusting the audio settings (CS-20203/CS-20203C only)	12
Using closed captions	13
Setting the sleep timer	14
Selecting your favorite color setting	14
Using headphones	14
Chapter Four: Troubleshooting	15



Welcome to Mitsubishi

Thank you for selecting our product, and welcome to Mitsubishi! Your new television is designed for excellent picture quality, and this owner's guide is written with easy-to-follow directions. We hope you enjoy your new Mitsubishi television.

Special features

Your TV comes with many special features, including:

- **Trilingual menus** --- You can choose to display your TV's on-screen menus in English, Spanish, or French.
- **Closed Caption Decoder** --- You can view conversations, narration, and other soundtrack information as captions on your TV screen.
- **Sleep timer** --- You can set your TV to turn off after 30, 60, 90, or 120 minutes.
- **Preview** --- You can quickly scan all of your TV's available channels at the touch of one button.

- **Quick View** --- You can quickly switch between two channels at the touch of a button.
- **181-Channel Capacity** --- Your TV can tune up to 181 channels, ensuring that your TV will still be up-to-date as cable systems expand.
- **Multichannel TV Sound (MTS)** --- Your TV can receive and play stereo or bilingual signals (CS-20203 and CS-20203C only).

Unpacking your TV

What you will find

As you unpack your TV, please check to be sure that along with the TV, the following items are included:

- an owner's guide with a warranty,
- a remote control transmitter,
- a set of two AAA size batteries for the remote control,
- a 300/75 ohm adaptor, and
- an indoor antenna ("rabbit ears").

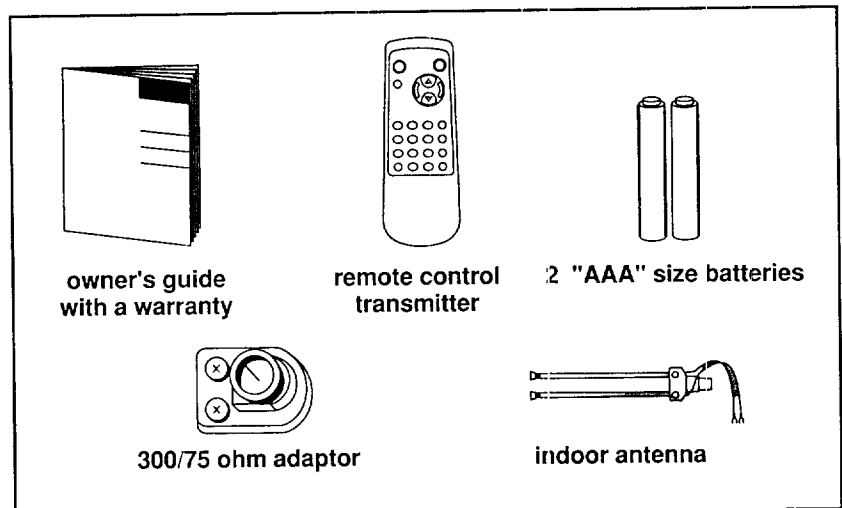

A few suggestions

Before you hook up your new TV, please take a few minutes to:

- 1 Write down the TV's model and serial number and file it in a safe place.
- 2 Keep the box and packing materials for future use.
- 3 File your sales receipt.
- 4 Place the TV on a stable surface with sufficient lighting to hook up your TV.



Getting to Know Your TV

This chapter will introduce the buttons that you will use to control your TV. These buttons are located in two places: on the remote control and on the TV's front panel.

Overview of the remote control

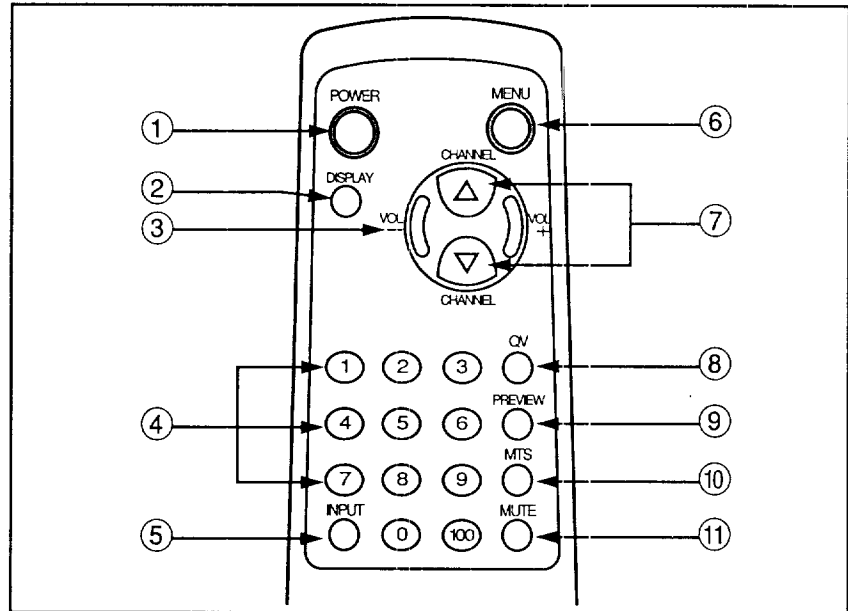

- ① **power button (POWER)**
Press this button to turn the TV on or off.
- ② **display button (DISPLAY)**
Use this button to display the current channel.
- ③ **volume buttons (VOL -, VOL +)**
Press the "+" button to turn up the volume and the "-" to turn down the volume. Also use these buttons to adjust settings when using the menus.
- ④ **number buttons (0 - 9, 100)**
Use these buttons to tune directly to a particular channel.
- ⑤ **input button (INPUT)**
Use this button to switch between viewing the TV and viewing the signal from any components that may be attached (such as a VCR).
- ⑥ **menu button (MENU)**
Press this button to enter or exit the menus.
- ⑦ **channel buttons (▼ CHANNEL ▲)**
Press the ▲ button to switch to a higher number channel and the ▼ button to switch to a lower number channel.

Overview of the Remote Control (cont.)

- ⑧ **quick view button (QV)**
Use this button to return to the previously viewed channel.
- ⑨ **preview button (PREVIEW)**
Use this button to scan through the TV's channels.
- ⑩ **audio adjustment button (MTS) (CS-20203, CS-20203C only)**
Use this button to change the TV's audio setting.
- ⑪ **mute button**
Use this button to turn off the sound and display the captions.

Overview of the control panel

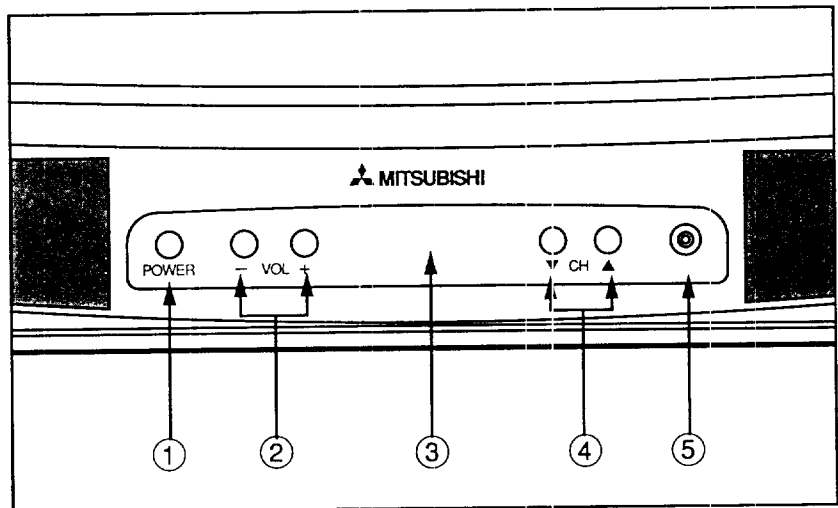

The front panel of your TV may not match the illustration exactly.

- ① **power button (POWER)**
Press this button to turn the TV on or off.
- ② **volume buttons (- VOL +)**
Press the "+" button to turn up the volume and the "-" button to turn down the volume.
- ③ **remote sensor area**
This area receives the signal from the remote control. Aim the remote control here.
- ④ **channel buttons (▼ CH ▲)**
Press the ▲ button to switch to a channel with a higher number and the ▼ button to switch to a channel with a lower number.
- ⑤ **headphone jack**
Plug headphones in here.



Connecting Your TV

This chapter describes the equipment and procedures needed for basic hook-ups. For more complex hook-ups, contact your dealer or local cable company.

Locating the terminal and inputs

When connecting antennas, cables, or A/V products to your TV, you will connect them to either the COAXIAL CABLE CONNECTOR or to the AUDIO IN and VIDEO IN terminals. These are located on the rear of your TV, on the lower left.

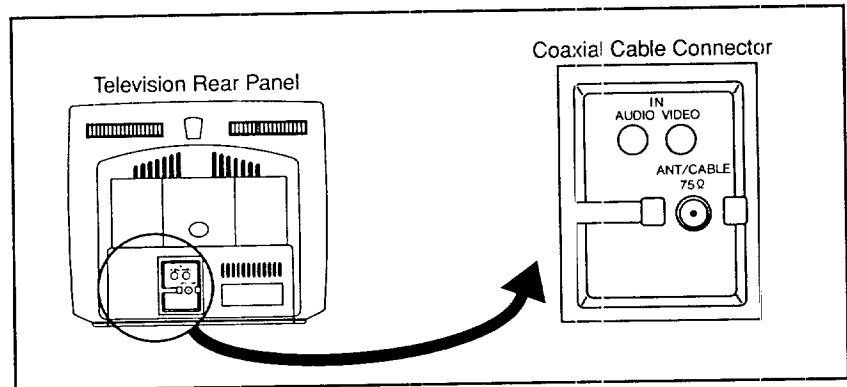

Connecting the indoor antenna

- 1 Plug the indoor antenna (included) into the TV as shown in the illustration. Push the antenna in until it snaps into place.
- 2 Place the leads from the antenna under the screws on the adaptor. Tighten the screws with a screwdriver.
- 3 Press the adaptor onto the COAXIAL CABLE CONNECTOR on the back of the TV.

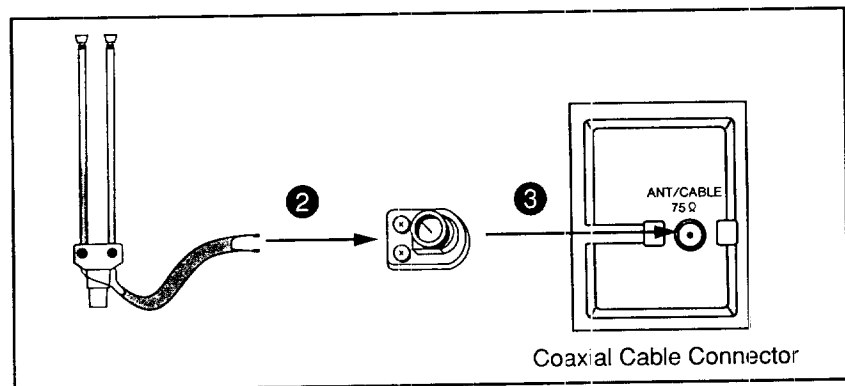
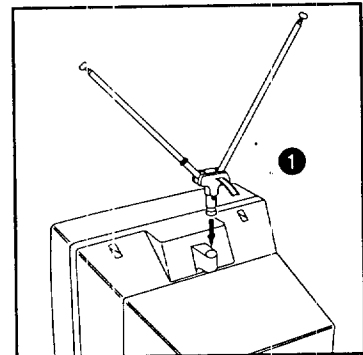

Connecting a VHF/UHF combined antenna

- 1 If the antenna uses a 75-ohm coaxial lead, press the lead directly onto the COAXIAL CABLE CONNECTOR on the TV.
- 2 If the antenna uses twin leads, place the leads under the screws on the adaptor. Tighten the screws with a screwdriver.
- 3 Press the adaptor onto the COAXIAL CABLE CONNECTOR on the back of the TV.

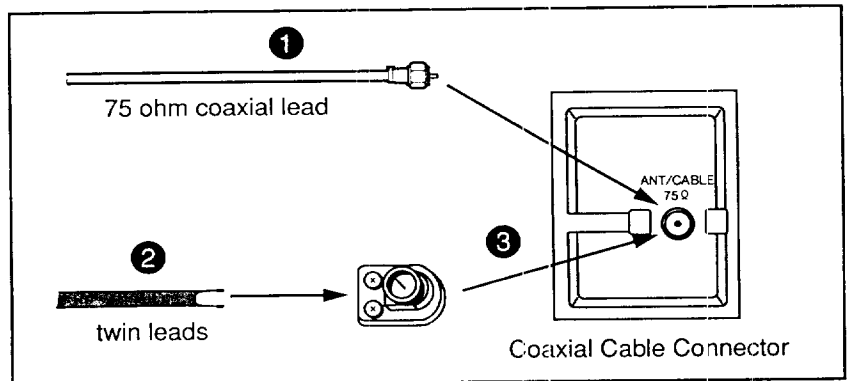

Connecting separate VHF/UHF antennas

- 1 Connect the leads from each antenna onto a combiner. (You can purchase a combiner from your dealer or an electronics store.)
- 2 Press the combiner onto the COAXIAL CABLE CONNECTOR on the back of the TV.

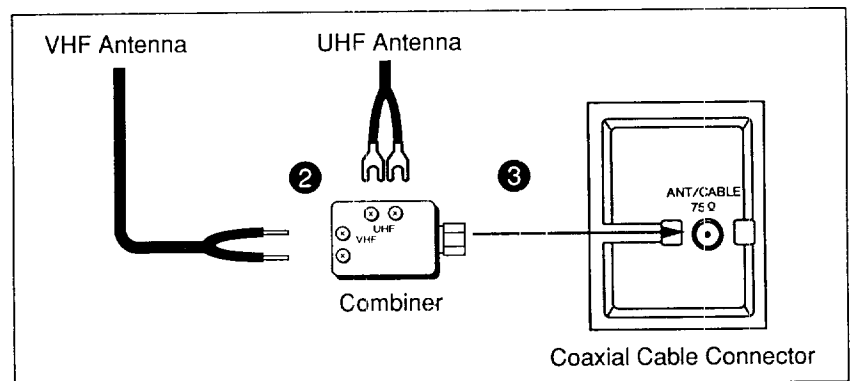

The combiner you need may be different from the one shown in the illustration, especially if your VHF antenna has a 75 ohm coaxial lead.

Connecting cable without a cable box

- 1 Connect the incoming coaxial cable onto the COAXIAL CABLE CONNECTOR on the back of the TV.

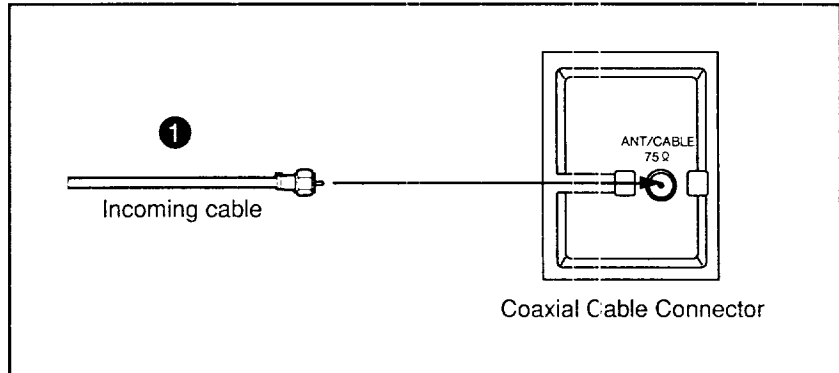

Connecting cable with a cable box

Use this connection if you only need to use the cable box to descramble some channels. If your cable box is needed to descramble ALL channels, use the method described in "Connecting cable without a cable box."

- 1 Connect the incoming cable to a signal splitter (not included).
- 2 Connect a coaxial cable (not included) to one output on the splitter. Connect the other end of this cable to the "A IN" terminal on an RF switch (not included).
- 3 Connect another coaxial cable to the other output of the splitter. Connect the other end of this cable to the INPUT terminal on the cable box.
- 4 Connect a third cable to the OUTPUT terminal on the cable box. Connect the other end of this cable to the "B IN" terminal on the RF switch.
- 5 Connect a fourth cable to the OUTPUT terminal on the RF switch. Connect the other end of this cable to the COAXIAL CABLE CONNECTOR on the back of the TV.

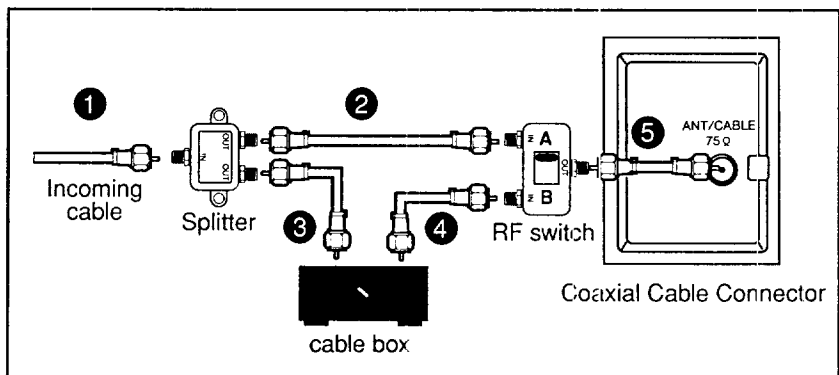

Connecting a VCR

These instructions show how to connect a VCR to allow you to view a VCR tape on your TV. These instructions may not be appropriate if you want to use your VCR to record. Please refer to your VCR's operating guide for more information.

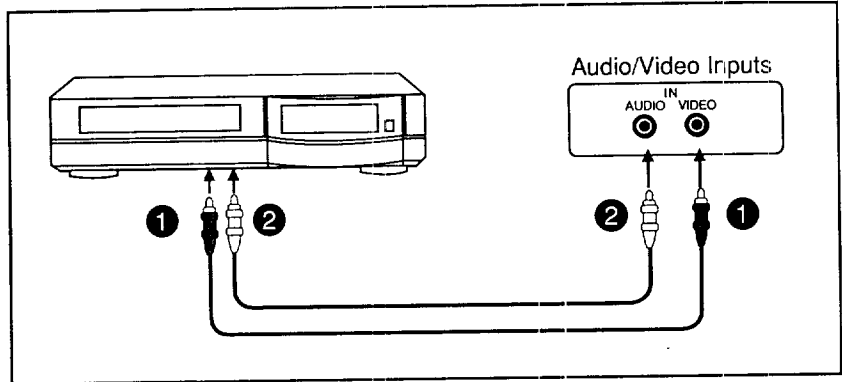

- 1 Connect a video cable to the VIDEO OUT terminal on the VCR. Connect the other end of this cable to the VIDEO IN terminal on the rear of the TV.
- 2 (For models CS-13103, CS-13104, CS-13103C, CS-20103, and CS-20103M.) Connect an audio cable to the AUDIO OUT terminal on the VCR. If you have a stereo VCR, connect the cable to the LEFT terminal. Connect the other end of this cable to the AUDIO IN terminal on the rear of the TV.
- 2 (For models CS-20203, CS-20203C.) Connect an audio cable to the AUDIO OUT L terminal on your VCR; connect the other end of this cable to the AUDIO IN L on the rear of the TV. Connect a second audio cable to the AUDIO OUT R terminal on the VCR; connect the other end of the cable to the AUDIO IN R terminal on the rear of the TV.

Watching the VCR on your TV

In order to watch the VCR on your TV, you need to tune your TV to the VIDEO mode. You can do this in one of two ways:

- 1 Press the INPUT button on the remote control. You will switch from the TV mode to the VIDEO mode.
- 2 You can also switch to the VIDEO mode with the channel buttons. Tune your TV to the highest-numbered station your TV has memorized, then press the CHANNEL ▲ button. Or, tune your TV to the lowest-numbered station your TV has memorized, then press the CHANNEL ▼ button.
- 3 To return to normal TV viewing, press the INPUT button on the remote control.

CHAPTER THREE Operating Your TV

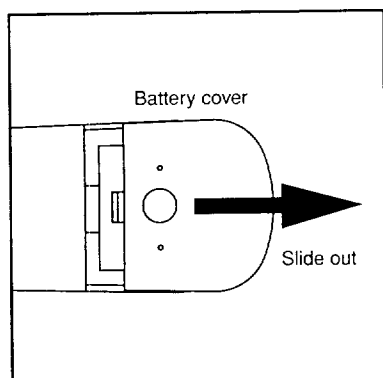

Using the remote

- 1 Remove the back cover of the remote control as shown.
- 2 Take the two batteries from the packing bag and load them into the remote control, making sure that they match the polarities (+ and -) as indicated on the remote control.
- 3 Replace the back cover of the remote control.
- 4 Point the top of the remote control towards the TV and press the appropriate button.

Notes about using the remote control

- Don't press two or more buttons at the same time.
- Don't allow the remote control to get wet or become heated.
- Avoid dropping the remote control.
- Don't use harsh chemicals to clean the remote. Use only a soft, slightly moistened cloth.
- Don't use an old battery with a new one.
- Don't heat, take apart, or throw batteries into a fire.

Using the menus

To use the menus:

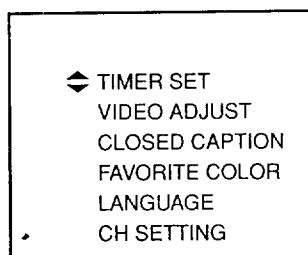

"Main Menu"

- 1 Press the MENU button on the remote control. You will see the "Main Menu," shown to the left.
- 2 Press the CHANNEL buttons to move the "◆" mark next to the feature you wish to use or change. Press the CHANNEL ▲ button to move the "◆" mark up; press the CHANNEL ▼ button to move the "◆" mark down.
- 3 Press the VOL + button to use or change that feature.
- 4 When you are finished using the menus, press the MENU button on the remote control to return to normal TV viewing.

Selecting the on-screen language

To select the on-screen menu language:

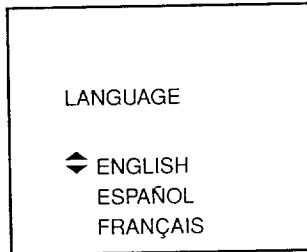

"Language Menu"

- 1 Press the MENU button on the remote control. You will see the "Main Menu."
- 2 Use the CHANNEL buttons to move the "◆" mark next to "Language."
- 3 Press the VOL + button.
- 4 Press the CHANNEL buttons to select the language you want to use.
- 5 When you are finished, press the MENU button on the remote control to return to normal TV viewing.

Memorizing channels

Whenever you first install your TV, your TV needs to memorize all of the channels it can receive. This memorization has two parts: choosing an antenna setting and searching for available channels.

Choosing an antenna setting

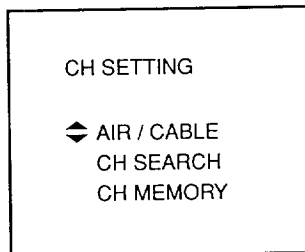

"Channel Setting Menu"

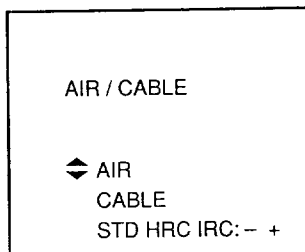

"Air/Cable Menu"

- 1 Press the MENU button on the remote control. You will see the "Main Menu."
- 2 Use the CHANNEL buttons to move the "◆" mark next to "CH SETTING."
- 3 Press the VOL + button. You will see the "Channel Setting Menu."
- 4 Use the CHANNEL buttons to move the "◆" mark next to "AIR/CABLE."
- 5 Press the VOL + button. You will see the "Air/Cable Menu"
 - **If you have connected an off-air antenna**, use the CHANNEL buttons to move the "◆" mark next to "AIR."
 - **If you have connected a cable antenna**, use the CHANNEL buttons to move the "◆" mark next to "CABLE." Use the VOLUME buttons to select STD, HRC, or IRC, depending on what type of cable system you have. (Contact your cable company if you do not know what type of cable system you have.)
- 6 Press the MENU button to exit.

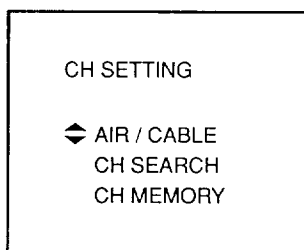

“Channel Setting Menu”

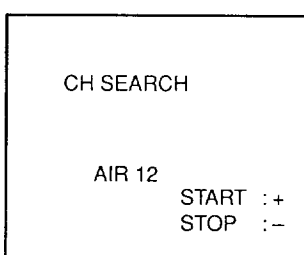

“Channel Search Menu”

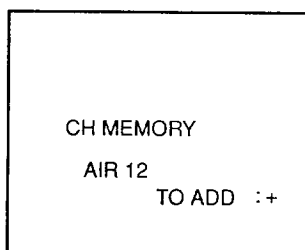

“Channel Memory Menu”

Searching for available channels

- 1 Press the MENU button on the remote control. You will see the “Main Menu.”
- 2 Use the CHANNEL buttons to move the “◆” mark next to “CH SETTING.”
- 3 Press the VOL + button. You will see the “Channel Setting Menu.”
- 4 Use the CHANNEL buttons to move the “◆” mark next to “CH SEARCH.” Press the VOL + button. You will see the “Channel Search Menu.”
- 5 Press the VOL + button to begin searching for available channels. Available channels will be displayed on the TV as they are found.
- 6 If you wish to stop channel search, press the VOL – button.
- 7 When finished, press the MENU button to exit.

Adding and deleting channels

There may be times when you want to add or delete channels from your TV's memory. To do this:

- 1 Press the MENU button on the remote control. You will see the “Main Menu.”
- 2 Use the CHANNEL buttons to move the “◆” mark next to “CH SETTING.”
- 3 Press the VOL + button. You will see the “Channel Setting Menu.”
- 4 Use the CHANNEL buttons to move the “◆” mark next to “CH MEMORY.” Press the VOL + button. You will see the “Channel Memory Menu.”
- 5 Use the CHANNEL buttons to select a channel that you want to add or delete.
- 6 If the channel is in the TV's memory, press the VOL – button to delete it. If the channel is not in the TV's memory, press the VOL + button to add it.
- 7 When finished, press the MENU button to exit.

Adjusting the video settings

To adjust the video settings:

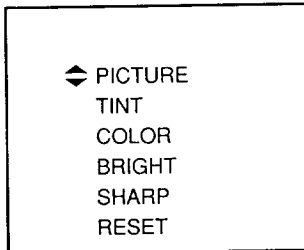

“Video Adjustment Menu”

- 1 Press the MENU button on the remote control. You will see the “Main Menu.”
- 2 Use the CHANNEL buttons to move the “◆” mark next to “VIDEO ADJUST.” Press the VOL + button. You will see the “Video Adjustment Menu.”
- 3 Use the CHANNEL buttons to move the “◆” mark next to setting you want to adjust.
- 4 Press and hold the VOL + or VOL – button to adjust that setting. The descriptions of each type of setting are shown below.
- 5 When finished, press the MENU button to exit.

Descriptions of video settings

- **Picture** --- Press VOL – to decrease contrast; press VOL + to increase contrast.
- **Tint** --- Press VOL – to add purple to skin tones; press VOL + to add green to skin tones.
- **Color** --- Press VOL – to decrease color intensity; press VOL + to increase color intensity.
- **Bright** --- Press VOL – to decrease brightness; press VOL + to increase brightness.
- **Sharp** --- Press VOL – to decrease sharpness; press VOL + to increase sharpness.
- **Reset** --- Press VOL – or VOL + to return all settings to their original factory levels.

Adjusting the audio settings (CS-20203, CS-20203C only)

Your TV can receive and play three types of audio signals: stereo, S.A.P., and mono.

- You should set your TV to **stereo** for normal TV viewing. Your TV will play stereo when the program you are watching is being broadcast in stereo. Otherwise, your TV will play in mono.
- Some broadcasters will broadcast an **S.A.P.**, or Separate Audio Program. An S.A.P. is an alternative soundtrack. It is often another language, but it can also be unrelated information, such as news or weather. Choose S.A.P. when you want listen to this soundtrack. (S.A.P. is a mono signal.)
- Choose **mono** when you are having difficulty receiving an audio signal on a particular station. This may help make the sound clearer.

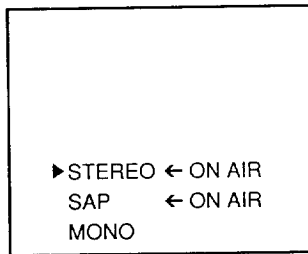

“Audio Adjustment Menu”

To choose an audio setting:

- 1 Press the MTS button on the remote control. You will cycle through the audio settings: “stereo,” “SAP,” and “mono.” Press the MTS button until you have selected the setting you want.

Using closed captions

Your TV is equipped with an internal closed caption decoder. “Closed Captioning” is a system that allows you to view conversations, narration, and sound effects as captions on your TV screen. Captions usually appear at the bottom of your screen and do not block your view of the program.

Closed captioning also gives you access to “text” services, which provide news, weather, and other information. Text services sometimes take up your entire TV screen and can block your view of the program.

Additionally, each television channel can have more than one version of captions, or more than one version of text. These versions are called “channels.” To use the closed caption system:

- 1 Press the MENU button on the remote control. You will see the “Main Menu.”
- 2 Use the CHANNEL buttons to move the “◄” mark next to “CLOSED CAPTION.” Press the VOL + button. You will see the “Closed Caption Menu.”
- 3 Use the CHANNEL buttons to move the “◄” mark next to either “mode” or “data.” “Mode” allows you to choose between captions, text, or off. “Data” allows you to choose between channels 1 and 2 for captions and text.
- 4 Use the volume buttons to change the “Mode” and “Data” settings.
- 5 When finished, press the MENU button to exit.

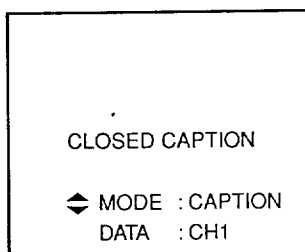

“Closed Caption Menu”

- If you are watching a program that has captions and you press the MUTE button, captions will automatically appear. They will disappear when you press the MUTE button again.
- Closed captioning can malfunction (showing white blocks or strange characters instead of letters) when there are problems with the TV signal. This is not a malfunction of the TV.
- Captions do not appear when you turn on a display or menu.
- If you have “Text” mode selected, and you are watching a program without text service, your screen may be blocked by a large black rectangle. Turn the “Text” mode off.

Setting the sleep timer

You can set your television to turn off after 30, 60, 90, or 120 minutes. To do this:

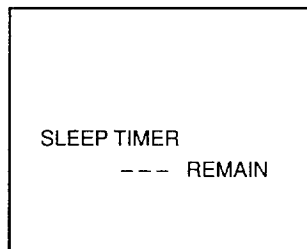

"Sleep Timer Menu"

- 1 Press the MENU button on the remote control. You will see the "Main Menu."
- 2 Use the CHANNEL buttons to move the "◀" mark next to "TIMER SET." Press the VOL + button. You will see the "Sleep Timer Menu."
- 3 Use the volume buttons to set the sleep time to 30, 60, 90, or 120 minutes. (To cancel the sleep timer, press the volume buttons until "---" appears.)
- 4 When finished, press the MENU button to exit. The TV will turn off after the set number of minutes have elapsed.

Selecting your favorite color setting

You can set your television's color tone to a setting that you like best. To do this:

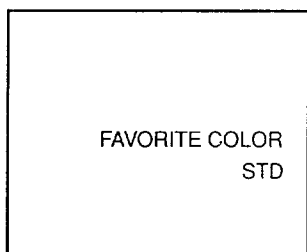

"Favorite Color Menu"

- 1 Press the MENU button on the remote control. You will see the "Main Menu."
- 2 Use the CHANNEL buttons to move the "◀" mark next to "FAVORITE COLOR." Press the VOL + button. You will see the "Favorite Color Menu."
- 3 Use the volume buttons to set your favorite color to RED TONE, BLUE TONE, or STANDARD (STD).
- 4 When finished, press the MENU button to exit.

Using headphones

When using headphones, follow the instructions below.

- 1 Turn the volume of the TV all the way down.
- 2 Plug the headphones into the headphone jack on the TV.
- 3 Adjust the volume to a comfortable level.

When headphones are plugged in, the TV's external speakers are turned off.



CHAPTER FOUR

Troubleshooting

If you are having a problem with your TV, please try one or more of the solutions below before contacting your dealer or service shop. You may be able to correct the problem yourself.

Problems

If you can't see the signal from your VCR or disc player, try solution ⑪.

If there is no picture or sound coming from your TV, try solutions ②, ③, ⑦, ⑧, and ⑪.

If the remote control does not work, try solutions ②, ⑧, and ⑫.

If there are bars on the screen, try solution ⑥.

If the picture is distorted, try solutions ① and ⑤.

If the picture rolls vertically, try solutions ①, ⑤, ⑥, and ⑧.

If there is no color, try solutions ①, ④, ⑤, ⑧, ⑨.

If there is poor reception on some channels, try solutions ①, ④, ⑤, and ⑥.

If there is a weak picture, try solutions ①, ④, and ⑤.

If there are lines or streaks in the picture, try solutions ①, ⑤, and ⑥.

If there are ghosts in the picture, try solutions ①, ④, ⑤, and ⑥.

If the picture is blurry, try solutions ① and ⑤.

If the sound is good but the picture is poor, try solutions ①, ④, ⑤, ⑥, ⑧, ⑩, and ⑪.

If the picture is good but the sound is poor, try solutions ①, ⑥, ⑧, and ⑪.

If there is no picture or sound, try solutions ①, ②, ③, ④, ⑤, ⑦, ⑧, and ⑪.

If your screen is covered by a dark, black rectangle, try solutions ⑧ and ⑬.

Possible solutions

① Try changing channels to see if it may be a problem with that broadcast station.

② Make sure the TV is plugged into a working outlet.

③ Make sure the TV is turned on.

④ Make sure the antenna is connected to the back of the TV.

⑤ Check for a broken wire in your antenna.

⑥ Check to see if there are any magnetic or electric products that may be interfering with the TV reception.

⑦ Try turning the TV off for about one minute, then turning it back on.

⑧ Try leaving the TV unplugged for about one minute, then plugging it back in.

⑨ Adjust the COLOR video setting.

⑩ Adjust the PICTURE (contrast) setting.

⑪ Check the connections to your TV.

⑫ Check the batteries in the remote control.

⑬ Set the closed caption setting to "OFF."

MITSUBISHI COLOR TELEVISION OR COLOR MONITOR
20" OR SMALLER
LIMITED WARRANTY

MITSUBISHI ELECTRONICS AMERICA, INC. ("MELA") warrants to the original purchaser of this television or monitor if purchased from an authorized MITSUBISHI Audio/Video Dealer that, should it prove defective by reason of improper workmanship and/or material:

- a. **Picture Tube.** For two years from the date of purchase at retail, we will repair or replace, at our option, any defective picture tube without charge for the tube.
- b. **Other Parts.** For one year from the date of original purchase at retail, we will repair or replace, at our option, any defective part without charge for the part.
- c. All parts used for replacement are warranted for the remainder of the original warranty period.
- d. **Labor.** For one year from the date of original purchase at retail, we will provide the labor for a warranty repair without charge at an authorized MITSUBISHI service center.
- e. **Notice.** To obtain warranty service, you must notify an authorized MITSUBISHI service center of any defect within the applicable warranty time period.

1. TO OBTAIN WARRANTY SERVICE, deliver your television or monitor to the nearest authorized MITSUBISHI service center. Shipping expenses are your responsibility. The name and address of the nearest service center can be obtained from your MITSUBISHI Dealer, or by writing or calling MELA at the address and telephone number provided below. Proof of purchase date from an authorized MITSUBISHI Dealer is required when requesting warranty service. Present your sales receipt or other document which establishes proof and date of purchase. THE RETURN OF THE OWNER REGISTRATION CARD IS NOT A CONDITION OF WARRANTY COVERAGE. However, please detach and return the Owner Registration Card so that we can contact you should a question of safety arise which could affect you.

2. THIS WARRANTY DOES NOT COVER damage caused by: modification, alteration, repair or service of this product by anyone other than an authorized MITSUBISHI service center; physical abuse to, or misuse of, the product; operation in a manner contrary to the instructions which accompany the product; freight damage; or any damage caused by acts of God such as lightning or fluctuation in electrical power. This warranty also excludes all costs arising from installation, adjustment of user controls, external antenna systems, service of products purchased or serviced outside the U.S.A., initial technical adjustments (set-up) and user-required maintenance. Consult the operating instructions furnished with the product for information regarding user controls.

3. ANY EXPRESS WARRANTY NOT PROVIDED HEREIN, AND ANY REMEDY WHICH, BUT FOR THIS PROVISION, MIGHT ARISE BY IMPLICATION OR OPERATION OF LAW, IS HEREBY EXCLUDED AND DISCLAIMED. THE IMPLIED WARRANTIES OF MERCHANTABILITY AND OF FITNESS FOR ANY PARTICULAR PURPOSE ARE EXPRESSLY LIMITED TO A TERM OF ONE YEAR.

4. UNDER NO CIRCUMSTANCES SHALL MELA BE LIABLE TO PURCHASER OR ANY OTHER PERSON FOR ANY INCIDENTAL, SPECIAL OR CONSEQUENTIAL DAMAGES, WHETHER ARISING OUT OF BREACH OF WARRANTY, BREACH OF CONTRACT, OR OTHERWISE.

5. Some states do not allow limitations on how long an implied warranty lasts, or the exclusion or limitation of incidental, special, or consequential damages, so the above limitations or exclusions may not apply to you.

6. This warranty gives you specific legal rights and you may also have other rights which vary from state to state.

7. BEFORE REQUESTING SERVICE, please review the instruction booklet to insure proper installation and correct customer control adjustment. If the problem persists, contact your nearest MITSUBISHI Dealer for name(s) of authorized MITSUBISHI Service Center(s). If you are unable to obtain this information, please call 1-800-332-2119, or write us at the address below.

MITSUBISHI ELECTRONICS AMERICA, INC.
P.O. Box 5025
Norcross, GA 30091-5025



RETAIN THIS PORTION FOR YOUR RECORDS

SERIAL NO. _____

CUSTOMER NAME _____

STREET ADDRESS _____

CITY _____ STATE _____ ZIP _____

PHONE () _____ PURCHASE DATE _____ / _____ / _____

MO DAY YR

PLACE OF PURCHASE _____



MITSUBISHI ELECTRONICS AMERICA, INC.
6100 Atlantic Boulevard
Norcross, GA 30071-1305

© 1995 Mitsubishi Electronics America, Inc.

PRINTED IN U.S.A.
TINS-5579MEZZ