



# HITACHI

# SOLID STATE COLOR TV

## 27AX4B, 27AX3B 27AX0B

### OPERATING GUIDE

Your new HITACHI COLOR TV incorporates a host of features designed to give you excellent performance if you follow the instructions in this manual. We recommend that you read the following instructions and "IMPORTANT SAFEGUARDS" notice before turning on your TV set for the first time.





This television receiver will display television closed captioning (  or  ) in accordance with paragraph 15.119 of the FCC rules.

### TABLE OF CONTENTS

IMPORTANT SAFEGUARDS .....	2	SOUND FUNCTIONS .....	25
BEFORE OPERATING YOUR TV SET .....	5	SPECIAL FEATURE FOR THE 27AX4B (P-IN-P) .....	27
LOCATION OF CONTROLS .....	6	PICTURE-IN-PICTURE FUNCTIONS .....	27
FRONT PANEL JACKS AND CONNECTIONS .....	8	USING THE GENIUS REMOTE TO CONTROL:	
HOW TO SELECT CHANNELS .....	9	VCR FUNCTIONS .....	29
PICTURE CAUTION .....	9	CABLE BOX FUNCTIONS .....	30
THE GENIUS REMOTE CONTROL CLU-692GR		CONNECTING EXTERNAL AUDIO AMPLIFIER .....	32
WITH P-IN-P (FOR MODEL 27AX4B) .....	10	CONNECTING EXTERNAL VIDEO SOURCES .....	33
THE GENIUS REMOTE CONTROL CLU-681GJ WITHOUT		CONNECTING STEREO VCR OR STEREO VIDEO	
P-IN-P (FOR MODEL 27AX3B) .....	11	DISC PLAYER .....	34
REMOTE CONTROL CLU-264		ACCESSORIES PART NUMBERS .....	34
(FOR MODEL 27AX0B) .....	12	TRANSMITTER BATTERY INSTALLATION	
HOW TO USE THE REMOTE TO OPERATE		AND REPLACEMENT .....	35
YOUR TV .....	13	TROUBLESHOOTING .....	36
SET-UP FUNCTIONS .....	16	SPECIFICATIONS .....	37
PICTURE FUNCTIONS .....	24	SERVICE HOTLINE .....	38

# IMPORTANT SAFEGUARDS

Follow all warnings and instructions marked on TV set.

	<b>CAUTION</b> RISK OF ELECTRIC SHOCK DO NOT OPEN			The lightning flash with arrowhead symbol, within an equilateral triangle, is intended to alert the user to the presence of uninsulated "dangerous voltage" within the TV set enclosure that may be of sufficient magnitude to constitute a risk of electric shock to persons.
<b>CAUTION:</b> TO REDUCE THE RISK OF ELECTRIC SHOCK, DO NOT REMOVE COVER (OR BACK). NO USER-SERVICEABLE PARTS INSIDE. REFER SERVICING TO QUALIFIED SERVICE PERSONNEL.				The exclamation point within an equilateral triangle is intended to alert the user to the presence of important operating and maintenance (servicing) instructions in the literature accompanying the TV set.

## WARNING: TO PREVENT FIRE OR SHOCK HAZARD, DO NOT EXPOSE THIS TV SET TO RAIN OR MOISTURE.

- There are no user serviceable parts inside the TV set.
- Never remove the back cover of the TV set, as this can expose you to a very high voltage and other hazards.
- If the TV set does not operate properly, unplug the set and call your dealer or service shop.

## WARNING:

### POWER SOURCE

- This TV set operates only on AC 120 volts 60 Hz.
- To prevent fire or shock hazard, connect this TV set to 120 VAC 60Hz (house current) ONLY. Never connect the TV to 50Hz or DIRECT CURRENT POWER SOURCES.
- This TV set is equipped with a polarized alternating current line plug (a plug having one blade wider than the other). This plug will fit into the receptacle only one way. If you are unable to insert the plug fully into the receptacle, try reversing the plug. If the plug should still fail to fit, contact a local electrician.
- To prevent shock hazard do not use this polarized plug with an extension cord, receptacle or other outlet unless the blades can be fully inserted to prevent blade exposure.
- If the power cord or plug is damaged or frayed, unplug the TV set from the receptacle and refer servicing to qualified service personnel.
- To prevent fire or shock hazard, do not overload receptacle and extension cords.

#### • POLARIZED PLUG

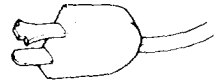

#### • NO GOOD

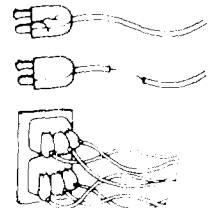

### INSTALLATION

#### ■ ANTENNA

Unless your TV set is connected to a cable TV system or to a centralized antenna system, a good outdoor color TV antenna is recommended for the best performance. However, if you are located in an exceptionally good signal area that is free from interference and multiple image ghosts, the indoor antenna may be sufficient.

#### ■ LOCATION

Select an area where sunlight or bright indoor illumination will not fall directly on the picture screen. Also, be sure that the location selected allows a free flow of air to and from the perforated back cover of the TV set.

To prevent damaging the TV, do not leave the set in a place where the temperature becomes too hot. For example, exposed to direct sunlight or near a heating device, etc.

#### ■ VIEWING

This TV set may be viewed from any desired distance. Most viewers prefer a distance of three to six feet or more, depending on screen size, for maximum eye comfort.

**NOTE:** Model Number and serial number are indicated on the back cover of the TV set.

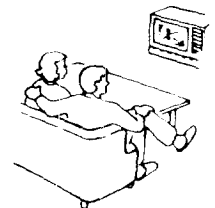

# HITACHI

## SAFETY POINTS YOU SHOULD KNOW ABOUT YOUR HITACHI TELEVISION RECEIVER.

Our reputation has been built on the quality performance and ease of service of HITACHI television receivers.

Safety is also foremost in our minds in the design of these units. To help you operate these products properly, this folder illustrates safety tips which will be of benefit to you. Please read it carefully and apply the knowledge you obtain from it to the proper operation of your HITACHI television receiver.

Please fill out your warranty registration card at once and mail it to HITACHI. This will enable HITACHI to notify you promptly in the improbable event that a safety problem should be discovered in your model of product.

## IMPORTANT SAFEGUARDS

### CAUTION:

- \* Read all of these instructions.
- \* Save these instructions for later use.
- \* Follow all warnings and instructions marked on the television receiver.

### FOR YOUR PERSONAL SAFETY

1 This television set is equipped with a polarized alternating-current line plug (a plug having one blade wider than the other). This plug will fit into the power outlet only one way. This is a safety feature. If you are unable to insert the plug fully into the outlet, try reversing the plug. If the plug should still fail to fit, contact your electrician to replace your obsolete outlet. Do not defeat the safety purpose of the polarized plug.



2 When the power cord or plug is damaged or frayed, unplug this television set from the wall outlet and refer servicing to qualified service personnel.



3 Do not overload wall outlets and extension cords as this can result in fire or electric shock.

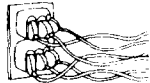

4 Do not allow anything to rest on or roll over the power cord, and do not place the TV where the power cord is subject to traffic or abuse. This may result in a shock or fire hazard.



5 Do not attempt to service this television set yourself as opening or removing covers may expose you to dangerous voltage or other hazards. Refer all servicing to qualified service personnel.

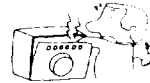

6 Never push objects of any kind into this television set through cabinet slots as they may touch dangerous voltage points or short out parts that could result in a fire or electric shock. Never spill liquid of any kind on the television set.



7 If the television set has been dropped or the cabinet has been damaged, unplug this television set from the wall outlet and refer servicing to qualified service personnel.



8 If liquid has been spilled into this television set, unplug it from the wall outlet and refer service to qualified service personnel.



9 Do not subject your television set to impact of any kind. Be particularly careful not to damage the picture tube surface.



10 Unplug this television set from the wall outlet before cleaning. Do not use liquid cleaners or aerosol cleaners. Use a damp cloth for cleaning.



11-1 Do not place this television set on an unstable cart, stand, or table. The television set may fall, causing serious injury to a child or an adult, and serious damage to the appliance. Use only with a cart or stand recommended by the manufacturer, or sold with the television set. Wall or shelf mounting should follow the manufacturer's instructions, and should use a mounting kit approved by the manufacturer.

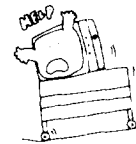

11-2 An appliance and cart combination should be moved with care. Quick stops, excessive force, and uneven surfaces may cause the appliance and cart combination to overturn.



### PROTECTION AND LOCATION OF YOUR SET

12 Do not use this television set near water... for example, near a bathtub, washbowl, kitchen sink, or laundry tub, in a wet basement, or near a swimming pool, etc.



• Never expose the set to rain or water. If the set has been exposed to rain or water, unplug the set from the wall outlet and refer to servicing personnel.

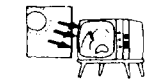

13 Choose a place where light (artificial or sunlight) does not shine directly on the screen.



14 Avoid dusty places, since accumulated dust inside the TV chassis may cause failure of the set when high humidity persists.

15 The set has slots, or openings in the cabinet for ventilation purposes, to provide reliable operation of the receiver, and to protect it from overheating. These openings must not be blocked or covered.

• Never cover the slots or openings with cloth or other material.

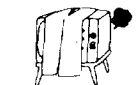

• Never block the bottom ventilation slots of the set by placing it on a bed, sofa, rug, etc.



• Never place the set near or over a radiator or heat register.

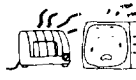

• Never place the set in a "built-in" enclosure, unless proper ventilation is provided.



## PROTECTION AND LOCATION OF YOUR SET

- 16-1 If an outside antenna is connected to the television set, be sure the antenna system is grounded so as to provide some protection against voltage surges and built up static charges. Section 810 of the National Electrical Code, NFPA No. 70-1975, provides information with respect to proper grounding of the mast and supporting structure, grounding of the lead-in wire to an antenna discharge unit, size of

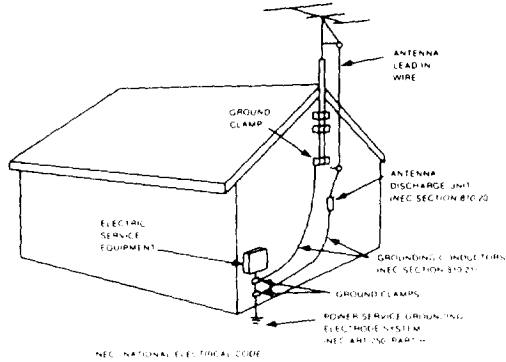

NEC NATIONAL ELECTRICAL CODE  
EXAMPLE OF ANTENNA GROUNDING AS PER NATIONAL ELECTRICAL CODE INSTRUCTIONS

grounding conductors, location of antenna discharge unit, connection to grounding electrode, and requirements for the grounding electrode.

- 16-2 Note to CATV system installer:  
(Only for the television set with CATV reception)  
This reminder is provided to call the CATV system installer's attention to Article 820-40 of the NEC that provides guidelines for proper grounding and, in particular, specifies that the cable ground shall be connected to the grounding system of the building, as close to the point of cable entry as practical.

- 17 An outside antenna system should not be located in the vicinity of overhead power lines or other electrical lights or power circuits, or where it can fall into such power lines or circuits. When installing an outside antenna system, extreme care should be taken to keep from touching such power lines or circuits as contact with them might be fatal.



- 18 For added protection for this television set during a lightning storm, or when it is left unattended and unused for long periods of time, unplug it from the wall outlet and disconnect the antenna. This will prevent damage due to lightning and power-line surges.



## OPERATION OF YOUR SET

- 19 This television set should be operated only from the type of power source indicated on the marking label. If you are not sure of the type of power supply at your home, consult your television dealer or local power company. For television sets designed to operate from battery power, refer to the operating instructions.



- 20 If the television set does not operate normally by following the operating instructions, unplug this television set from the wall outlet and refer servicing to qualified service personnel. Adjust only those controls that are covered in the operating instructions as improper adjustment of other controls may result in damage and will often require extensive work by a qualified technician to restore the television set to normal operation.

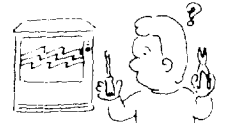

- 21 When going on a holiday: If your television set is to remain unused for a period of time, turn the television set "off" and unplug it from the wall outlet.

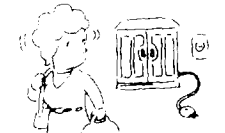

## IF THE SET DOES NOT OPERATE PROPERLY

- 22 If you are unable to restore normal operation by following the detailed procedure in your operating instructions, do not attempt any further adjustment. Unplug the set and call your dealer or service technician.



- 23 Whenever the television set is damaged or fails, or a distinct change in performance indicates a need for service, unplug the set and have it checked by a professional service technician.

- 24 It is normal for some TV sets to make occasional snapping or popping sounds, particularly when being turned on or off. If the snapping or popping is continuous or frequent, unplug the set and consult your dealer or service technician.

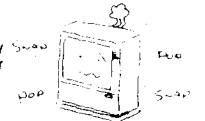

## FOR SERVICING AND MODIFICATION

- 25 Do not use attachments not recommended by the television set manufacturer as they may cause hazards.

- 26 When replacement parts are required, be sure the service technician has used replacement parts specified by the manufacturer that have the same characteristics as the original part. Unauthorized substitutions may result in fire, electric shock, or other hazards.

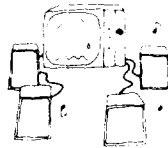

- 27 Upon completion of any service or repairs to the television set, ask the service technician to perform routine safety checks to determine that the television is in safe operating condition.

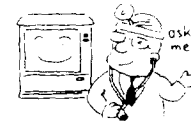

# BEFORE OPERATING YOUR TV SET

## ANTENNA CONNECTIONS

These sets are equipped with one VHF/UHF antenna terminal. The VHF/UHF terminal can be used for normal TV, cable TV (CATV), a TV game, etc.

### 1. VHF (75Ω) antenna/CATV

When using a 75 ohm coaxial cable system, disconnect the VHF adaptor from the VHF 75 ohm receptacle and connect the outdoor antenna or CATV cable to a VHF 75 ohm receptacle.

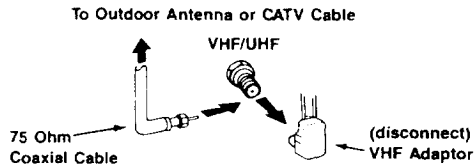

### 3. When both VHF and UHF antennas are connected

Attach an optional ANT. MIXER to the TV antenna terminal, and connect the cables to the ANT. MIXER.

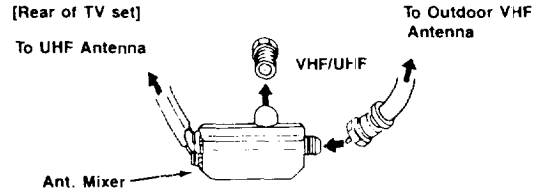

### 2. VHF (300Ω) antenna/UHF antenna

When using a 300 ohm twin lead from an outdoor antenna, disconnect the (VHF or UHF) indoor antenna leads from screws of the (VHF or UHF) adaptor, and connect outdoor (VHF or UHF) antenna leads to these screws of a (VHF or UHF) adaptor.

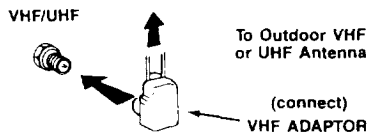

### Notes

1. If an outdoor antenna/CATV is to be used, disconnect the indoor antenna. Do not leave both the indoor and outdoor antennas/CATV connected at the same time, since ghosting and poor reception may result.
2. Consult your dealer or service store for the ANT. MIXER or VHF adaptor.
3. The special converter (decoder) will be supplied by the cable company.

# LOCATION OF CONTROLS

Details are described on the page shown by the number attached to the part name (example: ①).

## FRONT VIEW

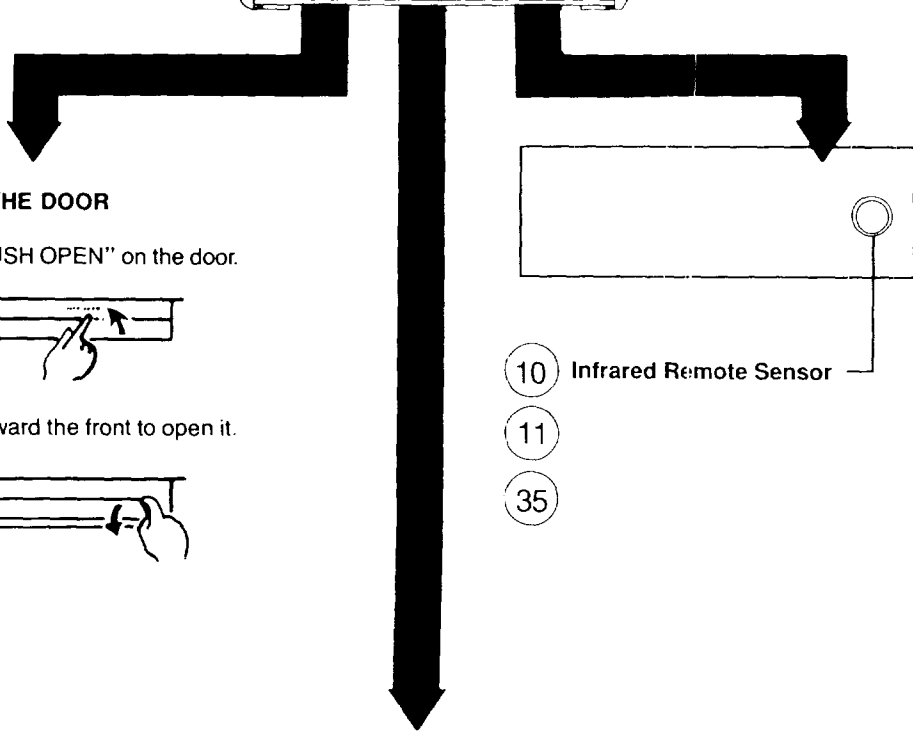
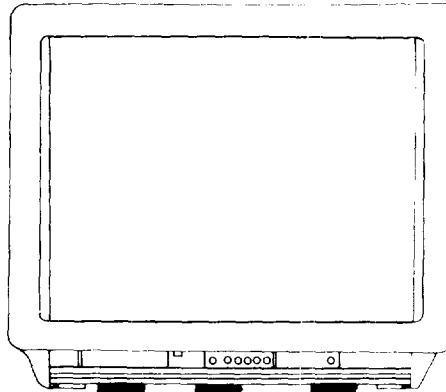

### HOW TO OPEN THE DOOR

1. Push letters "PUSH OPEN" on the door.

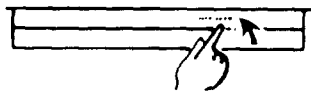

2. Pull the door toward the front to open it.

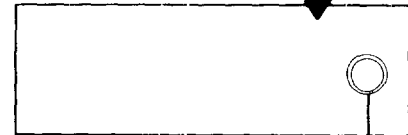
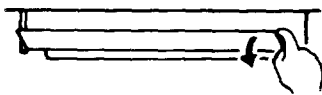

⑩ Infrared Remote Sensor

⑪

⑮

## INDOOR CONTROLS

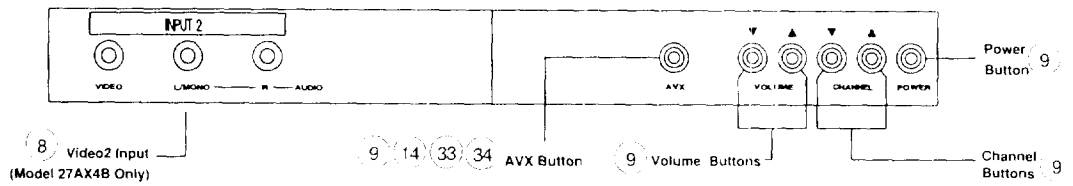

# REAR VIEW

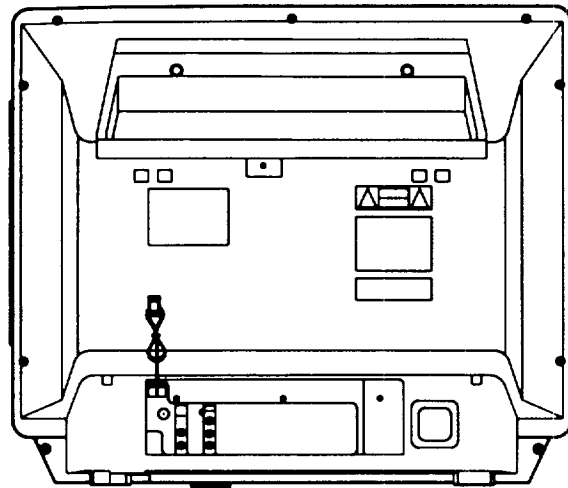

Audio Output Terminals (32)

Input Terminals (33) (34)

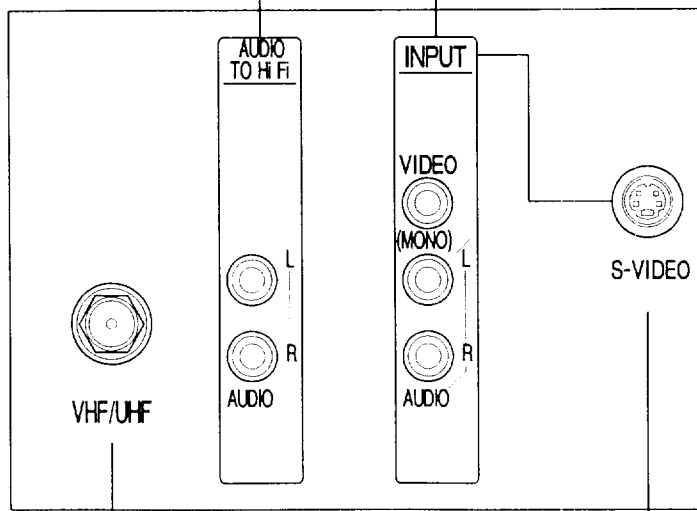

(5) VHF/UHF Antenna Terminal

(8) S-Video Input  
(Model 27AX4B Only)

**NOTE:** For 27AX0B  
(S-in Video not available.)

## FRONT PANEL JACKS AND CONNECTIONS

- The front panel jacks are provided as a convenience to allow you to easily connect a camcorder or VCR as shown in the following examples.

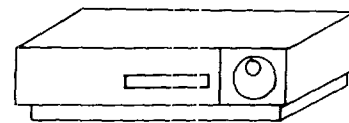
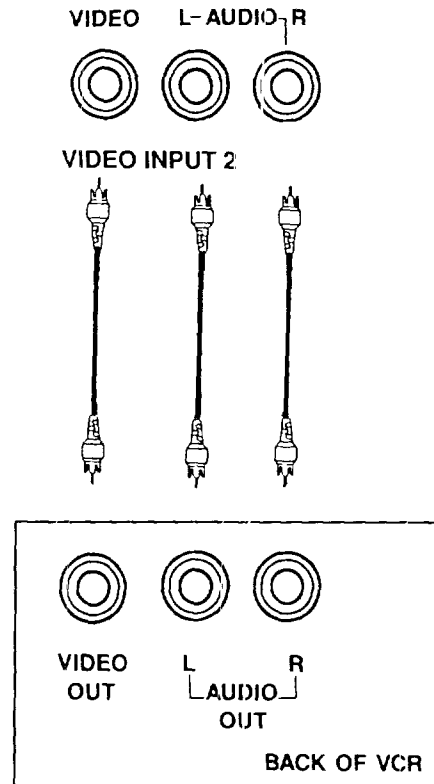
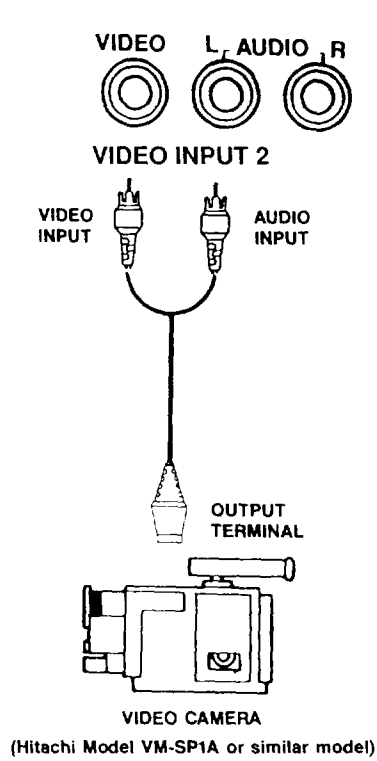

Hitachi Model VT-S751A or similar model

**NOTE:**

- Completely insert the connection cord plugs when connecting to front panel jacks. If you do not, the played back picture may be abnormal.
- If you have an S-VHS VCR, use the S INPUT cable in place of the standard video cable.



# HOW TO SELECT CHANNELS

## STEP 1

### TURNING THE SET ON —

#### POWER BUTTON

Push the POWER BUTTON to turn the set ON. (To turn the set OFF, push the POWER BUTTON again.)

## STEP 2

### VOLUME CONTROL —

#### VOLUME BUTTON

Push the right side (▲: UP) of the VOLUME BUTTON to make the sound louder, and the left side (▼: DOWN) of the VOLUME BUTTON to make the sound softer. Variation of the volume is displayed in the lower part of the screen by the color bar. (Fig. 1)

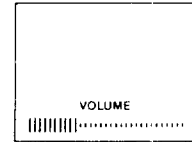

FIG. 1

## STEP 3

### FUNCTION SELECTION —

#### AVX BUTTON

Every time the AVX BUTTON is pressed, the set alternates between the TV mode and AVX mode. To watch the TV, set to the TV mode. At this time, the channel number is displayed at the upper right of the screen. To enjoy a VCR, set to the VIDEO mode. See page 14.

## STEP 4

### CHANNEL SELECTION —

#### CHANNEL BUTTON

Channel selection may be performed by pressing either the CHANNEL BUTTON UP (▲) or DOWN (▼). When pressing the right side (▲: UP) of the CHANNEL BUTTON, the next higher channel is selected. When pressing the left side (▼: DOWN) of the CHANNEL BUTTON, the next lower channel is selected. The No. of the channel to which the TV is tuned is displayed in the upper right of the screen. (Fig. 2)

Channel number indication

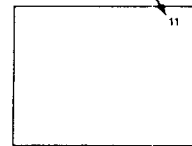

FIG. 2

The channel No. selected is displayed for approx. 8 seconds after changing channels and disappears automatically.

(When the set is turned ON, the channel No. is displayed on the screen for approx. 15 seconds.)

## PICTURE CAUTIONS

When using TV games, computers and similar products with your TV, keep the CONTRAST and BRIGHTNESS functions at low settings. If a fixed (non-moving) pattern is left on the screen for long periods of time at a high CONTRAST or BRIGHTNESS setting, the image can be permanently imprinted onto the screen. These types of imprints are not covered by your warranty because they are the result of misuse.

When using the Picture-in-Picture function the sub-picture should not be left permanently in one corner of the screen or a "pattern burn" may develop over a long period of time.

This color television receiver was intended mainly for the private viewing of programs broadcast by TV stations and cable companies and programs from other video sources. Public viewing may require prior authorization from the broadcaster or owner of the video program.

# THE GENIUS REMOTE CONTROL (CLU-692GR with P-in-P) (MODEL 27AX4B)

In addition to controlling all the functions on your Hitachi Color TV, the new Genius Remote control is designed to operate different types of VCR's (also abbreviated VTR) and different types of CATV converters (cable boxes) with one touch. Basic operation buttons are grouped together in one area. All other controls are separated from them and

arranged in MULTI-PAGE sections, with a display that can be switched to cover any of the three pages. Functions are arranged and properly categorized into windows, making operation simple even when multiple functions are to be controlled.

- To operate your TV, point the Genius remote at the remote sensor of the TV.
- To operate your VCR, point the remote at the remote sensor of the VCR.
- To operate your cable box, point the remote at the remote sensor of the cable box.

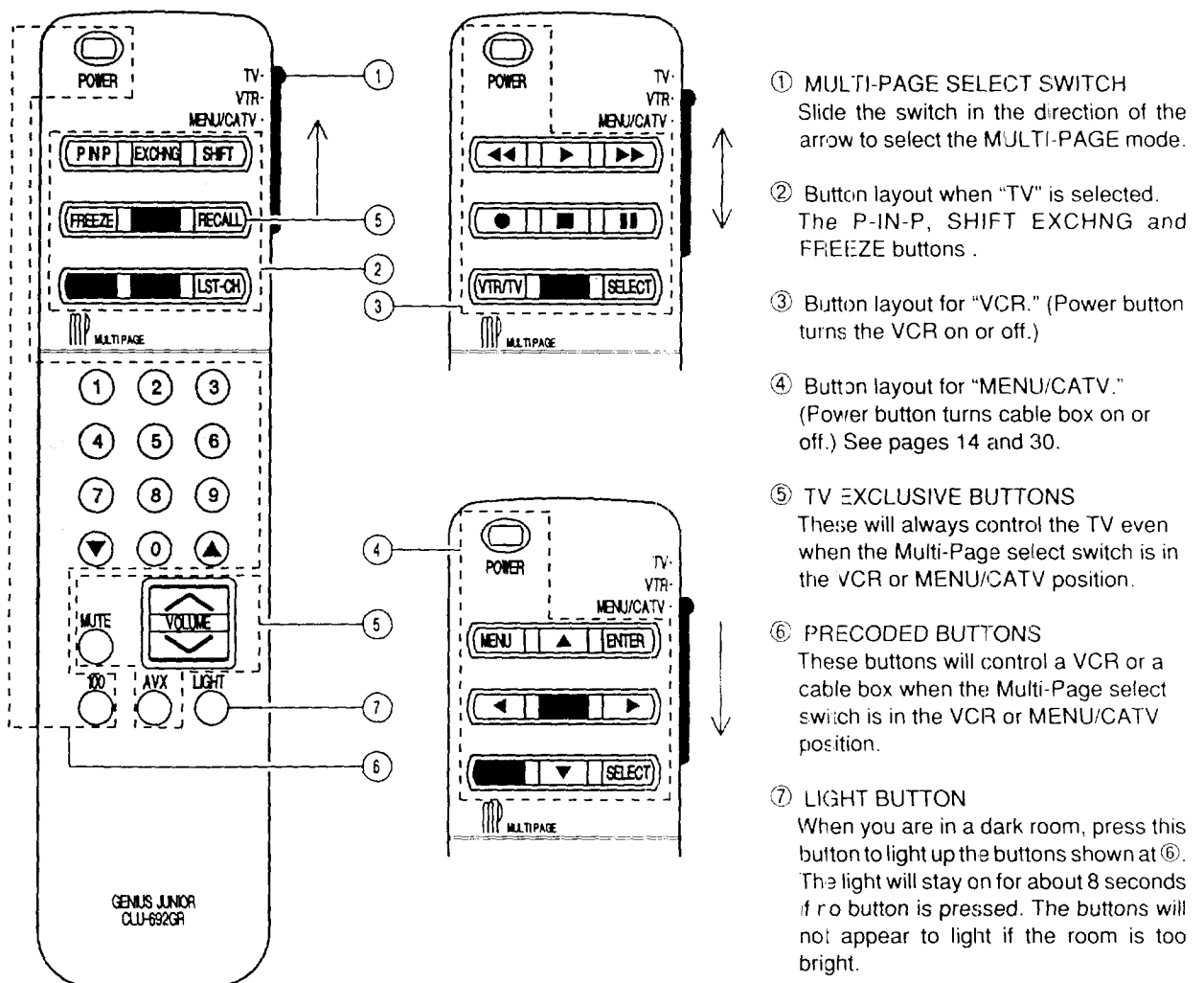

# THE GENIUS REMOTE CONTROL (CLU-681GJ without P-in-P) (MODEL 27AX3B)

In addition to controlling all the functions on your Hitachi Color TV, the new Genius Remote control is designed to operate different types of VCR's (also abbreviated VTR) and different types of CATV converters (cable boxes) with one touch. Basic operation buttons are grouped together in one area. All other controls are separated from them and

arranged in MULTI-PAGE sections, with a display that can be switched to cover any of the three pages. Functions are arranged and properly categorized into windows, making operation simple even when multiple functions are to be controlled.

- To operate your TV, point the Genius remote at the remote sensor of the TV
- To operate your VCR, point the remote at the remote sensor of the VCR.
- To operate your cable box, point the remote at the remote sensor of the cable box.

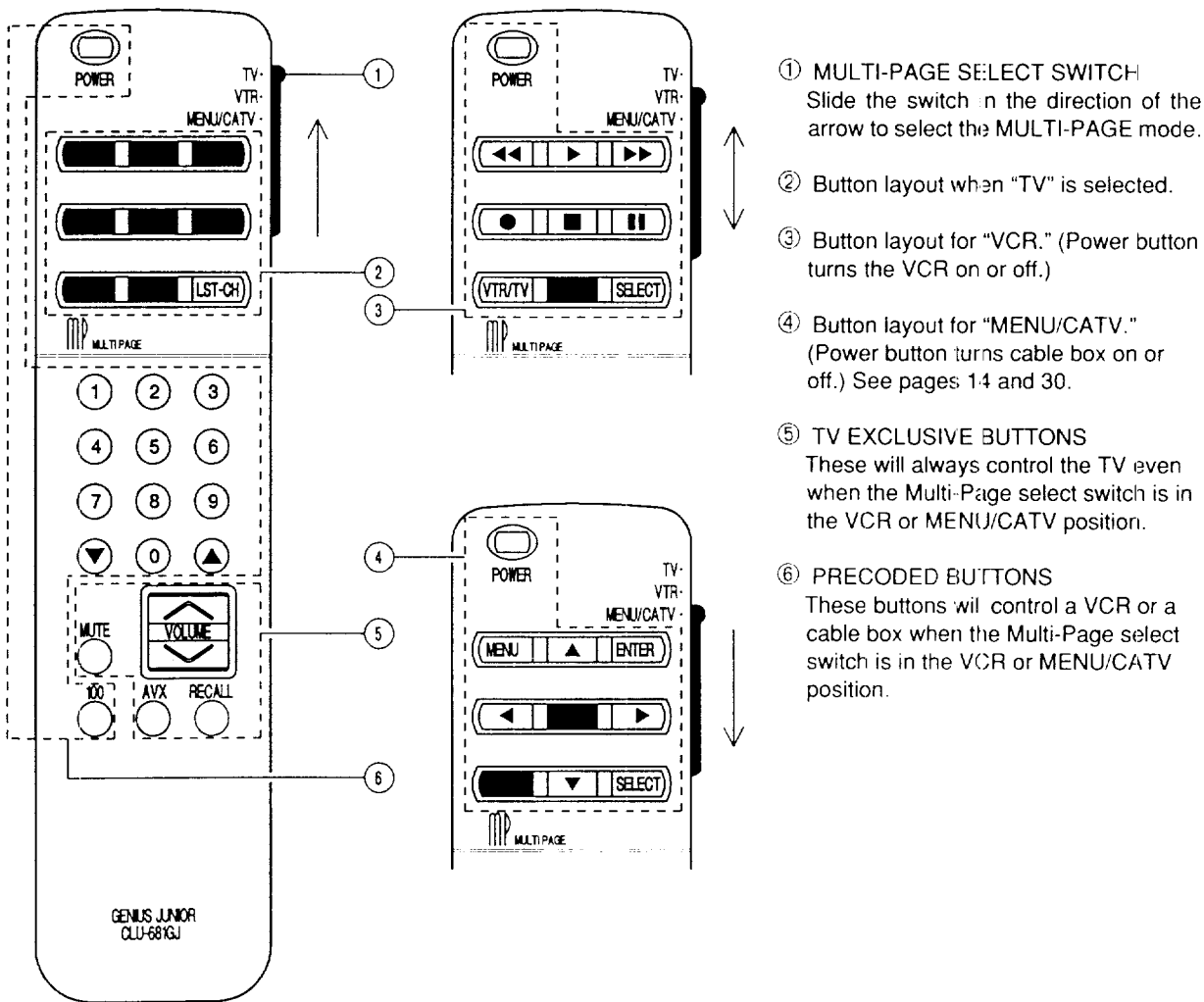

# REMOTE CONTROL CLU-264 (MODEL 27AX0B)

This remote control transmitter operates only on TV functions. To operate your TV, read the description for each remote control button beginning on page 13.

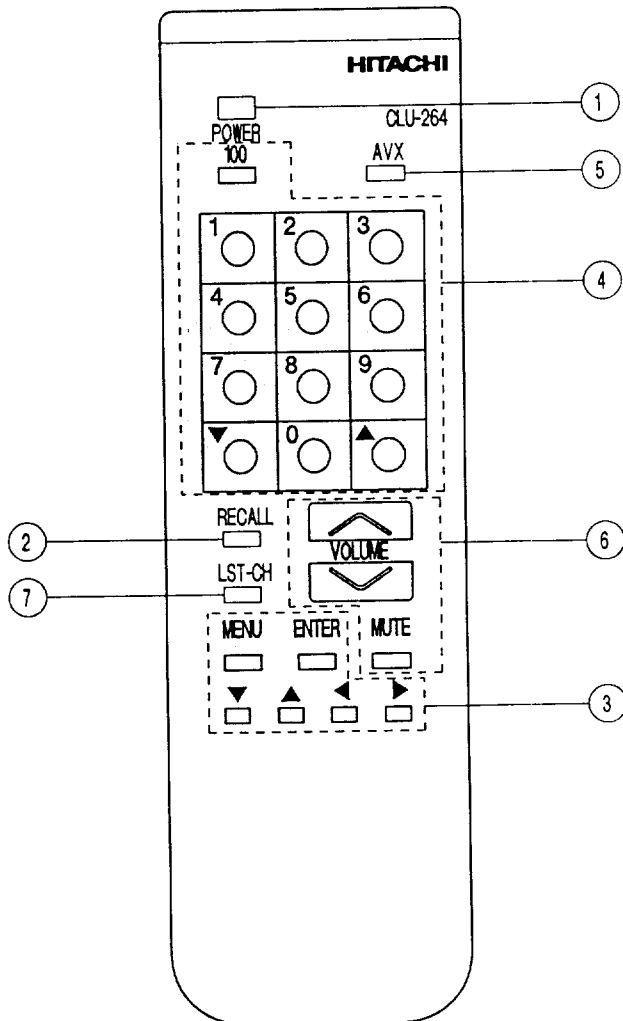

① TV EXCLUSIVE BUTTONS  
These will always control the TV.

# HOW TO USE THE REMOTE TO CONTROL YOUR T.V.

## ① POWER button

Press this button to turn the TV set on or off.

## ② RECALL button

When you want to check the channel being received, or if it has a stereo (ST) or second audio (SA) program, press the "RECALL" button. You can also check the time, and if the ON TIME or OFF TIME has been set. (These functions are explained in the MENU - SET UP section beginning on page 16.)

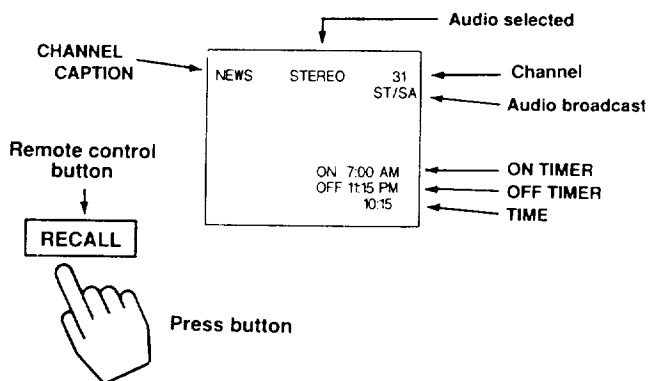

If a video input is used:

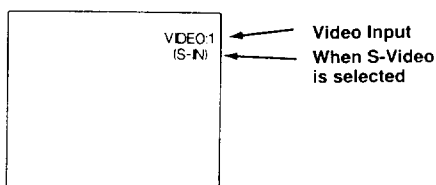

You can also use the "RECALL" button to quickly clear many of the other on-screen displays.

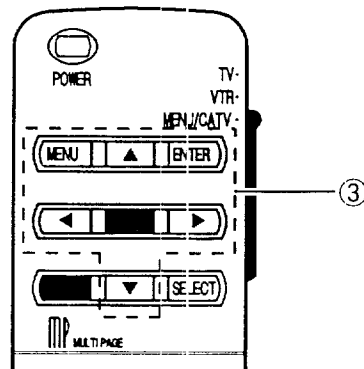
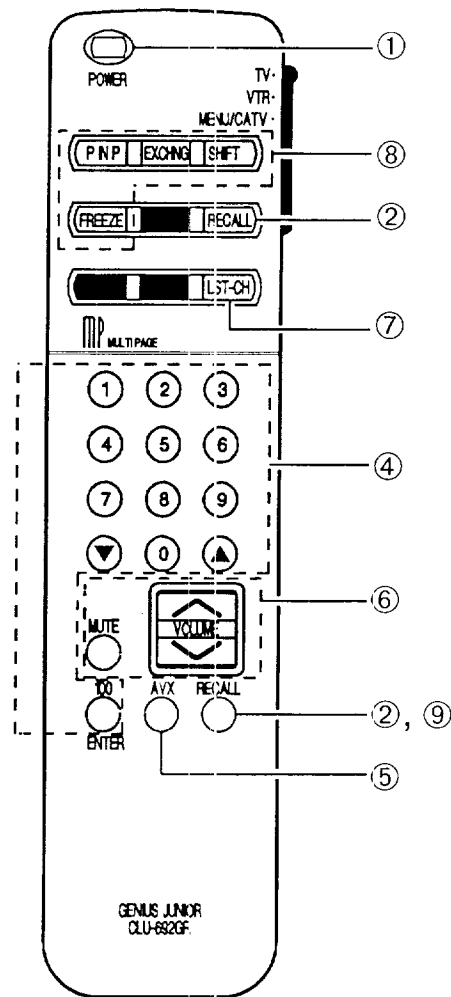

**③ MENU, ENTER, CURSOR buttons**

All the on-screen display features can be set or adjusted by using these buttons.

The "MENU" button will start or exit the on-screen display.

The "CURSOR" buttons will highlight functions or adjust different features.

The "ENTER" button will set features to your preference.

**④ CHANNEL SELECTOR buttons**

Enter two or three numbers to select channels. Enter a "0" first for channels 1 to 9. Use the "100" button for channels 100 and higher.

Channel selection may also be performed by pressing channel up (▲) or down (▼).

**NOTE: THE TV MAY NOT RECEIVE SOME CHANNELS IF YOU ARE NOT IN THE CORRECT AIR/CABLE MODE. SEE PAGE 17.**

**⑤ AVX button**

The AVX (Auxiliary Video) button will select between the antenna signal and the two sets of video input jacks each time the button is pressed.

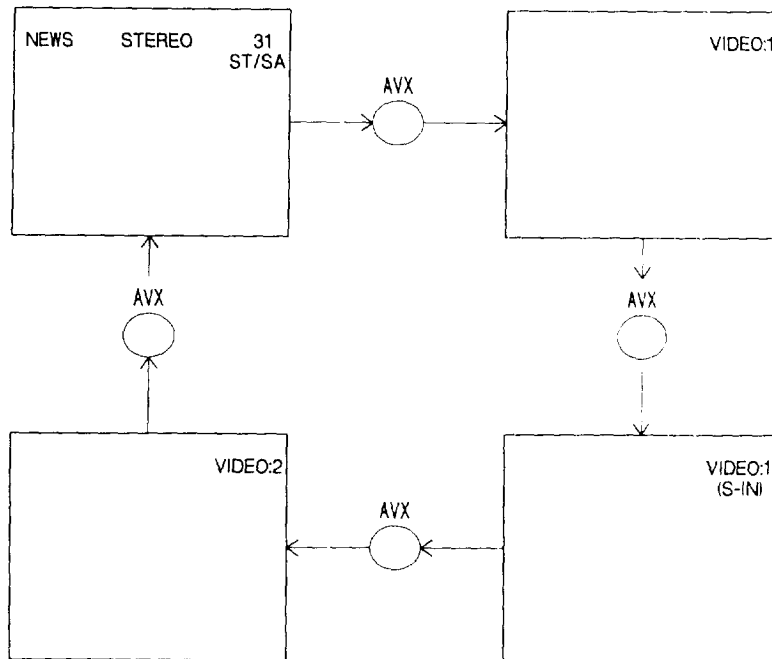

**⑥ VOLUME, MUTE buttons**

Press the "VOLUME" up (▲) or down (▼) button until you obtain the desired sound level.

To turn the sound off instantly to answer the telephone, etc., press the "MUTE:" button. Press the "MUTE" button again or press the "VOLUME" up (▲) button to restore the sound.

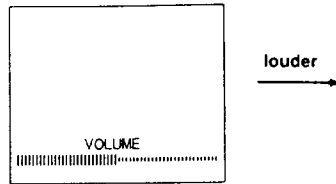

The word "MUTE" will remain displayed if the CLOSED CAPTION feature is turned off.

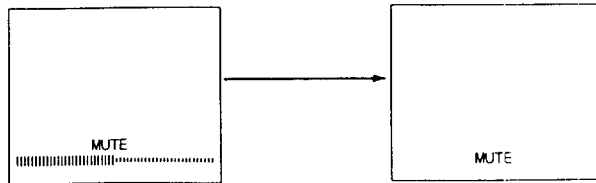

The word "MUTE" will not be displayed if the CLOSED CAPTION feature is on.

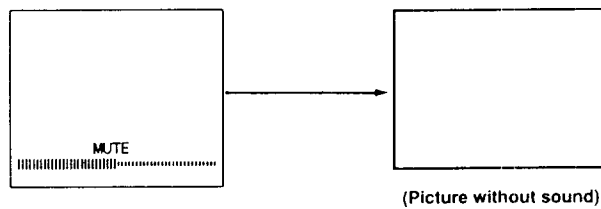

**⑦ LAST CHANNEL (LST-CH) button**

Use this button to select between the last two channels viewed. (Good for watching two sporting events, etc.)

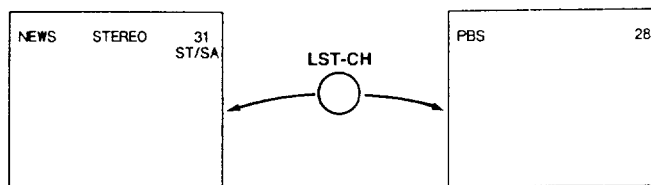

**⑧ PICTURE-IN-PICTURE buttons (For Model 27AX4B only)**

See separate section on pages 27, 28 for a description.

**⑨ LIGHT button (For Model 27AX4B only)**

When you are in a dark room, press this button to light up the volume and channel buttons. The light will stay on for about 8 seconds if no button is pressed. The buttons will not appear to light if the room is too bright.

## **-SET UP- FUNCTIONS (27AX4B, 27AX3B, 27AX0B)**

Press MENU, 1, and ENTER to display 3 of the -SET UP- Functions. There are a total of 8 -SET UP- Functions.

Use the CURSOR UP or DOWN to scroll through the functions. or use the number buttons to highlight a function. The functions highlighted in purple can be selected by pressing ENTER. To exit the on-screen display, press MENU or RECALL.

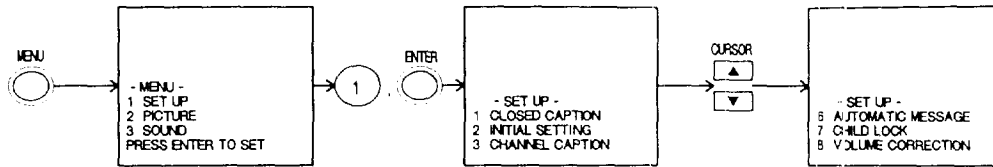

**NOTE:** To see an autodemonstration of the on-screen display and to practice using the remote control, press and hold the POWER button on the TV set for approximately 5 seconds. Press the POWER button on the TV again to end the autodemonstration.

### • CLOSED CAPTION cc

When CLOSED CAPTION is highlighted in purple, press ENTER to see the following display:

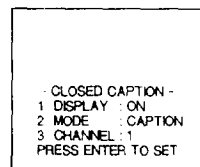

Closed captions are the dialogue, narration, and/or sound effects of a television program or home video which are displayed on the TV screen. Your local TV program guide denotes these programs as cc

DISPLAY: ON/OFF is to turn the cc display on or off.

MODE: CAPTION is for the program you are viewing.

MODE: TEXT is for additional information such as news reports or a TV program guide. This information covers the entire screen and viewing the TV program is not possible. TEXT may not be available with every cc program.

CHANNEL 1 is used for the primary language (usually English).

CHANNEL 2 is sometimes used for a second language (may vary by region).

Use the CURSOR UP or DOWN to highlight the function to change, press ENTER to change the function, and press MENU to exit.

**NOTE:** The word MUTE will not be displayed if the DISPLAY is ON. If you do not have sound, make sure MUTE is not set.



**• INITIAL SETTING**

Select -SET UP- and -INITIAL SETTINGS- when setting your TV up for the first time. Use the CURSOR UP / DOWN or a NUMBER from the remote to highlight the functions desired.

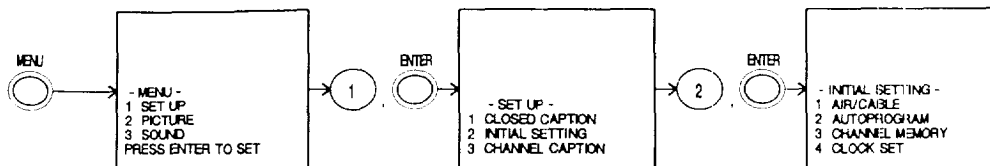

**• AIR / CABLE**

Select this function to change between regular VHF/UHF broadcasting (AIR) and cable TV (CATV1 or CATV2).

Press the CURSOR buttons to highlight the correct AIR/CABLE mode and press MENU to exit.

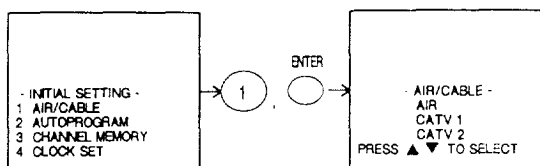

Reception channels for each mode are shown at the right.

Refer to your cable or TV guide for channel identification standards.

If certain CATV channels are poor or not possible in the CATV mode, set the -AIR/ CABLE- select to CATV2.

RECEPTION BAND		
AIR	CATV 1 or CATV 2	
	CATV CHANNEL	Indicated on the screen
VHF 2 ~ 13ch UHF 14 ~ 69ch	VHF 2 ~ 13	2 ~ 13
	Mid band A ~ 1 A-5 ~ A-1	14 ~ 22 95 ~ 99
	Super band J ~ W	23 ~ 36
	Hyper band W+1 ~ W+28	37 ~ 64
	Ultra band W+29 ~ W+84	65 ~ 125

• **AUTOPROGRAM**

This feature will automatically store active TV channels in CHANNEL MEMORY. This will allow you to skip over unused channels when using the CHANNEL UP (▲) or DOWN (▼) buttons.

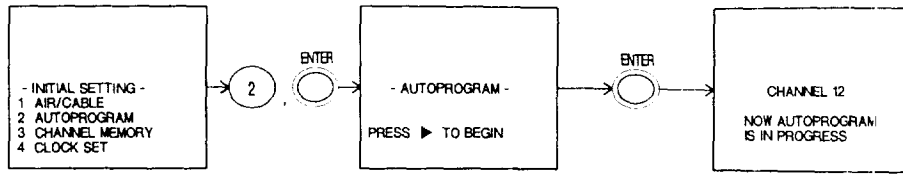

If the MENU button is pressed while the autoprogramming function is engaged, programming will stop.

See CHANNEL MEMORY to add or erase additional channels.

• **CHANNEL MEMORY**

Use this function after AUTOPROGRAM to add or erase additional channels to the remote control CHANNEL ▲, ▼ buttons.

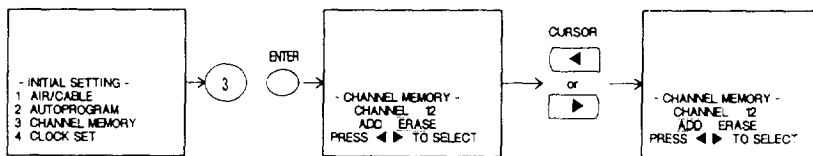

Add or erase additional channels while still in CHANNEL MEMORY using the CHANNEL ▲, ▼ buttons or number buttons and then add or erase using the CURSOR ◀, ▶ buttons.

**• CLOCK SET**

Use the same remote control buttons as shown in previous examples to display the clock setting, press MENU, 1, ENTER, 2, ENTER, 4, ENTER.

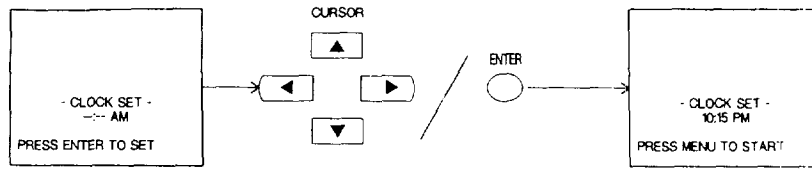

Once the proper time is set (including AM or PM), press MENU to start.

**• CHANNEL CAPTION**

Use this feature to give channel names to up to 24 channels for the antenna source (ABC, PAY1, CMDY, etc.).

To display this function, press MENU, 1, ENTER, 3, ENTER.

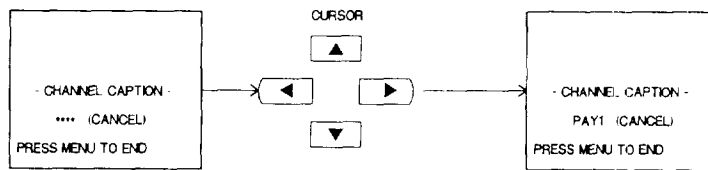

Press the CURSOR ▲, ▼ to select letters

Press the CURSOR ◀, ▶ to change position.

Press CHANNEL ▲, ▼ or the number buttons to select and label additional channels.

Press MENU to exit.

The (\*) represents a blank space.

Select CANCEL to erase a CHANNEL CAPTION.

**• PROGRAM LIST**

This function allows you to view which channels are labeled in CHANNEL CAPTION (NAME), which have been added to CHANNEL MEMORY (SCAN) and which are protected by CHILD LOCK (LOCK). Press MENU, 1, ENTER, 4, ENTER to view.

CH	NAME	SCAN	LOCK
01	----	--	--
02	CBS	ON	--
03	SHOW	ON	ON
04	NBC	ON	--
05	PLBY	--	ON

Press the CURSOR ▲, ▼ to view more channels.  
Press MENU to exit.

**• TIMER SET**

This function will automatically turn the TV on or off.

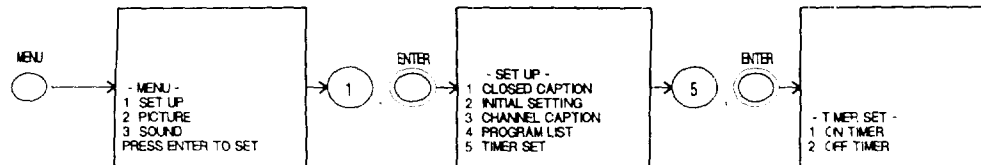

Press 1, ENTER, to select the ON TIMER.

**NOTE:** If the clock has not been set, the display will be for clock setting as shown on page 19.

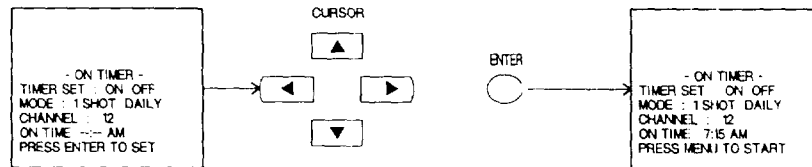

Press the CURSOR ◀, ▶ buttons for TIMER SET: ON or OFF and MODE: 1 SHOT (one time only) or MODE: DAILY (TV will turn on at the same time every day).

Press the number buttons to select the CHANNEL the TV will tune to when the TV automatically turns on.

Press the CURSOR buttons to set the ON TIME.

Press ENTER after each selection. Your choice will appear in "blocked" letters.

Press MENU to start.

Repeat the previous steps to select and set the OFF TIMER.

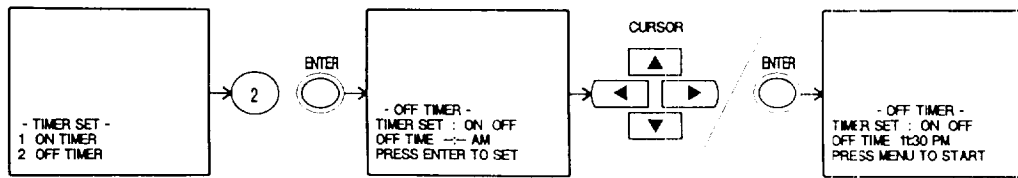

Remember to press ENTER after making selections with the CURSOR buttons.  
Press MENU to start.

**CAUTION:** The OFF TIMER is a one time only operation. Do not try to use your TV as a deterrent when away from home by using both the ON and OFF TIMERS. The OFF TIMER function will not work until you reset it and the next ON TIME (when using the DAILY MODE) will leave the TV set turned on until you press the power button on the TV or remote control to turn it off.

• **AUTOMATIC MESSAGE**

Use this function to set up to two personal messages once a day or one time only. Setting the AUTOMATIC MESSAGE is the same as setting CHANNEL CAPTION and ON TIMER. Press MENU, 1, ENTER, 6, ENTER to get the AUTOMATIC MESSAGE display. (You can also use the CURSOR ▲, ▼ to "scroll" to AUTOMATIC MESSAGE and then select the function.)

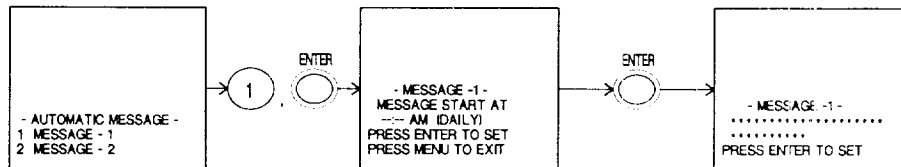

Use the CURSOR ▲, ▼ to select a letter or other character.

Use the CURSOR◀, ▶ to change position

The asterisk (\*) represents a blank space.

When finished with your message press ENTER.

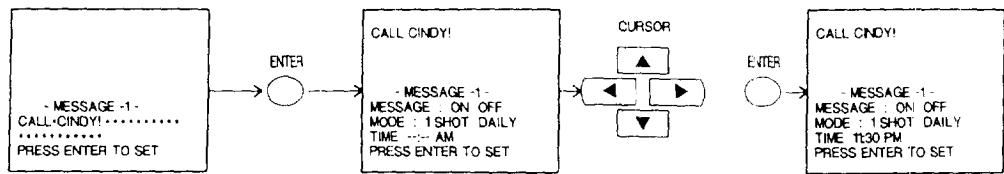

Press the CURSOR and ENTER buttons to set the functions shown in the same way as you set the OFF TIMER. Press MENU to start.

FIVE beeps will be heard when the AUTOMATIC MESSAGE is displayed.

Examples: Use this message function to remember to take daily vitamins, or use the 1 SHOT to remember to call a friend.

**CAUTION:** Do not leave an AUTOMATIC MESSAGE on the TV screen for more than 48 hours at a time. A pattern burn may develop and this is not covered by your warranty. The message can be erased from the TV by pressing RECALL, MUTE, LST-CH, etc.

• **CHILD LOCK**

This function will block out the picture and sound of the selected channel. Press MENU, 1, ENTER, 7, ENTER to display CHILD LOCK.

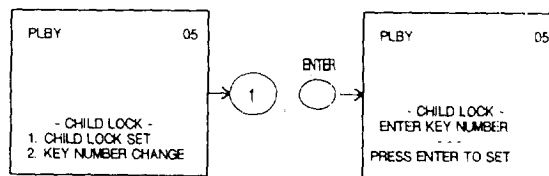

The code to set or cancel CHILD LOCK is a three digit key number. The factory preset key number is 000.

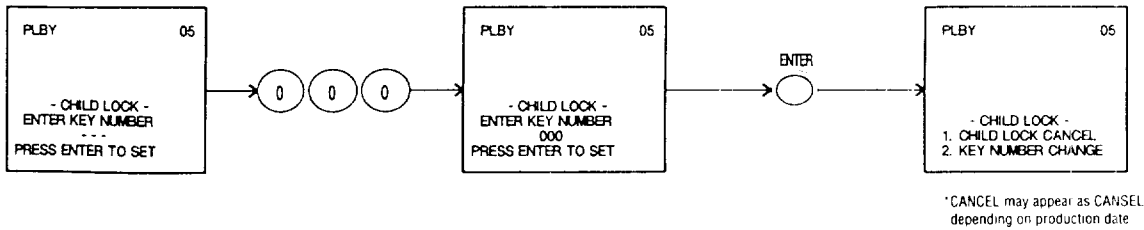

The picture and sound will now be blocked out for this channel. Repeat the same steps to cancel the CHILD LOCK.

To change the key number, select key number change. Enter the old number (factory preset 000 for first time use), then enter a new three digit key number you prefer.

If you forget your key number, use the factory code 777 to erase your key number. This will reset the key number back to the factory preset 000.

#### • VOLUME CORRECTION

Use this function to reduce the volume level of up to four TV channels that sound loud compared to other TV channels. Press MENU, 1, ENTER, 8, ENTER to display VOLUME CORRECTION.

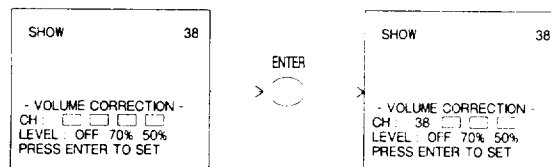

Press the CURSOR ◀, ▶ to select volume level.

Press ENTER to set the volume level.

Press MENU to exit.

## **-PICTURE- FUNCTIONS (27AX4B, 27AX3B, 27AX0B)**

```
- PICTURE PROGRAM -  
1. PREFERENCE  
2. PRESET  
PRESS ENTER TO SET
```

PICTURE PROGRAM is for your preferred settings — contrast, color, etc.

Press MENU, 2, ENTER to display the -PICTURE- PROGRAM functions.

### **• PICTURE PROGRAM**

You can have two settings, PREFERENCE or use the factory PRESET settings.

Press MENU, 2, ENTER to select the PICTURE PROGRAM.

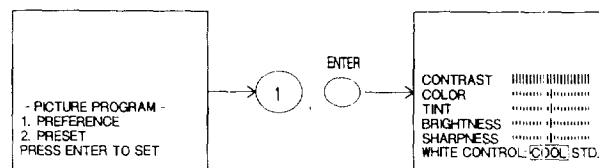

Press MENU, 2, ENTER, 2, ENTER to select PRESET.

Press the CURSOR buttons to select and make adjustments.

**CONTR** — Use this function to change the contrast between black and white levels in the picture. This adjustment will only affect the picture when the PICTURE SETTING AI is OFF. See page 34.

**COLOR** — Use this function to adjust the level of color in the picture.

**TINT** — Use this function to adjust flesh tones so that they appear natural.

**BRIGHT** — Use this function to adjust overall picture brightness.

**SHARP** — Use this function to adjust the amount of fine detail in the picture. This adjustment will only affect the picture when PICTURE SETTING AI is OFF.

**WHITE CONTROL: COOL STD** → Use this function to adjust the white balance (hue) of the picture to your own color preference. When shipped from the factory, this is set to "cool." If you prefer a reddish screen, set to "STD."



# SOUND- FUNCTIONS (27AX4B, 27AX3B, 27AX0B)

Press MENU, 3, ENTER to display the -SOUND- functions.

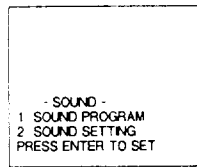

SOUND PROGRAM is for your preferred settings — balance, bass and treble.

SOUND SETTING is used to improve the sound quality.

## SOUND PROGRAM

You can have two sets of settings, PREFERENCE, or use the factory PRESET settings.

Press MENU, 3, ENTER, 1, ENTER to select the SOUND PROGRAM.

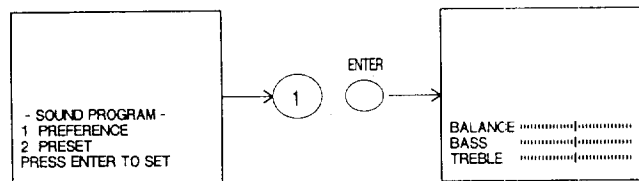

Press the CURSOR buttons to select and make adjustments.

**BALANCE** — This function will control the left, right balance of the TV internal speakers, the AUDIO TO HI-FI output and the surround speakers.

**BASS** — This function controls the low frequency audio to all speakers.

**TREBLE** — This function controls the high frequency audio to all speakers.

• **SOUND SETTING**

Use the sound settings to improve the sound performance of your TV depending on listening conditions.

Press MENU, 3, ENTER, 2, ENTER to display the SOUND SETTING.

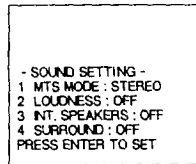

Use the CURSOR ▲, ▼ to select a function.  
Press ENTER to set a function or to turn it on or off.

• **MTS MODE (Multi-Channel Television Sound)** will allow you to select STEREO (a stereo broadcast), SA (second audio) program which may be a secondary language, weather report, etc. or MONO (monaural sound) used when receiving a weak stereo broadcast.

The sources received will be displayed below the channel number. The source you select will be displayed to the left of the channel number. See example below for each selection when both stereo and second audio are received (monaural is always received).

**STEREO selected**

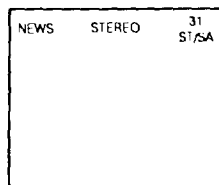

**SA selected**

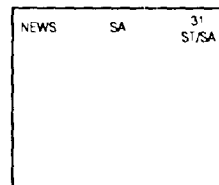

**MONO selected**

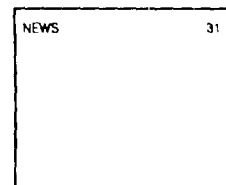

• **LOUDNESS**

This function will improve the quality of both low and high frequency sounds when listening at low volume levels.

• **INT. SPEAKERS**

This function is useful when first setting up the external speakers, or if you prefer to use only speakers from a separate stereo system.

• **SURROUND SOUND STEREO**

Surround sound allows the viewer to enjoy sound which provides a feeling of "presence" from stereo broadcasts and VCR tapes\* recorded with stereo sound.

\*Your play VCR must be a Hi-Fi or stereo unit. See page 32 for stereo VCR connection (27AX3B).

\*Set must be outputting stereo. (See MTS • mode : stereo (above).)

# PICTURE-IN-PICTURE FUNCTIONS (27AX4B ONLY)

## P IN P BUTTON

The Picture-in-Picture feature is convenient when you want to watch more than one program at the same time. You can watch a TV program while viewing a VCR program (TV or tape) and vice versa with this feature.

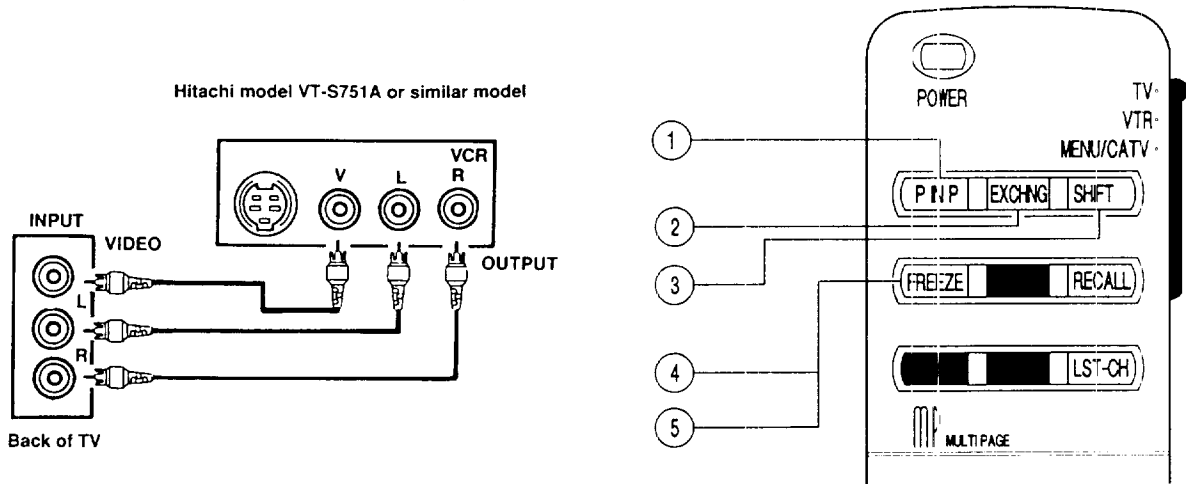

### ① P-IN-P BUTTON:

Press the "P in P" button and a sub-picture appears in one corner of the screen. To remove the sub-picture from the screen, press the button a second time.

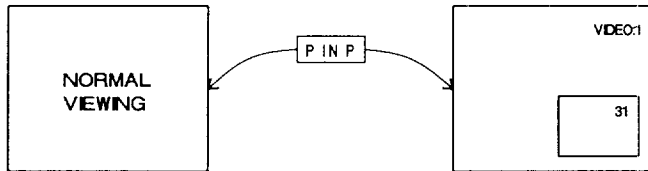

### ② EXCHNG BUTTON:

If you wish to switch what is being shown on the main picture to the sub-picture, press the "EXCHNG" button.

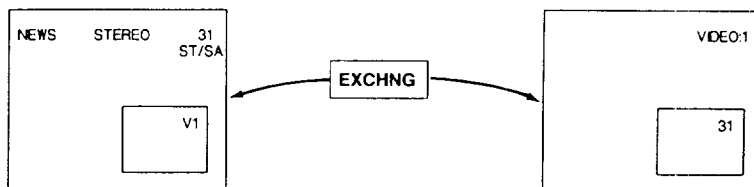

③ **SHIFT BUTTON:**

To move the sub-picture to another corner, press the "SHIFT" button. The sub-picture moves one step counter-clockwise every time the "SHIFT" button is pressed.

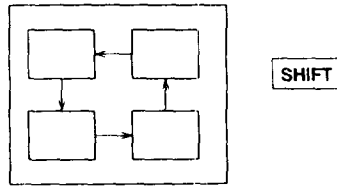

④ **FREEZE BUTTON:**

If you wish to freeze the sub-picture, press the "FREEZE" button. This is convenient when trying to write down the address for a mail order company, recording statistics for a sporting event, etc. To return to motion, press the button again.

⑤ **FREEZE BUTTON WITHOUT A SUB-PICTURE:**

Press this button without a sub-picture to freeze the picture you are currently viewing. Press this button again to return to normal viewing. The EXCHNG picture-in-picture function will not work with this FREEZE function.

**CAUTION:**

A pattern burn may develop if the sub-picture is left in the same corner permanently. If the P-in-P feature is used frequently, occasionally shift the sub-picture to a different corner.

- NOTE:**
1. Only sound from the main picture can be heard.
  2. When the "P in P" button is pressed, the sub-picture will appear in the same position as previously set.
  3. The "FREEZE" function is released when the "EXCHNG" button is pressed.
  4. P in P will not work with a CHILD LOCK channel.

## **USING THE GENIUS REMOTE TO CONTROL VCR FUNCTIONS (FOR MODELS 27AX4B and 27AX3B)**

---

- To operate your VCR, point the Genius remote at the remote sensor of the VCR.

The Genius remote is designed to operate different types of VCR's. You must first program the Genius remote to match the remote system of your VCR (Refer to Table 1 on page 31).

(1) Turn ON your VCR.

(2) Set the Multi-Page select switch on the Genius remote to VCR.

(3) AIM the Genius remote at the front of your VCR.

(4) While holding down the SELECT button, press the button that matches your VCR as shown on page 31. The channels on the VCR will begin changing after 5 seconds when the correct button is pressed. When this happens the Genius Remote control is programmed for your VCR. If the VCR channels do not change after 5 seconds, try a different Genius Remote button.

(5) Release both buttons when the VCR begins to change channels. The precoded VCR buttons will now control your VCR.

### **Notes:**

- If your VCR cannot be operated after performing the above procedure, the codes have not been precoded into the Genius remote control and it will not be able to operate your VCR.
- You will only have to program your remote control to match your VCR once. The remote will remember the codes until you replace the batteries.
- Whenever you install or replace batteries in the Genius remote, you must reprogram the Genius remote to match the remote system of your VCR.
- When operating your TV or a cable box, remember to set the Multi-Page select switch to the proper position.
- Refer to the instruction manual for the VCR to operate buttons exclusively for the VCR.
- Be sure to keep the original remote control for the VCR even if you use the Hitachi Genius remote to control your VCR.

## **USING THE GENIUS REMOTE TO CONTROL CABLE BOX FUNCTIONS (FOR MODELS 27AX4B and 27AX3B)**

- To operate your cable box, point the Genius remote at the remote sensor of the cable box.

The Genius remote is designed to operate different types of cable boxes. You must first program the Genius remote to match the remote system of your cable box (Refer to Table 2 on page 31).

(1) Turn ON your cable box.

(2) Set the Multi-Page select switch on the Genius remote to MENU/CATV.

(3) AIM the Genius remote at the front of your cable box.

(4) While holding down the SELECT button, press the button that matches your cable box as shown on page 31. The channels on the cable box will begin changing after 5 seconds when the correct button is pressed. When this happens the Genius Remote control is programmed for your cable box. If the cable box channels do not change after 5 seconds, try a different Genius Remote button.

(5) Release both buttons when the cable box begins to change channels. The precoded cable box buttons will now control your cable box.

### **Notes:**

- If your cable box cannot be operated after performing the above procedure, the codes have not been precoded into the Genius remote control and it will not be able to operate your cable box.
- You will only have to program your remote control to match your cable box once. The remote will remember the codes until you replace the batteries.
- Whenever you install or replace batteries in the Genius remote, you must reprogram the Genius remote to match the remote system of your cable box.
- When operating your TV or VCR, remember to set the Multi-Page select switch to the proper position.
- Be sure to keep the original remote control for the cable box even if you use the Hitachi Genius remote to control the cable box.

**TABLE 1. VCR Precoded remote controls**

VCR Brand	Press SELECT and this button	VCR Brand	Press SELECT and this button
Canon	6	Pentax	1
Citizen	0	Philco	4/6
Curtis Mathes	2/6	Philips	4/6
Dimensia	2	Pioneer	1
GE	2/6	ProScan	2
Goldstar	0	Quasar	6
Hitachi	1	RCA	1/2
Instant Replay	6	Realistic	6/9/CHANNEL▲
JC Penney	1/6/9	Sanyo	9
JVC	0	Scott	7/8
Kenwood	0	Sears	1/9
Magnavox	4/6	Sharp	CHANNEL ▲
Marantz	9	Sony	5/VOLUME ▲/VOLUME ▼
Marta	0	Sylvania	4/6
Memorex	6	Tashiko	0
MGA	7	Technics	6
Minolta	1	Toshiba	1/8
Mitsubishi	7	Wards	CHANNEL ▲
Montgomery Ward	CHANNEL ▲	Yamaha	9
NEC	9	Zenith	3/5
Panasonic	6		

**TABLE 2. Cable Box Precoded remote controls**

CATV Brand	Press SELECT and this button	CATV Brand	Press SELECT and this button
General Instrument	0/1/2/3/8	Regal	4
Hamlin	4	Scientific Atlantic	6
Jerrold	0/1/2/3/8	Viewstar	9
Pioneer	7	Zenith	5

## EXTERNAL CONNECTIONS

### CONNECTING EXTERNAL AUDIO AMPLIFIER

To control the audio level of an external audio amplifier with the remote transmitter, connect the system as shown below. (Fig. 1)

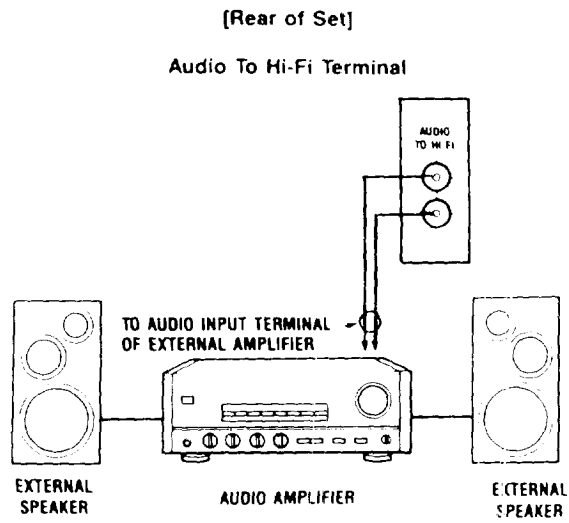

FIG. 1

**NOTE:** To prevent damage to the speaker and distorted sound, set the volume control of the audio amplifier lower and adjust the sound level using the volume control on the remote transmitter of the TV set.



## CONNECTING EXTERNAL VIDEO SOURCES

The exact arrangement you use to connect the Video Cassette Recorder, Video Disc Player and Video Camera to your TV set is dependent on the model and features of each component. Check the Owner's Manual of each component for the location of its video and audio inputs and outputs. The following connection diagrams are offered as suggestions. However, you may need to modify them to accommodate your particular assortment of components and features. For best performance, video and audio cables should be made from coaxial shielded wire.

### Before Operating External Video Source

The input mode is changed every time the AVX button is pressed as shown below. Connect External Video source to the INPUT terminal, then press the AVX button as necessary to view the input source.

#### INPUT MODE SELECTION ORDER

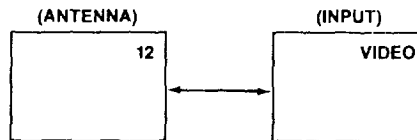

**NOTE:** When TV is set to "VIDEO" and a video signal is not received from VIDEO INPUT JACK on the back panel of the TV (i.e., VCR/ Video Disc Player, etc. is not connected or the video input device is OFF), the screen will be blank gray or blue in color.

## CONNECTING MONAURAL AUDIO VCR or VIDEO DISC PLAYER

- STEP 1** Connect the cable from the VIDEO OUT of the VCR or the Video Disc Player to the INPUT (VIDEO) jack on the TV set. (Fig. 1)
- STEP 2** Connect the cable from the AUDIO OUT of the VCR or the Video Disc Player to the INPUT (MONO)/L (AUDIO) jack. (Fig. 1)
- STEP 3** Press the AVX button to view the program from the VCR or Video Disc Player. The video mode "VIDEO" disappears automatically after approx. 8 seconds.
- STEP 4** Press the AVX button to return to the previous channel.

### STEP 5

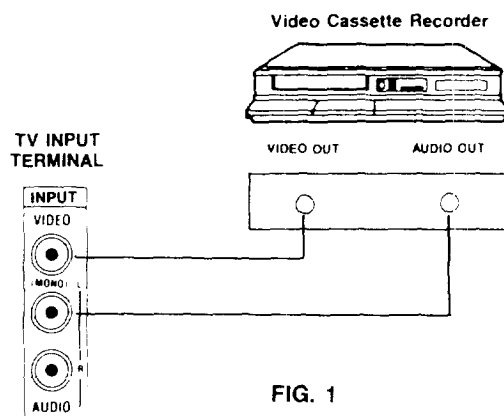
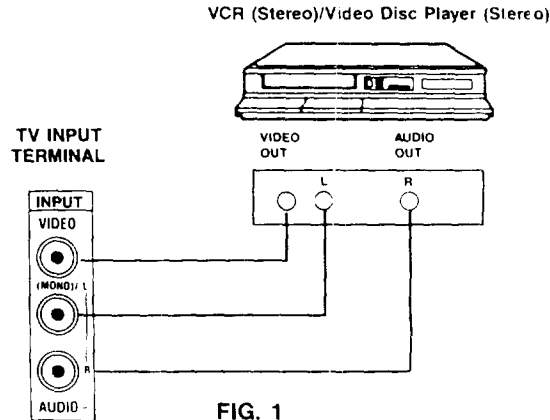

FIG. 1

## CONNECTING STEREO VCR or STEREO VIDEO DISC PLAYER

- STEP 1** → Connect the cable from the VIDEO OUT of the VCR or the Video Disc Player to the "INPUT (VIDEO)" jack on the TV set. (Fig. 1)
- STEP 2** → Connect the cable from the AUDIO OUT "R" of the VCR or the Video Disc Player to the "INPUT (AUDIO/R)" jack (Fig. 1).
- STEP 3** → Connect the cable from the AUDIO OUT "L" of the VCR or the Video Disc Player to the "INPUT (AUDIO/L)" jack (Fig. 1).
- STEP 4** → Press the AVX button to view the program from the VCR or Video Disc Player. The video mode "VIDEO" disappears automatically after approx. 8 seconds.
- STEP 5** → Press the AVX button to return to the previous channel.



## ACCESSORIES PART NUMBERS

For information regarding how to obtain these accessories, please call TOLL FREE 1-800-448-2244 for your nearest Hitachi Authorized Parts Distributor in the continental United States. For Alaska and Hawaii, please contact the nearest Hitachi Regional office.

PART NAME	PART NO.	ILLUSTRATION
GJ III Genius Jr. III CLU-692GR 27AX4B	2573922	<div style="display: flex; justify-content: space-around; font-size: small;"> <span>CLU-692GR</span> <span>CLU-681GJ</span> <span>CLU-264</span> </div>
GJ II Genius Jr. II CLU-681GJ 27AX3B	2573786	
TV Only CLU-264 27AX0B	2573912	
TELEVISION STAND SP292B (Black Color) (Not included, order separately)	H410253 (Black)	
TELEVISION STAND SP291G (Grey Color) (Not included, order separately)	H410252 (Grey)	

**CAUTION:** The television stands Model SP291G and Model SP292B are designed for use only with Hitachi TV Models 27AX4B, 27AX3B, 27AX0B. Use with other television equipment may result in instability, causing possible injury.

## TRANSMITTER BATTERY INSTALLATION AND REPLACEMENT

Open the battery cover of the Remote transmitter by pushing the notched part of the cover with your finger.

- a) Push the batteries towards the spring and lift them out.
- b) Replace old batteries with two new "AA" size (SUM-3) batteries or equivalent.
- c) Match the (+) and (-) marks in the battery compartment.
- d) Replace the cover.

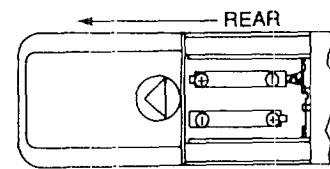

## CAUTIONS





1. If your television set is to remain unused for a long period of time, for instance, when you go on a vacation, unplug the television set from the wall outlet.
2. Do not subject the Remote transmitter to shocks such as dropping it on the floor, etc. Precision parts may be damaged.
3. Do not allow the Remote transmitter to become wet and avoid placing it in areas of high humidity. Don't leave it on or near a heater. Excess heat or moisture may cause the unit to cease operation.
4. If the batteries become exhausted, Remote control operation may become erratic or stop altogether. Replace the old batteries with two fresh "AA" (SUM-3) types.

## NOTES

1. When the power button is set to OFF, the OFF TIMER is released.
2. The channel No. indication, volume indication and OFF TIMER indication are not displayed simultaneously.
3. To operate your TV, point the Remote transmitter at the remote sensor of the TV.

# TROUBLESHOOTING

## RECEPTION PROBLEMS (EXTERNAL TO THE TV)

	<ul style="list-style-type: none"> <li>• <b>IGNITION NOISE:</b> Black spots or horizontal streaks may appear, picture may flutter or drift. Usually caused by interference from automobile ignition systems, neon lamps, electrical drills and other electrical appliances.</li> </ul>
	<ul style="list-style-type: none"> <li>• <b>GHOSTS:</b> Ghosts are caused by the television signal following two paths. One is the direct path and the other is reflected from tall buildings, hills or some other objects. Changing the direction or position of the antenna may improve reception. Ghosting may also be caused by defects in the antenna system such as unshielded leads or connecting several sets to the same antenna without using multiple antenna couplers.</li> </ul>
	<ul style="list-style-type: none"> <li>• <b>SNOW:</b> If your receiver is located in the fringe area of a television station where the signal is weak, your picture may be marred by the appearance of small dots. When the signal is extremely weak, it may be necessary to install a special antenna to improve the picture.</li> </ul>
	<ul style="list-style-type: none"> <li>• <b>RADIO FREQUENCY INTERFERENCE:</b> The interference produces moving ripples or diagonal streaks, and in some cases, causes loss of contrast in the picture.</li> </ul>

## CHECK HERE BEFORE CALLING FOR SERVICE

SYMPTOMS	CHECK THESE ITEMS AND TRY THESE ADJUSTMENTS										
	1	2	3	4	5	6	7	8	9	10	11
No picture, no sound	•	•	•	•	•	•	•	•	•	•	•
Sound OK, picture poor	•			•	•	•	•	•	•	•	•
Picture OK, sound poor	•			•	•	•	•	•	•	•	•
Picture blurred	•			•	•	•	•	•	•	•	•
Lines or streaks in picture				•	•	•	•	•	•	•	•
Poor reception on some channels				•	•	•	•	•	•	•	•
Picture rolls vertically				•	•	•	•	•	•	•	•
No color	•			•	•	•	•	•	•	•	•
Poor color	•			•	•	•	•	•	•	•	•

# SPECIFICATIONS

## Features:

- Super Fine Quality  
600 Lines Horizontal Resolution
- Dark Tint Picture Tube (27AX4B and 27AX3B)
- Genius Remote (27AX4B and 27AX3B)  
Controls many VCR brands and cable boxes
- Full Function Menu On-Screen Display
- Full Set of Input Jacks, including S-Video  
(27AX4B and 27AX3B)
- Closed Caption Decoder
- Picture-in-Picture (27AX4B)
- Comb Filter, Wide-Band Video-Amp and White Control
- MTS (Multi-Channel Television Sound) Stereo  
Broadcast Reception
- Surround Sound

**Screen Size:** 27V (27 inches measured diagonally)

## Inputs:

- Power input ..... AC 120V, 60 Hz
- Power consumption ..... 116W
- Power consumption (maximum) ..... 155W
- Antenna input impedance ..... 75Ω
- Channel coverage ..... 181 ch.  
VHF Band ..... 2~13  
UHF Band ..... 14~69  
CATV Mid Band ..... A-5~A-1  
A-I  
Super Band ..... J-W  
Hyper Band ..... W+1~W+28  
Ultra Band ..... W+29~W+84
- Video ..... 1.0Vp-p, 75Ω
- S-Video  
Luminance (Y) ..... 1.0Vp-p, 75Ω  
Chrominance (C) ..... 0.286Vp-p, 75Ω
- Audio input impedance ..... 47kΩ  
Average input level ..... 470mVrms  
Maximum input level ..... 940mVrms

## Outputs:

- Video ..... 1.0Vp-p, 75Ω
- Audio (fixed) ..... 470mVrms, 1kΩ

## Dimensions:

	<b>27AX4B</b>	<b>27AX3B</b>
• Height (in.)	22 <sup>7</sup> / <sub>8</sub>	22 <sup>7</sup> / <sub>8</sub>
• Width (in.)	27 <sup>1</sup> / <sub>16</sub>	27 <sup>1</sup> / <sub>16</sub>
• Depth (in.)	20 <sup>3</sup> / <sub>16</sub>	20 <sup>3</sup> / <sub>16</sub>
• Weight (lbs.)	89.0	89.0
	<b>27AX0B</b>	
• Height (in.)	22 <sup>7</sup> / <sub>8</sub>	
• Width (in.)	27 <sup>1</sup> / <sub>16</sub>	
• Depth (in.)	20 <sup>3</sup> / <sub>16</sub>	
• Weight (lbs.)	88.0	

**NOTE:** Due to improvements, specifications in this operating guide are subject to change without notice.

# HITACHI

Hitachi Home Electronics (America), Inc.  
Hitachi Sales Corporation of Hawaii

## LIMITED WARRANTY

Hitachi Home Electronics (America), Inc. and Hitachi Sales Corporation of Hawaii ("Hitachi") warrant this component in duration as stated below

### COLOR TELEVISION

#### Conditions of Hitachi Limited Warranty

Hitachi Color Television Products are warranted to be free of defects in parts and workmanship at the time of purchase by the original owner. If this product is found to be defective, Hitachi will repair or replace defective parts at no charge to the original owner. Parts used for replacement are warranted for the remainder of the original Limited Warranty period. For 1 year from the date of original purchase, Hitachi will provide labor for the repair or replacement of defective parts without charge, subject to the following conditions:

1. Owner must provide verification of the date of purchase when requesting Limited Warranty Service. (Dated Sales Receipt Required)
2. All repairs must be performed by a Hitachi Authorized Service Facility.
3. On 19" and larger color television sets only, the labor service during this 1 year period includes (at Hitachi's option) either in-home repair or free pick up and delivery. During the remainder of the duration of the foregoing limited warranties, Hitachi will (at its option) repair or replace any defective component parts or transistors for only the labor charge for such repair or replacement.

- 10 YEARS TRANSISTOR
- 2 YEARS PARTS • 1 YEAR LABOR

For information concerning repairs, operation, technical assistance or for referral to the location of your nearest Authorized Service Facility or Parts Distributor, call 1-800-HITACHI (1-800-448-2244) Continental U.S.

#### HITACHI HOME ELECTRONICS (AMERICA), INC.

3890 Steve Reynolds Blvd.  
Norcross, GA 30093  
Tel: 404-279-5600

#### HITACHI SALES CORPORATION OF HAWAII

3219 Kcapaka St.  
Honolulu, HI 96819  
Tel: 808-836-3621

(Continued on reverse side)

## Warranty Limitations

The Limited Warranty provided by Hitachi does not cover

- A. Antennas, cabinet, cabinet parts, knobs, batteries, and accessories.
- B. Cartage or shipment to or from an authorized Hitachi Service Facility or in-home service (other than the first year in-home service for 19" and larger color television sets).
- C. New products purchased or service performed outside of the continental United States or its possessions.
- D. Uncrating, set-up, or installation, adjustments of customer operated controls.
- E. Repairs or replacement parts supplied by other than an authorized Hitachi Service Facility.
- F. Any defect, malfunction, or failure caused by or resulting from improper service.
- G. Maintenance or repair, or from abuse, neglect, accident or any other cause beyond the control of Hitachi.
- H. Any product whose serial number shall have been removed, altered, replaced, defaced or rendered illegible.
- I. Product used for a commercial or industrial purpose.

This limited warranty is made only to the original consumer purchaser of this Hitachi color television set and is effective only upon presentation of evidence of provable date of purchase.

NO PERSON, AGENT, DISTRIBUTOR, DEALER, SERVICE FACILITY, OR COMPANY IS AUTHORIZED TO CHANGE, MODIFY, OR AMEND THE TERMS OF THIS LIMITED WARRANTY IN ANY MANNER OR FASHION WHATSOEVER. EXCEPT AND TO THE EXTENT PROVIDED IN THIS LIMITED WARRANTY, HITACHI MAKES NO EXPRESS WARRANTY REGARDING THIS HITACHI PRODUCT. FURTHER, ALL IMPLIED WARRANTIES RELATING TO ANY PORTION OF THIS PRODUCT, INCLUDING ANY WARRANTY OF MERCHANTABILITY OR FITNESS FOR A PARTICULAR PURPOSE, ARE LIMITED TO TEN YEARS FOR TRANSISTORS, TWO YEARS FOR PARTS AND ONE YEAR FOR LABOR, THE DURATION OF THE APPLICABLE EXPRESS WARRANTY CONTAINED ABOVE. HITACHI SHALL NOT BE LIABLE TO THE PURCHASER OR TO ANY OTHER PERSON FOR ANY INCIDENTAL OR CONSEQUENTIAL DAMAGES OR LOSS OF PROFIT OR PRODUCT RESULTING FROM ANY DEFECT IN OR MALFUNCTION, OR FAILURE OF THIS HITACHI PRODUCT. SOME STATES DO NOT ALLOW LIMITATIONS ON HOW LONG AN IMPLIED WARRANTY LASTS, OR THE EXCLUSION OF INCIDENTAL OR CONSEQUENTIAL DAMAGES, SO THE ABOVE LIMITATIONS MAY NOT APPLY TO YOU. THIS WARRANTY GIVES YOU SPECIFIC LEGAL RIGHTS AND YOU MAY ALSO HAVE OTHER RIGHTS WHICH VARY FROM STATE TO STATE.

TATIONS ON HOW LONG AN IMPLIED WARRANTY LASTS, OR THE EXCLUSION OF INCIDENTAL OR CONSEQUENTIAL DAMAGES, SO THE ABOVE LIMITATIONS MAY NOT APPLY TO YOU. THIS WARRANTY GIVES YOU SPECIFIC LEGAL RIGHTS AND YOU MAY ALSO HAVE OTHER RIGHTS WHICH VARY FROM STATE TO STATE.

### Important Notice:

Retain your sales receipt for warranty purposes. Please complete the section below for your records as it may be needed in the event of loss. Attach sales receipt to this card for your protection.

# HITACHI

## *Color Television Limited Warranty Registration*

(Retain this limited warranty card for your records)

Model No \_\_\_\_\_

Serial No \_\_\_\_\_

Date of Purchase \_\_\_\_\_

Dealer Name \_\_\_\_\_

Dealer Address \_\_\_\_\_

City \_\_\_\_\_

State \_\_\_\_\_

Zip \_\_\_\_\_