

OPERATING GUIDE & WARRANTY

The Zenith logo is a stylized, bold, italicized font with a lightning bolt effect, set against a dark background.

THE QUALITY GOES IN BEFORE THE NAME GOES ON®

**¡Aviso para nuestros
clientes de habla hispana:
consulte la información que
aparece al final de este manual!**

SYSTEM 3
Direct-View Receiver/Monitor
MTS Stereo Audio with
SEq & Surround Sound



*recycled paper
50 percent*

**Return the Product Registration
Card, and your TV could be free!**



WARNING

**RISK OF ELECTRIC SHOCK
DO NOT OPEN**



WARNING: TO REDUCE THE RISK OF ELECTRIC SHOCK DO NOT REMOVE COVER (OR BACK). NO USER SERVICEABLE PARTS INSIDE. REFER TO QUALIFIED SERVICE PERSONNEL.

TO PREVENT FIRE OR SHOCK HAZARDS, DO NOT EXPOSE THIS PRODUCT TO RAIN OR MOISTURE.



The lightning flash with arrowhead symbol, within an equilateral triangle, is intended to alert the user to the presence of uninsulated "dangerous voltage" within the product's enclosure that may be of sufficient magnitude to constitute a risk of electric shock to persons.



The exclamation point within an equilateral triangle is intended to alert the user to the presence of important operating and maintenance (servicing) instructions in the literature accompanying the appliance.

Safety Tips

Refer to the "Safety Tips" booklet that came with your product for important safety considerations.

Note to Cable TV System Installer

This reminder is provided to call the cable TV system installer's attention to Article 820-40 of the NEC that provides guidelines for proper grounding and, in particular, specifies that the cable ground shall be connected to the grounding system of the building, as close to the point of the cable entry as practical.

Power-Cord Polarization

This product is equipped with a polarized alternating-current line plug (a plug having one blade wider than the other.) This plug will fit into the power outlet only one way. This is a safety feature. If you are unable to insert the plug fully into the outlet, try reversing the plug. If the plug should still fail to fit, contact your electrician to replace your obsolete outlet. Do not defeat the safety purpose of the polarized plug.

CAUTION

To prevent electric shock, match wide blade of plug to wide slot, fully insert.

ATTENTION

Pour éviter les chocs électriques, introduire la lame la plus large de la fiche dans la borne correspondante de la prise et pousser jusqu'au fond.

CONTENTS

INTRODUCTION	
Welcome	ii
Installation Considerations	ii
CONNECTIONS FOR YOUR TV	
Connection Center on Back of TV	1-1
Step 1. Make Basic Connection to TV	1-2
Step 2. Make VCR Connections to TV	1-3
Step 3. Make Surround Sound Connections to TV	1-3
Step 4. Make Audio Connection to Stereo Amplifier ...	1-4
THE FIRST TIME YOU OPERATE YOUR TV	
Step 1. Connect the Power	2-1
Step 2. Select Your Language	2-1
Step 3. Select Your Viewing Source	2-1
Step 4. Use Auto Program	2-1
Step 5. Set the Clock	2-2
Step 6. Use Other Options	2-2
GETTING TO KNOW YOUR TV	
Typical Control Panel	3-1
Sleep Timer	3-1
On/Off Timer	3-2
REMOTE CONTROL MODEL MBR3420/3430	
Introduction	4-1
Choosing Operating Mode	4-1
TV Operations	4-2
VCR Operations	4-3
Cable-TV Operations	4-4
Preparation for Use	4-5
Installing Batteries	4-5
Programming Brand Codes	4-6
TV, VCR and Cable-TV Brand Codes	4-7
QUICK REFERENCE TO ON-SCREEN MENUS	
Available Menus	5-1
Basic Menu Operation	5-1
Menu Operation Example	5-2
SOURCE MENU	
Source Selection	6-1
Source Identification	6-1
SETUP MENU	
Auto Program	7-1
Ch. (Channel) Add/Del	7-1
Ch. (Channel) Labels	7-2
Tuning Band	7-2
Auto Tuning	7-3
Clock Set	7-3
Captions	7-4
Language	7-4
AUDIO MENU	
Bass	8-1
Treble	8-1
Balance	8-1
Audio	8-1
SEQ (Spatial Equalization)	8-1
VIDEO MENU	
Contrast	9-1
Brightness	9-1
Color	9-1
Tint	9-1
Sharpness	9-1
Picture Pref. (Preference)	9-1
PIP MENU (SOME MODELS)	
PIP Source	10-1
PIP Color	10-1
PIP Tint	10-1
PIP CONNECTIONS AND OPERATION (SOME MODELS)	
Introduction	11-1
Basic Picture-In-Picture Connections	11-1
Optional Picture-In-Picture Connection	11-2
Selecting Main Picture and PIP Insert Sources	11-3
Picture-In-Picture Functions	11-3
MAINTENANCE AND TROUBLESHOOTING	
Caring for Your TV	12-1
Extended Absence	12-1
TV Picture Interference	12-1
Before Calling for Service	12-2
Product Registration Card	
Recommended Accessories for Your Television	
Aviso para nuestros clientes de habla hispana	
Your Zenith Warranty	

HOW TO USE YOUR OPERATING GUIDE

This operating guide describes a family of TV models. Some models have features that are not provided on other models, such as Picture-In-Picture. Different control panels and remote controls may be used from model-to-model. Refer to the applicable sections of this operating guide for the features and items provided with your TV.

INTRODUCTION

WELCOME

Welcome into the family of Zenith Color Television owners. This guide provides instructions on how to operate your new TV. It is supplemented by a booklet containing Safety Tips. We urge you to read these publications carefully so that you will receive full enjoyment from your new Zenith TV for many years to come.

Your new Zenith TV has been designed and built to give you the very best in quality, features and performance. There are many regional Zenith distributors and thousands of distributor-approved Zenith service centers throughout the U.S., Canada and Mexico who can attend promptly and effectively to ordinary service needs.

If you should have an unusual performance or service problem that cannot be satisfactorily resolved by your distributor-approved Zenith service center, contact the regional Zenith distributor in your area, or write:

Zenith Electronics Corporation
Customer Service Department
1000 Milwaukee Avenue
Glenview, Illinois 60025-2493
Telephone: (847) 391-8752
Mon-Fri, 8:00 a.m. - 4:30 p.m. Central Time

Send the model number, serial number, and date of purchase or original installation, with a full explanation of the problem and the service history. We will welcome the opportunity to look into your specific question or problem and to be of assistance in resolving it promptly.

The model and serial numbers of your new TV are located on the back of the TV cabinet. For your future convenience and protection, we suggest that you record these numbers here:

Model No. _____

Serial No. _____

INSTALLATION CONSIDERATIONS

Before you install your TV...



Ventilation — Proper ventilation keeps your TV running cool. Air circulates through perforations in the back and bottom of the cabinet. Do not block these vents or you will shorten the life of your TV.



Power Source — Your TV is designed to operate on normal household current, 120 volt 60 Hertz AC. Do not attempt to operate it on DC current.



Power Cord — Your power cord has a polarized plug as required by Underwriters' Laboratories. It has one regular blade and one wide blade and fits only one way into a standard electrical outlet. If the blades will not enter either way, your outlet is very old and non-standard. A new outlet should be installed by a qualified electrician.



Safe Operation — Your TV is manufactured and tested with your safety in mind. However, unusual stress caused by dropping or mishandling, exposure to flood, fire, rain or moisture, or accidental spilling of liquids into the TV, can result in potential electrical shock or fire hazards. If this happens, have your TV checked by a service technician before using it again.

Please read and observe each safety point in the "Safety Tips" folder when installing and using your TV.

FIXED PATTERN DISPLAY CAUTION — If you use your TV for video games, teletext or other fixed displays, avoid setting the BRIGHTNESS control for an excessively bright picture. A bright, fixed pattern, if used for long periods of time, can result in a permanent imprint on the TV picture tube. You can reduce this possibility by alternating the use of the fixed pattern display with normal TV picture viewing, by turning down the CONTRAST control for sustained fixed pattern use, and by turning off the fixed pattern display when not in use.

CONNECTIONS FOR YOUR TV

CONNECTION CENTER ON BACK OF TV

ANTENNA/CABLE

Jacks for 75-ohm antenna-type connections to your TV. Attach your antenna, cable-TV line or VCR to this jack.

VIDEO 1 IN or VIDEO 2 IN
Jacks for baseband audio and video (A/V) input from a VCR or other component.

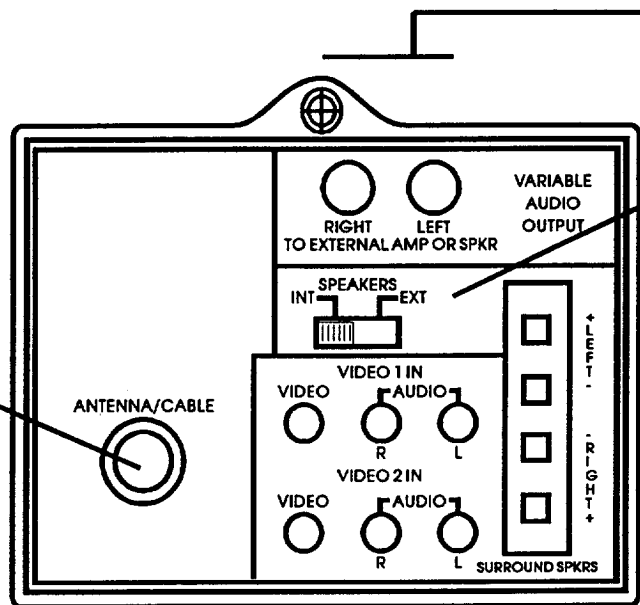

VARIABLE AUDIO OUTPUT
Standard phono jacks for output to the customer's audio amplifier.

This output is always present regardless of the position of the SPEAKERS switch.

SPEAKERS EXT/INT

EXT: TV's speakers are off.
INT: TV's speakers are on.

SURROUND SPKRS

Terminals
Connections for output to optional surround sound speakers.

CONNECTIONS FOR YOUR TV

STEP 1. MAKE BASIC CONNECTION TO TV

Select the hook up that best fits your needs.

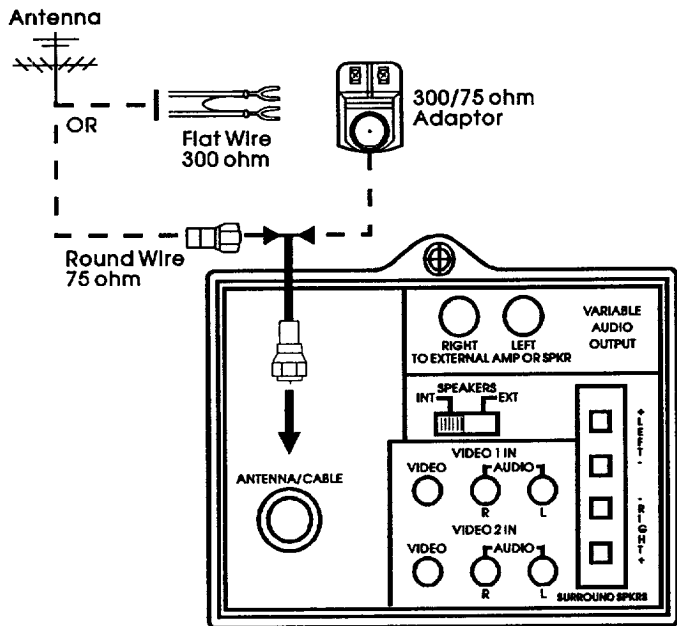

Antenna Direct to TV

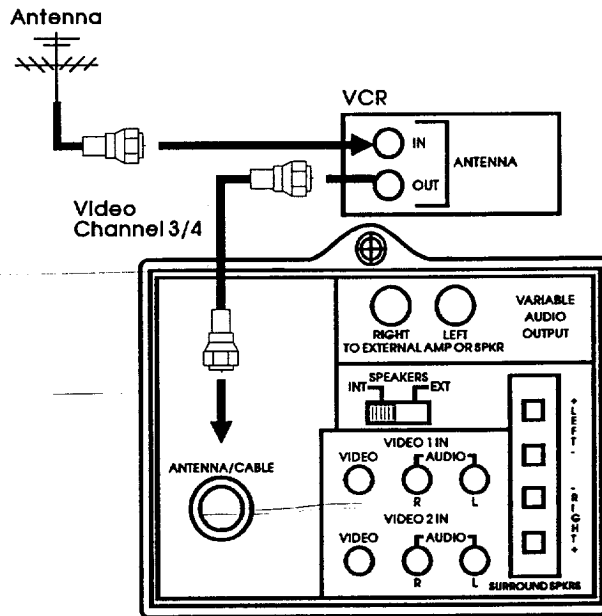

Antenna Through VCR to TV

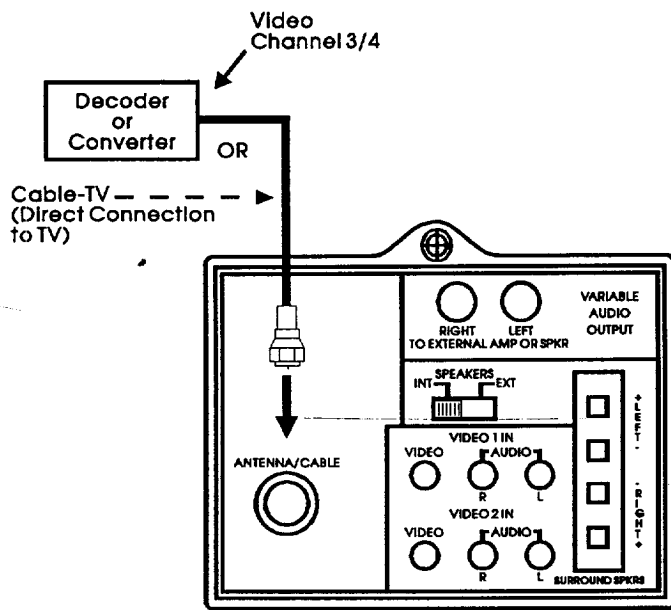

Cable Direct to TV

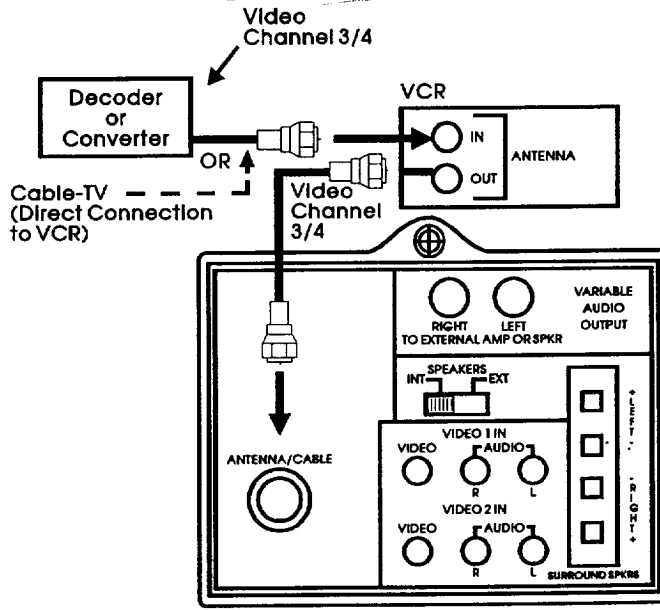

Cable Through VCR to TV

(continued on next page)

CONNECTIONS FOR YOUR TV

STEP 2. MAKE VCR CONNECTIONS TO TV

If you have a stereo VCR, you must make either of the A/V connections shown below in order to hear stereo sound while playing a tape.

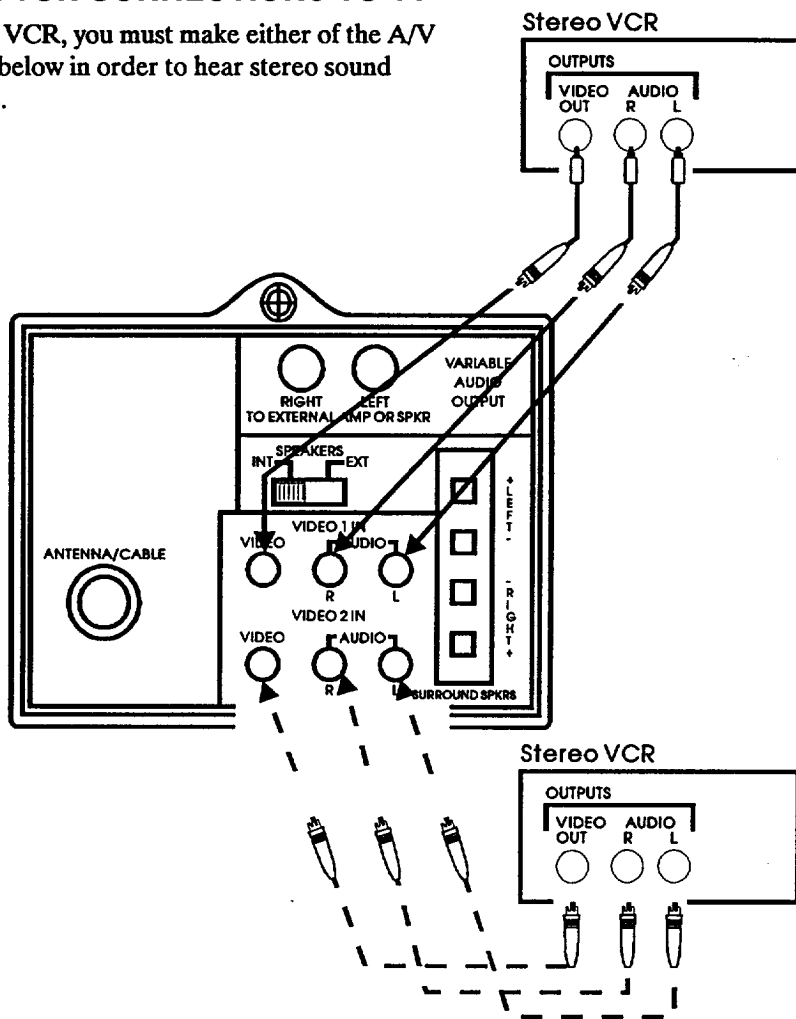

This is the VCR connection you must make if your TV has Picture-In-Picture and you wish to use this feature.

Connections for second stereo VCR or alternate connections for first VCR.

STEP 3. MAKE SURROUND SOUND CONNECTIONS TO TV

1. Mount and connect the optional surround sound speakers by following the instructions provided with the speakers.
2. Connect the two external speaker terminals. Observe polarity of the connections.

The level of the surround sound varies relative to the difference between the left- and right-channel stereo signals.
NOTE: The SURROUND SPKRS terminals are always active. Therefore, the position of the SPEAKERS EXT/INT switch does not affect the operation of surround speakers.

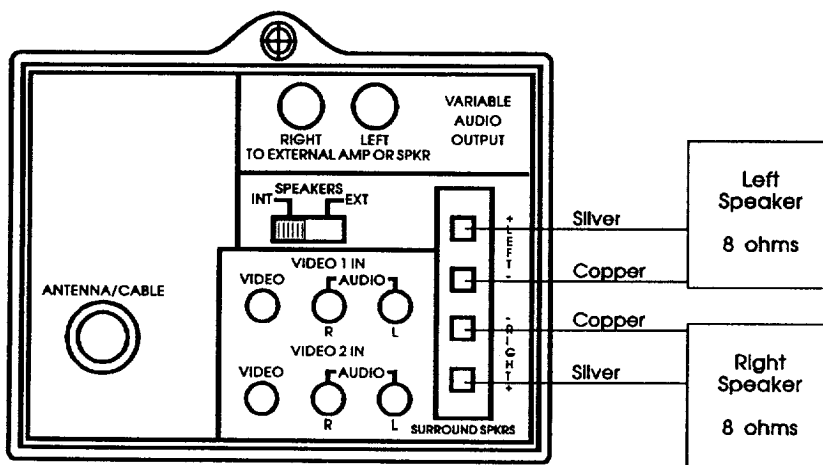

CONNECTIONS FOR YOUR TV

STEP 4. MAKE AUDIO CONNECTION TO STEREO AMPLIFIER

Using an External Amplifier with Speakers While the TV's Speakers are OFF.

1. Place the SPEAKERS EXT/INT switch on the TV in the INT position (TV's speakers are ON).
2. Turn the TV ON. Increase the volume level of the TV until the sound just starts to distort (sound bad).
3. Place the SPEAKERS EXT/INT switch on the TV in the EXT position (TV's speakers are OFF).
4. Turn the external audio amplifier ON. Adjust the volume level of the audio amplifier for the highest level you will need for your listening pleasure.
5. Adjust the volume level of the TV for the normal listening level as heard through the speakers of your audio amplifier.

Using an External Amplifier with Speakers While the TV's Speakers are ON.

1. Place the SPEAKERS EXT/INT switch on the TV in the INT position (TV's speakers are ON).
2. Turn the TV ON. Increase the volume level of the TV until the sound just starts to distort (sound bad).
3. Turn the external audio amplifier ON. Adjust the volume level of the audio amplifier for the highest level you will need for your listening pleasure.
4. Adjust the volume level of the TV for the normal listening level as heard through the speakers of the TV.

NOTE: If the volume of the internal TV speakers is set too low, you may hear undesirable noises through the speakers connected to your audio amplifier.

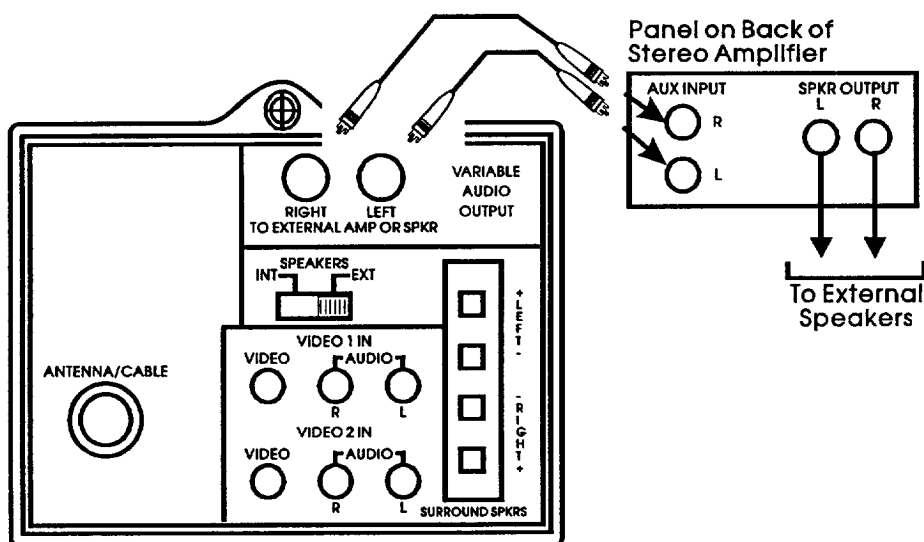

THE FIRST TIME YOU OPERATE YOUR TV

STEP 1. CONNECT THE POWER

- A. Plug your TV into an unswitched AC power source.
- B. Turn the TV on by pressing OFF-ON.

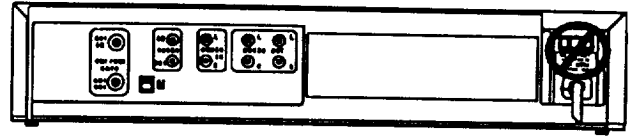

Do not plug TV into switched outlet on a VCR or cable-TV decoder

STEP 2. SELECT YOUR LANGUAGE

Select the language for the on-screen menus. Your options are English (ENGLISH), Spanish (ESPAÑOL) or French (FRANÇAIS). The word LANGUAGE always appears in English no matter which language is chosen.

1. Press MENU repeatedly on the remote control until the SETUP MENU is shown.
2. Press SELECT (SEL) to highlight LANGUAGE then use ADJUST (ADJ) to choose the desired language.
3. Press ENTER (ENT) to return to normal viewing.

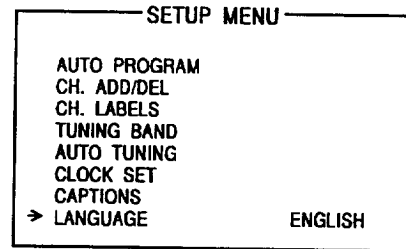

Setup Menu with Language Highlighted

STEP 3. SELECT YOUR VIEWING SOURCE

A TV source refers to the equipment connected to the TV. You select the viewing source that supplies the picture and sound to your TV by means of the SOURCE MENU.

To Access SOURCE MENU

1. Press SOURCE on the remote control to view the SOURCE MENU.
2. Press SOURCE repeatedly until the ANT/CABLE source is highlighted.

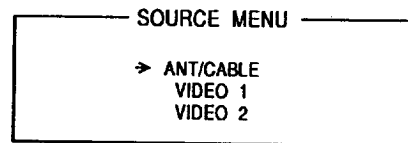

3. Press ENTER (ENT) to return to normal viewing.
- NOTE:** ANT/CABLE source must be selected before using AUTO PROGRAM in order to correctly find available channels.

STEP 4. USE AUTO PROGRAM

When your TV is first powered up you will see the AUTO PROGRAM reminder display. AUTO PROGRAM finds all available channels and stores them in the memory of the TV. To activate AUTO PROGRAM, press ADJUST (ADJ) Left/Right.

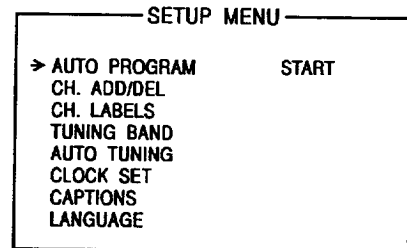

Setup Menu with Auto Program Highlighted

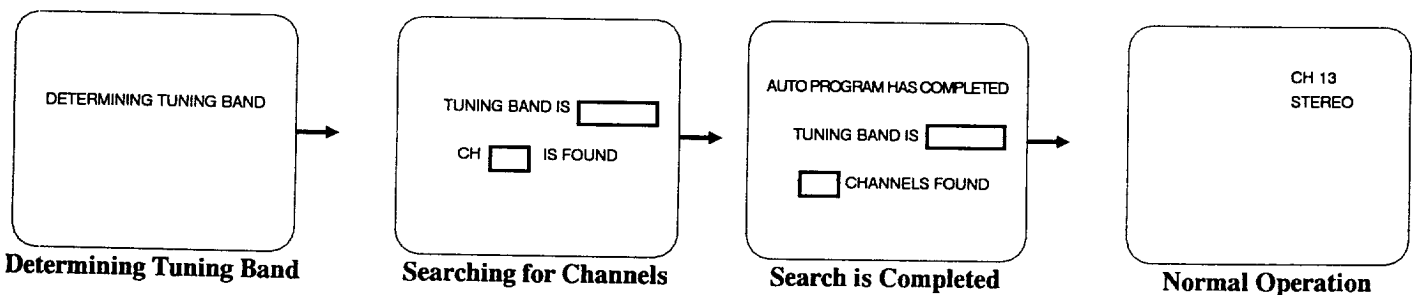

THE FIRST TIME YOU OPERATE YOUR TV

STEP 5. SET THE CLOCK

1. Press MENU repeatedly until the SETUP MENU is shown.
2. Press SELECT (SEL) to highlight CLOCK SET.
3. Use numbered buttons on remote control to enter correct time and TIMER to select AM or PM. You can also use ADJUST (ADJ) Left/Right to advance the 24 hour clock.
4. Press ENTER (ENT) to start the clock and return to normal viewing.

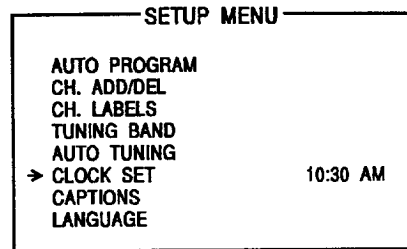

Setup Menu with Clock Set Highlighted

STEP 6. USE OTHER OPTIONS

You may want to consider using the following options:

- Program the channels accessed by using CHANNEL (CH) Up/Down. Refer to the CH. (Channel) ADD/DEL option for details.
- Assign labels (such as ABC) to appear in the Channel/Time display. Refer to the CH. (Channel) LABELS option for details.

GETTING TO KNOW YOUR TV

TYPICAL CONTROL PANEL

The control panel on your TV may differ from the one shown. **NOTE:** Some TVs have a vertical control panel – the operation is the same as described for the control panels shown above.

ENTER (ENT)

Press to see the Channel/Time display, or to remove any on-screen display or menu.

SELECT (SEL)

Press during on-screen menu operations to select a menu option.

VOLUME (VOL) Up/Down

Press to increase or decrease the sound level.

OFF-ON

Press to turn TV power ON or OFF.

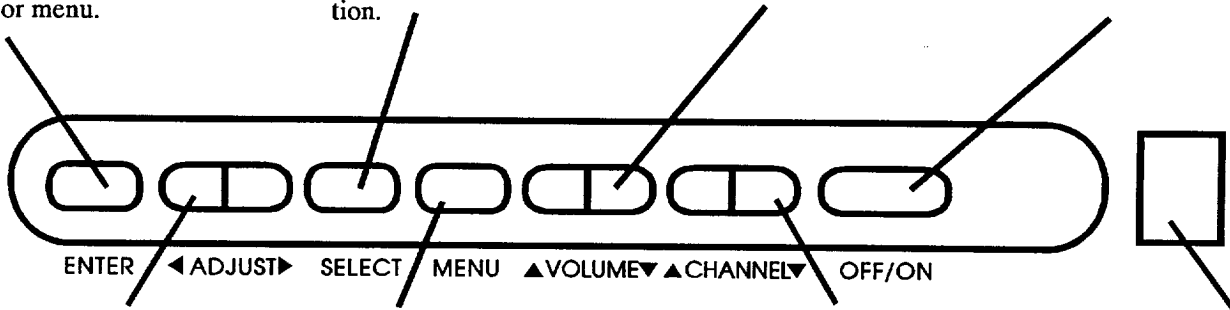

ADJUST (ADJ) Left/Right

Press during on-screen menu operation to see information/status display for selected option. Press again to adjust the selected menu option.

MENU

Press once to see a menu. Press repeatedly to sequence through the available menus.

CHANNEL (CH) Up/Down

Press to select channels higher or lower than the channels being viewed. You can add channels to or delete channels from the scanning sequence stored in memory of the TV. See CH. ADD/DEL option for channel programming information.

Remote Window

Point the remote control towards this window to operate the TV.

SLEEP TIMER

Some remote controls are equipped with a **TIMER** button that provides access to the **SLEEP TIMER** available with some TV models. By using the **SLEEP TIMER**, you can program the TV to automatically shut off after a period from 15 minutes up to 4 hours.

To Set SLEEP TIMER

1. Press **TIMER** to see **SLEEP TIMER** display.
2. Press **TIMER** repeatedly until you reach desired shut-off time.

One minute before the TV shuts off, the **GOOD NIGHT** display appears on the screen. At this time you have a choice of the following three actions.

1. Do nothing. The **GOOD NIGHT** display remains on the screen. The TV will shut off in one minute.
2. Remove the **GOOD NIGHT** display by pressing **ENTER (ENT)**. The TV will still shut off in one minute.
3. Delay the shut off by using **TIMER** to select a new shut off time.

To Cancel the SLEEP TIMER

You can cancel the **SLEEP TIMER** by setting the **SLEEP TIMER** status to **OFF**. Press **TIMER** repeatedly until **OFF** is selected.

NOTE: The **SLEEP TIMER** resets to **OFF** when you turn off the TV.

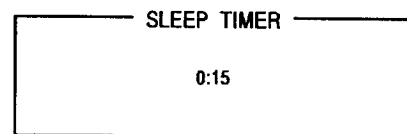

Sleep Timer Display

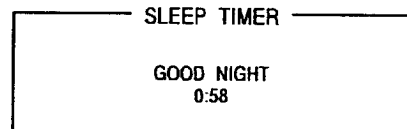

“Good Night” Display

GETTING TO KNOW YOUR TV

ON/OFF TIMER

NOTE: ON/OFF TIMER cannot be accessed until the clock is set.

1. Press **TIMER** on remote control to see **SLEEP TIMER** display, then press **MENU** to access **ON/OFF TIMER**.
2. Press **SELECT (SEL)** to highlight **ON TIME**. Use numbered buttons on remote to enter time for TV to turn **ON** and **TIMER** to select **AM** or **PM**. You can also use **ADJUST (ADJ)** Left/Right to advance the time set for **ON TIME**.
3. Press **SELECT (SEL)**, if needed, to highlight **OFF TIME**. Use numbered buttons on remote to enter time for TV to turn **OFF** and **TIMER** to select **AM** or **PM**. You can also use **ADJUST (ADJ)** Left/Right to advance the time set for **OFF TIME**.
4. Press **SELECT (SEL)** to highlight **TIMER**. Use **ADJUST (ADJ)** on remote to turn **TIMER ON** or **OFF**.
NOTE: A time must be set for either **ON TIME** or **OFF TIME** in order to turn **TIMER ON**.
5. Press **ENTER (ENT)** to start the timer and return to normal viewing.

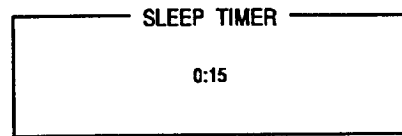

Sleep Timer Display

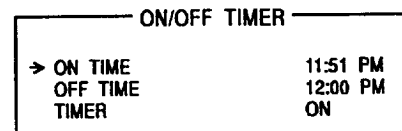

On/Off Timer Display

REMOTE CONTROL MODEL MBR3420/MBR3430

INTRODUCTION

The multi-brand remote control supplied with your new Zenith TV allows you to operate most models of infra-red (IR) remote-controlled TVs, VCRs, and cable-TV decoders, even if they are all different brands.

Your multi-brand remote has already been programmed to operate your Zenith TV, a Zenith cable-TV decoder and a Zenith VHS VCR. It must be programmed to operate other brands of equipment.

Refer to the "Programming Brand Codes" paragraph for more information.

CHOOSING OPERATING MODE

To use the remote to operate your TV, a cable-TV decoder or a VCR, you must first choose the mode of operation of the remote control. To select the mode of operation, press **MODE** repeatedly until the corresponding indicator lights.

Some controls on the remote will always operate a particular appliance. For example, **VOLUME** always operates the TV and **PLAY** always operates the VCR. The functions of some controls depends on the selected operating mode of the remote.

Functional Differences Between Models

MBR3420 Buttons	MBR3430 Buttons
A	PIP
B	FREEZE
MEMORY	SWAP

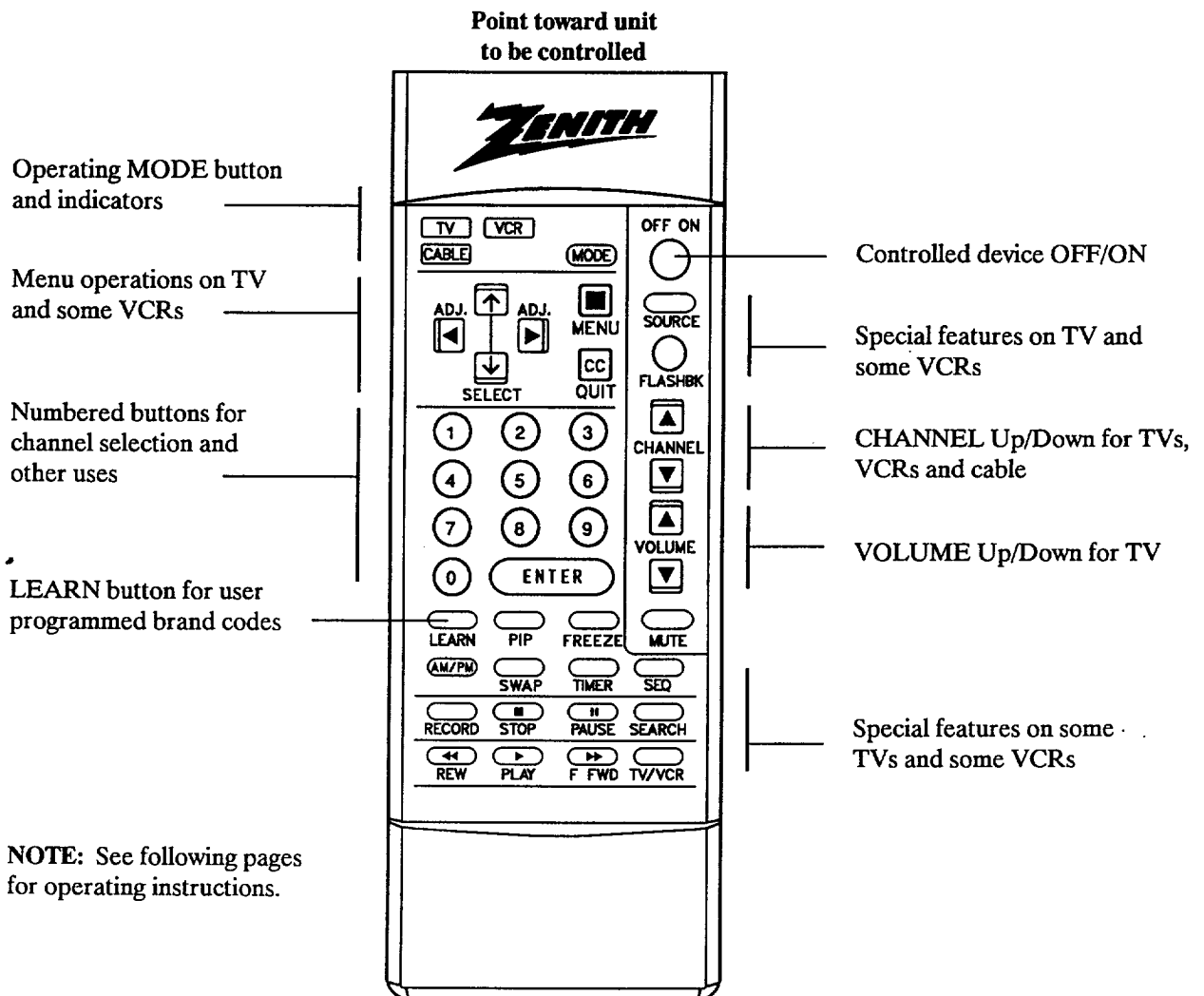

MBR3430 is Shown

NOTE: See following pages for operating instructions.

REMOTE CONTROL MODEL MBR3420/MBR3430

TV OPERATIONS

The following functions and operations apply to your Zenith TV. The remote control must be in the TV mode to operate your TV.

MODE

Press repeatedly to select the TV mode of operation.

TV

Lights when TV mode of operation is selected.

CC (Closed Captions)

Used to view closed captions broadcast with some television programs.

MENU, SELECT and ADJUST

Used with on-screen menus to see menu, select an option, and adjust that option.

Numbered Buttons

Used to select a TV channel.

ENTER

Used to view the Channel/Time display or to remove any on-screen menu or display.

PIP (Picture-In-Picture)

Used to activate PIP.

SWAP

Used to swap the main picture with the PIP insert.

FREEZE

Used to freeze the motion of the PIP insert.

TIMER

Used to activate SLEEP TIMER and ON/OFF TIMER.

↑
Point toward your TV.

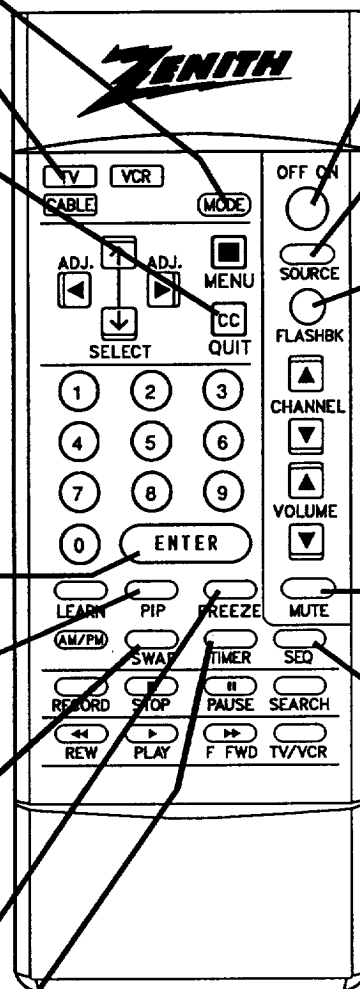

OFF/ON

Used to turn TV ON or OFF.

SOURCE

Used to display the menu of TV sources for some TVs. Press SOURCE again to step through the source selections. On some TVs, press SOURCE to select the AUX (Auxiliary) channel.

FLASHBK (Flashback)

Used to return to the last TV channel you were watching.

CHANNEL Up/Down

Used to sequence through the TV channels.

VOLUME Up/Down

Used to adjust the volume level of the TV.

MUTE

Used to turn off sound while the picture remains. Press again to restore the sound.

SPATIAL EQUALIZATION (SEq)

Used to select SEq audio mode on TVs equipped with SEq feature.

MBR3430 is Shown
TV Operations

REMOTE CONTROL MODEL MBR3420/MBR3430

VCR OPERATIONS

The following functions and operations apply to Zenith VCR models built after 1988. The remote control must be in the VCR mode to operate your VCR.

The remote control supplied with your VCR may have keys not duplicated on the new remote. If these functions are desired, the original remote control will have to be used.

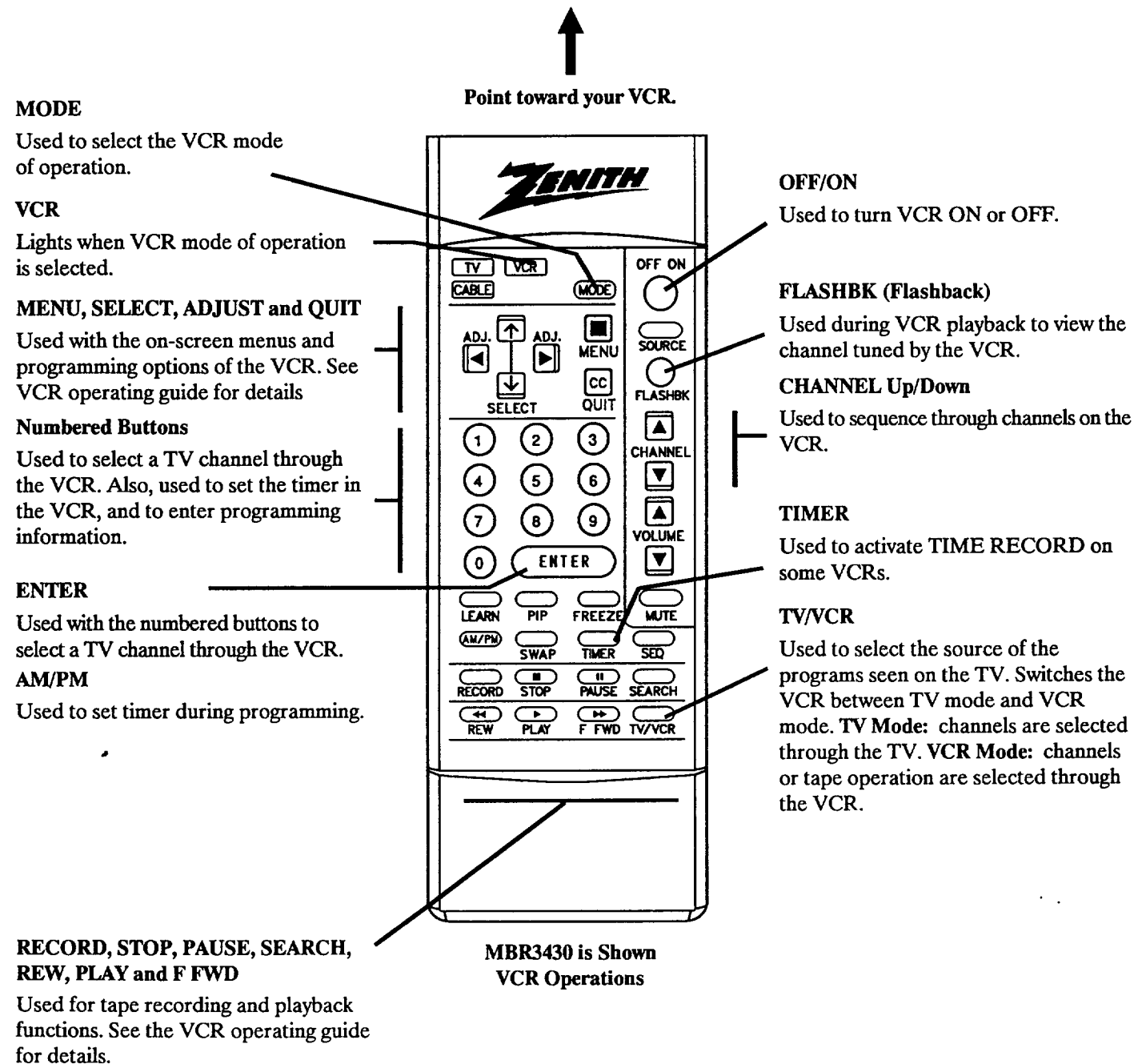

REMOTE CONTROL MODEL MBR3420/MBR3430

CABLE-TV OPERATIONS

The following functions and operations apply to a Zenith cable-TV decoder. The remote control must be in the CABLE mode to operate your cable-TV decoder.

The remote control supplied with your cable-TV decoder may have keys not duplicated on the new remote. If these functions are desired, the original remote control will have to be used.

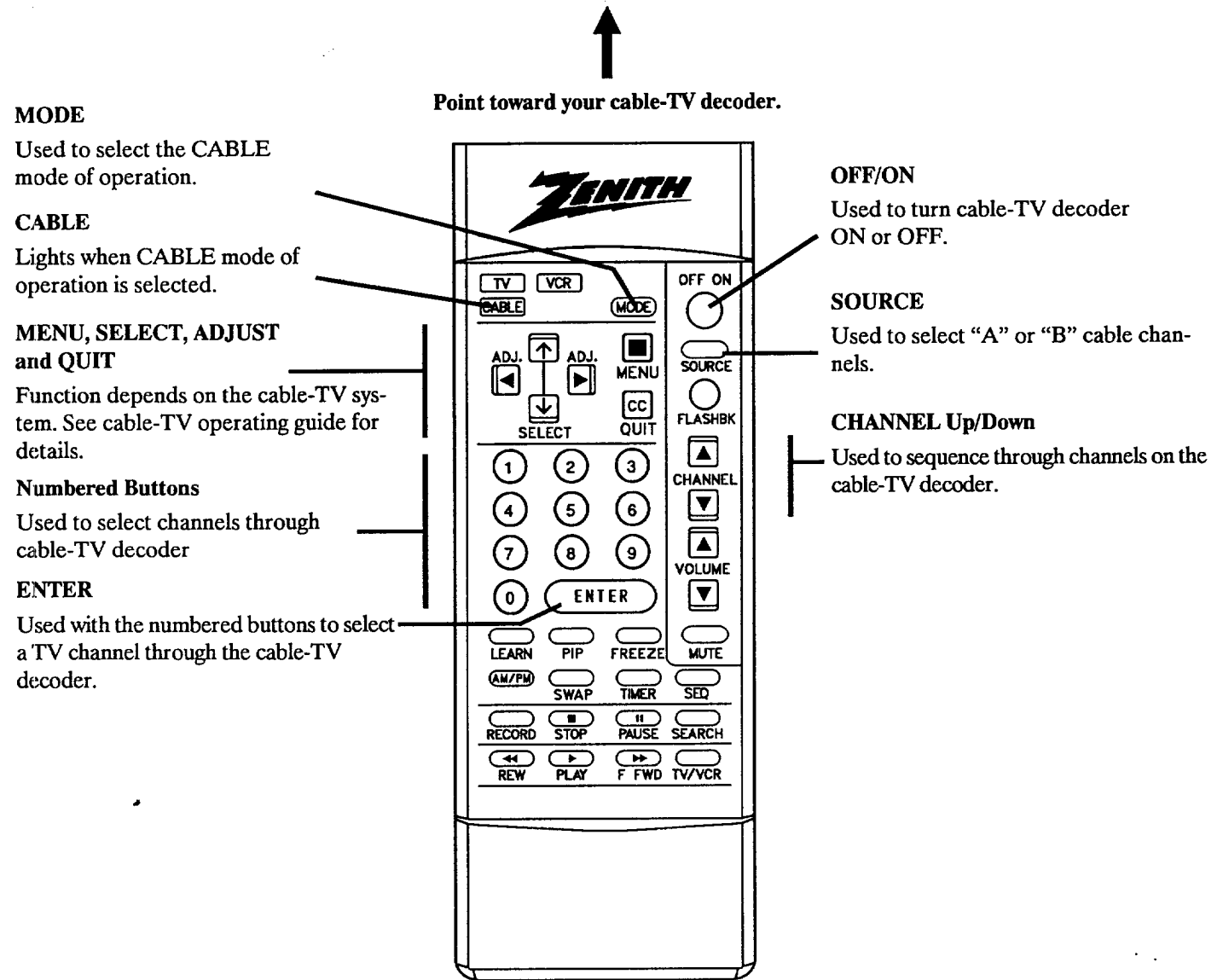

MBR3430 is Shown
Cable-TV Decoder Operations

REMOTE CONTROL MODEL MBR3420/MBR3430

PREPARATION FOR USE

Batteries are provided with this remote, but you must install them before using the remote.

INSTALLING BATTERIES

When the effective operating range of your remote becomes noticeably shorter, replace the batteries with two (2) high quality, alkaline, size AAA batteries.

After installing new batteries, the remote control will set itself to Zenith brand codes, as follows: TV = 101, VCR = 201 and CABLE = 301.

If you are going to operate equipment that uses different codes, the remote must be reprogrammed for those codes.

NOTE: Zenith is not responsible for damage caused by battery leakage.

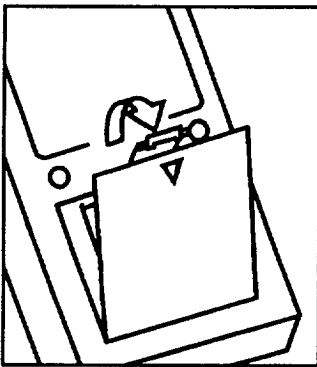

Step 1.

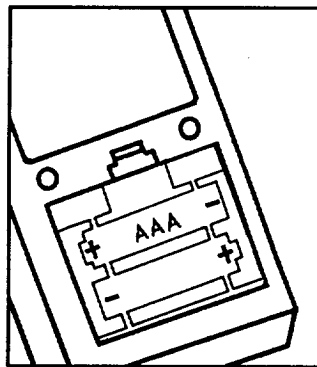

Step 2.

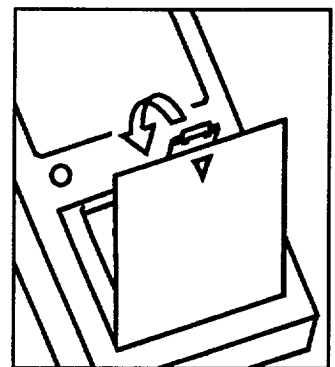

Step 3.

REMOTE CONTROL MODEL MBR3420/MBR3430

PROGRAMMING BRAND CODES

Before using your new remote control, it must be programmed to recognize the brands of equipment it will be used to operate. If you are using a Zenith TV, Zenith VHS VCR or a Zenith cable-TV decoder, it has already been programmed for you.

Find the code that corresponds to each brand and type of equipment you are going to operate. Refer to Tables 1, 2 and 3.

For example, if you were programming the remote for use with a Zenith TV, you would look up "Zenith" in "Table 1.", and find code "101."

Write the brand codes for your equipment on the following lines.

TV CODE: _____

CABLE CODE: _____

VCR CODE: _____

1. Press **MODE** repeatedly to select the desired TV, VCR or CABLE operating mode for the remote.
2. Press **LEARN** for about 5 seconds until the **MODE** indicator lights for the selected TV, VCR or CABLE mode of operation.
3. Enter the proper brand code number for the equipment to be controlled.
4. Press **LEARN**. All three mode indicators should light briefly, then turn off to indicate the brand code has been programmed.
5. If all three mode indicators fail to light briefly, an error has occurred. Repeat steps 1-4 to try again.
6. Repeat steps 1-4 to program the remote for the other equipment you are using.

NOTE: CABLE mode can be programmed to operate a second TV or second VCR, if desired.

When batteries are removed: It will be necessary to reprogram the proper VCR and cable-TV decoder codes.

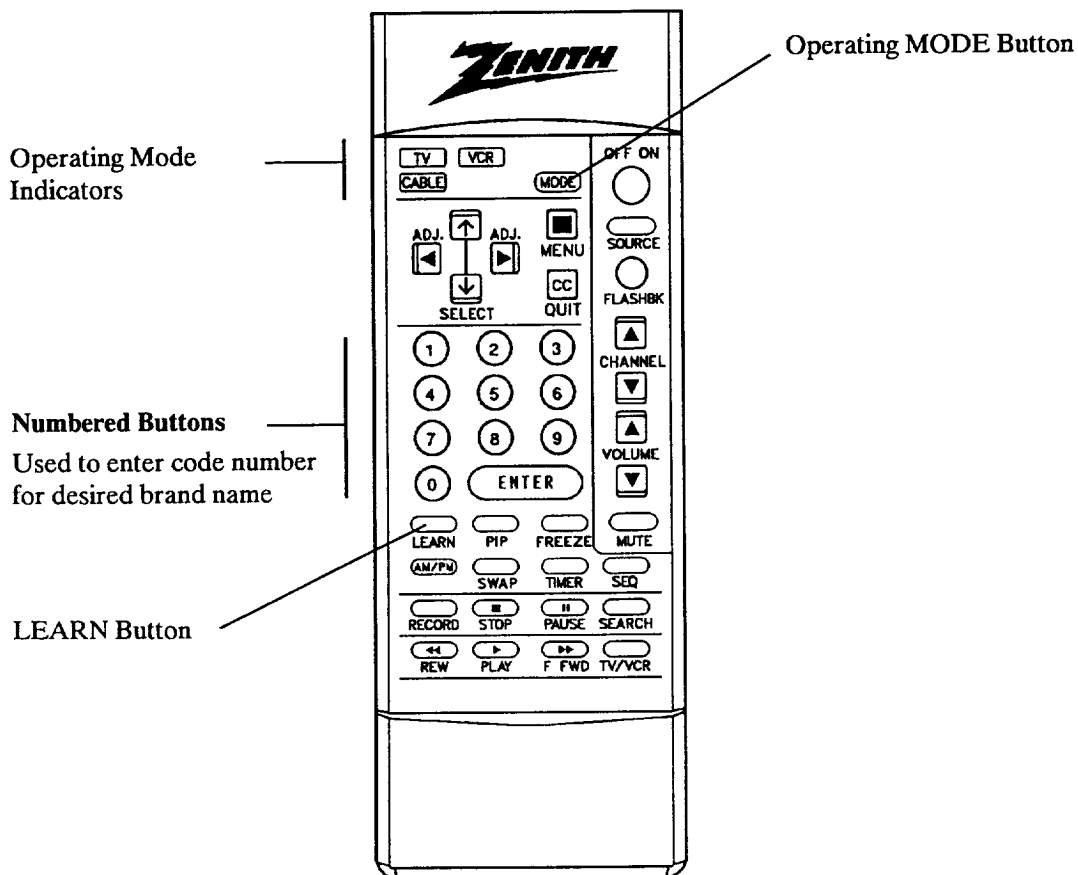

MBR3430 is Shown

REMOTE CONTROL MODEL MBR3420/MBR3430

TV, VCR AND CABLE-TV BRAND CODES

Table 1. TV Codes by Brand

TV Brand Name	Code	TV Brand Name	Code
Admiral	116	Montgomery Ward	119
Admiral	121	Montgomery Ward	121
Akai	104	Montgomery Ward	130
Amark	103	NEC	104
AOC	104	NEC	119
Bell & Howell	121	Panasonic	106
Centurion	119	Panasonic	107
Coronado	103	Philco	103
Curtis Mathes	116	Philco	104
Curtis Mathes	119	Philco	112
Curtis Mathes	121	Philco	113
Daytron	119	Philips	112
Emerson	103	Philips	113
Emerson	104	Pioneer	135
Emerson	123	Portland	103
Emerson	124	Quasar	106
Emerson	131	Quasar	107
Emerson	136	Realistic	105
Fisher	109	Realistic	123
Fisher	118	Realistic	124
General Electric	106	RCA	104
General Electric	107	RCA	116
General Electric	114	RCA	126
General Electric	116	Sampo	119
Goldstar	103	Samsung	103
Goldstar	104	Samsung	119
Goldstar	119	Samsung	134
Hitachi	102	Sanyo	108
Hitachi	103	Sanyo	109
Hitachi	129	Sanyo	118
JVC	125	Scott	119
JVC	132	Sears	103
J.C. Penney	104	Sears	108
J.C. Penney	110	Sears	109
J.C. Penney	114	Sears	110
J.C. Penney	117	Sears	111
J.C. Penney	119	Sears	118
KMC	103	Sears	134
KTV	103	Sharp	103
KTV	104	Sharp	105
Lodgenet	121	Sharp	122
Logik	121	Sharp	133
LXI	133	Sharp	137
LXI	137	Sony	115
Magnavox	103	Sylvania	112
Magnavox	112	Sylvania	113
Magnavox	113	Sylvania	117
Magnavox	119	Sylvania	119
Magnavox	127	Sylvania	127
Magnavox	128	Sylvania	128
Majestic	121	Tatung	106
Marantz	104	Teknika	103
Marantz	120	Teknika	112
Memorex	121	Teknika	121
MGA/Mitsubishi	104	Teknika	124
MGA/Mitsubishi	119	Telerent	103
MGA/Mitsubishi	120	Telerent	121
MGA/Mitsubishi	130	Toshiba	110
Montgomery Ward	103	Toshiba	111
Montgomery Ward	104	Toshiba	134
Montgomery Ward	105	Yorx	119
Montgomery Ward	113	Zenith	101
Montgomery Ward	114		

Table 2. VCR Codes by Brand

VCR Brand Name	Code	VCR Brand Name	Code
Akai	223	Pentax	215
Audio Dynamics	202	Philco	214
Audio Dynamics	218	Philips	214
Broksonic	221	Philips	227
Canon	214	Pioneer	210
Citizen	209	Pioneer	215
Craig	212	Pioneer Laser Disk	228
Curtis Mathes	214	Quasar	214
Curtis Mathes	216	RCA	215
DBX	202	RCA	216
DBX	218	RCA	220
Emerson	203	RCA	227
Emerson	221	Realistic	206
Emerson	223	Realistic	208
Emerson	226	Realistic	212
Emerson	233	Realistic	214
Emerson	235	Realistic	231
Fisher	211	Samsung	220
Fisher	212	Samsung	230
Fisher	213	Sanyo	206
Funai	231	Sanyo	212
General Electric	214	Scott	204
General Electric	216	Scott	205
General Electric	220	Scott	233
Goldstar	209	Sears	206
Hitachi	215	Sears	209
Instant Replay	214	Sears	211
Instant Replay	227	Sears	212
JVC	202	Sears	215
JVC	225	Sharp	208
J.C. Penney	214	Sony VHS	232
J.C. Penney	218	Sony Video 8	217
J.C. Penney	227	Sylvania	207
Kenwood	202	Sylvania	214
Magnavox	207	Sylvania	227
Magnavox	214	Symphonic	231
Marantz	207	Tashiko	209
Marantz	218	Tatung	202
Marta	209	Teac	202
Memorex	212	Teac	231
Memorex	214	Teknika	234
Memorex	231	Toshiba	205
MGA/Mitsubishi	204	Toshiba	215
MGA/Mitsubishi	222	Vector Research	204
Montgomery Ward	208	Vector Research	218
Montgomery Ward	214	Yamaha	202
Montgomery Ward	219	Yamaha	218
NEC	202	Zenith VHS	201
NEC	218	Zenith VHS	225
Panasonic	214	Zenith VHS	229

Table 3. Cable Decoder Codes by Brand

Cable Decoder Brand Name	Code	Cable Decoder Brand Name	Code
Drake Satellite	312	Pioneer	315
Drake Satellite	330	Regency	329
Gemini	305	Samsung	335
Gemini	331	Scientific Atlanta	316
General Instrument	305	Scientific Atlanta	323
General Instrument	306	Scientific Atlanta	336
Hamlin	302	Sprucer	
Hamlin	303	(Panasonic)	313
Jerrold	304	Standard	
Jerrold	307	Components	335
Jerrold	308	STS Satellite	324
Jerrold	309	Telecaption 4000	325
Jerrold	310	Tocom	317
Kale Vision	335	Tocom VIP	318
Macom	314	Toshiba	322
Macom	321	Toshiba Satellite	319
Macom Satellite	322	Zenith	301
Magnavox	334	Zenith	322
NSC	335	Zenith AV3000	327
Oak	311	Zenith Satellite	312
Oak	332	Zenith Satellite	330
Panasonic	313	Zenith Satellite	328
Panasonic	320	Zenith Laser Disk	326
Paragon (Zenith)	333		

QUICK REFERENCE TO ON-SCREEN MENUS

AVAILABLE MENUS

Your TV is menu operated, that is, adjustments that can be made to the TV appear on the screen in a list of choices you can make.

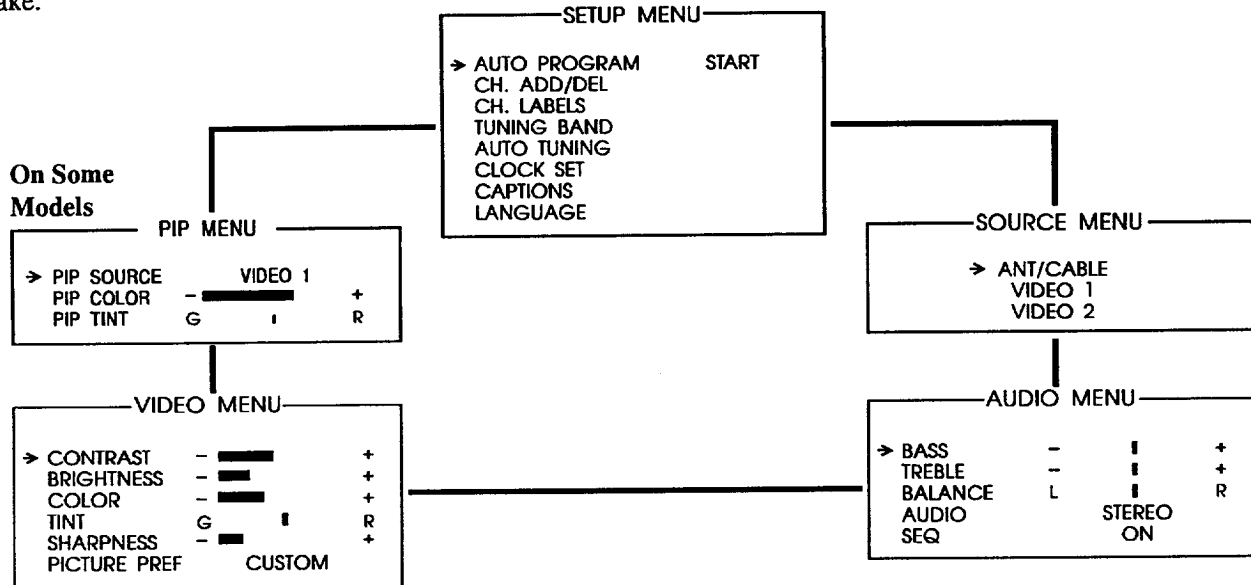

BASIC MENU OPERATION

1. Press MENU repeatedly to choose between available menus.
2. Press SELECT (SEL) Up/Down repeatedly until the desired option is highlighted.
3. Press ADJUST (ADJ) Left/Right to adjust an option.
4. Press ENTER (ENT) or wait a few seconds and the TV will return automatically to normal operation.

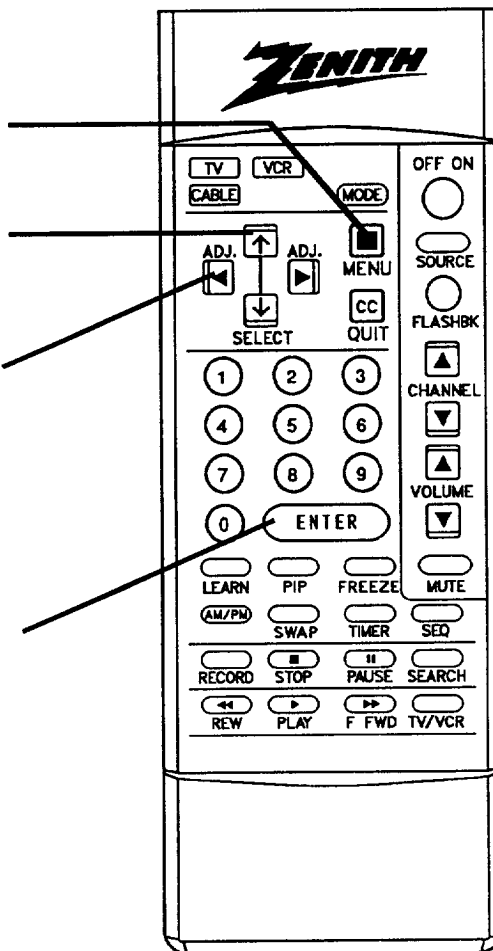

Typical Remote Control Shown

QUICK REFERENCE TO ON-SCREEN MENUS

MENU OPERATION EXAMPLE



Press MENU repeatedly until the desired menu is shown.
This example shows choosing the SETUP MENU.

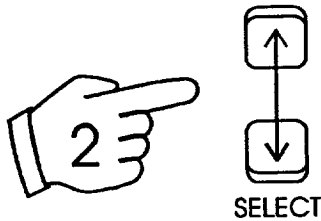
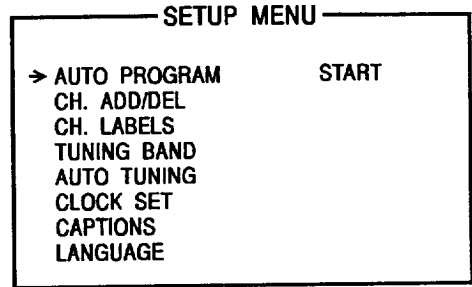

Press SELECT (SEL) Up/Down repeatedly until the desired option is highlighted. This example shows choosing TUNING BAND.

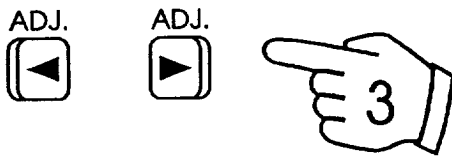
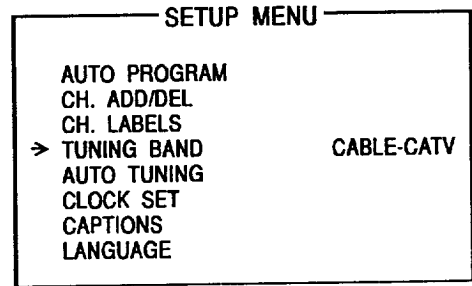

Press ADJUST (ADJ) Left/Right to adjust an option. This example shows the various choices you have for TUNING BAND.

Available options
for TUNING BAND

BROADCAST
CABLE - CATV
CABLE - HRC
CABLE - ICC

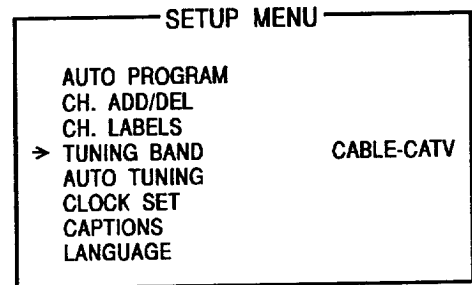

Press ENTER (ENT) or wait a few seconds and the TV will return to normal operation.

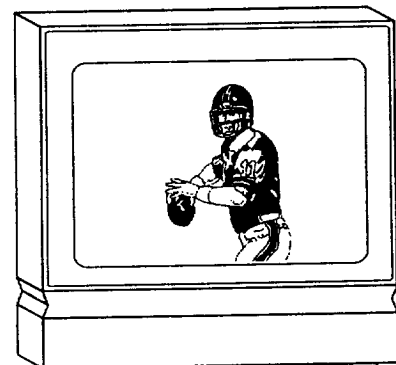

SOURCE MENU

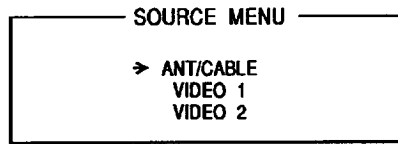

SOURCE SELECTION

Purpose

The viewing "source" refers to the equipment that supplies the picture and sound to your TV. You select the viewing source by using the SOURCE MENU.

To Access the SOURCE MENU

1. Press SOURCE on the remote control to see the SOURCE MENU.
2. Press SOURCE repeatedly until the source you want is highlighted.
3. Press ENTER (ENT) to return to normal viewing.

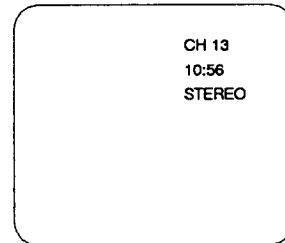

Channel/Time Display
for Antenna or
Cable Source Shows
Channel Number

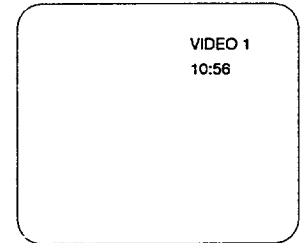

Channel/Time Display
for A/V Source Shows
VIDEO 1 or VIDEO 2

SOURCE IDENTIFICATION

Selecting ANT/CABLE: Routes the antenna or cable-TV source to the TV for viewing. You see program material from whichever signal source is connected to the ANTENNA/CABLE jack.

Selecting VIDEO 1 or VIDEO 2: Routes the audio and video from an A/V source (such as a VCR or a video disc player) to the TV for viewing. The source must be connected to the corresponding VIDEO 1 IN or VIDEO 2 IN jacks.

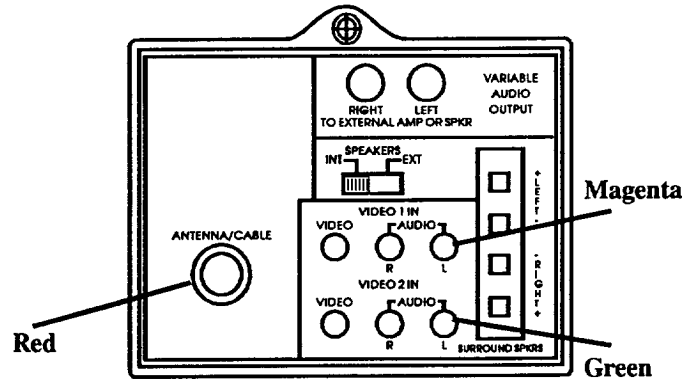

Connection Center on Back of TV

SETUP MENU

To Access SETUP MENU

Refer to the "Quick Reference to On-Screen Menus" section for details.

Before Using SETUP MENU

Connect and turn ON all external equipment, such as cable TV decoder, VCR, etc. before using any item on the SETUP MENU.

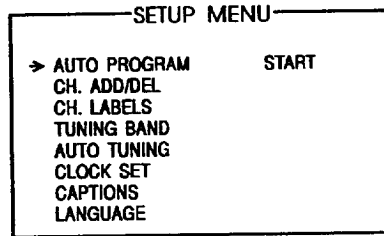

SETUP MENU

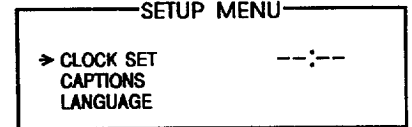

SETUP MENU While VIDEO 1 or VIDEO 2 Source is Chosen

AUTO PROGRAM

Purpose

Finds all available channels and stores them in the memory of the TV for access by CHANNEL (CH) Up/Down.

Use AUTO PROGRAM only when you first install your TV, or when you permanently change the connections to the TV. For example, when you replace the antenna with a cable-TV system.

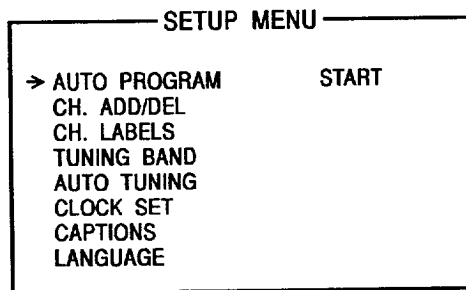

Selecting Auto Program

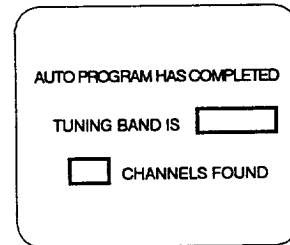

Status When Search is Complete

When Some Channels Are Not Found

AUTO PROGRAM finds only active channels and stores them in the favorite channel memory. You can add channels to those stored in memory by using the CH. ADD/DEL option.

To Use AUTO PROGRAM

Press ADJUST (ADJ) Left/Right to start AUTO PROGRAM.

CH. (Channel) ADD/DEL

Purpose

Lets you add channels to and remove channels from the active channels found when using the AUTO PROGRAM option. In this way you can customize the channels that are accessed through CHANNEL (CH) Up/Down.

To Add a Channel to Scan Sequence

1. Use numbered buttons to select the channel you wish to add.
2. Add channel by pressing ADJUST (ADJ) Left/Right until the display shows ADD.

To Delete a Channel from Scan Sequence

1. Use numbered buttons to select the channel you wish to delete.
2. Delete channel by pressing ADJUST (ADJ) Left/Right until the display shows DEL.

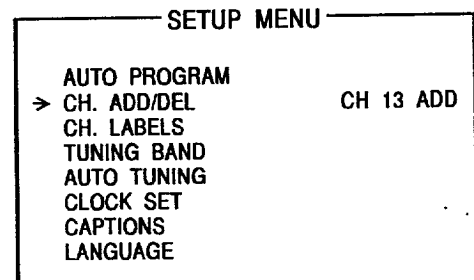

Selecting Ch. Add/Del

SETUP MENU

CH. (Channel) LABELS

Purpose

Assigns a network label or name to the selected channels. If you choose the label "ABC" for channel 13, "ABC" appears in the Channel/Time display when channel 13 is selected for viewing.

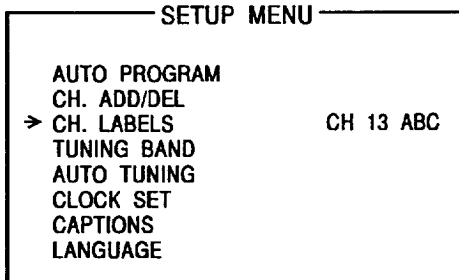

Selecting Ch. Labels

To Use CH. LABELS

1. Select a channel by using the number buttons or CHANNEL Up/Down.
2. Press ADJUST (ADJ) Left/Right to sequence through the available choices until the desired label appears.

NOTE: To remove an assigned channel label, select the four dashes.

A&E	ABC	ACTS	ADC	AMC	BET
BRAV	CA	CBC	CBN	CBS	CMTV
CNBC	CNN	COM	CSPN	CTN	CTV
DIS	DISC	E!	ENC	ESPN	ET
EWTN	FAM	FNN	FOX	GALA	HBO
HN	HSE	HSN	IC	INSP	LIFE
MAX	MEU	MMT	MTV	NBC	NICK
NOS	PBS	PLAY	PTL	QVC	RDS
REQ	SC	SCFI	SHOW	SIN	TBS
TBN	TELE	TLC	TMC	TNN	TNT
TRAV	TSN	TVA	TWN	USA	VC
VCR	VH1	VISN	VJN	WGN	WTBS
WWOR	YTV	---	---	---	---

Available Channel Labels

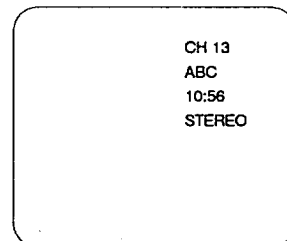

Channel/Time Display with Label

TUNING BAND

Purpose

Allows for setting the TV channel selector (tuner) to match your antenna or cable-TV system.

If you are having difficulty tuning channels, the TUNING BAND may have to be set manually to match your viewing needs.

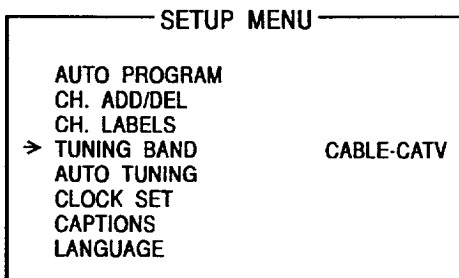

Selecting Tuning Band

To Use TUNING BAND

Press ADJUST (ADJ) Left/Right to select the tuning band that gives you the most channels:

- BROADCAST – is used for standard “over-the-air” broadcasts.
- CABLE – CATV is used for most standard cable-TV (CATV) systems.
- CABLE – HRC is used for cable-TV systems that use HRC (Harmonically Related Carrier).
- CABLE – ICC is used for cable-TV systems using ICC (Incremental Coherent Carrier).

Available Channels per Band

The channels that are available in the broadcast and cable tuning bands are shown below:

- BROADCAST Band – VHF 2 to 13, UHF 14 to 69
- CATV, HRC and ICC Bands – 1 to 125

SETUP MENU

AUTO TUNING

Purpose

Lets your TV compensate for variations in broadcast and cable-TV frequencies.

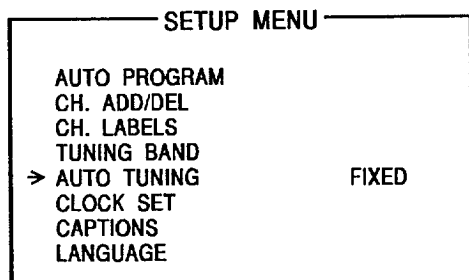

Selecting Auto Tuning

If you are having difficulty tuning channels, the AUTO TUNING may have to be set manually to match your viewing needs.

To Use AUTO TUNING

Press ADJUST (ADJ) Left/Right to select the mode of operation that gives you the most channels:

- FIXED is used to receive "over-the-air" TV stations, and with many cable-TV systems.
- SEARCH is used only when the TV must search to find the frequency being received, such as when used with certain cable-TV systems, VCRs and video game controllers.

CLOCK SET

Purpose

Sets the clock in the TV to the correct time.

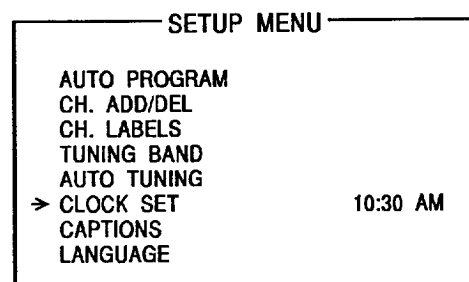

Selecting Clock Set

To Use CLOCK SET from Remote Control

Use the numbered buttons on the remote control to enter the correct time and TIMER to select AM or PM. Press ENTER (ENT) to start the clock.

To Use CLOCK SET from Control Panel

Use ADJUST (ADJ) Left/Right to set the time. Press ENTER (ENT) to start the clock.

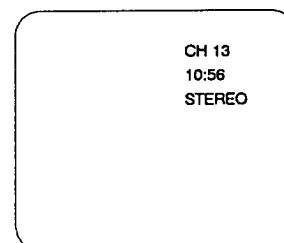

Channel/Time Display

SETUP MENU

CAPTIONS

Purpose

Displays closed captions (CC) or informational text when available on the selected channel.

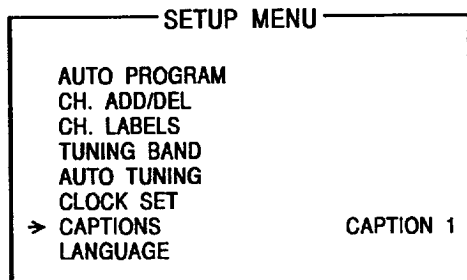

Selecting Captions

To Use CAPTIONS

Press ADJUST (ADJ) Left/Right to select desired mode of operation. Five different selections can be made: OFF, CAPTION 1, CAPTION 2, TEXT 1 or TEXT 2.

At the time of this writing, very little appears in any selection except CAPTION 1. Therefore you should select CAPTION 1 and leave it in that selection unless you know there is something you want to see in one of the other selections. Once you make a selection, that selection is remembered until you change it.

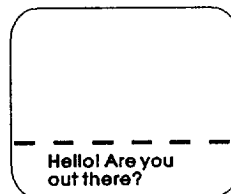

Typical Captions Display

Captions may be shown anywhere on the screen.

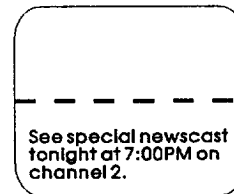

Typical Text Display

Fixed size text window fills lower half of screen. May be all black when no information is shown.

LANGUAGE

Purpose

Determines whether the on-screen menus are displayed in English (ENGLISH), Spanish (ESPAÑOL) or French (FRANÇAIS). NOTE: The word LANGUAGE always appears in English no matter which language is chosen.

To Use LANGUAGE

Press ADJUST (ADJ) Left/Right to select desired language.

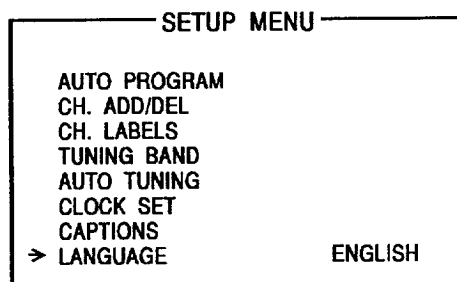

Selecting Language

AUDIO MENU

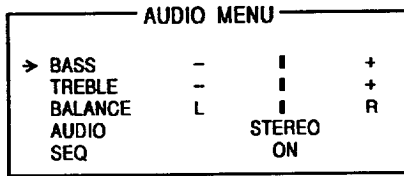

AUDIO MENU

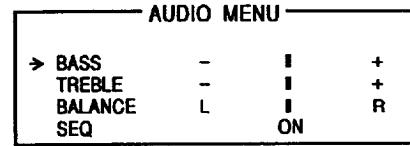

AUDIO MENU While VIDEO 1 or VIDEO 2 Source is Chosen

BASS	Adjusts the BASS (low-frequency) level.
TREBLE	Adjusts the TREBLE (high-frequency) level.
BALANCE	Adjusts the balance of sound between the left and right speakers.
AUDIO (AUDIO mode options are not available while using a VIDEO 1 or 2 source. The signal being received from the source is assumed to be stereo audio. SEQ may be switched ON or OFF as desired.)	Allows you to select STEREO, MONO or 2ND AUDIO/SAP speaker operation. <p>STEREO: Directs the sound to the left and right speakers as supplied by the program source (broadcast TV, VCR, etc.)</p> <p>MONO: Directs the same sound to both left and right speakers even if the source being received is in stereo.</p> <p>2ND AUDIO/SAP: Directs the sound for the second audio program (second language) to both the left and right speakers. SAP sound is always monaural.</p>
SEQ (Spatial Equalization)	Improves tonal balance and increases apparent stereo separation to produce a spacious and more tonal sound. SEQ is only available if a stereo signal is being received and you have previously selected STEREO using the AUDIO option.

To Access AUDIO MENU

Refer to the "Quick Reference to On-Screen Menus" section for details.

NOTE: All adjustments on the AUDIO MENU are optional. You do not have to use these features in order to use your TV.

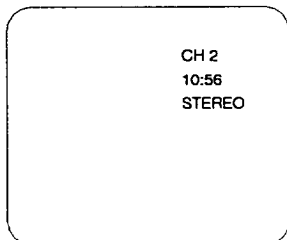

Audio Mode Shown in Channel/Time Display

STEREO is selected and a stereo signal is being received. You will hear stereo sound.

To Adjust BASS, TREBLE and BALANCE

Press ADJUST (ADJ) Left/Right until the most pleasing sound is heard.

To Use AUDIO Mode Options

Press ADJUST (ADJ) Left/Right to select desired option. We recommend that you use the STEREO option. The TV will switch automatically between the STEREO and MONO modes dependent on the signal being received. If you prefer SAP, use the 2ND AUDIO/SAP option. On those stations which broadcast two audio portions, you will hear the SAP (usually a second language). When the SAP broadcast ends, the TV switches automatically between STEREO and MONO modes. The TV switches back to 2ND AUDIO/SAP when the SAP broadcast resumes.

VIDEO MENU

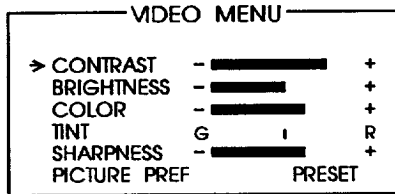

CONTRAST	Adjusts the overall contrast and color level of the picture.
BRIGHTNESS	Adjusts the brightness level of black areas in the picture.
COLOR	Adjusts the intensity of the colors in the picture.
TINT	Adjusts the color of the flesh tones, where G is Green and R is Red.
SHARPNESS	Adjusts the clarity of the edges of objects for the clearest picture quality.
PICTURE PREF. (Preference)	Lets you decide if you want to use your own CUSTOM video settings, or the factory set PRESET video settings.

To Access VIDEO MENU

Refer to the "Quick Reference to On-Screen Menus" section for details.

NOTE: All adjustments on the VIDEO MENU are optional. You do not have to use these features in order to use your TV.

To Use Video Settings

1. Select video setting to be adjusted.
2. Press ADJUST (ADJ) Left/Right until the most pleasing picture is seen.

NOTE: Any adjustment made to these settings while PICTURE PREF. is in PRESET mode will automatically store the current settings as the CUSTOM setting.

To Use PICTURE PREF. (Preference)

Press ADJUST (ADJ) Left/Right to select status.

PIP MENU (SOME MODELS)

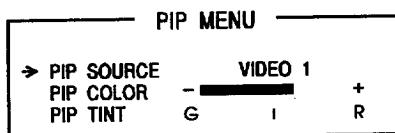

PIP SOURCE	Chooses the PIP inset source.
PIP COLOR	Adjusts the intensity of the colors in the PIP inset.
PIP TINT	Adjusts the color of the flesh tones in the PIP inset, where G is Green and R is Red.

To Access PIP MENU

Refer to the “Quick Reference to On-Screen Menus” section for details.

NOTE: All adjustments on the PIP MENU are optional. You do not have to use these features in order to use your TV.

To Select PIP SOURCE

Press ADJUST (ADJ) Left/Right to select desired source.
NOTE: VIDEO 2 is not available as a PIP source.

To Adjust PIP COLOR and PIP TINT

1. Select video setting to be adjusted.
2. Press ADJUST (ADJ) Left/Right until the most pleasing picture is seen.

PIP CONNECTIONS AND OPERATION (SOME MODELS)

INTRODUCTION

Your TV must be connected to two separate sources in order to view different pictures in the main picture and the PIP (Picture-In-Picture) inset. One source must be connected to the ANTENNA/CABLE jack. The other source must be connected to the VIDEO 1 jacks.

The most common use of PIP is to view two different channels; one from the channel selector in the TV and the other from the channel selector in the VCR. For example, you can view two sporting events or two movies at the same time.

BASIC PICTURE-IN-PICTURE CONNECTIONS

This illustration shows the basic connection of your TV to a stereo VCR. Using these connections, you can do the following:

- Simultaneously view video tape playback and a channel selected using the TV's tuner.
- Simultaneously view two different channels; one selected using the TV's tuner and another using the VCR's tuner.
- Swap the main picture and the PIP inset.

How to View Two Different Channels Simultaneously

In order to view two different channels simultaneously using the basic connection you must do the following.

1. Select ANT/CABLE source for the main picture. Select your viewing channel via the channel selector in the TV.
2. Select VIDEO 1 source for the PIP inset. Select your viewing channel via the channel selector in the VCR. The VCR/TV switch on the VCR must be in the TV position. **NOTE:** The VCR must not be in the PLAYBACK mode.
3. Press SWAP to swap the main picture with the PIP inset as desired.

NOTE: Detailed operation is given in the "Selecting Main Picture and PIP Inset Sources" paragraph.

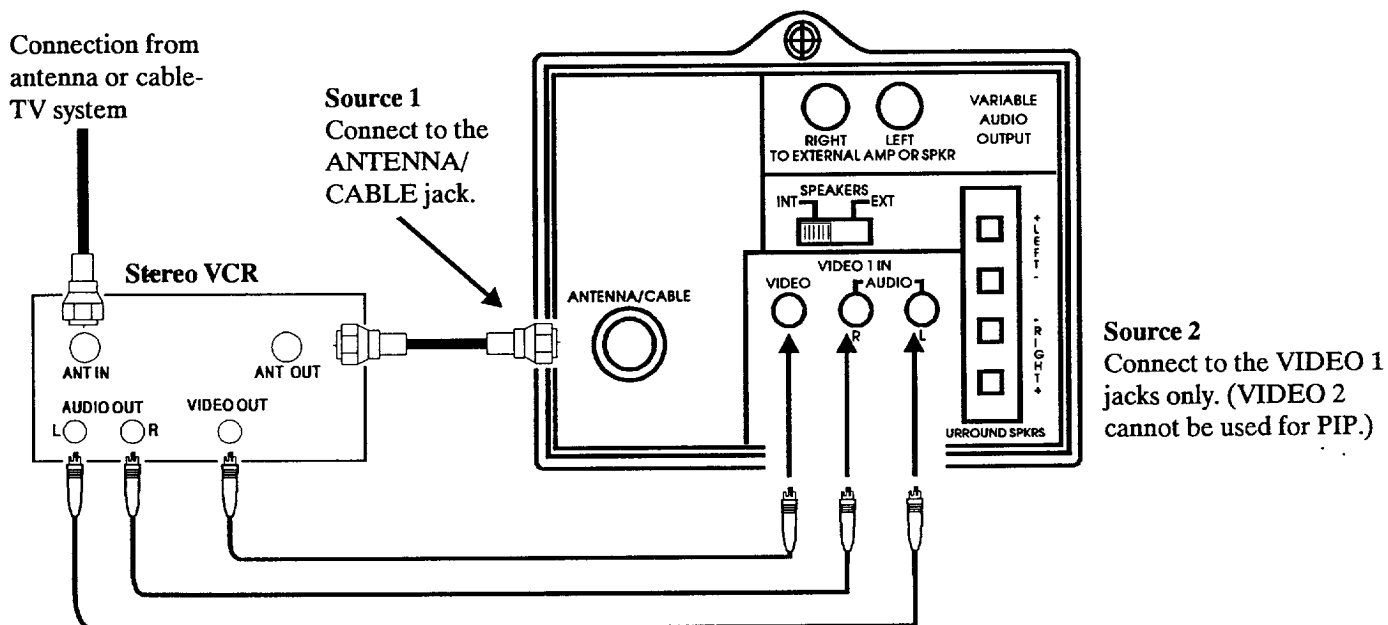

PIP CONNECTIONS AND OPERATION (SOME MODELS)

OPTIONAL PICTURE-IN-PICTURE CONNECTION

Using these connections, you can do the following:

- Simultaneously view video tape playback and a basic cable channel selected using the TV's tuner.
- Simultaneously view two different channels; one basic channel selected using the TV's tuner and a decoded channel selected using the decoder's tuner.
- Swap the main picture and the PIP inset.

How to View Two Different Channels Simultaneously

In order to view two different channels simultaneously using a cable-TV decoder and a signal splitter you must do the following.

1. Select ANT/CABLE source for the main picture. Select your viewing channel via the channel selector in the TV.
2. Select VIDEO 1 source for the PIP inset. Select your viewing channel via the channel selector in the decoder. **NOTE:** The VCR must not be in the PLAYBACK mode.
3. Press SWAP to swap the main picture with the PIP inset as desired.

NOTE: Detailed operation is given in the "Selecting Main Picture and PIP Inset Sources" paragraph.

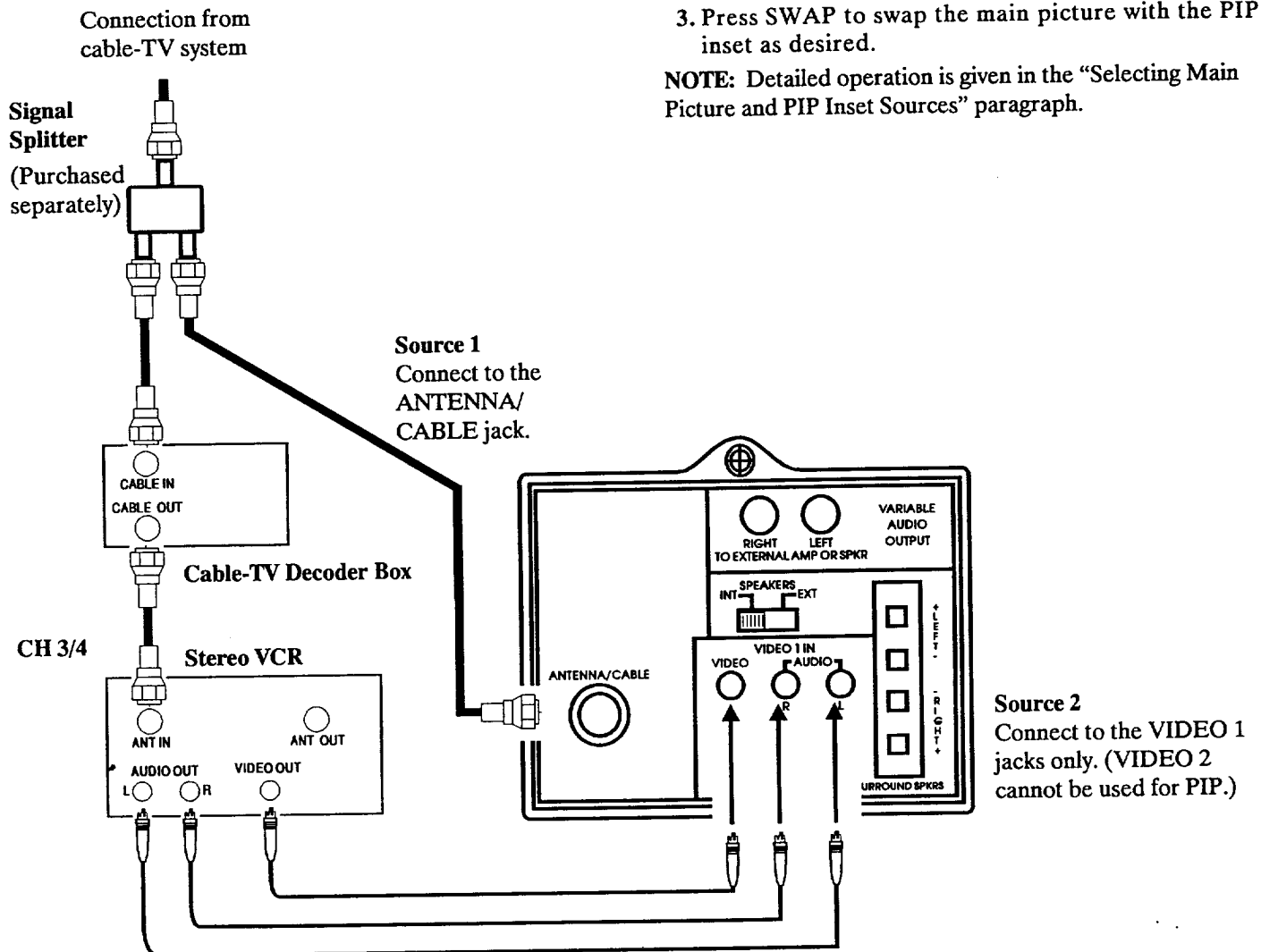

PIP CONNECTIONS AND OPERATION (SOME MODELS)

SELECTING MAIN PICTURE AND PIP INSET SOURCES

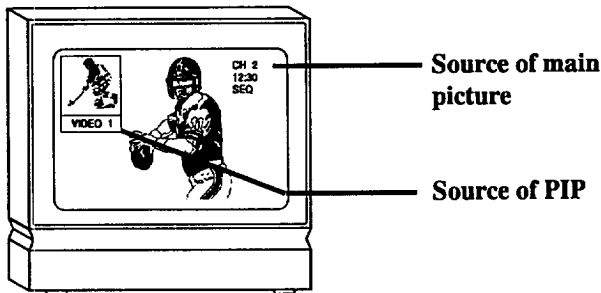

To Select Main Picture Source

The source for the main picture can be either ANT/CABLE or VIDEO 1. The following example shows selecting ANT/CABLE for the main picture source.

1. Select TV mode of operation on the remote.
2. Press SOURCE on the remote repeatedly until ANT/CABLE is selected.

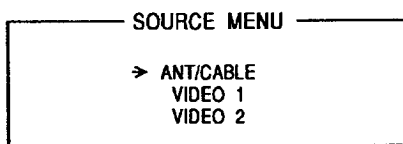

To Select PIP Inset Source

The source for the main picture can be either ANT/CABLE or VIDEO 1. The following example shows selecting VIDEO 1 for the PIP inset source.

1. Select TV mode of operation on the remote.
2. Press PIP on the remote to display PIP inset.
3. Press SOURCE on the remote to view the PIP MENU.
4. Press SOURCE on the remote repeatedly until VIDEO 1 is selected.

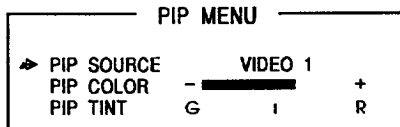

5. Use the VCR to change the channel in the PIP inset or to view a video tape in the PIP inset.
6. Press PIP on the remote to remove PIP inset.

PICTURE-IN-PICTURE OPERATION

PIP

Press PIP to display the PIP inset. Press PIP again to remove inset.

Moving the PIP Inset

Use 4-way arrows (ADJ/SELECT) to move PIP inset to the desired corner of the TV screen.

SWAP

Press SWAP to swap the main picture with the PIP inset. Press SWAP again to return to the original display.

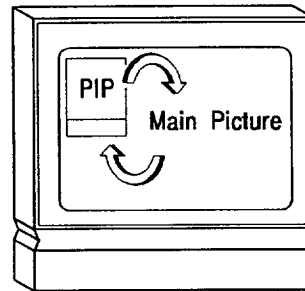

FREEZE

Press FREEZE to freeze motion of the picture shown in the PIP inset. Press FREEZE again to return to a live PIP inset.

When the PIP inset is not currently displayed, pressing FREEZE provides an instant PIP freeze-frame of the program you are watching. Press PIP again to return to normal TV viewing. This function can be used to retain a phone number or freeze a football play.

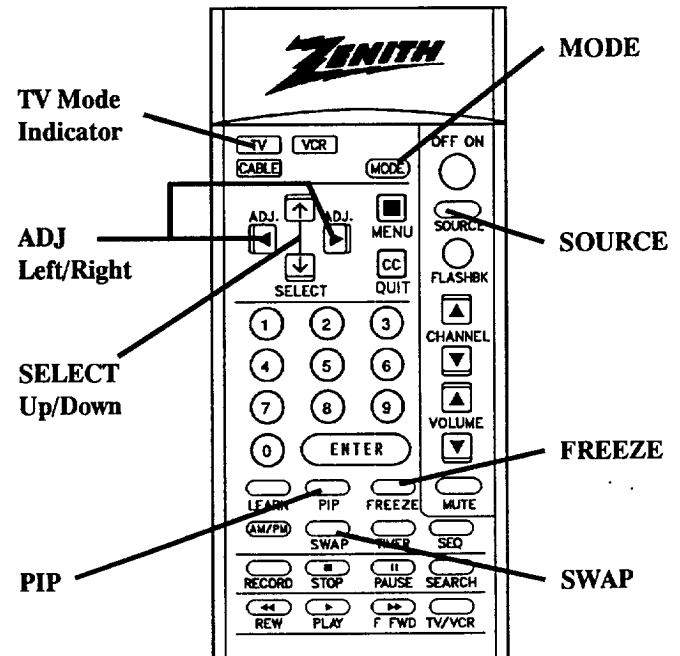

Typical Remote Control
(Your remote may differ from unit shown.)

MAINTENANCE AND TROUBLESHOOTING

CARING FOR YOUR TV

Your TV will look better, have a longer life and perform better if you care for it properly.



First check to see that the TV is off. For added safety, unplug the TV from the power outlet.

NOTE: If you unplug your TV, you will have to reset the clock to the current time.

Picture Glass Cleaning

The picture tube face attracts dust particles and should be cleaned regularly. To clean the face, spray a small amount of glass cleaner on a cleaning cloth and wipe the picture tube glass face until clean. Repeat if necessary.

To delay new dust accumulation, wet a soft cloth in lukewarm water in which a little fabric softener or Ivory dishwashing detergent has been mixed. Wring the cloth almost dry. Wipe the glass face. Make sure no drops of moisture are squeezed onto the glass. Do not wipe the glass dry. Allow the glass to air-dry before you turn the TV on again.

Cabinet Care

Non-Wood Cabinet or Cabinet Components: Moisten a soft cloth with a mild soap solution or Ivory dishwashing detergent. Wipe the surface with a damp cloth. Then rinse the cloth in clean water and wipe the surface again. Allow the TV to air-dry before turning it on.

Wood Cabinets or Cabinet Components: Use any good furniture cleaner and polish. Regular care will help preserve the finish.

EXTENDED ABSENCE

Before an extended absence (such as a vacation) you may want to unplug the TV from the outlet. This will protect the TV from possible damage from lightning or power line surges. If you have an outdoor antenna, you may also want to disconnect the antenna lead-in wires on the back of the TV.

NOTE: If you unplug your TV, you will have to reset the clock to the current time.

TV PICTURE INTERFERENCE

Your TV picture may be affected by interference caused by one or a number of factors.

Nearby Automobile Ignition, Electrical Appliances: Produces a speckled, streaked picture, most noticeable in weak signal areas.

Snow in Picture: Caused by weak signal being received. Usually caused by the TV being located too far from the TV station or by an improper antenna installation.

Ghosts or Reflections: Caused by signals being reflected from surrounding buildings, water tanks, or other high structures.

Radio Signal: Rolling picture, herringbone pattern or torn picture caused by police, amateur or CB radio transmitters.

These interference problems can often be corrected through the use of a better antenna, signal amplifier, or various filter devices. See your TV dealer for additional information, and for available TV accessories.

MAINTENANCE AND TROUBLESHOOTING

BEFORE CALLING FOR SERVICE

Check these items and see if you can correct the trouble by changing the adjustment of a control or the setting of a switch.

By making these simple checks before calling for service, you may save time and money.

Problem

Try This

Picture OK. Poor sound.

Re-orient antenna. Try another channel – possible station trouble. Check for local interference. Check AUTO TUNING and TUNING BAND options on SETUP MENU.

Sound OK. Poor picture.

Re-orient antenna. Try another channel – possible station trouble. Adjust VIDEO MENU options with PICTURE PREF. in CUSTOM mode. Trouble with cable-TV system?

No picture or sound.

Is TV on? Is there power in wall outlet? Is TV plugged in? Is antenna hooked up? Is cable hooked up? Trouble with cable-TV system? Check auxiliary audio/video equipment. Check channel selection. Check TUNING BAND and AUTO TUNING options on SETUP MENU.

Picture blurred or distorted. Ghost in picture.

Check antenna or cable hook up for broken wires. Try another channel – possible station trouble. Check for local interference.

No color, or poor color.

Is it a color program? Check antenna or cable hook up for broken wires. Adjust VIDEO MENU options with PICTURE PREF. in the CUSTOM mode.

No sound.

VOLUME (VOL) setting may be too low. Check MUTE button operation on remote control.

Cannot select certain channels.

Channels may be skipped in CH. ADD/DEL option on SETUP MENU. Check TUNING BAND and AUTO TUNING options on SETUP MENU.

No closed captions

Are captions available? Is CAPTION 1 or CAPTION 2 selected using the CAPTIONS option on the SETUP MENU?

Black or blue box covers half of screen.

Is TEXT 1 or TEXT 2 selected using the CAPTIONS option on the SETUP MENU and is text information available?

No picture or sound when VIDEO 1 or VIDEO 2 source is selected.

Is audio/video source hooked up properly? Are all wires connected to VIDEO 1 IN or VIDEO 2 IN jacks on connection center?

No stereo sound or weak stereo sound when using a stereo VCR.

Check AUDIO mode. Was stereo sound present before selecting VIDEO 1 or VIDEO 2 source?

PIP inset frame is black or lacks contrast when selecting VIDEO 1 for PIP insert source.

Adjust PIP COLOR and PIP CONTRAST settings on PIP MENU. Are all wires connected to VIDEO 1 IN jacks on connection center?

PIP inset frame is snowy when using ANT/CABLE for PIP insert source and VIDEO 1 for main picture source.

Is TV/VCR switch on the VCR in the TV position?

Complete picture loss when using VIDEO 1 for PIP insert source and ANT/CABLE for main picture source.

Is TV/VCR switch on the VCR in the TV position?

Remote control does not work.

Are batteries okay? Is TV turned ON? Is TV plugged in?

Always request that your technician use only genuine Zenith exact replacement parts for continued Quality and Safety performance. Keep your Zenith ALL Zenith.

NOTE: If your TV fails to respond to the PICTURE PREF. selection, or to any other menu selection, you must reset the TV. Simply disconnect the AC power cord from the power outlet. Wait a few minutes, then plug the TV back into the power outlet. You will have to reset the clock to the current time.

YOUR ZENITH WARRANTY

Consumer Protection Plan for Zenith TV

Welcome into the Zenith family! We believe that you will be pleased with your new Zenith Color TV. Please read this Consumer Protection Plan carefully. It is a "LIMITED WARRANTY" as defined under Federal Law. This warranty gives you specific legal rights, and you may also have other rights that vary from state to state within the U.S.A.

Zenith's Responsibility

Service Labor — During a period of 90 days from effective warranty date, Zenith will pay for service labor by a U.S. or Canadian distributor-approved Zenith service center when needed as a result of manufacturing defects.

Parts — New or remanufactured replacements for factory-defective parts will be supplied by a U.S. or Canadian distributor-approved service center for one year from effective warranty date (color picture tube — two years). Such replacement parts are warranted for the remaining portion of the original warranty period.

Home Service — Warranty service for 19" diagonal (U.S.A.) or larger screen size models is provided in the home.

Not Covered — This warranty covers manufacturing defects and does not cover installation, adjustment of customer controls in the home, installation or repair of home antenna systems, cable converters or cable company-supplied equipment; it also does not cover damage due to misuse, abuse, negligence, acts of God or other causes beyond the control of Zenith. Any alteration of the product after manufacture voids this warranty in its entirety.

Owner's Responsibility

Effective Warranty Date — Warranty begins on the date of original consumer installation. For your convenience, keep the dealers dated bill of sale or delivery ticket as evidence of the purchase date.

Operating Guide — Read your Operating Guide carefully so that you will understand the operation of your set and how to adjust the customer controls.

Carry-In Service — Models under 19" diagonal (U.S.A.) screen size must be taken to a distributor-approved Zenith service center for warranty service and must be picked up by the owner.

Antenna — Reception problems caused by inadequate home antennas or faulty antenna connections are the owner's responsibility.

Important: Product Registration — Please fill out and mail your Product Registration Card. It is imperative that Zenith know how to reach you promptly if we should discover a safety problem that could affect you.

Warranty Service — For warranty service information, contact your Zenith dealer preferably, or any distributor-approved Zenith service center. Parts and service labor that are Zenith's responsibility (see above) will be provided without charge. Other service is at the owner's expense. If you have any problem in obtaining satisfactory warranty service, write:

Zenith Electronics Corporation

Customer Service Department

1000 Milwaukee Avenue

Glenview, Illinois 60025-2493

Telephone: (847) 391-8752

Mon-Fri, 8:00 a.m. - 4:30 p.m. Central Time

NOTE: Before you ask for Warranty service, check the Operating Guide section entitled, "MAINTENANCE AND TROUBLESHOOTING." It may be possible to avoid a service call.

ZENITH ELECTRONICS CORPORATION
1000 MILWAUKEE AVENUE
GLENVIEW, ILLINOIS 60025

Part No. 206-2743
Printed in U.S.A.
EP-ED
