

# HITACHI

## SOLID STATE COLOR TV

### 35UX60B

### 35TX10B

## OPERATING GUIDE



**IMPORTANT SAFEGUARDS**

**2 - 5**

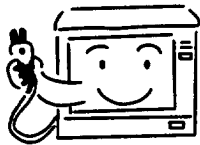

**FIRST TIME USE**

**6 - 24**



**THE GENIUS REMOTE CONTROL**

**25-41**

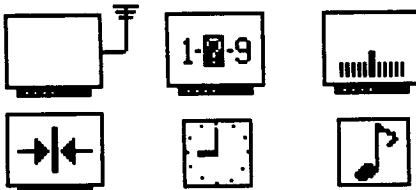

**EASY GRAPHIC GUIDE**

**42 - 63**

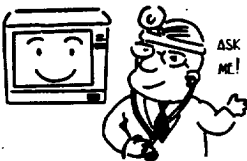

**USEFUL INFORMATION INDEX**

**64-71**



## IMPORTANT

Our new HITACHI COLOR TV incorporates a host of features designed to give you excellent performance if you follow instructions in this manual. We recommend that you read the following instructions and "IMPORTANT SAFETY WARNINGS" notice before turning on your TV set for the first time.

Observe all warnings and instructions marked on this television receiver.

	<b>CAUTION</b> RISK OF ELECTRIC SHOCK DO NOT OPEN			The lightning flash with arrowhead symbol, within an equilateral triangle, is intended to alert the user to the presence of uninsulated "dangerous voltage" within the product's enclosure that may be of sufficient magnitude to constitute a risk of electric shock to persons.
<b>CAUTION: TO REDUCE THE RISK OF ELECTRIC SHOCK, DO NOT REMOVE COVER (OR BACK) NO USER-SERVICEABLE PARTS INSIDE. REFER SERVICING TO QUALIFIED SERVICE PERSONNEL.</b>				The exclamation point within an equilateral triangle is intended to alert the user to the presence of important operating and maintenance (servicing) instructions in the literature accompanying the appliance.

**WARNING:**  
**TO PREVENT FIRE OR SHOCK HAZARD, DO NOT EXPOSE THIS TELEVISION SYSTEM TO RAIN OR MOISTURE.**

- NOTE:**
- There are no user serviceable parts inside the receiver.
  - Model number and serial number are indicated on back side of the set.

### POWER SOURCE:

This HITACHI color TV is designed to operate on 120 volts 60 Hz, AC household current. Insert power cord into a 120 volt 60 Hz outlet.

**TO PREVENT ELECTRIC SHOCK, DO NOT USE THE TELEVISION'S PLUG WITH AN EXTENSION CORD, RECEPTACLE, OR OTHER OUTLET UNLESS THE BLADES AND GROUND TERMINAL CAN BE FULLY INSERTED TO PREVENT BLADE EXPOSURE.**

**NEVER CONNECT THE TV TO 50 Hz, DIRECT CURRENT, OR ANYTHING OTHER THAN THE SPECIFIED VOLTAGE.**

**NOTE:** This television receiver will display television closed captioning, (CC or □), in accordance with paragraph 15.119 of the FCC rules.



**CAUTION:** Never remove the back cover of the set as this can expose you to very high voltages and other hazards. If the set does not operate properly, unplug the set and call your dealer or service shop. HITACHI's 35UX60B employ state-of-the-art computer circuits to enhance picture performance. Should your color TV become unplugged from the AC wall outlet or lose AC power due to a local power failure, please wait at least 30 seconds following return of power before turning on your TV. This will allow the computers time to check/correct any internal errors caused by the loss of power.



# SAFETY TIPS

## IMPORTANT SAFEGUARDS

### SAFETY POINTS YOU SHOULD KNOW ABOUT YOUR HITACHI TELEVISION RECEIVER

#### CAUTION:

- \* Read all of these instructions
- \* Save these instructions for later use.
- \* Follow all warnings and instructions marked on the television receiver.

Our reputation has been built on the quality, performance, and ease of service of HITACHI television receivers.

Safety is also foremost in our minds in the design of these units. To help you operate these products properly, this folder illustrates safety tips which will be of benefit to you. Please read it carefully and apply the knowledge you obtain from it to the proper operation of your HITACHI television receiver.

Please fill out your warranty card at once and mail it to HITACHI. This will enable HITACHI to notify you promptly in the improbable event that a safety problem should be discovered in your model of product.

#### FOR YOUR PERSONAL SAFETY

1 This television set is equipped with a polarized alternating-current line plug (a plug having one blade wider than the other). This plug will fit into the power outlet only one way. This is a safety feature. If you are unable to insert the plug fully into the outlet, try reversing the plug. If the plug should still fail to fit, contact your electrician to replace your obsolete outlet. Do not defeat the safety purpose of the polarized plug.



2 When the power cord or plug is damaged or frayed, unplug this television set from the wall outlet and refer servicing to qualified service personnel.

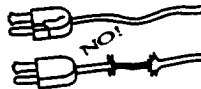

3 Do not overload wall outlets and extension cords as this can result in fire or electric shock.



4 Do not allow anything to rest on or roll over the power cord, and do not place the TV where the power cord is subject to traffic or abuse. This may result in a shock or fire hazard.



5 Do not attempt to service this television set yourself as opening or removing covers may expose you to dangerous voltage or other hazards. Refer all servicing to qualified service personnel.



6 Never push objects of any kind into this television set through cabinet slots as they may touch dangerous voltage points or short out parts that could result in a fire or electric shock. Never spill liquid of any kind on the television set.



7 If the television set has been dropped or the cabinet has been damaged, unplug this television set from the wall outlet and refer servicing to qualified service personnel.



8 If liquid has been spilled into this television set, unplug it from the wall outlet and refer service to qualified service personnel.



9 Do not subject your television set to impact of any kind. Be particularly careful not to damage the picture tube surface.



10 Unplug this television set from the wall outlet before cleaning. Do not use liquid cleaners or aerosol cleaners. Use a damp cloth for cleaning.



11-1 Do not place this television set on an unstable cart, stand, or table. The television set may fall, causing serious injury to a child or an adult, and serious damage to the appliance. Use only with a cart or stand recommended by the manufacturer, or sold with the television set. Wall or shelf mounting should follow the manufacturer's instructions, and should use a mounting kit approved by the manufacturer.



11-2 An appliance and cart combination should be moved with care. Quick stops, excessive force, and uneven surfaces may cause the appliance and cart combination to overturn.



#### PROTECTION AND LOCATION OF YOUR SET

12 Do not use this television set near water, for example, near a bathtub, washbowl, kitchen sink, or laundry tub, in a wet basement, or near a swimming pool, etc.



• Never expose the set to rain or water. If the set has been exposed to rain or water, unplug the set from the wall outlet and refer to servicing personnel.

13 Choose a place where light (artificial or sunlight) does not shine directly on the screen.



14 Avoid dusty places, since accumulated dust inside the chassis may cause failure of the set when high humidity persists.



15 The set has slots, or openings in the cabinet for ventilation purposes, to provide reliable operation of the receiver, and to protect from overheating. These openings must not be blocked or covered.



• Never cover the slots or openings with cloth or other material.

• Never block the bottom ventilation slots of the set by placing it on a bed, sofa, rug, etc.



• Never place the set near or over a radiator or heat register.



• Never place the set in a 'built-in' enclosure, unless proper ventilation is provided.





# SAFETY TIPS

## TECTION AND LOCATION OF YOUR SET

If an outside antenna is connected to the television set, be sure the antenna system is grounded so as to provide some protection against voltage surges and built up static charges. Section 810 of the National Electrical Code, NFPA No. 70-1975, provides information with respect to proper grounding of the mast and supporting structure, grounding of the lead-in wire to an antenna discharge unit, size of grounding conductors, location of antenna discharge unit, connection to grounding electrode, and requirements for the grounding electrode.

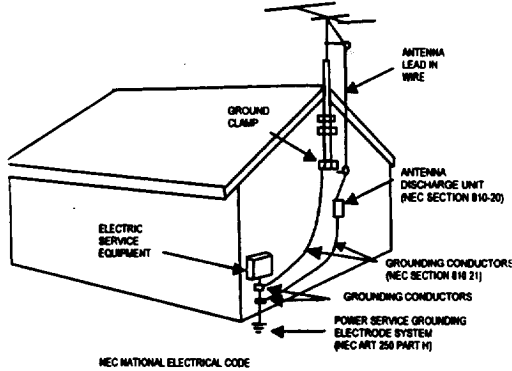

EXAMPLE OF ANTENNA GROUNDING AS PER NATIONAL ELECTRICAL CODE INSTRUCTIONS

16-2 Note to CATV system installer:  
(Only for the television set with CATV reception)  
This reminder is provided to call the CATV system installer's attention to Article 820-40 of the NEC that provides guidelines for proper grounding and, in particular, specifies that the cable ground shall be connected to the grounding system of the building, as close to the point of cable entry as practical.

17 An outside antenna system should not be located in the vicinity of overhead power lines or other electrical lights or power circuits, or where it can fall into such power lines or circuits. When installing an outside antenna system, extreme care should be taken to keep from touching such power lines or circuits as contact with them might be fatal.



18 For added protection for this television set during a lightning storm, or when it is left unattended and unused for long periods of time, unplug it from the wall outlet and disconnect the antenna. This will prevent damage due to lightning and power-line surges.

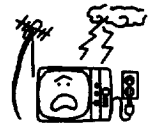

## UTION OF YOUR SET

This television set should be operated only from the type of power source indicated on the marking label. If you are not sure of the type of power supply at your home, consult your television dealer or local power company. For television sets designed to operate from battery power, refer to the operating instructions.

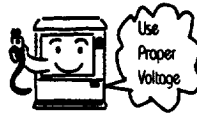

20 If the television set does not operate normally by following the operating instructions, unplug this television set from the wall outlet and refer servicing to qualified service personnel. Adjust only those controls that are covered in the operating instructions as improper adjustment of other controls may result in damage and will often require extensive work by a qualified technician to restore the television set to normal operation.



21 When going on a holiday: If your television set is to remain unused for a period of time, turn the television set "off" and unplug it from the wall outlet.



## IE SET DOES NOT OPERATE PROPERLY

If you are unable to restore normal operation by following the detailed procedure in your operating instructions, do not attempt any further adjustment. Unplug the set and call your dealer or service technician.



23 Whenever the television set is damaged or fails, or a distinct change in performance indicates a need for service, unplug the set and have it checked by a professional service technician.

24 It is normal for some TV sets to make occasional snapping or popping sounds, particularly when being turned on or off. If the snapping or popping is continuous or frequent, unplug the set and consult your dealer or service technician.

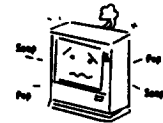

## SERVICING AND MODIFICATION

Do not use attachments not recommended by the television set manufacturer as they may cause hazards.

When replacement parts are required, be sure the service technician has used replacement parts specified by the manufacturer that have the same characteristics as the original part. Unauthorized substitutions may result in fire, electric shock, or other hazards.



27 Upon completion of any service or repairs to the television set, ask the service technician to perform routine safety checks to determine that the television is in safe operating condition.





# **WARNING**

Continuous on-screen displays such as video games, stock market quotations, computer generated graphics, and other fixed (non-moving) patterns can cause permanent damage to color television receivers. Such "PATTERN BURNS" constitute misuse and are NOT COVERED by your Hitachi Factory Warranty.

When using the Picture-in-Picture function, the sub-picture should not be left permanently in one corner of the screen or a "pattern burn" may develop over a long period of time.

This Color television receiver was intended mainly for the private viewing of programs broadcast by TV stations and cable companies and programs from other video sources. Public viewing may require prior authorization from the broadcaster or owner of the video program.



# ACCESSORIES

Check to make sure you have the following accessories before disposing of the packing material.

For information regarding how to obtain these accessories, please call TOLL FREE 1-800-448-2244 for your nearest Hitachi Authorized Parts Distributor in the continental United States. For Alaska and Hawaii, please contact your nearest Hitachi Regional office

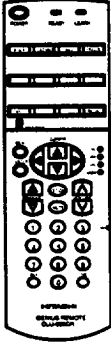
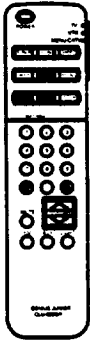
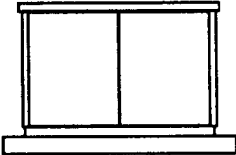
PART NAME	PART NO.	ILLUSTRATION	
.U-850GR REMOTE TRANSMITTER 35UX60B	2573971	 CLU-850GR	 CLU-692GR
.U-692GR REMOTE TRANSMITTER 35TX10B	2573922		
TELEVISION STAND SP350G (Not included, order separately)	H410258		CUSTOM HITACHI TELEVISION STAND Excellent for VCR and videotape storage. Special Features: curved smoke glass doors, adjustable shelf. Available in Black.



**CAUTION:** The television stand model SP350G is designed for use only with HITACHI TV models 35UX60B and 35TX10B. Use with other television equipment may result in instability, causing possible injury.

# REMOTE CONTROL BATTERY INSTALLATION AND REPLACEMENT



1. Open the battery cover of the remote transmitter by pushing the notched part of the cover with your fingers.
2. Insert new "AA" size (SUM-3) batteries or equivalent for the Genius Remote. When replacing old batteries, push them towards the springs and lift them out.
3. Match the (+) and (-) marks in the battery compartment.
4. Replace the cover.

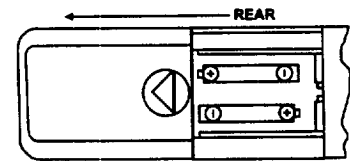
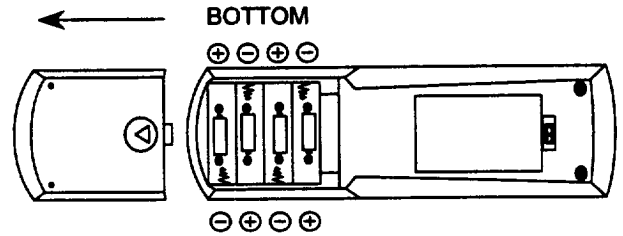

## CAUTIONS

1. If your television set is to remain unused for a long period of time, for instance, when you go on a vacation, unplug the television set from the wall outlet.
2. Do not allow the Remote transmitter to shocks such as dropping it on the floor, etc. Precision parts may be damaged.
3. Do not allow the remote transmitter to become wet and avoid placing it in areas of high humidity. Don't leave it on or near a heater. Excess heat or moisture may cause the unit to cease operation.
4. If the batteries become exhausted, Remote control operation may become erratic or stop altogether. Replace the old batteries with fresh "AA" (SUM-3) types.

## NOTES

1. When the power button is set to OFF, the OFF TIMER is released.
2. The channel No. indication, volume indication and OFF TIMER indication are not displayed simultaneously.
3. To operate your TV, point the Remote transmitter at the remote sensor of the TV.



# HOW TO SET UP YOUR NEW HITACHI COLOR TV

## ANTENNA

If your TV is connected to a cable TV system or to a centralized antenna system, a good outdoor color TV antenna is recommended for the best performance. However, if you are located in an exceptionally good signal area that is free of interference and multiple image ghosts, an indoor antenna may be sufficient.

## LOCATION

Place the TV in an area where sunlight or bright indoor illumination will not fall directly on the picture screen. Also, be sure that the location selected allows a free flow of air to and from the perforated back cover of the set. To avoid cabinet warping, cabinet color changes, and increased chance of set failure, do not place the TV where temperatures can become excessively hot. For example, in direct sunlight or near a heating appliance, etc.

## VIEWING

A major benefit of the HITACHI Color Television is its large viewing screen. To see this large screen at its best, move to various locations in the room to find the best spot for viewing. The drawings give several suggestions.

The best picture is seen by sitting directly in front of the TV about 3 to 6 feet from the screen.

During daylight hours, reflections from outside light may appear on the screen. If so, drapes or screens can be used to reduce the reflection or the TV can be located in a different section of the room.

If the TV's audio output will be connected to a Hi-Fi system's external speakers, the best audio performance will be obtained by placing the speakers equidistant from each side of the receiver cabinet and as close as possible to the height of the picture screen center. For best stereo separation, place the external speakers at least 4 feet from the side of the TV. Place the surround speakers to the side or behind the viewing area. Differences in room sizes and acoustical environments will require some experimentation with speaker placement for best performance.

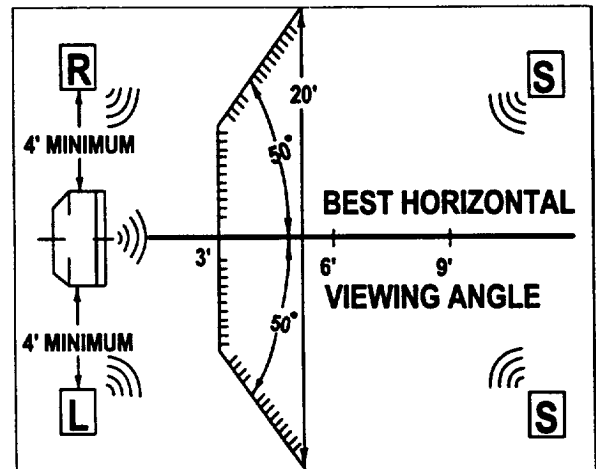
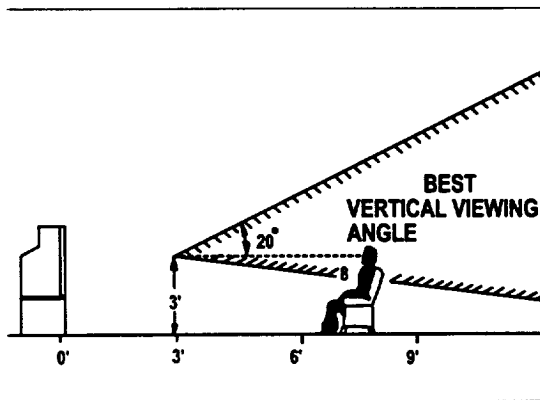

**CAUTION:** The magnetic field of external speakers may cause the TV picture to distort if the speakers are placed too close to the television. Move the speakers away from the TV until there is no picture distortion.



# HOOK-UP CABLES AND CONNECTORS



Most video/audio connections between components can be made with shielded video and audio cables that have phono connectors. For best performance, video cables should use 75-ohm coaxial shielded wire. Cables can be purchased from most stores that sell audio/video products. Below are illustrations and names of common connectors. Before purchasing any cables, be sure of the output and input connector types required by the various components. Also make sure the cables are the correct length.

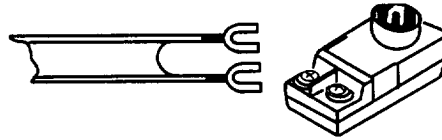

## 300-Ohm Twin Lead Connector

This outdoor antenna cable must be connected to an antenna adaptor (300-Ohm to 75-Ohm).



## "F" Type 75-Ohm Coaxial Antenna Connector

For connecting RF signals (antenna or cable TV) to the antenna jack on the television.



## Phono Connector

Used on all standard video and audio cables which connect to inputs and outputs located on the Television's front and rear jack panels.



## S-Video (Super Video) Connector

This connector is used on camcorders, VCR's, and laser disc players with an S-Video feature in place of the standard video cable to produce a high-quality picture.



# HOOK-UP CABLES AND CONNECTORS

## ANTENNA CONNECTIONS TO REAR JACK PANEL

### FOR 35UX60B

#### (75-Ohm) antenna/CATV(cable TV)

When using a 75-Ohm coaxial cable system, connect the outdoor antenna or CATV coaxial cable to the VHF/UHF 75 Ohm terminal. If you have a second antenna or cable system, connect the coaxial cable to the AUX terminal.

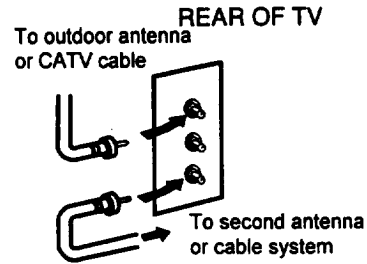

#### (300-Ohm) antenna/UHF antenna

When using a 300-Ohm twin lead from an outdoor antenna, connect the VHF or UHF antenna leads to screws of the VHF or UHF adaptor. Plug the adaptor into the VHF/UHF antenna terminal on the TV.

To outdoor VHF or UHF antenna



When both VHF and UHF antennas are connected, attach an optional antenna cable mixer to the TV antenna terminal, and connect the cables to the antenna mixer. Consult your dealer or service store for the antenna mixer.

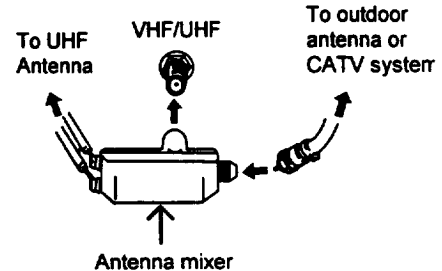

### FOR 35TX10B

#### VHF (75ohm) antenna/CATV

When using a 75 ohm coaxial cable system, disconnect the VHF adaptor from the VHF 75 ohm receptacle and connect the outdoor antenna or CATV cable to a VHF 75 ohm receptacle.

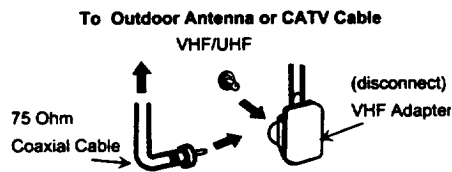

#### 3. When both VHF and UHF antennas are connected

Attach an optional ANT. MIXER to the TV antenna terminal, and connect the cables to the ANT. MIXER.

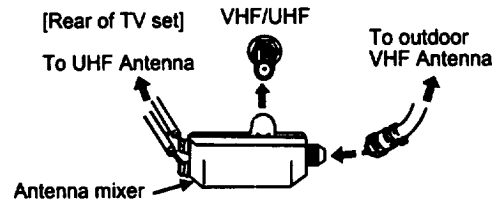

#### VHF (300Ohm) antenna/UHF antenna

When using a 300 ohm twin lead from an outdoor antenna, disconnect the (VHF or UHF) indoor antenna leads from screws of the (VHF or UHF) adaptor, and connect outdoor (VHF or UHF) antenna leads to these screws of a (VHF or UHF) adaptor.

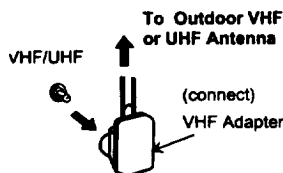

#### Notes:

1. If an outdoor antenna/CATV is to be used, disconnect the indoor antenna. Do not leave both the indoor and outdoor antennas/CATV connected at the same time, since ghosting and poor reception may result.
2. Consult your dealer or service store for the ANT. MIXER and (VHF or UHF) adaptor.
3. The special converter (decoder) will be supplied by the cable company.

# FRONT PANEL CONTROLS FOR 35UX60B



## FRONT VIEW

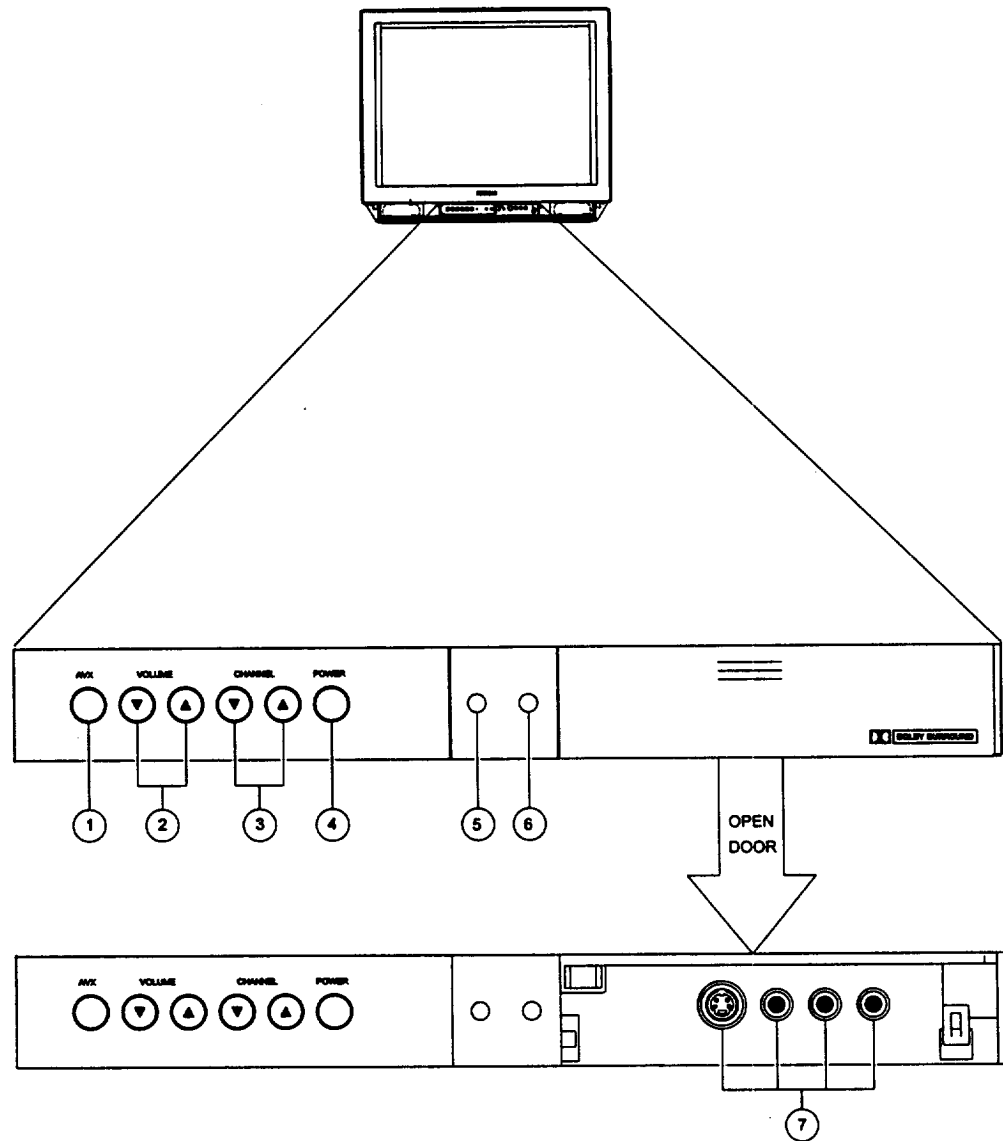

- ① **AVX (Audio/Video) selector**  
Press this button to select the current antenna source, or VIDEO: 1, 2, or 3. Your selection is shown in the top right corner of the screen.
  
- ② **VOLUME level**  
Press these buttons for your desired sound level. The volume level will be displayed on the TV screen.



# FRONT PANEL CONTROLS FOR 35TX10B

## FRONT VIEW

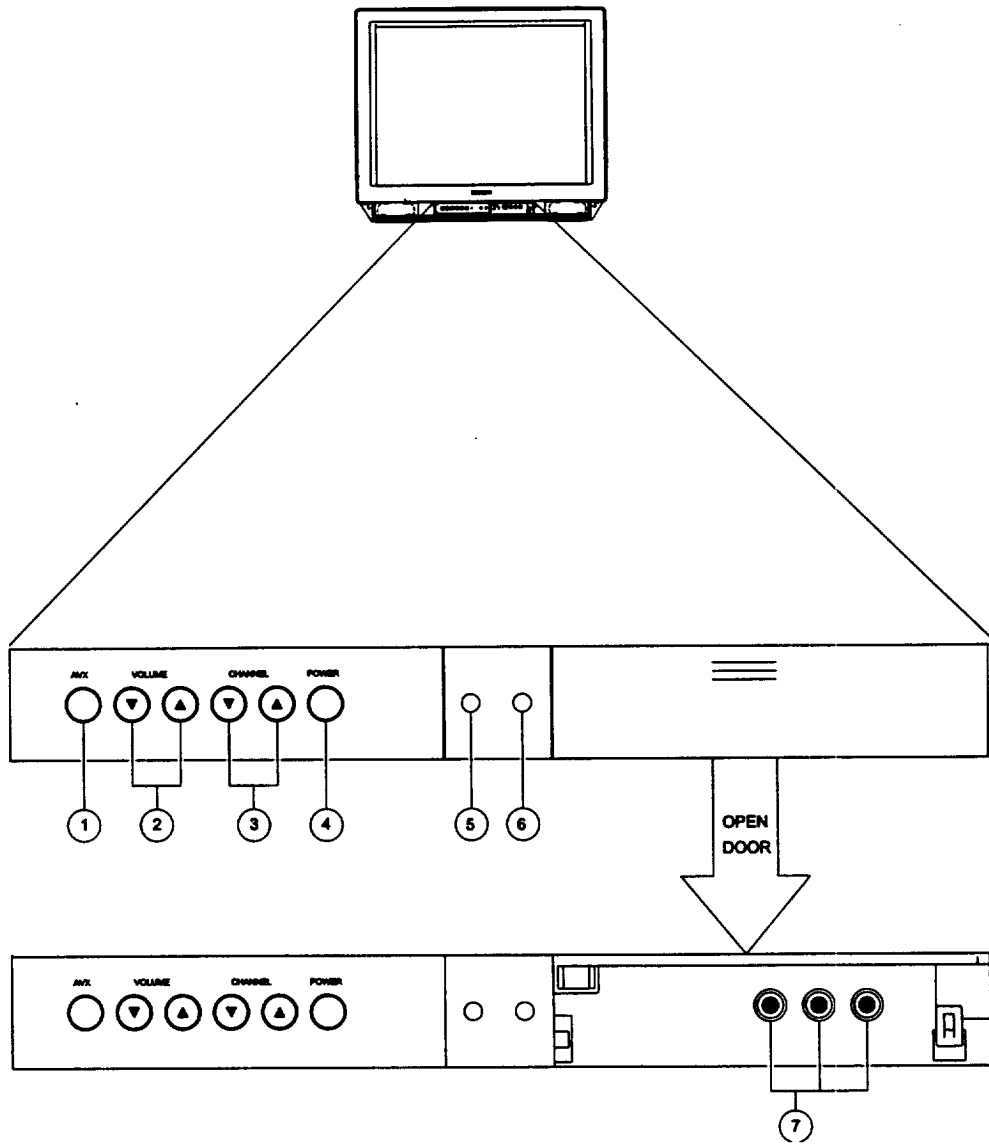

Parts are described by the number attached to the part name. (example: ①)

## FRONT PANEL CONTROLS



- ③ **CHANNEL selector**  
Press these buttons until the desired channel appears in the top right corner of the TV screen.

- ④ **POWER button**  
Press this button to turn the TV on or off.

**NOTE:** Your HITACHI TV will appear to be turned "off" if there is no video input when VIDEO: 1, 2, or 3 is selected. Press AVX until it returns to the same Video, if not Power is "off".

- ⑤ **AI (Artificial Intelligence) sensor**  
This "Artificial Intelligence" sensor will make automatic picture adjustments depending on the amount of light in the room to give the best picture. (See page 55.)
- ⑥ **REMOTE CONTROL sensor**  
Point your Genius Remote at this area when selecting channels, adjusting volume, etc.
- ⑦ **FRONT INPUT JACKS (for VIDEO: 3)**  
Use these audio/video jacks for a "quick" hook-up from a camcorder or VCR to instantly view your favorite show or new recording. (Press the AVX button until VIDEO: 3 appears in the top right corner of the TV screen.)

**NOTE:** Model 35TX10B is not equipped with an S-Video on the front input jacks (for VIDEO: 3)



# FRONT PANEL JACKS AND CONNECTIONS

front panel jacks are provided as a convenience to allow you to easily connect a camcorder or VCR as shown in the following examples:

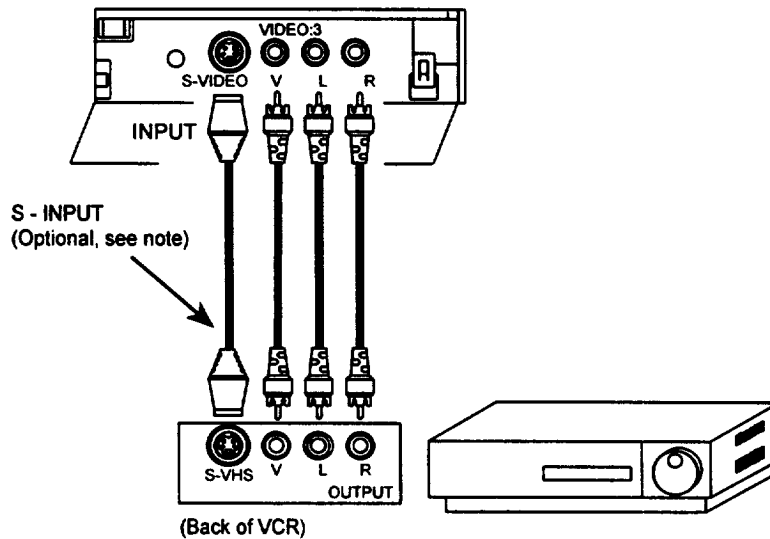
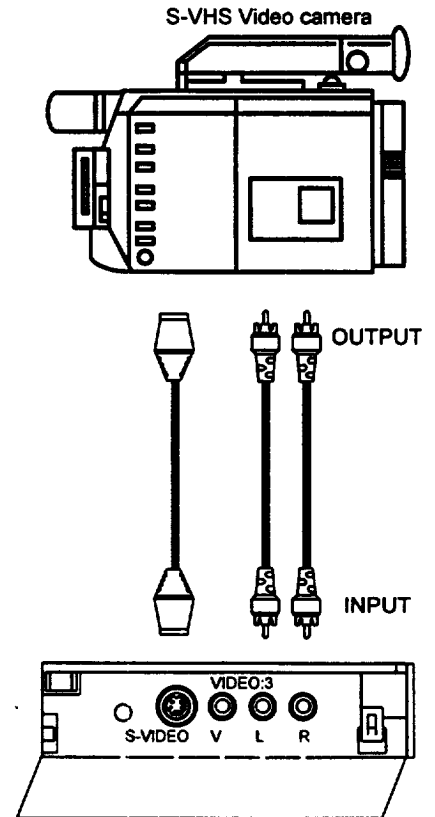
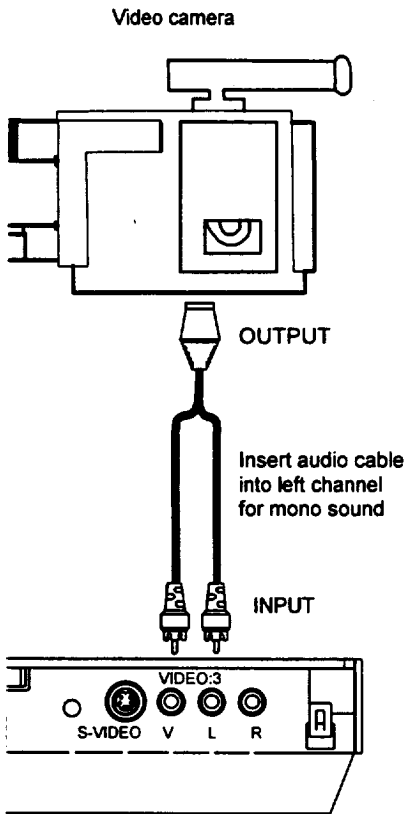

**NOTE:** Completely insert the connection cord plugs when connecting to front panel jacks. If you do not, the played back picture may be abnormal. If you have an S-VHS VCR, use the S-INPUT cable in place of the standard video cable. Model 35TX10B does not have Front Panel S-Video connector.

# REAR PANEL JACKS FOR 35UX60B

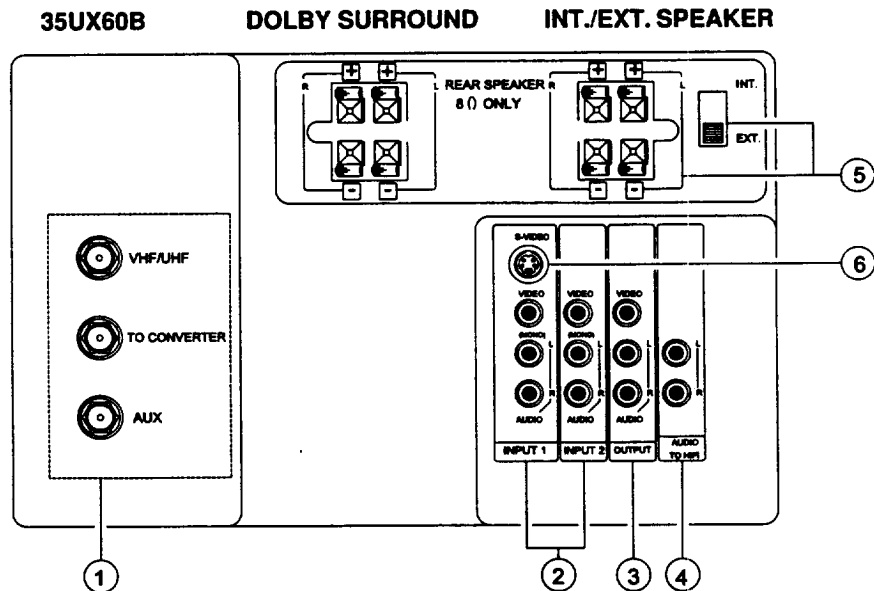

- ① Antenna Inputs/Output**  
 The "ANT" button on the Genius Remote Control allows you to switch between two separate 75-ohm RF antenna inputs, Main (VHF/UHF) and Auxiliary (AUX). The antenna output labeled "To converter" allows the Main (VHF/UHF) antenna connection to pass directly to a different source such as a pay-TV cable decoder.
- ② Audio/Video Inputs 1, 2**  
 The "AVX" (Auxiliary video) button will step through each video source and the current antenna input each time it is pressed. Use the audio and video inputs to connect external devices, such as VCR's, camcorders, laser disc players, video games, etc.
- ③ Output**  
 These jacks provide fixed audio and video signals which are used for recording.
- ④ Audio to Hi-Fi**  
 These jacks provide variable audio output to a separate stereo system amplifier. With this connection, the audio to the stereo can be controlled by the television's remote control. Use these jacks for the SURROUND Left and Right channels. (See page 19, 23 and 24.)
- ⑤ Rear Speaker Terminals**  
 These terminals are used to connect external speakers, which are used for the surround sound feature. The volume level is controlled by the remote control main volume buttons and also by an independent rear volume feature found in the "sound" function menu. Use speakers with 8 Ohm impedance only. Terminals are Dolby external speaker and switchable Internal/External Speakers.
- ⑥ S-Video**  
 Input 1 provides S-Video (Super Video) jacks for connecting equipment with S-Video output capability.

**NOTE:** Model 35TX10B has only one antenna input, no external speaker output connection and no Audio/Video output jacks.

**NOTE:** DOLBY SURROUND SPEAKER connection is used for Dolby surround. There is always a signal coming out from this connection.  
 INT/EXT SPEAKER connection is connected in parallel with the factory built in speaker. By using an optional external speaker, you can select to use which speaker you want by switching the switch located at the rear panel to (INT) Internal for Factory built in speaker or (EXT) External for optional consumer connected speakers, this is On Screen Display controlled either "ON" or "OFF"



# REAR PANEL JACKS 35TX10B

REAR VIEW

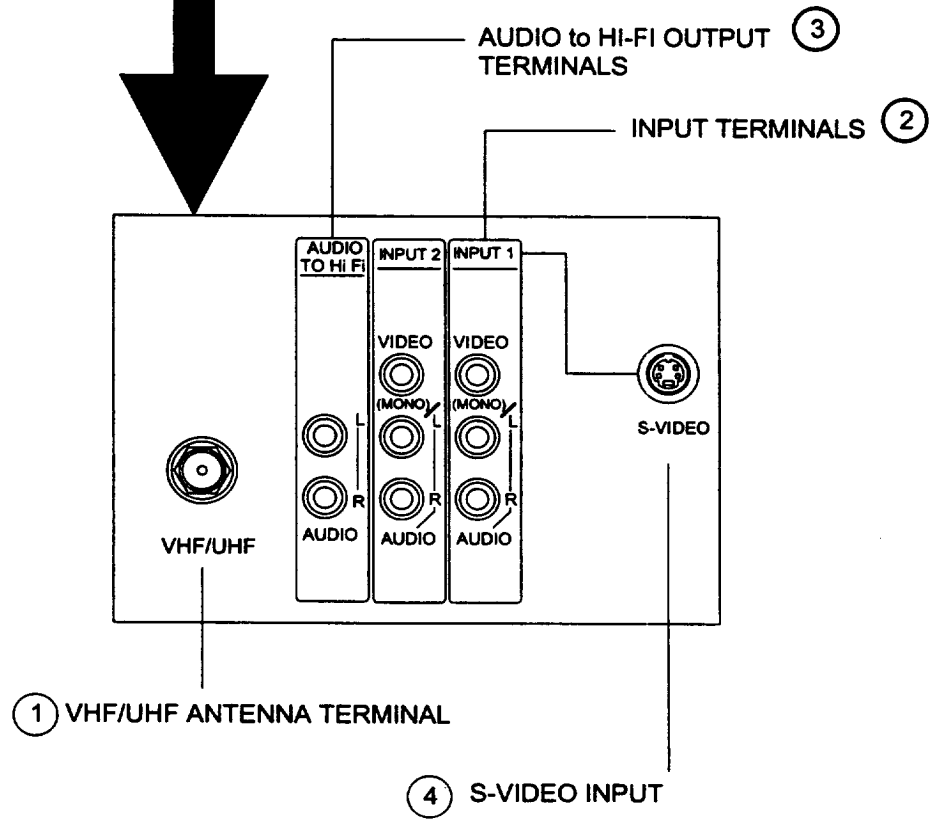
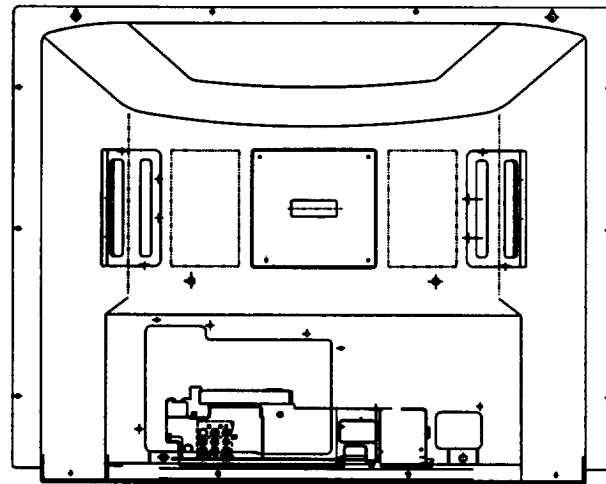



# REAR PANEL CONNECTIONS FOR 35UX60B

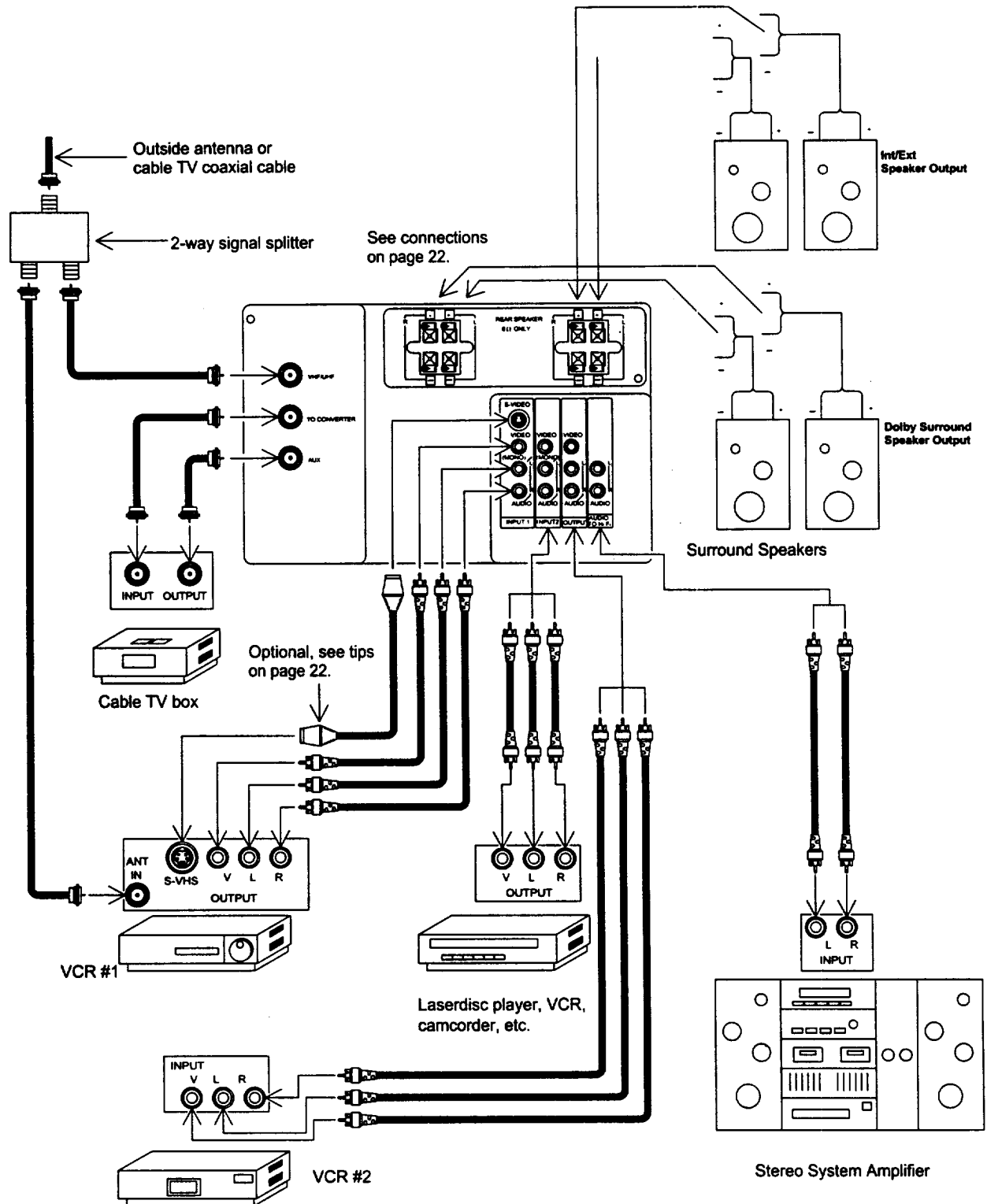

Typical full feature set-up. Follow connections that pertain to your personal entertainment system.

**NOTE:** The Dolby speaker output connection is for Dolby Surround. This is always "ON" whether the Int/Ext Speaker output is "ON" or "OFF". The Int/Ext Speaker output will only have a sound reproduction when switch is on "EXT" and Int. Speaker On Screen Display is "ON"



# REAR PANEL CONNECTIONS FOR 35TX10B

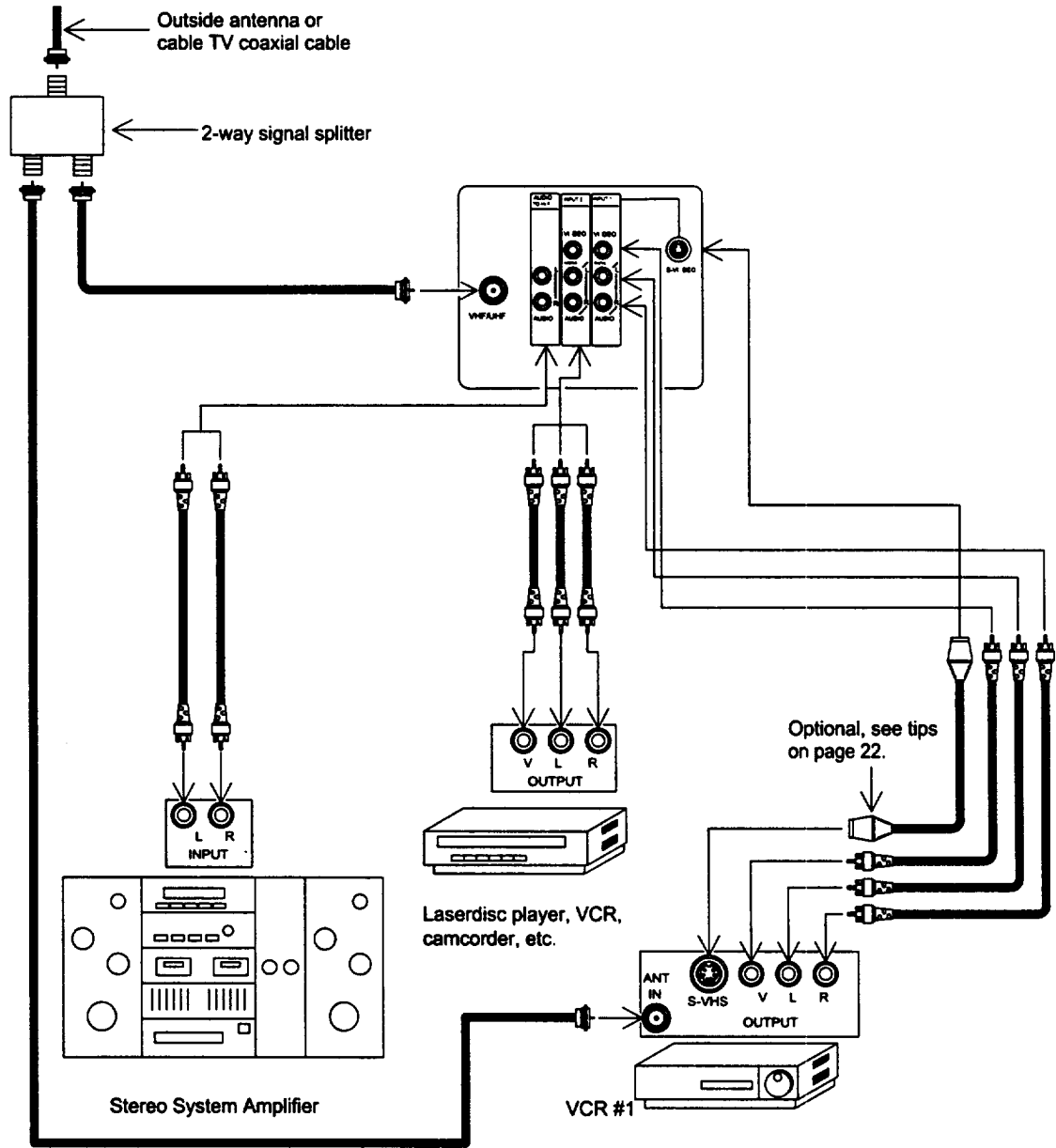

# EXTERNAL CONNECTIONS



## CONNECTING EXTERNAL AUDIO AMPLIFIER

To control the audio level of an external audio amplifier with the remote transmitter, connect the system as shown below in Fig. 1.

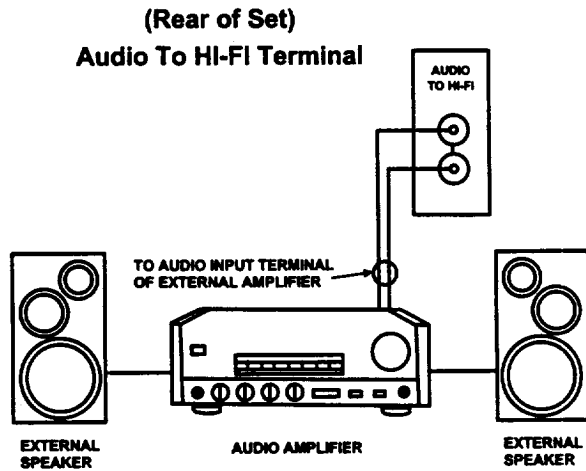

FIG. 1

**NOTE:** To prevent damage to the speaker and distorted sound, set the volume control of the audio amplifier lower and adjust the sound level using the volume control on the remote transmitter of the TV set.



# CONNECTING EXTERNAL VIDEO SOURCES

The exact arrangement you use to connect the Video Cassette Recorder, Video Disc Player and Video Camera to your set is dependent on the model and features of each component. Check the Owner's Manual of each component for the location of its video and audio inputs and outputs. The following connection diagrams are offered as suggestions. However, you may need to modify them to accommodate your particular assortment of components and features. For best performance, video and audio cables should be made from coaxial shielded wire.

## Before Operating External Video Source

The input mode is changed every time the AVX button is pressed as shown below. Connect External source to the INPUT terminal, then press the AVX button as necessary to view the input source.

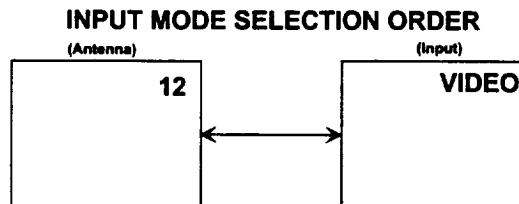

**NOTE:** When TV is set to "VIDEO" and a video signal is not received from VIDEO INPUT JACK on the jack panel of the TV (i.e., VCR/Video Disc Player, etc. is not connected or the video device is OFF), the screen will be black.

## CONNECTING MONAURAL AUDIO VCR OR VIDEO DISC PLAYER

Connect the cable from the VIDEO OUT of the VCR or the Video Disc Player to the INPUT (VIDEO) jack on the TV set. (Fig. 1)

Connect the cable from the AUDIO OUT of the VCR or Video Disc Player to the INPUT (MONO)/L(AUDIO) jack. (Fig. 1)

Press the AVX button to view the program from the VCR or Video Disc Player. The video mode "VIDEO" disappears automatically after approx. 8 seconds.

Press the AVX button to return to the previous channel.

See Below.

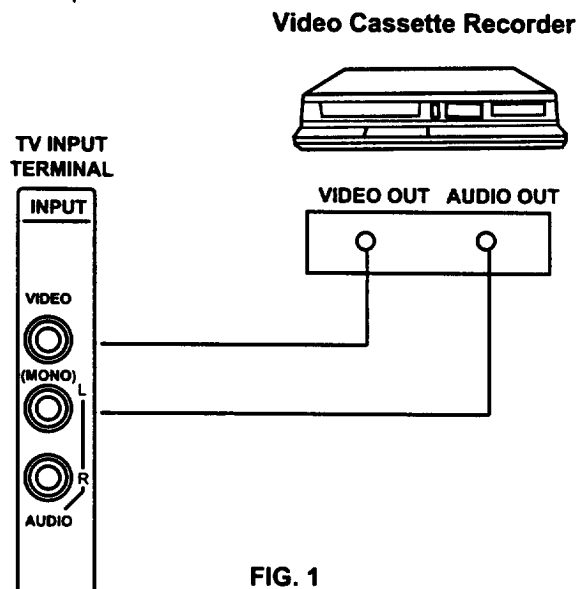

FIG. 1

# CONNECTING EXTERNAL VIDEO SOURCES



## CONNECTING STEREO VCR OR STEREO VIDEO DISC PLAYER

1. Connect the cable from the VIDEO OUT of the VCR or the Video Disc Player to the "INPUT (VIDEO)" jack on the TV set. (Fig. 1)
2. Connect the cable from the AUDIO OUT "R" of the VCR or the Video Disc Player to the "INPUT(AUDIO)R)" jack. (Fig. 1)
3. Connect the cable from the AUDIO OUT "L" of the VCR or the Video Disc Player to the "INPUT(AUDIO/L)" jack. (Fig. 1)
4. Press the AVX button to view the program from the VCR or Video Disc Player. The video mode "VIDEO" disappears automatically after approx. 8 seconds.
5. Press the AVX button to return to the previous channel.

### Video Cassette Recorder

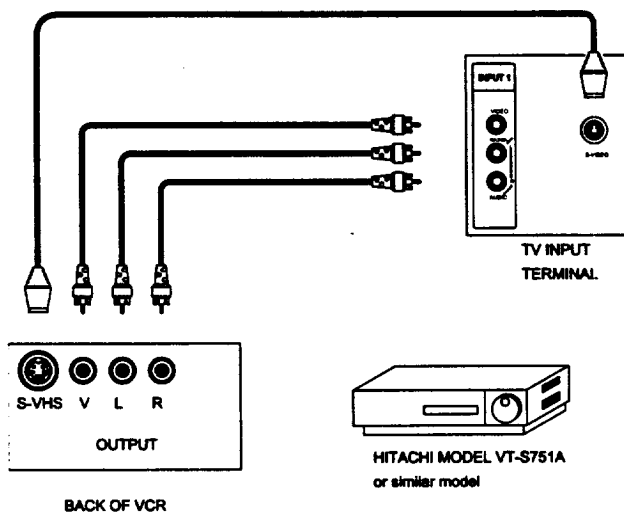
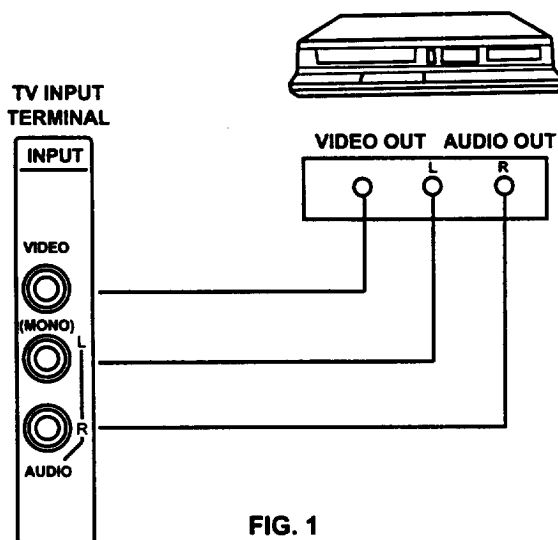

**NOTE:** Completely insert the connection cord plugs when connecting to REAR panel jacks. If you do not the played back picture may be abnormal.

If you have an S-VHS VCR, use the S INPUT cable in place of the standard video cable.



## REAR SPEAKER TERMINAL CONNECTIONS FOR 35UX60B

nect after turning the power of the TV "OFF".

is the Right Speaker red button and insert the positive(+) lead wire into the hole below the button. When The button released, the wire is locked into place. In the same manner, press the Right Speaker black button and insert the negative lead wire. Repeat this procedure for the Left Speaker.

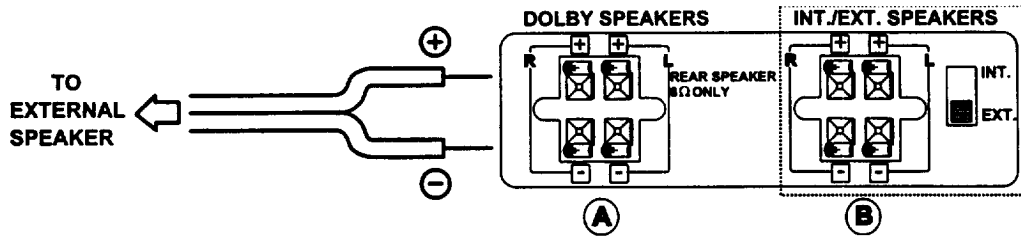

### Dolby Surround External Connection

This is used for DOLBY Surround, sound signal is always "ON".

### INT./EXT. SPEAKER CONNECTION

This is controlled by the remote transmitter thru the on screen display. It can be turned "ON" or "OFF" with the INT./EXT. switch that could be set to factory built in Internal speaker or to an optional Ext. Speaker.



**CAUTION:** Do not connect Speakers simultaneously to the REAR SPEAKER terminal of the Color TV and an external amplifier. This could damage both the TV and the speakers. Your TV was designed to use 8 Ohm speakers only. Any other type may degrade the audio performance of your entertainment system.

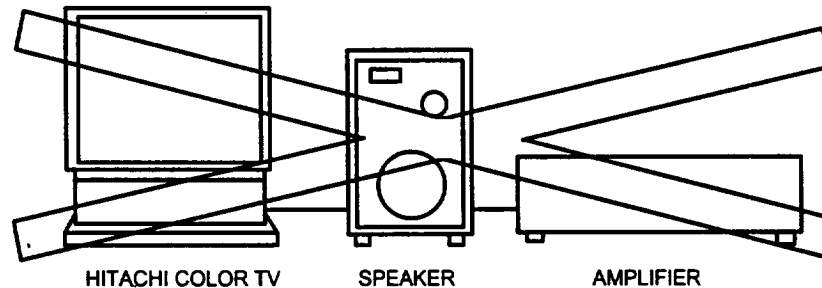

## NOTES ON REAR PANEL CONNECTIONS

S-Video connection is provided for high performance laser discs, VCR's, etc., that have this feature. Use this connection in place of the standard video connection if your device has this feature.

If your device has only one audio output (mono sound), connect it to the left audio jack on the TV.

Refer to the operating guide of your other electronic equipment for additional information on connecting your hook-up cables.

A single VCR can be used for VCR #1 and VCR #2, but note that a VCR cannot record its own video or line output (INPUT: 1 in the example on p. 17). Refer to your VCR operating guide for more information on "line" input-output connections.

# AUDIO SYSTEM SET-UP FOR 35UX60B



Match the numbers below to the diagram for speaker placement and refer to the table for the different surround sound requirements. (See page 62 for SURROUND functions.)

- ① The television's internal speakers.
- ② These speakers are connected to a separate audio amplifier. Use the "Audio to Hi-Fi" output on the TV.
- ③ These speakers are connected to the Rear Speaker 8 Ohm output on the TV.

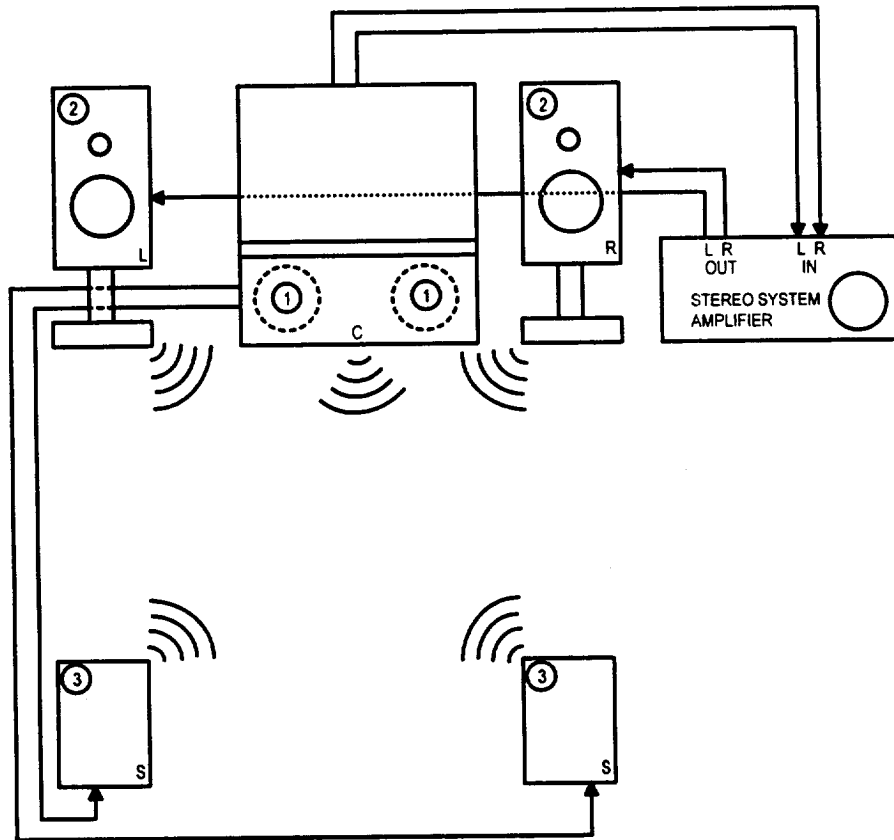

SURROUND FEATURE	REQUIRED CONNECTION	OPTIONAL CONNECTION	EFFECT
OFF	①	② ③	Receive Mono and Stereo Sound.
HALL	①	② ③	Concert Hall Sound.
MATRIX	① ③	②	Feeling of being at a Stadium.
DOLBY	① ②	③	Movie Theater Reproduction, Surround Channel added to left and right audio amplifier speakers.



## AUDIO SYSTEM SET-UP FOR 35TX10B

Match the numbers below to the diagram for speaker placement and refer to the table for the different surround sound requirements. (See page 61 for SURROUND functions.)

- ) The television's internal speakers.
- ) These speakers are connected to a separate audio amplifier. Use the "Audio to Hi-Fi" output on the TV.

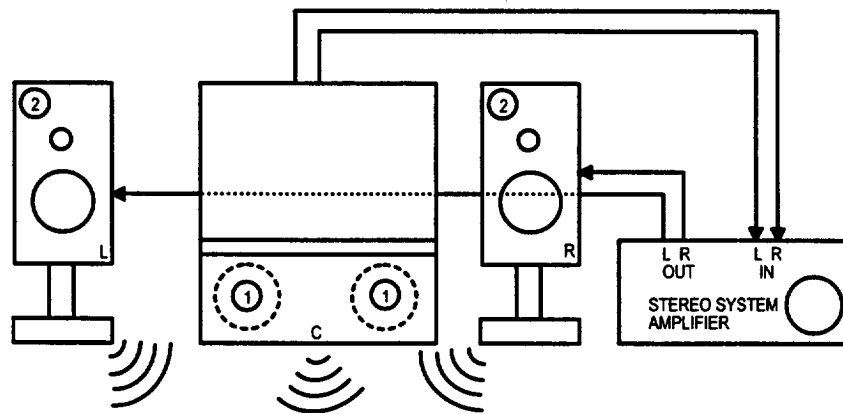

SURROUND FEATURE	REQUIRED CONNECTION	OPTIONAL CONNECTION	EFFECT
OFF	①	②	Receive Mono and Stereo Sound.
SIMULATE	①	②	At Mono Input, sound is changed more loudly
MUSIC	① ②	—	At stereo Input, sound of music is changed more loudly, Surround Channel added to left and right Audio Amplifier speakers.
MOVIE	① ②	—	Movie Theater Reproduction, Surround Channel added to left and right audio amplifier speakers.





# THE GENIUS REMOTE CONTROL (CLU-850GR)

In addition to controlling all the functions on your HITACHI Color TV, the new Genius Remote is designed to operate different types of VCR's and different types of CATV (Cable TV) converters with one touch. Basic operation keys are grouped together in one area. All other controls are separated from them and arranged in MULTI-PAGE

sections, with a display that can be switched to cover any of the four pages. Functions are arranged and properly categorized into windows, making operation simple when multiple functions are to be controlled.

To operate your TV, point the Genius Remote at the remote sensor of the TV.  
To operate your VCR, point the remote at the remote sensor of the VCR.

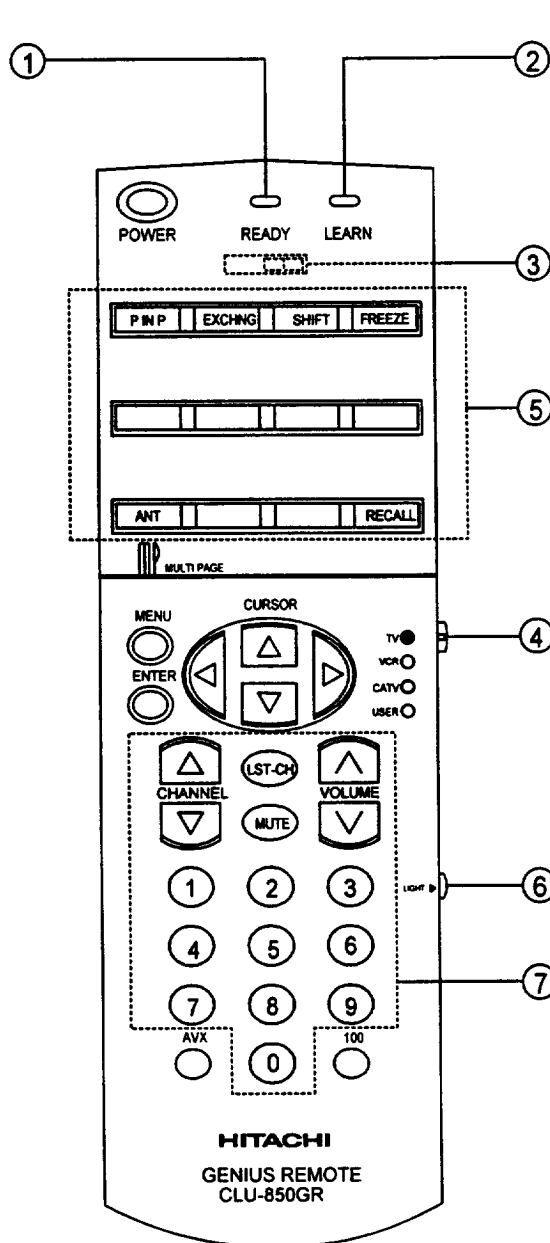

- ① **READY indicator light**  
Refer to Page 38.
- ② **SEND/LEARN indicator light**  
Refer to page 38.
- ③ **LEARN/USE select switch**  
(Located on rear side of remote control)

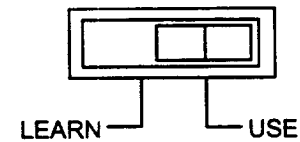

LEARN. . . . . Enters the Learning mode.  
(Refer to page 38.)  
USE. . . . . Set for normal use.

- ④ **MULTI-PAGE select switch**  
This selects the button layout of the multi-page section of the remote control.
- ⑤ **MULTI-PAGE buttons**  
These buttons change functions as shown on page 26.
- ⑥, ⑦ **LIGHT button**  
When you are in a dark room, press this button on the side of the remote to light up the buttons shown in ⑦. The light will stay on for about 8 seconds if no button is pressed. The buttons will not appear to light if the room is too bright.



# MULTI-PAGE WINDOWS

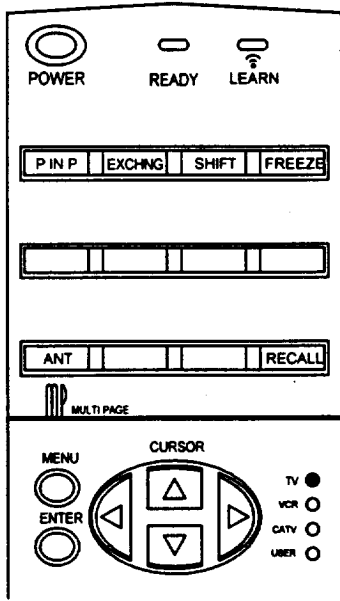

When "TV" is set

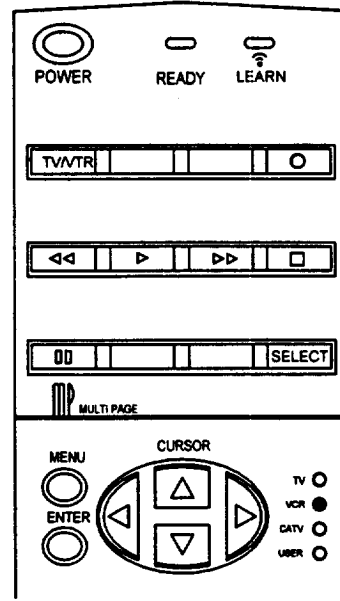

When "VCR" is set

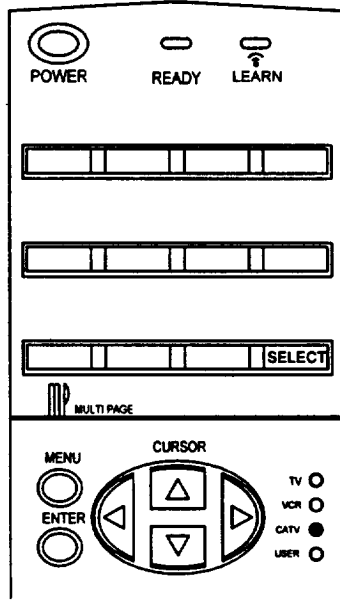

When "CATV" is set

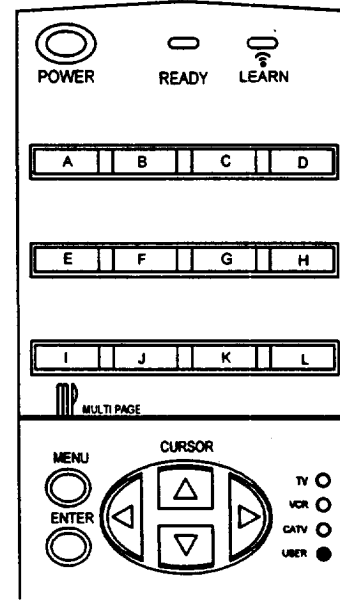

When "USER" is set

# THE GENIUS REMOTE CONTROL (CLU-692GR)



In addition to controlling all the functions on your HITACHI Color TV, the Genius Remote control is designed to operate different types of VCR's (Also Abbreviated VTR) and different types of CATV converters (cable boxes) with one touch. Basic operating buttons are grouped together in one area. All other controls are separated from them

and arranged in MULTI-PAGE sections, with a display that can be switched to cover any of the three pages. Function are arranged and properly categorized into windows. Making operation simple even when multiple functions are to be controlled.

**NOTE:** Precoded buttons (⑥ below) will control HITACHI TV only when the MULTI-PAGE SELECT SWITCH (① below) is set to "TV" mode.

To operate your TV, point the Genius remote at the remote sensor of the TV.  
 To operate you VCR, point the remote at the remote sensor of the VCR.  
 To operate your cable box, point the remote at the remote sensor of the cable box.

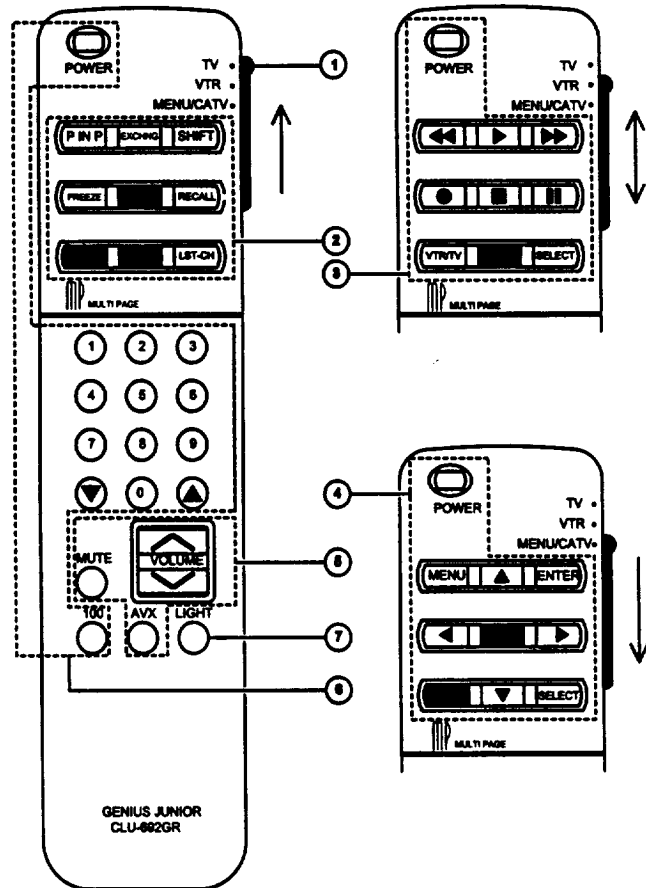

- ① **MULTI-PAGE SELECT SWITCH**  
Slide the switch in the direction of the arrow to select the MULTI-PAGE mode.
- ② **Button layout when "TV" is selected .**  
The P-IN-P, SHIFT EXCHNG and FREEZE buttons.
- ③ **Button layout for "VCR."**  
(Power button turns the VCR on or off.)
- ④ **Button layout for "MENU/CATV."**  
(Power button turns cable box on of off.)  
See pages 30 and 35.
- ⑤ **TV EXCLUSIVE BUTTONS**  
These will always control the TV even when the Multi-Page select switch is in the VCR or MENU/ CATV position.
- ⑥ **PRECODED BUTTONS**  
These buttons will control a VCR or a cable box when the Multi-Page select switch is in the VCR of MENU/CATV position.
- ⑦ **LIGHT BUTTON**  
When you are in a dark room, press this button on to light up the Channel Keys, Volume, Up and Down Keys. The light will stay on for about 8 seconds if no button is pressed. The buttons will not appear to light if the room is too bright.



# HOW TO USE THE GENIUS REMOTE TO CONTROL YOUR TV

Detailed explanation of the circled numbers is on the following pages.

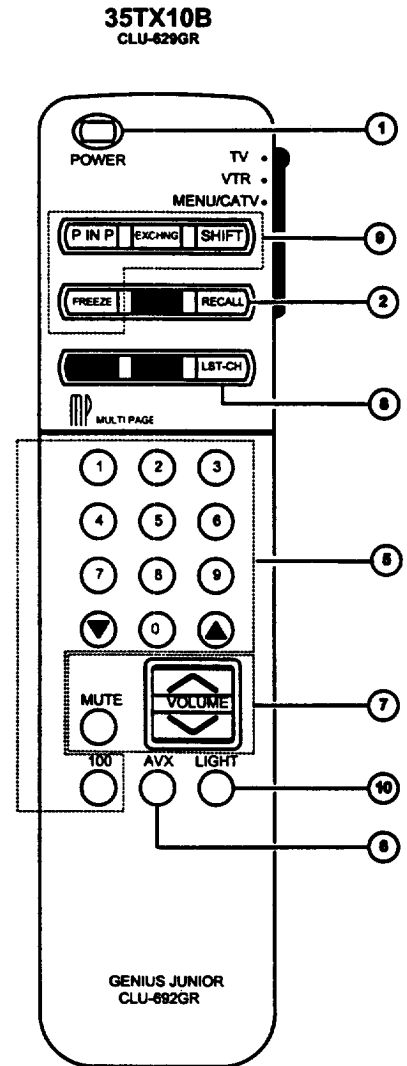
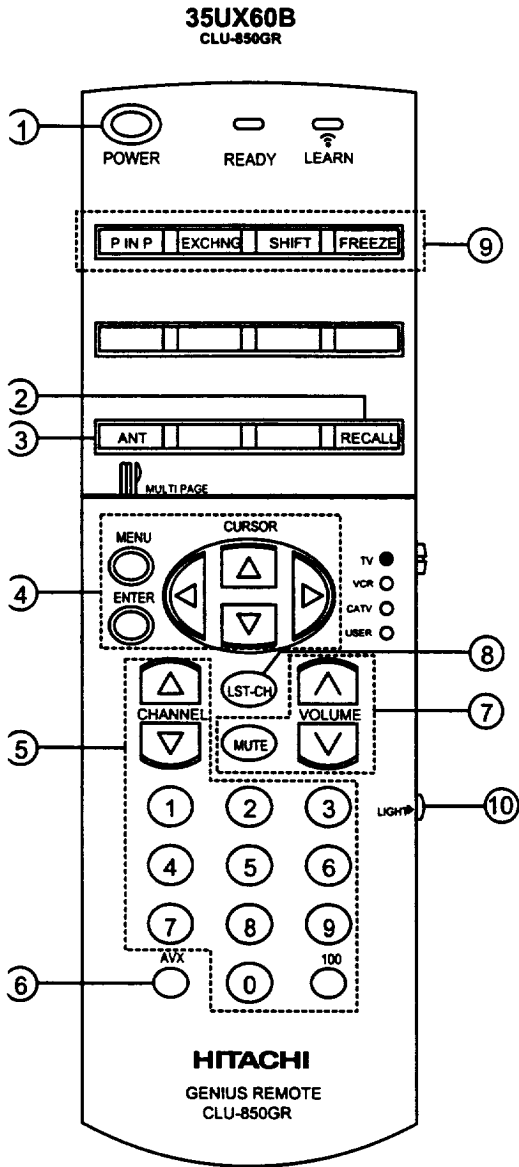

1 Detailed explanation of the circled numbers on the following pages.

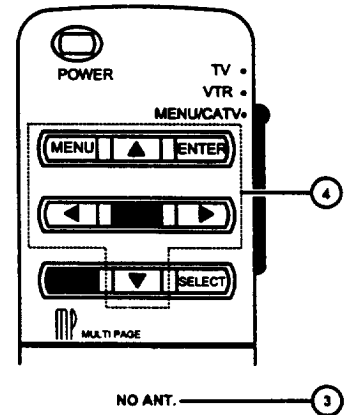

# HOW TO USE THE GENIUS REMOTE TO CONTROL YOUR TV



- ① **POWER button**  
Press this button to turn the TV set on or off. If an automatic message is set, it will be displayed when the TV is first turned on. (See page 53.)
- ② **RECALL button**  
When you want to check the channel being received, or if it has a stereo (ST) or second audio program (SAP), press the RECALL button.

You can also check the time, and if the ON TIME or OFF TIME has been set. (See page 52.)

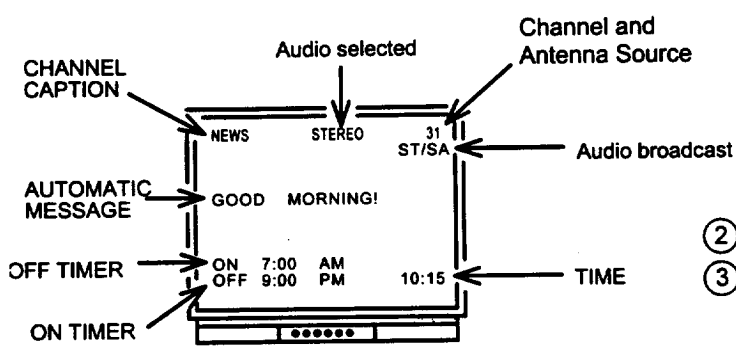

If a video input is used:

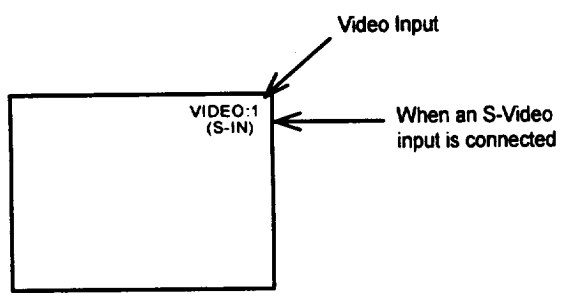

You can also use the RECALL button to quickly clear many of the other on-screen displays.

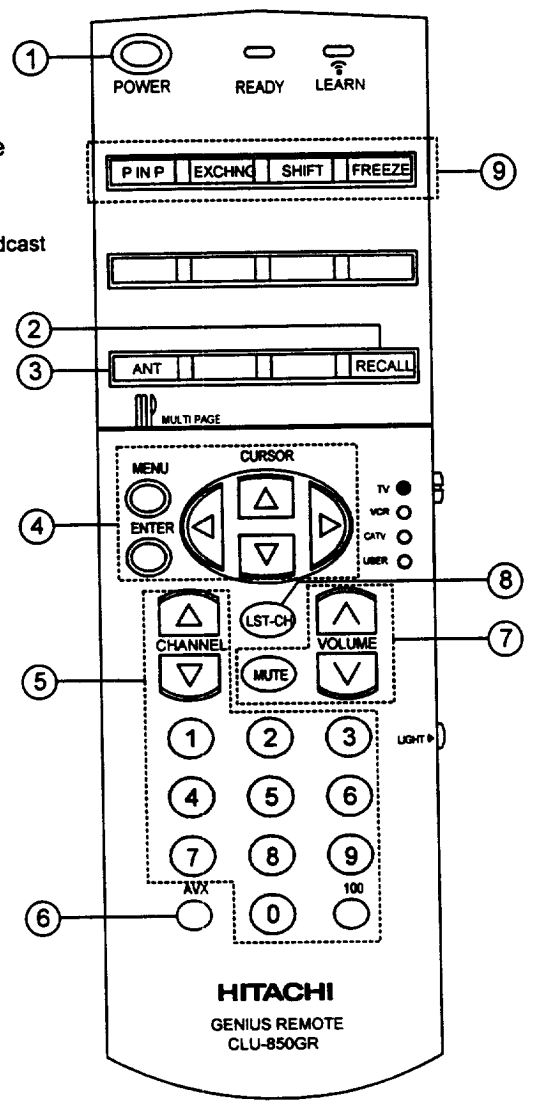



# HOW TO USE THE GENIUS REMOTE TO CONTROL YOUR TV

## ) ANT button (35UX60B only)

Use the ANT (Antenna) button to select between the VHF/UHF and AUX (Auxiliary) antenna inputs.

**NOTE:** When VHF/UHF is selected, the channel number in the upper right corner of the screen is in green. When the AUX input is selected, the channel number is in yellow.

## ) MENU, ENTER, CURSOR buttons

All the on-screen display features can be set or adjusted by using these buttons.

The "MENU" button will start or exit the on-screen display.

The "CURSOR" buttons will highlight functions or adjust different features. These buttons are also used for FAVORITE CHANNELS. (see Page 47.)

The "ENTER" button will set features to your preference.

"CHANNEL SELECTOR" buttons are used to set the time, for channel memory, etc..

## ) CHANNEL SELECTOR buttons

Enter two or three numbers to select channels. Enter a "0" first for channels 1 to 9. Use the "100" button for channels 100 and higher.

Channel selection may also be performed by pressing channel up (▲) or down (▼).

**NOTE:** The TV may not receive some channels if you are not in the correct AIR/CABLE mode. See page 44.

## ) AVX button

The AVX (Auxiliary Video) button will select between the antenna signal and the three sets of video input jacks each time the button is pressed. If the Picture-in-Picture (PinP) is on, the AVX will select between the three sets of video input jacks. (See page 32.)

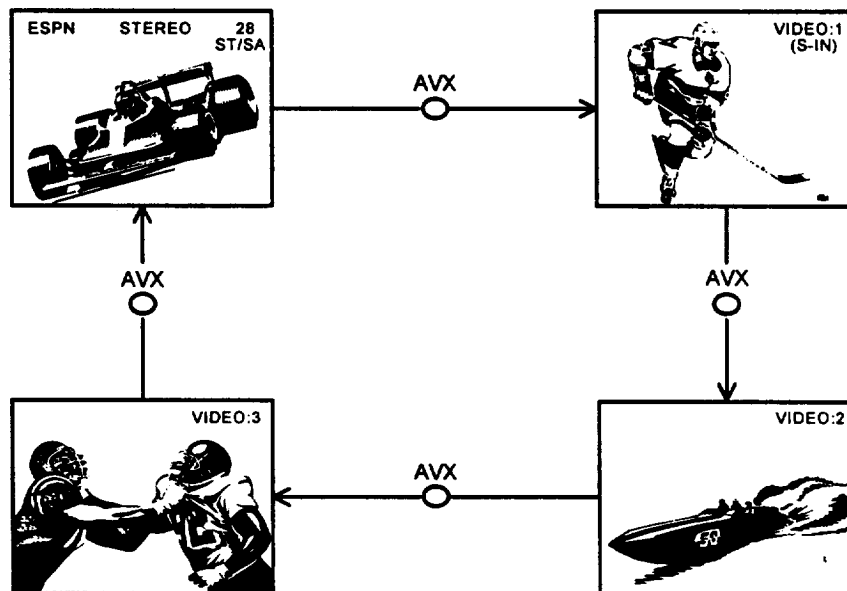

# HOW TO USE THE GENIUS REMOTE TO CONTROL YOUR TV



## ⑦ VOLUME, MUTE buttons

Press the "VOLUME" up (▲) or down (▼) button until you obtain the desired sound level.

To turn the sound off instantly to answer the telephone, etc., press the "MUTE" button. Press the "MUTE" button again or press the "VOLUME" up (▲) button to restore the sound.

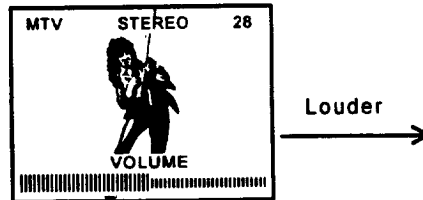

The word "MUTE" will remain displayed if the CLOSED CAPTION feature is turned off.

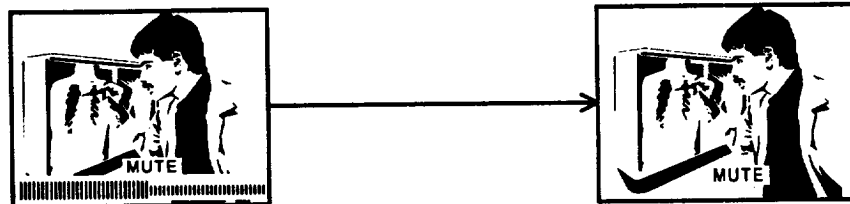

The word "MUTE" will not be displayed if the CLOSED CAPTION feature is on.

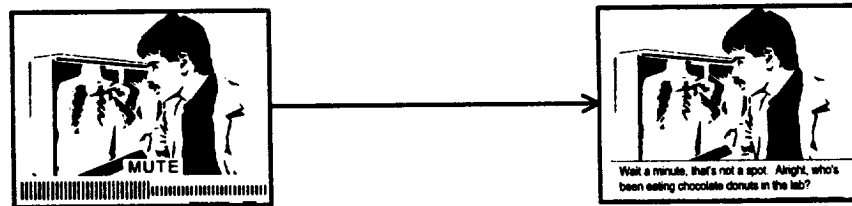

## ⑧ LAST CHANNEL (LST-CH) button

Use this button to select between the last two channels viewed. (Good for watching two sporting events, etc.)

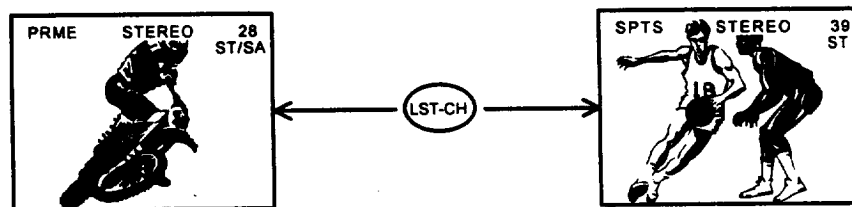

## ⑨ PICTURE-IN-PICTURE buttons

See separate section on page 32 for a description.

## ⑩ LIGHT BUTTON

When you are in a dark room, press this button to light up the volume and channel buttons. The light will stay on for about 8 seconds if no buttons is pressed. The buttons will not appear to light if the room is too bright.



## PICTURE-IN-PICTURE (P-IN-P)

Picture-in-Picture feature is convenient when you want to watch more than one program at the same time. You can watch a TV program while viewing a VCR program (TV or tape) on any of the video inputs, and vice versa with this feature.

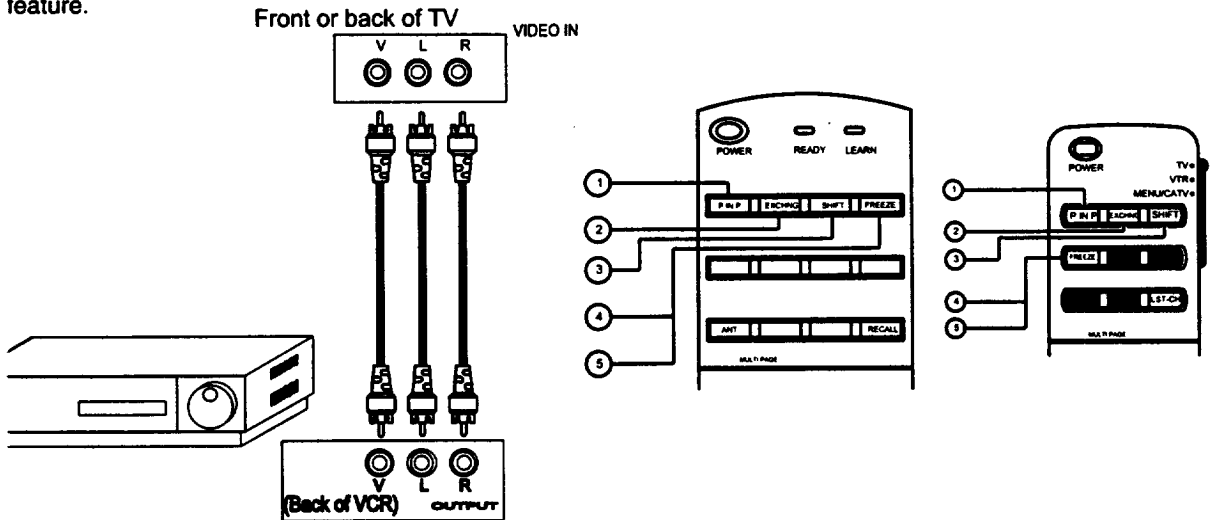

### P-IN-P BUTTON (35TX10B)

Press the "P IN P" button and a sub-picture appears in one corner of the screen. Press the button a second time to remove the sub-picture from the screen. Press the AVX button when the sub-picture is on to change between VIDEO: 1, VIDEO: 2, and VIDEO: 3. The TV channel will always be either the main picture or the sub-picture.

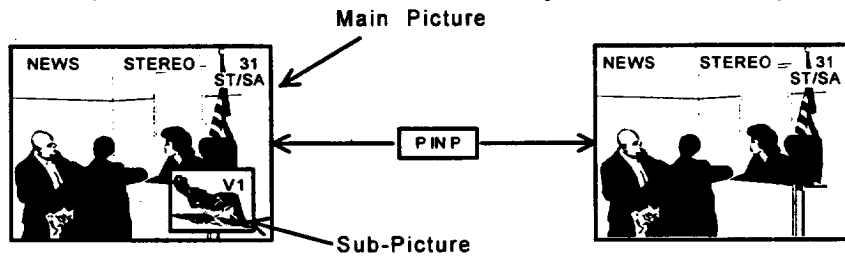

### P-IN-P BUTTON (35UX60B)

Press the "P in P" button and a sub-picture appears in one corner of the screen. To remove the sub-picture from the screen, press the button a second time.

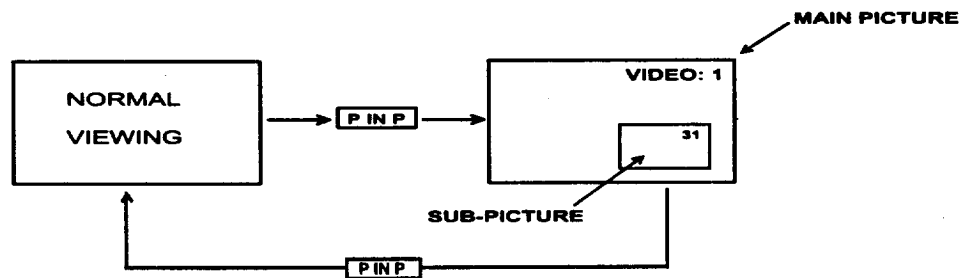

### EXCHNG (EXCHANGE) BUTTON

If you wish to switch what is being shown on the main picture to the sub-picture, press the "EXCHNG" button.

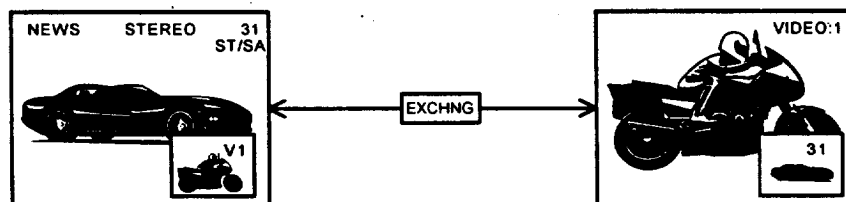





## PICTURE-IN-PICTURE (P-IN-P)

### ③ SHIFT BUTTON

To move the sub-picture to another corner, press the "SHIFT" button. The sub-picture moves one step counter-clockwise every time the "SHIFT" button is pressed.

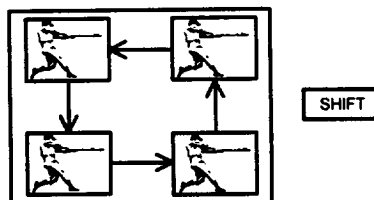

### ④ FREEZE BUTTON

If you wish to freeze the sub-picture, press "FREEZE" button. This is convenient when trying to write down the address for a mail order company, recording statistics for a sporting event, etc. To return to motion, press the button again.

### ⑤ FREEZE BUTTON WITHOUT A SUB-PICTURE

Press this button without a sub-picture to freeze the picture you are currently viewing. Press this button again or P IN P to return to normal viewing. The EXCHNG picture-in-picture function will not work with this FREEZE function.

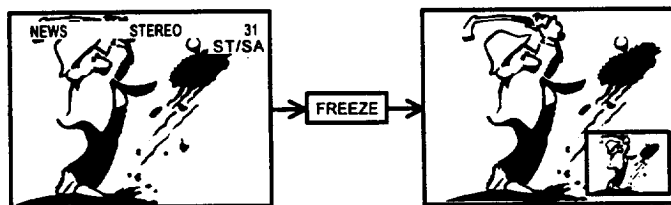

**CAUTION:** A pattern burn may develop if the sub-picture is left in the same corner permanently. If the P-IN-P feature is used frequently, occasionally shift the sub-picture to a different corner.

#### NOTE:

1. Only sound from the main picture can be heard.
2. P-IN-P will not work with a CHILD LOCK channel as the Main Picture but it will be displayed as a Sub-Picture.
3. The Sub-Picture will not appear while a FAVORITE CHANNEL is being selected. The Sub-Picture will reappear after the FAVORITE CHANNEL display is gone.
4. When the "P-in-P" button is pressed, the sub-picture will appear in the same position as previously set.
5. The "FREEZE" function is released when the "EXCHNG" button is pressed.



# USING THE GENIUS REMOTE TO CONTROL VCR FUNCTIONS

## erating the pre-Coded function for your VCR

s Genius Remote is designed to operate different types of VCRs. You must first program the Genius Remote to match remote system in your VCR. (Refer to Table 1 on page 36 or Table 3 on page 37.)

Set the MULTI-PAGE select switch to "VCR."

Set the USE/LEARN mode select switch on the rear side of the Genius Remote to "USE." (For CLU-850GR only)

Turn ON your VCR.

Aim the Genius Remote control at the front of your VCR.

While holding down the SELECT button, press the button that matches your VCR as shown on page 36 or page 37. Continue to hold down both buttons. The channels of the VCR will begin changing when the correct button is pressed. When this occurs, the Genius Remote Control is programmed for your VCR. If the VCR channels do not change after 5 seconds, try a different Genius Remote button.

Release both buttons when the VCR starts to change channels. The Genius Remote will now control your VCR.

### NOTES:

1. If your VCR cannot be operated after performing the above procedures, this means that your VCR's codes have not been precoded into the GENIUS REMOTE. Please store your VCR codes in memory by using the USER mode. (Refer to page 38.)
2. The GENIUS REMOTE CONTROL will remember the codes you have programmed in until the batteries are removed from the GENIUS REMOTE CONTROL. After replacing the batteries repeat the entire programming procedure stated above.
3. If you have a play back only VCR (no CH UP/DOWN function), please follow operating step 5 described above and then check a VCR function until you find the button that will allow the precoded VCR buttons to operate your VCR.

### ) PRECODED VCR BUTTONS

These buttons always transmit the chosen precoded VCR codes.

### ) SELECT BUTTON

This is for setting up the Genius Remote to transmit the VCR's remote codes.

### ) EXCLUSIVE TV BUTTONS

These buttons are for operating the TV.

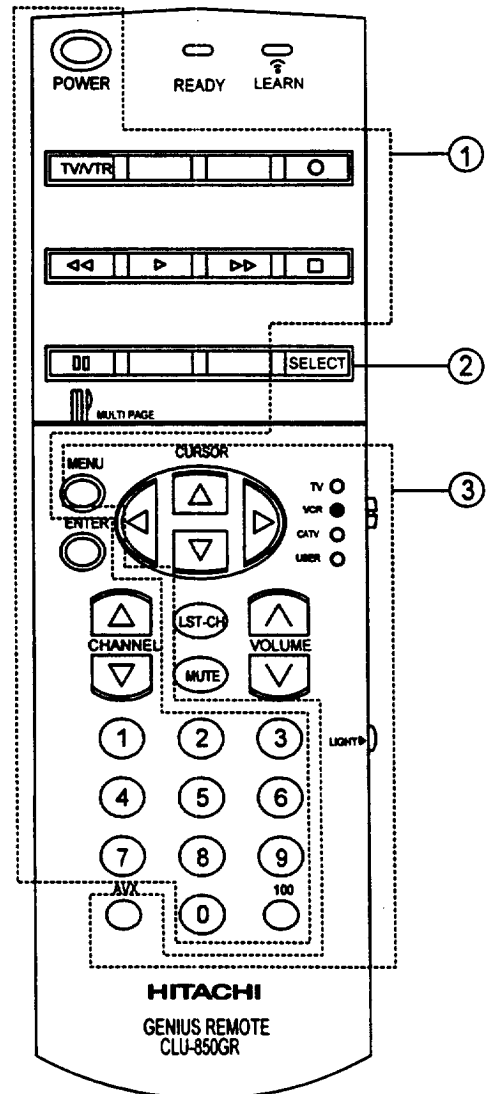

# USING THE GENIUS REMOTE TO CONTROL CABLE BOX FUNCTIONS



## Operating the pre-coded function for your cable box

This Genius Remote is designed to operate different types of cable boxes. You must first program the Genius Remote to match the remote system in your cable box. (Refer to Table 2 on page 36 or Table 4 on page 37.)

1. Set the MULTI-PAGE select switch to "CATV."
2. Set the USE/LEARN mode select switch to "USE." (For CLU-850GR only)
3. Turn ON your cable box.
4. Aim the Genius Remote control at the front of your cable box.
5. While holding down the SELECT button, press the button that matches our cable box as shown on page 36 or page 37. Continue to hold down both buttons. The channels of the cable box will begin changing when the correct button is pressed. When this occurs, the Genius Remote Control is programmed for your cable box. If the cable box channels do not change after 5 seconds, try a different Genius Remote button.
6. Release both buttons when the cable box starts to change channels. The Genius Remote will now control your cable

### NOTES:

1. If your cable box cannot be operated after performing the above procedures, this means that your cable box codes have not been precoded into the GENIUS REMOTE. Please store your cable box codes in memory by using the USER mode. (Refer to page 38.)
2. The GENIUS REMOTE CONTROL will remember the codes you have programmed in until the batteries are removed from the GENIUS REMOTE CONTROL. After replacing the batteries, repeat the entire programming procedure stated above.

- ① **PRECODED FOR CABLE BOX**  
These buttons always transmit the chosen precoded CATV codes.
- ② **SELECT BUTTON**  
This is for setting up the cable box's Pre-code.
- ③ **EXCLUSIVE TV BUTTONS**  
These buttons are for operating the TV.

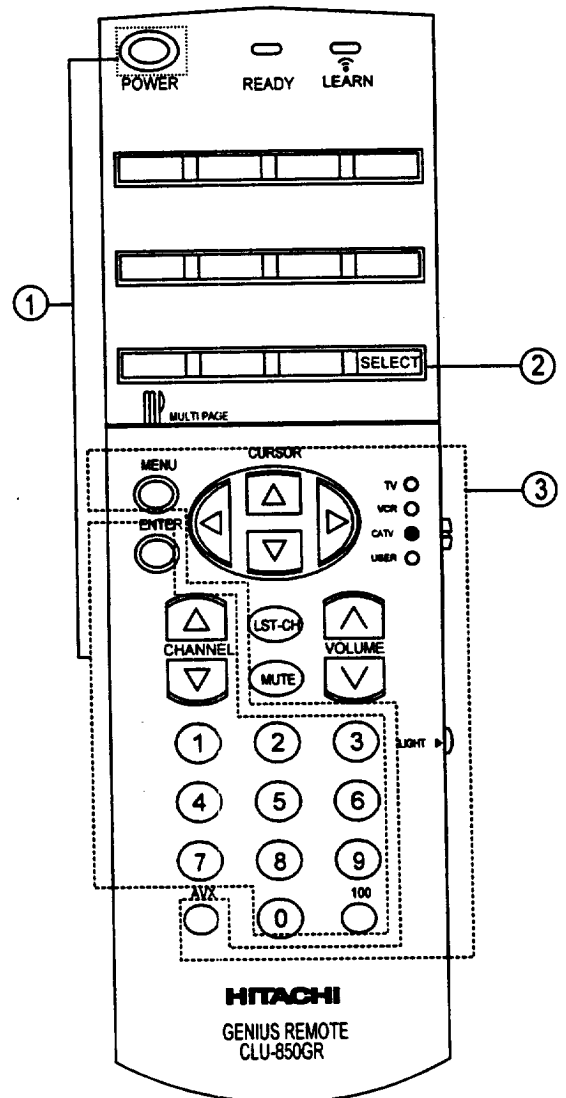



## VCR AND CABLE BOX CODES

**BLE 1. VCR Precoded remote controls for Hitachi GR111 Remote CLU-850GR**

CR BRAND	Press SELECT and this button	VCR BRAND	Press SELECT and this button
Audio Dynamics	VOLUME ▼	NEC	9/VOLUME ▼
Canon	6	Panasonic	6
Citizen	0	Pentax	1
Craig	VOLUME ▲	Philco	4/6
Curtis Mathes	2/6	Philips	4/6
Cox	VOLUME ▼	Pioneer	1
Cimensia	2	ProScan	2
Cernson	100/ENTER	Quasar	6
Chesher	VOLUME ▲	RCA	1/2
CE	2/6	Realistic	6/9/CHANNEL ▲ /VOLUME ▼
Coldstar	0	Sanyo	9/VOLUME
Hitachi	1	Scott	7/8
Instant Replay	6	Sears	1/9
J. Penny	1/6/9/VOLUME ▼	Sharp	CHANNEL ▲
J/C	0/VOLUME ▼	Sony	5/MUTE/AVX
Kenwood	0/VOLUME ▼	Sylvania	4/6
Magnavox	4/6	Tashiko	0
Marantz	9/VOLUME ▼	Technics	6
Marta	0	Toshiba	1/8
Memorex	6/VOLUME ▲	Vector Research	VOLUME ▼
GA	7	Video Concepts	VOLUME ▼
Inolta	1	Wards	CHANNEL ▲
Itsubishi	7	Yamaha	0/VOLUME ▼
Montgomery Wards	CHANNEL ▲	Zenith	3/5

**BLE 2. Cable Box Precoded remote controls for Hitachi GR111 Remote CLU-850GR**

ATV Brand	Press SELECT and this button	CATV Brand	Press SELECT and this button
General Instrument	0/1/2/3	Pioneer	7
Amclin	4	Regal	4
Arnold	1/2/3/3	Scientific Atlantic	6
Magnavox	9	Viewstar	9
Panasonic	8	Zenith	5
Philips	9		



## VCR AND CABLE BOX CODES

**TABLE 3. VCR Precoded remote controls for Hitachi GJ111 Remote CLU-692GR.**

VCR BRAND	Press SELECT and this button	VCR BRAND	Press SELECT and this button
Canon	6	Pentax	1
Citizen	0	Philco	4/6
Curtis Mathes	2/6	Philips	4/6
Dimensia	2	Pioneer	1
GE	2/6	ProScan	2
Goldstar	0	Quasar	6
Hitachi	1	RCA	1/2
Instant Replay	6	Realistic	6/9/CHANNEL ▲
JC Penny	1/6/9	Sanyo	9
JVC	0	Scott	7/8
Kenwood	0	Sears	1/9
Magnavox	4/6	Sharp	CHANNEL ▲
Marantz	9	Sony	5/VOLUME ▲/VOLUME ▼
Marta	0	Sylvania	4/6
Memorex	6	Tashiko	0
MGA	7	Technics	6
Minolta	1	Toshiba	1/8
Mitsubishi	7	Wards	CHANNEL ▲
Montgomery Wards	CHANNEL ▲	Yamaha	9
NEC	9	Zenith	3/5
Panasonic	6		

**TABLE 4. Cable Box Precoded remote controls for Hitachi GJ111 Remote CLU-692GR**

CATV Brand	Press SELECT and this button	CATV Brand	Press SELECT and this button
General Instrument	0/1/2/3/8	Regal	4
Hamlin	4	Scientific Atlantic	6
Jerrold	0/1/2/3/8	Viewstar	9
Pioneer	7	Zenith	5



## USING THE GENIUS REMOTE TO LEARN ADDITIONAL FUNCTIONS FOR CLU-850GR

The Genius Remote is equipped with a learning function which allows it to learn additional infrared control codes. This remote will not only control the television, a VCR, and cable box, but also other electronic equipment which uses an infrared remote transmitter, by learning the transmitter's codes.

Only infrared remote control codes can be stored in memory.

### Before starting the memory operation

Since the infrared signals sent from the remote transmitter may be reflected by a wall, door, etc., even if the transmitter is not pointed directly at the device, it may operate. When storing the remote control codes of another device, turn off the power of the device (VCR, Cable Converter, etc.)

If you do not do this, the device may work unexpectedly. The power could be turned on, an important tape could be erased, the volume could increase too much, etc..

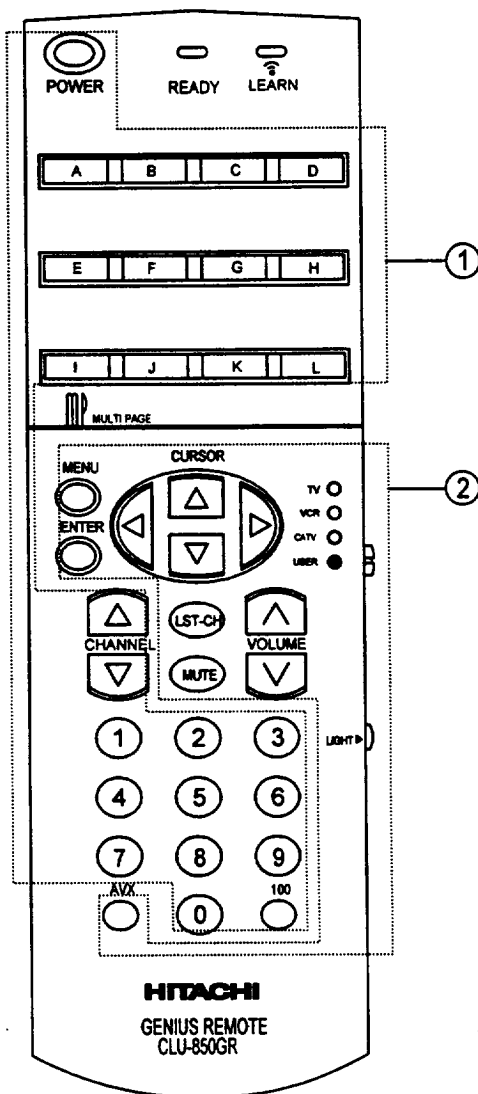

### ① LEARNABLE BUTTONS

These buttons can "learn" the codes of other remote control transmitters when the MULTI-PAGE select switch is set to the "USER" mode.

- MULTI-PAGE keys (A through L): No codes have been factory stored to these keys.
- Learning buttons other than MULTI-PAGE buttons: the codes for the TV have been stored in memory. However, the remote control codes of other equipment (cable converter, audio equipment, etc.) can be stored using the learning function as shown on page 39 and page 40.

### ② EXCLUSIVE BUTTONS

These buttons are for operating the TV.

# USING THE GENIUS REMOTE TO LEARN ADDITIONAL FUNCTIONS FOR CLU-850GR



## Storing Operation

- 1 Set the remote transmitter as shown below. Put the remote transmitter which contains the codes to be stored and the GENIUS REMOTE transmitter to face each other. (Distance should be 2-4 inches.)

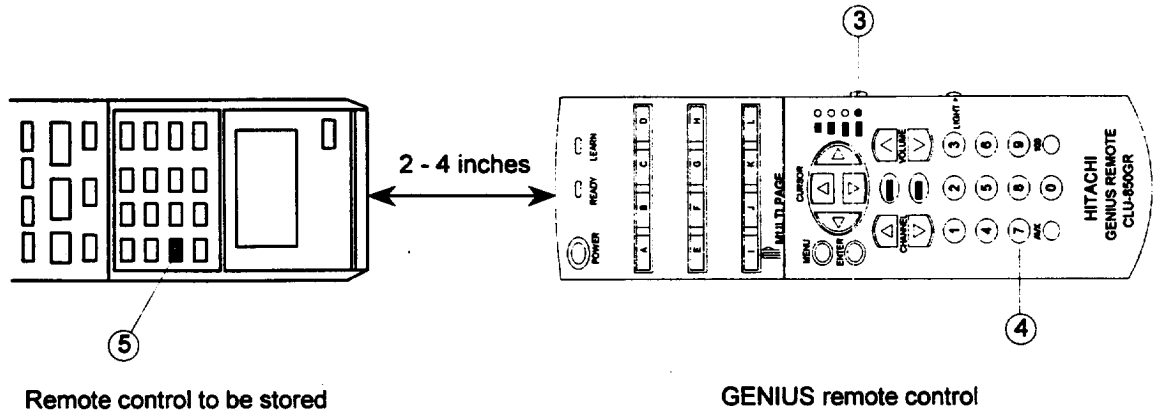

- 2 Set the LEARN/USE mode select switch located on the back of the Genius Remote to the LEARN position.
- 3 Set the MULTI-PAGE select switch to "USER" position.
- 4 Press one of the learnable buttons on the Genius Remote, ("7" in this example). This button will be used to store the new code. The READY indicator will flash at this time. (The light will remain lit for approximately 15 seconds. If no other function is performed at this time, the operation is canceled.)

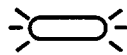

READY  
(flashing)



LEARN  
(off)

The Genius Remote is ready to receive an infrared code from another remote.

- 5 Press and hold the button down on the other transmitter which contains the code to be stored, while the READY light is flashing on the Genius Remote. Release the button after both the READY and LEARN indicators light and then go off.



# USING THE GENIUS REMOTE TO LEARN ADDITIONAL FUNCTIONS FOR CLU-850GR



**READY**  
(Goes out)



**LEARN**  
(Lights)

When storing has been performed correctly, the LEARN indicator lights for about 2 seconds.

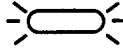

**READY**  
(Flashing)



**LEARN**  
(Flashing)

If the storing was not done correctly, or the codes are too long to learn, or no more codes can be stored in memory due to memory overflow, the LEARN indicator and READY indicator will flash on and off.

- 3) Set the LEARN/USE mode select switch on the back of the Genius Remote to "USE" and check that the button to which the code is stored operates correctly. If it does not operate correctly, repeat from step 1.
- 4) Repeat steps 3 to 5 to store other keys.

### 5) clear the stored codes from the USER mode.

Set the MULTI-PAGE select switch to the USER mode and LEARN/USE mode select switch to "LEARN." Then, press the POWER and the MUTE buttons simultaneously for 3 seconds. The "READY" and "LEARN" LEDs will light together. All MULTI-PAGE KEYS with codes are reset to their initial states.

To remember stored codes, it is convenient to paste the labels (user's label) provided on the buttons for the USER page. If the correct labels are not provided, it is possible to write these letters on an empty label with a ballpoint pen.

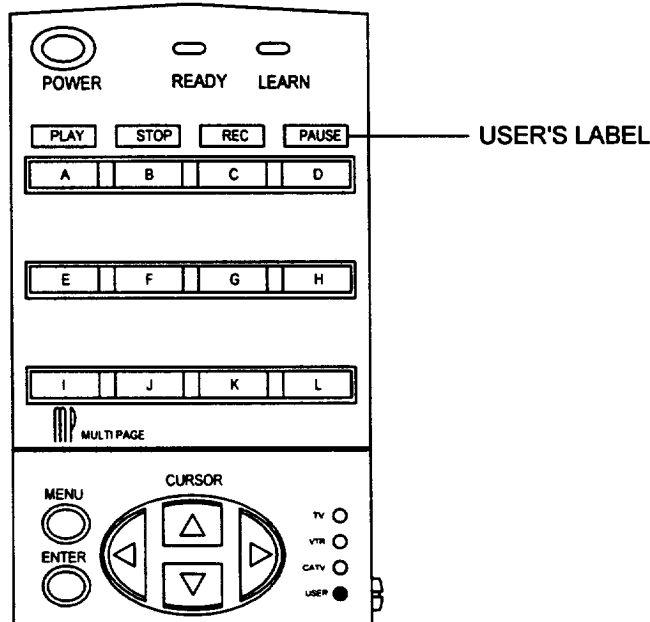



## USING THE REMOTE TO LEARN ADDITIONAL FUNCTIONS

---



### **NOTE:**

1. To operate your TV, be sure to point the Genius Remote at the remote sensor on the television. To operate other electronic equipment like a VCR, point the remote at the sensor on the device.
2. Refer to the instruction manual of the VCR for operation on the buttons exclusively for the VCR.
3. Be sure to keep the original remote transmitter even after storing its codes in the Genius Remote Control.
4. If the Genius Remote is left with its batteries removed, the learned codes in its memory are erased and will have to be reprogrammed into the memory.
5. The Genius Remote Control may not be able to learn certain special remote codes.

### **CAUTION ON BATTERIES:**

1. The Genius Remote Control is working when the LEARN indicator lights up when a button is pressed.
2. When you press a button and the learn indicator will not light up or if the operation is extremely slow, this is an indication that the batteries should be replaced.
3. Even if the batteries seem dead, do not remove them until you have replacement batteries ready to put in. The codes stored in memory will be erased in a few minutes without power. When replacing batteries, prepare the new ones first.



## EASY GRAPHIC GUIDE

- 1) Press MENU on the remote control to display the different features on your HITACHI TV. The feature to be selected will be highlighted in a magenta (purple) color.
- 2) Press the CURSOR buttons to highlight a different feature.
- 3) Press ENTER on the remote control to select a feature.

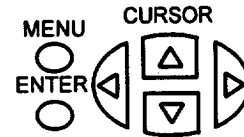

**NOTE:** Press the CURSOR buttons first to view FAVORITE CHANNELS (See Page 47.)

This part of the screen shows what selections are available.

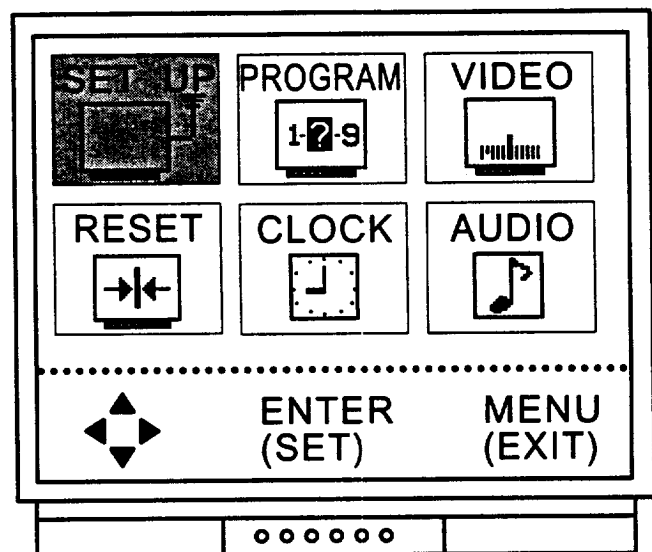

This part of the screen shows which remote control buttons to use.



**NOTE:** For CLU-692GR, slide multi-page select to MENU/CATV mode to work on MENU, ENTER, and cursor up, down left and right. Slide to TV mode to Use Channel ▲, ▼ Buttons or number buttons.

# EASY GRAPHIC GUIDE

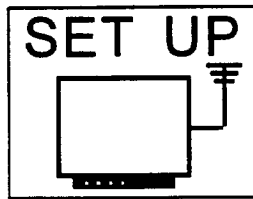

**AIR/CABLE AIR**

Select antenna or cable TV.

**AUTO PROGRAM**

First time setup for channel buttons.

**CHANNEL MEMORY**

Channel buttons, add or erase.

**CLOSED CAPTION**

Feature to display dialogue/text.

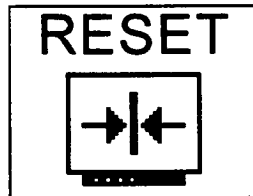

Return video and audio adjustments to factory settings.

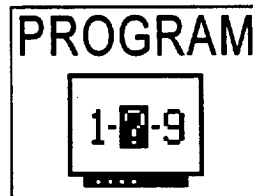

**CHANNEL CAPTION**

Label channels PAY1, ABC, etc.

**CHILD LOCK**

Block channel picture & sound.

**PROGRAM LIST**

Check channel name, scan, childlock.

**VOLUME CORRECTION**

Lower volume on selected channels.

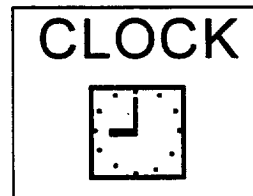

**CLOCK SET**

Set before using timer features.

**ON/OFF TIMER**

Turn TV on or off one time or daily.

**AUTOMATIC MESSAGE-1**

Set for one time or daily.

**AUTOMATIC MESSAGE-2**

Set for one time or daily.



**FOR 35UX10B**

Adjust Contrast, Color, Tint, Sharpness and White Control.

**FOR 35UX60B**

**PREFERENCE ADJUST**

Adjust color, brightness, etc.

**PREFERENCE SETTING**

Improve picture performance.



**PREFERENCE ADJUST**

Adjust balance, bass, and treble.

**PREFERENCE SETTING**

Improve sound performance.

**SURROUND**

Special sound effects.



# SET UP

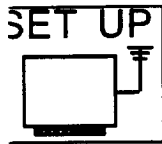

Select SET UP when setting your TV up for the first time. Use the CURSOR UP/DOWN buttons on the remote to highlight the function desired.

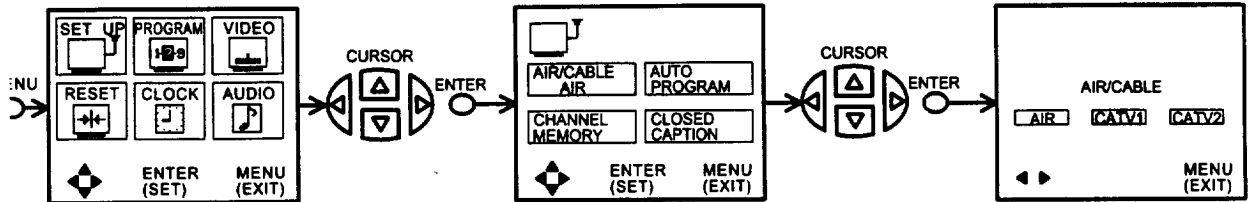

## AIR/CABLE AIR

Select AIR if you are using an indoor or outdoor antenna.  
Select CATV if you have cable TV.

Press the CURSOR buttons to highlight the correct AIR/CABLE mode and press MENU to exit. Your choice will be shown on the display.

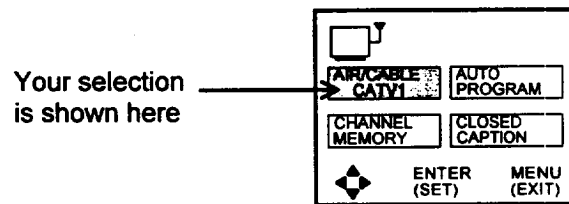

Reception channels for each mode are shown to the right.

Refer to your cable or TV guide for channel identification standards.

For certain CATV channels are poor or not possible in the CATV1 mode, set AIR/CABLE to CATV2.

RECEPTION BAND		
AIR	CATV 1 or CATV 2	
	CATV CHANNEL	Indicated on the screen
VHF 2 ~ 13ch UHF 14 ~ 69ch	VHF 2 ~ 13	2 ~ 13
	Mid band A ~ I A-5 ~ A-1	14 ~ 22 95 ~ 99
	Super band J ~ W	23 ~ 36
	Hyper band W + 1 ~ W + 28	37 ~ 64
	Ultra band W + 29 ~ W + 84	65 ~ 125



# SET UP

## AUTO PROGRAM

This feature will automatically store active TV channels in CHANNEL MEMORY. This will allow you to skip over unused channels when using the CHANNEL UP (▲) or DOWN (▼) buttons.

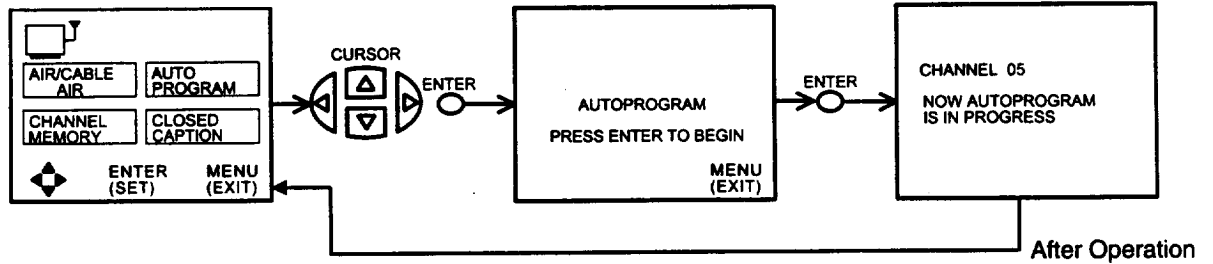

If the MENU button is pressed while the auto programming function is engaged, programming will stop. If two antennas are connected, switch antenna inputs with the ANT button and repeat auto programming for the second antenna input.

Remember to select the correct AIR/CABLE mode before using auto programming for the second antenna input.

See CHANNEL MEMORY to add or erase additional channels.

## CHANNEL MEMORY

Use this function after AUTOPROGRAM to add or erase additional channels by the remote control CHANNEL ▲, ▼ buttons. Your Choice will be highlighted in magenta.

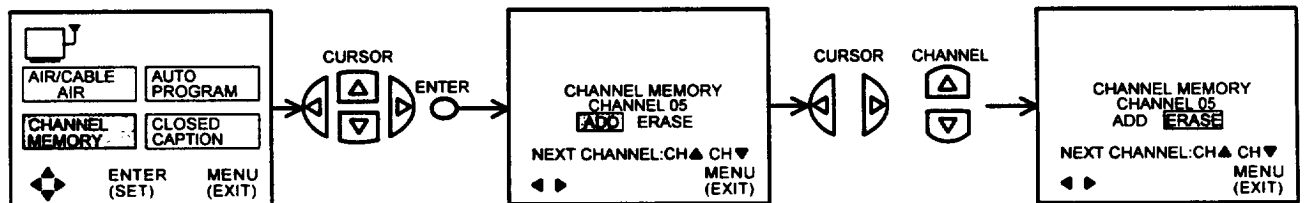

Add or erase additional channels while still in CHANNEL MEMORY using the CHANNEL ▲, ▼ buttons or number buttons and then add or erase using the CURSOR ◀, ▶ buttons.



# SET UP

## LOSED APTION

Closed captions are the dialogue, narration, and/or sound effects of a television program or home video which are displayed on the TV screen. Your local TV program guide denotes these programs as or .

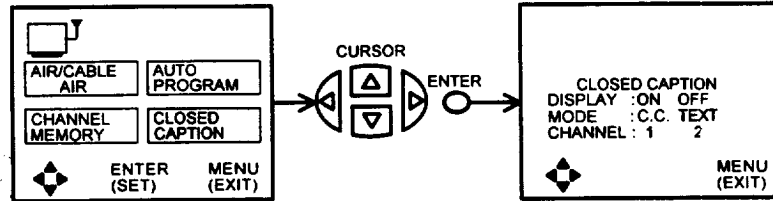

ie selected function will be in magenta. Your choice for the function will be in blue.

**DISPLAY: ON/OFF** is to turn the cc display "ON" or "OFF".

**MODE: C.C.** (Closed Caption) is for the program you are viewing.

**MODE: TEXT** is for additional information such as news reports or a TV program guide. This information covers the entire screen and viewing the TV program is not possible. TEXT may not be available with every program.

**CHANNEL: 1** is used for the primary language (usually English).

**CHANNEL: 2** is sometimes used for a second language (may vary by region).

Use the CURSOR or to highlight the function to change, press ENTER to change the function, and press MENU to exit.

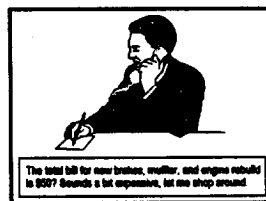

C.C. Selected

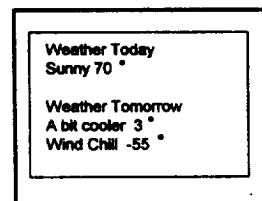

Text Selected

**NOTE:** The word MUTE will not be displayed if the DISPLAY is ON. If you do not have sound, make sure MUTE is not set, or Int. speaker is on "OFF"

# FAVORITE CHANNELS



The FAVORITE CHANNELS function will allow you to select up to 16 favorite channels by pressing the cursor buttons.

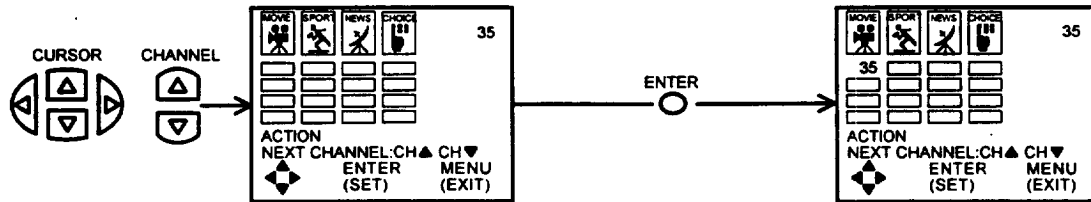

Use the CHANNEL ▲, ▼ or number buttons to select one of your favorite channels.  
 Use the CURSOR buttons to select the location (in magenta color) for your favorite channel.  
 Press ENTER to save the channel location.  
 Enter channel 00 to erase a favorite channel.

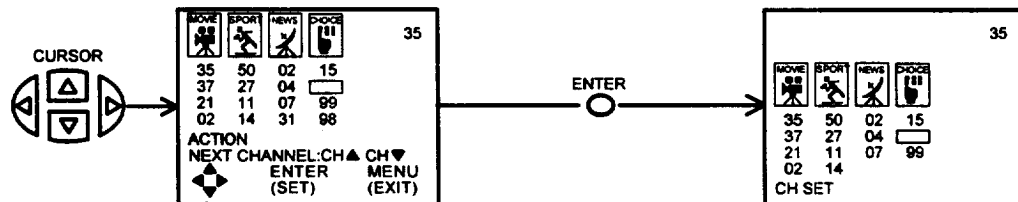

-highlight ACTION and press ENTER to use your favorite channels.  
 Use the CURSOR buttons to highlight a favorite channel and the TV will automatically tune to the channel.  
 -highlight CH SET and Press ENTER to add or erase more favorite channels.

## FAVORITE CHANNEL PREVIEW (For 35UX60B)

-highlight a topic - MOVIE, SPORT, NEWS, or CHOICE and press ENTER to get a preview of the channels under that topic.  
 The channels will be displayed for about 15 seconds.

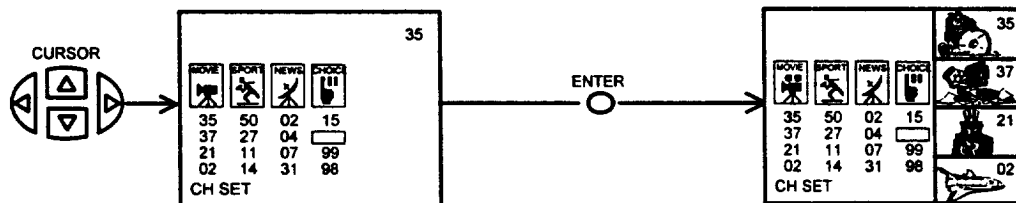

**NOTES:** Only the main channel viewed will have a moving picture.  
 Use the cursor to change the channel and moving picture for the Favorite Channel Preview.  
 The Favorite Channel Preview is removed when the cursor ◀, ▶ is pressed.



# RESET

## RESET

Use the reset to change your preferred video and audio adjustments to factory settings.

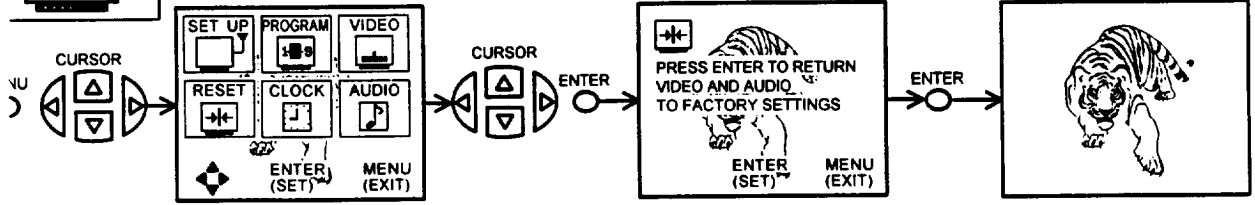

or **35UX60B** Factory Settings:

### VIDEO

Contrast:

Color:

Tint:

Brightness:

Sharpness:

AI: OFF

Auto Color: ON

Noise Reducer: OFF

White Control: ON

### AUDIO

Balance:

Bass:

Treble:

MTS Mode: STEREO

Dynamic Bass: OFF

Loudness: OFF

Internal Speakers: ON

Surround: OFF

**NOTE:** This RESET Selection will not change your preferred adjustments. To change back to your adjustments, see VIDEO (Page 54 and 56) or Audio (Page 57).

or **35TX10B** Factory Settings:

### VIDEO

Contrast:

Color:

Tint:

Brightness:

Sharpness:

White Control: ON

### AUDIO

Balance:

Bass:

Treble:

MTS Mode: STEREO

Dynamic Bass: OFF

Loudness: OFF

Internal Speakers: ON

Surround: OFF

**NOTE:** This RESET Selection will not change your preferred adjustments. To change back to your adjustments, see VIDEO (Page 54 and 56 ) or Audio (Page 57).

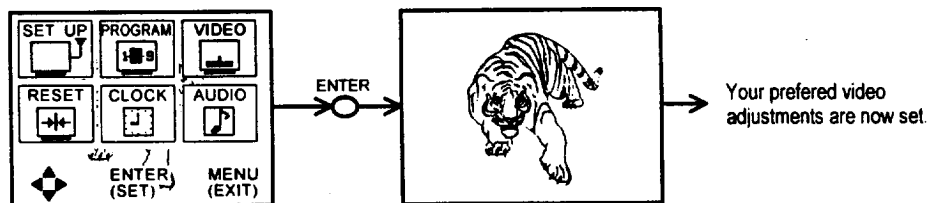



# PROGRAM



This Selection contains advanced feature switch will make TV viewing easier and more enjoyable.

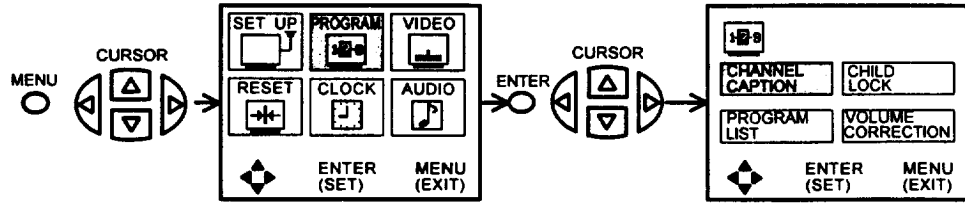

## CHANNEL CAPTION

Use this feature to give channel names to up to 30 channels for each antenna source.

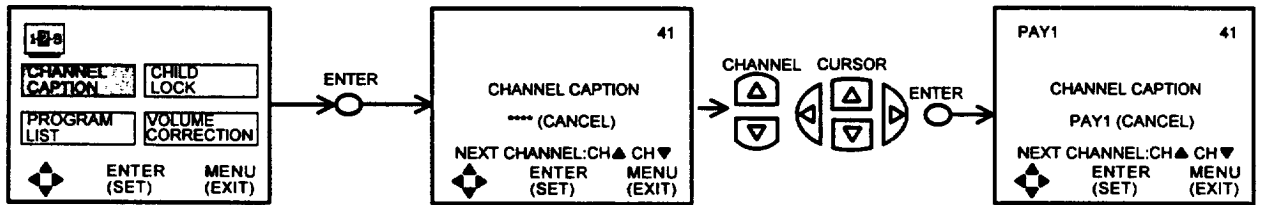

- Press the CURSOR ▲, ▼ to select letters.
- Press the CURSOR ◀, ▶ to change position.
- Press ENTER to set the CHANNEL CAPTION and it will appear in the top left corner of the screen.
- Press CHANNEL ▲, ▼ or the number buttons to select and label additional channels.
- Press MENU to exit.

The (\*) represents a blank space.  
Select CANCEL to erase a CHANNEL CAPTION.

## PROGRAM LIST

This function allows you to view which channels are labeled in CHANNEL CAPTION (NAME), which have been added to CHANNEL MEMORY (SCAN), and which are protected by CHILD LOCK (LOCK).

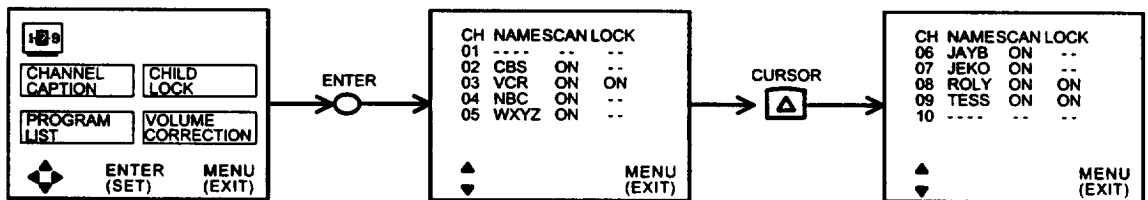

- Press CURSOR ▲, ▼ to review more channels.
- Press MENU to exit.

**CHILD LOCK**

This function will block out the picture and sound of the selected channel.

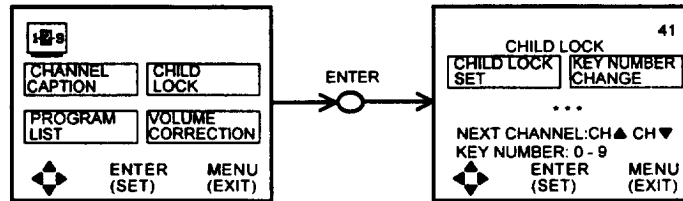

The code to set or cancel CHILD LOCK is a three digit key number. The factory preset key number is 000.

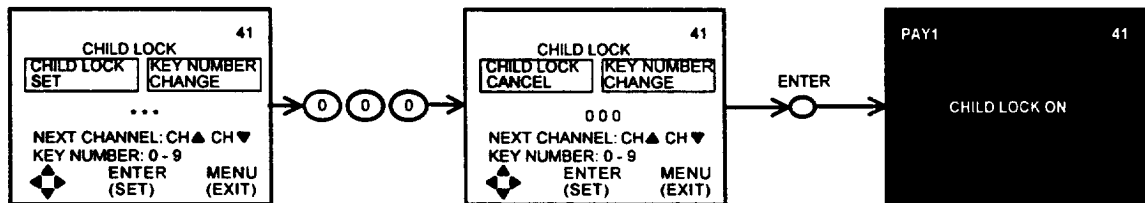

The picture and sound will now be blocked out for this channel. Repeat the same steps to cancel the CHILD LOCK.

To change the key number, select key number change. Enter the old number (factory preset 000 for first time use), then enter a new three digit key number you prefer.

If you forget your key number, use the factory code 777 to erase your key number. This will reset the key number back to the factory preset 000.

# PROGRAM

## VOLUME CORRECTION

Use this function to reduce the volume level of up to four TV channels that sound loud compared to other TV channels.

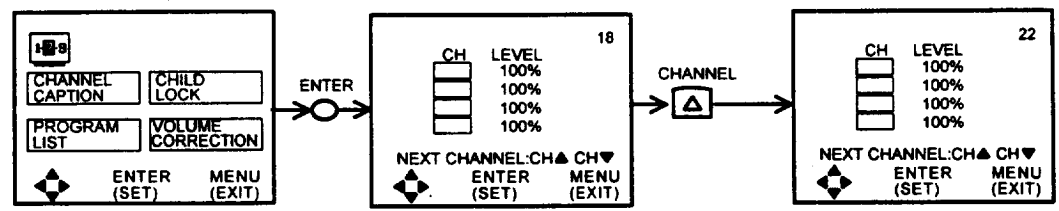

Press the cursor ▲, ▼ to select one of the four volume corrections. Use the Channel ▲, ▼ or number buttons to select a channel.

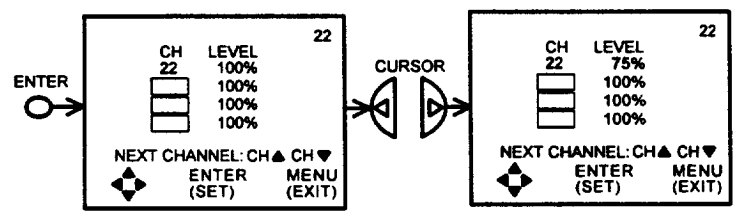

Press ENTER to set the channel.  
Press the CURSOR ◀, ▶ to adjust volume level.  
Press MENU to exit.

- NOTE:**
1. VOLUME CORRECTION adjustment is for the channel displayed in the top right corner of the screen. To adjust a different channel, you must select the channel with the channel or number buttons and press ENTER.
  2. If the channel has been corrected before, use the cursor ▲, ▼ to highlight that channel then use the cursor ◀, ▶ to change the level.
  3. To erase a channel from the volume correction, select channel 00 and press ENTER.
  4. The volume level will change from 50% to 100% in 5% steps.



# CLOCK

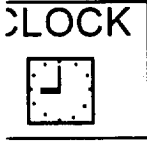

Use this feature for all time related functions.

## LOCK ET

The time must be set before you can use the on/off timer or automatic message.

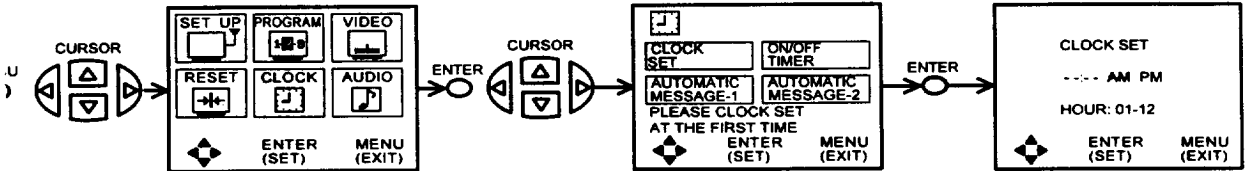

Use the NUMBER buttons and CURSOR ◀, ▶ to set the time. The AM or PM selected will be highlighted in blue.

## ON/OFF TIMER

This function will automatically turn the TV on or off, one time only or everyday.

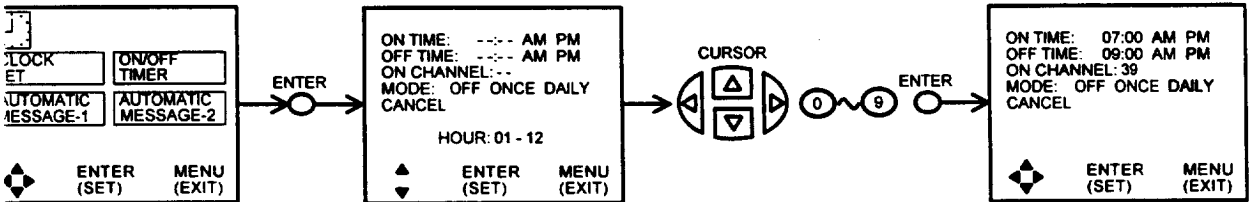

The step to change will be in magenta.

Press the number buttons to select the time the TV will turn "ON" or "OFF". (AM: 1, PM: 2)

Press the CURSOR ◀, ▶ buttons for MODE: ONCE (one time only) or MODE: DAILY (TV will turn on/off at the same time every day).

Press CHANNEL ▲, ▼ or the NUMBER buttons to set the channel the TV will tune to when it automatically turns on.

Your choice for AM/PM and MODE will appear in blue.

Press ENTER to start.

Select CANCEL and press ENTER to erase time.

**NOTE:** You can set either "ON" time only, "OFF" time only, or both. The mode will be the same for both.



**CAUTION:** Do not use your TV as a deterrent when away from home by using both the ON and OFF TIMERS. For safety, the TV should be turned off when you are away from home.

# CLOCK



## AUTOMATIC MESSAGE

Use this function to set one or two personal messages every day or one time only.

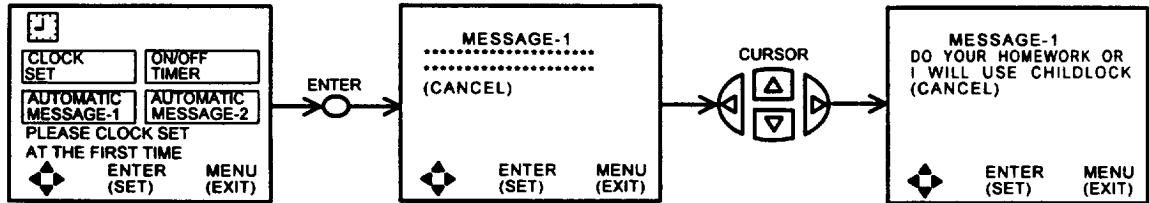

Use the CURSOR ▲, ▼ to select a letter or other character.

Use the CURSOR ◀, ▶ to change position.

Press ENTER when message is finished.

The asterisk (\*) represents a blank space.

Move the CURSOR ◀, ▶ until (CANCEL) is magenta and press ENTER to erase message.

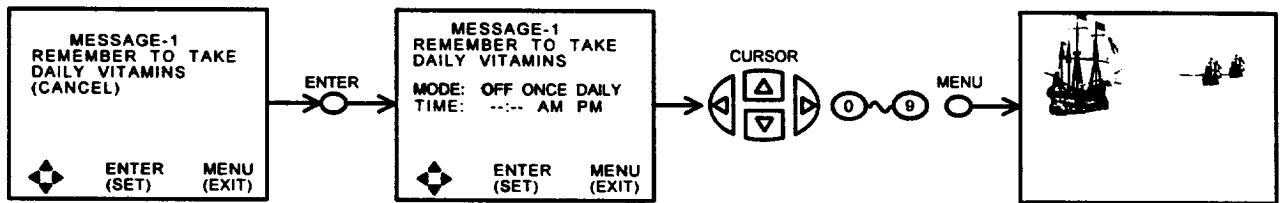

Use cursor ▲, ▼ to choose MODE or TIME.

Use cursor ◀, ▶ to set MODE when it is magenta. Your choice will be in blue.

Use the NUMBER buttons to set the time.

Press ENTER to start and MENU to exit.

**NOTE:** Automatic Message-2 is the same cursor operation.



## VIDEO



Select VIDEO to adjust picture settings, and to improve picture quality.

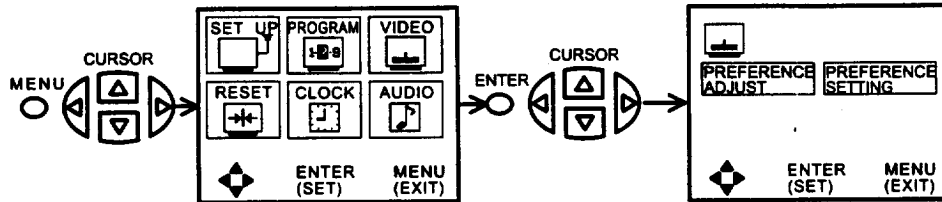

## REFERENCE ADJUST

Use this feature to adjust contrast, color, etc.

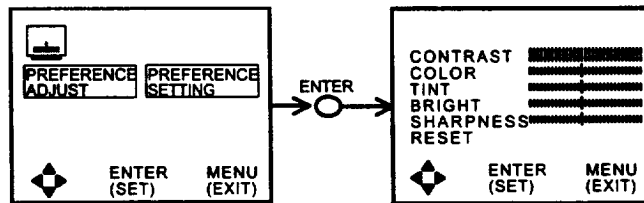

Press the CURSOR buttons to select and make adjustments. The function to be adjusted will be in magenta.

**CONTRAST** - Use this function to change the contrast between black and white levels in the picture. This adjustment will only affect the picture when the PICTURE SETTING AI is OFF. (See page 55.)

**TINT** - Use this function to adjust flesh tones so that they appear natural.

**COLOR** - Use this function to adjust the level of color in the picture.

**BRIGHT** - Use this function to adjust overall picture brightness.

**SHARPNESS** - Use this function to adjust the amount of fine detail in the picture. This adjustment will only affect the picture when PICTURE SETTING AI is OFF. (See page 55.)

**RESET** - When RESET is selected, press ENTER to return video adjustments to factory preset conditions.



## PREFERENCE SETTING

Your HITACHI TV has an AI (Artificial Intelligence) function which will automatically adjust picture settings to produce the highest quality picture possible. When AI is magenta, use the cursor ◀ ▶ to turn the AI "ON" or "OFF", Your choice will be in blue.

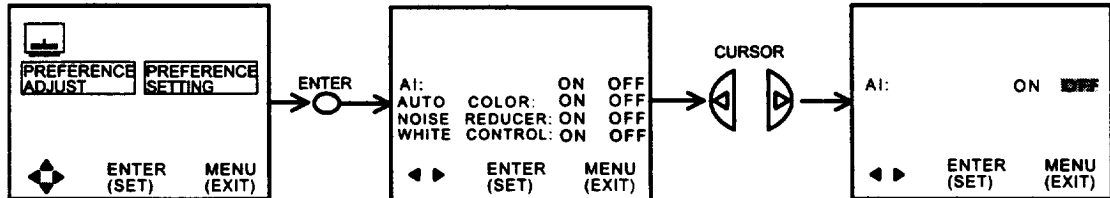

Use the CURSOR ▲, ▼ to select function.

Use the CURSOR ◀, ▶ to turn function "ON" or "OFF". Your choice will be in blue.

## AI (ARTIFICIAL INTELLIGENCE)

When the AI function is on, the TV internal computer will perform the following:

1. Automatically monitor and adjust contrast depending on room lighting (sensor is located on the front panel), to produce a more natural picture.
2. Automatically monitor and adjust color levels and maintain natural flesh tones.
3. Automatically compensate for weak or strong TV signals to produce a clear picture. (The SHARPNESS function is automatically adjusted.)

Turn the AI function off to control other PREFERENCE SETTINGS.

## AUTOCOLOR

The AUTOCOLOR function automatically monitors and adjusts the color to maintain constant color levels even after a program or channel changes. It also maintains natural flesh tones while preserving fidelity of background colors. For best picture performance, leave the AUTOCOLOR function "ON".

## NOISE REDUCER

The NOISE REDUCER automatically reduces conspicuous noise in the picture without degrading picture quality.

## WHITE CONTROL

Use this function to adjust the white balance (hue) of the picture to you own color preference. When shipped from the factory, this is set to "ON". If you prefer a reddish screen, set to "OFF".



## VIDEO



Select VIDEO to adjust picture settings, and to improve picture quality.

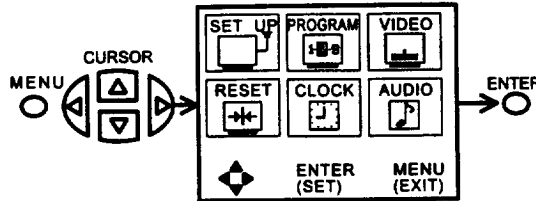

Use this feature to adjust contrast, color, tint, brightness, sharpness, and white control.

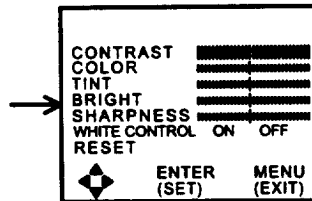

Press the CURSOR buttons to select and make adjustments. The function to be adjusted will be in magenta.

**CONTRAST** - Use this function to change the contrast between black and white levels in the picture.

**COLOR** - Use this function to adjust the level of color in the picture.

**TINT** - Use this function to adjust flesh tones so that they appear natural.

**BRIGHT** - Use this function to adjust overall picture brightness.

**SHARPNESS** - Use this function to adjust the amount of fine detail in the picture.

**WHITE CONTROL**- Use this function to adjust the white balance (hue) of the picture to your own color preference. When shipped from the factory, this is set to "ON". If you prefer a reddish screen, set to "OFF".

**RESET** - When RESET is selected, press ENTER to return video adjustments to factory preset conditions.



# AUDIO



Select AUDIO to adjust the TV to your preference, to improve the sound quality, and to select special sound effects.

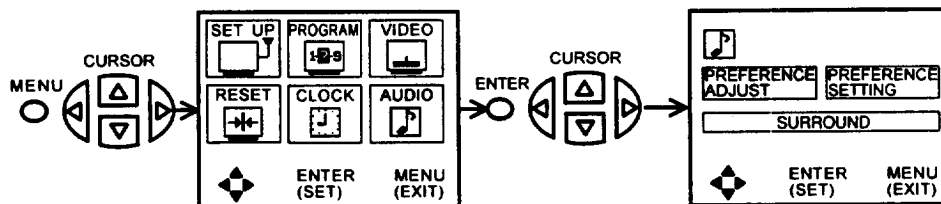

## PREFERENCE ADJUSTMENT

Use this to set balance, bass, and treble.

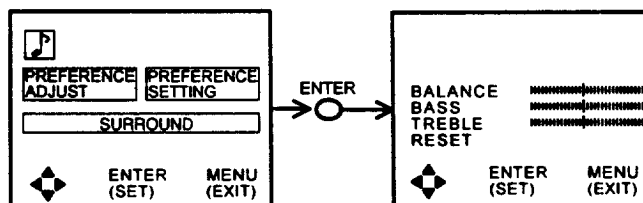

Press the CURSOR buttons to select and make adjustments. The function to be adjusted will be in magenta.

**BALANCE** - This function will control the left and right balance of the TV internal speakers, the AUDIO TO HI-FI output, and the surround speakers. The balance control is also found in the Dolby Surround function. (See Page 63.)

**BASS** - This function controls the low frequency audio to all speakers.

**TREBLE** - This function controls the high frequency audio to all speakers.

**RESET** - When RESET is selected, press ENTER to return audio adjustments to factory preset conditions.



## PREFERENCE SETTING

Use Preference SETTING to improve the sound performance of your TV depending on listening conditions.

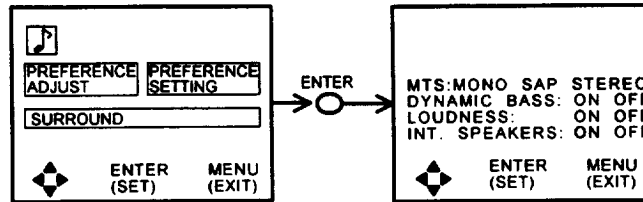

the CURSOR **▲**, **▼** to select a function. The function will be in magenta.  
the CURSOR **◀**, **▶** to change function. Your choice will be in blue.

**MODE** (Multi-Channel Television Sound) will allow you to select STEREO (a stereo broadcast), SAP (second audio program) which may be a secondary language, weather report, etc. or MONO (monaural sound) used when receiving a stereo broadcast.

sources received will be displayed below the channel number. The source you select will be displayed to the left of channel number. See example below for each selection when both stereo and second audio are received (monaural ways received).

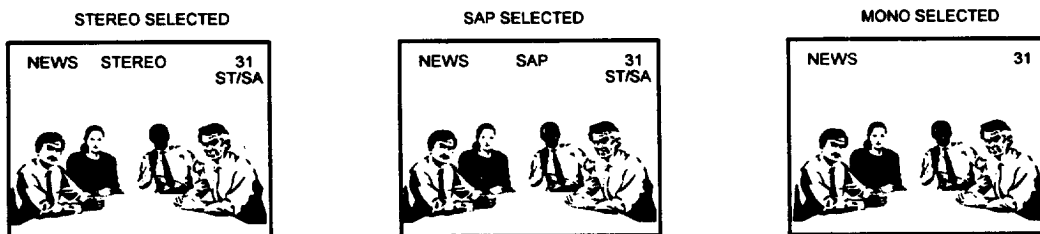

## DYNAMIC BASS

This function allows you to enjoy spectacular bass sound that would normally be heard only with expensive home speaker systems.

## LOUDNESS

This function will improve the quality of both low and high frequency sounds when listening at low volume levels.



# AUDIO

## INT. SPEAKERS

This function is useful when first setting up the external speakers, or if you prefer to use only speakers from a separate stereo system. This feature is used to turn the internal speakers "ON" or "OFF", when the Receiver is connected to an External Audio Amplifier. This function allow the user to turn off the TV speakers. Therefore, no sound will be emitted from them. This function is useful when first setting up the external speakers, or if you prefer to use only speakers from a separate stereo system.

For external speaker with Internal/External switch, sound reproduction is as follows. (For 35UX60B Only.)

## TELEVISION ON SCREEN DISPLAY AND REAR SPEAKER CONNECTION

- (A) On Screen Display Int. Speaker: "ON" **-and-** Rear Switch to Int.: Internal Speaker is "ON" **-or-** Rear Switch to Ext.: Connect Ext. Speaker first or no sound will be heard. External speaker in "ON".

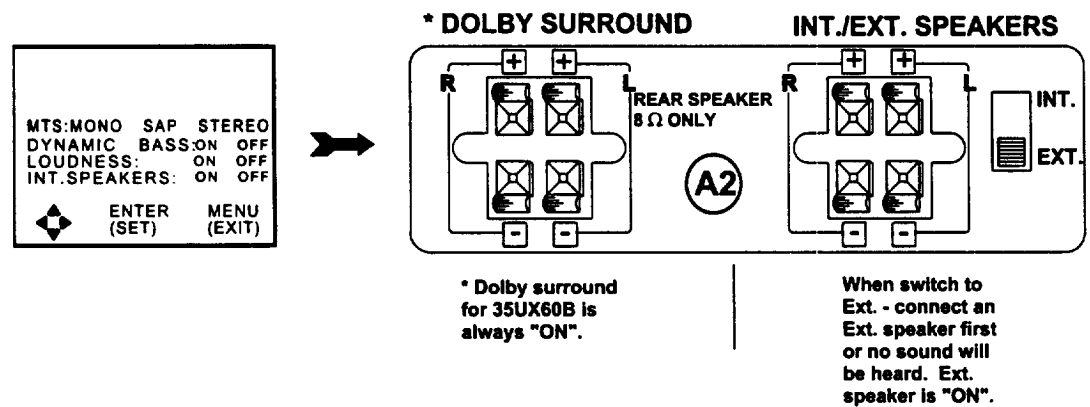
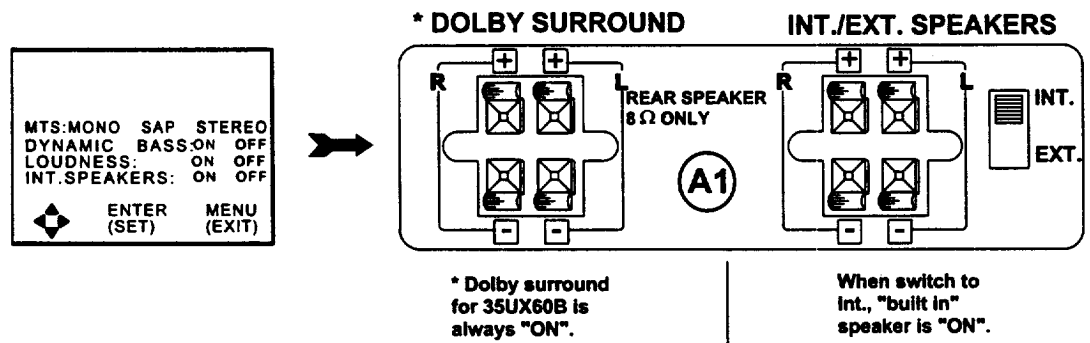



) On Screen Display Int. Speaker: "OFF" -and- Rear Switch Int. or Ext.: Int. or Ext. Speaker are "OFF"

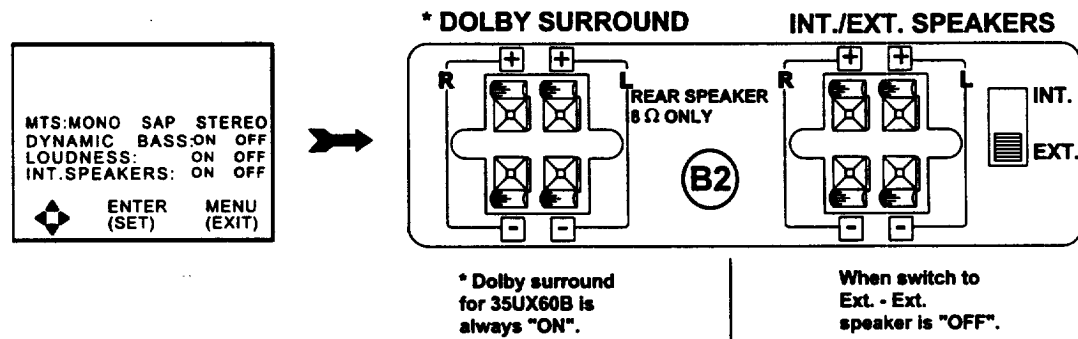
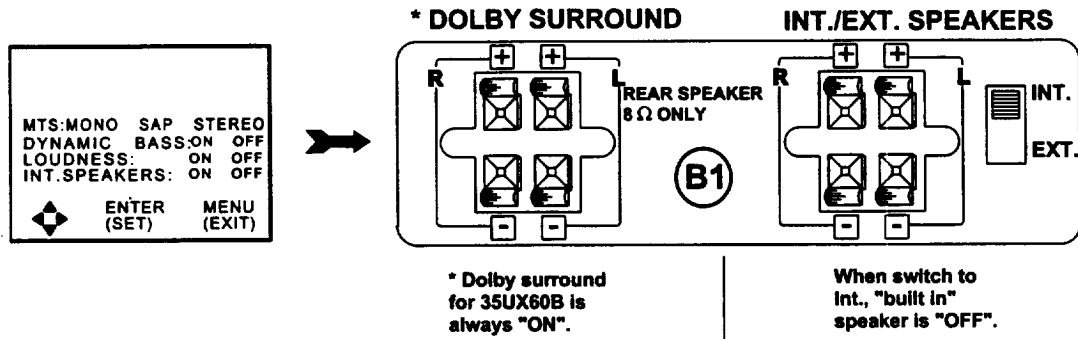

**NOTE:** The television set internal speaker is connected in parallel with an external speaker connection which will allow you to use the switch located at the rear of the CTV to switch either the TV sets built in internal speaker or to a consumer connected external speakers. This switch located at the rear of the TV set beside the external speaker connection can be switched to "ON" for a consumer connected external speaker sound reproduction or to "OFF" to use the factory built in speaker for sound reproduction. Please refer to Int./Ext. Speaker Connection on page 22.

## AUDIO FOR 35TX10B



### SURROUND

The following surround sound settings will reproduce the "live" sound you would hear in concert halls, movie theaters, etc. when you set up your speaker system as shown in the section on rear panel connections on page 18 and 24. The surround sound system is most effective with movies played on a stereo VCR.

Surround sound allows the viewer to enjoy sound which provides a feeling of "presence" from stereo broadcasts and VCR tapes\* recorded with stereo sound. Also a mono input, simulating a stereo or more louder reproduction.

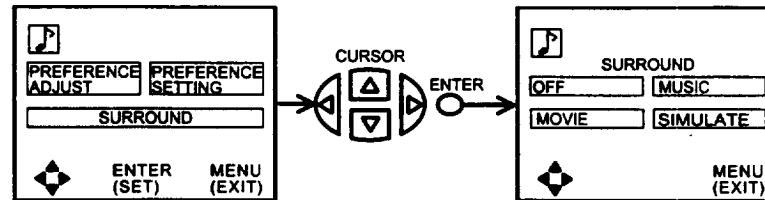

Use the CURSOR buttons to select surround setting

### SURROUND OFF

Use this for normal stereo/mono broadcasts.

**NOTE:** If the sound is noisy when a stereo broadcast is received and the TV is set to the Surround mode, decrease the "Treble" control or turn the "Surround Off"

### MOVIE SURROUND

Listener is surrounded by many sound sources such as a movie theater reproduction.

**NOTE:** Some TV systems do not transmit optimum audio channel separation which can reduce the effectiveness of the MOVIE SURROUND function.

### MUSIC SURROUND

Resonant sound - Listener has the feeling of being in a concert hall.

### SIMULATE SURROUND

At mono Input, sound is changed more loudly simulating a stereo like Surround.

\* Your play VCR must be a HI-FI or stereo unit. See page 18. For stereo VCR connection.

\* Set must be outputting stereo. (See MTS mode: stereo. See page 58.)



## AUDIO FOR 35UX60B

### **SURROUND**

The following surround sound settings will reproduce the "live" sound you would hear in concert halls, sports stadiums, movie theaters, etc. when you set up your speaker system as shown in the section on rear panel connections on page 17 and 23. The Surround sound system is most effective with movies and other stereo material that is Dolby Surround encoded, and played on a stereo VCR.

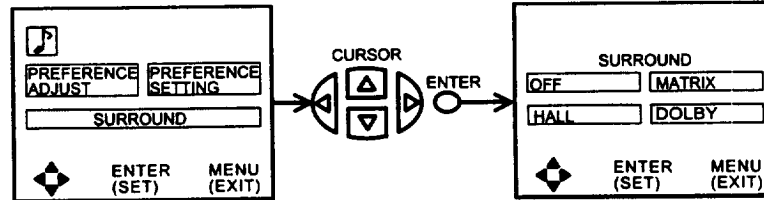

Use the CURSOR buttons to select Surround setting.  
The FRONT volume is the same as the main TV volume.

### **SURROUND OFF**

Use this for normal stereo/mono broadcasts.

**NOTE:** If the sound is noisy when a stereo broadcast is received and the TV is set to the Surround mode, decrease the "treble" control or turn the "Surround Off."

### **MATRIX SURROUND**

Listener is surrounded by many sound sources such as a sporting event, etc.

**NOTE:** Some TV systems do not transmit optimum audio channel separation which can reduce the effectiveness of the MATRIX SURROUND function.

### **HALL SURROUND**

Resonant sound - Listener has the feeling of being in a concert hall.



# AUDIO FOR 35UX60B

## DOLBY SURROUND\*

This is effective when playing a video tape marked with  logo. You can enjoy the feeling of a movie theater in your home.

\*Dolby and the double-D symbol are trademark of Dolby Laboratories Licensing Corporation.

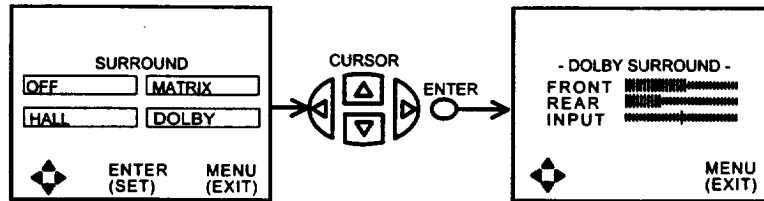

Use CURSOR ▲,▼ To select the Dolby Surround function

**NOTE:** Dolby Surround speaker outputs are always "ON" regardless of whether the set's internal speakers are "ON" or "OFF"..  
(INT/EXT Speakers)

## INPUT BALANCE

Use the CURSOR ▲,▼ to select to input balance.

With the TV receiving a Dolby Surround signal, adjust the input balance control until dialogue (conversation) from the Surround speakers is reduced to a minimum.

**NOTE:** This adjustment is easiest when the "FRONT SPEAKERS" setting is turned off or reduce the volume of the front channels only. Using a dialogue portion of the Surround program material, adjust the input balance control such that any dialogue heard from the Surround speakers is minimized. When this adjustment is complete, restore the front channel volume to its original setting and enjoy optimized Dolby Surround decoding.

## USING REAR SPEAKERS (DOLBY SURROUND EXTERNAL SPEAKER)

Only certain Surround sound formats can be enjoyed from the TV's built-in speakers. It may be necessary to connect rear speakers, depending on the Surround mode.

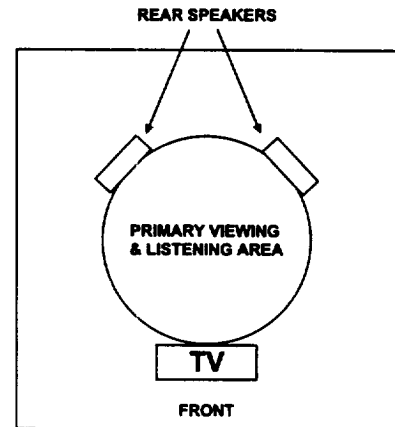

Refer to page 22 and page 23 for the connection of the rear speakers

LAYOUT OF THE REAR SPEAKERS

## ADJUSTING "REAR VOLUME"

You can enjoy dynamic sound from the built-in speakers. However, if rear speakers are connected, a more powerful feeling of presence can be enjoyed with Surround sound. (See page 22 and page 23 for connection of speakers.) If the volume is adjusted with the volume, the volume of the rear speakers changes together with the volume of the front speakers.



## CARE OF YOUR HITACHI COLOR TV AND YOUR REMOTE CONTROL

---

### **DO**

Dust the screen and cabinet with a soft cloth.

Clean the screen with a soft cloth moistened in warm water. Dry with a soft cloth. (A mild soap may be used if the screen is extremely dirty.)

Place your TV and remote control away from extreme heat, humidity and extremely dusty places.

Remove the plug from the wall outlet if your television set will not be used for a long period of time, for instance, when you go on vacation.

### **DO NOT**

Do not clean your screen or cabinet with strong cleaners, polishes or chemically treated cloth.

Do not place rubber or vinyl products or cellophane tape on your set.

Do not touch the screen too often.

Do not subject the Remote Control to shocks such as dropping it on the floor, etc. Physical damage to the precision parts may result.





Avoid placing the Remote Control in a high humidity place or getting it wet. Don't leave it on or near a heater. Excessive heat or moisture may cause the unit to cease operation.

When the batteries run down, remote control operation will become erratic or possibly stop altogether. Replace the old batteries with fresh "AA" size batteries.



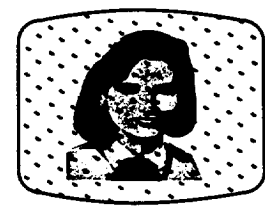

## RECEPTION PROBLEMS

	<p>• <b>IGNITION NOISE:</b> Black spots or horizontal streaks may appear, picture may flutter or drift. Usually caused by interference from automobile ignition systems, neon lamps, electrical drills and other electrical appliances.</p>
	<p>• <b>GHOSTS:</b> Ghosts are caused by the television signal following two paths. One is the direct path and the other is reflected from tall buildings, hills or some other objects. Changing the direction or position of the antenna may improve reception. Ghosting may also be caused by defects in the antenna system such as unshielded leads or connecting several sets to the same antenna without using multiple antenna couplers.</p>
	<p>• <b>SNOW:</b> If your receiver is located in the fringe area of a television station where the signal is weak, your picture may be marred by the appearance of small dots. When the signal is extremely weak, it may be necessary to install a special antenna to improve the picture.</p>
	<p>• <b>RADIO FREQUENCY INTERFERENCE:</b> The interference produces moving ripples or diagonal streaks, and in some cases, causes loss of contrast in the picture.</p>



# CHECK HERE BEFORE CALLING FOR SERVICE

SYMPTOMS	CHECK THESE ITEMS AND TRY THESE ADJUSTMENTS											
	Be sure external connection is correct	Be sure power cord is plugged in	Be sure TV is switched "ON"	Try another channel	Check antenna connections (trouble)	Check antenna connections (back of TV)	Check outside antenna	Adjust Picture control	Adjust Black level control	Adjust Color control	Adjust Tint control	Adjust Volume control
No picture, no sound	•	•	•	•	•	•	•					
Sound OK, picture poor	•			•	•	•	•	•	•			
Picture OK, sound poor	•			•	•	•	•					•
Picture blurred	•			•	•		•					
Lines or streaks in picture				•	•	•	•					
Poor reception on some channels				•	•	•	•	•				
No color	•			•	•	•	•			•		
Poor color	•			•	•	•	•			•	•	

## R 35UX60B

This Color Television incorporates advanced power surge protection technology designed to protect against component or circuit damage due to external or internal voltage or power surges.

IF YOUR SET SHOULD APPEAR TO HAVE A LOSS OF POWER, PLEASE FOLLOW THIS PROCEDURE:

- 1) Push the power switch (ON/OFF switch) once.
- 2) If there is still no power, wait 30 seconds and push the power switch again.
- 3) If there is still no power, unplug the power cord from the wall. Wait thirty seconds and plug the power cord back in. Push the power switch again.

This protective technology should provide for years of lasting entertainment from your Color Television.



# SPECIFICATIONS

## Features:

- Superfine Picture Quality
  - 750 Line Horizontal Resolution (35UX60B)
  - 700 Line Horizontal Resolution (35TX10B)
- Dark Tint Tube, INVAR Mask (35UX60B), AK Mask (35TX10B)
- Genius Remote CLU-850GR (35UX60B) and CLU-692GR (35TX10B)  
Controls many VCR brands and cable boxes, and other audio/video equipment
- ICON: Easy Graphic Guide
- Full set of Input Jacks, including S-Video
- Artificial Intelligence System (35UX60B)
- Closed Caption Decoder
- Advance high resolution Picture in Picture (35UX60B), Picture in Picture (35TX10B)
- Comb Filter, Wide-Band Video-Amp and White Control
- MTS (Multi-Channel Television Sound) Stereo Broadcast Reception
- 3D Surround Sound (3 Way) (35TX10B)
- Dolby\* Surround Sound (35UX60B)
- Velocity Scan Modulation (35UX60B)

**Screen Size:** 35V (35 inches measures diagonally)

## Inputs:

- Power Input. . . . . AC 120V, 60 Hz
- Power consumption (ave.)
  - 35UX60B. . . . . 165W
  - 35TX10B. . . . . 135W
- Power consumption (max.)
  - 35UX60B. . . . . 220W
  - 35TX10B. . . . . 180W
- Antenna input impedance. . . . . 75 Ohm
- Channel coverage. . . . . 181 ch.
  - VHF-Band. . . . . 2~13
  - UHF Band. . . . . 14~69
  - CATV Mid Band. . . . . A-5~A-1
  - A-1
  - Super Band. . . . . J-W
  - Hyper Band. . . . . W+1-W+28
  - Ultra Band. . . . . W+29-W+84
- Video. . . . . 1.0Vp-p, 75 Ohm
- S-Video
  - Luminance (Y). . . . . 1.0Vp-p, 75 Ohm
  - Chrominance (C). . . . . 0.286Vp-p, 75 Ohm
- Audio input impedance. . . . . 47k Ohm
- Average input level . . . . . 470mVrms
- Maximum input level. . . . . 940mVrms

## Outputs:

- Video. . . . . 1.0Vp-p, 75 Ohm
- Audio (fixed). . . . . 0~470mVrms, 1k Ohm

## Dimensions:

- |                      |                                  |
|----------------------|----------------------------------|
|                      | <b>35UX60B</b>                   |
| • Height (in.). . .  | 30 <sup>1</sup> / <sub>16</sub>  |
| • Width (in.). . .   | 35 <sup>31</sup> / <sub>32</sub> |
| • Depth (in.). . .   | 24 <sup>13</sup> / <sub>16</sub> |
| • Weight (lbs.). . . | 184                              |
|                      | <b>35TX10B</b>                   |
| • Height (in.). . .  | 30 <sup>1</sup> / <sub>16</sub>  |
| • Width(in.). . .    | 35 <sup>31</sup> / <sub>32</sub> |
| • Depth(in.). . .    | 24 <sup>13</sup> / <sub>16</sub> |
| • Weight (lbs.). . . | 184                              |

NOTE: Due to improvements, specifications in this operating guide are subject to change without notice.

\*Manufactured under License from Dolby Laboratories Licensing Corporation.



## NOTES

---

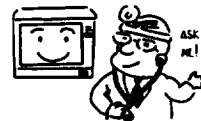

---

# HITACHI

*Service  
hotline*

To locate an authorized  
HITACHI service facility  
in the continental U.S.A.

**DIAL TOLL FREE**

7 days a week, 24 hours a day

**800 HITACHI**

1-800-448-2244

## **Hitachi Home Electronics (America), Inc.**

---

Hitachi has made every effort to assure you hours of trouble free operation from your unit. However, should you require service, a network of Hitachi Authorized Service Facilities has been established in all 50 states and Puerto Rico. Each facility will provide you with convenient and expedient assistance. Our service "Hotline" operator will direct you to the Hitachi Authorized Service Facility nearest you. Just present proof of purchase and/or delivery receipts to the Hitachi Authorized Service Facility, and service will be rendered in accordance with the terms of the limited warranty as stated on your warranty card or operating guide.

---

***Should you have any questions regarding in-warranty service, operation or technical assistance, please contact:***

**Hitachi Home Electronics (America), Inc.**

3890 Steve Reynolds Blvd  
Norcross, GA 30093  
Tel: 404-279-5600

**Hitachi Sales Corporation of Hawaii**

3219 Koapaka St. / Honolulu, HI 96819  
Tel: 808-836-3621



# INDEX

Accessories . . . . .	6	Music Surround . . . . .	24, 61
Artificial Intelligence) . . . . .	13, 55	MUTE . . . . .	28, 29, 31, 46
button . . . . .	29, 30	P IN P (Picture in Picture). . . . .	5, 31, 32, 33
Antenna . . . . .	8, 10, 15, 30, 44	Phono Connector . . . . .	9
o		Picture Cautions. . . . .	5
Preference Adjust . . . . .	57	Power	
Preference Setting . . . . .	58	Button . . . . .	13, 28, 29
Surround . . . . .	23, 24, 61, 62	Program	
o to Hi-Fi . . . . .	15, 16, 17, 18, 19	Channel Caption . . . . .	29, 49
o System Set-Up . . . . .	23, 24	Child Lock . . . . .	50
. . . . .	11, 15, 30, 32	Program List. . . . .	49
ery Replacement . . . . .	7, 41, 64	Volume Correction . . . . .	51
le Box Codes . . . . .	35, 36, 37	Ready Indicator . . . . .	25, 39, 40
les, Hook up . . . . .	9	Rear Speaker Connections . . . . .	22, 63
o for your TV and Remote . . . . .	64	RECALL . . . . .	28, 29
V . . . . .	4, 8, 26, 27, 35, 36, 37, 44	Reception	
nnel . . . . .	13, 30	Band . . . . .	44
oring Stored Codes . . . . .	40	Problems . . . . .	65
k		Remote Control	
Automatic Message . . . . .	53	Cable Box Functions . . . . .	35
Clock set . . . . .	52	Learning Functions . . . . .	38
On/Off timer . . . . .	29, 52	Picture in Picture . . . . .	32
nections,		Sensor . . . . .	13, 25, 27
Antenna . . . . .	4, 10	TV Functions . . . . .	28, 29, 30, 31
Front Panel . . . . .	14	VCR Functions . . . . .	34
Rear Panel . . . . .	17, 18, 19, 20, 21, 22	RESET . . . . .	48, 54, 56, 57
RSOR . . . . .	28, 29, 30, 42	S-Video . . . . .	9, 14, 15, 22
BY Surround . . . . .	63	Safety Tips. . . . .	2, 3, 4
y Graphic Guide . . . . .	42, 43	SA, SAP . . . . .	29, 58
TER . . . . .	28, 29, 30, 42	SELECT . . . . .	34, 35
HNG . . . . .	32	Select Switch. . . . .	25, 26, 27, 34, 35, 39
onconnector . . . . .	9	Service Hotline . . . . .	69
ORITE CHANNELS . . . . .	47	Service . . . . .	4, 66, 69
EZE . . . . .	33	SET UP	
nt Panel Controls . . . . .	11, 12, 13	AIR/CABLE . . . . .	44
.L Surround. . . . .	23, 62	Auto Program . . . . .	45
ortant Safeguards . . . . .	2, 3, 4	Channel Memory . . . . .	45
it Balance . . . . .	63	Closed Caption . . . . .	46
ks		SHIFT . . . . .	33
Rear Panel . . . . .	15, 16	Simulate Surround . . . . .	24, 61
Front Panel . . . . .	11, 12, 13, 14	Speaker, Rear . . . . .	15, 22, 23, 24, 63
rn Indicator . . . . .	25, 39, 40	Specifications . . . . .	67
\RN/USE Switch . . . . .	25, 34, 35, 39, 40	Storing Codes . . . . .	39
HT Button . . . . .	25, 27, 31	Twin Lead Connector . . . . .	9
ation, Viewing. . . . .	3, 8, 64	UHF/VHF . . . . .	10, 15, 30, 44
-CH . . . . .	28, 29, 31	VCR Codes . . . . .	34, 36, 37
TRIX Surround . . . . .	23, 62	Video	
NU . . . . .	28, 29, 30, 42	Preference Adjust . . . . .	54
/ie Surround . . . . .	24, 61	Preference Setting . . . . .	55
o Sound . . . . .	58	Volume . . . . .	11, 31
ti-page . . . . .	25, 26, 27		



**HITACHI**