

HITACHI

SOLID STATE COLOR TV

31CX4B

31UX5B

OPERATING GUIDE



IMPORTANT SAFEGUARDS

2 - 5



FIRST TIME USE

6 - 19



THE GENIUS REMOTE CONTROL

20 - 36

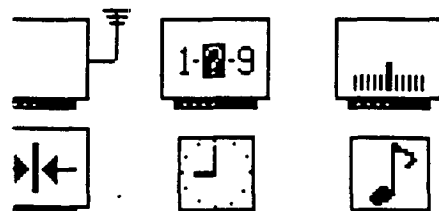

EASY GRAPHIC GUIDE

37 - 52



USEFUL INFORMATION

INDEX



53 - 60



IMPORTANT

Your new HITACHI COLOR TV incorporates a host of features designed to give you excellent performance if you follow the instructions in this manual. We recommend that you read the following instructions and "IMPORTANT SAFETY GUARDS" notice before turning on your TV set for the first time.

Follow all warnings and instructions marked on this television receiver.

	CAUTION RISK OF ELECTRIC SHOCK DO NOT OPEN	
CAUTION: TO REDUCE THE RISK OF ELECTRIC SHOCK, DO NOT REMOVE COVER (OR BACK) NO USER-SERVICEABLE PARTS INSIDE. REFER SERVICING TO QUALIFIED SERVICE PERSONNEL.		



The lightning flash with arrowhead symbol, within an equilateral triangle, is intended to alert the user to the presence of uninsulated "dangerous voltage" within the product's enclosure that may be of sufficient magnitude to constitute a risk of electric shock to persons.



The exclamation point within an equilateral triangle is intended to alert the user to the presence of important operating and maintenance (servicing) instructions in the literature accompanying the appliance.

WARNING:
TO PREVENT FIRE OR SHOCK HAZARD, DO NOT EXPOSE THIS TELEVISION SYSTEM TO RAIN OR MOISTURE.



- NOTE:**
- There are no user serviceable parts inside the receiver.
 - Model number and serial number are indicated on back side of the set.

POWER SOURCE:

This HITACHI color TV is designed to operate on 120 volts 60 Hz, AC household current. Insert power cord into a 120 volt 60 Hz outlet.

TO PREVENT ELECTRIC SHOCK, DO NOT USE THE TELEVISION'S PLUG WITH AN EXTENSION CORD, RECEPTACLE, OR OTHER OUTLET UNLESS THE BLADES AND GROUND TERMINAL CAN BE FULLY INSERTED TO PREVENT BLADE EXPOSURE.

NEVER CONNECT THE TV TO 50 Hz, DIRECT CURRENT, OR ANYTHING OTHER THAN THE SPECIFIED VOLTAGE.

NOTE: This television receiver will display television closed captioning, ( or ), in accordance with paragraph 15.119 of the FCC rules.



SAFETY TIPS

IMPORTANT SAFEGUARDS

SAFETY POINTS YOU SHOULD KNOW ABOUT YOUR HITACHI TELEVISION RECEIVER

CAUTION:

- Read all of these instructions
- Save these instructions for later use.
- Follow all warnings and instructions marked on the television receiver.

Our reputation has been built on the quality performance, and ease of service of HITACHI television receivers.

Safety is also foremost in our minds in the design of these units. To help you operate these products properly, this folder illustrates safety tips which will be of benefit to you. Please read it carefully and apply the knowledge you obtain from it to the proper operation of your HITACHI television receiver.

Please fill out your warranty card at once and mail it to HITACHI. This will enable HITACHI to notify you promptly in the improbable event that a safety problem should be discovered in your model of product.

FOR YOUR PERSONAL SAFETY

This television set is equipped with a polarized alternating-current line plug (a plug having one blade wider than the other). This plug will fit into the power outlet only one way. This is a safety feature. If you are unable to insert the plug fully into the outlet, try reversing the plug. If the plug should still fail to fit, contact your electrician to replace your obsolete outlet. Do not defeat the safety purpose of the polarized plug.



When the power cord or plug is damaged or frayed, unplug this television set from the wall outlet and refer servicing to qualified service personnel.

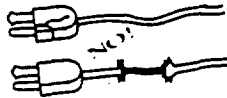

Do not overload wall outlets and extension cords as this can result in fire or electric shock.

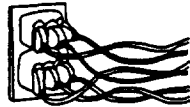

Do not allow anything to rest on or roll over the power cord, and do not place the TV where the power cord is subject to traffic or abuse. This may result in a shock or fire hazard.



Do not attempt to service this television set yourself as opening or removing covers may expose you to dangerous voltage or other hazards. Refer all servicing to qualified service personnel.

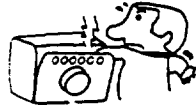

Never push objects of any kind into this television set through cabinet slots as they may touch dangerous voltage points or short out parts that could result in a fire or electric shock. Never spill liquid of any kind on the television set.

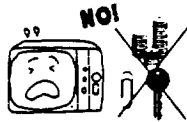

7 If the television set has been dropped or the cabinet has been damaged, unplug this television set from the wall outlet and refer servicing to qualified service personnel.

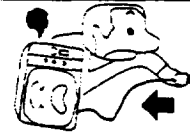

8 If liquid has been spilled into this television set, unplug it from the wall outlet and refer service to qualified service personnel.



9 Do not subject your television set to impact of any kind. Be particularly careful not to damage the picture tube surface.



10 Unplug this television set from the wall outlet before cleaning. Do not use liquid cleaners or aerosol cleaners. Use a damp cloth for cleaning.



11-1 Do not place this television set on an unstable cart, stand, or table. The television set may fall, causing serious injury to a child or an adult, and serious damage to the appliance. Use only with a cart or stand recommended by the manufacturer, or sold with the television set. Wall or shelf mounting should follow the manufacturer's instructions, and should use a mounting kit approved by the manufacturer.



11-2 An appliance and cart combination should be moved with care. Quick stops, excessive force, and uneven surfaces may cause the appliance and cart combination to overturn.



PROTECTION AND LOCATION OF YOUR SET

Do not use this television set near water, for example near a bathtub, washbowl, kitchen sink, or laundry tub, in a wet basement, or near a swimming pool, etc.



Never expose the set to rain or water. If the set has been exposed to rain or water, unplug the set from the wall outlet and refer to servicing personnel.



Choose a place where light (artificial or sunlight) does not shine directly on the screen.

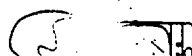

Avoid dusty places. Accumulated dust

15 when high humidity persists. The set has slots, or openings in the cabinet for ventilation purposes, to provide reliable operation of the receiver, and to protect from overheating. These openings must not be blocked or covered.

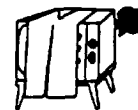

• Never cover the slots or openings with cloth or other material.



• Never block the bottom ventilation slots of the set by placing it on a bed, sofa, rug, etc.



• Never place the set near or over a radiator or heat register.





SAFETY TIPS

PROTECTION AND LOCATION OF YOUR SET

- 1 If an outside antenna is connected to the television set, be sure the antenna system is grounded so as to provide some protection against voltage surges and built up static charges. Section 810 of the National Electrical Code, NFPA No. 70-1975.

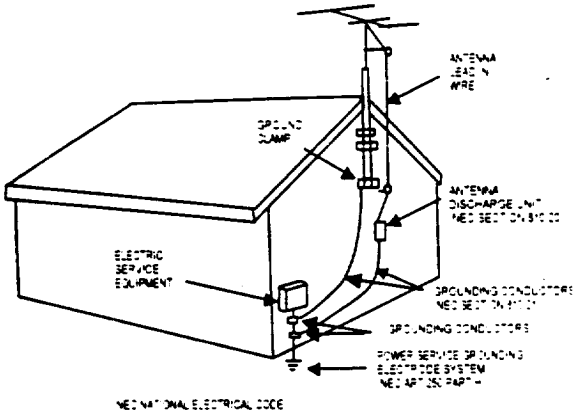

EXAMPLE OF ANTENNA GROUNDING AS PER NATIONAL ELECTRICAL CODE INSTRUCTIONS

provides information with respect to proper grounding of the mast and supporting structure, grounding of the lead-in wire to an antenna discharge unit, size of grounding conductors, location of antenna discharge unit, connection to grounding electrode, and requirements for the grounding electrode.

- 16-2 Note to CATV system installer:
(Only for the television set with CATV reception)
This reminder is provided to call the CATV system installer's attention to Article 820-40 of the NEC that provides guidelines for proper grounding and, in particular, specifies that the cable ground shall be connected to the grounding system of the building, as close to the point of cable entry as practical.

- 17 An outside antenna system should not be located in the vicinity of overhead power lines or other electrical lights or power circuits, or where it can fall into such power lines or circuits. When installing an outside antenna system, extreme care should be taken to keep from touching such power lines or circuits as contact with them might be fatal.

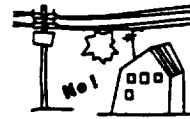

- 18 For added protection for this television set during a lightning storm, or when it is left unattended and unused for long periods of time, unplug it from the wall outlet and disconnect the antenna. This will prevent damage due to lightning and power-line surges.



OPERATION OF YOUR SET

- 3 This television set should be operated only from the type of power source indicated on the marking label. If you are not sure of the type of power supply at your home, consult your television dealer or local power company. For television sets designed to operate from battery power, refer to the operating instructions.

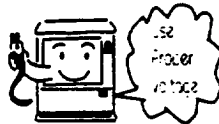

- 20 If the television set does not operate normally by following the operating instructions, unplug this television set from the wall outlet and refer servicing to qualified service personnel. Adjust only those controls that are covered in the operating instructions as improper adjustment of other controls may result in damage and will often require extensive work by a qualified technician to restore the television set to normal operation.



- 21 When going on a holiday, if your television set is to remain unused for a period of time, turn the television set "off" and unplug it from the wall outlet.



IF THE SET DOES NOT OPERATE PROPERLY

- 2 If you are unable to restore normal operation by following the detailed procedure in your operating instructions, do not attempt any further adjustment. Unplug the set and call your dealer or service technician.



- 23 Whenever the television set is damaged or fails, or a distinct change in performance indicates a need for service, unplug the set and have it checked by a professional service technician.

- 24 It is normal for some TV sets to make occasional snapping or popping sounds, particularly when being turned on or off. If the snapping or popping is continuous or frequent, unplug the set and consult your dealer or service technician.

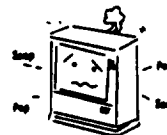

FOR SERVICING AND MODIFICATION

- 5 Do not use attachments not recommended by the television set manufacturer as they may cause hazards.

- 6 When replacement parts are required, be sure the service technician has used replacement parts specified by the manufacturer that have the same characteristics as the original part. Unauthorized substitutions may result in fire, electric shock, or other hazards.



- 27 Upon completion of any service or repairs to the television set, ask the service technician to perform routine safety checks to determine that the television is in safe operating condition.

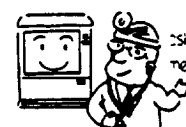



WARNING

Continuous on-screen displays such as video games, stock market quotations, computer generated graphics, and other fixed (non-moving) patterns can cause permanent damage to color television receivers. Such "PATTERN BURNS" constitute misuse and are NOT COVERED by your Hitachi Factory Warranty.

When using the Picture-in-Picture function, the sub-picture should not be left permanently in one corner of the screen or a "pattern burn" may develop over a long period of time.

This Color television receiver was intended mainly for the private viewing of programs broadcast by TV stations and cable companies and programs from other video sources. Public viewing may require prior authorization from the broadcaster or owner of the video program.



ACCESSORIES

Check to make sure you have the following accessories before disposing of the packing material.

For information regarding how to obtain these accessories, please call TOLL FREE 1-800-448-2244 for your nearest HITACHI Authorized Parts Distributor in the continental United States. For Alaska and Hawaii, please contact your nearest HITACHI Regional office

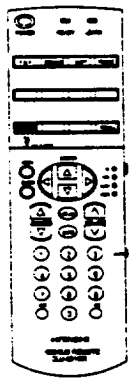
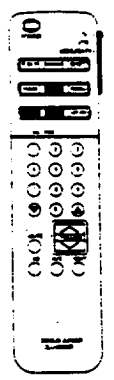
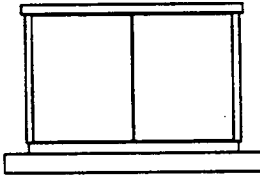
PART NAME	PART NO.	ILLUSTRATION	
CLU-851GR REMOTE TRANSMITTER	2573972	 CLU-851GR	 CLU-692GR
CLU-692GR REMOTE TRANSMITTER	2573922		
TELEVISION STAND SP313G (Not included. order separately)	H410256	 CUSTOM HITACHI TELEVISION STAND Excellent for VCR and videotape storage. Special Features: curved smoke glass doors, adjustable shelf. Available in Black.	
TELEVISION STAND SP314G (Not included. order separately)	H410255 (Upgrade)		
TELEVISION STAND SP315B (Not included. order separately)	H410258 31UX5B		



CAUTION: The television stand model SP313G, SP314G and SP315B is designed for use only with HITACHI TV models 31CX4B and 31UX5B. Use with other television equipment may result in instability, causing possible injury.

REMOTE CONTROL BATTERY INSTALLATION AND REPLACEMENT



1. Open the battery cover of the remote transmitter by pushing the notched part of the cover with your fingers.
2. Insert new "AA" size (SUM-3) batteries or equivalent for the Genius Remote. When replacing old batteries, push them towards the springs and lift them out.
3. Match the (+) and (-) marks in the battery compartment.
4. Replace the cover.

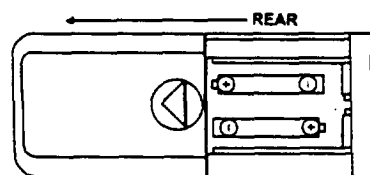
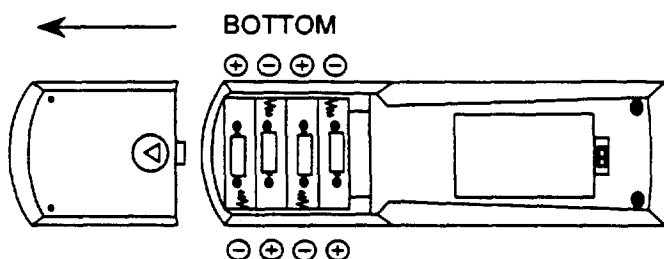

CAUTIONS

1. If your television set is to remain unused for a long period of time, for instance, when you go on a vacation, unplug the television set from the wall outlet.
2. Do not subject the Remote Transmitter to shocks such as dropping it on the floor, etc. Precision parts may be damaged.
3. Do not allow the Remote Transmitter to become wet and avoid placing it in areas of high humidity. Don't leave it on or near a heater. Excess heat or moisture may cause the unit to cease operation.
4. If the batteries become exhausted, Remote Control operation may become erratic or stop altogether. Replace the old batteries with fresh "AA" (SUM-3) types.

NOTES

1. When the power button is set to OFF, the OFF TIMER is released.
2. The channel No. indication, volume indication and OFF TIMER indication are not displayed simultaneously.
3. To operate your TV, point the Remote Transmitter at the remote sensor of the TV.

HOOK-UP CABLES AND CONNECTORS



Most video-audio connections between components can be made with shielded video and audio cables that have the correct connectors. For best performance, video cables should use 75-ohm coaxial shielded wire. Cables can be purchased from most stores that sell audio/video products. Below are illustrations and names of common connectors. Before purchasing any cables, be sure of the output and input connector types required by the various components. Also be sure the cables are the correct length.

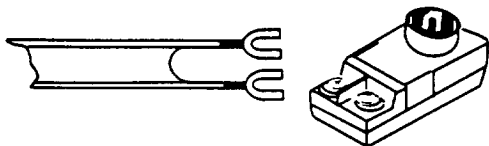

300-Ohm Twin Lead Connector

This outdoor antenna cable must be connected to an antenna adaptor (300-Ohm to 75-Ohm).



"F" Type 75-Ohm Coaxial Antenna Connector

For connecting RF signals (antenna or cable TV) to the antenna jack on the television.



Video Connector

Found on all standard video and audio cables which connect to inputs and outputs located on the Television's front and rear jack panels.



S-Video (Super Video) Connector

This connector is used on camcorders, VCR's, and laser disc players with an S-Video feature in place of the standard video cable to produce a high-quality picture.

ANTENNA CONNECTIONS

These sets are equipped with one VHF/UHF antenna terminal. The VHF/UHF terminal can be used for normal TV, cable (CATV), a TV game, etc.

VHF (75Ohm) antenna/CATV

When using a 75 ohm coaxial cable system, disconnect the VHF adaptor from the VHF 75 ohm receptacle and connect the outdoor antenna or CATV cable to a VHF 75 ohm receptacle.

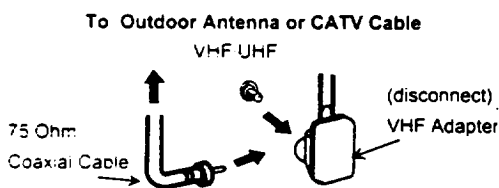

3. When both VHF and UHF antennas are connected

Attach an optional ANT. MIXER to the TV antenna terminal, and connect the cables to the ANT. MIXER.

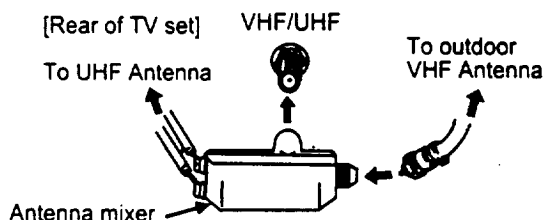

VHF (300Ohm) antenna/UHF antenna

When using a 300 ohm twin lead from an outdoor antenna, disconnect the (VHF or UHF) indoor antenna leads from screws of the (VHF or UHF) adaptor, and connect outdoor (VHF or UHF) antenna leads to these screws of a (VHF or UHF) adaptor.

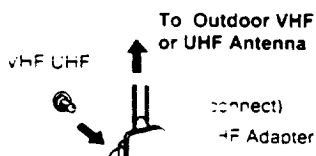

Notes:

1. If an outdoor antenna/CATV is to be used, disconnect the indoor antenna. Do not leave both the indoor and outdoor antennas/CATV connected at the same time, since ghosting and poor reception may result.
2. Consult your dealer or service store for the ANT. MIXER and (VHF or UHF) adaptor.



FRONT PANEL CONTROLS

FRONT VIEW

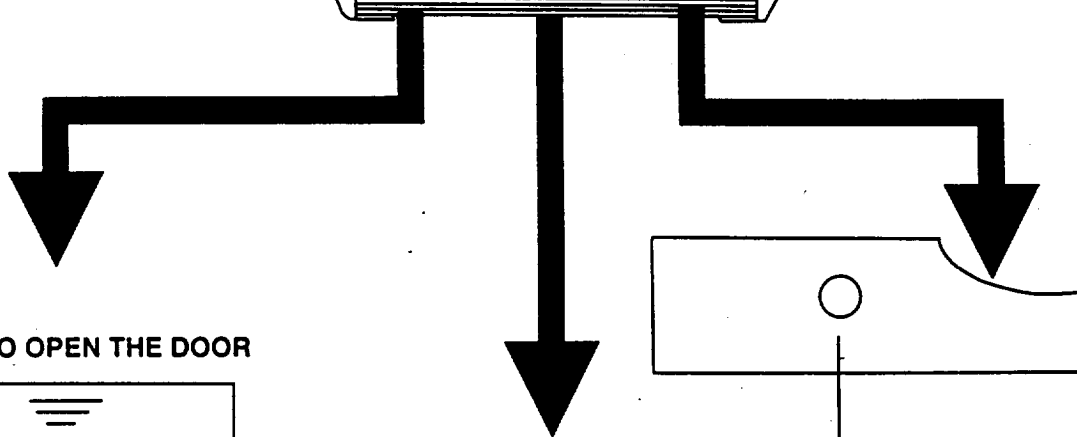
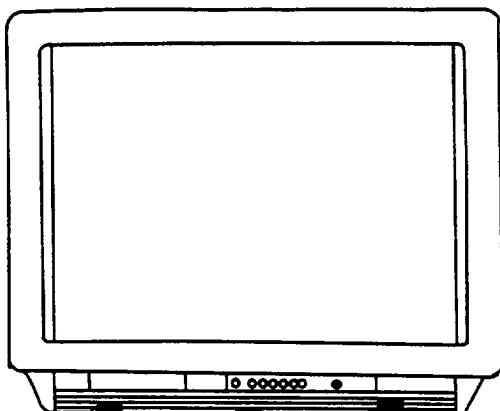

HOW TO OPEN THE DOOR

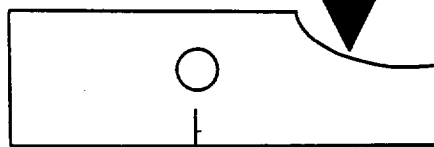
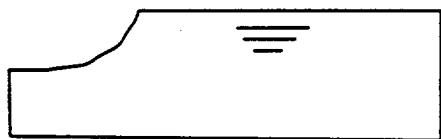

⑤ Infrared Remote Sensor

INDOOR CONTROLS

1. Push on "≡"
2. Pull the door toward the front to open it.

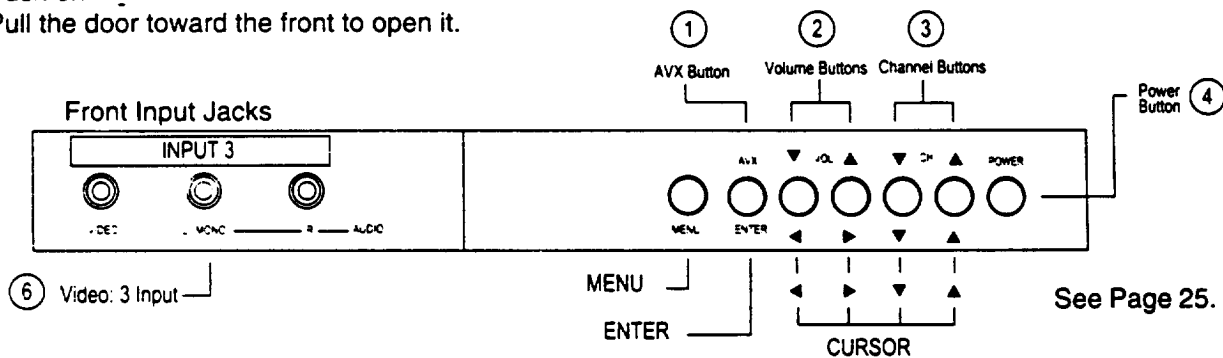

NOTE: The "Program Icon", "Clock Icon" and Channel Memory Menu in "Set Up" are not displayed using the Front Menu Key. This feature uses the numbered buttons which are not in the front panel and the CH UP/DOWN button is disabled at Menu Function. For complete Menu Icon, use the remote control supplied.

FRONT PANEL CONTROLS



AVX(Audio/Video) selector

Press this button to select the current antenna source, or VIDEO: 1, 2 or 3. Your selection is shown in the top right corner of the screen.

VOLUME level

Press these buttons for your desired sound level. The volume level will be displayed on the TV screen.

CHANNEL selector

Press these buttons until the desired channel appears in the top right corner of the TV screen.

POWER button

Press this button to turn the TV on or off.

NOTE: Your HITACHI TV will appear to be turned "off" if there is no video input when VIDEO: 1, 2, or 3 is selected. Press AVX until it returns to the same Video. if not Power is "off".

REMOTE CONTROL sensor

Point your Genius Remote at this area when selecting channels, adjusting volume, etc.

FRONT INPUT JACKS (for VIDEO: 3)

Use these audio/video jacks for a "quick" hook-up from a camcorder or VCR to instantly view your favorite show or new recording. (Press the AVX button until VIDEO: 3 appears in the top right corner of the TV screen.)



FRONT PANEL JACKS AND CONNECTIONS

The front panel jacks are provided as a convenience to allow you to easily connect a camcorder or VCR as shown in the following examples:

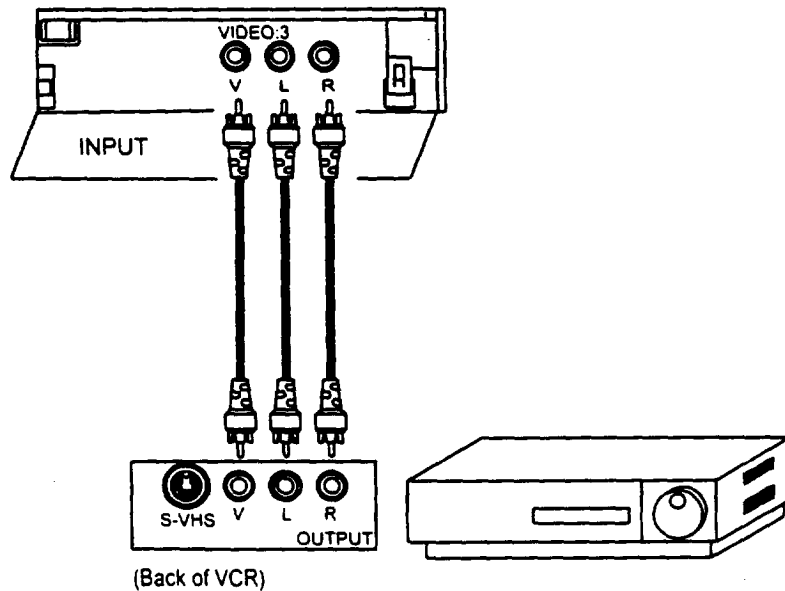
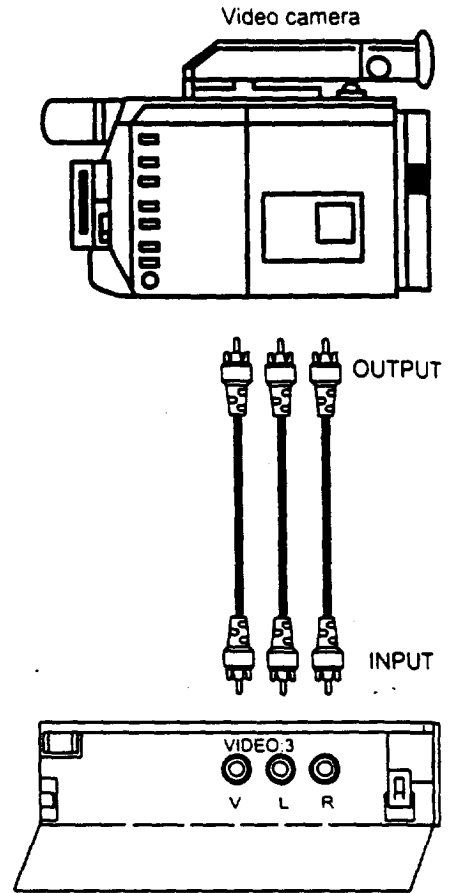
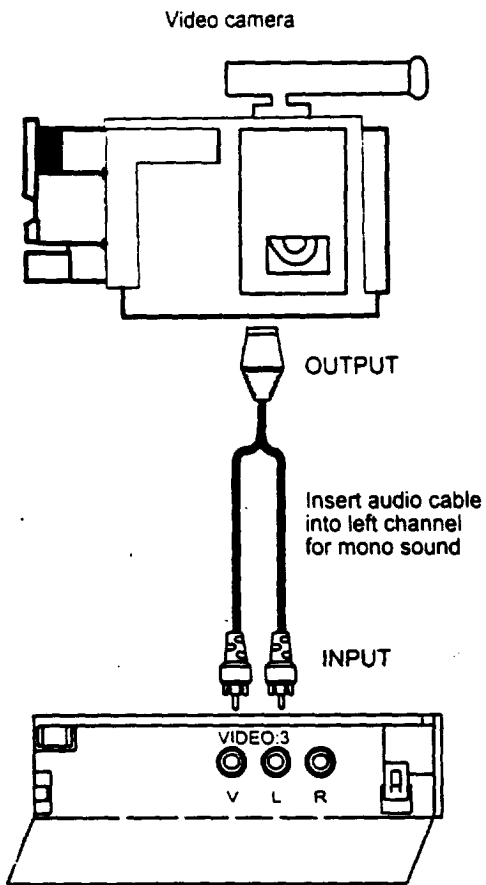

REAR PANEL JACKS

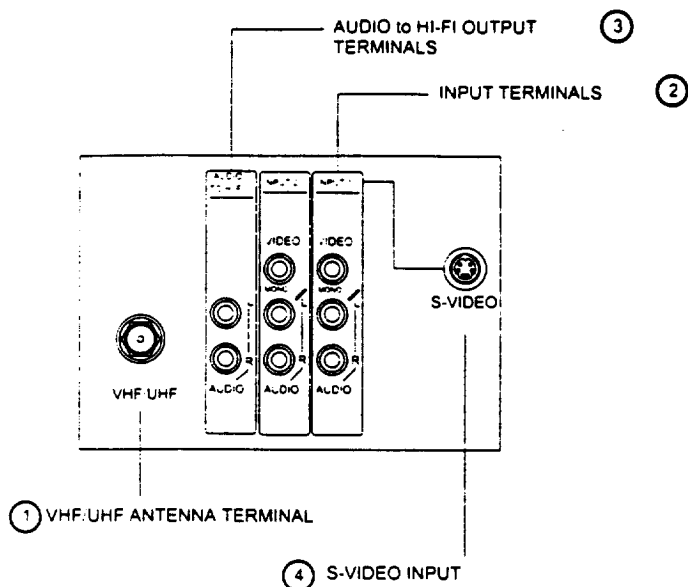

Antenna Inputs

The VHF/UHF terminal can be used for normal TV, cable TV (CATV), a TV game, etc.

Audio/Video Inputs 1, 2

The "AVX" (Auxiliary video) button will step through each video source and the current antenna input each time it is pressed. Use the audio and video inputs to connect external devices, such as VCR's, camcorders, laser disc players, video games, etc.

Audio to Hi-Fi

These jacks provide variable audio output to a separate stereo system amplifier. With this connection, the audio to the stereo can be controlled by the television's remote control. Use these jacks for the SURROUND Left and Right channels. (See page 16 and 19.)

S-Video

Input 1 provides S-Video (Super Video) jacks for connecting equipment with S-Video output capability.

NOTES ON REAR PANEL CONNECTIONS

S-Video connection is provided for high performance laser discs, VCR's, etc., that have this feature. Use this connection in place of the standard video connection if your device has this feature.

If your device has only one audio output (mono sound), connect it to the left audio jack on the TV.

Refer to the operating guide of your other electronic equipment for additional information on connecting your hook-up devices.

A single VCR can be used for VCR #1 and VCR #2, but note that a VCR cannot record its own video or line output (see the example on p. 15). Refer to your VCR operating guide for more information on "line" input-output connections.



REAR PANEL JACKS

REAR VIEW

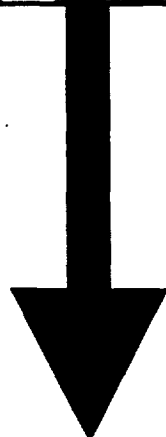
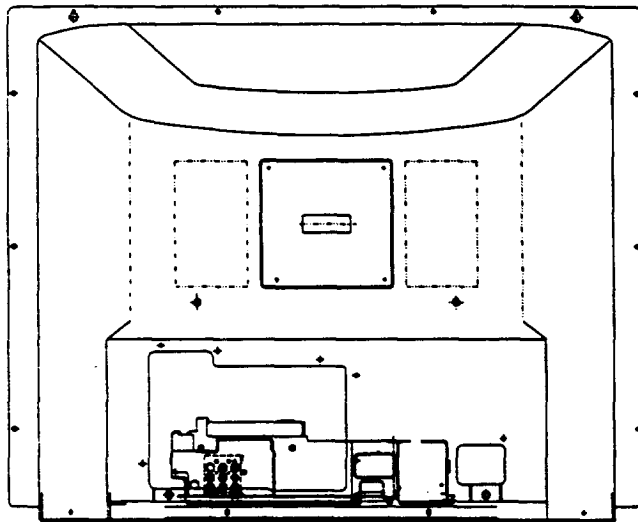

AUDIO to HI-FI OUTPUT TERMINALS (3)

INPUT TERMINALS (2)

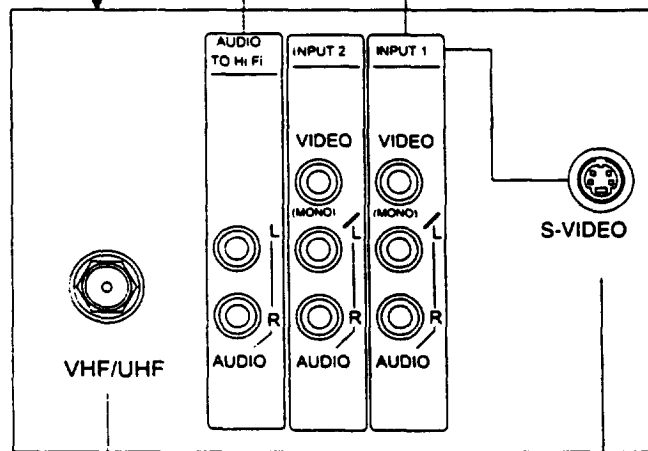

(1) VHF/UHF ANTENNA TERMINAL

(4) S-VIDEO INPUT



FRONT PANEL CONNECTIONS

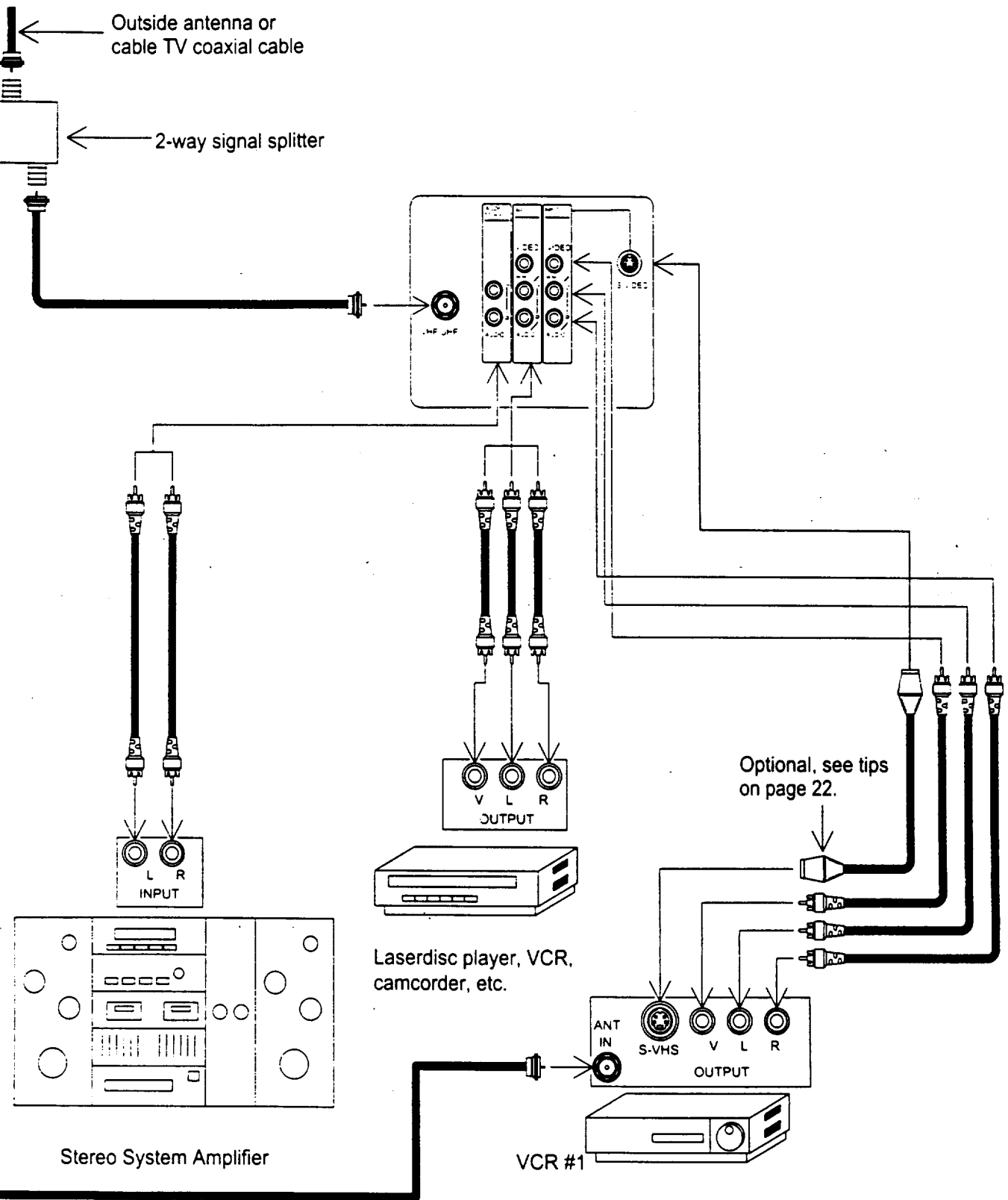



EXTERNAL CONNECTIONS

CONNECTING EXTERNAL AUDIO AMPLIFIER

To control the audio level of an external audio amplifier with the remote transmitter, connect the system as shown below in Fig. 1.

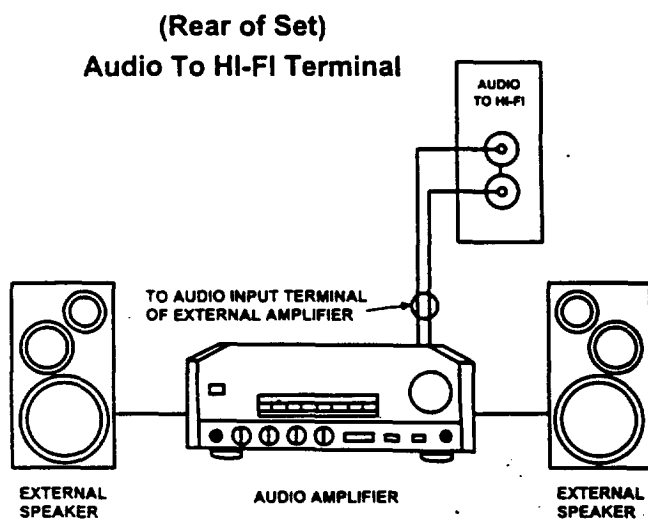

FIG. 1

NOTE: To prevent damage to the speaker and distorted sound, set the volume control of the audio amplifier lower and adjust the sound level using the volume control on the remote transmitter of the TV set.



CONNECTING EXTERNAL VIDEO SOURCES

The exact arrangement you use to connect the Video Cassette Recorder, Video Disc Player and Video Camera to your set is dependent on the model and features of each component. Check the Owner's Manual of each component for location of its video and audio inputs and outputs. The following connection diagrams are offered as suggestions. However, you may need to modify them to accommodate your particular assortment of components and features. For best performance, video and audio cables should be made from coaxial shielded wire.

Operating External Video Source

Input mode is changed every time the AVX button is pressed as shown below. Connect External source to the INPUT terminal, then press the AVX button as necessary to view the input source.

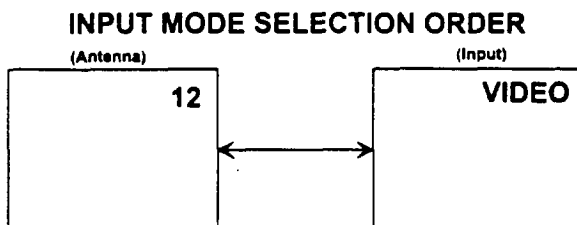

NOTE: When TV is set to "VIDEO" and a video signal is not received from VIDEO INPUT JACK on the jack panel of the TV (i.e., VCR/Video Disc Player, etc. is not connected or the video device is OFF), the screen will be grey-blue.

CONNECTING MONAURAL AUDIO VCR OR VIDEO DISC PLAYER

Connect the cable from the VIDEO OUT of the VCR or the Video Disc Player to the INPUT (VIDEO) jack on the TV set. (Fig. 1)

Connect the cable from the AUDIO OUT of the VCR or Video Disc Player to the INPUT (MONO)/L(AUDIO) jack. (Fig. 1)

Press the AVX button to view the program from the VCR or Video Disc Player. The video mode "VIDEO" disappears automatically after approx. 8 seconds.

Press the AVX button to return to the previous channel.

See Below.

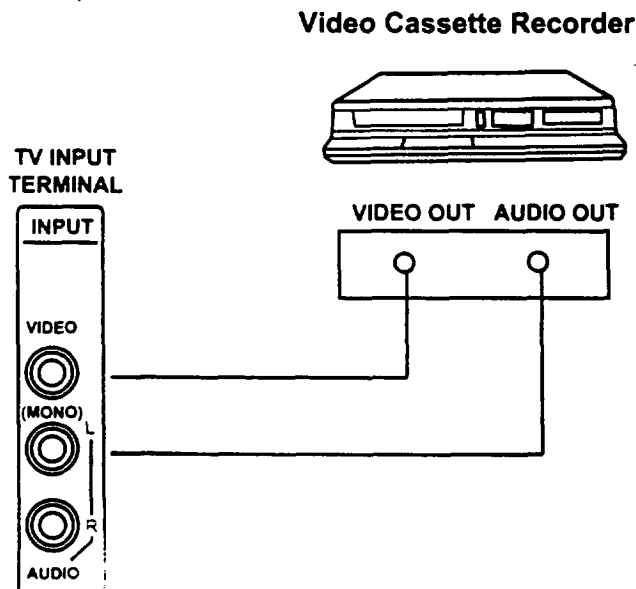



CONNECTING EXTERNAL VIDEO SOURCE

CONNECTING STEREO VCR OR STEREO VIDEO DISC PLAYER

1. Connect the cable from the VIDEO OUT of the VCR or the Video Disc Player to the "INPUT (VIDEO)" jack on the TV set. (Fig. 1)
2. Connect the cable from the AUDIO OUT "R" of the VCR or the Video Disc Player to the "INPUT(AUDIO)R)" jack (Fig. 1)
3. Connect the cable from the AUDIO OUT "L" of the VCR or the Video Disc Player to the "INPUT(AUDIO/L)" jack (Fig. 1)
4. Press the AVX button to view the program from the VCR or Video Disc Player. The video mode "VIDEO" disappears automatically after approx. 8 seconds.
5. Press the AVX button to return to the previous channel.

Video Cassette Recorder

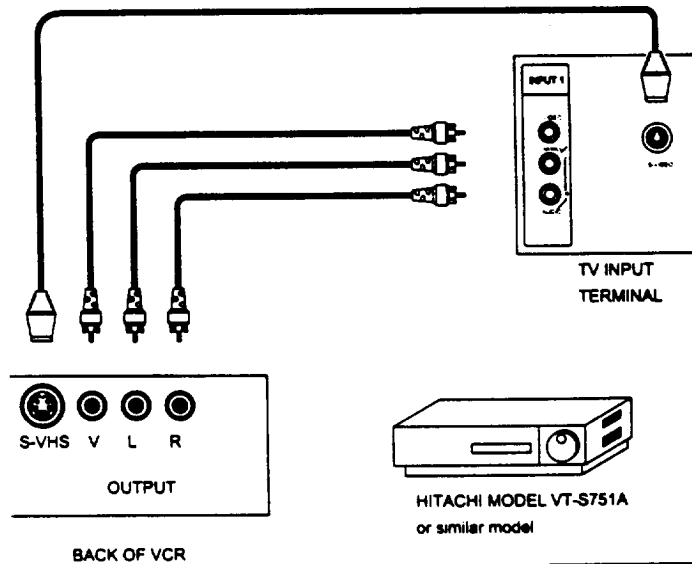
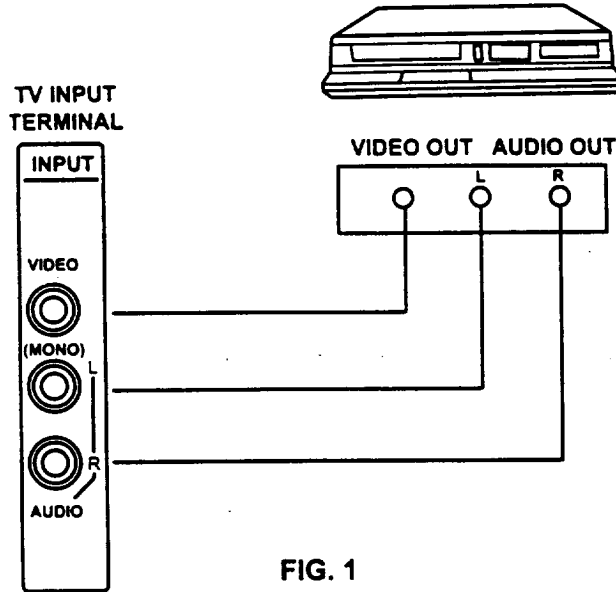

NOTE: Completely insert the connection cord plugs when connecting to REAR panel jacks. If you do not the played back picture may be abnormal.

If you have an S-VHS VCR, use the S INPUT cable in place of the standard video cable.

AUDIO SYSTEM SET-UP



Match the numbers below to the diagram for speaker placement and refer to the table for the different surround sound requirements. (See page 52 for SURROUND functions.)

- 1) The television's internal speakers.
- 2) These speakers are connected to a separate audio amplifier. Use the "Audio to Hi-Fi" output on the TV.

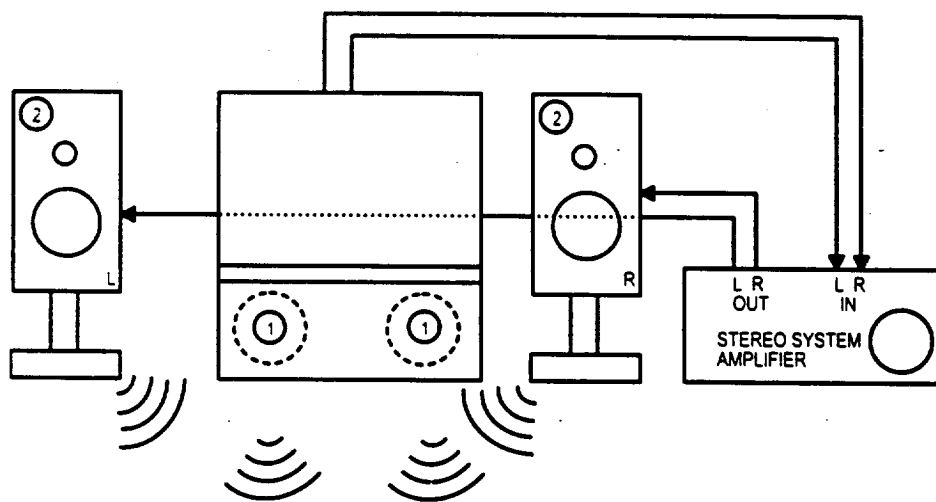

SURROUND FEATURE	REQUIRED CONNECTION	OPTIONAL CONNECTION	EFFECT
OFF	①	②	Receive Mono and Stereo Sound.
SIMULATE	①	②	At Mono Input, sound is changed more loudly.
MUSIC	① ②	—	At stereo Input, sound of music is changed more loudly, Surround Channel added to left and right Audio Amplifier speakers.



THE GENIUS REMOTE CONTROL (CLU-851GR)

In addition to controlling all the functions on your HITACHI Color TV, the new Genius Remote is designed to operate different types of VCR's and different types of CATV (Cable TV) converters with one touch. Basic operation keys are grouped together in one area. All other controls are separated from them and arranged in MULTI-PAGE

sections, with a display that can be switched to cover any of the four pages. Functions are arranged and properly categorized into windows, making operation simple when multiple functions are to be controlled.

To operate your TV, point the Genius Remote at the remote sensor of the TV.
To operate your VCR, point the remote at the remote sensor of the VCR.

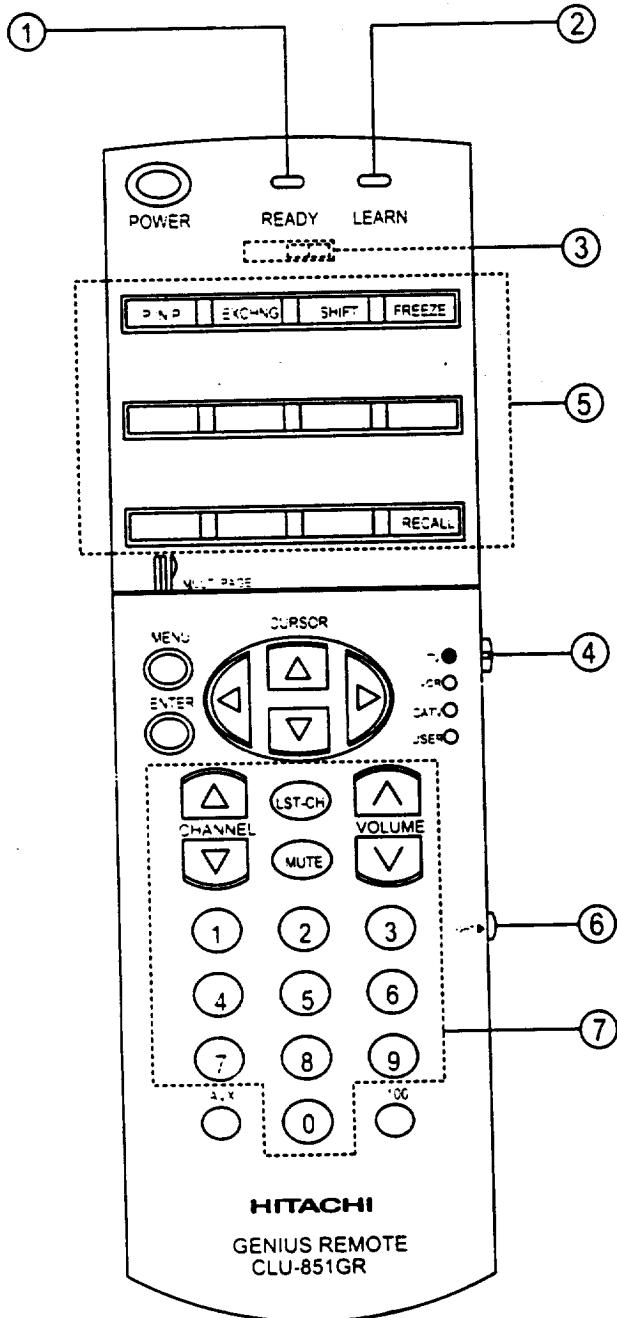

1 **READY indicator light**
Refer to page 33.

2 **SEND/LEARN indicator light**
Refer to page 33.

3 **LEARN/USE select switch**
(Located on rear side of remote control)

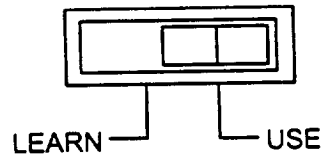

LEARN..... Enters the Learning mode.
(Refer to page 33.)

USE..... Set for normal use.

4 **MULTI-PAGE select switch**
This selects the button layout of the multi-page section of the remote control.

5 **MULTI-PAGE buttons**
These buttons change functions as shown on page 21.

6, 7 **LIGHT button**
When you are in a dark room, press this button on the side of the remote to light up the buttons shown in **7**. The light will stay on for about 8 seconds if no button is pressed. The buttons will not appear

MULTI-PAGE WINDOWS

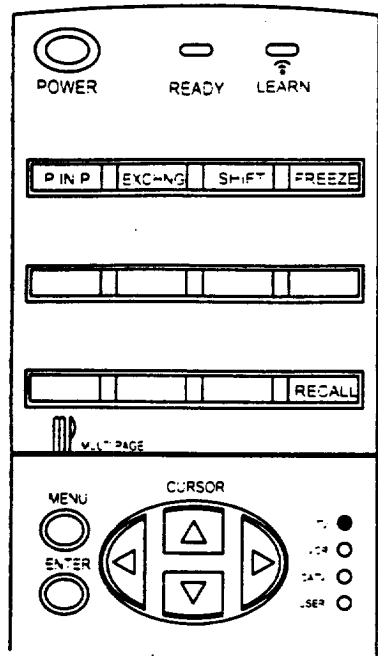

When "TV" is set

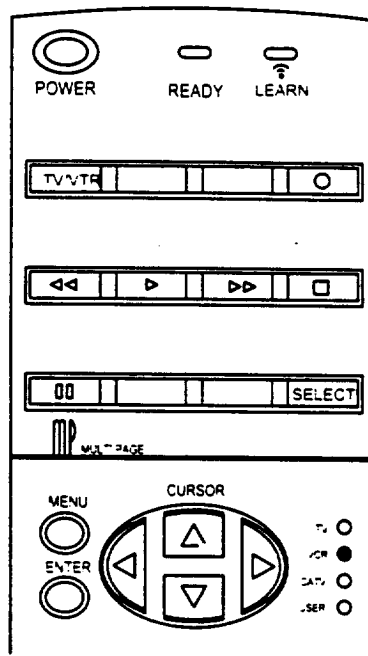

When "VCR" is set

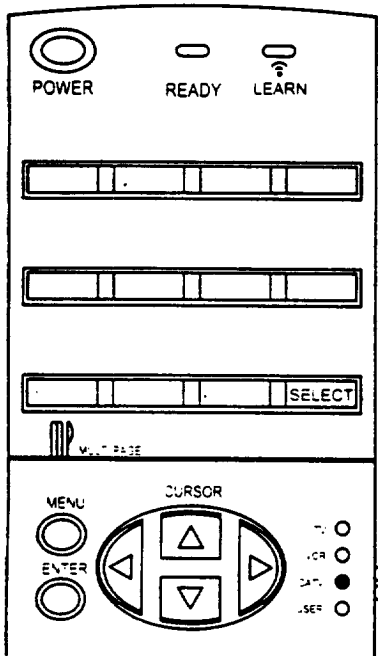

When "CATV" is set

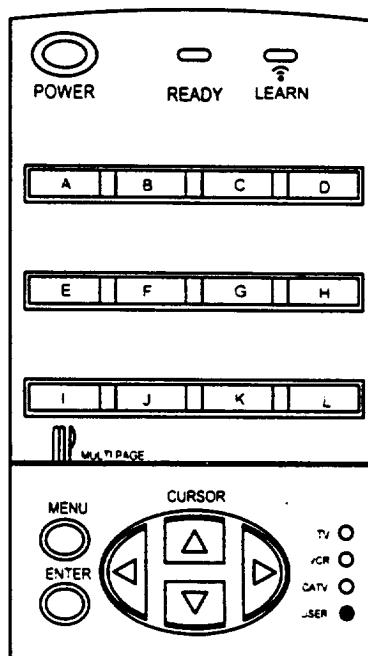

When "USER" is set



THE GENIUS REMOTE CONTROL (CLU-692GR)

In addition to controlling all the functions on your HITACHI Color TV, the Genius Remote control is designed to operate different types of VCR's (Also Abbreviated VTR) and different types of CATV converters (cable boxes) with one touch. Basic operating buttons are grouped together in one area. All other controls are separated from them

and arranged in MULTI-PAGE sections, with a display that can be switched to cover any of the three pages. Functions are arranged and properly categorized into windows. Making operation simple even when multiple functions are to be controlled.

NOTE: Precoded buttons (⑥ below) will control HITACHI TV only when the MULTI-PAGE SELECT SWITCH (① below) is set to "TV" mode.

To operate your TV, point the Genius remote at the remote sensor of the TV.
 To operate your VCR, point the remote at the remote sensor of the VCR.
 To operate your cable box, point the remote at the remote sensor of the cable box.

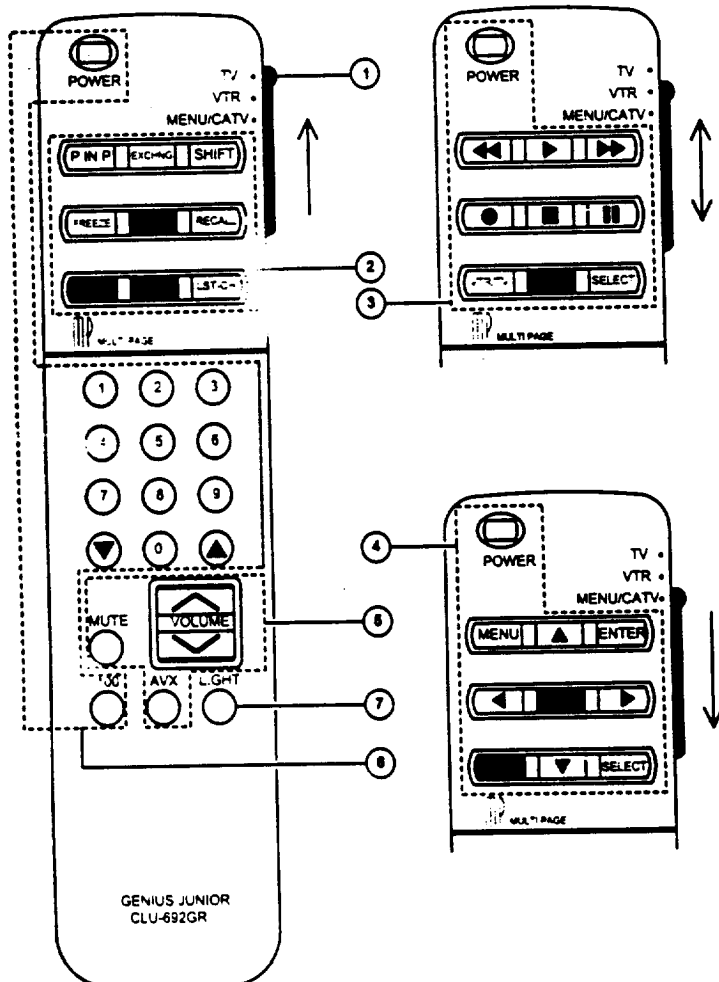

- ① **MULTI-PAGE SELECT SWITCH**
Slide the switch in the direction of the arrow to select the MULTI-PAGE mode.
- ② **Button layout when "TV" is selected.**
The P-IN-P, SHIFT EXCHNG and FREEZE buttons.
- ③ **Button layout for "VCR."**
(Power button turns the VCR on or off.)
- ④ **Button layout for "MENU/CATV."**
(Power button turns cable box on or off.)
See pages 30, 31, and 32.
- ⑤ **TV EXCLUSIVE BUTTONS**
These will always control the TV even when the Multi-Page select switch is in the VCR or MENU/CATV position.
- ⑥ **PRECODED BUTTONS**
These buttons will control a VCR or a cable box when the Multi-Page select switch is in the VCR or MENU/CATV position.
- ⑦ **LIGHT BUTTON**
When you are in a dark room, press this button or light up the Channel Keys, Volume, Up and Down Keys. The light will stay on for about 8 seconds if the button is pressed. The buttons will not appear light if the room is too bright.

HOW TO USE THE GENIUS REMOTE TO CONTROL YOUR TV



Detailed explanation of the circled numbers is on the following pages.

31UX5B
CLU-851GR
GR111

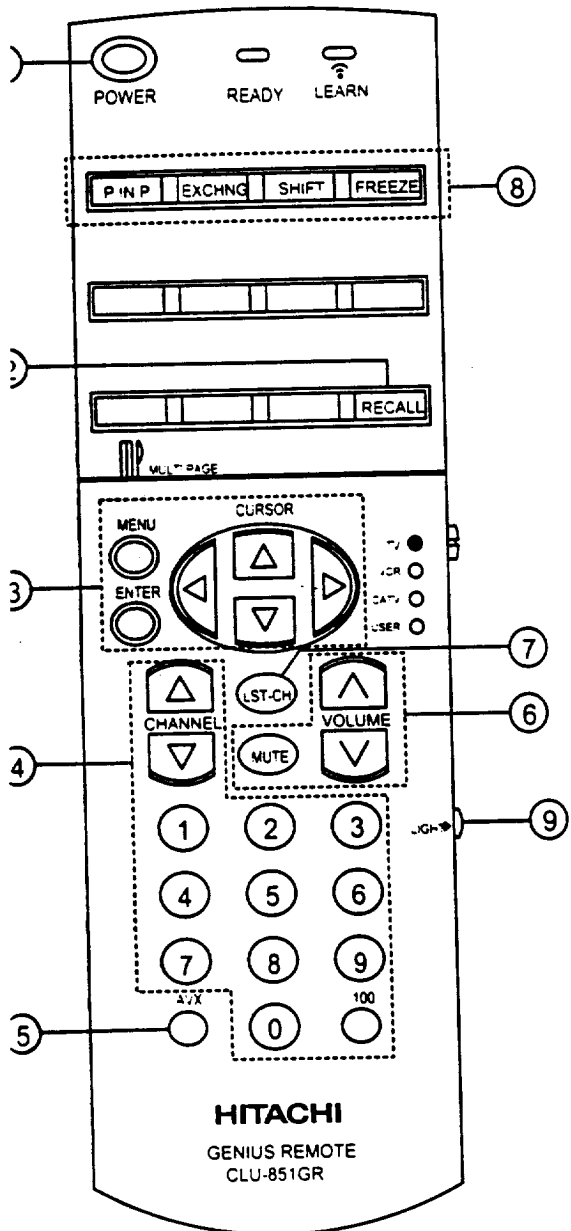

31CX4B
CLU-692GR
GJ111

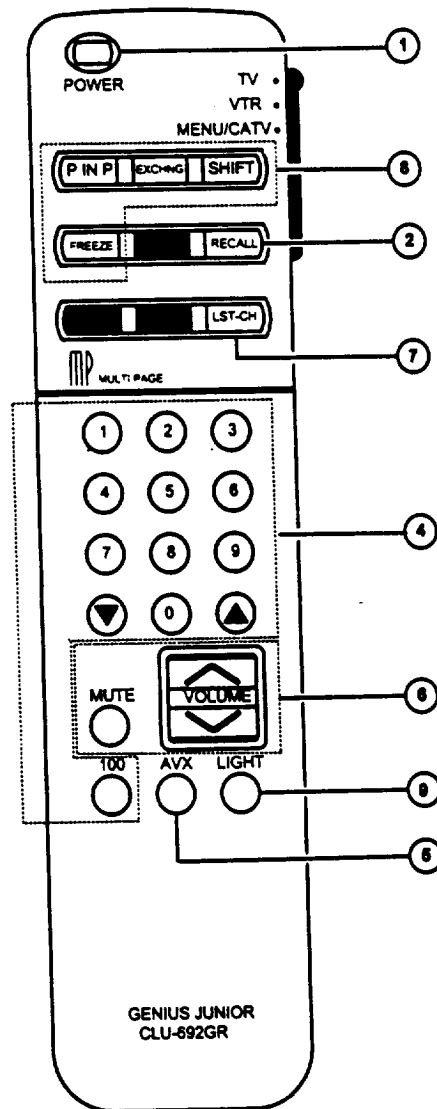

1 Detailed explanation of the circled numbers on the following pages.

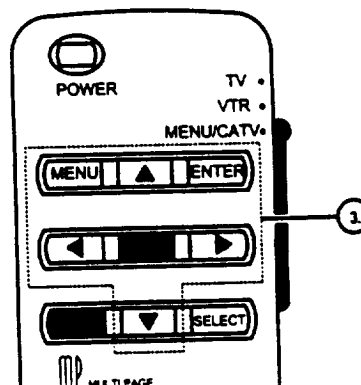



HOW TO USE THE GENIUS REMOTE TO CONTROL YOUR

- ① **POWER button**
Press this button to turn the TV set on or off. If an automatic message is set, it will be displayed when the TV is first turned on. (See page 48.)
- ② **RECALL button**
When you want to check the channel being received, or if it has a stereo (ST) or second audio program (SAP), press the RECALL button.

You can also check the time, and if the ON TIME or OFF TIME has been set. (See page 47.)

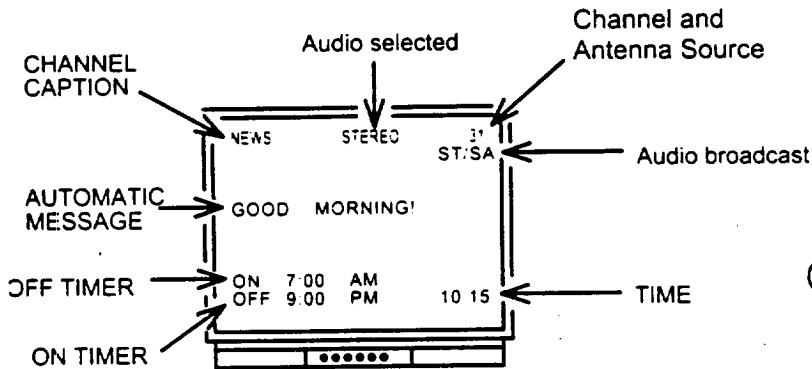

If a video input is used:

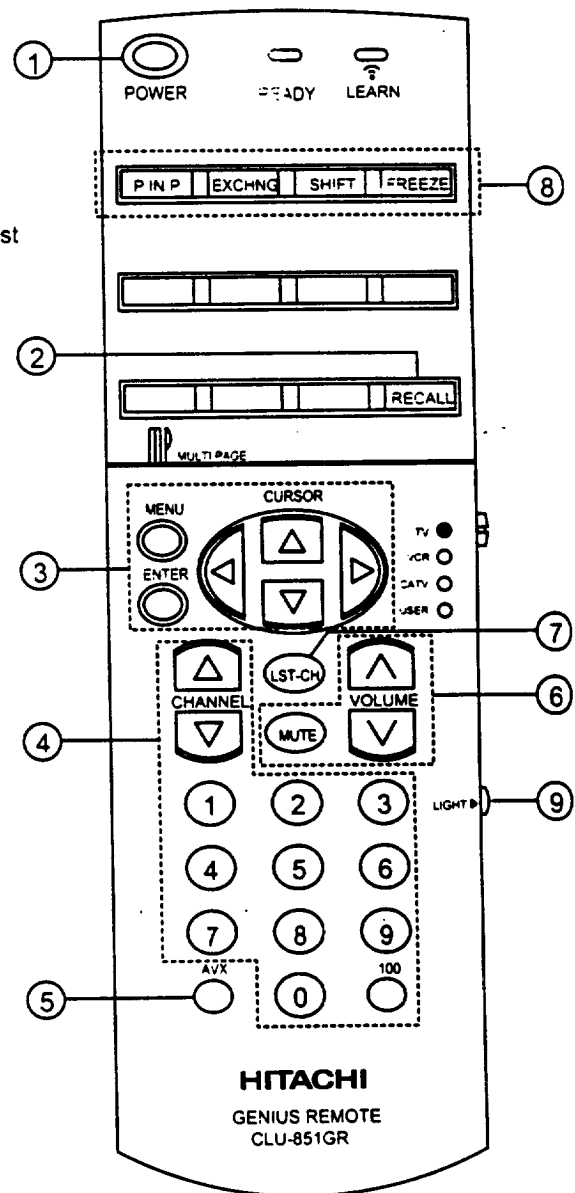
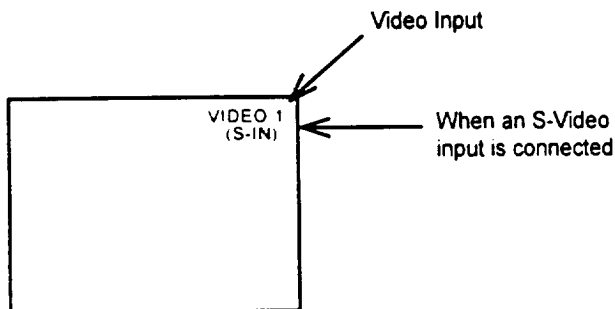

You can also use the RECALL button to quickly clear many of the other on-screen displays.



HOW TO USE THE GENIUS REMOTE TO CONTROL YOUR TV

MENU, ENTER, CURSOR buttons

All the on-screen display features can be set or adjusted by using these buttons.

The "MENU" button will start or exit the on-screen display.

The "CURSOR" buttons will highlight functions or adjust different features. These buttons are also used for FAVORITE CHANNELS. (See page 42.)

The "ENTER" button will set features to your preference. "CHANNEL SELECTOR" buttons are used to set the time, for channel memory, etc..

CHANNEL SELECTOR buttons

Enter two or three numbers to select channels. Enter a "0" first for channels 1 to 9. Use the "100" button for channels 100 and higher.

Channel selection may also be performed by pressing channel up (▲) or down (▼).

NOTE: The TV may not receive some channels if you are not in the correct AIR/CABLE mode. See page 39.

AVX button

The AVX (Auxiliary Video) button will select between the antenna signal and the three sets of video input jacks each time the button is pressed. If the Picture-in-Picture (PinP) is on, the AVX will select between the three sets of video input jacks. (See page 27.)

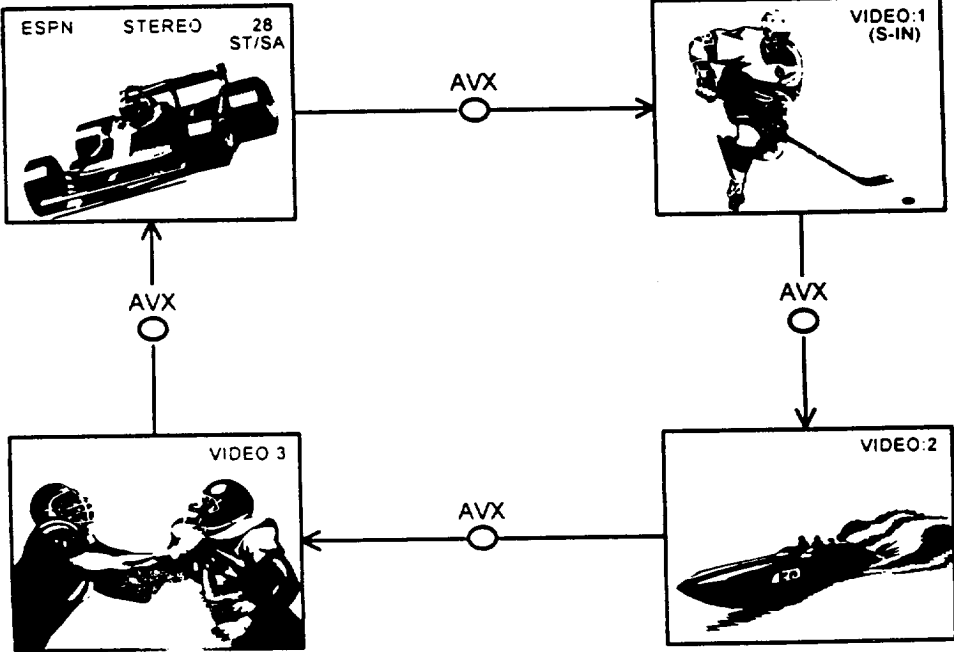



HOW TO USE THE GENIUS REMOTE TO CONTROL YOUR

⑥ VOLUME, MUTE buttons

Press the "VOLUME" up (▲) or down (▼) button until you obtain the desired sound level.

To turn the sound off instantly to answer the telephone, etc., press the "MUTE" button. Press the "MUTE" button, or press the "VOLUME" up (▲) button to restore the sound.

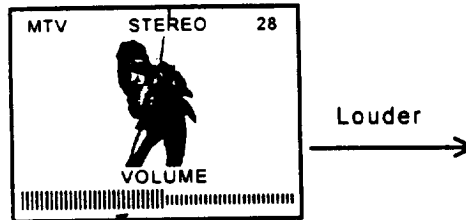

The word "MUTE" will remain displayed if the CLOSED CAPTION feature is turned off.

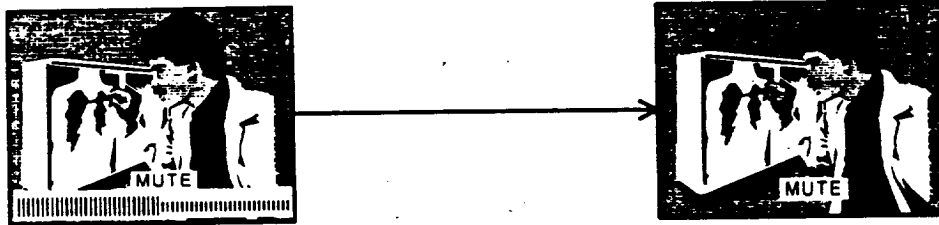

The word "MUTE" will not be displayed if the CLOSED CAPTION feature is on.

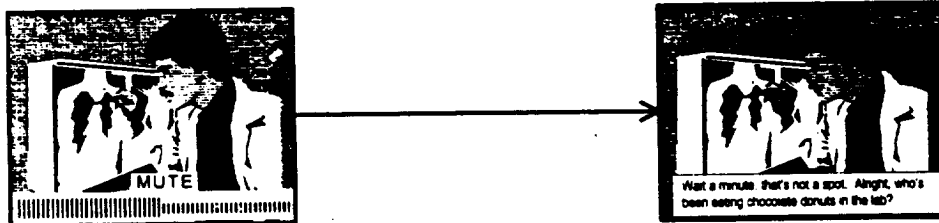

⑦ LAST CHANNEL (LST-CH) button

Use this button to select between the last two channels viewed. (Good for watching two sporting events)

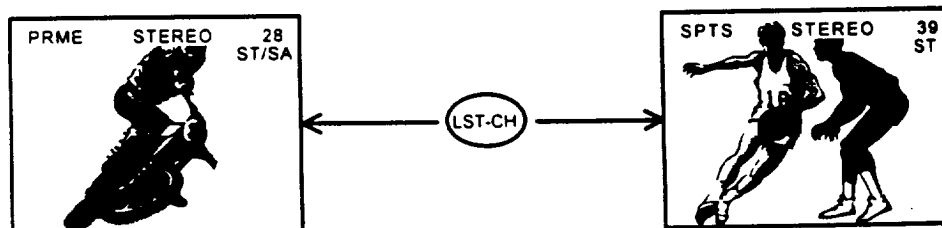

⑧ PICTURE-IN-PICTURE buttons

See separate section on page 27 for a description.

⑨ LIGHT BUTTON



PICTURE-IN-PICTURE (P-IN-P)

The Picture-in-Picture feature is convenient when you want to watch more than one program at the same time. You can watch a TV program while viewing a VCR program (TV or tape) on any of the video inputs, and vice versa with this feature.

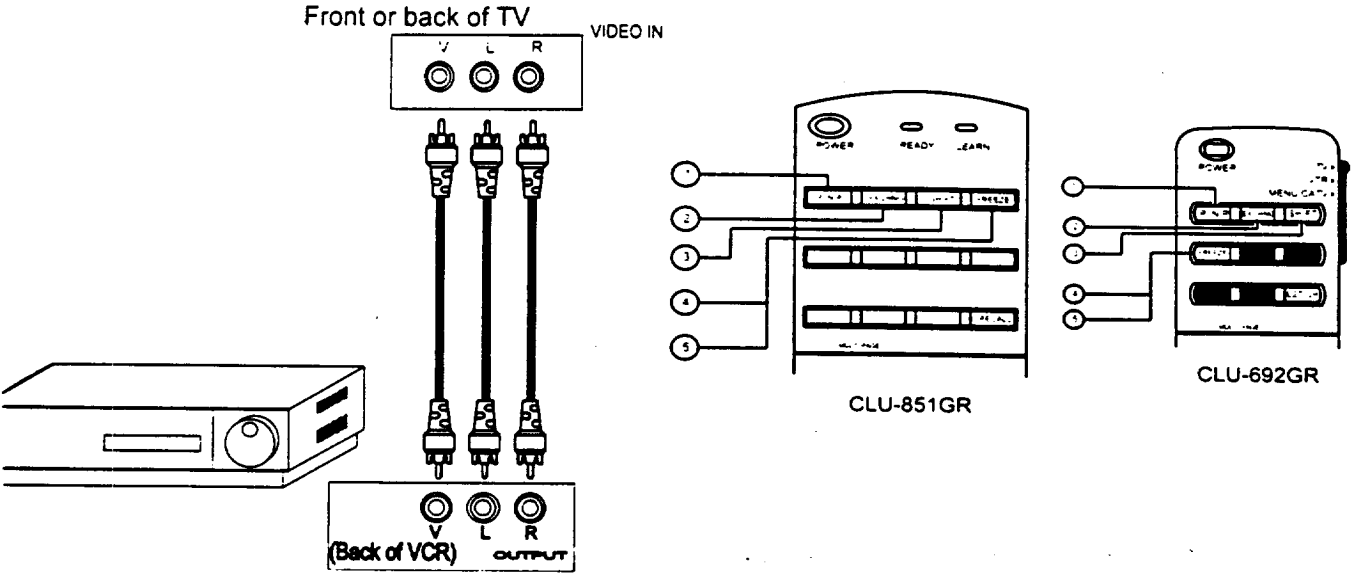

P-IN-P BUTTON

Press the "P IN P" button and a sub-picture appears in one corner of the screen. Press the button a second time to remove the sub-picture from the screen. The TV channel will always be either the main picture or the sub-picture.

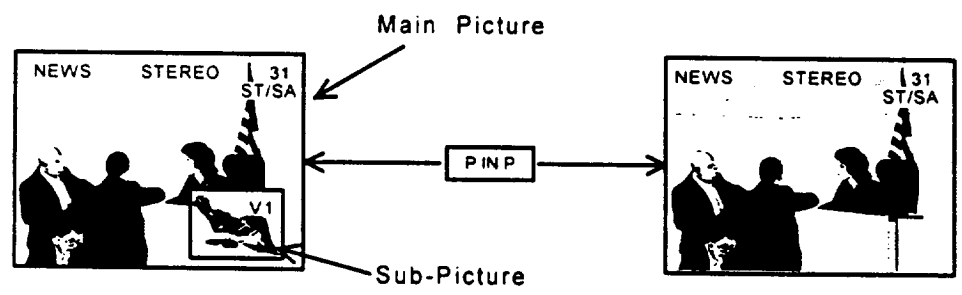

EXCHNG (EXCHANGE) BUTTON

If you wish to switch what is being shown on the main picture to the sub-picture, press the "EXCHNG" button.

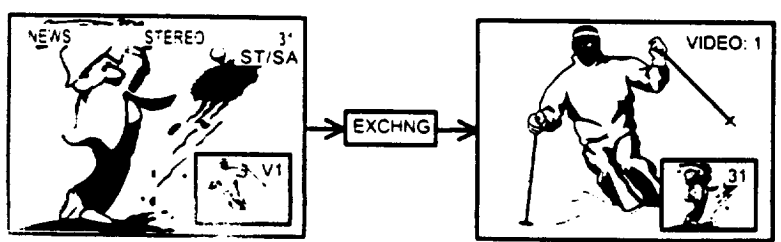



USING THE GENIUS REMOTE TO CONTROL CABLE BOX FUNCTIONS

Operating the pre-coded function for your cable box

This Genius Remote is designed to operate different types of cable boxes. You must first program the Genius Remote to match the remote system in your cable box. (Refer to Table 2 on page 31 or Table 4 on page 32.)

1. Set the MULTI-PAGE select switch to "CATV."
2. Set the USE/LEARN mode select switch to "USE." (For CLU-851GR only)
3. Turn ON your cable box.
4. Aim the Genius Remote control at the front of your cable box.
5. While holding down the SELECT button, press the button that matches our cable box as shown on page 31 or p 32. Continue to hold down both buttons. The channels of the cable box will begin changing when the correct button is pressed. When this occurs, the Genius Remote Control is programmed for your cable box. If the cable channels do not change after 5 seconds, try a different Genius Remote button.
6. Release both buttons when the cable box starts to change channels. The Genius Remote will now control your cable box.

NOTES:

1. If your cable box cannot be operated after performing the above procedures, this means that your cable box codes have not been precoded into the GENIUS REMOTE. Please store your cable box codes in memory by using the USER mode. (Refer to page 33.)
2. The GENIUS REMOTE CONTROL will remember the codes you have programmed in until the batteries are removed from the GENIUS REMOTE CONTROL. After replacing the batteries, repeat the entire programming procedure stated above.

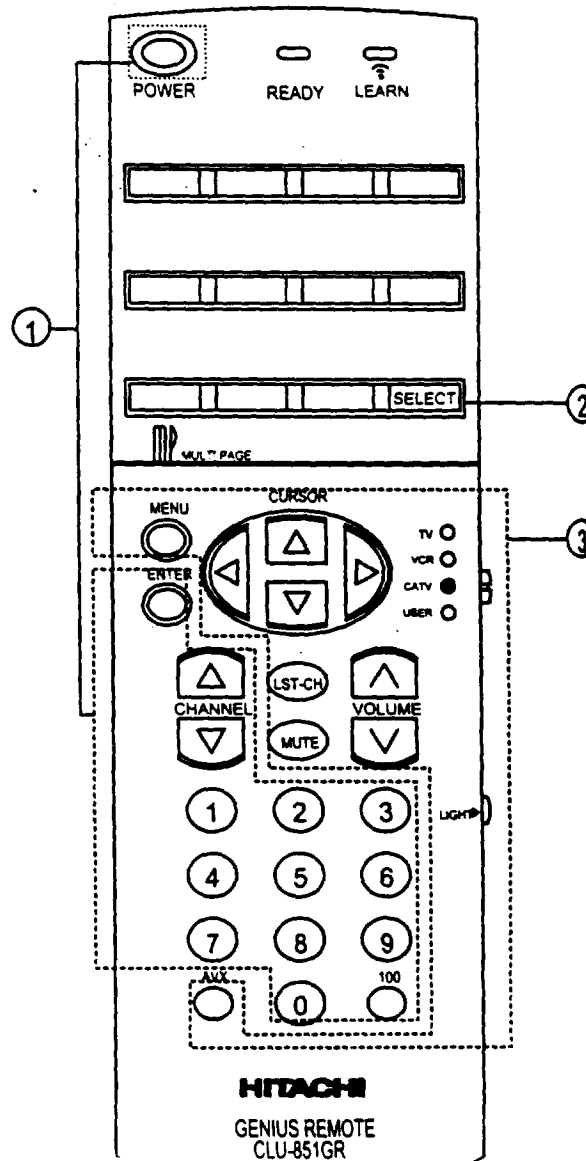

- ① **PRECODED FOR CABLE BOX**
These buttons always transmit the chosen precoded CATV codes.
- ② **SELECT BUTTON**
This is for setting up the cable box's Pre-code.
- ③ **EXCLUSIVE TV BUTTONS**
These buttons are for operating the TV.



AND CABLE BOX CODES

1. VCR Precoded remote controls for Hitachi GR111 Remote CLU-851GR

BRAND	Press SELECT and this button	VCR BRAND	Press SELECT and this button
Dynalines	VOLUME ▼	NEC	9/VOLUME ▼
	6	Panasonic	6
	0	Pentax	1
	VOLUME ▲	Philco	4/6
Pathes	2/6	Philips	4/6
	VOLUME ▼	Pioneer	1
Pa	2	ProScan	2
1	100/ENTER	Quasar	6
	VOLUME ▲	RCA	1/2
	2/6	Realistic	6/9/CHANNEL ▲ /VOLUME ▼
	0	Sanyo	9/VOLUME
	1	Scott	7/8
Replay	6	Sears	1/9
ry	1/6/9/VOLUME ▼	Sharp	CHANNEL ▲
	0/VOLUME ▼	Sony	5/MUTE/AVX
d	0/VOLUME ▼	Sylvania	4/6
ox	4/6	Tashiko	0
	9/VOLUME ▼	Technics	6
	0	Toshiba	1/8
x	6/VOLUME ▲	Vector Research	VOLUME ▼
	7	Video Concepts	VOLUME ▼
	1	Wards	CHANNEL ▲
hi	7	Yamaha	0/VOLUME ▼
ery Wards	CHANNEL ▲	Zenith	3/5

2. Cable Box Precoded remote controls for Hitachi GR111 Remote CLU-851GR

Brand	Press SELECT and this button	CATV Brand	Press SELECT and this button
Instrument	0/1/2/3	Pioneer	7
	4	Regal	4
	1/2/3/3	Scientific Atlantic	6
ox	9	Viewstar	9
ic	8	Zenith	5
	9		



VCR AND CABLE BOX CODES

TABLE 3. VCR Precoded remote controls for Hitachi GJ111 Remote CLU-692GR.

VCR BRAND	Press SELECT and this button	VCR BRAND	Press SELECT and this button
Canon	6	Pentax	1
Citizen	0	Philco	46
Curtis Mathes	26	Philips	46
Dimensia	2	Pioneer	1
GE	26	ProScan	2
Goldstar	0	Quasar	6
Hitachi	1	RCA	1/2
Instant Replay	6	Realistic	6/9/CHANNEL ▲
JC Penny	1/6/9	Sanyo	9
JVC	0	Scott	7/8
Kenwood	0	Sears	1/9
Magnavox	46	Sharp	CHANNEL ▲
Marantz	9	Sony	5/VOLUME ▲/VOLUME ▼
Marta	0	Sylvania	46
Memorex	6	Tashiko	0
MGA	7	Technics	6
Minolta	1	Toshiba	1/8
Mitsubishi	7	Wards	CHANNEL ▲
Montgomery Wards	CHANNEL ▲	Yamaha	9
NEC	9	Zenith	3/5
Panasonic	6		

TABLE 4. Cable Box Precoded remote controls for Hitachi GJ111 Remote CLU-692GR

CATV Brand	Press SELECT and this button	CATV Brand	Press SELECT and this button
General Instrument	0/1/2/3/8	Regal	4
Hamlin	4	Scientific Atlantic	6
Jerrold	0/1/2/3/8	Viewstar	9
Pioneer	7	Zenith	5



THE GENIUS REMOTE TO LEARN ADDITIONAL FUNCTIONS FOR CLU-851GR

This Remote is equipped with a learning function which allows it to learn additional infrared control codes. It will not only control the television, a VCR, and a cable converter, but also other electronic equipment which has an infrared remote transmitter, by learning the manufacturer's codes.

Additional infrared remote control codes can be stored in

Before starting the memory operation

Since the infrared signals sent from the remote transmitter may be reflected by a wall, door, etc., even if the transmitter is not pointed directly at the device, it may operate. When storing the remote control codes of another device, turn off the power of the device (VCR, Cable Converter, etc.)

If you do not do this, the device may work unexpectedly. The power could be turned on, an important tape could be erased, the volume could increase too much, etc..

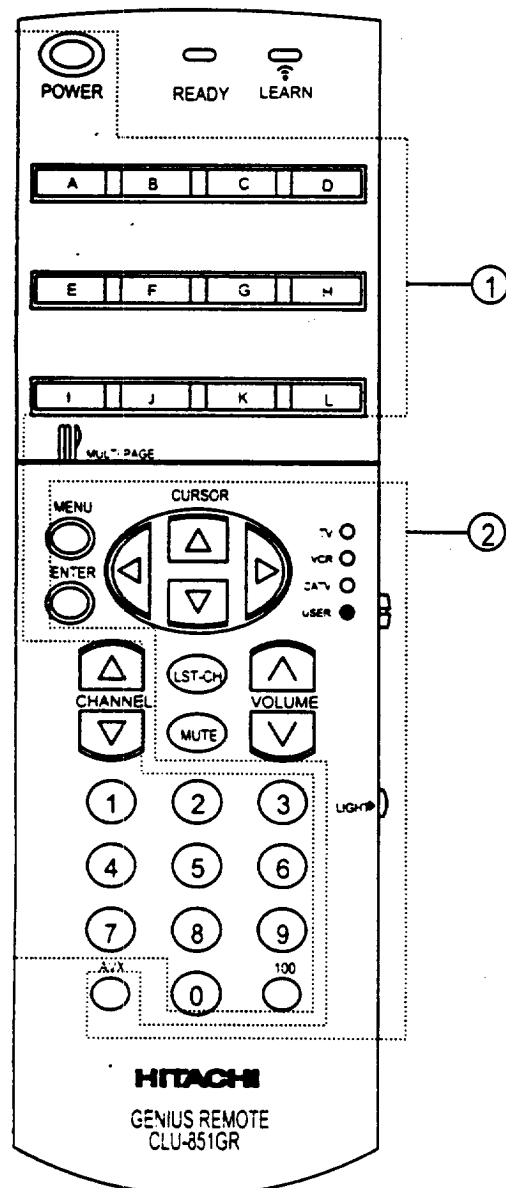

① LEARNABLE BUTTONS

These buttons can "learn" the codes of other remote control transmitters when the MULTI-PAGE select switch is set to the "USER" mode.

- MULTI-PAGE keys (A through L): No codes have been factory stored to these keys.
- Learning buttons other than MULTI-PAGE buttons: the codes for the TV have been stored in memory. However, the remote control codes of other equipment (cable converter, audio equipment, etc.) can be stored using the learning function as shown on page and page 34 and 35.

② EXCLUSIVE BUTTONS

These buttons are for operating the TV.

HITACHI
GENIUS REMOTE
CLU-851GR



USING THE GENIUS REMOTE TO LEARN ADDITIONAL FUNCTIONS FOR CLU-851GR

Storing Operation

- 1 Set the remote transmitter as shown below.
Put the remote transmitter which contains the codes to be stored and the GENIUS REMOTE transmitter to face each other. (Distance should be 2-4 inches.)

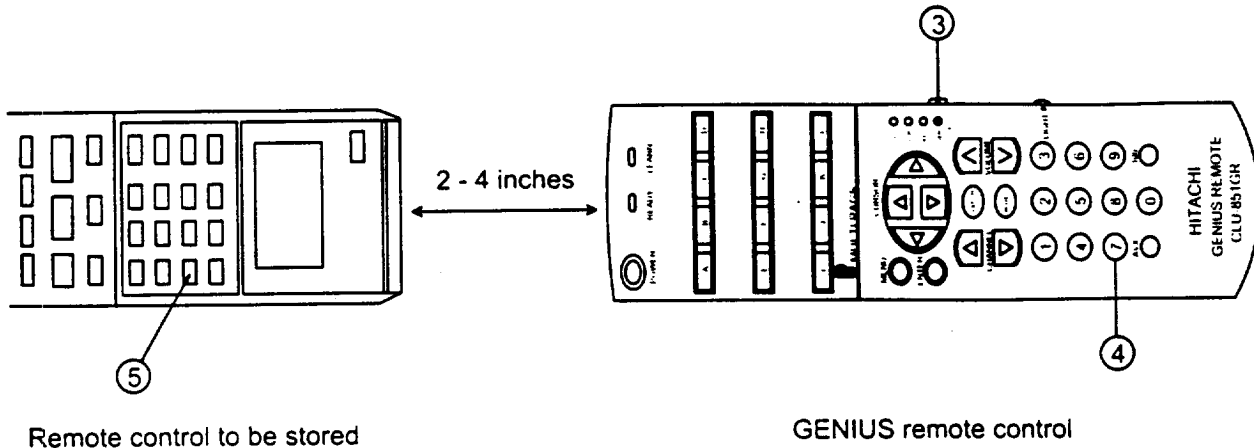

- 2 Set the LEARN/USE mode select switch located on the back of the Genius Remote to the LEARN position.
- 3 Set the MULTI-PAGE select switch to "USER" position.
- 4 Press one of the learnable buttons on the Genius Remote, ("7" in this example). This button will be used to store the new code. The READY indicator will flash at this time. (The light will remain lit for approximately 15 seconds. If no other function is performed at this time, the operation is canceled.)

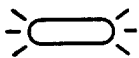

READY
(flashing)



LEARN
(off)

The Genius Remote is ready to receive an infrared code from another remote.

- 5 Press and hold the button down on the other transmitter which contains the code to be stored, while the READY light is flashing on the Genius Remote.
Release the button after both the READY and LEARN indicators light and then go off.



USING THE GENIUS REMOTE TO LEARN ADDITIONAL FUNCTIONS FOR CLU-851GR

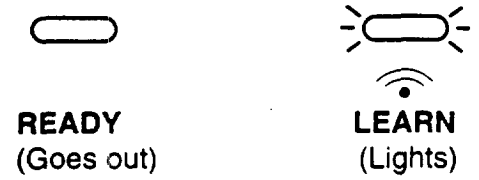

When storing has been performed correctly, the LEARN indicator lights for about 2 seconds.



If the storing was not done correctly, or the codes are too long to learn, or no more codes can be stored in memory due to memory overflow, the LEARN indicator and READY indicator will flash on and off.

Set the LEARN/USE mode select switch on the back of the Genius Remote to "USE" and check that the button to which the code is stored operates correctly. If it does not operate correctly, repeat from step 1.

Repeat steps 3 to 5 to store other keys.

Remove the stored codes from the USER mode.

Set the MULTI-PAGE select switch to the USER mode and LEARN/USE mode select switch to "LEARN." Then, press POWER and the MUTE buttons simultaneously for 3 seconds. The "READY" and "LEARN" LEDs will light together. MULTI-PAGE KEYS with codes are reset to their initial states.

Remember stored codes, it is convenient to paste the labels (user's label) provided on the buttons for the USER page. If correct labels are not provided, it is possible to write these letters on an empty label with a ballpoint pen.

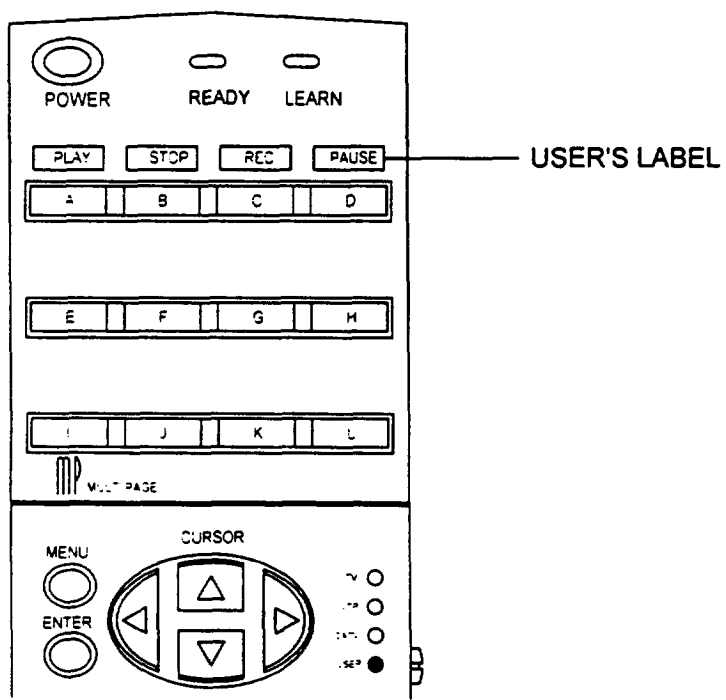



USING THE REMOTE TO LEARN ADDITIONAL FUNCTIONS

NOTE:

1. To operate your TV, be sure to point the Genius Remote at the remote sensor on the television. To operate other electronic equipment like a VCR, point the remote at the sensor on the device.
2. Refer to the instruction manual of the VCR for operation on the buttons exclusively for the VCR.
3. Be sure to keep the original remote transmitter even after storing its codes in the Genius Remote Control.
4. If the Genius Remote is left with its batteries removed, the learned codes in its memory are erased and will have to be reprogrammed into the memory.
5. The Genius Remote Control may not be able to learn certain special remote codes.

CAUTION ON BATTERIES:

1. The Genius Remote Control is working when the LEARN indicator lights up when a button is pressed.
2. When you press a button and the learn indicator will not light up or if the operation is extremely slow, this is an indication that the batteries should be replaced.
3. Even if the batteries seem dead, do not remove them until you have replacement batteries ready to put in. The codes stored in memory will be erased in a few minutes without power. When replacing batteries, prepare the new ones first.

GRAPHIC GUIDE

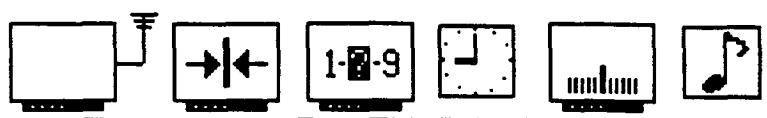

Press MENU on the remote control to display the different features on your HITACHI TV. The feature to be selected will be highlighted in a magenta (purple) color.

Press the CURSOR buttons to highlight a different feature.

Press ENTER on the remote control to select a feature.

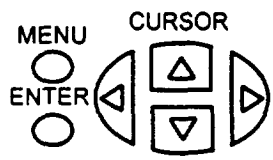

NOTE: Press the CURSOR buttons first to view FAVORITE CHANNELS (See Page 42.)

This part of the screen shows what selections are available.



This part of the screen shows which remote control buttons to use.

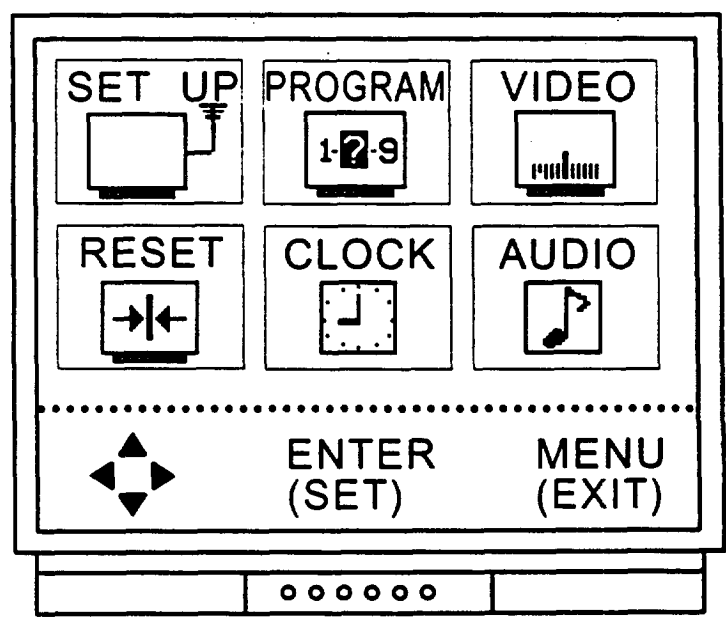
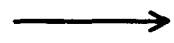

NOTE: For CLU-692GR, slide MULTI-PAGE select to MENU/CATV mode to work on MENU, ENTER, and cursor up, down, left and right. Slide to TV mode to Use Channel ▲, ▼ buttons or number buttons.



EASY GRAPHIC GUIDE

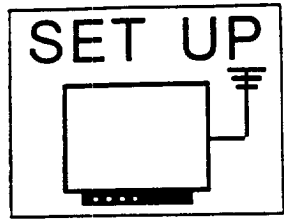

AIR/CABLE AIR

Select antenna or cable TV.

AUTO PROGRAM

First time setup for channel buttons.

CHANNEL MEMORY

Channel buttons, add or erase.

CLOSED CAPTION

Feature to display dialogue/text.

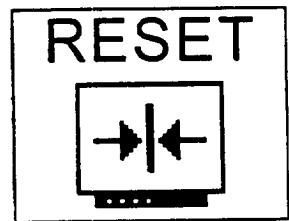

Return video and audio adjustments to factory settings.

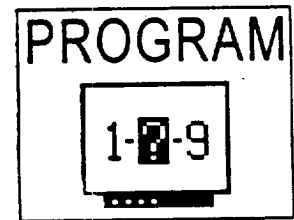

CHANNEL CAPTION

Label channels PAY1, ABC, etc.

CHILD LOCK

Block channel picture & sound.

PROGRAM LIST

Check channel name, scan, childlock.

VOLUME CORRECTION

Lower volume on selected channels.

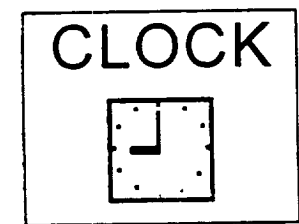

CLOCK SET

Set before using timer features.

ON/OFF TIMER

Turn TV on or off one time or daily.

AUTOMATIC MESSAGE-1

Set for one time or daily.

AUTOMATIC MESSAGE-2

Set for one time or daily.



Adjust Contrast, Color, Tint, Brightness, Sharpness and White Control.



PREFERENCE ADJUST

Adjust balance, bass, and treble.

PREFERENCE SETTING

Improve sound performance.

SURROUND

Special sound effects.



UP



Select SET UP when setting your TV up for the first time. Use the CURSOR UP/DOWN buttons on the remote to highlight the function desired.

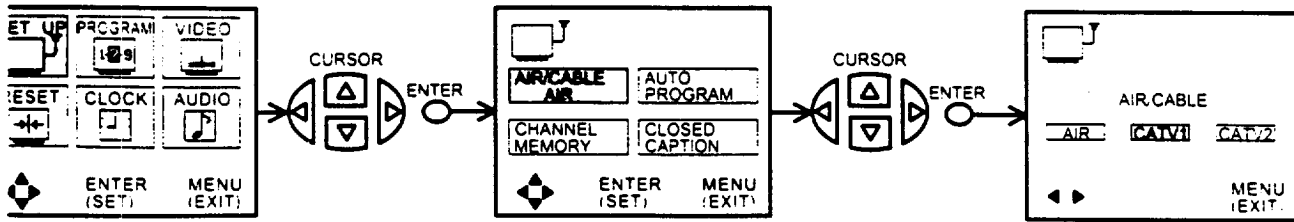

ABLE

Select AIR if you are using an indoor or outdoor antenna.
Select CATV if you have cable TV.

Press the CURSOR buttons to highlight the correct AIR/CABLE mode and press MENU to exit. Your choice will be shown on the display.

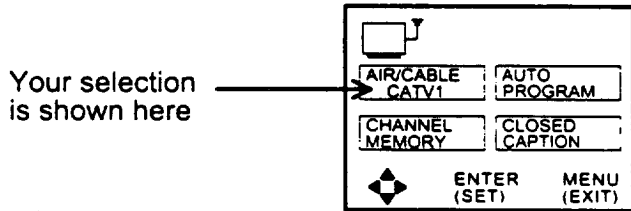

on channels for each mode are shown ght.

your cable or TV guide for channel ation standards.

i CATV channels are poor or not pos- he CATV1 mode, set AIR/CABLE to

RECEPTION BAND		
AIR	CATV 1 or CATV 2	
	CATV CHANNEL	Indicated on the screen
VHF 2 ~ 13ch UHF 14 ~ 69ch	VHF 2 ~ 13	2 ~ 13
	Mid band A ~ I	14 ~ 22
	A-5 ~ A-1	95 ~ 99
	Super band J ~ W	23 ~ 36
	Hyper band W + 1 ~ W + 28	37 ~ 64
	Ultra band W + 29 ~ W + 84	65 ~ 125



AUTO PROGRAM

This feature will automatically store active TV channels in CHANNEL MEMORY. This will allow you to skip over unused channels when using the CHANNEL UP (▲) or DOWN (▼) buttons.

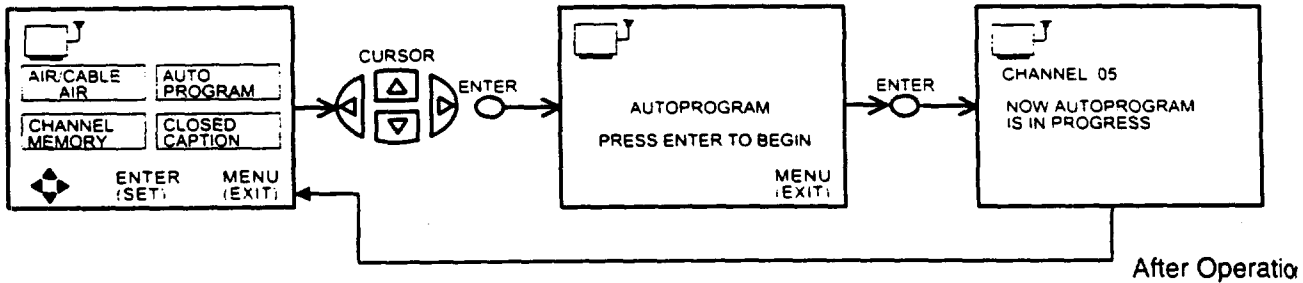

If the MENU button is pressed while the auto programming function is engaged, programming will stop.

Remember to select the correct AIR/CABLE mode before using auto programming.

See CHANNEL MEMORY to add or erase additional channels.

CHANNEL MEMORY

Use this function after AUTOPROGRAM to add or erase additional channels by the remote control CHANNEL ▲, ▼ buttons. Your Choice will be highlighted in magenta.

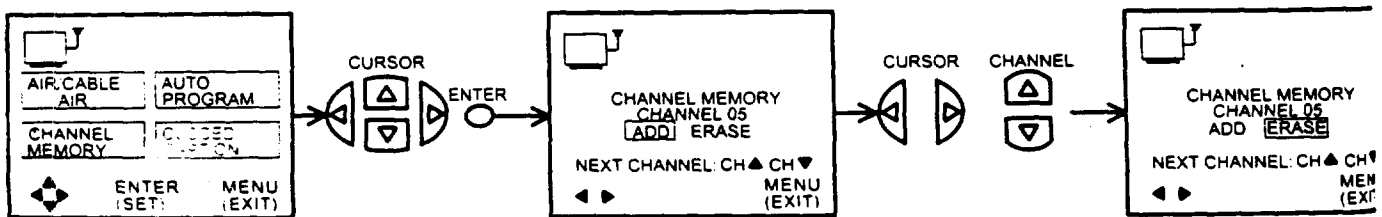

Add or erase additional channels while still in CHANNEL MEMORY using the CHANNEL ▲, ▼ buttons or number buttons and then add or erase using the CURSOR ◀, ▶ buttons.

UP



SECTION

Closed captions are the dialogue, narration, and/or sound effects of a television program or home video which are displayed on the TV screen. Your local TV program guide denotes these programs as **CC** or .

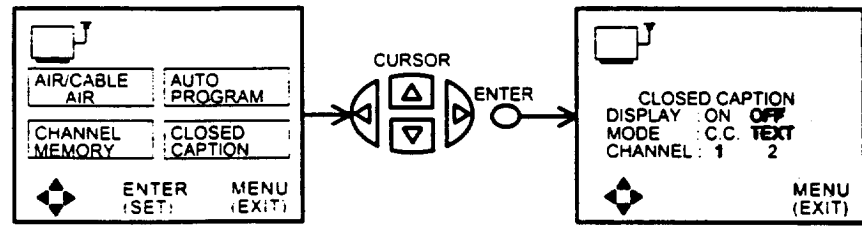

Selected function will be in magenta. Your choice for the function will be in blue.

KEY: ON/OFF is to turn the cc display "ON" or "OFF".

MODE: C.C. (Closed Caption) is for the program you are viewing.

MODE: TEXT is for additional information such as news reports or a TV program guide. This information covers the entire screen and viewing the TV program is not possible. TEXT may not be available with every **CC** program.

CHANNEL: 1 is used for the primary language (usually English).

CHANNEL: 2 is sometimes used for a second language (may vary by region).

Use CURSOR **▲** or **▼** to highlight the function to change, press ENTER to change the function, and press MENU

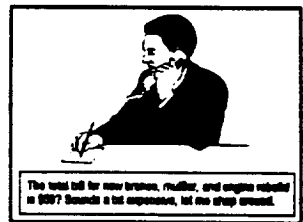

C.C. Selected

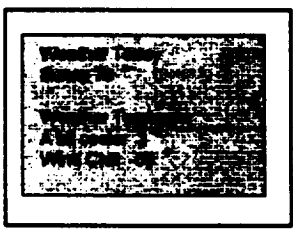

Text Selected



FAVORITE CHANNEL

The FAVORITE CHANNELS function will allow you to select up to 16 favorite channels by pressing the cursor buttons

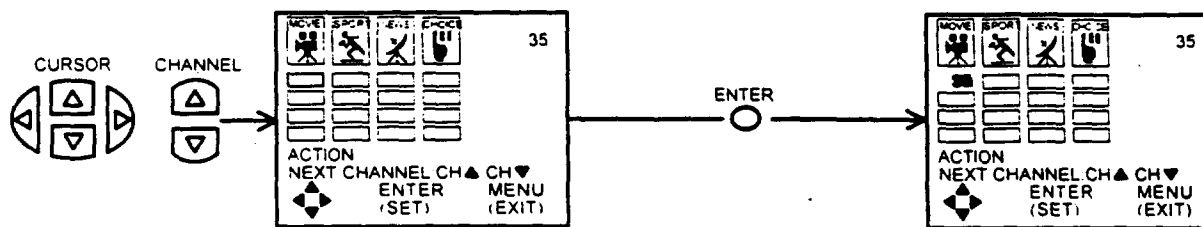

Use the CHANNEL ▲, ▼ or number buttons to select one of your favorite channels.
 Use the CURSOR buttons to select the location (in magenta color) for your favorite channel.
 Press ENTER to save the channel location.
 Enter channel 00 to erase a favorite channel.

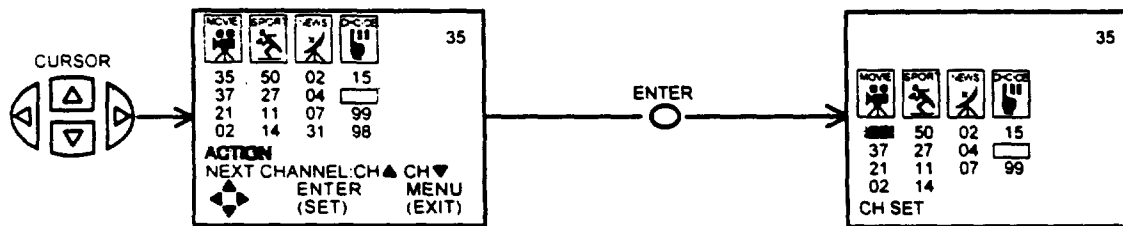

Highlight ACTION and press ENTER to use your favorite channels.
 Use the CURSOR buttons to highlight a favorite channel and the TV will automatically tune to the channel.
 Highlight CH SET and Press ENTER to add or erase more favorite channels.



SET

ESET





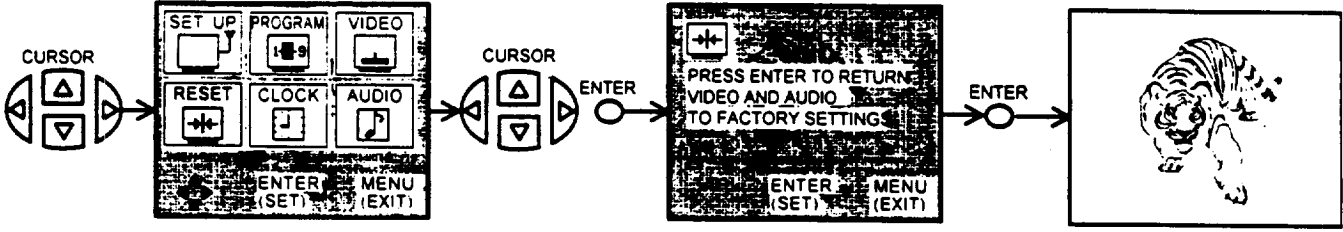

Use the reset to change your preferred video and audio adjustments to factory settings.





Factory Settings:

VIDEO

- Contrast: 
- Color: 
- Tint: 
- Brightness: 
- Sharpness: 
- White Control: ON

AUDIO

- Balance: 
- Bass: 
- Treble: 
- MTS Mode: STEREO
- Dynamic Bass: OFF
- Loudness: OFF
- Internal Speakers: ON
- Surround: OFF

NOTE: This RESET Selection will not change your preferred adjustments. To change back to your adjustments, see VIDEO on page 49 or Audio page 50.

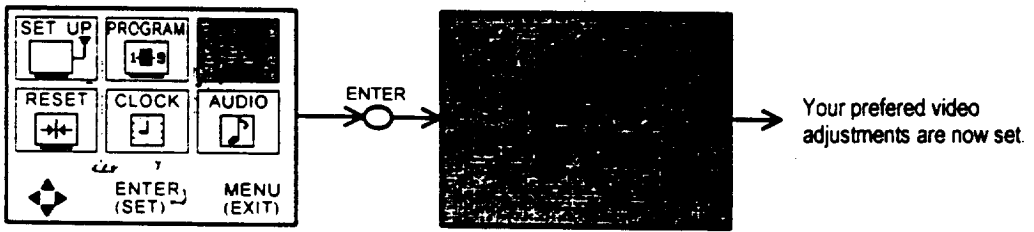

PROGRAM

This Selection contains advanced feature switch will make TV viewing easier and more enjoyable

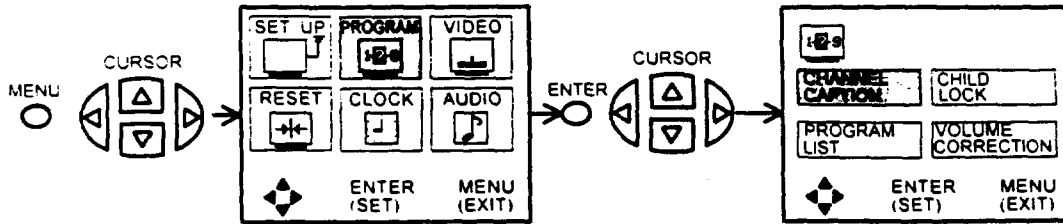

CHANNEL CAPTION

Use this feature to give channel names to up to 30 channels.

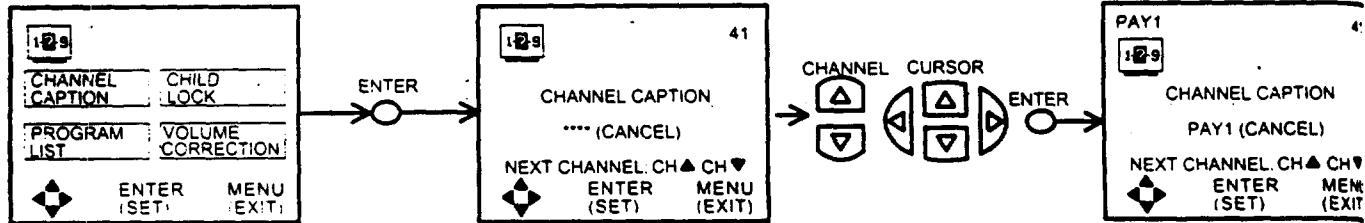

- Press the CURSOR ▲, ▼ to select letters.
- Press the CURSOR ◀, ▶ to change position.
- Press ENTER to set the CHANNEL CAPTION and it will appear in the top left corner of the screen.
- Press CHANNEL ▲, ▼ or the number buttons to select and label additional channels.
- Press MENU to exit.

The (*) represents a blank space.
Select CANCEL to erase a CHANNEL CAPTION.

PROGRAM LIST

This function allows you to view which channels are labeled in CHANNEL CAPTION (NAME), which have been added to CHANNEL MEMORY (SCAN), and which are protected by CHILD LOCK (LOCK).

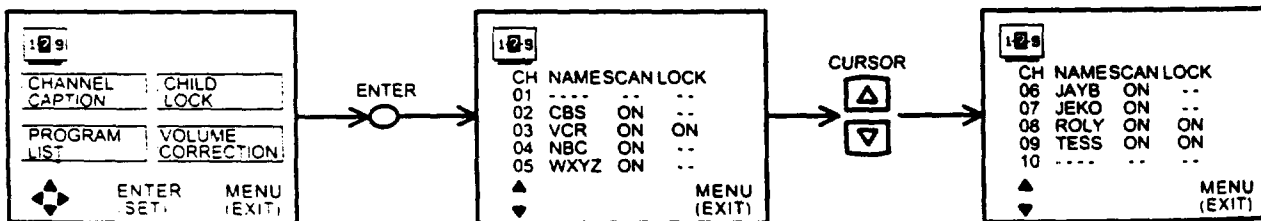

OGRAM



CHILD LOCK

This function will block out the picture and sound of the selected channel.

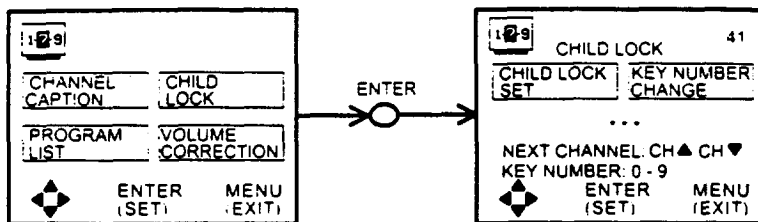

The code to set or cancel CHILD LOCK is a three digit key number. The factory preset key number is 000.

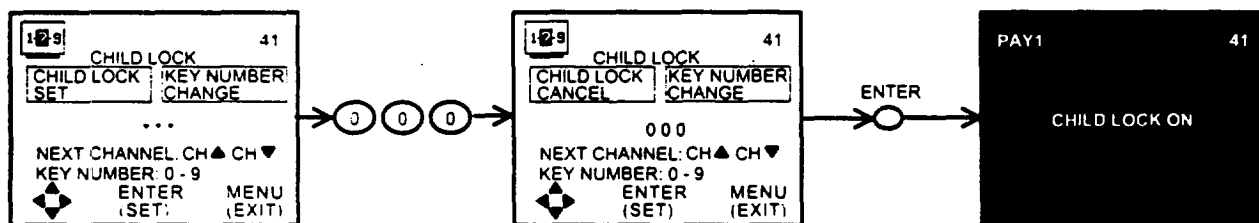

The picture and sound will now be blocked out for this channel. Repeat the same steps to cancel the CHILD LOCK.

To change the key number, select key number change. Enter the old number (factory preset 000 for first time use), then a new three digit key number you prefer.

To forget your key number, use the factory code 777 to erase your key number. This will reset the key number back to the factory preset 000.

**VOLUME
CORRECTION**

Use this function to reduce the volume level of up to four TV channels that sound loud compared to other TV channels.

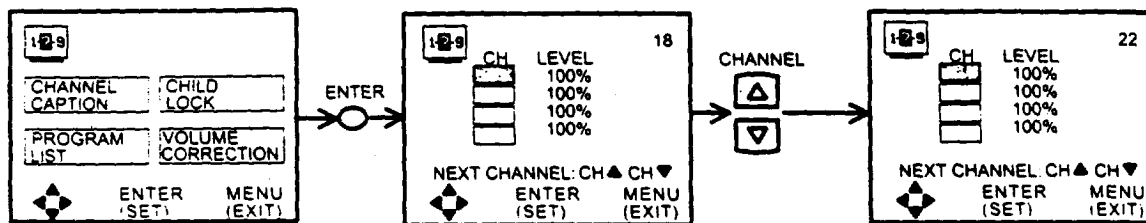

Press the cursor \blacktriangle , \blacktriangledown to select one of the four volume corrections.
Use the Channel \blacktriangle , \blacktriangledown or number buttons to select a channel.

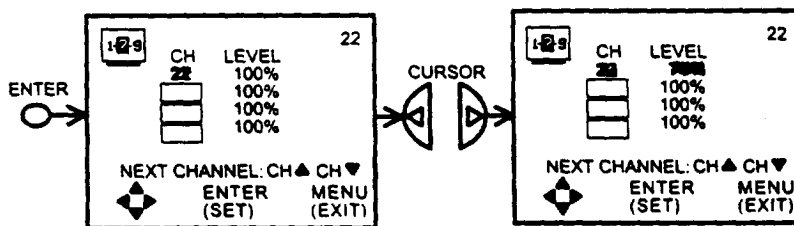

Press ENTER to set the channel.
Press the CURSOR \blacktriangleleft , \blacktriangleright to adjust volume level.
Press MENU to exit.

NOTE: 1. VOLUME CORRECTION adjustment is for the channel displayed in the top right corner of the screen. To adjust a different channel, you must select the channel with the channel or number buttons and press ENTER.

2. If the channel has been corrected before, use the cursor \blacktriangle , \blacktriangledown to highlight that channel then use the cursor \blacktriangleleft , \blacktriangleright to change the level.

From the volume correction, select channel 00 and press ENTER.

CLOCK



LOCK



Use this feature for all time related functions.

CLOCK

The time must be set before you can use the on/off timer or automatic message.

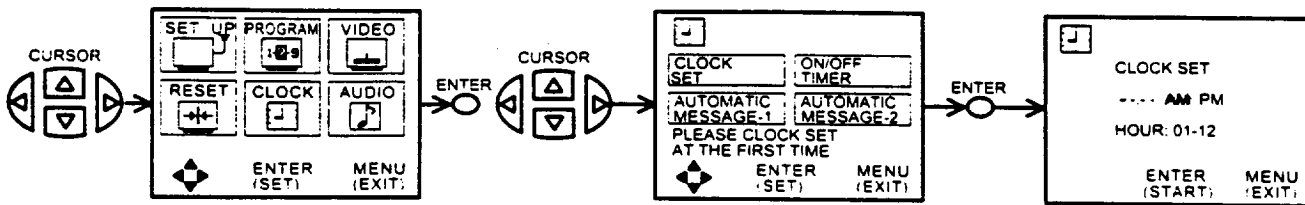

Use the NUMBER buttons and CURSOR ◀, ▶ to set the time. AM or PM selected will be highlighted in blue.

OFF

This function will automatically turn the TV on or off, one time only or everyday.

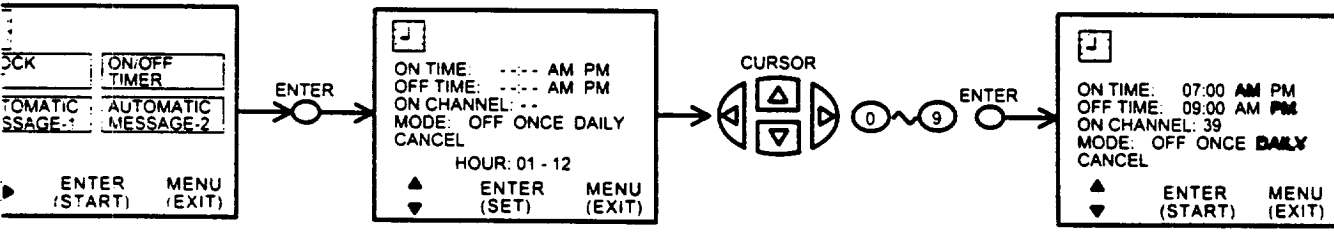

Each step to change will be in magenta.
 Press the number buttons to select the time the TV will turn "ON" or "OFF". (AM: 1, PM: 2)
 Press the CURSOR ◀, ▶ buttons for MODE: ONCE (one time only) or MODE: DAILY (TV will turn on/off at the same every day).
 Press CHANNEL ▲, ▼ or the NUMBER buttons to set the channel the TV will tune to when it automatically turns on.
 The choice for AM/PM and MODE will appear in blue.
 Press ENTER to start.
 Press CANCEL and press ENTER to erase time.

NOTE: You can set either "ON" time only, "OFF" time only, or both. The mode will be the same for both.

CAUTION: Do not use your TV as a clock when away from home by using both the ON and OFF



AUTOMATIC MESSAGE

Use this function to set one or two personal messages every day or one time only.

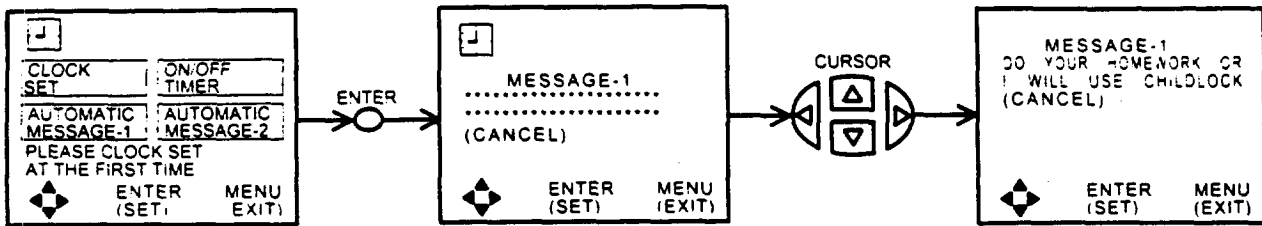

Use the CURSOR ▲, ▼ to select a letter or other character.

Use the CURSOR ◀, ▶ to change position.

Press ENTER when message is finished.

The asterisk (*) represents a blank space.

Move the CURSOR ◀, ▶ until (CANCEL) is magenta and press ENTER to erase message.

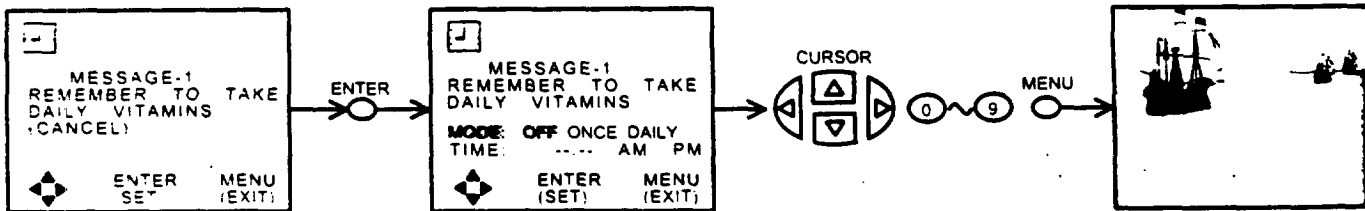

Use cursor ▲, ▼ to choose MODE or TIME.

Use cursor ◀, ▶ to set MODE when it is magenta. Your choice will be in blue.

Use the NUMBER buttons to set the time.

Press ENTER to start and MENU to exit.

NOTE: Automatic Message-2 is the same cursor operation.



Select VIDEO to adjust picture settings, and to improve picture quality.

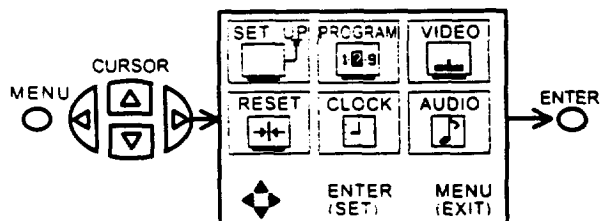

Use this feature to adjust contrast, color, tint, brightness, sharpness, and white control.

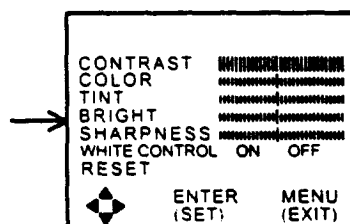

Use the CURSOR buttons to select and make adjustments. The function to be adjusted will be in magenta.

CONTRAST - Use this function to change the contrast between black and white levels in the picture.

COLOR - Use this function to adjust the level of color in the picture.

TINT - Use this function to adjust flesh tones so that they appear natural.

BRIGHT - Use this function to adjust overall picture brightness.

SHARPNESS - Use this function to adjust the amount of fine detail in the picture.

WHITE CONTROL - Use this function to adjust the white balance (hue) of the picture to your own color preference. When shipped from the factory, this is set to "ON". If you prefer a reddish screen, set to "OFF".



Select AUDIO to adjust the TV to your preference, to improve the sound quality, and to select special sound effects.

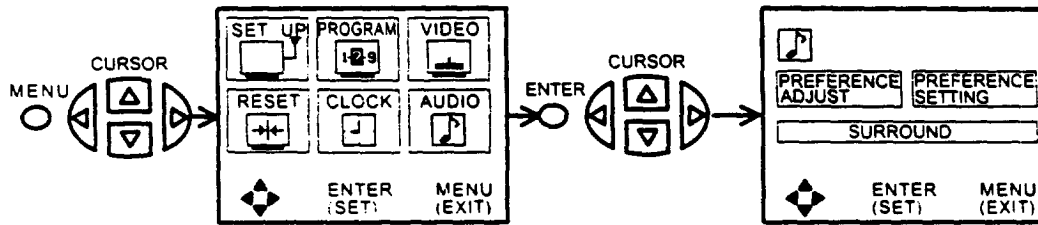

PREFERENCE ADJUSTMENT

Use this to set balance, bass, and treble.

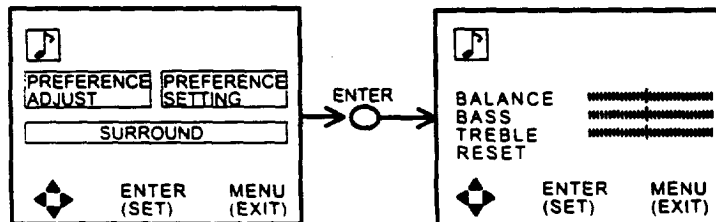

Press the CURSOR buttons to select and make adjustments. The function to be adjusted will be in magenta.

BALANCE - This function will control the left and right balance of the TV internal speakers, the AUDIO TO HI-FI output and the surround speakers.

BASS - This function controls the low frequency audio to all speakers.

TREBLE - This function controls the high frequency audio to all speakers.

RESET - When RESET is selected, press ENTER to return audio adjustments to factory preset conditions.



PREFERENCE SETTING

Use Preference SETTING to improve the sound performance of your TV depending on listening conditions.

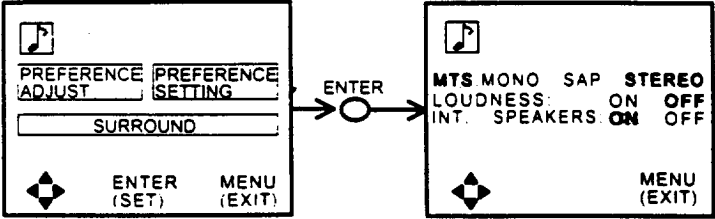

the CURSOR ▲, ▼ to select a function. The function will be in magenta.
 the CURSOR ◀, ▶ to change function. Your choice will be in blue.

MODE (Multi-Channel Television Sound) will allow you to select STEREO (a stereo broadcast), SAP (second audio) which may be a secondary language, weather report, etc. or MONO (monaural sound) used when receiving a stereo broadcast.

sources received will be displayed below the channel number. The source you select will be displayed to the left of the channel number. See example below for each selection when both stereo and second audio are received (monaural ways received).

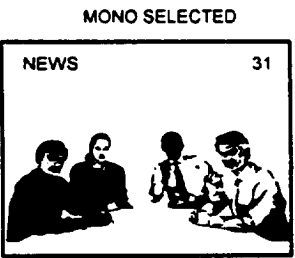
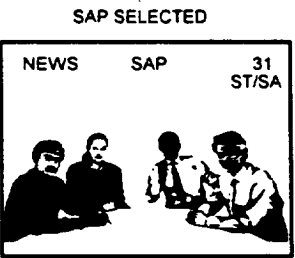

LOUDNESS
 function will improve the quality of both low and high frequency sounds when listening at low volume levels.



AUDIO

SURROUND

The following surround sound settings will reproduce the "live" sound you would hear in concert halls, movie theaters, etc. when you set up your speaker system as shown in the section on rear panel connections on page 17 and 18. The surround sound system is most effective with movies played on a stereo VCR.

Surround sound allows the viewer to enjoy sound which provides a feeling of "presence" from stereo broadcasts and VCR tapes* recorded with stereo sound. Also a mono input, simulating a stereo more loudly reproduction.

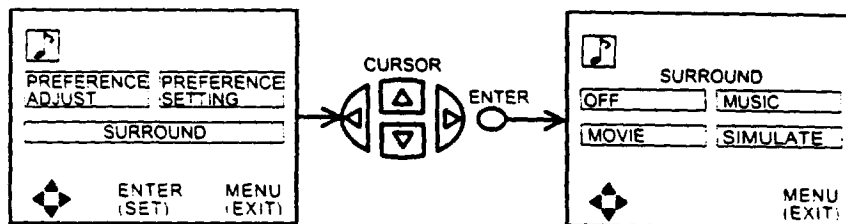

Use the CURSOR buttons to select surround setting.

SURROUND OFF

Use this for normal stereo/mono broadcasts.

NOTE: If the sound is noisy when a stereo broadcast is received and the TV is set to the Surround mode, decrease the "Treble" control or turn the "Surround Off"

MOVIE SURROUND

Listener is surrounded by many sound sources such as a movie theater reproduction.

NOTE: Some TV systems do not transmit optimum audio channel separation which can reduce the effectiveness of the MOVIE SURROUND function.

MUSIC SURROUND

Resonant sound - Listener has the feeling of being in a concert hall.

At stereo input, sound of music is changed more loudly.

SIMULATE SURROUND

At mono input, sound is changed more loudly simulating a stereo like Surround.

* Your play VCR must be a HI-FI or stereo unit. See page 18. For stereo VCR connection.

CARE OF YOUR HITACHI COLOR TV AND YOUR REMOTE CONTROL



DO

Dust the screen and cabinet with a soft cloth.

Clean the screen with a soft cloth moistened in warm water. Dry with a soft cloth. (A mild soap may be used if the screen is extremely dirty.)

Place your TV and remote control away from extreme heat, humidity and extremely dusty places.

Remove the plug from the wall outlet if your television set will not be used for a long period of time, for instance, when you go on vacation.

DO NOT

Do not clean your screen or cabinet with strong cleaners, polishes or chemically treated cloth.

Do not place rubber or vinyl products or cellophane tape on your set.

Do not touch the screen too often.





Do not subject the Remote Control to shocks such as dropping it on the floor, etc. Physical damage to the precision parts may result.

Avoid placing the Remote Control in a high humidity place or getting it wet. Don't leave it on or near a heater. Excessive heat or moisture may cause the unit to cease operation.

When the batteries run down, remote control operation will become erratic or possibly stop altogether. Replace the old batteries with fresh "AA" size batteries.

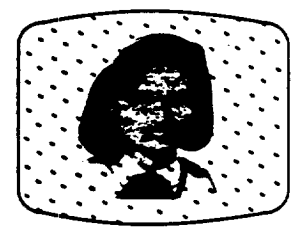

RECEPTION PROBLEM

	<ul style="list-style-type: none">• IGNITION NOISE: Black spots or horizontal streaks may appear, picture may flutter or drift. Usually caused by interference from automobile ignition systems, neon lamps, electrical drills and other electrical appliances.
	<ul style="list-style-type: none">• GHOSTS: Ghosts are caused by the television signal following two paths. One is the direct path and the other is reflected from tall buildings, hills or some other objects. Changing the direction or position of the antenna may improve reception. Ghosting may also be caused by defects in the antenna system such as unshielded leads or connecting several sets to the same antenna without using multiple antenna couplers.
	<ul style="list-style-type: none">• SNOW: If your receiver is located in the fringe area of a television station where the signal is weak, your picture may be marred by the appearance of small dots. When the signal is extremely weak, it may be necessary to install a special antenna to improve the picture.
	<ul style="list-style-type: none">• RADIO FREQUENCY INTERFERENCE: The interference produces moving ripples or diagonal streaks, and in some cases, causes loss of contrast in the picture.

CHECK HERE BEFORE CALLING FOR SERVICE

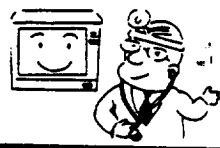

SYMPTOMS	CHECK THESE ITEMS AND TRY THESE ADJUSTMENTS										
	Be sure external connection is correct	Be sure power cord is plugged in	Be sure TV is switched "ON"	Try another channel (station trouble?)	Check antenna connections (back of TV)	Check for local interference	Adjust Picture control	Adjust Black level control	Adjust Color control	Adjust Tint control	Adjust Volume control
No picture, no sound	•	•	•	•	•	•	•				
Sound OK, picture poor	•			•	•	•	•	•	•		
Picture OK, sound poor	•			•	•	•	•				•
Picture blurred	•			•	•		•				
Lines or streaks in picture				•	•	•	•	•			
Poor reception on some channels				•	•	•	•	•			
No color	•			•	•	•	•			•	
Poor color	•			•	•	•	•			•	•



SPECIFICATION

Features:

- Superfine Picture Quality
700 Line Horizontal Resolution
- Dark Tint CPT
- Genius Remote
(Controls many VCR and cable box brands)
- P-in-P Functions
- Icons: Easy Graphic Guide
- Full set of Input Jacks, including S-Video
- Closed Caption Decoder
- Comb Filter, Wide-Band Video-Amp and White Control
- MTS (Multi-Channel Television Sound) Stereo Broadcast Reception
- 3D Surround Sound (3 Way)
- SES - Spatially Equalized Sound (A-Horn)

Screen Size: 31V (31 inches measures diagonally)

Inputs:

- Power Input. AC 120V, 60 Hz
- Power consumption (operating) 135W
- Power consumption (maximum) 180W
- Antenna input impedance. 75 Ohm
- Channel coverage. 181 ch.
VHF-Band. 2-13
UHF Band. 14-69
CATV Mid Band A-5-A-1
A-I
Super Band. J-W
Hyper Band. W+1-W+28
Ultra Band. W+29-W+84
- Video. 1.0Vp-p, 75 Ohm
- S-Video
Luminance (Y). 1.0Vp-p, 75 Ohm
Chrominance (C). 0.286Vp-p, 75 Ohm
- Audio input impedance. 47k Ohm
- Average input level 470mVrms
- Maximum input level. 940mVrms

Dimensions:

	31UX5B	31CX4B
• Height (in.) . . .	26 ¹¹ / ₁₆	26 ¹¹ / ₁₆
• Width (in.) . . .	31 ¹ / ₁₆	31 ¹ / ₁₆
• Depth (in.) . . .	22 ³³ / ₆₄	22 ³³ / ₆₄
• Weight (lbs.) . . .	132	132

NOTE: Due to improvements, specifications in this operating guide are subject to change without notice.



HITACHI

*Service
hotline*

To locate an authorized
HITACHI service facility
in the continental U.S.A.

DIAL TOLL FREE

7 days a week, 24 hours a day

800 HITACHI

1-800-448-2244

Hitachi Home Electronics (America), Inc.

Hitachi has made every effort to assure you hours of trouble free operation from your unit. However, should you require service, a network of Hitachi Authorized Service Facilities has been established in all 50 states and Puerto Rico. Each facility will provide you with convenient and expedient assistance. Our service "Hotline" operator will direct you to the Hitachi Authorized Service Facility nearest you. Just present proof of purchase and/or delivery receipts to the Hitachi Authorized Service Facility, and service will be rendered in accordance with the terms of the limited warranty as stated on your warranty card or operating guide.

Should you have any questions regarding in-warranty service, operation or technical assistance, please contact:

Hitachi Home Electronics (America), Inc.

3690 Steve Reynolds Blvd.
Norcross, GA 30093
Tel: 404-279-5600

Hitachi Sales Corporation of Hawaii

3219 Koaapaka St. Honolulu, HI 96819
Tel: 808-536-3621

EX

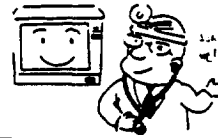

Series	6	P IN P (Picture in Picture)	5, 26, 27, 28
na	8, 9, 13, 15, 39	Phono Connector	9
Preference Adjust	50	Picture Cautions	5
Preference Setting	51	Power	
Surround	19, 52	Light Button	20, 22, 26
to Hi-Fi	15, 16, 19	Button	11
System Set-Up	19	Program	
.	10, 11	Channel Caption	24
ty Replacement	7, 53	Child Lock	45
Box Codes	31, 32	Program List	44
ts. Hook up	9	Volume Correction	46
for your TV and Remote	53	Ready Indicator	30, 33, 34, 35
/.	4, 8, 30, 31, 32	RECALL	24
nel	11, 25	Reception	
ing Stored Codes	35	Band	39
Automatic Message	48	Problems	54
Clock set	47	Remote Control	
On/Off timer	24, 47	Cable Box Functions	30
ections,		Learning Functions	33
Antenna	4, 9	Picture in Picture	27
Front Panel	12	Sensor	11
Rear Panel	15, 16, 17, 18, 19	TV Functions	24, 25, 26
SOR	25, 42	VCR Functions	29
Graphic Guide	37, 38	RESET	37, 38, 43, 49, 50
ER	25, 42	S-Video	9, 13, 14, 15
ING	27	Safety Tips	2, 3, 4
nnector	9	SA, SAP	24, 51
ORITE CHANNELS	42	SELECT	29, 30
EZE	28	Select Switch	20, 29, 30
t Panel Controls	10, 11, 12	Service Hotline	58
rtant Safeguards	2, 3, 4	Service	4, 58
s		SET UP	
Rear Panel	15, 16, 17, 18	AIR/CABLE	39
Front Panel	12, 13, 14	Auto Program	40
an Indicator	20, 33, 34, 35	Channel Memory	40
RN/USE Switch	20, 33, 34, 35	Closed Caption	41
IT Button	20, 22, 26	SHIFT	28
tion, Viewing	3, 8, 53	Simulate Surround	19, 52
CH	26	Specifications	56
IU	25	Storing Codes	34
e Surround	19, 52	Twin Lead Connector	9
o Sound	52	UHF/VHF	9, 15
-page	20, 21, 22	VCR Codes	31, 32
c Surround	19, 52	Video	49
E	26, 41	Volume	11, 26

HITACHI