

SOLID STATE COLOR TV

35TX69K

OPERATING GUIDE

Your new HITACHI COLOR TV incorporates a host of features designed to give you excellent performance if you follow the instructions in this manual. We recommend that you read the following instructions and "IMPORTANT SAFEGUARDS" notice before turning on your TV set for the first time.







This television receiver will display television closed captioning ( or ) in accordance with paragraph 15.119 of the FCC rules.

TABLE OF CONTENTS

IMPORTANT SAFEGUARDS	2	PICTURE-IN-PICTURE (P-IN-P) FUNCTIONS	27
HOOK UP CABLES AND CONNECTORS	5	PICTURE FUNCTIONS	29
BEFORE OPERATING YOUR TV SET	5	AUDIO SYSTEM SET-UP	31
ANTENNA CONNECTIONS	6	SOUND FUNCTIONS	32
LOCATION OF CONTROLS	7	USING THE GENIUS REMOTE TO:	
FRONT PANEL CONTROLS	8	CONTROL VCR FUNCTIONS	34
FRONT PANEL JACKS AND CONNECTIONS	10	CONTROL CABLE BOX FUNCTIONS	35
REAR PANEL JACKS	11	ACCESSORIES PART NUMBERS	37
REAR PANEL CONNECTIONS	12	REMOTE CONTROL BATTERY INSTALLATION	
CONNECTING TO THE REAR SPEAKER TERMINALS	13	AND REPLACEMENT	37
THE GENIUS REMOTE CONTROL (CLU-692GR)	14	TROUBLESHOOTING	39
HOW TO USE THE GENIUS REMOTE TO CONTROL		SPECIFICATIONS	40
YOUR TV	15	SERVICE HOTLINE	41
SET-UP FUNCTIONS	18	NOTES	42

IMPORTANT SAFEGUARDS

Follow all warnings and instructions marked on this television receiver.

	CAUTION RISK OF ELECTRIC SHOCK DO NOT OPEN			The lightning flash with arrowhead symbol, within an equilateral triangle, is intended to alert the user to the presence of uninsulated "dangerous voltage" within the TV set enclosure that may be of sufficient magnitude to constitute a risk of electric shock to persons.
CAUTION: TO REDUCE THE RISK OF ELECTRIC SHOCK, DO NOT REMOVE COVER (OR BACK). NO USER-SERVICEABLE PARTS INSIDE. REFER SERVICING TO QUALIFIED SERVICE PERSONNEL.				The exclamation point within an equilateral triangle is intended to alert the user to the presence of important operating and maintenance (servicing) instructions in the literature accompanying the TV set.

WARNING: TO PREVENT FIRE OR SHOCK HAZARD, DO NOT EXPOSE THIS TELEVISION TO RAIN OR MOISTURE.



POWER SOURCE

This Hitachi color TV is designed to operate on 120 volts 60 Hz, AC household current. Insert the power cord plug into a 120 volt 60 Hz outlet.

NEVER CONNECT THE TV TO 50 Hz, DIRECT CURRENT, OR ANYTHING OTHER THAN THE SPECIFIED VOLTAGE.

**CAUTION:
POWER SUPPLY CORD**

• POLARIZED PLUG

TO PREVENT ELECTRIC SHOCK DO NOT USE THIS (POLARIZED) PLUG WITH AN EXTENSION CORD, RECEPTACLE OR OTHER OUTLET UNLESS THE BLADES CAN BE FULLY INSERTED TO PREVENT BLADE EXPOSURE.

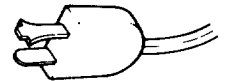

HITACHI

SAFETY POINTS YOU SHOULD KNOW ABOUT YOUR HITACHI TELEVISION RECEIVER.

Our reputation has been built on the quality performance and ease of service of HITACHI television receivers.

Safety is also foremost in our minds in the design of these units. To help you operate these products properly, this folder illustrates safety tips which will be of benefit to you. Please read it carefully and apply the knowledge you obtain from it to the proper operation of your HITACHI television receiver.

Please fill out your warranty registration card at once and mail it to HITACHI. This will enable HITACHI to notify you promptly in the improbable event that a safety problem should be discovered in your model of product.

IMPORTANT SAFEGUARDS

CAUTION:

- * Read all of these instructions.
- * Save these instructions for later use.
- * Follow all warnings and instructions marked on the television receiver.

FOR YOUR PERSONAL SAFETY

- 1 This television set is equipped with a polarized alternating-current line plug (a plug having one blade wider than the other). This plug will fit into the power outlet only one way. This is a safety feature. If you are unable to insert the plug fully into the outlet, try reversing the plug. If the plug should still fail to fit, contact your electrician to replace your obsolete outlet. Do not defeat the safety purpose of the polarized plug.



- 2 When the power cord or plug is damaged or frayed, unplug this television set from the wall outlet and refer servicing to qualified service personnel.



- 3 Do not overload wall outlets and extension cords as this can result in fire or electric shock.

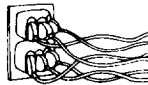

- 4 Do not allow anything to rest on or roll over the power cord, and do not place the TV where the power cord is subject to traffic or abuse. This may result in a shock or fire hazard.



- 5 Do not attempt to service this television set yourself as opening or removing covers may expose you to dangerous voltage or other hazards. Refer all servicing to qualified service personnel.

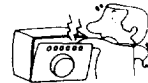

- 6 Never push objects of any kind into this television set through cabinet slots as they may touch dangerous voltage points or short out parts that could result in a fire or electric shock. Never spill liquid of any kind on the television set.



- 7 If the television set has been dropped or the cabinet has been damaged, unplug this television set from the wall outlet and refer servicing to qualified service personnel.



- 8 If liquid has been spilled into this television set, unplug it from the wall outlet and refer service to qualified service personnel.



- 9 Do not subject your television set to impact of any kind. Be particularly careful not to damage the picture tube surface.



- 10 Unplug this television set from the wall outlet before cleaning. Do not use liquid cleaners or aerosol cleaners. Use a damp cloth for cleaning.



- 11-1 Do not place this television set on an unstable cart, stand, or table. The television set may fall, causing serious injury to a child or an adult, and serious damage to the appliance. Use only with a cart or stand recommended by the manufacturer, or sold with the television set. Wall or shelf mounting should follow the manufacturer's instructions, and should use a mounting kit approved by the manufacturer.



- 11-2 An appliance and cart combination should be moved with care. Quick stops, excessive force, and uneven surfaces may cause the appliance and cart combination to overturn.



PROTECTION AND LOCATION OF YOUR SET

- 12 Do not use this television set near water...for example, near a bathtub, washbowl, kitchen sink, or laundry tub, in a wet basement, or near a swimming pool, etc.



- Never expose the set to rain or water. If the set has been exposed to rain or water, unplug the set from the wall outlet and refer to servicing personnel.



- 13 Choose a place where light (artificial or sunlight) does not shine directly on the screen.



- 14 Avoid dusty places, since accumulated dust inside the TV chassis may cause failure of the set when high humidity persists.

- 15 The set has slots, or openings in the cabinet for ventilation purposes, to provide reliable operation of the receiver, and to protect it from overheating. These openings must not be blocked or covered.

- Never cover the slots or openings with cloth or other material.



- Never block the bottom ventilation slots of the set by placing it on a bed, sofa, rug, etc.



- Never place the set near or over a radiator or heat register.



- Never place the set in a "built-in" enclosure, unless proper ventilation is provided.



PROTECTION AND LOCATION OF YOUR SET

- 16-1 If an outside antenna is connected to the television set, be sure the antenna system is grounded so as to provide some protection against voltage surges and built up static charges. Section 810 of the National Electrical Code, NFPA No. 70-1975, provides information with respect to proper grounding of the mast and supporting structure, grounding of the lead-in wire to an antenna discharge unit, size of

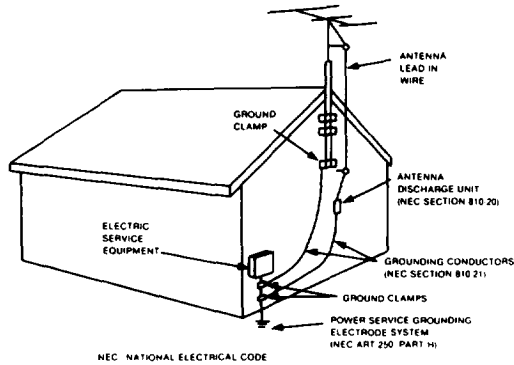

NEC NATIONAL ELECTRICAL CODE
EXAMPLE OF ANTENNA GROUNDING AS PER NATIONAL ELECTRICAL CODE INSTRUCTIONS

grounding conductors, location of antenna-discharge unit, connection to grounding electrode, and requirements for the grounding electrode.

- 16-2 Note to CATV system installer: (Only for the television set with CATV reception)
This reminder is provided to call the CATV system installer's attention to Article 820-40 of the NEC that provides guidelines for proper grounding and, in particular, specifies that the cable ground shall be connected to the grounding system of the building, as close to the point of cable entry as practical.

- 17 An outside antenna system should not be located in the vicinity of overhead power lines or other electrical lights or power circuits, or where it can fall into such power lines or circuits. When installing an outside antenna system, extreme care should be taken to keep from touching such power lines or circuits as contact with them might be fatal.

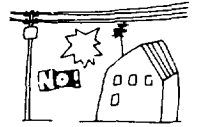

- 18 For added protection for this television set during a lightning storm, or when it is left unattended and unused for long periods of time, unplug it from the wall outlet and disconnect the antenna. This will prevent damage due to lightning and power-line surges.

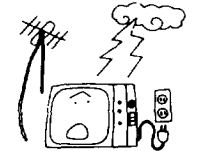

OPERATION OF YOUR SET

- 19 This television set should be operated only from the type of power source indicated on the marking label. If you are not sure of the type of power supply at your home, consult your television dealer or local power company. For television sets designed to operate from battery power, refer to the operating instructions.



- 20 If the television set does not operate normally by following the operating instructions, unplug this television set from the wall outlet and refer servicing to qualified service personnel. Adjust only those controls that are covered in the operating instructions as improper adjustment of other controls may result in damage and will often require extensive work by a qualified technician to restore the television set to normal operation.

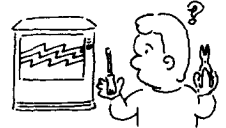

- 21 When going on a holiday: If your television set is to remain unused for a period of time, turn the television set "off" and unplug it from the wall outlet.

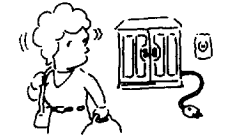

IF THE SET DOES NOT OPERATE PROPERLY

- 22 If you are unable to restore normal operation by following the detailed procedure in your operating instructions, do not attempt any further adjustment. Unplug the set and call your dealer or service technician.



- 23 Whenever the television set is damaged or fails, or a distinct change in performance indicates a need for service, unplug the set and have it checked by a professional service technician.

- 24 It is normal for some TV sets to make occasional snapping or popping sounds, particularly when being turned on or off. If the snapping or popping is continuous or frequent, unplug the set and consult your dealer or service technician.

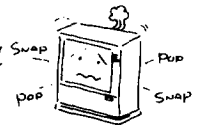

FOR SERVICING AND MODIFICATION

- 25 Do not use attachments not recommended by the television set manufacturer as they may cause hazards.

- 26 When replacement parts are required, be sure the service technician has used replacement parts specified by the manufacturer that have the same characteristics as the original part. Unauthorized substitutions may result in fire, electric shock, or other hazards.

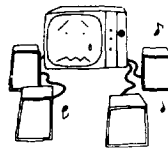

- 27 Upon completion of any service or repairs to the television set, ask the service technician to perform routine safety checks to determine that the television is in safe operating condition.

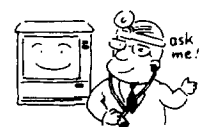

HOOK-UP CABLES AND CONNECTORS

Most video/audio connections between components can be made with shielded video and audio cables that have phono connectors. For best performance, video cables should use 75-ohm coaxial shielded wire. Cables can be purchased from most stores that sell audio/video products. Below are illustrations and names of common connectors.

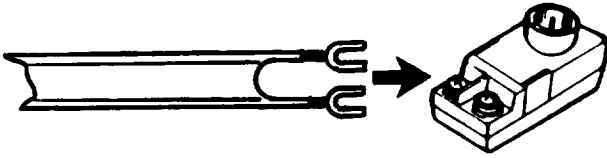

300-ohm Twin Lead Connector

This outdoor antenna cable must be connected to an antenna adaptor (300-ohm to 75-ohm).



Phono Connector

Used on all standard video and audio cables which connect to inputs and outputs located on the Television's Interface Connection Panel.

Before purchasing any cables, be sure of the output and input connector types required by the various components. Also make sure how long the cable should be.



"F"-Type 75-ohm Coaxial Antenna Connector

For connecting RF signals (antenna or cable TV) to the antenna jack on the television.

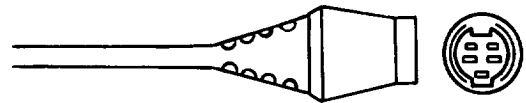

S-Video (Super Video) Connector

This connector is used on camcorders, VCR's and laser disc players with an S-Video feature in place of the standard video cable to produce a high-quality picture.

BEFORE OPERATING YOUR TV SET

INSTALLATION

■ ANTENNA

Unless your TV set is connected to a cable TV system or to a centralized antenna system, a good outdoor color TV antenna is recommended for the best performance. However, if you are located in an exceptionally good signal area that is free from interference and multiple image ghosts, the indoor antenna may be sufficient.

■ LOCATION

Select an area where sunlight or bright indoor illumination will not fall directly on the picture screen. Also, be sure that the location selected allows a free flow of air to and from the perforated back cover of the TV set.

To prevent damaging the TV, do not leave the set in a place where the temperature becomes too hot. For example, exposed to direct sunlight or near a heating device, etc.

■ VIEWING

This TV set may be viewed from any desired distance. Most viewers prefer a distance of three to six feet or more, depending on screen size, for maximum eye comfort.

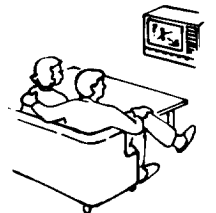

ANTENNA CONNECTIONS

The 35TX69K is equipped with one VHF/UHF antenna terminal. The VHF/UHF terminal can be used for normal TV, cable TV (CATV), or TV game, etc.

1. VHF (75Ω) antenna/CATV

When using a 75 ohm coaxial cable system, disconnect the VHF adaptor from the VHF 75 ohm receptacle and connect the outdoor antenna or CATV cable to a VHF 75 ohm receptacle.

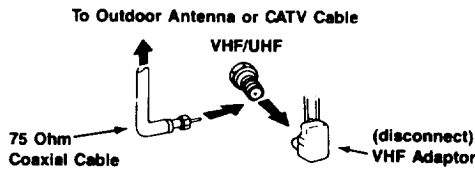

3. When both VHF and UHF antennas are connected

Attach an optional ANT. MIXER to the TV antenna terminal, and connect the cables to the ANT. MIXER.

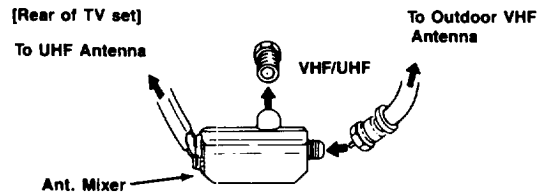

2. VHF (300Ω) antenna/UHF antenna

When using a 300 ohm twin lead from an outdoor antenna, disconnect the (VHF or UHF) indoor antenna leads from screws of the (VHF or UHF) adaptor, and connect outdoor (VHF or UHF) antenna leads to these screws of a (VHF or UHF) adaptor.

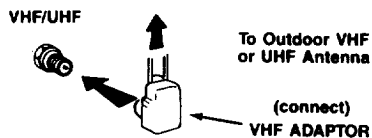

Notes

1. If an outdoor antenna/CATV is to be used, disconnect the indoor antenna. Do not leave both the indoor and outdoor antennas/CATV connected at the same time, since ghosting and poor reception may result.
2. Consult your dealer or service store for the ANT. MIXER and (VHF or UHF) adaptor.
3. The special converter (decoder) will be supplied by the cable company.

LOCATION OF CONTROLS

VCR STORAGE COMPARTMENT

This TV is equipped with a VCR storage compartment. Follow instructions below for door operation and VCR installation.

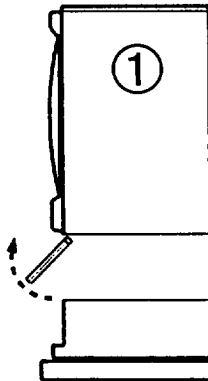
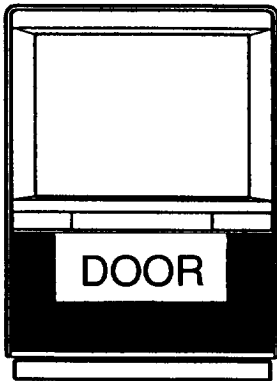

Press lower right corner of door to release magnetic latch. Gently lift door from bottom.

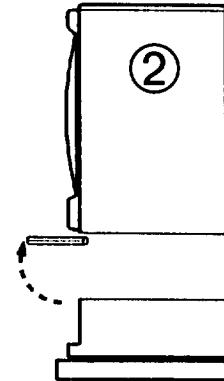

Raise door to full horizontal position.

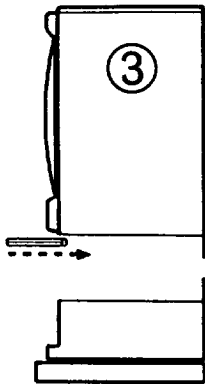

Push door to rear.

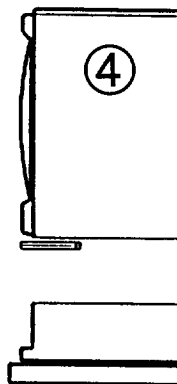

Gently push door to full back position.

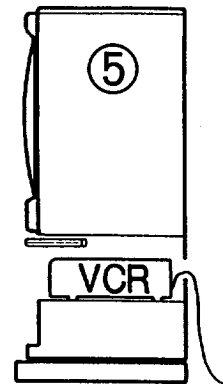

Install VCR into VCR storage compartment. Feed power cord and A/V wires through opening in back of VCR storage compartment.

TO CLOSE DOOR

Gently pull door to full forward horizontal position. Lower door to vertical position and gently press lower right corner of door to engage magnetic latch.

FRONT PANEL CONTROLS

FRONT VIEW

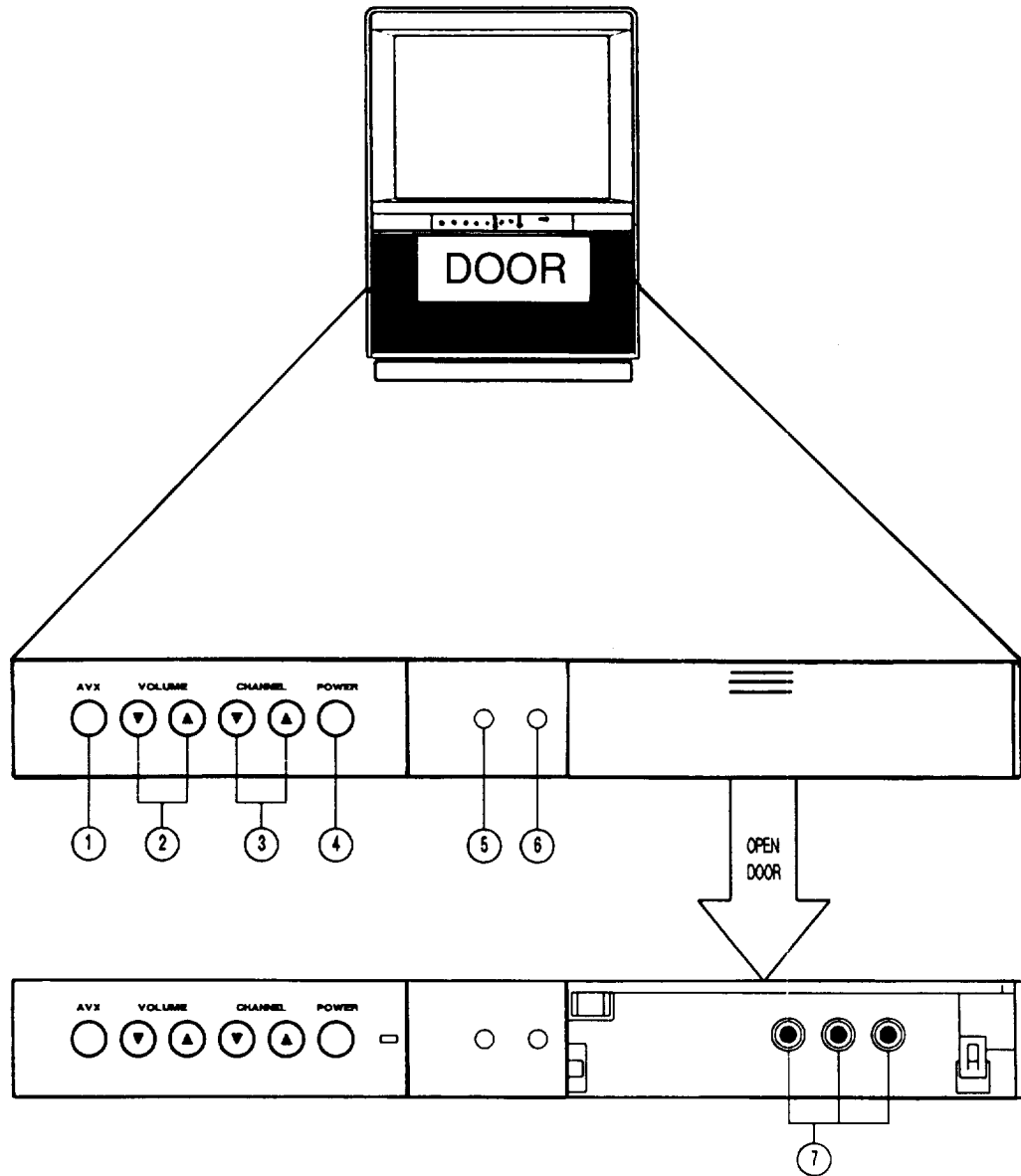

Details are described by the number attached to the part name (example: ①).

① AVX (Audio/Video) selector

Press this button to select the current antenna source, or video: 1, 2, or 3. Your selection is shown in the top right corner of the screen.

② VOLUME level

Press these buttons for your desired sound level. The volume level will be displayed on the TV screen.

FRONT PANEL CONTROLS

③ **CHANNEL selector**

Press these buttons until the desired channel appears in the top right corner of the TV screen.

④ **POWER button**

Press this button to turn the TV on or off.

⑤ **AI (Artificial Intelligence) sensor**

This "Artificial Intelligence" sensor will make automatic picture adjustments depending on the amount of light in the room to give the best picture. See page 30.

⑥ **REMOTE CONTROL sensor**

Point your Genius Remote at this area when selecting channels, adjusting volume, etc.

⑦ **FRONT INPUT JACKS (for VIDEO:3)**

Use these audio/video jacks for a "quick" hook-up from a camcorder or VCR to instantly view your favorite show or new recording. (Press the AVX button until VIDEO:3 appears in the top right corner of the TV screen.)



FRONT PANEL JACKS AND CONNECTIONS

- The front panel jacks are provided as a convenience to allow you to easily connect a camcorder or VCR as shown in the following examples.

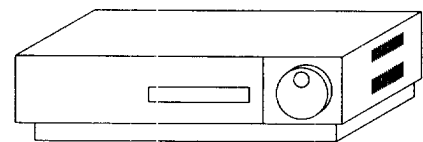
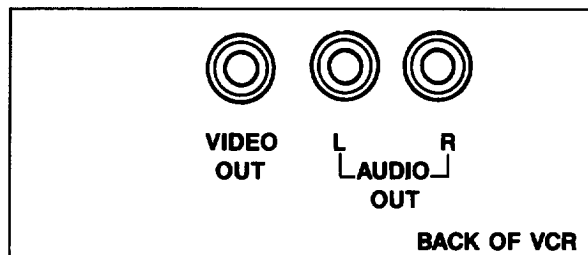
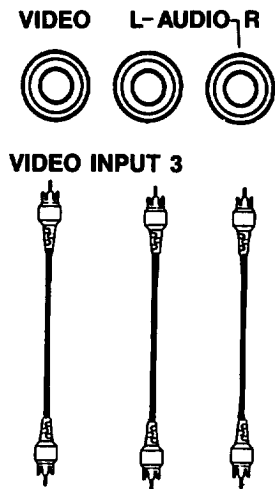
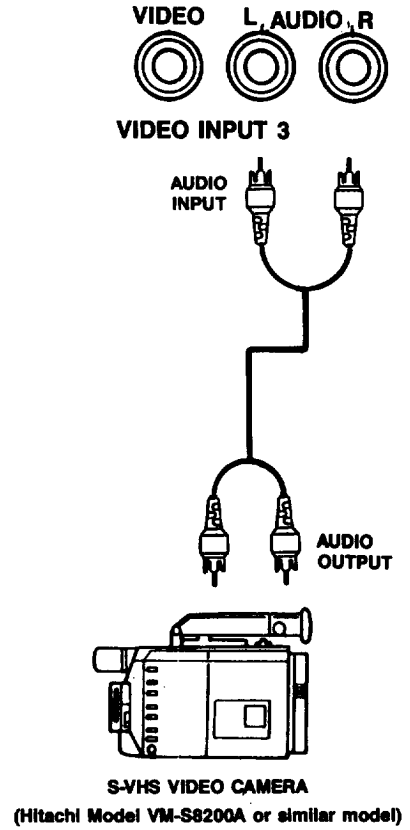
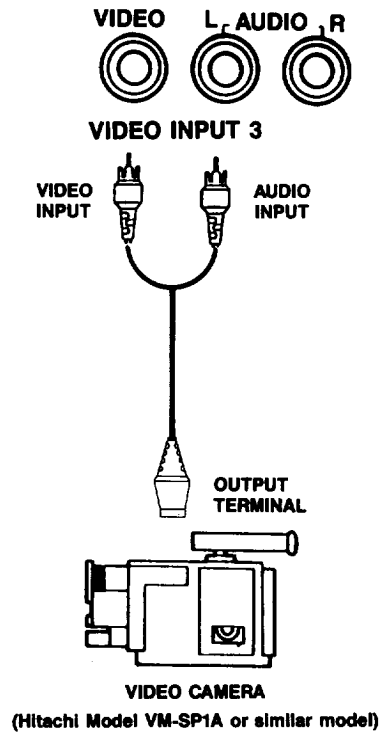

Hitachi Model VT-S751A or similar model

REAR PANEL JACKS

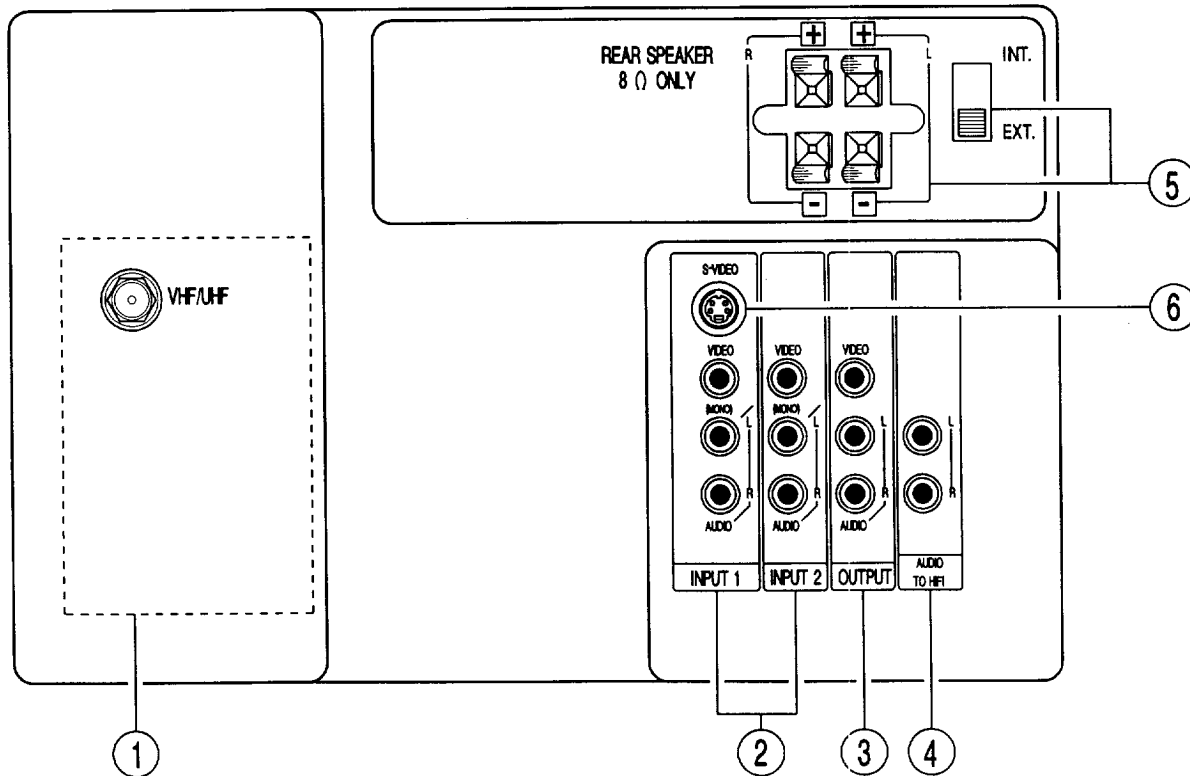

- ① **Antenna Inputs**
This is for VHF/UHF antenna and cable input.
- ② **Audio/Video Inputs 1, 2**
The "AVX" (Auxiliary video) button will step through each video source and the current antenna input each time it is pressed. Use the audio and video inputs to connect external devices, such as VCRs, camcorders, laser disc players, video games, etc.
- ③ **Output**
These jacks provide fixed audio and video signals which are used for recording.
- ④ **Audio to Hi-Fi**
These jacks provide variable audio output to a separate stereo system amplifier. With this connection, the audio to the stereo can be controlled by the television's remote control.
- ⑤ **Rear Speaker Terminals**
These terminals are used to connect external speakers, which are used for the surround sound feature. The volume level is controlled by the remote control main volume buttons and also by an independent rear volume feature found in the "sound" function menu. Use speakers with 8Ω impedance only. Terminals are switchable Internal/External Speakers.
- ⑥ **S-Video**
Input 1 provides S-Video (Super Video) jacks for connecting equipment with S-Video output capability.

REAR PANEL CONNECTIONS

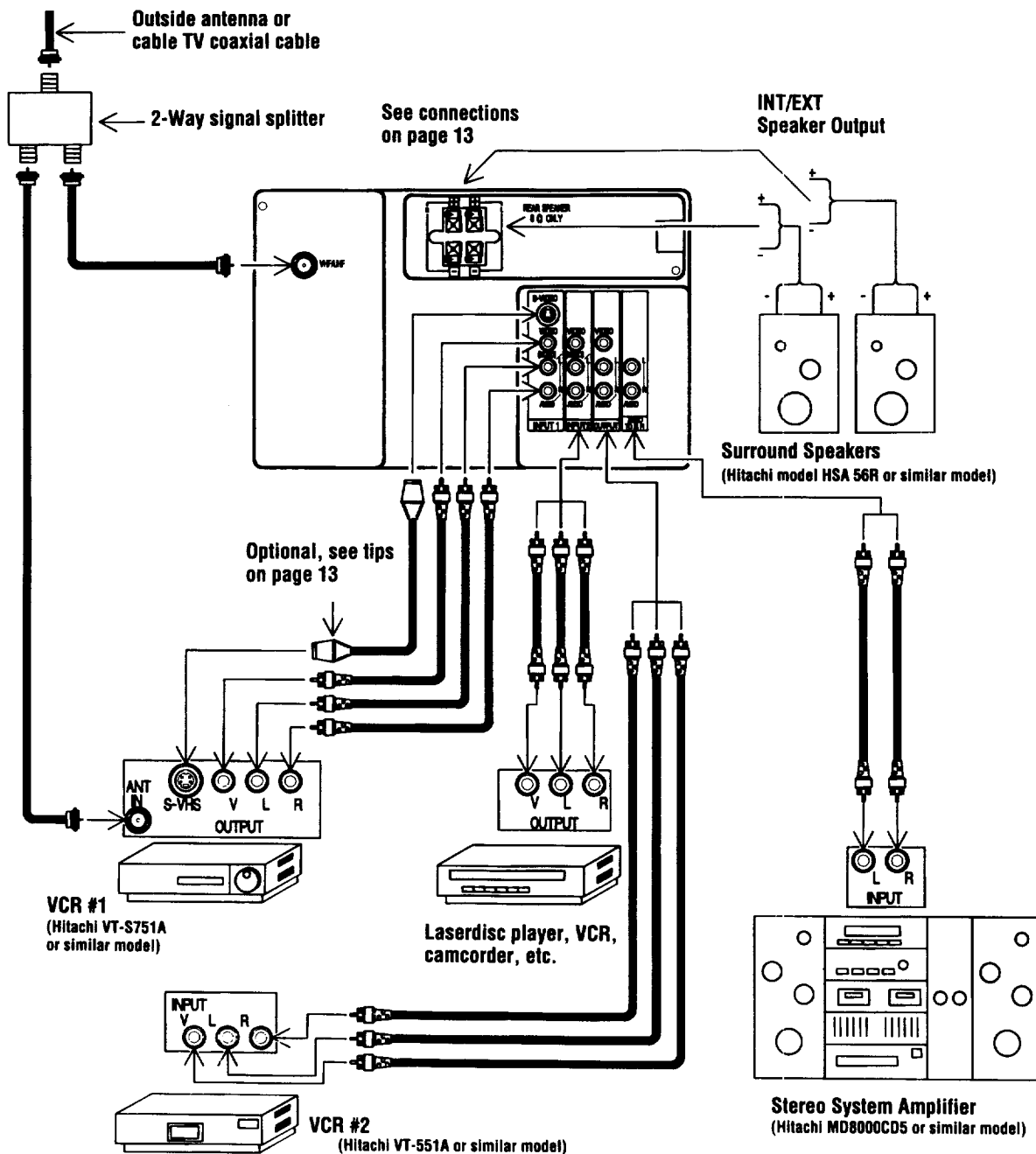

Typical full feature set-up. Follow connections that pertain to your personal entertainment system.

CONNECTING TO THE REAR SPEAKER TERMINALS

Connect after turning the power of the TV OFF.

- Press the Right Speaker red button and insert the positive lead wire + into the hole above the button. In same manner, press the Right Speaker black button and insert the negative lead wire -. Repeat this procedure for the Left Speaker.

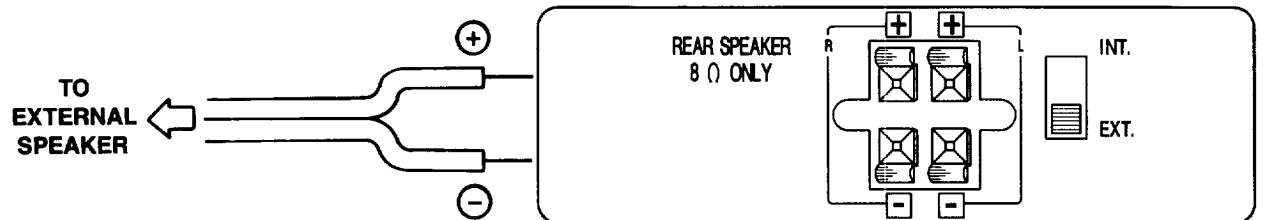

CAUTION: Do not connect Speakers simultaneously to the REAR SPEAKER terminal of the Color TV and Amplifier. This could damage both the Color TV and the Speakers. Your Hitachi TV was designed to use 8Ω speakers only. Any other type may degrade the audio performance of your entertainment system.

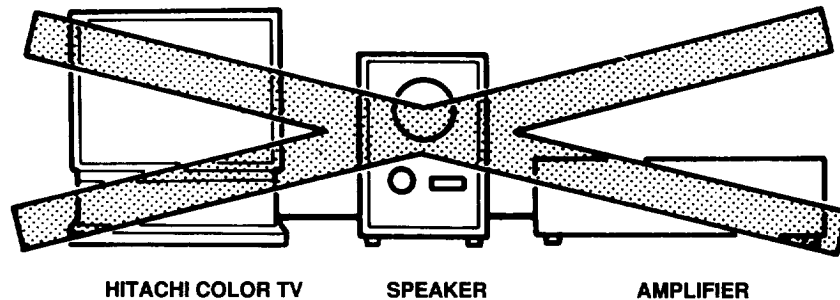

HITACHI COLOR TV

SPEAKER

AMPLIFIER

TIPS ON REAR PANEL CONNECTIONS

- The S-Video connection is provided for high performance laser discs, VCR's, etc., that have this feature. Use this connection in place of the standard video connection if your device has this feature.
- If your device has only one audio output, connect it to the left audio jack on the TV.
- Refer to the operating guide of your other electronic equipment for additional information on connecting your hook-up cables.
- A single VCR can be used for VCR #1 and VCR #2, but note that a VCR cannot record its own video or line output (Input 1 in the example on page 12). Refer to your VCR operating guide for more information on "line" input-output connections.

THE GENIUS REMOTE CONTROL (CLU-692GR with P-in-P)

In addition to controlling all the functions on your Hitachi Color TV, the new Genius Remote control is designed to operate different types of VCR's (also abbreviated VTR) and different types of CATV converters (cable boxes) with one touch. Basic operation buttons are grouped together in one area. All other controls are separated from them and

arranged in MULTI-PAGE sections, with a display that can be switched to cover any of the three pages. Functions are arranged and properly categorized into windows, making operation simple even when multiple functions are to be controlled.

- To operate your TV, point the Genius remote at the remote sensor of the TV.
- To operate your VCR, point the remote at the remote sensor of the VCR.
- To operate your cable box, point the remote at the remote sensor of the cable box.

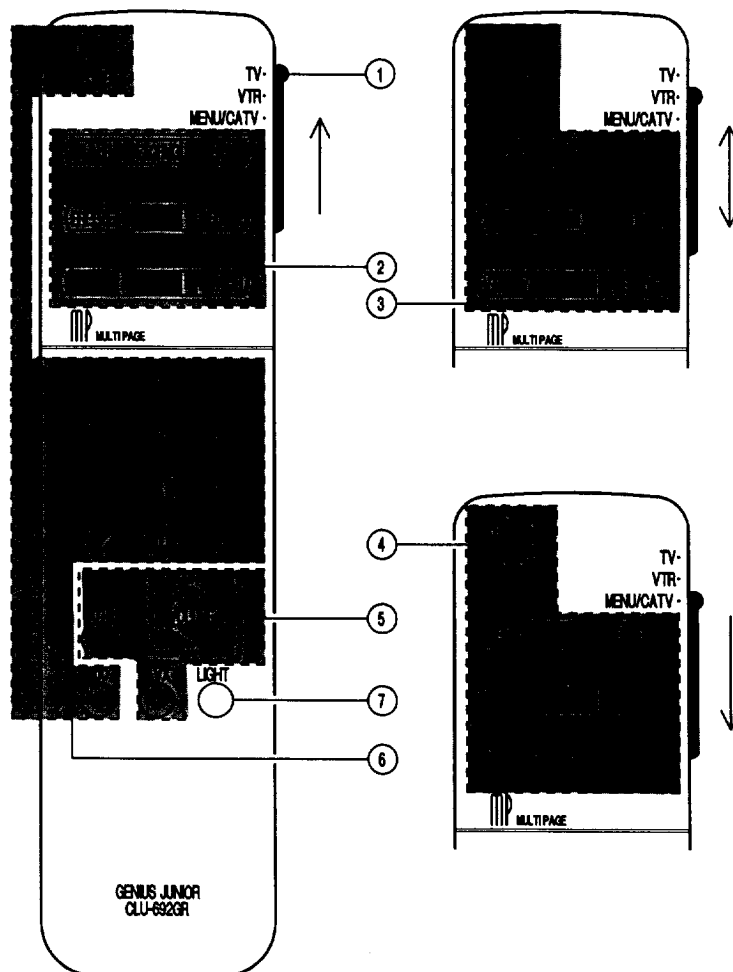

- ① **MULTI-PAGE SELECT SWITCH**
Slide the switch in the direction of the arrow to select the MULTI-PAGE mode.
- ② **Button layout when "TV" is selected.**
The P-IN-P, SHIFT EXCHNG and FREEZE buttons .
- ③ **Button layout for "VCR."** (Power button turns the VCR on or off.)
- ④ **Button layout for "MENU/CATV."** (Power button turns cable box on or off.) See pages 16 and 35.
- ⑤ **TV EXCLUSIVE BUTTONS**
These will always control the TV even when the Multi-Page select switch is in the VCR or MENU/CATV position.
- ⑥ **PRECODED BUTTONS**
These buttons will control a VCR or a cable box when the Multi-Page select switch is in the VCR or MENU/CATV position.
- ⑦ **LIGHT BUTTON**
When you are in a dark room, press this button on to light up the Channel Keys, Volume, Up and Down Keys. The light will stay on for about 8 seconds if no button is pressed. The buttons will not appear to light if the room is too bright.

HOW TO USE THE GENIUS REMOTE TO CONTROL YOUR T.V.

① POWER button

Press this button to turn the TV set on or off.

② RECALL button

When you want to check the channel being received, or if it has a stereo (ST) or second audio (SA) program, press the "RECALL" button. You can also check the time, and if the ON TIME or OFF TIME has been set. (These functions are explained in the MENU - SET UP section beginning on page 18.)

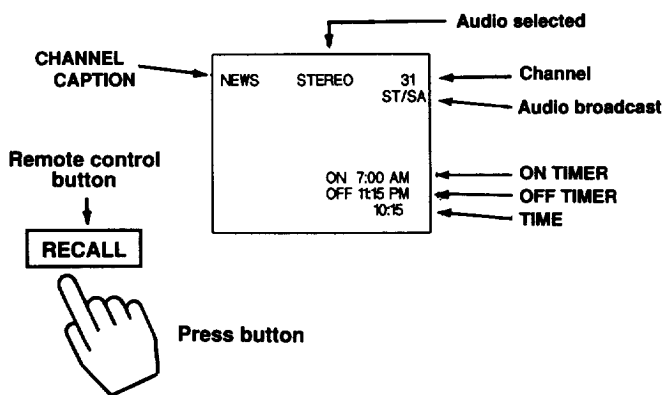

If a video input is used:

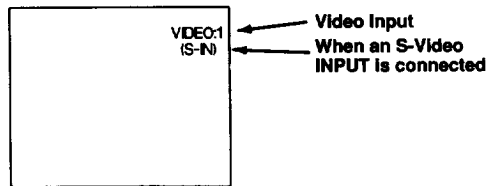

You can also use the "RECALL" button to quickly clear many of the other on-screen displays.

CLU-692GR

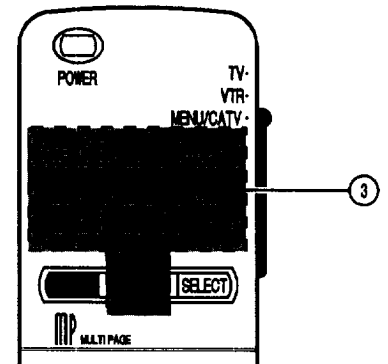
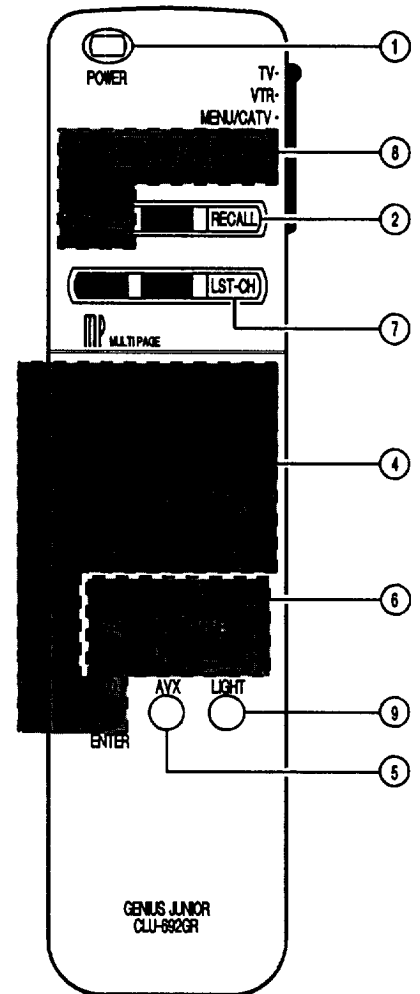

③ MENU, ENTER, CURSOR buttons

All the on-screen display features can be set or adjusted by using these buttons.

The "MENU" button will start or exit the on-screen display.

The "CURSOR" buttons will highlight functions or adjust different features.

The "ENTER" button will set features to your preference.

④ CHANNEL SELECTOR buttons

Enter two or three numbers to select channels. Enter a "0" first for channels 1 to 9. Use the "100" button for channels 100 and higher.

Channel selection may also be performed by pressing channel up (▲) or down (▼).

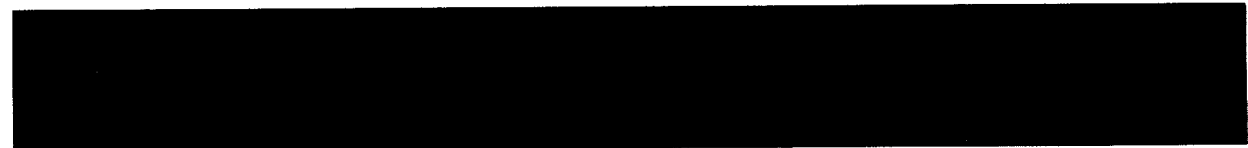

⑤ AVX button

The AVX (Auxiliary Video) button will select between the antenna signal and the three sets of video input jacks each time the button is pressed.

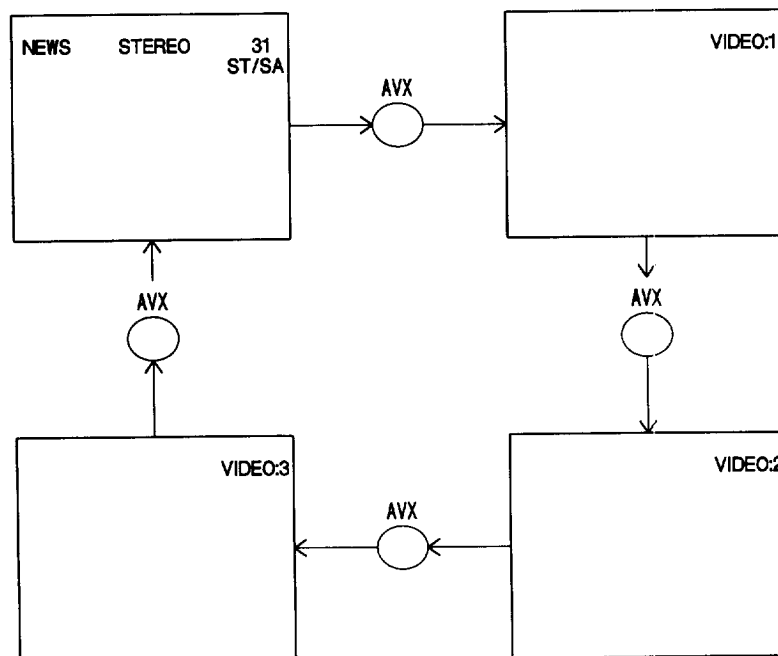

⑥ VOLUME, MUTE buttons

Press the "VOLUME" up (▲) or down (▼) button until you obtain the desired sound level.

To turn the sound off instantly to answer the telephone, etc., press the "MUTE" button. Press the "MUTE" button again or press the "VOLUME" up (▲) button to restore the sound.

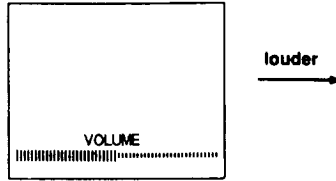

The word "MUTE" will remain displayed if the CLOSED CAPTION feature is turned off. See page 18.

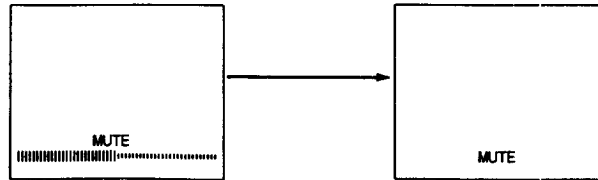

The word "MUTE" will not be displayed if the CLOSED CAPTION feature is on. See page 18.

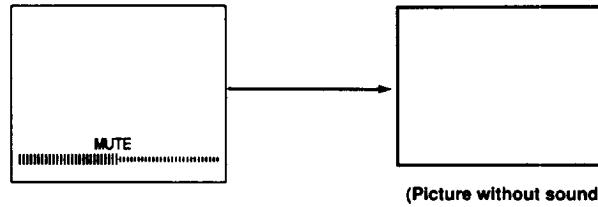

⑦ LAST CHANNEL (LST-CH) button

Use this button to select between the last two channels viewed. (Good for watching two sporting events, etc.)

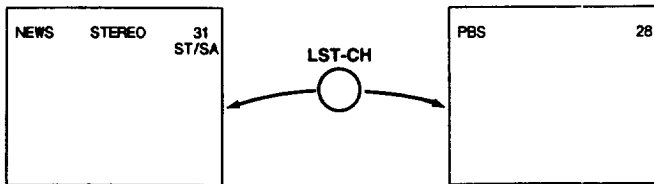

⑧ PICTURE-IN-PICTURE buttons

See separate section on page 27 for a description.

⑨ LIGHT button

When you are in a dark room, press this button to light up the volume and channel buttons. The light will stay on for about 8 seconds if no button is pressed. The buttons will not appear to light if the room is too bright.

-SET UP- FUNCTIONS

Press MENU, 1, and ENTER to display 5 of the -SET UP- Functions. There are a total of 9- SET UP- Functions.

Use the CURSOR UP or DOWN to scroll through the functions, or use the number buttons to highlight a function. The functions highlighted in purple can be selected by pressing ENTER. To exit the on-screen display, press MENU or RECALL.

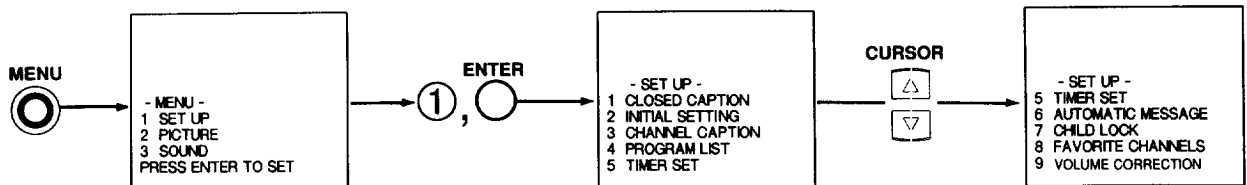

• CLOSED CAPTION cc

When CLOSED CAPTION is highlighted in purple, press ENTER to see the following display:

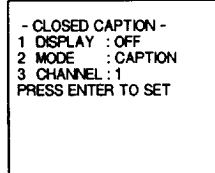

Closed captions are the dialogue, narration, and/or sound effects of a television program or home video which are displayed on the TV screen. Your local TV program guide denotes these programs as cc

DISPLAY: ON/OFF is to turn the cc display on or off.

MODE: CAPTION is for the program you are viewing.

MODE: TEXT is for additional information such as news reports or a TV program guide. This information covers the entire screen and viewing the TV program is not possible. TEXT may not be available with every cc program.

CHANNEL 1 is used for the primary language (usually English).

CHANNEL 2 is sometimes used for a second language (may vary by region).

Use the CURSOR UP or DOWN to highlight the function to change, press ENTER to change the function, and press MENU to exit.

• INITIAL SETTING

Select -SET UP- and -INITIAL SETTINGS- when setting your TV up for the first time. Use the CURSOR UP / DOWN or a NUMBER from the remote to highlight the functions desired.

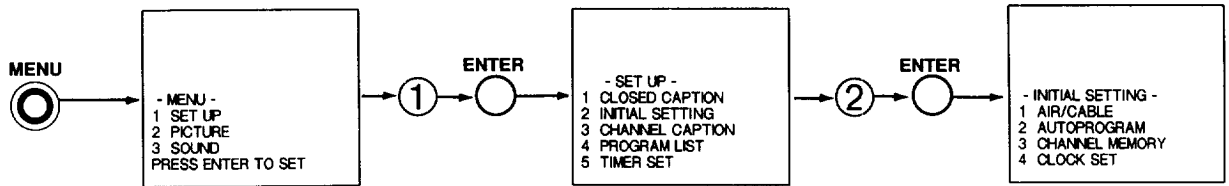

• AIR / CABLE

Select this function to change between regular VHF/UHF broadcasting (AIR) and cable TV (CATV1 or CATV2).

Press the CURSOR buttons to highlight the correct AIR/CABLE mode and press MENU to exit.

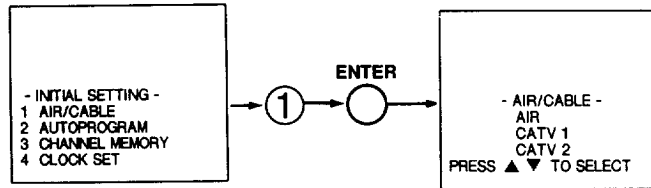

Reception channels for each mode are shown at the right.

Refer to your cable or TV guide for channel identification standards.

If certain CATV channels are poor or not possible in the CATV mode, set the -AIR/ CABLE- select to CATV2.

RECEPTION BAND		
AIR	CATV 1 or CATV 2	
	CATV CHANNEL	Indicated on the screen
VHF 2 ~ 13ch UHF 14 ~ 69ch	VHF 2 ~ 13	2 ~ 13
	Mid band A ~ 1 A-5 ~ A-1	14 ~ 22 95 ~ 99
	Super band J ~ W	23 ~ 36
	Hyper band W+1 ~ W+28	37 ~ 64
	Ultra band W+29 ~ W+84	65 ~ 125

• AUTOPROGRAM

This feature will automatically store active TV channels in CHANNEL MEMORY. This will allow you to skip over unused channels when using the CHANNEL UP (▲) or DOWN (▼) buttons.

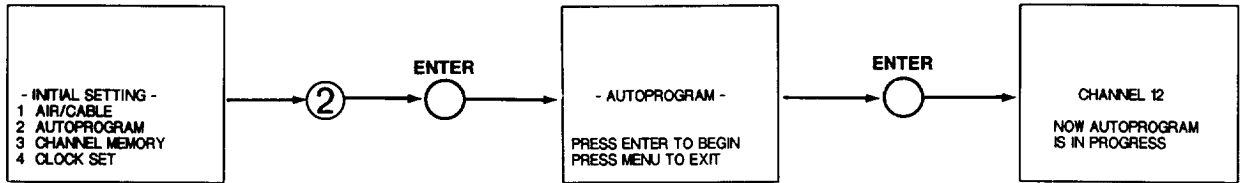

If the MENU button is pressed while the autoprogramming function is engaged, programming will stop. If two antennas are connected, switch antenna inputs with the ANT button and repeat autoprogramming for the second antenna input.

See CHANNEL MEMORY to add or erase additional channels.

• CHANNEL MEMORY

Use this function after AUTOPROGRAM to add or erase additional channels to the remote control CHANNEL ▲, ▼ buttons.

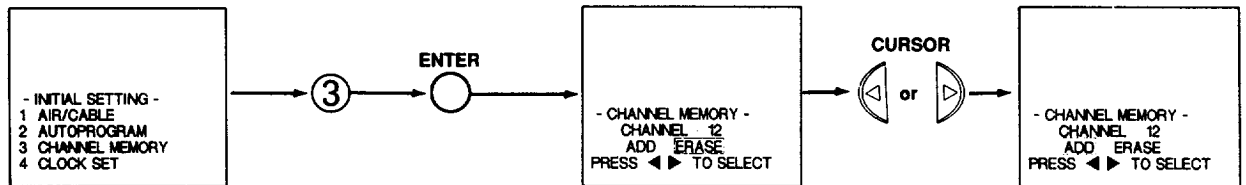

Add or erase additional channels while still in CHANNEL MEMORY using the CHANNEL ▲, ▼ buttons or number buttons and then add or erase using the CURSOR ◀, ▶ buttons.

• CLOCK SET

Use the same remote control buttons as shown in previous examples to display the clock setting, press MENU, 1, ENTER, 2, ENTER, 4, ENTER.

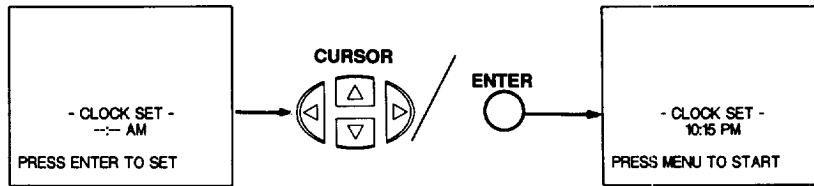

Once the proper time is set (including AM or PM), press MENU to start.

• CHANNEL CAPTION

Use this feature to give channel names to up to 30 channels for each antenna source (ABC, PAY1, CMDY, etc.).

To display this function, press MENU, 1, ENTER, 3, ENTER.

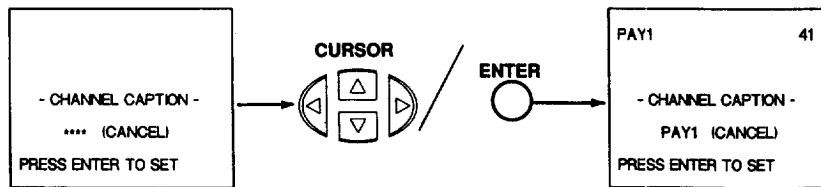

Press the CURSOR ▲, ▼ to select letters

Press the CURSOR ◀, ▶ to change position.

Press ENTER to set the CHANNEL CAPTION and it will appear in the top left corner of the screen.

Press CHANNEL ▲, ▼ or the number buttons to select and label additional channels.

Press MENU to exit.

The (*) represents a blank space.

Select CANCEL to erase a CHANNEL CAPTION.

• PROGRAM LIST

This function allows you to view which channels are labeled in CHANNEL CAPTION (NAME), which have been added to CHANNEL MEMORY (SCAN) and which are protected by CHILD LOCK (LOCK). Press MENU, 1, ENTER, 4, ENTER to view.

CH	NAME	SCAN	LOCK
01	----	--	--
02	CBS	ON	--
03	SHOW	ON	ON
04	NBC	ON	--
05	PLBY	--	ON

Press the CURSOR ▲, ▼ to view more channels.
Press MENU to exit.

• TIMER SET

This function will automatically turn the TV on or off.

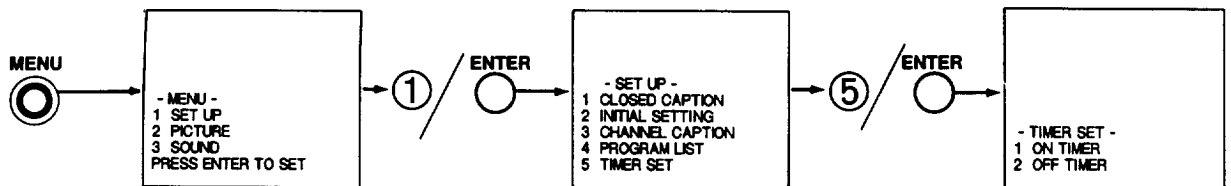

Press 1, ENTER, to select the ON TIMER.

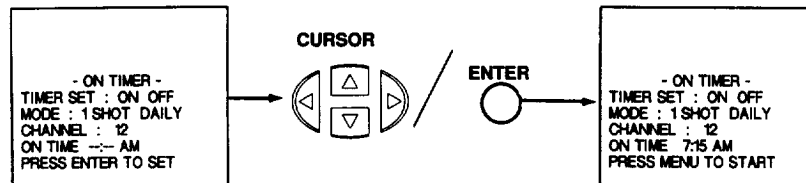

Press the CURSOR ◀, ▶ buttons for TIMER SET: ON or OFF and MODE: 1 SHOT (one time only) or MODE: DAILY (TV will turn on at the same time every day).

Press the number buttons to select the CHANNEL the TV will tune to when the TV automatically turns on.

Press the CURSOR buttons to set the ON TIME.

Press ENTER after each selection. Your choice will appear in "blocked" letters.

Press MENU to start.

Repeat the previous steps to select and set the OFF TIMER.

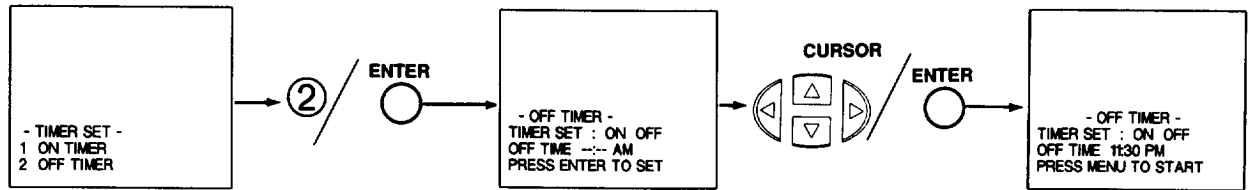

Remember to press ENTER after making selections with the CURSOR buttons.
Press MENU to start.

CAUTION: The OFF TIMER is a one time only operation. Do not try to use your TV as a deterrent when away from home by using both the ON and OFF TIMERS. The OFF TIMER function will not work until you reset it and the next ON TIME (when using the DAILY MODE) will leave the TV set turned on until you press the power button on the TV or remote control to turn it off.

• AUTOMATIC MESSAGE

Use this function to set up to three personal messages once a day or one time only. Setting the AUTOMATIC MESSAGE is the same as setting CHANNEL CAPTION and ON TIMER. Press MENU, 1, ENTER, 6, ENTER to get the AUTOMATIC MESSAGE display. (You can also use the CURSOR ▲, ▼ to "scroll" to AUTOMATIC MESSAGE and then select the function.)

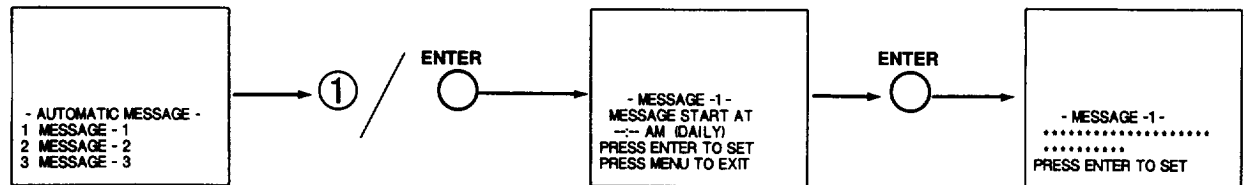

Use the CURSOR ▲, ▼ to select a letter or other character.

Use the CURSOR◀ , ▶ to change position

The asterisk (*) represents a blank space.

When finished with your message press ENTER.

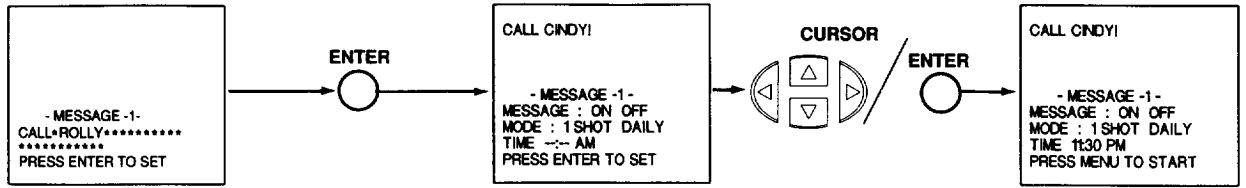

Press the CURSOR and ENTER buttons to set the functions shown in the same way as you set the OFF TIMER. Press MENU to start.

FIVE beeps will be heard when the AUTOMATIC MESSAGE is displayed.

Examples: Use this message function to remember to take daily vitamins, or use the 1 SHOT to remember to call a friend.

CAUTION: Do not leave an AUTOMATIC MESSAGE on the TV screen for more than 48 hours at a time. A pattern burn may develop and this is not covered by your warranty. The message can be erased from the TV by pressing RECALL, MUTE, LST-CH, etc.

• **CHILD LOCK**

This function will block out the picture and sound of the selected channel. Press MENU, 1, ENTER, 7, ENTER to display CHILD LOCK.

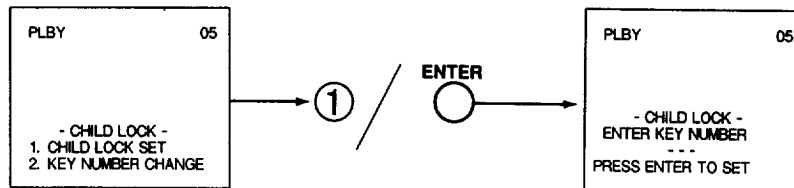

The code to set or cancel CHILD LOCK is a three digit key number. The factory preset key number is 000.

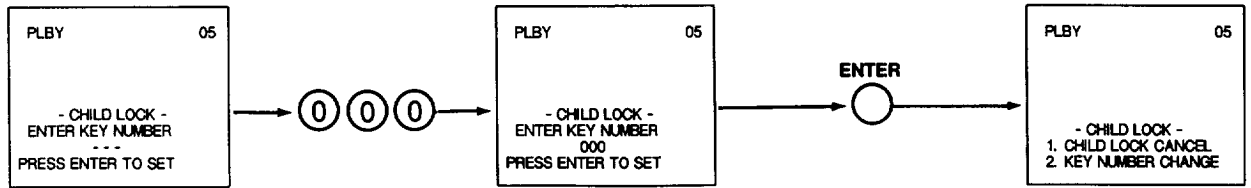

The picture and sound will now be blocked out for this channel. Repeat the same steps to cancel the CHILD LOCK.

To change the key number, select key number change. Enter the old number (factory preset 000 for first time use), then enter a new three digit key number you prefer.

If you forget your key number, use the factory code 777 to erase your key number. This will reset the key number back to the factory preset 000.

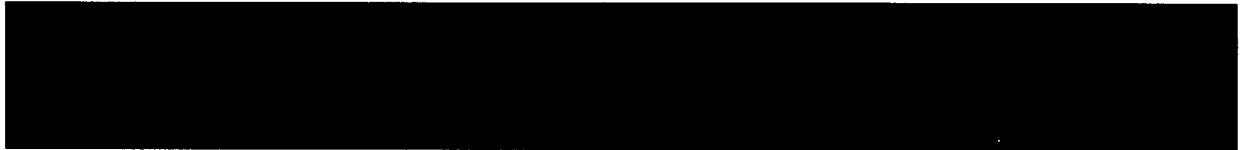

• FAVORITE CHANNELS

This function will allow you to select channels using the CURSOR buttons. Up to 5 channels can be preset for four groups of favorite channels, for a total of 20 channels. Note that only 12 channels will be shown at a time. Use the CURSOR ◀, ▶ buttons to “scroll” to the other channels. Press MENU, 1, ENTER, 8, ENTER to display FAVORITE CHANNELS.

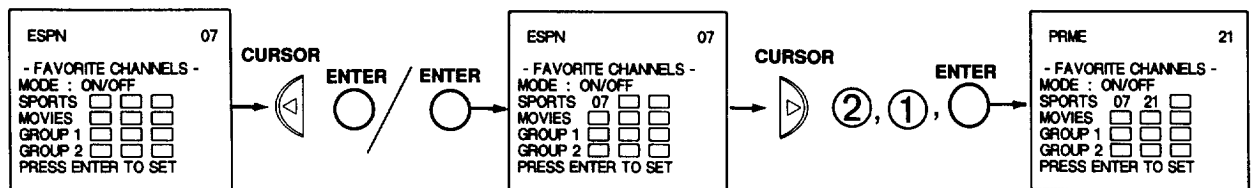

Press the CHANNEL ▲, ▼ or the number buttons to select a channel.

Press the CURSOR button to highlight the spot to save the channel.

Press ENTER to set the channel to that location.

Press MENU to exit when you have finished setting your favorite channels.

When FAVORITE CHANNELS is set to the ON MODE, press a CURSOR button to display the FAVORITE CHANNELS.

PRIME	21		
SPORTS	07	21	<input type="checkbox"/>
MOVIES	<input type="checkbox"/>	<input type="checkbox"/>	<input type="checkbox"/>
GROUP 1	<input type="checkbox"/>	<input type="checkbox"/>	<input type="checkbox"/>
GROUP 2	<input type="checkbox"/>	<input type="checkbox"/>	<input type="checkbox"/>

Press the CURSOR buttons to highlight a FAVORITE CHANNEL and the TV will tune to that channel.



• VOLUME CORRECTION

Use this function to reduce the volume level of up to four TV channels that sound loud compared to other TV channels. Press MENU, 1, ENTER, 9, ENTER to display VOLUME CORRECTION.

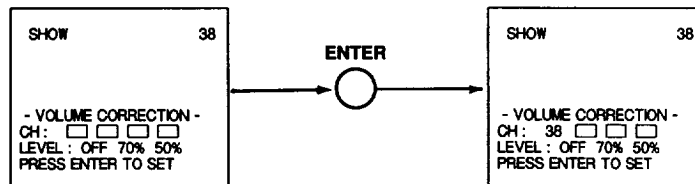

Press the CURSOR ◀, ▶ to select volume level.

Press ENTER to set the volume level.

Press MENU to exit.

PICTURE-IN-PICTURE (P-IN-P) FUNCTIONS

P IN P BUTTON

The Picture-in-Picture feature is convenient when you want to watch more than one program at the same time. You can watch a TV program while viewing a VCR program (TV or tape) and vice versa with this feature.

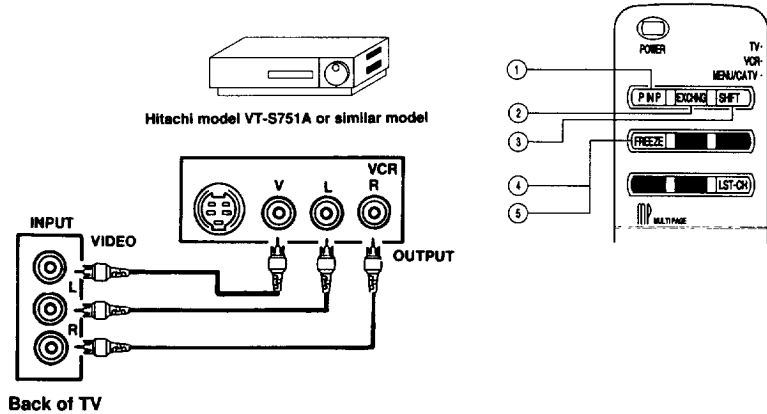

① P-IN-P BUTTON:

Press the "P in P" button and a sub-picture appears in one corner of the screen. Press the button a second time to reduce the size of the sub-picture. To remove the sub-picture from the screen, press the button a third time.

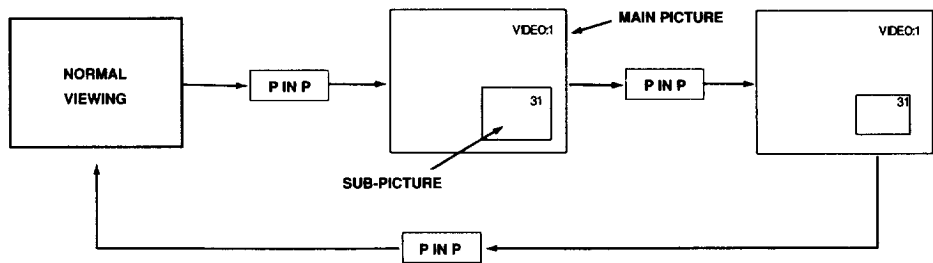

② EXCHNG BUTTON:

If you wish to switch what is being shown on the main picture to the sub-picture, press the "EXCHNG" button.

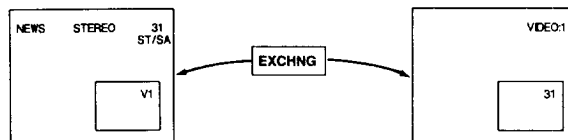

③ SHIFT BUTTON:

To move the sub-picture to another corner, press the "SHIFT" button. The sub-picture moves one step counter-clockwise every time the "SHIFT" button is pressed.

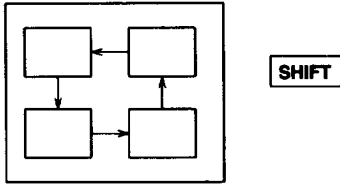

④ FREEZE BUTTON:

If you wish to freeze the sub-picture, press the "FREEZE" button. This is convenient when trying to write down the address for a mail order company, recording statistics for a sporting event, etc. To return to motion, press the button again.

⑤ FREEZE BUTTON WITHOUT A SUB-PICTURE:

Press this button without a sub-picture to freeze the picture you are currently viewing. Press this button again to return to normal viewing. The other picture-in-picture functions (SHIFT, and EXCHNG buttons) will not work with this FREEZE function.

CAUTION:

A pattern burn may develop if the sub-picture is left in the same corner permanently. If the P-in-P feature is used frequently, occasionally shift the sub-picture to a different corner.

-PICTURE- FUNCTIONS

Press MENU, 2, ENTER to display the -PICTURE- functions.

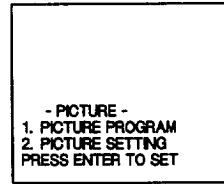

PICTURE PROGRAM is for your preferred settings — contrast, color, etc.
PICTURE SETTING is used to improve the picture quality.

• PICTURE PROGRAM

You can have two sets of preferred settings, PREFERENCE-A, PREFERENCE-B or use the factory PRESET settings.

Press MENU, 2, ENTER, 1, ENTER to select the PICTURE PROGRAM.

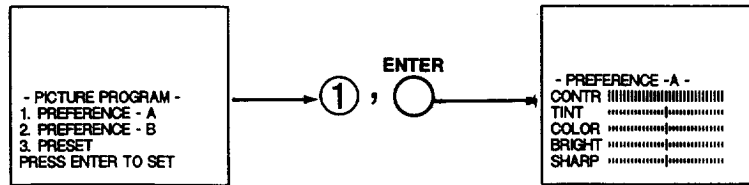

Press the CURSOR buttons to select and make adjustments.

- CONTR — Use this function to change the contrast between black and white levels in the picture. This adjustment will only affect the picture when the PICTURE SETTING AI is OFF. See page 30.
- TINT — Use this function to adjust flesh tones so that they appear natural.
- COLOR — Use this function to adjust the level of color in the picture.
- BRIGHT — Use this function to adjust overall picture brightness.
- SHARP — Use this function to adjust the amount of fine detail in the picture. This adjustment will only affect the picture when PICTURE SETTING AI is OFF.

• PICTURESETTING

Your Hitachi TV has a new AI (Artificial Intelligence) function which will automatically adjust picture settings to produce the highest quality picture possible.

• AI ON/OFF

Press MENU, 2, ENTER, 2, ENTER to display the PICTURE SETTING.

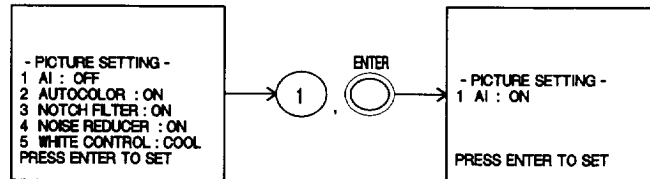

Use the CURSOR ▲, ▼ to select function.

Press ENTER to turn function on or off.

When the AI function is on, the TV internal computer will perform the following:

- ① Automatically monitor and adjust contrast depending on room lighting (sensor is located on the front panel), to produce a more natural picture.
- ② Automatically monitor and adjust color levels and maintain natural flesh tones.
- ③ Automatically compensate for weak or strong TV signals to produce a clear picture. (The SHARPNESS function is automatically adjusted.)

Turn the AI function off to control other PICTURE SETTINGS.

• AUTOCOLOR ON/OFF

The AUTOCOLOR function automatically monitors and adjusts the color to maintain constant color levels even after a program or channel changes. It also maintains natural flesh tones while preserving fidelity of background colors. For best picture performance, leave the AUTOCOLOR function on.

• NOTCH FILTER ON/OFF

Turn on the NOTCH FILTER when viewing a television program or a program from one of the regular video inputs to improve the picture appearance, especially around the outline of buildings, signs, letters, etc.

Turn off the NOTCH FILTER when viewing a program from the S-Video input to get the maximum sharpness and clarity out of the picture.

• NOISE REDUCER ON/OFF

The NOISE REDUCER automatically reduces conspicuous noise in the picture without degrading picture quality.

• **WHITE CONTROL: COOL STD** → Use this function to adjust the white balance (hue) of the picture to your own color preference. When shipped from the factory, this is set to "cool." If you prefer a reddish screen, set to "STD."

AUDIO SYSTEM SET-UP

• Match the numbers below to the diagram for speaker placement and refer to the table for the different surround sound requirements.

- ① The television's internal speakers.
- ② These speakers are connected to a separate audio amplifier. Use the "Audio to Hi-Fi" output on the TV.
- ③ These speakers are connected to the Rear Speaker 8Ω output on the TV.

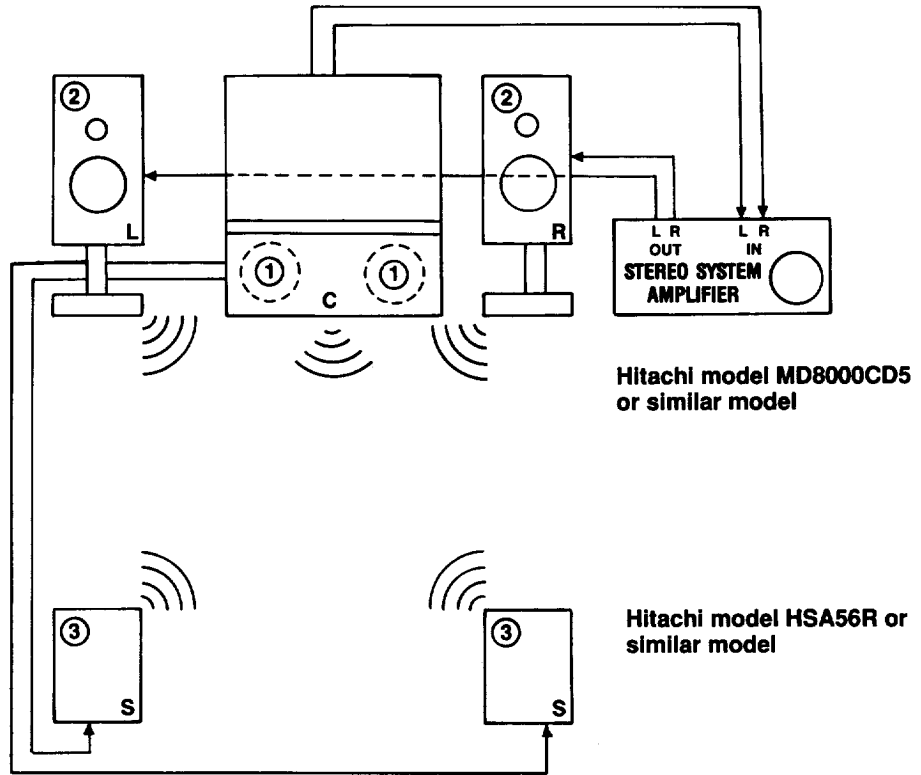

SURROUND FEATURE	REQUIRED CONNECTION	OPTIONAL CONNECTION	EFFECT
OFF	①	② ③	Receive Mono and Stereo Sound

-SOUND- FUNCTIONS

Press MENU, 3, ENTER to display the -SOUND- functions.

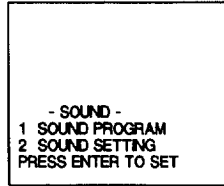

SOUND PROGRAM is for your preferred settings — balance, bass and treble.
SOUND SETTING is used to improve the sound quality.

1 SOUND PROGRAM

You can have two sets of preferred settings, PREFERENCE-A, PREFERENCE-B, or use the factory PRESET settings. Press MENU, 3, ENTER, 1, ENTER to select the SOUND PROGRAM.

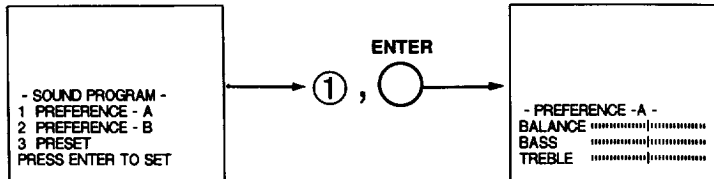

Press the CURSOR buttons to select and make adjustments.

BALANCE — This function will control the left, right balance of the TV internal speakers, the AUDIO TO HI-FI output and the surround speakers.

BASS — This function controls the low frequency audio to all speakers.

TREBLE — This function controls the high frequency to all speakers.

2 SOUND SETTING

Use the sound settings to improve the sound performance of your TV depending on listening conditions.

Press MENU, 3, ENTER, 2, ENTER to display the SOUND SETTING.

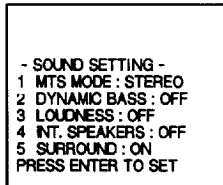

Use the CURSOR ▲, ▼ to select a function.

Press ENTER to set a function or to turn it on or off.

- **MTS MODE (Multi-Channel Television Sound)** will allow you to select STEREO (a stereo broadcast), SA (second audio) program which may be a secondary language, weather report, etc. or MONO (monaural sound) used when receiving a weak stereo broadcast.

The sources received will be displayed below the channel number. The source you select will be displayed to the left of the channel number. See example below for each selection when both stereo and second audio are received (monaural is always received).

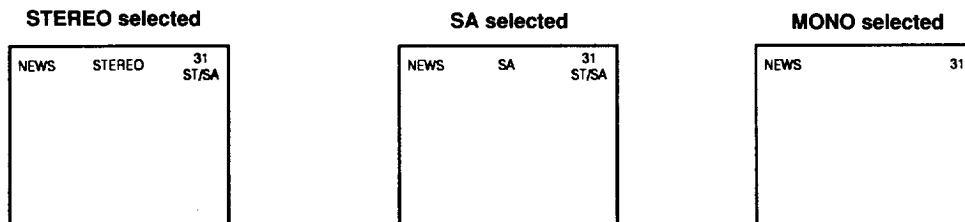

- **DYNAMIC BASS**

This function allows you to enjoy spectacular bass sound that would normally be heard only with expensive home speaker systems.

- **LOUDNESS**

— Due to the characteristics of the human ear, the bass and treble seem to drop off when the sound volume is decreased. Therefore, the "LOUDNESS" function, when turned "ON" will increase the bass and treble to compensate for this drop off.

This function will improve the quality of both low and high frequency sounds when listening at low volume levels.

- **INT. SPEAKERS**

This function allows the user to turn off the TV speakers. Therefore, no sound will be emitted from them. This function is useful when first setting up the external speakers, or if you prefer to use only speakers from a separate stereo system.

For external speaker with Internal/External switch, sound reproduction is as follows.

Int. Speaker: ON

Switch to Int.: Internal Speaker is ON

Switch to Ext.: Connect Ext. Speaker first or no sound will be heard. External Speaker is ON.

Int. Speaker: OFF

Switch Int. or switch Ext.: Int. and Ext. Speaker are OFF.

- **SURROUND SOUND STEREO**

Surround sound allows the viewer to enjoy sound which provides a feeling of "presence" from stereo broadcasts and VCR tapes* recorded with stereo sound.

- **SURROUND**

OFF:

Use this for normal stereo/mono broadcasts.

ON:

Listener is surrounded by many sound sources such as a sporting event, etc.

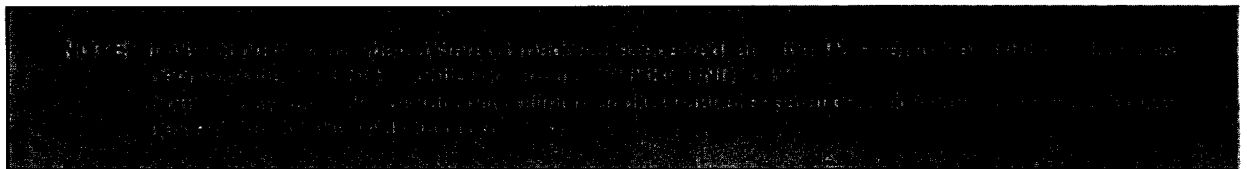

*Your play VCR must be a Hi-Fi or stereo unit. See page 12 for stereo VCR connection.

*Set must be outputting stereo. (See MTS • mode : stereo. See page 32.)

USING THE GENIUS REMOTE TO CONTROL VCR FUNCTIONS

- To operate your VCR, point the Genius remote at the remote sensor of the VCR.

The Genius remote is designed to operate different types of VCR's. You must first program the Genius remote to match the remote system of your VCR (Refer to Table 1 on page 36).

(1) Turn ON your VCR.

(2) Set the Multi-Page select switch on the Genius remote to VCR.

(3) AIM the Genius remote at the front of your VCR.

(4) While holding down the SELECT button, press the button that matches your VCR as shown on page 36. The channels on the VCR will begin changing after 5 seconds when the correct button is pressed. When this happens the Genius Remote control is programmed for your VCR. If the VCR channels do not change after 5 seconds, try a different Genius Remote button.

(5) Release both buttons when the VCR begins to change channels. The precoded VCR buttons will now control your VCR.

Notes:

- If your VCR cannot be operated after performing the above procedure, the codes have not been precoded into the Genius remote control and it will not be able to operate your VCR.
- You will only have to program your remote control to match your VCR once. The remote will remember the codes until you replace the batteries.
- Whenever you install or replace batteries in the Genius remote, you must reprogram the Genius remote to match the remote system of your VCR.
- When operating your TV or a cable box, remember to set the Multi-Page select switch to the proper position.
- Refer to the instruction manual for the VCR to operate buttons exclusively for the VCR.
- Be sure to keep the original remote control for the VCR even if you use the Hitachi Genius remote to control your VCR.

USING THE GENIUS REMOTE TO CONTROL CABLE BOX FUNCTIONS

- To operate your cable box, point the Genius remote at the remote sensor of the cable box.

The Genius remote is designed to operate different types of cable boxes. You must first program the Genius remote to match the remote system of your cable box (Refer to Table 2 on page 36).

(1) Turn ON your cable box.

(2) Set the Multi-Page select switch on the Genius remote to MENU/CATV.

(3) AIM the Genius remote at the front of your cable box.

(4) While holding down the SELECT button, press the button that matches your cable box as shown on page 36. The channels on the cable box will begin changing after 5 seconds when the correct button is pressed. When this happens the Genius Remote control is programmed for your cable box. If the cable box channels do not change after 5 seconds, try a different Genius Remote button.

(5) Release both buttons when the cable box begins to change channels. The precoded cable box buttons will now control your cable box.

Notes:

- If your cable box cannot be operated after performing the above procedure, the codes have not been precoded into the Genius remote control and it will not be able to operate your cable box.
- You will only have to program your remote control to match your cable box once. The remote will remember the codes until you replace the batteries.
- Whenever you install or replace batteries in the Genius remote, you must reprogram the Genius remote to match the remote system of your cable box.
- When operating your TV or VCR, remember to set the Multi-Page select switch to the proper position.
- Be sure to keep the original remote control for the cable box even if you use the Hitachi Genius remote to control the cable box.

TABLE 1. VCR Precoded remote controls for Hitachi GJ III Remote CLU-692GR.

VCR Brand	Press SELECT and this button	VCR Brand	Press SELECT and this button
Canon	6	Pentax	1
Citizen	0	Philco	4/6
Curtis Mathes	2/6	Philips	4/6
Dimensia	2	Pioneer	1
GE	2/6	ProScan	2
Goldstar	0	Quasar	6
Hitachi	1	RCA	1/2
Instant Replay	6	Realistic	6/9/CHANNEL▲
JC Penney	1/6/9	Sanyo	9
JVC	0	Scott	7/8
Kenwood	0	Sears	1/9
Magnavox	4/6	Sharp	CHANNEL ▲
Marantz	9	Sony	5/VOLUME ▲/VOLUME ▼
Marta	0	Sylvania	4/6
Memorex	6	Tashiko	0
MGA	7	Technics	6
Minolta	1	Toshiba	1/8
Mitsubishi	7	Wards	CHANNEL ▲
Montgomery Ward	CHANNEL ▲	Yamaha	9
NEC	9	Zenith	3/5
Panasonic	6		

TABLE 2. Cable Box Precoded remote controls for Hitachi GJ III Remote CLU-692GR.

CATV Brand	Press SELECT and this button	CATV Brand	Press SELECT and this button
General Instrument	0/1/2/3/8	Regal	4
Hamlin	4	Scientific Atlantic	6
Jerrold	0/1/2/3/8	Viewstar	9
Pioneer	7	Zenith	5

ACCESSORIES PART NUMBERS

For information regarding how to obtain these accessories, please call TOLL FREE 1-800-448-2244 for your nearest Hitachi Authorized Parts Distributor in the continental United States. For Alaska and Hawaii, please contact the nearest Hitachi Regional office.

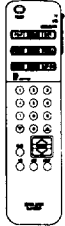
PART NAME	PART NO.	ILLUSTRATION
CLU-692GR REMOTE TRANSMITTER	2573922	 <p>CLU-692GR</p>

REMOTE CONTROL BATTERY INSTALLATION AND REPLACEMENT

TRANSMITTER BATTERY INSTALLATION AND REPLACEMENT

Open the battery cover of the Remote transmitter by pushing the notched part of the cover with your finger.

- Push the batteries towards the spring and lift them out.
- Replace old batteries with two new "AA" size (SUM-3) batteries or equivalent.
- Match the (+) and (-) marks in the battery compartment.
- Replace the cover.

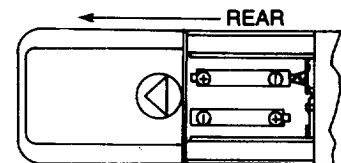

CAUTIONS

- If your television set is to remain unused for a long period of time, for instance, when you go on a vacation, unplug the television set from the wall outlet.
- Do not subject the Remote transmitter to shocks such as dropping it on the floor, etc. Precision parts may be damaged.
- Do not allow the Remote transmitter to become wet and avoid placing it in areas of high humidity. Don't leave it on or near a heater. Excess heat or moisture may cause the unit to cease operation.
- If the batteries become exhausted, Remote control operation may become erratic or stop altogether. Replace the old batteries with two fresh "AA" (SUM-3) types.

NOTES

- When the power button is set to OFF, the OFF TIMER is released.
- The channel No. indication, volume indication and OFF TIMER indication are not displayed simultaneously.
- To operate your TV, point the Remote transmitter at the remote sensor of the TV.

NOTES





1. To operate your TV, be sure to point the Genius Remote at the remote sensor on the television. To operate other electronic equipment like a VCR, point the remote at the remote sensor on the device.
2. Refer to the instruction manual of the VCR for operation of the buttons exclusively for the VCR.
3. Be sure to keep the original remote transmitter even after storing its codes in the Genius Remote Control.

Caution on batteries

- Even if the batteries seem dead, do not remove them until you have replacement batteries ready to put in. The codes stored in memory will be erased in a few minutes without power. When replacing batteries, prepare the new ones first.

TROUBLESHOOTING

RECEPTION PROBLEMS (EXTERNAL TO THE TV)

	<ul style="list-style-type: none"> • IGNITION NOISE: Black spots or horizontal streaks may appear, picture may flutter or drift. Usually caused by interference from automobile ignition systems, neon lamps, electrical drills and other electrical appliances.
	<ul style="list-style-type: none"> • GHOSTS: Ghosts are caused by the television signal following two paths. One is the direct path and the other is reflected from tall buildings, hills or some other objects. Changing the direction or position of the antenna may improve reception. Ghosting may also be caused by defects in the antenna system such as unshielded leads or connecting several sets to the same antenna without using multiple antenna couplers.
	<ul style="list-style-type: none"> • SNOW: If your receiver is located in the fringe area of a television station where the signal is weak, your picture may be marred by the appearance of small dots. When the signal is extremely weak, it may be necessary to install a special antenna to improve the picture.
	<ul style="list-style-type: none"> • RADIO FREQUENCY INTERFERENCE: The interference produces moving ripples or diagonal streaks, and in some cases, causes loss of contrast in the picture.

CHECK HERE BEFORE CALLING FOR SERVICE

SYMPTOMS	CHECK THESE ITEMS AND TRY THESE ADJUSTMENTS												
	1	2	3	4	5	6	7	8	9	10	11	12	
No picture, no sound	•	•	•	•	•	•	•	•	•	•	•	•	•
Sound OK, picture poor	•			•	•	•	•	•	•	•	•	•	•
Picture OK, sound poor	•			•	•	•	•	•	•	•	•	•	•
Picture blurred	•			•	•	•	•	•	•	•	•	•	•
Lines or streaks in picture				•	•	•	•	•	•	•	•	•	•
Poor reception on some channels				•	•	•	•	•	•	•	•	•	•
Picture rolls vertically				•									
No color	•			•	•	•	•	•	•	•	•	•	•
Poor color	•			•	•	•	•	•	•	•	•	•	•

SPECIFICATIONS

Features:

- Super Fine Quality
750 Lines Horizontal Resolution
- Dark Tint Picture Tube, INVAR CPT
- Genius Remote (CLU-692GR)
Controls many VCR brands and cable boxes, and other audio/video equipment
- Full Function Menu On-Screen Display
- Full Set of Input Jacks, including S-Video
- Artificial Intelligence System
- Closed Caption Decoder
- Picture-in-Picture
- Comb Filter, Wide-Band Video-Amp and White Control
- MTS (Multi-Channel Television Sound) Stereo
Broadcast Reception
- Surround Sound

Screen Size: 35V (35 inches measured diagonally)

Inputs:

- Power input AC 120V, 60 Hz
- Power consumption (Ave.) 160W
- Power consumption (max.) 210W
- Antenna input impedance 75Ω
- Channel coverage 181 ch.
VHF Band 2 ~ 13
UHF Band 14 ~ 69
CATV Mid Band A-5 ~ A-1
A-I
Super Band J-W
Hyper Band W+1~W+28
Ultra Band W+29~W+84
- Video 1.0Vp-p, 75Ω
- S-Video
Luminance (Y) 1.0Vp-p, 75Ω
Chrominance (C) 0.286Vp-p, 75Ω
- Audio input impedance 47kΩ
Average input level 470mVrms
Maximum input level 940mVrms

Outputs:

- Video 1.0Vp-p, 75Ω
- Audio (variable) 0 ~ 470mVrms, 1kΩ

Dimensions:

- Height (in.) 50
- Width (in.) 37¹⁵/₃₂
- Depth (in.) 25
- Weight (lbs.) 284

Console:

35TX69K

NOTE: Due to improvements, specifications in this operating guide are subject to change without notice.

HITACHI

*Service
hotline*

To locate an authorized
HITACHI service facility
in the continental U.S.A.

DIAL TOLL FREE

7 days a week, 24 hours a day

800 HITACHI

1-800-448-2244

Hitachi Home Electronics (America), Inc.

Hitachi has made every effort to assure you hours of trouble free operation from your unit. However, should you require service, a network of Hitachi Authorized Service Facilities has been established in all 50 states and Puerto Rico. Each facility will provide you with convenient and expedient assistance. Our service "Hotline" operator will direct you to the Hitachi Authorized Service Facility nearest you. Just present proof of purchase and/or delivery receipts to the Hitachi Authorized Service Facility, and service will be rendered in accordance with the terms of the limited warranty as stated on your warranty card or operating guide.

Should you have any questions regarding in-warranty service, operation or technical assistance, please contact:

Hitachi Home Electronics (America), Inc.

3890 Steve Reynolds Blvd.
Norcross, GA 30093
Tel: 404-279-5600

Hitachi Sales Corporation of Hawaii

3219 Koapaka St. / Honolulu, HI 96819
Tel: 808-836-3621

NOTES

NOTES

HITACHI