

Color Television Operating Instructions

Panasonic®

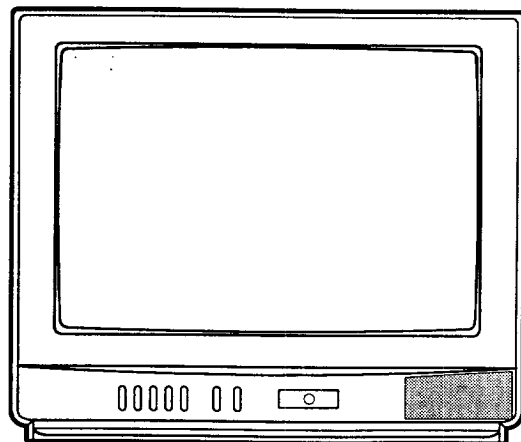

Read these instructions completely before operating this set.
Contents subject to change without notice or obligation.

Printed in U.S.A.
TQB2A0885

© Matsushita Electric Industrial Co. Ltd..
All rights reserved. Unauthorized
copying and distribution is a violation of law

Safety Instructions

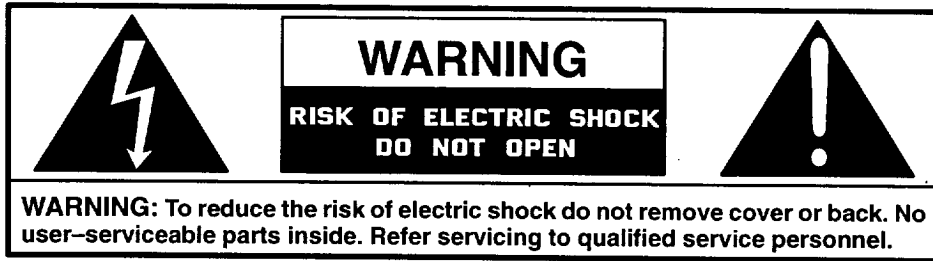

The lightning flash with arrow-head within a triangle is intended to tell the user that parts inside the product are a risk of electric shock to persons.



The exclamation point within a triangle is intended to tell the user that important operating and servicing instructions are in the papers with the appliance.

Note To CATV System Installer: This reminder is provided to call the CATV system installer's attention to Article 820-40 of the NEC that provides guidelines for proper grounding and, in particular, specifies that the cable ground shall be connected to the grounding system of the building, as close to the point of cable entry as practical.

Safety Instructions For Television Receivers

1. Read and apply the operating instructions provided with your television receiver.
2. Read all of the instructions given here and retain them for later use.
3. Unplug this television receiver from the wall outlet before cleaning. Do not use liquid or aerosol cleaners. Use a damp cloth for cleaning.
4. Do not use attachments not recommended by the television receiver manufacturer as they may cause hazards.
5. Do not use this television receiver near water. For example: Avoid placing it near a bathtub, washbowl, kitchen sink, or laundry tub, in a wet basement, or near a swimming pool, etc.
6. Do not place this television receiver on an unstable cart, stand, or table. The television receiver may fall, causing serious injury to a child or adult, and serious damage to the appliance. Use only with a cart or stand recommended by the manufacturer, or sold with the television receiver. Wall or shelf mounting should follow the manufacturer's instructions, and should use a mounting kit approved by the manufacturer.
- 6A. An appliance and cart combination should be moved with care. Quick stops, excessive force, and uneven surfaces may cause the appliance and cart combination to overturn.
7. Slots and openings in the cabinet and the back or bottom are provided for ventilation, and to insure reliable operation of the television receiver and to protect it from overheating. These openings must not be blocked or covered. The openings should never be blocked by placing the television receiver on a bed, sofa, rug or other similar surface. This television receiver should never be placed near or over a radiator or heat register. This television receiver should not be placed in a built-in installation such as a bookcase unless proper ventilation is provided.
8. Operate only from the type of power source indicated on the marking label. If you are not sure of the type of power supplied to your home consult your television dealer or local power company. For television receivers designed to operate from battery power, refer to the operating instructions.
9. This television receiver is equipped with a polarized alternating-current line plug (a plug having one blade wider than the other). This plug will fit into the power outlet only one way. This is a safety feature. If you are unable to insert the plug fully into the outlet, try reversing the plug. If the plug should still fail to fit, contact your electrician to replace your obsolete outlet. Do not defeat the safety purpose of the polarized plug.
10. Do not allow anything to rest on the power cord. Do not locate this television receiver where the cord will be abused by persons walking on it.
11. Follow all warnings and instructions marked on the television receiver.
12. Do not overload wall outlets and extension cords as this can result in fire or electric shock.
13. Never push objects of any kind into this television receiver through cabinet slots as they may touch dangerous voltage points or short out parts that could result in a fire or electric shock. Never spill liquid of any kind on the television receiver.

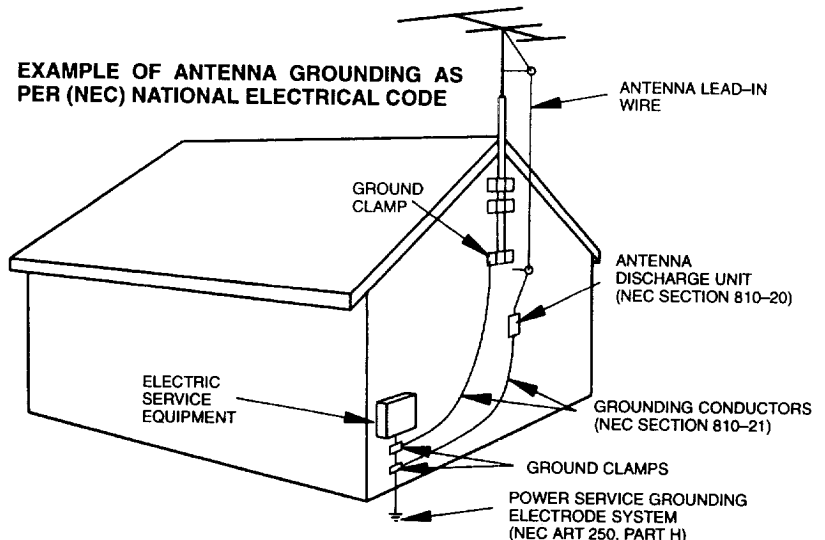

14. If an outside antenna is connected to the television equipment, be sure the antenna system is grounded so as to provide some protection against voltage surges and built up static charges. In the U.S. Section 810 of the National Electrical Code and in Canada Part 1 of the Canadian Electrical Code provides information with respect to proper grounding of the mast and supporting structure, grounding of the lead-in wire to an antenna discharge unit, size of grounding conductors, location of antenna-discharge unit, connection to grounding electrodes, and requirements for the grounding electrode. See Figure.
15. For added protection for this television receiver during a lightning storm, or when it is left unattended and unused for long periods of time, unplug it from the wall outlet and disconnect the antenna. This will prevent damage to the receiver due to lightning and power-line surges.
16. An outside antenna system should not be located in the vicinity of overhead power lines or other electric light or power circuits, or where it can fall into such power lines or circuits. When installing an outside antenna system extreme care should be taken to keep from touching such power lines or circuits as contact with them might be fatal.
17. Unplug this television receiver from the wall outlet, and refer servicing to qualified service personnel under the following conditions:
 - a. When the power cord or plug is damaged or frayed.
 - b. If liquid has been spilled into the television receiver.
 - c. If the television receiver has been exposed to rain or water.
 - d. If the television receiver does not operate normally by following the operating instructions. Adjust only those controls that are covered by the operating instructions as improper adjustment of other controls may result in damage and will often require extensive work by a qualified technician to restore the television receiver to normal operation.
 - e. If the television receiver has been dropped or the cabinet has been damaged.
 - f. When the television receiver exhibits a distinct change in performance – this indicates a need for service.
18. Do not attempt to service this television receiver yourself as opening or removing covers may expose you to dangerous voltage or other hazards. Refer all servicing to qualified service personnel.
19. When replacement parts are required, be sure the service technician has used replacement parts specified by the manufacturer that have the same characteristics as the original part. Unauthorized substitutions may result in fire, electric shock, or other hazards.
20. Upon completion of any service or repairs to this television receiver, ask the service technician to perform routine safety checks to determine that the television is in safe operating condition.
21. **WARNING: To prevent fire or shock hazard, do not expose this appliance to rain or moisture.**
22. **CAUTION: TO PREVENT ELECTRIC SHOCK DO NOT USE THIS (POLARIZED) PLUG WITH AN EXTENSION CORD, RECEPTACLE OR OTHER OUTLET UNLESS THE BLADES CAN BE FULLY INSERTED TO PREVENT BLADE EXPOSURE.**

NOTE: This equipment is designed to operate in the U.S.A., Canada and other countries where the broadcasting system and AC house current is exactly the same as in the U.S.A. and Canada.

Important Information Regarding Use of Video Games, Computers, Teletext or Other Fixed Image Displays.

The extended use of fixed image program material can cause a permanent "shadow image" on the picture tube. This background image is viewable on normal programs in the form of a stationary fixed image. This type of irreversible picture tube deterioration can be limited by observing the following steps:

- A. Reduce the brightness/contrast setting to a minimum viewing level.
- B. Do not display the fixed image for extended periods of time.
- C. Turn the power off when not in actual use.

NOTE: The marking or retained image on the picture tube resulting from fixed image use is not an operating defect and as such is not covered by Warranty. This product is not designed to display fixed image patterns for extended periods of time.

Specifications

Power Source:	120V 60Hz, AC
Channel Capability:	181 channels (See chart) VHF 2~13, UHF 14~69, Cable 125 channels
Video Input Jack:	1V p-p, 75 ohm, phono jack type
Audio Input Jack:	High Impedance – 10k ohm, 500mV rms.
Closed Caption Display	

Specifications are subject to change without notice or obligation.

Channel Capability Chart

BAND	USA/CAN
VHF	12
UHF	56
CABLE (Mid-Band)	15
CABLE (Super Band)	14
CABLE (Hyper Band)	28
CABLE (Ultra Band)	56
TOTAL CHANNELS	181

Introduction

Congratulations on Your New Purchase

Your new video component features an all solid state chassis which is designed to give you many years of enjoyment. It was thoroughly tested and adjusted at the factory for best performance.

In order for you to take full advantage of your new video component, please read and follow the installation and operating instructions supplied with this product.

Customer's Record

The model and serial number of this product may be found on its back cover. You should note the model and serial number in the space provided and retain this book as a permanent record of your purchase to aid in identification in the event of theft or loss.

Model Number: _____ Serial Number: _____

Table of Contents

Safety Instructions	2	Color	11
Specifications	3	Tint	11
Introduction	4	Brightness	11
Care & Cleaning	4	Picture	11
Installation	5	Sharpness	11
Receiver Location	5	Picture Norm	11
Optional External Equipment Connections	5	Game Guard	12
AC Power Supply Cord	5	Game Guard (Lockout)	12
Battery Installation	5	Game Guard (Unlock)	12
Antenna/Cable Connections	6	Timer Features	13
Other Video Equipment	6	Sleep Timer	13
Location of Controls	7	Program Timer	13
Quick Reference Control Operation	7	Set-Up Features	14
Control Operation	8	Menu	14
Power Button	8	CC (Closed Caption) On Mute	15
Volume (Vol) Buttons	8	Set Time (Clock)	16
Mute Button	8	Antenna Tuning Mode	17
Channel Change Features	8	Auto Programming	18
Channel (Ch) Buttons	8	Manual Programming	18
Keyboard "0 through 9" Buttons	8	CC (Closed Caption) Mode	19
TV/Video Button	8	2 Language Menu System (English/Spanish)	20
Recall Button	9	Channel Caption (Station Identifier)	21
R-Tune (Rapid Tune) Button	9	Video Input	22
Skip Button	9	Optional Equipment Connection and Operation	23
Sleep Button	9	Video/Audio Connection	23
Main Menu (Icons)	10	Troubleshooting Chart	24
Menu Language Selection	10	Power Loss	24
Picture Adjustments	11		

Care and Cleaning

Picture Tube (Turn set off)

Use a mild soap solution or window cleaner and a clean cloth. DO NOT USE ABRASIVE CLEANERS. Avoid excessive moisture and wipe dry.

Plastic Cabinets

Wipe the cabinet with a soft cloth dampened with water or a mild detergent solution and wipe dry with a soft clean cloth. Avoid excessive moisture. Do not use benzene, thinners or other petroleum based cleaners.

Wood Cabinets

When dusting or polishing the cabinet, use a clean soft cloth and stroke straight with the grain. An occasional coat of furniture polish will help preserve the finish. Do not use benzene, thinners or other petroleum based cleaners. Do not place objects made of plastic or rubber directly on top of the cabinet. A chemical reaction could result causing permanent marring of the finish.

Remote Control Transmitter

Do not use benzene, thinners or other petroleum based cleaners to clean the Remote Control Transmitter. To clean, wipe with a soft cloth slightly moistened with a mild detergent and then wipe dry with a soft clean cloth.

Installation

Location

Locate for comfortable viewing. Avoid placing where sunlight or other bright light (including reflections) will fall on the screen.

Use of some types of fluorescent lighting can reduce remote control transmitter range.

Adequate ventilation is essential to prevent internal component failure. Keep away from areas of excessive heat or moisture.

To insure optimum color purity do not position magnetic equipment (motors, fans, other speakers, etc,) nearby.

Optional External Equipment Connections

The Video/Audio connections between components can be made with shielded video and audio cables. For best performance, video cables should utilize 75 ohm coaxial shielded wire. Cables are available from your dealer or electronic supply house.

Before you purchase any cables, be sure you know what type of output and input connectors your various components require. Also determine the length of cable you'll need.

AC Power Supply Cord

Insert (Polarized) plug into 120 volts 60Hz standard AC outlet. Do not defeat the safety purpose of the polarized plug.

CAUTION: TO PREVENT ELECTRIC SHOCK DO NOT USE THIS (POLARIZED) PLUG WITH AN EXTENSION CORD, RECEPTACLE OR OTHER OUTLET UNLESS THE BLADE CAN BE FULLY INSERTED TO PREVENT BLADE EXPOSURE.

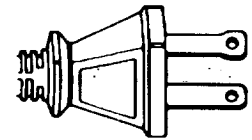

Polarized Plug

Remote Control Battery Installation & Replacement

Battery Installation

Batteries: Use two "AA" batteries.

1. Turn the Transmitter face down. To remove bottom cover, press down on marking and slide cover off in the direction indicated.
2. Install the batteries as shown in the battery compartment. (Polarity (+) or (-) must be correct.)
3. Replace the cover and slide in reverse until the lock snaps.

Precaution on Battery Use

Incorrect installation can cause battery leakage and corrosion that will damage the Remote Control Transmitter.

Observe the Following Precautions:

1. Batteries must be replaced as a pair.
2. Do not combine a used battery with a new one.
3. Do not mix battery types (Example: "Zinc Carbon" with "Alkaline").
4. Do not attempt to charge, short-circuit, disassemble, heat, or burn used batteries.
5. Battery replacement is necessary when Remote Control reacts sporadically or stops operating the Receiver.

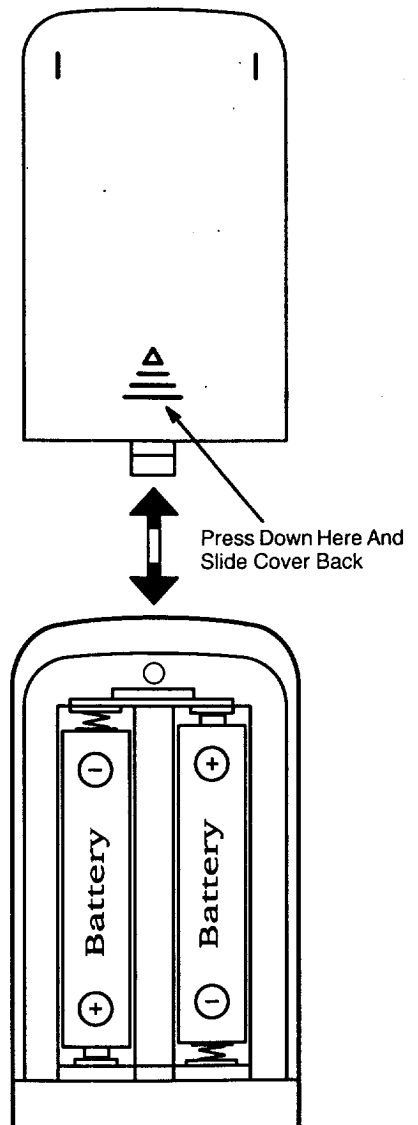

Antenna/Cable Connections

Antenna Connection – For proper reception of VHF/UHF channels an external antenna is required. For best reception an outdoor antenna is recommended. Antenna Mode must be set to TV. (Refer to Antenna Mode section.)

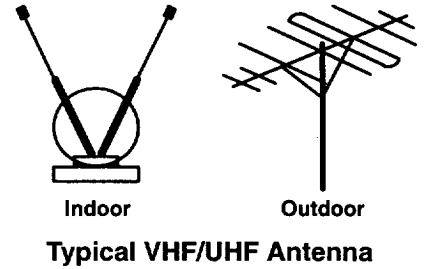

Incoming Cable From Home Antenna (75 Ohm)

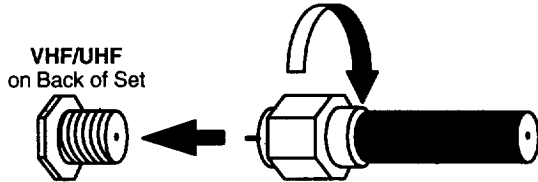

Incoming Cable From Home Antenna (300 Ohm)

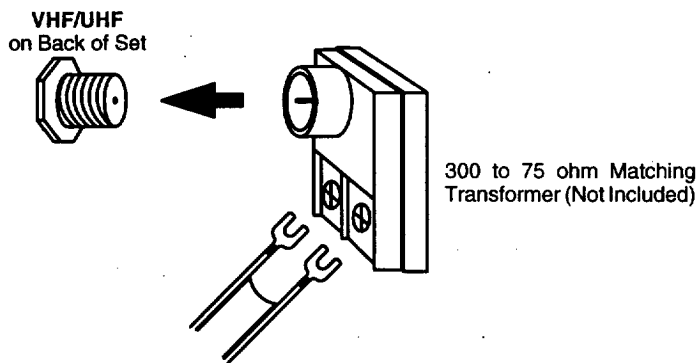

Cable Connection – For reception of cable channels (01~125) connect the cable supplied by your local cable company. Antenna Mode must be set to CABLE. (Refer to Antenna Mode section.)

Incoming 75 Ohm Cable (From Cable Company)

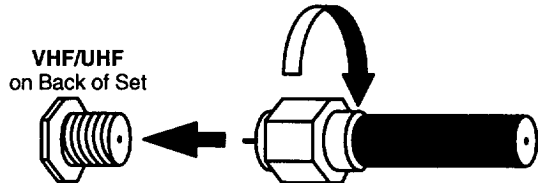

NOTE: Certain cable systems offset some channels to reduce interference or have Premium (scrambled) channels. A cable converter box is required for proper reception. Check with your local Cable company for its compatibility requirements.

Other Video Equipment

VCRs, Video Disc Players, Computers, TV games, and Teletext equipment can also be connected to the antenna input connection.

Location of Controls

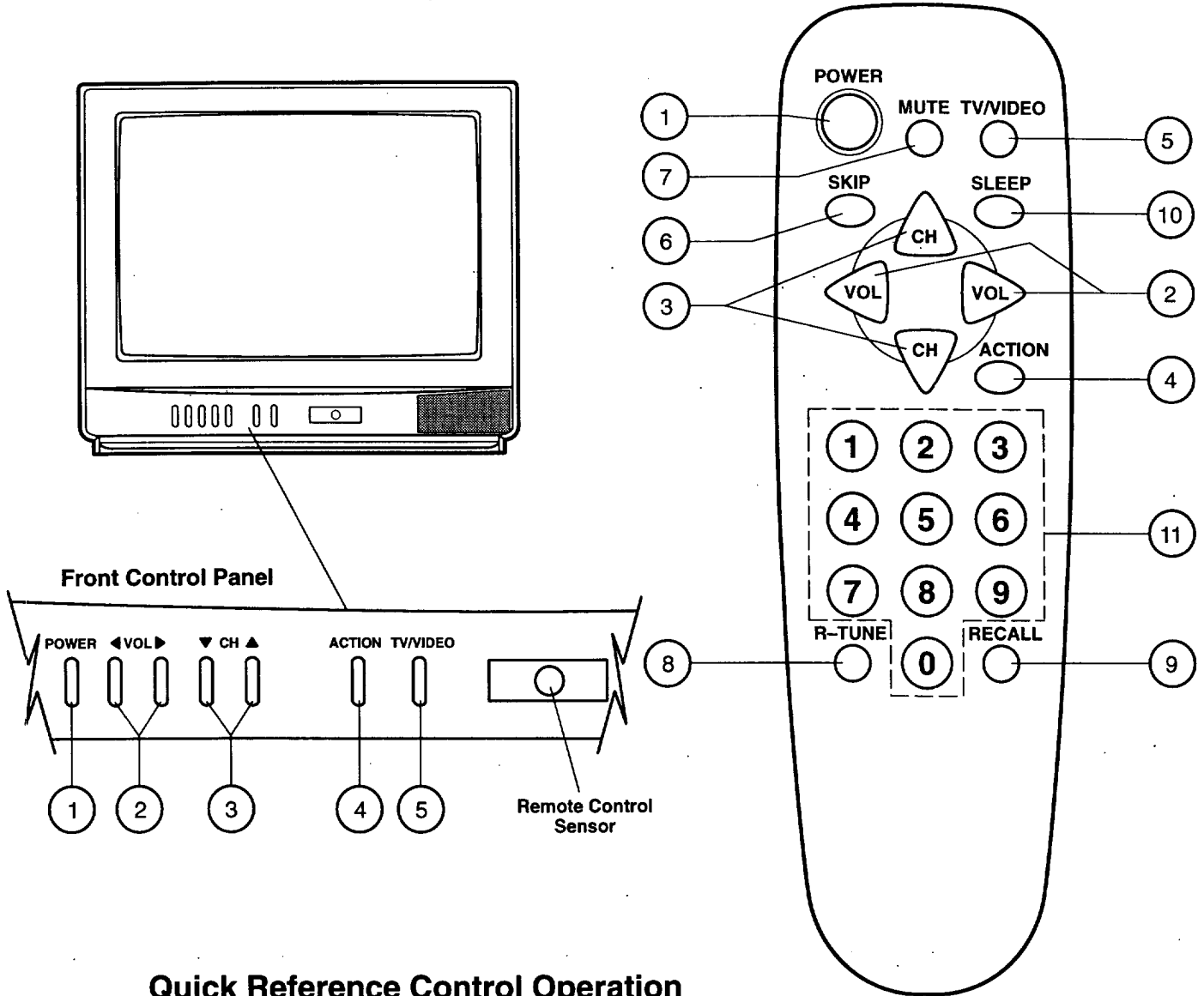

Quick Reference Control Operation

- ① **Power Button** – Press to turn ON or OFF. (pg. 8)
- ② **Volume Buttons** – Press to adjust Sound Level. Press to adjust Audio Menus, Video Menus, and select operating features when menus are displayed. (pg. 8)
- ③ **Channel Buttons** – Press to select programmed channels. Press to select desired features when menus are displayed. (pg. 8)
- ④ **Action Button** – Press to display Main Menu and access On Screen feature and Adjustment Menus. (pg. 10)
- ⑤ **TV/Video Button** – Press to select TV or Video Input. (pg. 8)
- ⑥ **Skip Button** – Press the SKIP button repeatedly to select desired time, up to three minutes, select any other channel(s). When the time elapses, you will automatically return to original channel. (pg. 9)
- ⑦ **Mute Button** – Press to mute sound. A second press returns sound. (pg. 8)
- ⑧ **R-Tune (Rapid Tune) Button** – Press to switch between two channels. (pg. 9)
- ⑨ **Recall Button** – Press to display Time, status of Sleep Timer, Channel, Video Mode, Channel Caption (Station Identifier). (pg. 9)
- ⑩ **Sleep Button** – Press to select automatic Turn OFF in 30, 60 or 90 minutes. (pg. 9)
- ⑪ **Keyboard “0 through 9” Buttons** – Press desired channel number to access any channel. (pg. 8)

Control Operation

Power Button — Press the POWER button to turn ON. Press again to turn OFF.



Volume Buttons — Press the VOLUME (VOL) LEFT or RIGHT button for desired listening level (while On Screen Menus are not displayed).

Located On Remote Control

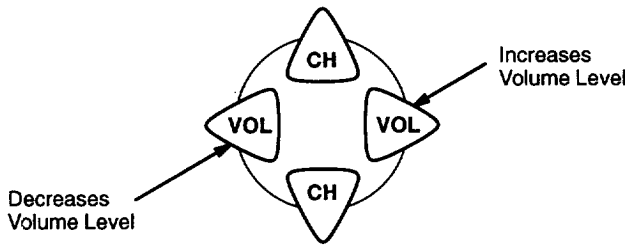

Mute Button — Press the MUTE button to quickly reduce sound level (Mute will appear on screen). Press again to restore sound.



Channel Change — (Two options)

Option 1.

Press the CHANNEL (CH) UP or DOWN button to sequentially scan through programmed channels (while On Screen Menus are not displayed).

Located On Remote Control

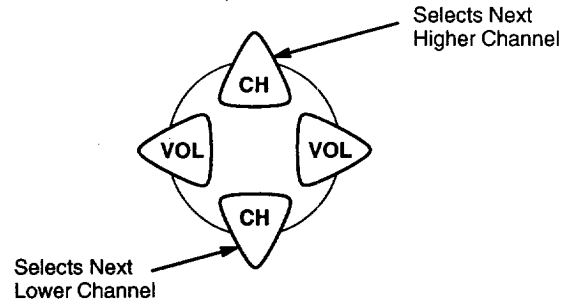

Option 2.

Press two digits on keyboard (Example press 0, then 5 for channel 05). For channels over 99, press three digits on keyboard.

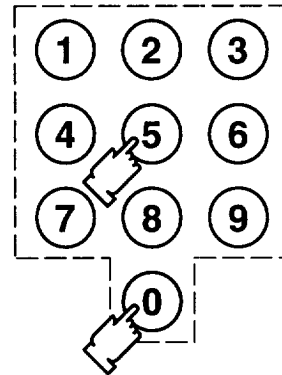

TV/Video Button — Press the TV/VIDEO button to select desired input.



Signal connected to:

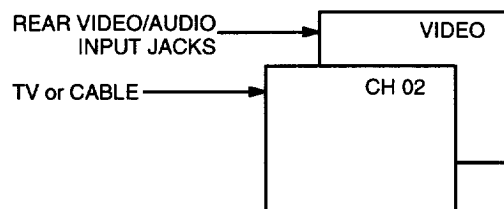

Helpful Hints:

- Helpful information will display On Screen momentarily when Receiver is first turned on and when the channel is changed.
- When using keyboard entry for channels 10,11 and 12 in the CABLE mode there is a slight delay before channel change because of the capability of tuning cable channels 100 to 125.
- If you do not receive channels above 13, confirm the type of signal at ANT Input (TV or Cable) and set the TV or Cable Tuning Mode accordingly. (Refer to Set-Up Feature, Antenna selection.)

Recall Button – Press the RECALL button to review:

- CH number selected or Video Input selected
- Sleep Timer status
- Clock Time
- Channel Caption (Station Identifier)

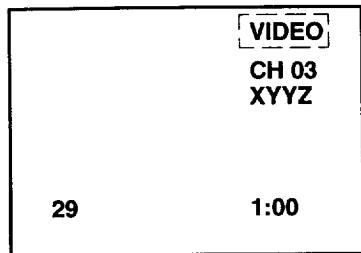

R-Tune (Rapid Tune) Button – Press the R-TUNE (RAPID TUNE) button to instantly switch between the last two channels selected (without any On Screen display being activated).

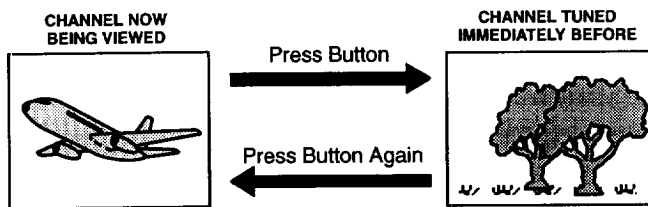

Skip Button – Press the SKIP button repeatedly to set the Skip Timer for a desired length of time up to 3 minutes. Then select any other channel or Video mode. When the set time elapses the original channel will return.

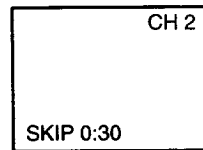

SET SKIP TIMER WHILE WATCHING CHANNEL 2

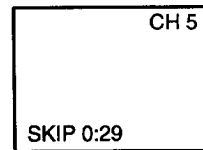

CHANGE CHANNELS, TIMER STARTS TO COUNT DOWN

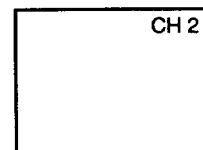

ORIGINAL CHANNEL RETURNS WHEN SET TIME ELAPSES

Sleep Button – Press the SLEEP button repeatedly for automatic turn OFF in 30, 60 or 90 minutes as desired. Sleep Timer clock will flash prior to automatic turn OFF.

NOTE: Display will flash 3, 2 and 1 to indicate the last three remaining minutes prior to turn OFF. To deactivate, press the Sleep button continuously until the display reads "0".

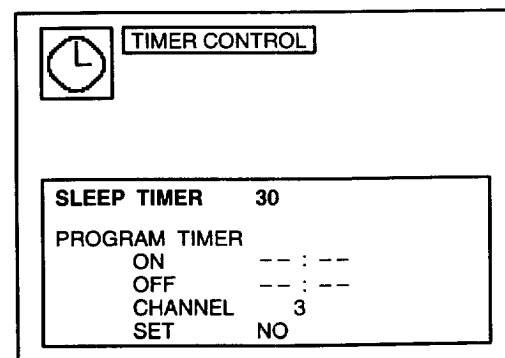

Main Menu (Icons)

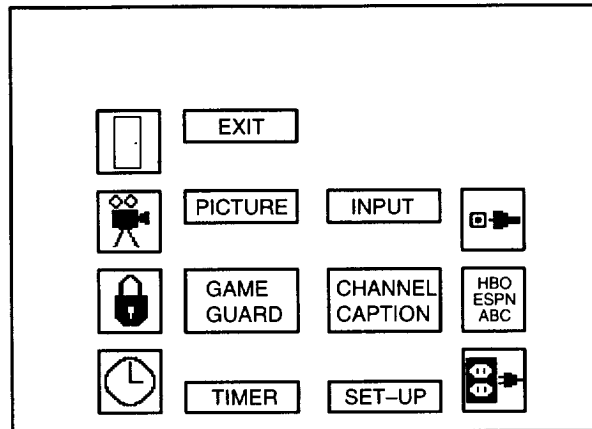

ACTION



Displays and Exits Menu

Located On Remote Control

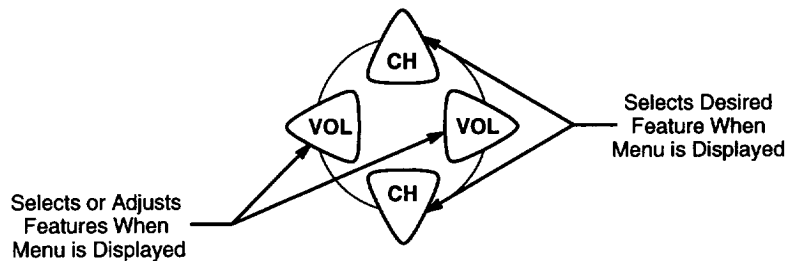

1. Press the ACTION button to display the Main Menu with Icons.
2. Press the CH UP or DOWN and the VOL LEFT or RIGHT buttons to select the desired Icon when the Main Menu is displayed (selected Icon will be indicated in Red).
3. Press the VOL buttons for left and right movement and the CH buttons for up or down movement.
4. To exit the Main Menu first select the EXIT Icon, then press the ACTION button.

The Language Menu is factory set to ENGLISH. Follow these instructions to change the Language Menu to Spanish and back to English.

1. Press the ACTION button to display the Main Menu.
2. Press the CH DOWN and VOL RIGHT buttons to select the SET-UP Icon.

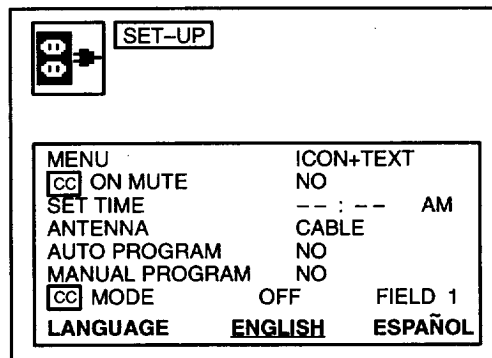

3. Press the ACTION button to display the SET-UP Menu.
4. Press the CH DOWN button to select "LANGUAGE".
5. Press the VOL LEFT or RIGHT button to highlight ENGLISH or ESPAÑOL. The selected mode will be underlined.
6. Press the ACTION button twice to exit SET-UP Menu.

Picture Adjustments

- Color
- Tint
- Brightness
- Picture
- Sharpness
- Picture Norm



Displays and Exits Menus

Located On Remote Control

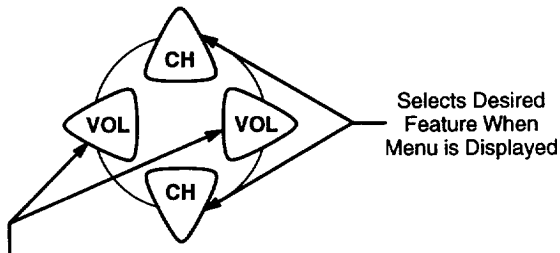

Selects or Adjusts Features When Menu is Displayed

Selects Desired Feature When Menu is Displayed

Color, Tint, Brightness, Picture & Sharpness Adjustments

1. Press the ACTION button to display the Main Menu.
2. Press the CH DOWN button to select the Picture Icon.
3. Press the ACTION button to display the Picture Adjustment menu.

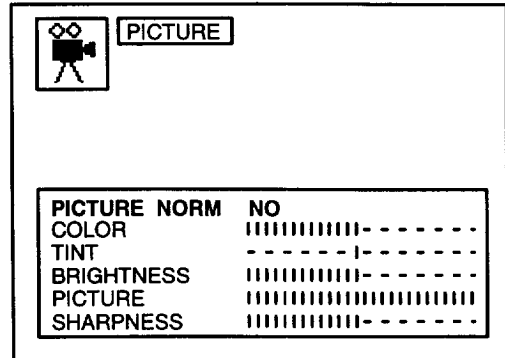

4. Press the CH UP or DOWN button to select the desired Picture Adjustment (Color, Tint, Brightness, Picture or Sharpness).
5. Press the VOL LEFT or RIGHT button to adjust your selection. (The Selected Picture Adjustment will be displayed.)
6. Repeat steps 4 and 5 for the remaining Picture Adjustments.
7. Press the ACTION button twice to exit the Picture Adjustment menu.

Picture Norm – This feature is used to reset Color, Tint, Brightness, Picture and Sharpness back to a factory preset level.

1. Press the ACTION button to display the Main Menu.
2. Press the CH DOWN button to select the Picture Icon.
3. Press the ACTION button to display the Picture Adjustment Menu.

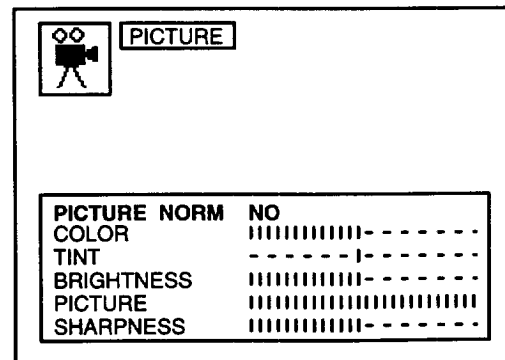

4. Press the VOL LEFT or RIGHT button to select "SET" to Normalize Color, Tint, Brightness, Picture and Sharpness.
5. Press the ACTION button twice to exit the Picture Adjustment Menu.

Helpful Hints:

Picture Adjustments:

COLOR – adjust for desired color intensity.

TINT – adjust for natural flesh tones.

BRIGHTNESS – adjust so dark areas of picture just become black for a crisp detail.

PICTURE – adjust so the white areas of the picture are to your liking.

SHARPNESS – adjust for best clarity of outline detail.

Game Guard

ACTION



Displays and Exits Menus

Located On Remote Control

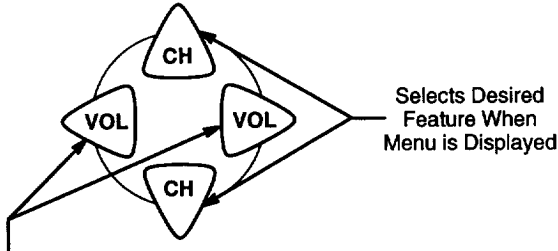

Selects or Adjusts Features When Menu is Displayed

Selects Desired Feature When Menu is Displayed

Game Guard (Lockout) – Prevents video games and other video sources from being viewed. Channel 3, 4, and Video Inputs are locked out for 12, 24 or 48 hours.

NOTE: Be sure to understand this feature before attempting its use. **Use a code that you will easily remember.**

1. Press the ACTION button to display the Main Menu.
2. Press the CH DOWN button to select the Game Guard Icon.
3. Press the ACTION button to display the Game Guard Menu.

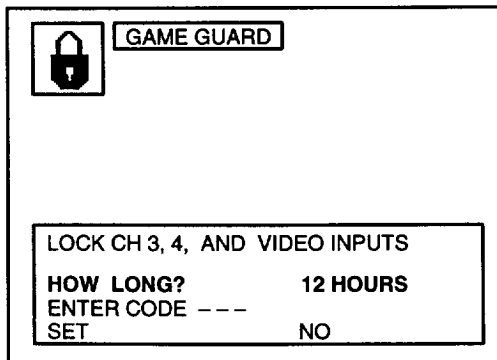

4. Press the VOL RIGHT button to select the desired hours (12, 24 or 48) for Game Guard (Lockout) to be activated.
5. Press the CH DOWN button to select "ENTER CODE". Then enter a 3 digit code with the Remote Control Keyboard.

IMPORTANT NOTE: Use a code you can easily remember.

6. Press the VOL LEFT or RIGHT button after entering three digit code. "Game Guard Locked" will display On Screen.

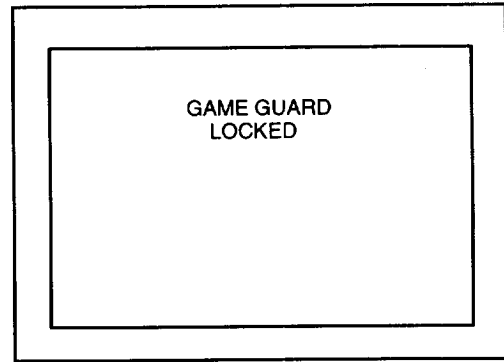

Game Guard Activated

Game Guard (Unlock)

To unlock the Game Guard feature, repeat steps 1 through 3. Enter the same 3 digit code previously used in step 5 with Remote Control Keyboard.

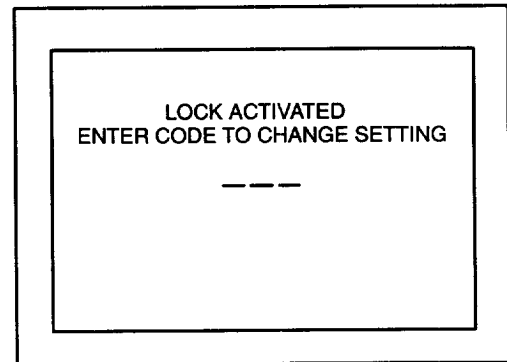

Enter Same 3 Digit Code Previously Used

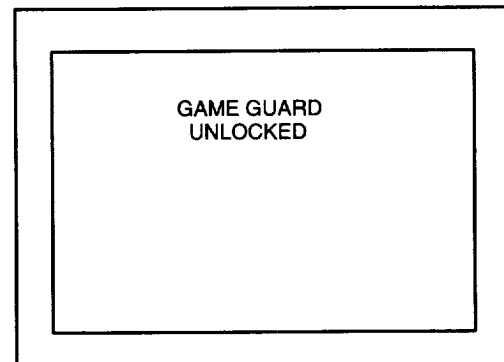

If 3 Digit Code Is The Same

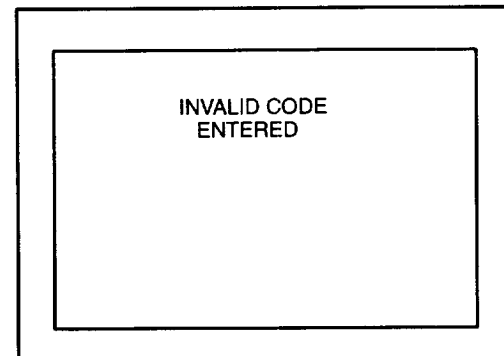

If 3 Digit Code Is Not The Same

Timer Features

- Sleep Timer
- Program Timer



Displays and Exits Menus

Located On Remote Control

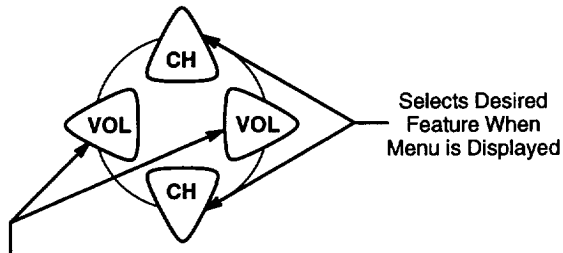

Selects or Adjusts Features When Menu is Displayed

Selects Desired Feature When Menu is Displayed

Sleep Timer – This feature is used for automatic turn off in 30, 60 or 90 minutes.

NOTE: Display will flash 3, 2 and 1 to indicate the last three remaining minutes prior to turn off. The Recall display will also appear.

1. Press the ACTION button to display the Main Menu.
2. Press the CH DOWN button to select the Timer Icon.
3. Press the ACTION button to display the Timer Control Menu.

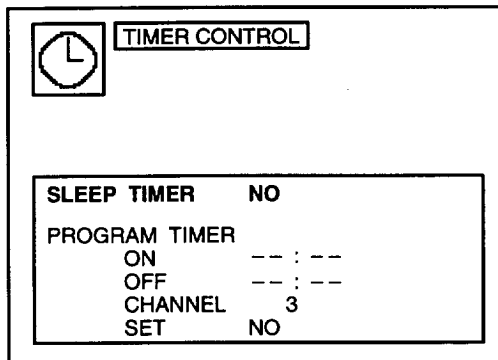

4. Press the VOL RIGHT button to select 30, 60 or 90 minutes (Sleep Timer will be activated).
5. Press the ACTION button twice to exit the Timer Control Menu.

NOTE: To deactivate Sleep Timer repeat steps 1 through 4. In step 4 select “NO” instead of minutes.

Program Timer – This feature is capable of turning the TV on, tuned to a desired channel and off at a predetermined time (one day or everyday).

NOTE: The clock must be set for this feature to operate. (Refer to the Set-Up Menu to set time.)

1. Press the ACTION button to display the Main Menu.
2. Press the CH DOWN button to select the Timer Icon.
3. Press the ACTION button to display the Timer Control Menu.

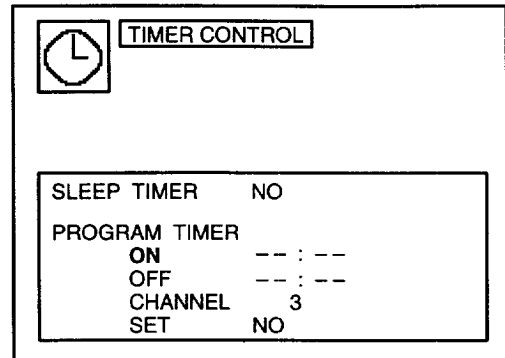

4. Press the CH DOWN button to select “ON” (time).
5. Press the VOL LEFT or RIGHT button repeatedly to set hours (set AM/PM accordingly).
6. Press the CH DOWN button to select the minutes position.
7. Press the VOL LEFT or RIGHT button repeatedly to set minutes.
8. Press the CH DOWN button to select “OFF” (time).
9. Repeat steps 5 through 7 for setting “OFF” (time).
10. Press the CH DOWN button to select “CHANNEL”.
11. Press the VOL LEFT or RIGHT button or use the Remote Control Keyboard to enter the channel number desired when the set turns “ON”.
12. Press the CH DOWN button to select “SET”.
13. Press the VOL RIGHT button to select:
 - NO – not activated
 - ONE DAY – activated
 - EVERY DAY – activated
- NOTE:** To deactivate Program Timer select “NO” in step 13.
14. Press the ACTION button twice to exit the Timer Control Menu.

Helpful Hints:

- If you see “GAME GUARD” in the upper right hand corner, the channel you have selected has been locked out.
- If the Program Timer “ON” functions while the set is operating, the set will automatically tune to the channel designated in the Timer Program.

Set-Up Features

- Menu
- CC (Closed Caption) on Mute
- Set Time
- Antenna (TV or Cable)
- Auto Program
- Manual Program
- CC (Closed Caption) Mode
- Language (English/Español)



Displays and Exits Menus

Located On Remote Control

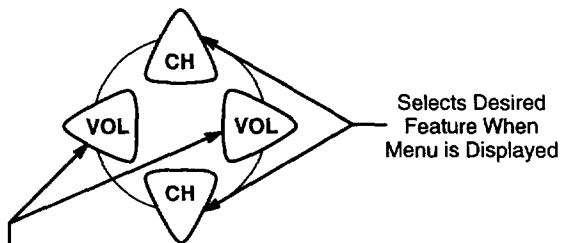

Selects Desired Feature When Menu is Displayed

Selects or Adjusts Features When Menu is Displayed

Menu – The Main Menu can be displayed in two formats. Icon with Text or Icon without Text for those familiar with the Icon system.

1. Press the ACTION button to display the Main Menu.
2. Press the CH DOWN and VOL RIGHT buttons to select the Set-Up Icon.
3. Press the ACTION button to display the Set-Up Menu.

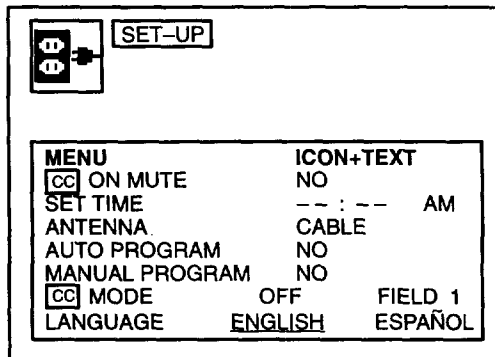

4. Press the VOL LEFT or RIGHT button to select "ICON with TEXT" or "ICON" only.
5. Press the ACTION button twice to exit Set-Up Menu.

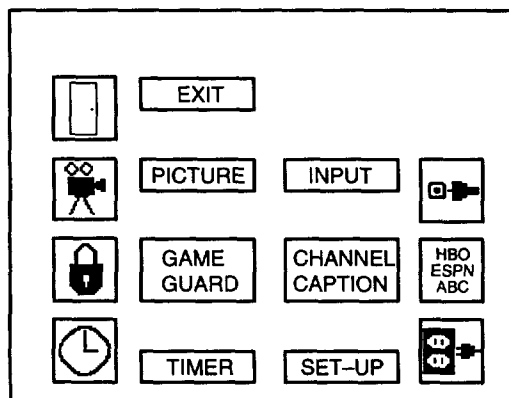

Icon with Text

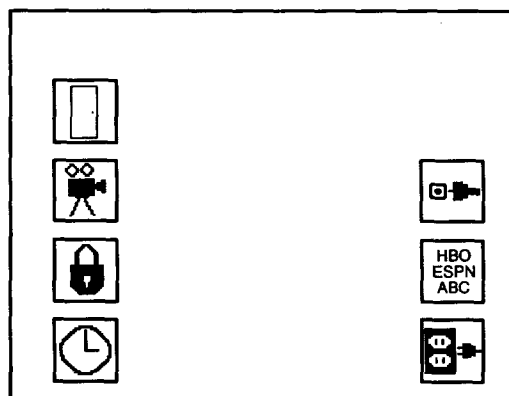

Icon (Only)

CC On Mute



Displays and Exits Menus

Located On Remote Control

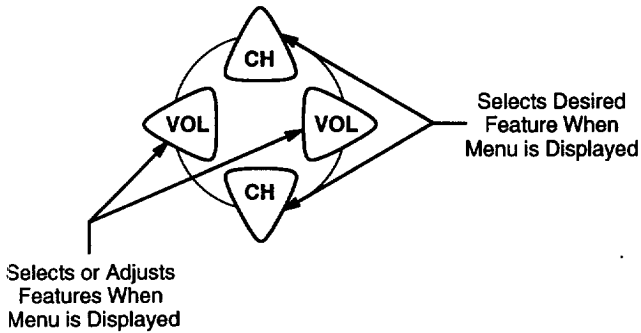

Closed Caption with Mute Button

Activates the On Screen Closed Captioning when the MUTE button on the Remote Control is pressed. To deactivate press the MUTE button again.

NOTE: This feature only functions when the Close Caption Mode is in the "OFF" position. The program being viewed must be broadcast with Closed Caption. (Refer to your local TV guide.)

1. Press the ACTION button to display the Main Menu.
2. Press the CH DOWN and VOL RIGHT buttons to select the Set-Up Icon.
3. Press the ACTION button to display the Set-Up Menu.

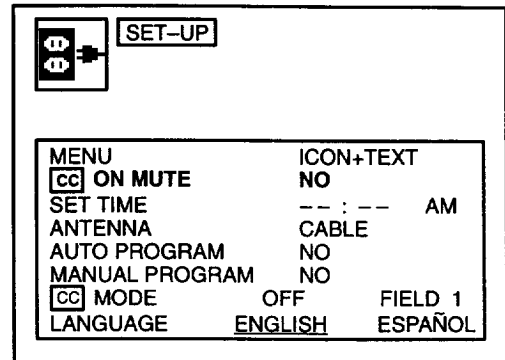

4. Press the CH DOWN button to select "CC ON MUTE".
5. Press the VOL LEFT or RIGHT button to select NO (OFF), CAP C1 or CAP C2.

Recommended Set-Up:

1. Place CC ON MUTE into the CAP C1 Mode.
2. Press the CH DOWN button to select "CC MODE".
3. Press the VOL RIGHT button to select "OFF".
4. Press the CH DOWN button to select the Field position.
5. Press the VOL LEFT or RIGHT button to select "FIELD 1".

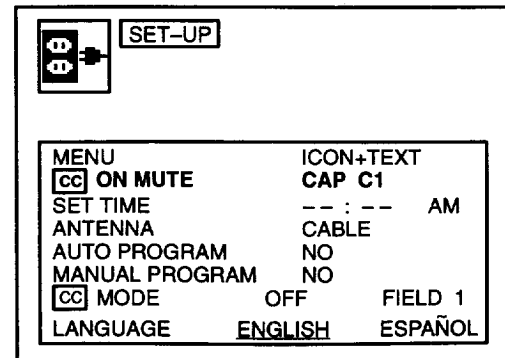

6. Press the ACTION button twice to exit Set-Up Menu.
7. Press the MUTE button when the program being viewed is broadcast with Closed Caption to activate. Press again to deactivate.

Set Time (Clock)

ACTION



Displays and Exits Menus

Located On Remote Control

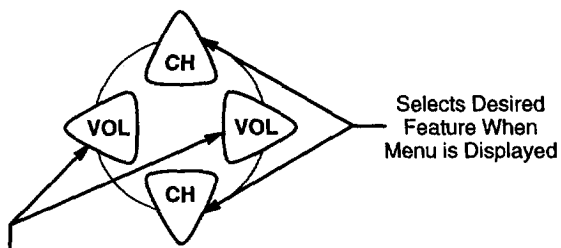

Selects or Adjusts Features When Menu is Displayed

Selects Desired Feature When Menu is Displayed

Set Time – Clock (when set) will display on screen at initial “Turn On”, after a channel change and when pressing the RECALL button. The time must be set first in order to operate the Program ON/OFF Timer.

1. Press the ACTION button to display the Main Menu.
2. Press the CH DOWN and VOL RIGHT buttons to select the Set-Up Icon.
3. Press the ACTION button to display the Set-Up Menu.

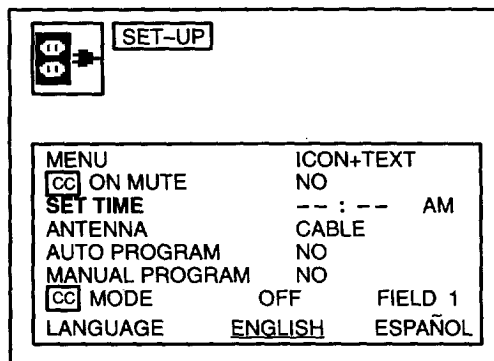

4. Press the CH DOWN button to select “SET TIME”.
5. Press the VOL LEFT or RIGHT button to set hours (set AM/PM accordingly).
6. Press the CH DOWN button to select minutes position.
7. Press the VOL LEFT or RIGHT button repeatedly to set minutes.
8. Press the ACTION button twice to exit Set-Up Menu.

Antenna Mode

ACTION



Displays and Exits Menus

Located On Remote Control

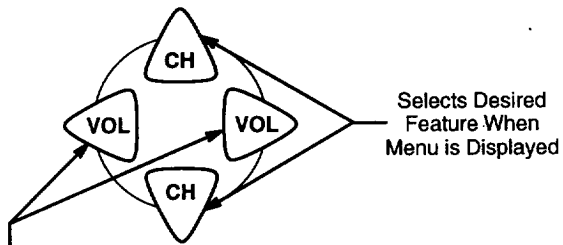

Selects or Adjusts Features When Menu is Displayed

Selects Desired Feature When Menu is Displayed

TV or Cable Tuning Mode – The proper Input mode must be selected for the type of signal at the antenna input.

- TV mode is used when the Receiver is not connected to a cable TV system, for example when using a VHF/UHF antenna (channels 02 – 69).
 - Cable mode is used when the Receiver is connected to a Cable TV system and you are not using a cable company converter box (channels 01 – 125).
1. Press the ACTION button to display the Main Menu.
 2. Press the CH DOWN and VOL RIGHT buttons to select the Set-Up Icon.
 3. Press the ACTION button to display the Set-Up Menu.

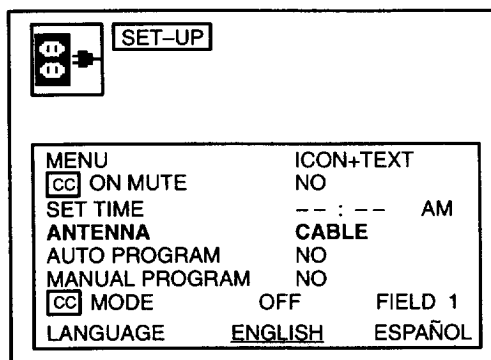

4. Press the CH DOWN button to select "ANTENNA".
5. Press the VOL LEFT or RIGHT button to select TV or CABLE.
6. Press the ACTION button twice to exit Set-Up Menu.

Auto Program

ACTION



Displays and Exits Menu

Located On Remote Control

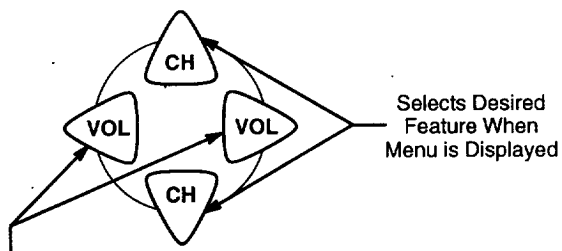

Selects or Adjusts Features When Menu is Displayed

Selects Desired Feature When Menu is Displayed

Auto Programming – This feature allows you to place all channels with a video signal into Channel Scan Memory. Press the CHANNEL (CH) UP or DOWN button and only those channels with a signal will be accessed.

1. Press the ACTION button to display the Main Menu.
2. Press the CH DOWN and VOL RIGHT buttons to select the Set-Up Icon.
3. Press the ACTION button to display the Set-Up Menu.

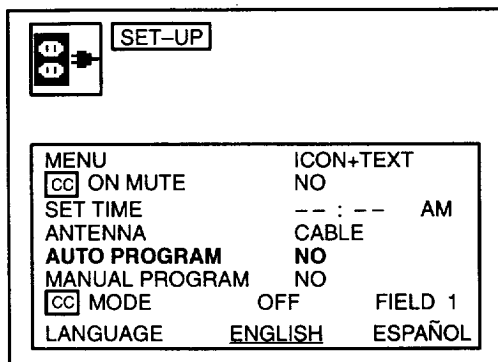

4. Press the CH DOWN button to select "AUTO PROGRAM".
5. Press the VOL LEFT or RIGHT button to start Auto Programming. Channels will automatically advance until all channels have been scanned.
6. Press the ACTION button twice after completion of Auto Programming to exit Set-Up Menu.

NOTE: Channel numbers with signal present will turn blue which indicates stored in Channel Scan Memory.

Manual Programming – This feature allows you to select which channels are placed into Channel Scan Memory. Press the CHANNEL (CH) UP or DOWN button and only those channels will be accessed.

1. Press the ACTION button to display the Main Menu.
2. Press the CH DOWN and VOL RIGHT buttons to select the Set-Up Icon.
3. Press the ACTION button to display the Set-Up Menu.

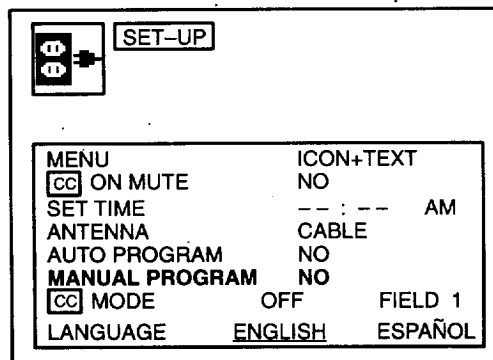

4. Press the CH DOWN button to select "MANUAL PROGRAM".
5. Press the VOL LEFT or RIGHT button to display the Manual Programming Menu.

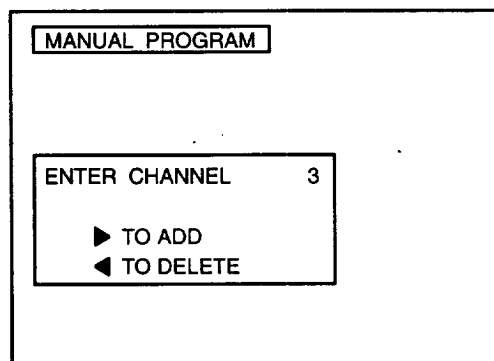

6. Use the CH UP or DOWN button or the Remote Keyboard "0 through 9" buttons to select channels.
7. Press the VOL RIGHT button to add channel(s) to memory (Blue). Press the VOL LEFT button to delete channels from memory (Yellow).
8. Repeat steps 6 and 7 to continue adding or deleting channels.
9. Press the ACTION button twice to exit the Manual Programming Menu.

CC Mode

ACTION



Displays and Exits Menu

Located On Remote Control

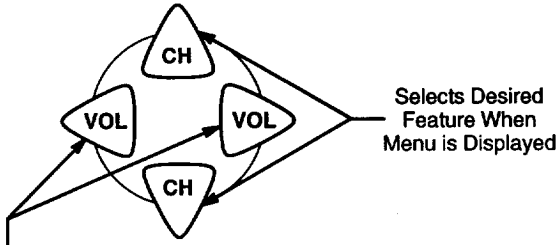

Selects Desired Feature When Menu is Displayed

Selects or Adjusts Features When Menu is Displayed

Closed Caption Mode

This Receiver has a built in decoder that provides a visual depiction of the audio portion of a television program in the form of written words across the screen (White or Colored letters on a black background). It allows the viewer to read the dialogue of a television program or other information.

1. Press the ACTION button to display the Main Menu.
2. Press the CH DOWN and VOL RIGHT buttons to select the Set-Up Icon.
3. Press the ACTION button to display the Set-Up Menu.

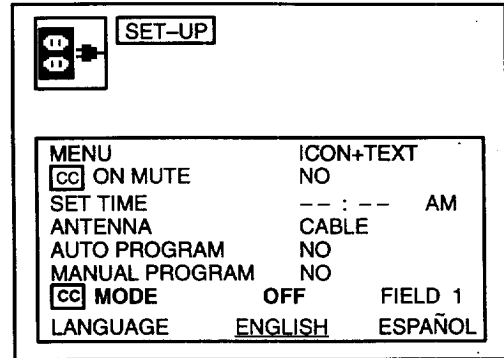

4. Press the CH DOWN button to select "CC MODE".
 5. Press the VOL LEFT or RIGHT button to select OFF, CAP C1, TEXT C1, CAP C2 or TEXT C2.
 6. Press the CH DOWN button to select the Field position.
 7. Press the VOL LEFT or RIGHT button to select "FIELD 1" or "FIELD 2".
 8. Press the ACTION button twice to exit the Set-Up Menu.
- CAPTION OFF – Recommended mode when you do not wish to view Closed Caption.
 - CAPTION C1 – For video related information that can be displayed (up to 4 lines of script strategically placed on the television screen so that it does not obstruct relevant parts of the picture). Script can be in any language.
 - TEXT C1 – Blanks out a large portion of the picture on the television screen, and displays program guide or any other information currently being transmitted.
 - CAPTION C2 – Another mode used for video related information that can be displayed (up to 4 lines of script strategically placed on the television screen so that it does not obstruct relevant parts of the picture).
 - TEXT C2 – Another mode which displays information and blanks out a large portion of the picture on the television screen.

Helpful Hints:

- Closed Caption information may be transmitted on either or both Caption Fields.
- Most Closed Caption information is transmitted on Field 1 in Cap C1 Mode.
- De-select Text mode if large portion of the picture is blanked out.

2 Language Menu System

ACTION



Displays and Exits Menus

Located On Remote Control

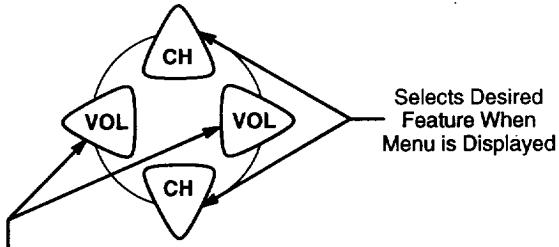

Selects or Adjusts Features When Menu is Displayed

Selects Desired Feature When Menu is Displayed

Icon Language Selection English or Spanish

The Language Menu is factory set to ENGLISH. Follow these instructions to change the Language Menu to Spanish and back to English.

1. Press the ACTION button to display the Main Menu.
2. Press the CH DOWN and VOL RIGHT buttons to select SET-UP Icon.
3. Press the ACTION button to display the SET-UP Menu.

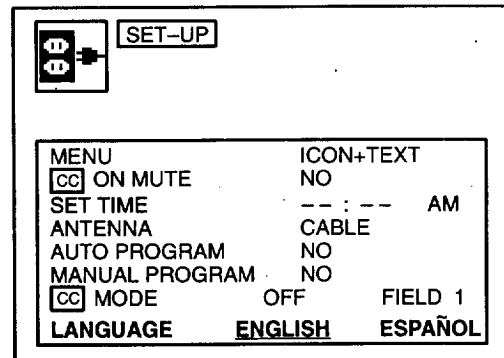

4. Press the CH DOWN button to select "LANGUAGE".
5. Press the VOL LEFT or RIGHT button to highlight ENGLISH or ESPAÑOL. The selected mode will be underlined.
6. Press the ACTION button twice to exit SET-UP Menu.

Helpful Hints:

Language Menu does not affect Close Caption or other transmitted text information.

Channel Caption

ACTION



Displays and Exits Menus

Located On Remote Control

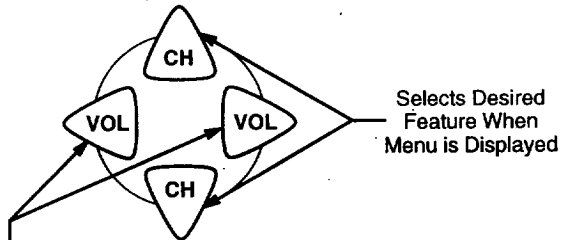

Selects or Adjusts Features When Menu is Displayed

Channel Caption (Station Identifier)

This feature allows you to enter the call names of up to 30 stations into memory (using up to 4 characters for each station). The call name will then display along with the channel number when changing channels or pressing RECALL.

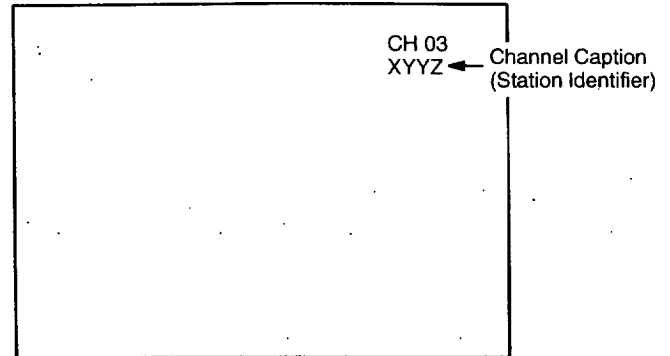

1. Press the ACTION button to display the Main Menu.
2. Press the CH DOWN and VOL RIGHT buttons to select the "Channel Caption" Icon.
3. Press the ACTION button to display the Channel Caption Menu.

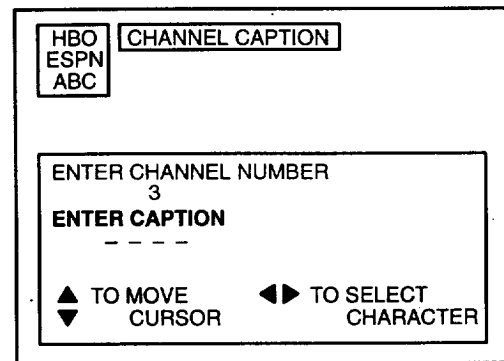

4. Press the VOL LEFT or RIGHT button, or use the Remote Control Keyboard, to enter channel number you wish to assign a Station Identifier.
5. Press the CH DOWN button to select "ENTER CAPTION".
6. Press the VOL LEFT or RIGHT button to select first character in Station Identifier. Then press the CH DOWN button to move cursor to the second position and repeat until the complete Station Identifier is entered (up to 4 characters).
7. Press the CH UP or DOWN button to select "ENTER CHANNEL NUMBER". Then repeat steps 4 through 6 to continue adding Channel Station Identifier(s).
8. Press the ACTION button twice to exit the Channel Caption Menu.

NOTE: To delete a Channel Caption (Station Identifier) from memory all four character positions must display dash mark (-).

Helpful Hints:

When the maximum amount of station identifiers are entered, "FULL" will be displayed in the characters position.

Video Input



Displays and Exits Menu

Located On Remote Control

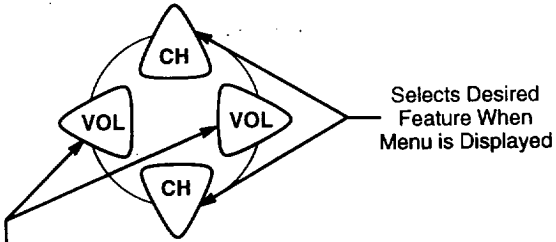

Selects or Adjusts Features When Menu is Displayed

Selects Desired Feature When Menu is Displayed

Video Input – This feature is used to select TV or Video Input.

1. Press the ACTION button to display the Main Menu.
2. Press the VOL RIGHT button to select the Input Icon.
3. Press the ACTION button to display the Input Select Menu.

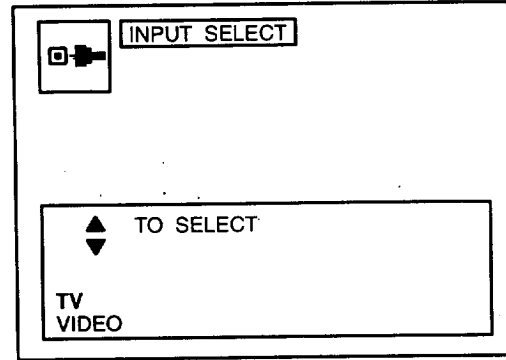

4. Press the CH UP or DOWN button to select "TV" or "VIDEO".

NOTE: The Game Guard feature must be deactivated before selecting Video Input.

Optional Equipment Connection and Operation

Video/Audio Connection

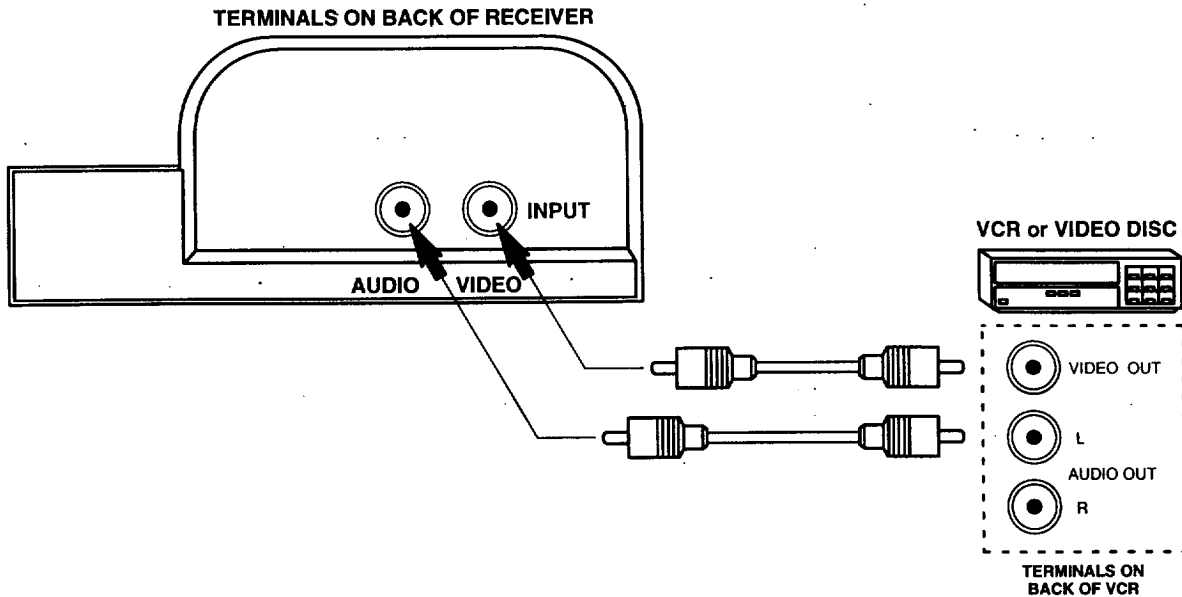



















Operation

1. Connect optional equipment as shown to INPUT.
2. Select the Video mode by pressing the TV/VIDEO button (or refer to the Input Selection Menu).
3. Operate optional equipment (VCR-VDP) as instructed in Optional Equipment manual.

Troubleshooting Chart

Before you call for service, determine the symptoms and make a few simple checks shown below.

Symptoms		Check
Picture	Sound	
 SNOWY PICTURE	 NOISY SOUND	- ANTENNA LOCATION AND/OR CONNECTION
 MULTIPLE IMAGE	 NORMAL SOUND	- ANTENNA DIRECTION AND/OR LOCATION - ANTENNA LEAD-IN WIRE
 INTERFERENCE	 NOISY SOUND	- ELECTRICAL APPLIANCES, LIGHTS, CARS AND TRUCKS - DIATHERMY AND OTHER MEDICAL EQUIPMENT
 NORMAL PICTURE	 NO SOUND	- VOLUME CONTROL SETTING - MUTE CONTROL (IF APPLICABLE) - TRY ANOTHER CHANNEL - TV SPEAKERS (IF APPLICABLE) IN THE OFF MODE
 NO VIDEO	 NOISY SOUND	- TV OR CABLE TUNING MODE SET TO PROPER SETTING - ANTENNA INPUT CORRECT (IF APPLICABLE)
 NO PICTURE	 NO SOUND	- CHECK THAT AC POWER LINE IS PLUGGED INTO AC OUTLET - BRIGHTNESS & AUDIO CONTROLS SET PROPERLY - TRY ANOTHER CHANNEL
 NO COLOR	 NORMAL SOUND	- COLOR CONTROL SETTINGS - TRY ANOTHER CHANNEL
 BLUE PICTURE	 NO SOUND	- RECEIVER IN VIDEO MODE WITH NO SIGNAL (IF APPLICABLE)
 BLACK BOX IN PICTURE	 SOUND	- CC (CLOSED CAPTION) IN TEXT MODE - SELECT CAPTION OFF MODE TO ELIMINATE BLACK BOX

Should this unit turn ON momentarily and then turn OFF, or fail to operate, unplug the AC cord and contact your Authorized Servicer for repairs.

Power Loss

Prolonged power interruption causes the following features to reset to their factory preset state.

FEATURE	FACTORY PRESET STATE	FEATURE	FACTORY PRESET STATE
POWER CLOCK	OFF NOT SET	SLEEP TIMER	OFF TIMER

Matsushita Consumer Electronics
Company, Division of Matsushita
Electric Corporation of America
One Panasonic Way
Secaucus, New Jersey 07094

Matsushita Electric of Canada Limited
5770 Ambler Drive
Mississauga, Ontario L4W 2T3
Canada

Panasonic Sales Company,
Division of Matsushita Electric
of Puerto Rico Inc. ("PSC")
Ave. 65 de Infanteria, Km 9.5
San Gabriel Industrial Park
Carolina, Puerto Rico 00985
Tel. (809) 750-4300
FAX. (809) 768-2910