

---

# Color Television

## Operating Instructions

Panasonic®

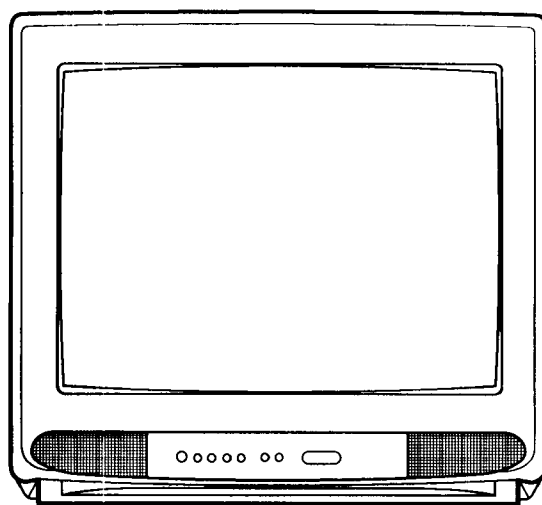

**CT-27G21**

Read these instructions completely before operating this set.  
Contents subject to change without notice or obligation.

Copyright 1996 by Matsushita Electric Corporation of America.  
All rights reserved. Unauthorized copying and distribution is a violation of law.

PRINTED IN MEXICO  
TQB2AA0040-1

# Safety Instructions

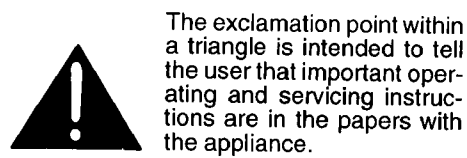
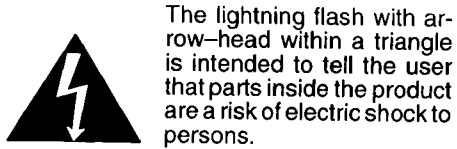
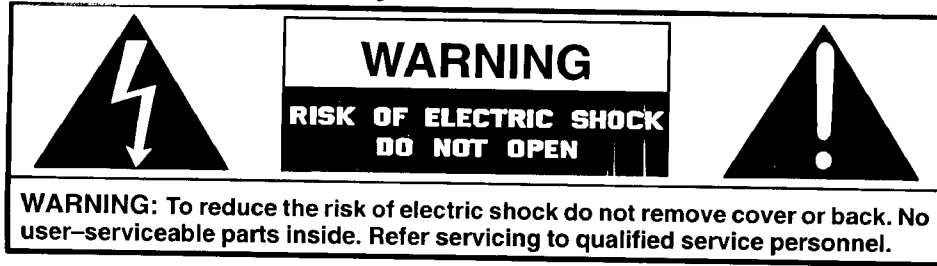

**Note To CATV System Installer:** This reminder is provided to call the CATV system installer's attention to Article 820-40 of the NEC that provides guidelines for proper grounding and, in particular, specifies that the cable ground shall be connected to the grounding system of the building, as close to the point of cable entry as practical.

## Safety Instructions For Television Receivers

1. Read and apply the operating instructions provided with your television receiver.
2. Read all of the instructions given here and retain them for later use.
3. Unplug this television receiver from the wall outlet before cleaning. Do not use liquid or aerosol cleaners. Use a damp cloth for cleaning.
4. Do not use attachments not recommended by the television receiver manufacturer as they may cause hazards.
5. Do not use this television receiver near water. For example: Avoid placing it near a bathtub, washbowl, kitchen sink, or laundry tub, in a wet basement, or near a swimming pool, etc.
6. Do not place this television receiver on an unstable cart, stand, or table. The television receiver may fall, causing serious injury to a child or adult, and serious damage to the appliance. Use only with a cart or stand recommended by the manufacturer, or sold with the television receiver. Wall or shelf mounting should follow the manufacturer's instructions, and should use a mounting kit approved by the manufacturer.
- 6A. An appliance and cart combination should be moved with care. Quick stops, excessive force, and uneven surfaces may cause the appliance and cart combination to overturn.
7. Slots and openings in the cabinet and the back or bottom are provided for ventilation, and to insure reliable operation of the television receiver and to protect it from overheating. These openings must not be blocked or covered. The openings should never be blocked by placing the television receiver on a bed, sofa, rug or other similar surface. This television receiver should never be placed near or over a radiator or heat register. This television receiver should not be placed in a built-in installation such as a bookcase unless proper ventilation is provided.
8. Operate only from the type of power source indicated on the marking label. If you are not sure of the type of power supplied to your home consult your television dealer or local power company. For television receivers designed to operate from battery power, refer to the operating instructions.
9. This television receiver is equipped with a polarized alternating-current line plug (a plug having one blade wider than the other). This plug will fit into the power outlet only one way. This is a safety feature. If you are unable to insert the plug fully into the outlet, try reversing the plug. If the plug should still fail to fit, contact your electrician to replace your obsolete outlet. Do not defeat the safety purpose of the polarized plug.
10. Do not allow anything to rest on the power cord. Do not locate this television receiver where the cord will be abused by persons walking on it.
11. Follow all warnings and instructions marked on the television receiver.
12. Do not overload wall outlets and extension cords as this can result in fire or electric shock.
13. Never push objects of any kind into this television receiver through cabinet slots as they may touch dangerous voltage points or short out parts that could result in a fire or electric shock. Never spill liquid of any kind on the television receiver.

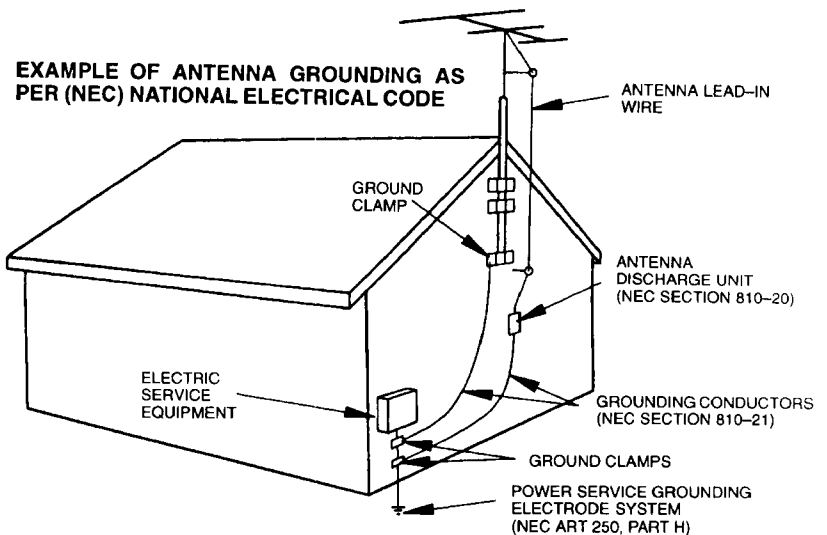

14. If an outside antenna is connected to the television equipment, be sure the antenna system is grounded so as to provide some protection against voltage surges and built up static charges. In the U.S. Section 810 of the National Electrical Code and in Canada Part 1 of the Canadian Electrical Code provides information with respect to proper grounding of the mast and supporting structure, grounding of the lead-in wire to an antenna discharge unit, size of grounding conductors, location of antenna-discharge unit, connection to grounding electrodes, and requirements for the grounding electrode. See Figure.
  15. For added protection for this television receiver during a lightning storm, or when it is left unattended and unused for long periods of time, unplug it from the wall outlet and disconnect the antenna. This will prevent damage to the receiver due to lightning and power-line surges.
  16. An outside antenna system should not be located in the vicinity of overhead power lines or other electric light or power circuits, or where it can fall into such power lines or circuits. When installing an outside antenna system extreme care should be taken to keep from touching such power lines or circuits as contact with them might be fatal.
  17. Unplug this television receiver from the wall outlet, and refer servicing to qualified service personnel under the following conditions:
    - a. When the power cord or plug is damaged or frayed.
    - b. If liquid has been spilled into the television receiver.
    - c. If the television receiver has been exposed to rain or water.
    - d. If the television receiver does not operate normally by following the operating instructions. Adjust only those controls that are covered by the operating instructions as improper adjustment of other controls may result in damage and will often require extensive work by a qualified technician to restore the television receiver to normal operation.
    - e. If the television receiver has been dropped or the cabinet has been damaged.
    - f. When the television receiver exhibits a distinct change in performance – this indicates a need for service.
  18. Do not attempt to service this television receiver yourself as opening or removing covers may expose you to dangerous voltage or other hazards. Refer all servicing to qualified service personnel.
  19. When replacement parts are required, be sure the service technician has used replacement parts specified by the manufacturer that have the same characteristics as the original part. Unauthorized substitutions may result in fire, electric shock, or other hazards.
  20. Upon completion of any service or repairs to this television receiver, ask the service technician to perform routine safety checks to determine that the television is in safe operating condition.
  21. **WARNING: To prevent fire or shock hazard, do not expose this appliance to rain or moisture.**
  22. **CAUTION: TO PREVENT ELECTRIC SHOCK DO NOT USE THIS (POLARIZED) PLUG WITH AN RECEPTACLE OR OTHER OUTLET UNLESS THE BLADES CAN BE FULLY INSERTED TO PREVENT BLADE EXPOSURE.**
- NOTE:** This equipment is designed to operate in the U.S.A., Canada and other countries where the broadcasting system and AC house current is exactly the same as in the U.S.A. and Canada.

**Important Information Regarding Use of Video Games, Computers, Teletext or Other Fixed Image Displays.**

The extended use of fixed image program material can cause a permanent "shadow image" on the picture tube. This background image is viewable on normal programs in the form of a stationary fixed image. This type of irreversible picture tube deterioration can be limited by observing the following steps:

- A. Reduce the brightness/contrast setting to a minimum viewing level.
- B. Do not display the fixed image for extended periods of time.
- C. Turn the power off when not in actual use.

**NOTE:** The marking or retained image on the picture tube resulting from fixed image use is not an operating defect and as such is not covered by Warranty. This product is not designed to display fixed image patterns for extended periods of time.

## Specifications

<b>Power Source:</b>	120V, 60Hz, AC
<b>Channel Capability:</b>	181 channels (See chart) VHF 2~13, UHF 14~69, Cable 125 channels
<b>Video Input Jack:</b>	1V p-p, 75 ohm, phono jack type
<b>Audio Input Jacks:</b>	High impedance – 10K ohm, 500mV rms
<b>To Audio AMP Jacks:</b>	0~4.0V rms 10K ohm
<b>Stereo Sound</b>	
<b>Closed Caption Display</b>	
<b>Picture in Picture:</b>	1 Tuner

## Channel Capability Chart

BAND	USA/CAN
VHF	12
UHF	56
CABLE (Mid-Band)	15
CABLE (Super Band)	14
CABLE (Hyper Band)	28
CABLE (Ultra Band)	56
<b>TOTAL CHANNELS</b>	<b>181</b>

Specifications are subject to change without notice or obligation.

# Introduction

## Congratulations on Your New Purchase

Your new video component features an all solid state chassis which is designed to give you many years of enjoyment. It was thoroughly tested and adjusted at the factory for best performance.

In order for you to take full advantage of your new video component, please read and follow the installation and operating instructions supplied with this product.

### Customer's Record

The model and serial number of this product may be found on its back cover. You should note the model and serial number in the space provided and retain this book as a permanent record of your purchase to aid in identification in the event of theft or loss.

Model Number: \_\_\_\_\_ Serial Number: \_\_\_\_\_

## Table of Contents

<b>Safety Instructions</b> .....	2	Move Button .....	17
<b>Specifications</b> .....	3	<b>Main Menu (Icons)</b> .....	18
<b>Introduction</b> .....	4	Picture Adjustments .....	19
<b>Care and Cleaning</b> .....	5	Picture Norm .....	19
<b>Installation</b> .....	6	Color .....	19
Receiver Location .....	6	Tint .....	19
Optional External Equipment Connections .....	6	Brightness .....	19
AC Power Supply Cord .....	6	Picture .....	19
Remote Control Battery Installation .....	6	Sharpness .....	19
Antenna/Cable Connections .....	7	Audio Adjustments .....	20
PIP External Video and Antenna Connection .....	8	Mode (Stereo/SAP/Mono) .....	20
<b>Optional Equipment Connection and Operation</b> ..	9	AI Sound .....	21
To Audio AMP Connection (stereo) .....	9	Lock .....	22
Video/Audio Connection .....	9	Lock Game Guard .....	22
<b>Location of Controls (Receiver)</b> .....	10	Unlock Game Guard .....	23
<b>Location of Controls (Remote)</b> .....	11	Channel Caption (Station Identifier) .....	24
Basic Remote Functions .....	11	Timer Features .....	25
<b>Remote Quick Reference Key Chart</b> .....	12	Sleep Timer .....	25
<b>Control Operation</b> .....	14	Program Timer .....	26
Power Button .....	14	Set-Up Features .....	27
Volume (Vol) Buttons .....	14	Set Time (Clock) .....	27
Mute Button .....	14	Ant (Antenna) .....	28
Channel Change Features .....	14	Auto Prog (Program) .....	29
Channel (Ch) Buttons .....	14	Manual Prog (Program) .....	30
Keyboard "0 through 9" Buttons .....	14	CC (Closed Caption) On Mute .....	31
VCR Function Buttons .....	14	CC (Closed Caption) Mode .....	32
TV/Video Button .....	15	Trilingual Menu Selection .....	33
Recall Button .....	15	<b>Programming The Universal Remote Control</b> ....	34
R-Tune (Rapid Tune) Button .....	15	<b>VCR Infrared Codes Index</b> .....	35
Multi Button .....	15	<b>Cable Converter Box &amp; CD Player Codes</b> .....	36
PIP (Picture in Picture) Button .....	16	<b>Cassette Players and AV Receivers Codes</b> .....	37
Swap Button .....	16	<b>Laser Disc/DSS/TV/&amp;DVD Codes</b> .....	38
Size Button .....	16	<b>Troubleshooting Chart</b> .....	39
Freeze Button .....	17	<b>Power Loss</b> .....	39

# Care and Cleaning

## **Picture Tube (Turn set off)**

Use a mild soap solution or window cleaner and a clean cloth. DO NOT USE ABRASIVE CLEANERS. Avoid excessive moisture and wipe dry.

## **Plastic Cabinets**

Wipe the cabinet with a soft cloth dampened with water or a mild detergent solution and wipe dry with a soft clean cloth. Avoid excessive moisture. Do not use benzene, thinners or other petroleum based cleaners.

## **Wood Cabinets**

When dusting or polishing the cabinet, use a clean soft cloth and stroke straight with the grain. An occasional coat of furniture polish will help preserve the finish. Do not use benzene, thinners or other petroleum based cleaners. Do not place objects made of plastic or rubber directly on top of the cabinet. A chemical reaction could result causing permanent marring of the finish.

## **Remote Control Transmitter**

Do not use benzene, thinners or other petroleum based cleaners to clean the Remote Control Transmitter. To clean, wipe with a soft cloth slightly moistened with a mild detergent and then wipe dry with a soft clean cloth.

# Installation

## Receiver Location

This unit is intended to be used with an optional stand or entertainment center. Consult your dealer for available options. Locate for comfortable viewing. Avoid placing where sunlight or other bright light (including reflections) will fall on the screen.

Use of some types of fluorescent lighting can reduce remote control transmitter range.

Adequate ventilation is essential to prevent internal component failure. Keep away from areas of excessive heat or moisture.

To insure optimum color purity do not position magnetic equipment (motors, fans, other speakers, etc.) nearby.

## Optional External Equipment Connections

The Video/Audio connections between components can be made with shielded video and audio cables. For best performance, video cables should utilize 75 ohm coaxial shielded wire. Cables are available from your dealer or electronic supply house.

Before you purchase any cables, be sure you know what type of output and input connectors your various components require. Also determine the length of cable you'll need.

## AC Power Supply Cord

**CAUTION:** TO PREVENT ELECTRIC SHOCK, MATCH WIDE BLADE OF PLUG TO WIDE SLOT OF AC OUTLET AND FULLY INSERT. DO NOT USE THIS (POLARIZED) PLUG WITH A RECEPTACLE OR OTHER OUTLET UNLESS THE BLADE CAN BE FULLY INSERTED TO PREVENT BLADE EXPOSURE.

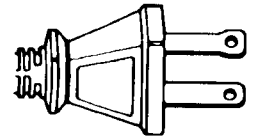

Polarized Plug

## Remote Control Battery Installation

Batteries: Use two "AA" batteries.

1. Turn the Transmitter face down. To remove top cover, press down on marking and slide cover off in the direction indicated.
2. Install the batteries as shown in the battery compartment. (Polarity (+) or (-) must be correct.)
3. Replace the cover and slide in reverse until the lock snaps.

### Helpful Hint:

For frequent Remote Control users, replace old batteries with Alkaline batteries for longer life.

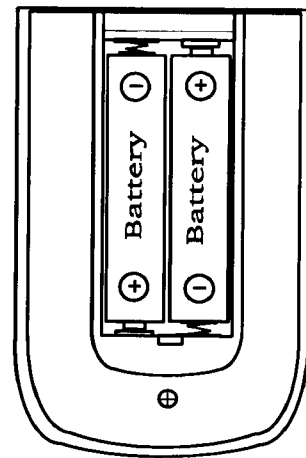

Press Down Here  
And Slide Cover  
Back

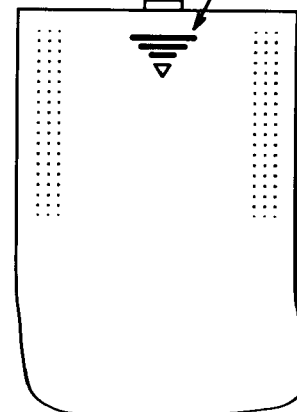

## Precaution on Battery Use

Incorrect installation can cause battery leakage and corrosion that will damage the Remote Control Transmitter.

### Observe the Following Precautions:

1. Batteries should be replaced as a pair. Always use new batteries when replacing the old set.
2. Do not combine a used battery with a new one.
3. Do not mix battery types (Example: "Zinc Carbon" with "Alkaline").
4. Do not attempt to charge, short-circuit, disassemble, heat or burn used batteries.
5. Battery replacement is necessary when Remote Control reacts sporadically or stops operating the Receiver.

### Helpful Hint:

Whenever you remove the batteries to replace them, you may need to reset the Remote Control Infrared Codes. We recommend that you initially record the codes on page 34, when you setup the remote.

## Antenna/Cable Connections

**Antenna Connection** – For proper reception of VHF/UHF channels an external antenna is required. For best reception an outdoor antenna is recommended. Antenna Mode must be set to TV. (Refer to Antenna Mode section.)

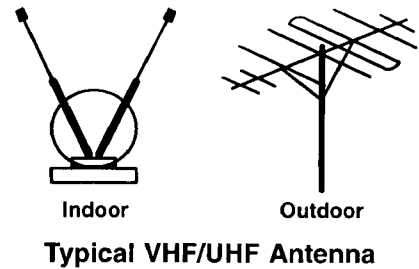

### Incoming Cable From Home Antenna (75 Ohm)

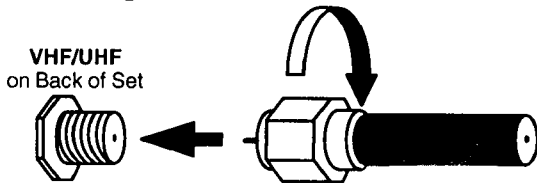

### Incoming Cable From Home Antenna (300 Ohm)

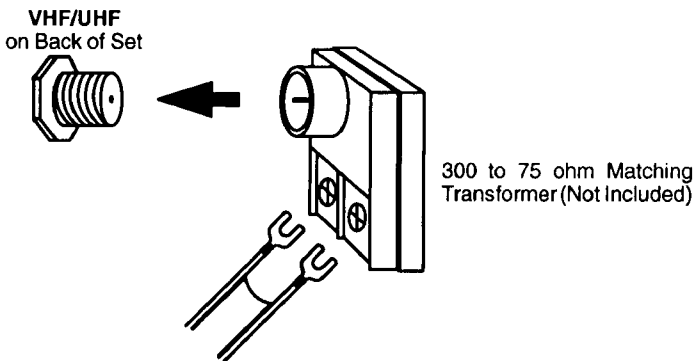

**Cable Connection** – For reception of cable channels (01~125) connect the cable supplied by your local Cable company. Antenna Mode must be set to CABLE. (Refer to Antenna Mode section.)

### Incoming 75 Ohm Cable (From Cable Company)

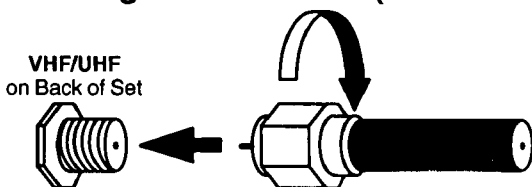

**NOTE:** Certain cable systems offset some channels to reduce interference or have Premium (scrambled) channels. A Cable Converter box is required for proper reception. Check with your local Cable company for its compatibility requirements.

## Other Video Equipment

VCRs, Video Disc Players, Computers, TV games and Teletext equipment can also be connected to the antenna input connection.

## Picture in Picture External Video and Antenna Connection

This Receiver has the "PICTURE IN PICTURE" feature. For the proper operation of this feature a second video source is required (such as a VCR). We recommend that you make your antenna and External Video connection as shown below when a second video source is available.

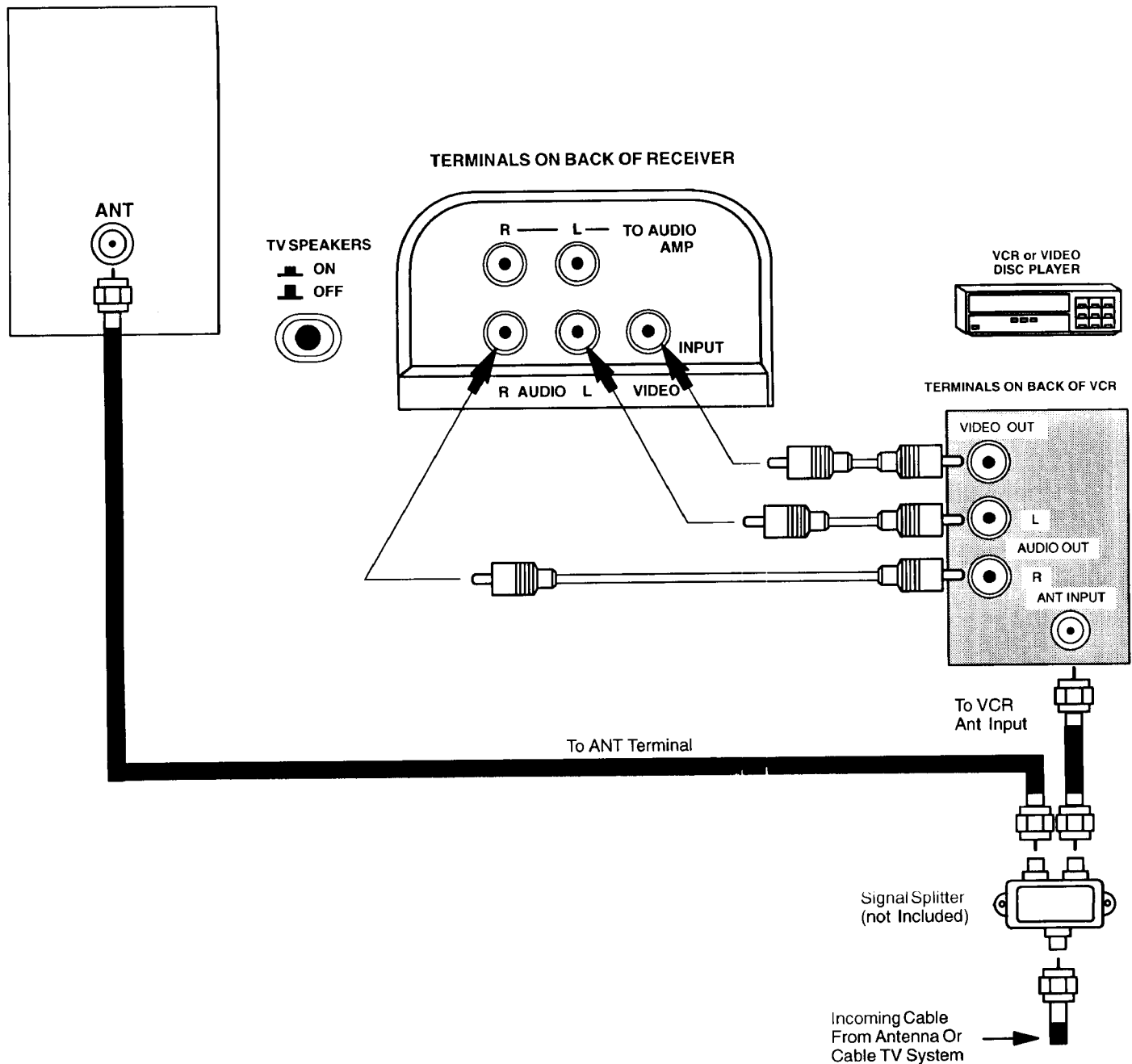

### Helpful Hints:

The PIP will operate using Audio/Video input terminals. Use the TV/VIDEO button (when the PIP frame is displayed) to select Video mode.



# Optional Equipment Connection and Operation

## To Audio AMP Connection (Stereo)

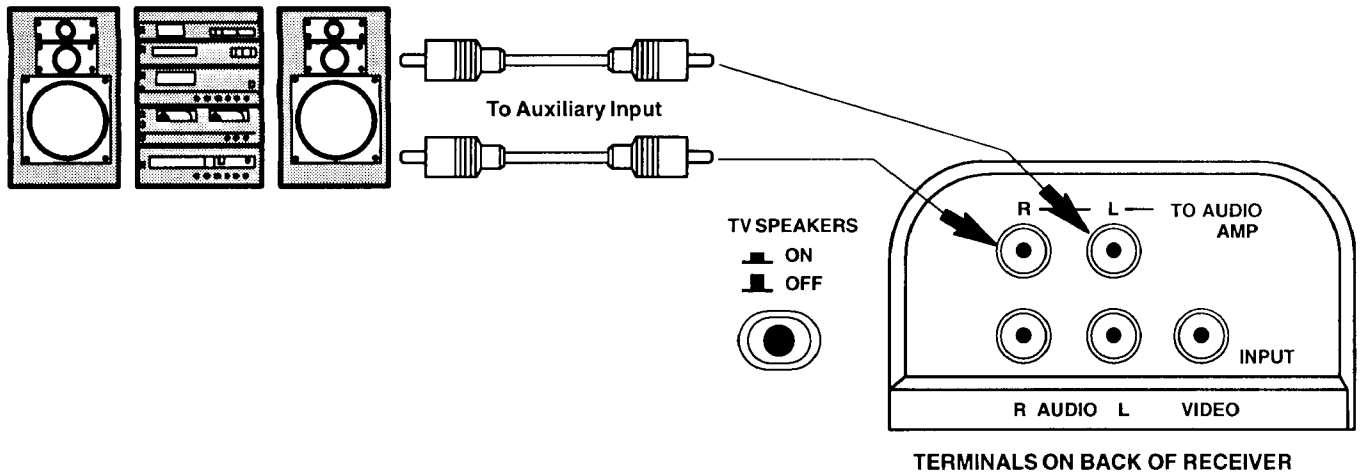

### • To Audio AMP

Connect to an external audio amp auxiliary input for monitoring sound through a stereo system.

**NOTE:** "TO AUDIO AMP" terminals cannot be used for external speakers.

**Adjustment** – When an audio amp is connected to "TO AUDIO AMP" terminals as shown:

1. Press the TV SPEAKERS button (located on back of Receiver) to turn INT. SPEAKERS "ON" (▲).
2. Set volume of audio amp to near minimum.
3. Adjust volume of TV to desired listening level.
4. Adjust volume of audio amp to match the level of TV.
5. Press the TV SPEAKERS button (located on back of Receiver) to turn INT. SPEAKERS "OFF" (▼).
6. Volume and mute can now be controlled by the TV Remote Control.

## Video/Audio Connection

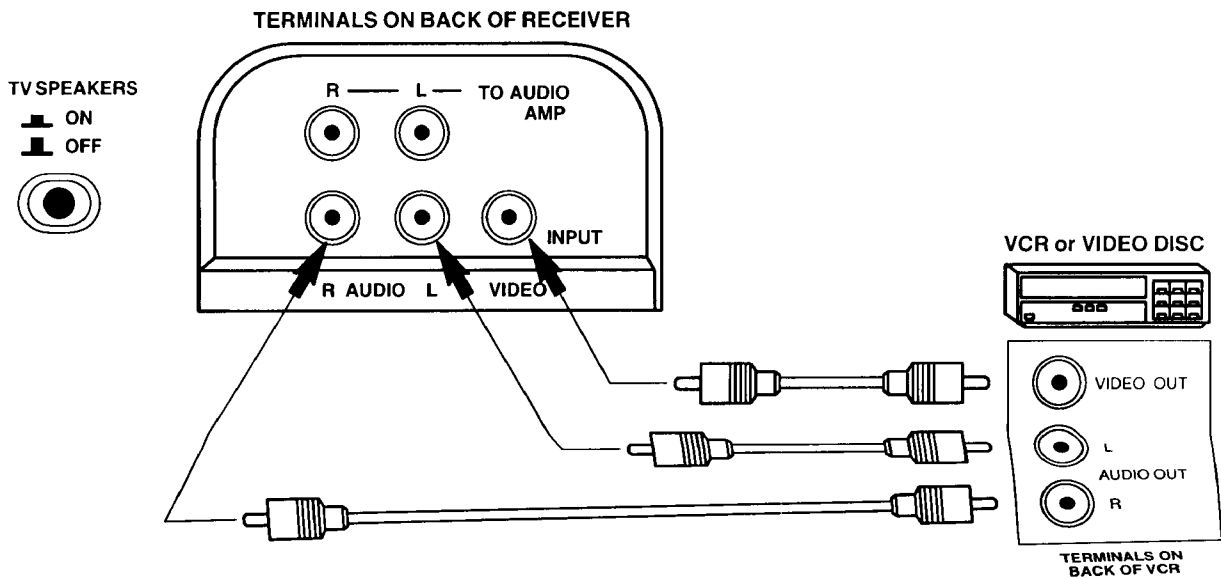

### Operation

1. Connect optional equipment as shown to INPUT.
2. Select the Video mode by pressing the TV/VIDEO button.
3. Operate optional equipment (VCR-VDP) as instructed in Optional Equipment manual.

## Location of Controls (Receiver)

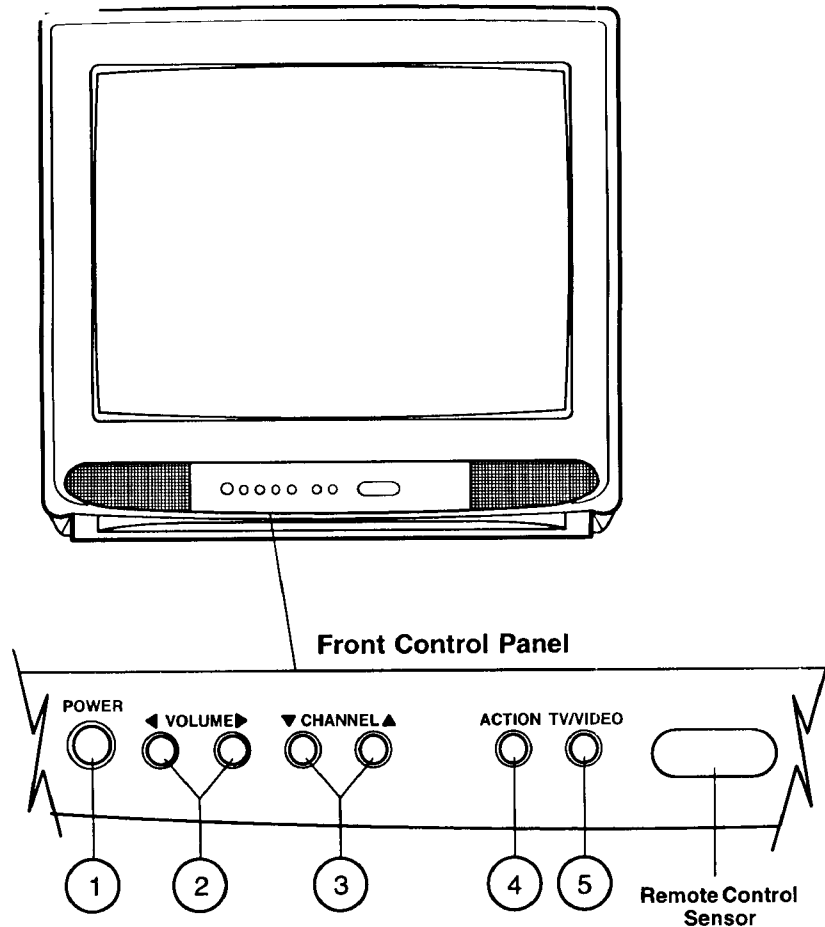

### Quick Reference Control Operation (Receiver)

- ① **Power Button** – Press to turn ON or OFF. (pg. 14)
- ② **Volume Buttons** – Press to adjust Sound Level. Press to adjust Audio Menus, Video Menus and select operating features when menus are displayed. (pg. 14)
- ③ **Channel Buttons** – Press to select programmed channels. Press to highlight desired features when menus are displayed. (pg. 14)
- ④ **Action Button** – Press to display Main Menu and access or exit On Screen feature and Adjustment Menus. (pg. 18)
- ⑤ **TV/Video Button** – Press to select TV or Video Input, for the Main Picture or the PIP frame (when PIP frame is displayed). (pg. 15)

# Location of Controls for the Remote Unit

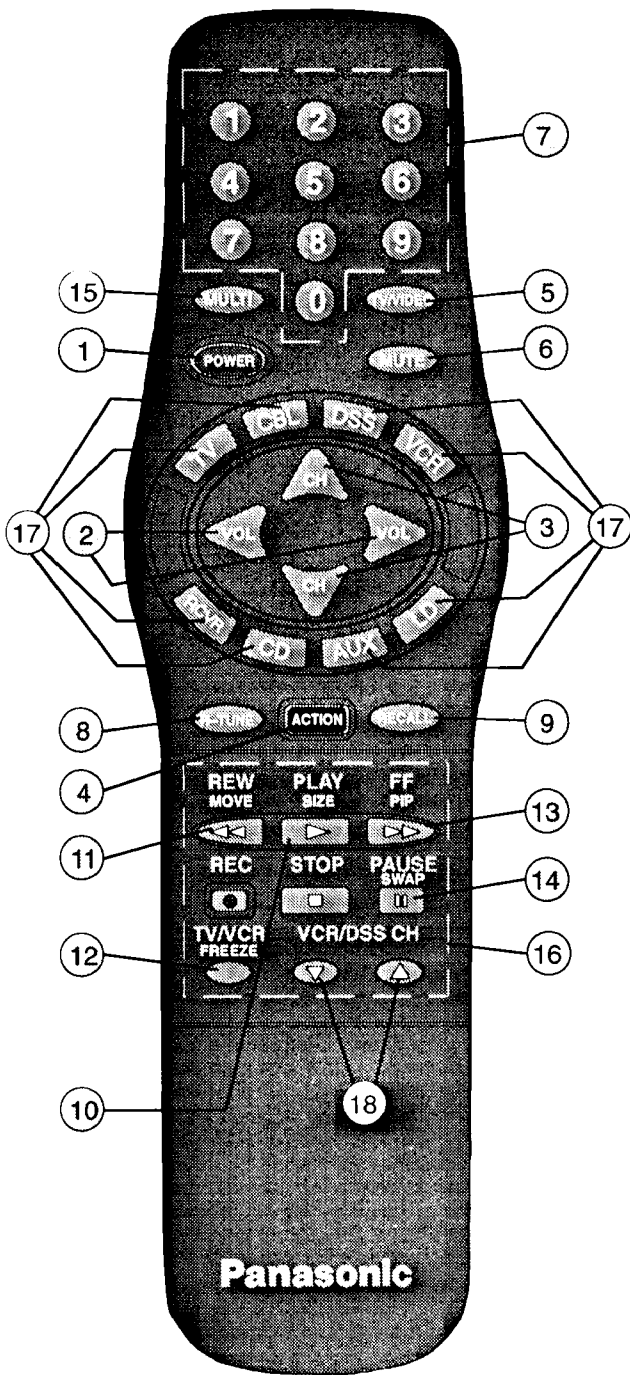

Home Theater  
Remote Control

## Basic Remote Control Functions

The following is a basic overview of the remote control unit for television operation. Ensure the TV mode is selected by initially pressing **TV**. Please refer to the indicated pages for more information.

- ① **Power Button** – Press to turn the TV ON or OFF. (pg. 14)
- ② **Volume Buttons** – Press to adjust TV sound level. Use with Channel buttons to navigate in menus. (pg. 14)
- ③ **Channel Buttons** – Press to select channels. Use with Volume buttons to navigate in menus. (pg. 14)
- ④ **Action Button** – Press to display Main Menu and access or exit On Screen feature and Adjustment Menus. (pg. 18)
- ⑤ **TV/Video Button** – Press to select TV or one of two (2) Video Inputs, for the Main Picture or the PIP frame (when the PIP frame is displayed). (pg. 15)
- ⑥ **Mute Button** – Press to mute sound. A second press returns sound. (pg. 14)
- ⑦ **Keyboard “0 through 9” Buttons** – Press desired channel number to access any channel. (pg. 14)
- ⑧ **R-Tune (Rapid Tune) Button** – Press to switch to the previous channel. (pg. 15)
- ⑨ **Recall Button** – Press to display Time, status of Sleep Timer, Channel, Video Mode, Channel Caption (Station Identifier) and Audio Mode. (pg. 15)
- ⑩ **PIP Size Button** – Press to select size of PIP frame (when the PIP frame is displayed). (pg. 16)
- ⑪ **PIP Move Button** – Press to position PIP frame to any corner of the Main Picture (when PIP frame is displayed). (pg. 17)
- ⑫ **PIP Freeze Button** – Press to stop action in the Main Picture or PIP frame (when the PIP frame is displayed). (pg. 17)
- ⑬ **PIP (Picture In Picture) Button** – Press to display the PIP frame, press again to remove PIP frame. (pg. 16)
- ⑭ **PIP Swap Button** – Press to interchange PIP frame with Main Picture (when the PIP frame is displayed). (pg. 16)

### Helpful Hints:

















If the selected component does not respond to the remote control, ensure that the proper mode is selected. **First**, press the **Mode Selection Button** that corresponds to that component. For example, after first pressing the TV Mode Button, the remote will remain in the TV mode for any following commands. If a different mode button is pressed while operating the television, the TV mode button must be pressed again to reset the TV mode condition.

- ⑮ **Multi Button** – Programmable to operate up to six Remote Function buttons simultaneously. (pg. 15)
- ⑯ **VCR Function Buttons** – Programmable to operate many brands of VCR's. (pg. 14)
- ⑰ **Mode Selection Buttons** – Selects the operation mode for the remote control. (pg. 39)
- ⑱ **VCR/DSS Channel Buttons** – These buttons are used to select VCR or DSS Up/Down channels. (pg. 13)

**NOTE:** For more information on the Remote Control, please refer to the Remote Control Quick Reference Functional Key Chart (pages 12 and 13).











# Remote Control

## Quick Reference Functional Key Chart

KEY	MODE	FUNCTION
①    ②    ③ ④    ⑤    ⑥ ⑦    ⑧    ⑨ ⑩	TV VCR CABLE, DSS	Selects Channel Selects Channel Selects Channel
	RECEIVER/AMPLIFIER	① Selects TV Video 1                      ⑦ VCR 1 ② Selects TV Video 2                      ⑧ VCR 2 ③ Selects TV Video 3                      ⑨ VCR 3 ④ Selects Tuner ⑤ Selects CD Player ⑥ Selects Tape Cassette Player
	CD PLAYER	Selects Track Number
	LD PLAYER	Selects Track Number
	ALL COMPONENTS	Programmable Button That Can Operate Up To Six Remote Functions At Once
	TV	Selects the TV Input Mode
	ALL COMPONENTS	Turns On and Off Selected Components
	TV, DSS, VCR, LDP CABLE RECEIVER/AMPLIFIER	Mutes TV Audio Mutes Audio Mutes Audio
	TV	TV Mode Selection for Remote Control
	CABLE	Cable Mode Selection for Remote Control
	DSS (DIGITAL SATELLITE SYSTEM)	DSS Mode Selection for Remote Control
	VCR	VCR Mode Selection for Remote Control
	RECEIVER/AMPLIFIER	Receiver/Amplifier Mode Selection for Remote Control
	COMPACT DISC	CD Mode Selection for Remote Control
	CASSETTE PLAYER, DVD	AUX Mode Selection for Remote Control Enables User to Operate a Tape Cassette Player, or Digital Video Disc
	LASER DISC PLAYER	LD Mode Selection for Remote Control
  	TV CABLE DSS LDP CD RECEIVER/AMPLIFIER DVD	Channel Up/Down, Menu Navigation Channel Up/Down DSS Guides and Menu Navigation Skip FF, REW Preset or Tuning Frequency Skip FWD / Skip REW
 	TV CABLE DSS RECEIVER/AMPLIFIER VCR LDP	Volume Up/Down, Menu Navigation Volume Up/Down DSS Guides and Menu Navigation Volume Up/Down TV Volume Up/Down TV Volume Up/Down

# Remote Control

## Quick Reference Functional Key Chart

KEY	MODE	FUNCTION
	LDP TV CABLE VCR DSS RECEIVER/AMPLIFIER CD TAPE CASSETTE PLAYER	Side A/B Selects Previously Tuned Channel Selects Previously Tuned Channel Selects Previously Tuned Channel Selects Previously Tuned Channel Switches between AM and FM Selects Next Disc Selects Tape Cassette Player A or B
	TV DSS	Activates TV Menus Acts as Menu Button for DSS
	TV DSS VCR LDP	Displays Channel, Time, and Audio Mode Displays Current DSS Settings Displays Current VCR Settings Displays Current LDP Settings
REW MOVE 	TV DSS VCR LDP TAPE CD DVD	PIP Move DSS Guide Rewind Rewind Rewind Selects Previous Track Rewind
PLAY SIZE 	TV DSS VCR LDP TAPE CD DVD	PIP Size Enter/Select Play Play Play (in Normal Direction) Play Play
FF PIP 	TV DSS VCR LDP TAPE CD DVD	PIP On/Off Exit/Clear Fast Forward Fast Forward Fast Forward Selects Next Track Fast Forward
REC 	DSS VCR TAPE CABLE	One Touch Record in DSS Mode Record Record VCR Record
STOP 	DVD VCR LDP TAPE CD CABLE	Stop Stop Stop Stop Stop VCR Stop
PAUSE SWAP 	DVD TV VCR LDP TAPE CD CABLE	Pause PIP Swap Pause Pause Pause Pause VCR Pause
TV/VCR FREEZE 	VCR DSS CABLE	Selects TV/VCR Mode Selects TV/DSS Mode Selects TV/VCR Mode
VCR/DSS CH 	TV VCR DSS CABLE	PIP Channel Up/Down (2 Tuner PIP Models Only) Channel Up/Down Channel Up/Down VCR Up/Down

# Control Operation

## Helpful Hints:

- Press the TV Mode Selection button to operate TV Remote functions, if necessary.



**Power Button** — Press the POWER button after selecting a mode to turn ON. Press again to turn OFF.

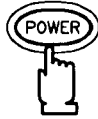

**Volume Button** — Press the VOLUME (VOL) LEFT or RIGHT button for desired listening level (when On Screen menus are not displayed).

Located On Remote Control

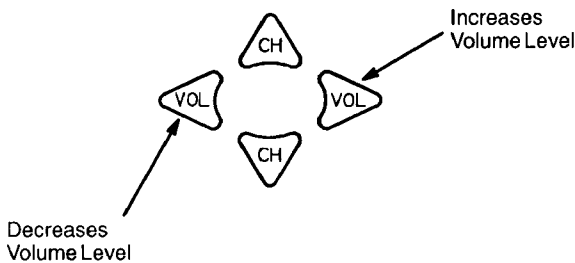

**Mute Button** — Press the MUTE button to quickly reduce sound level (Mute will appear on screen). Press again to restore sound.



## Helpful Hints:

- Helpful information will display On Screen momentarily when Receiver is first turned on and when the channel is changed.
- When using keyboard entry for channels 10, 11 and 12 in the CABLE mode there is a slight delay before channel change because of the capability of tuning cable channels 100 to 125.

**NOTE:** If "SPEAKER OFF" is displayed On Screen after pressing the VOLUME button, refer to Audio Menu to turn Speakers "ON".

## Channel Change - (Two options)

### Option 1.

Press the CHANNEL (CH) UP or DOWN button to sequentially scan through programmed channels (when On Screen menus are not displayed).

**NOTE:** Press the TV Mode button to operate TV Remote functions, if necessary.

Located On Remote Control

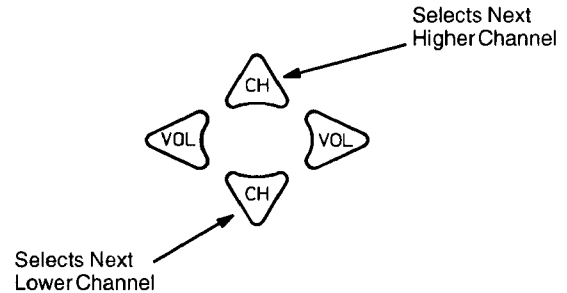

## Keyboard "0 through 9" Buttons

### Option 2.

Press two digits on keyboard (Example press 0, then 5 for channel 05). For channels over 99, press three digits on keyboard.

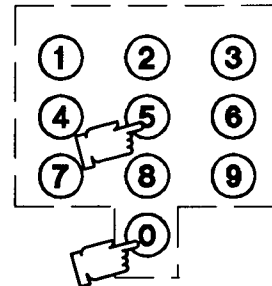

**VCR Function Buttons** — The VCR FUNCTION buttons have been designed to operate numerous brands of VCRs. The infrared code must be obtained prior to use. (Please refer to Programming the Universal Remote for programming instructions.)

**NOTE:** Press the VCR Mode Selection button to operate VCR Remote functions.

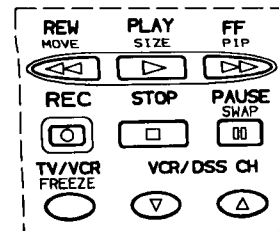

### Helpful Hints:

- Press the TV Mode Selection button to operate TV Remote functions, if necessary.



**TV/Video Button** – Press the TV/VIDEO button to select desired input for Main Picture or PIP frame (when the PIP is displayed).

Signal connected to:

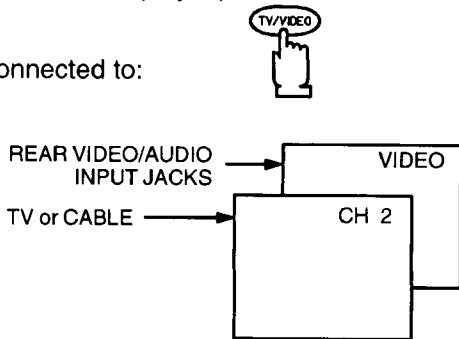

Signal connected to:

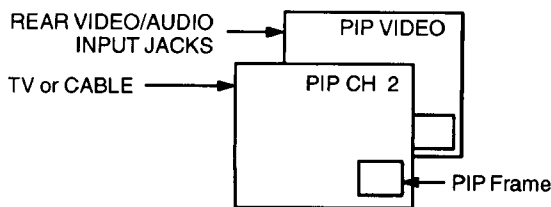

**Recall Button** – Press the RECALL button to review:

- Audio Mode status
- CH number or Video Input selected
- Sleep Timer status
- Clock time
- Channel Caption (Station Identifier)

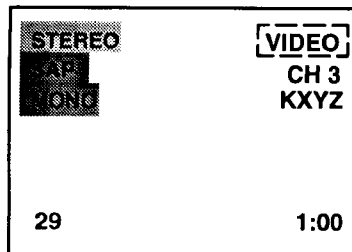

**R-Tune (Rapid Tune) Button** – Press the R-TUNE (RAPID TUNE) button to instantly switch between the last two channels selected (without any On Screen display being activated).

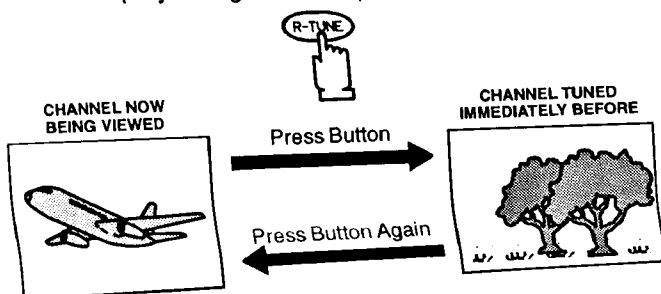

### Multi Button

The **MULTI** button can be programmed to operate up to 6 Remote function buttons at the same time.

**For Example:** TV Power/On, VCR Power/On and Cable box Power/On (selected brands) can be operated at the same time with one press of the MULTI button.

#### Procedure

1. First program the Remote for the selected device Infrared access code. Confirm that the Remote Control is compatible with the equipment.
2. Face the Remote Control transmitter away from all equipment remote sensors.
3. Press and hold the Remote POWER button, then press and hold the ACTION button down at the same time for three seconds. (All previous commands are erased.)

PRESS AT THE SAME TIME FOR THREE SECONDS

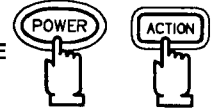

4. After three seconds, let go of the POWER and ACTION buttons.
5. Press the MULTI button. (Waiting more than 30 seconds without pressing another button will exit the programming mode.)
6. Press a maximum of 6 Function buttons on the Remote.

Each button you press is equal to one function. If six Remote button functions are entered, all will register in the MULTI button memory in the sequence entered. When finished, press the MULTI button to end the program mode.

The following is an example flow chart of Remote functions that can be programmed into the MULTI button (The VCR Mode button should be programmed before starting procedure see pg. 37).

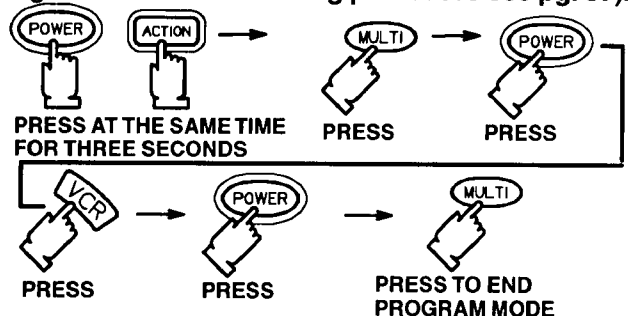

Now you can turn the TV and VCR ON/OFF at the same time with one press of the MULTI button.

**To delete entered functions** – Press and hold the Remote POWER button then press and hold the ACTION button down at the same time for three seconds. Now you can enter from one to six different Remote functions.

#### NOTE:

You can also program the MULTI button to perform most individual Remote Control button functions. Buttons which continuously perform a function as long as pressed (Volume Up/Down, Channel Up/Down, etc.) cannot be programmed. Only those buttons which perform a function when initially pressed (Power On/Off, Mute, Direct Channel Entry, etc.) can be programmed.

- Press the TV Mode Selection button to operate TV Remote functions, if necessary.



### PIP (Picture in Picture) Button –

This feature allows monitoring one channel while watching another when a second video source with a tuner is connected (such as a VCR) to the television.

**NOTE:** When the Main Picture is in Video mode with no signal, the PIP will not operate properly.

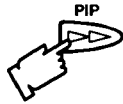

#### PIP Operation

1. Turn VCR ON and select a desired channel.
2. Press the TV Mode Selection button to operate the Remote function, if necessary.
3. Press the PIP button (television must be ON). The PIP frame will appear at the position it was last displayed. The Main Picture Video Source and PIP Video Source will display on screen momentarily. Audio will be that of Main Picture.

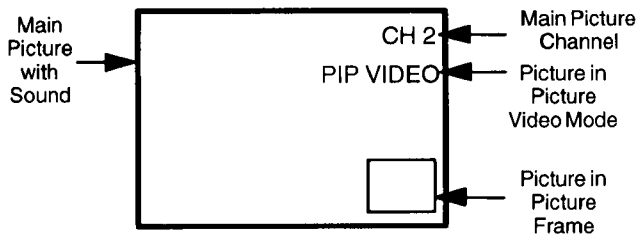

4. Press the PIP button again to cancel PICTURE IN PICTURE feature.

**NOTE:** For PIP Video source connection, refer to PIP Antenna and External Video connection section.

**Swap Button** – Press the SWAP button (when the PIP frame is displayed) to interchange what is being viewed on the Main Picture with that of the PIP frame.

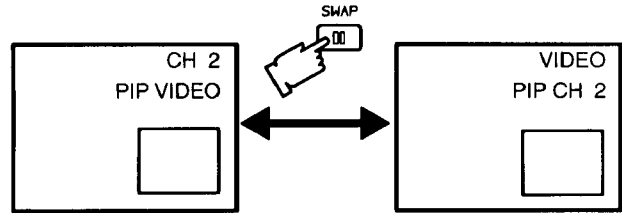

- Audio will be that of the Main Picture.

**Size Button** – Press the SIZE button (when the PIP frame is displayed) to choose either the large or small PIP frame.

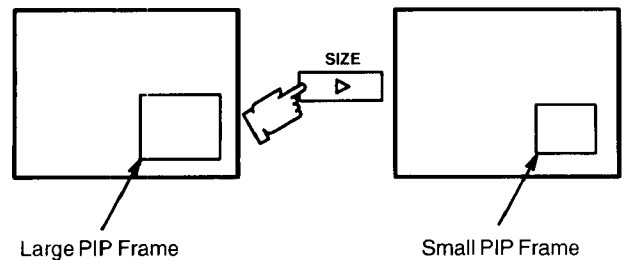



### Helpful Hints:

- Press the TV Mode Selection button to operate TV Remote functions, if necessary.



**Freeze Button** – Press the FREEZE button to stop action in the PIP frame.

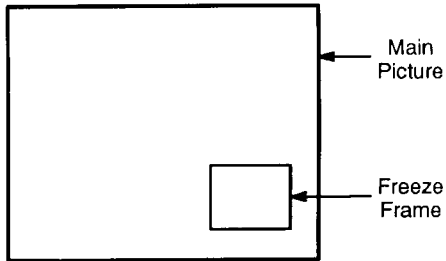

### NOTE:

- Pressing the FREEZE button when the PIP frame is not displayed will stop action in the Main Picture and display it on the PIP frame.
- Pressing the FREEZE button when PIP frame is displayed will stop action in the PIP frame, press the FREEZE button again to continue action.
- Press the PIP button to delete PIP frame.

**Move Button** – The PIP frame may be located at any corner of the Main Picture by pressing the PIP MOVE button (when the PIP frame is displayed).

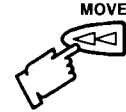

**NOTE:** Each time MOVE button is pressed (when the PIP frame is displayed), the PIP frame will move (counterclockwise) as illustrated.

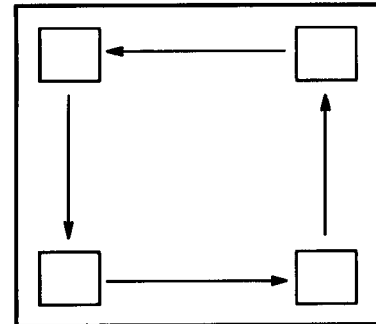

# Main Menu (Icons)

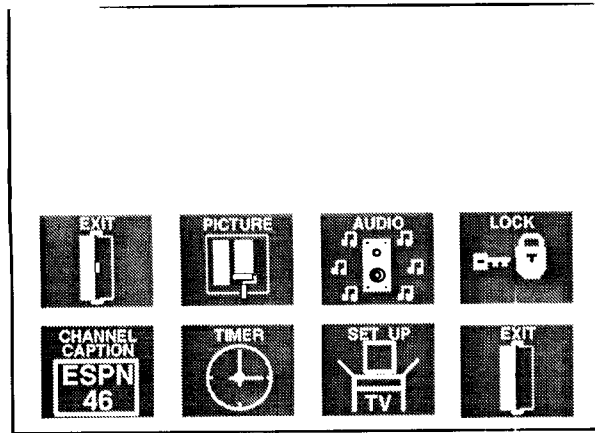

**Note:** Refer to Trilingual Menu Selection (page 33) to change sub menus to a different language (English, Spanish or French).

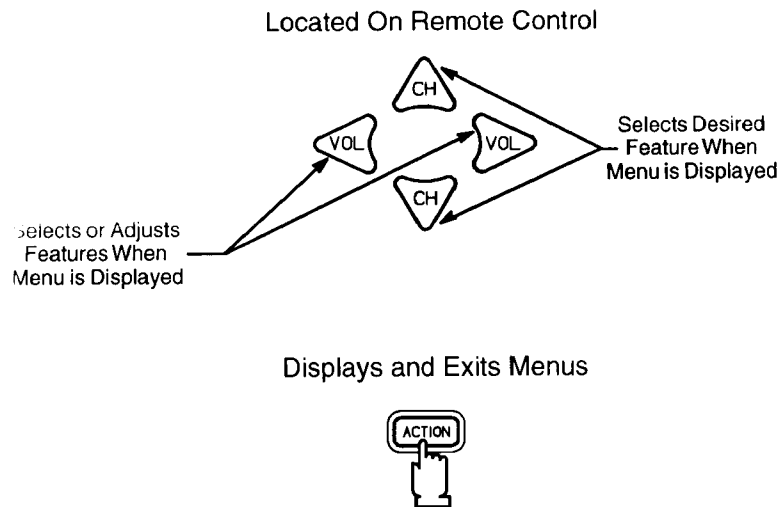

1. Press the ACTION button to display the Main Menu with Icons.
2. Press the CH UP or DOWN and the VOL LEFT or RIGHT buttons to select the desired Icon when the Main Menu is displayed (selected Icon will be indicated in Red).
3. Press the VOL buttons for left and right movement and the CH buttons for up or down movement.
4. To exit the Main Menu first select the EXIT Icon, then press the ACTION button.

# Picture Adjustments

- Picture Norm
- Color
- Tint
- Brightness
- Picture
- Sharpness

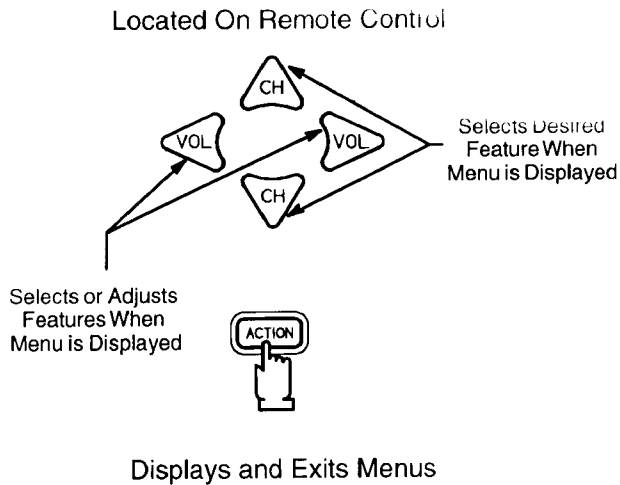

**Picture Norm** -- This feature is used to reset Color, Tint, Brightness, Picture and Sharpness adjustments back to a factory preset level.

1. Press the ACTION button to display the Main Menu.
2. Press the CH UP/DOWN and VOL LEFT/RIGHT buttons to select the Picture Icon.
3. Press the ACTION button to display the Picture Adjustment Menu.

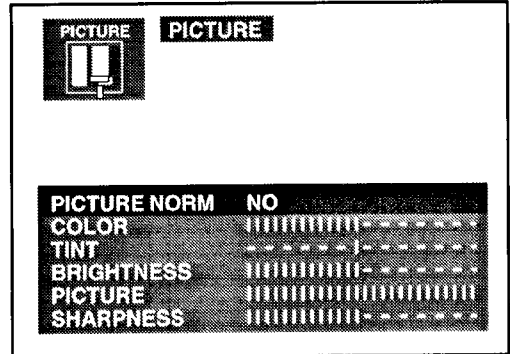

4. Press the CH UP or DOWN button to highlight PICTURE NORM (if necessary).
5. Press the VOL LEFT or RIGHT button to select "SET" to Normalize Color, Tint, Brightness, Picture and Sharpness.
6. Press the ACTION button twice to exit the Picture Adjustment Menu.

## Color, Tint, Brightness, Picture & Sharpness Adjustments

1. Press the ACTION button to display the Main Menu.
2. Press the CH UP/DOWN and VOL LEFT/RIGHT buttons to select the Picture Icon.
3. Press the ACTION button to display the Picture Adjustment Menu.

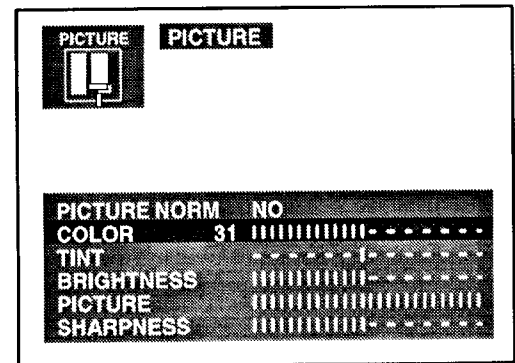

### Helpful Hints:

Picture Adjustments:

COLOR – adjust for desired color intensity.

TINT – adjust for natural flesh tones.

BRIGHTNESS – adjust so dark areas of picture just become black for a crisp detail.

PICTURE – adjust so the white areas of the picture are to your liking.

SHARPNESS – adjust for best clarity of outline detail.

4. Press the CH UP or DOWN button to highlight the desired Picture Adjustment (Color, Tint, Brightness, Picture or Sharpness).
5. Press the VOL LEFT or RIGHT button to adjust your selection. (The selected Picture Adjustment will be displayed).
6. Repeat steps 4 and 5 for the remaining Picture Adjustments.
7. Press the ACTION button twice to exit the Picture Adjustment Menu.

# Audio Adjustments

- Audio Mode
- AI Sound

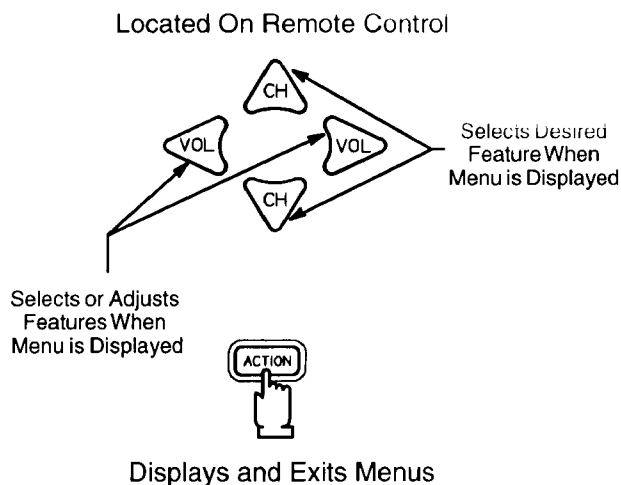

## Mode – Stereo/SAP/Mono

When Audio is broadcast in Stereo or SAP an ON Screen display will appear on initial “Turn On” and “Channel Change”. The available choices will be indicated in red.

1. Press the ACTION button to display the Main Menu.
2. Press the CH UP/DOWN and VOL LEFT/RIGHT buttons to select the Audio Icon.
3. Press the ACTION button to display the Audio Adjustment Menu.

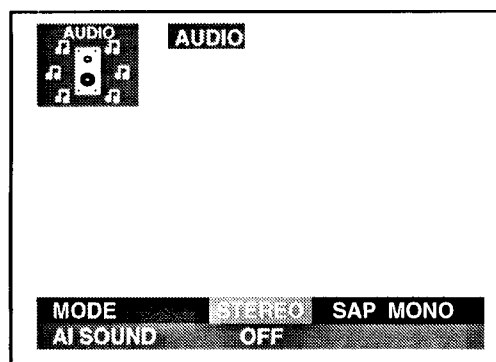

4. Press the CH UP or DOWN button to select MODE.
5. Press the VOL LEFT or RIGHT button to select Stereo, SAP (Second Audio Programming) or Mono.
6. Press the ACTION button twice to exit the Audio Adjustment Menu.

### Helpful Hints:

STEREO – Two channel Audio reception.  
SAP – Second Audio Programming (typically used for bilingual audio).  
MONO – Use when stereo signal is weak.

## Audio Adjustments (cont.)

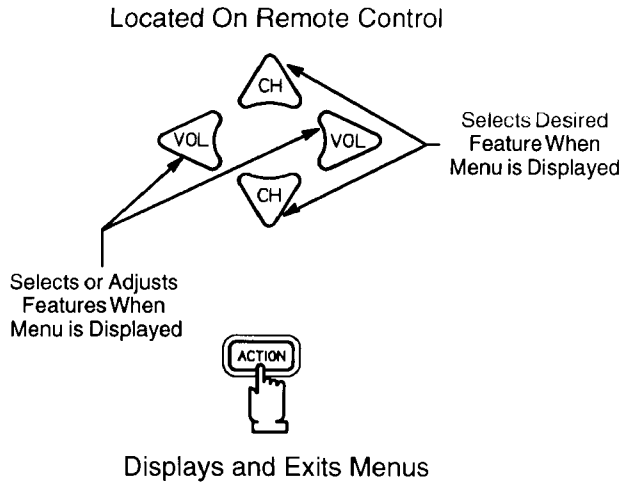

**AI Sound** — This feature regulates the volume between programs and commercial audio to maintain a constant sound output level.

1. Press the ACTION button to display the Main Menu.
2. Press the CH UP/DOWN and VOL LEFT/RIGHT buttons to select the Audio Icon.
3. Press the ACTION button to display the Audio Adjustment Menu.

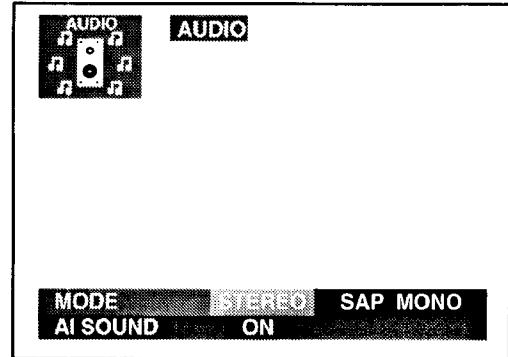

4. Press the CH UP or DOWN button to highlight AI SOUND.
5. Press the VOL LEFT or RIGHT button to select AI SOUND "ON" or "OFF".
6. Press the ACTION button twice to exit the Audio Adjustment Menu.

# Lock

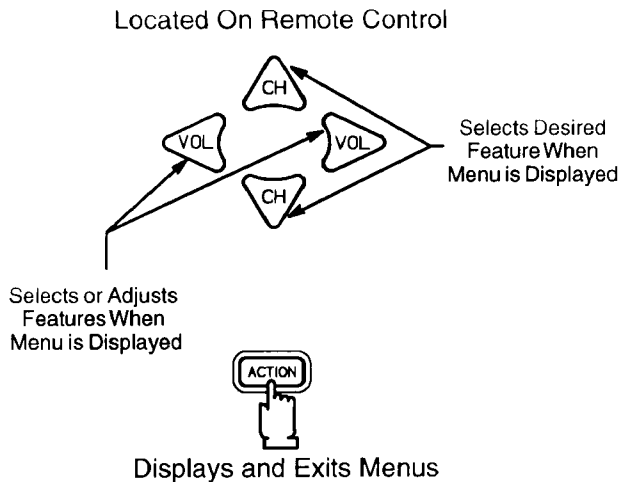

## Lock Game Guard

Prevents video games and other video sources from being viewed. Channel 3, 4 and all video inputs are locked out for 12, 24 or 48 hours.

**NOTE:** Be sure to understand this feature before attempting its use. **Use a code that you will easily remember or write down code on a piece of paper.**

1. Press the ACTION button to display the Main Menu.
2. Press the CH UP/DOWN and VOL LEFT/RIGHT buttons to select the Lock Icon.
3. Press the ACTION button to display the Lock (Game Guard) Menu.

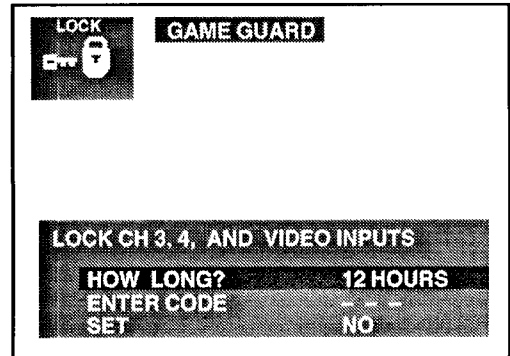

4. Press the VOL RIGHT button to select the desired hours (12, 24 or 48) for Game Guard (Lockout) to be activated.
5. Press the CH DOWN button to select "ENTER CODE". Then enter a 3 digit code with the Remote Control Keyboard.

**IMPORTANT NOTE:** Use a code you can easily remember or write down the code on a piece of paper.

6. Press the VOL LEFT or RIGHT button after entering three digit code. "Game Guard Locked" will display On Screen.

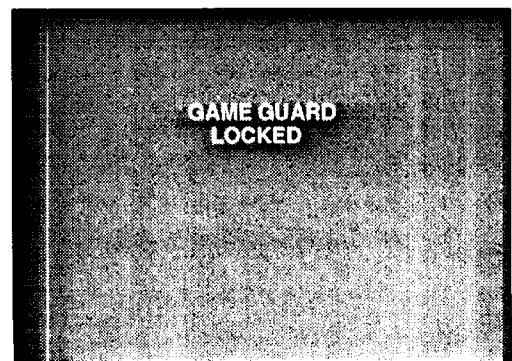

Game Guard Activated

## Lock (cont.)

### Unlock Game Guard

To unlock the Game Guard feature, repeat steps 1 through 3 from Lock Game Guard. Enter the same 3 digit code previously used in step 5 with Remote Control Keyboard.

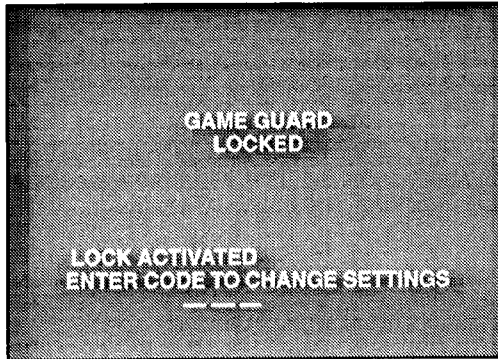

Enter Same 3 Digit Code Previously Used

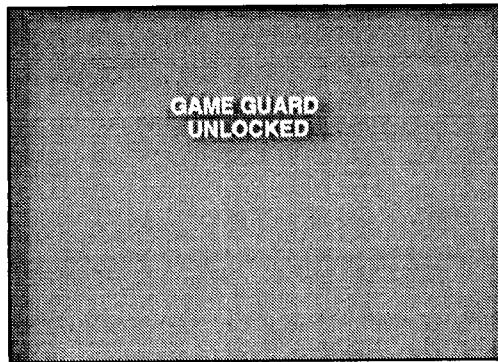

If 3 Digit Code Is The Same

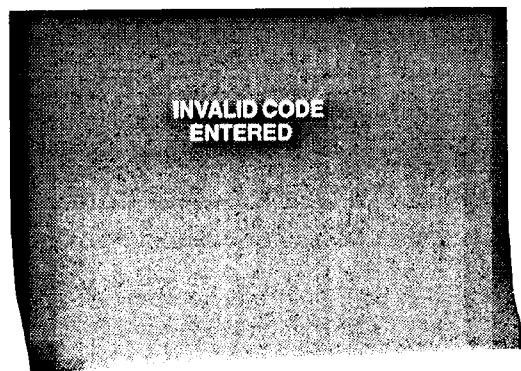

If 3 Digit Code Is Not The Same

# Channel Caption

Located On Remote Control

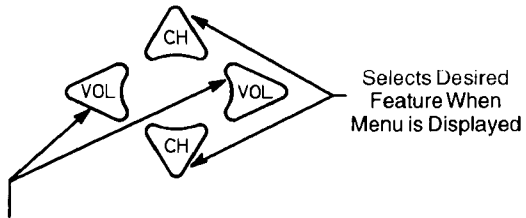

Selects or Adjusts

Selects Desired  
Feature When  
Menu is Displayed

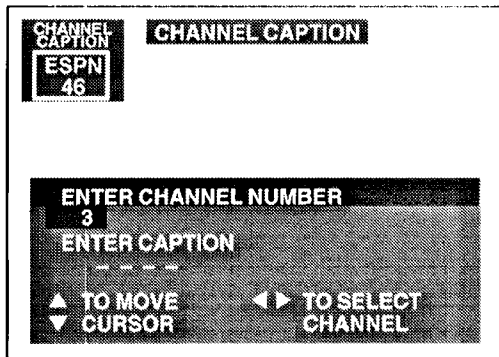

4. Press the VOL LEFT or RIGHT button, or use the



# Timer Features

- Sleep Timer
- Program Timer

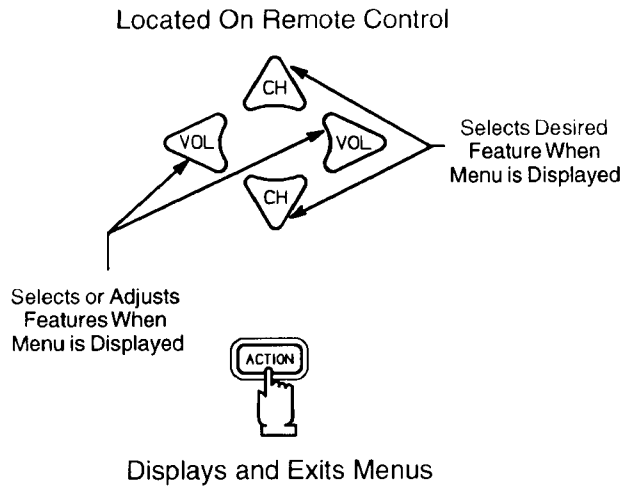

**Sleep Timer** – This feature is used for automatic turn off in 30, 60 or 90 minutes.

**NOTE:** Display will flash 3, 2 and 1 to indicate the last three remaining minutes prior to turn off. The Recall display will also appear.

1. Press the ACTION button to display the Main Menu.
2. Press the CH UP/DOWN and VOL LEFT/RIGHT buttons to select the Timer Icon.
3. Press the ACTION button to display the Timer Control Menu.

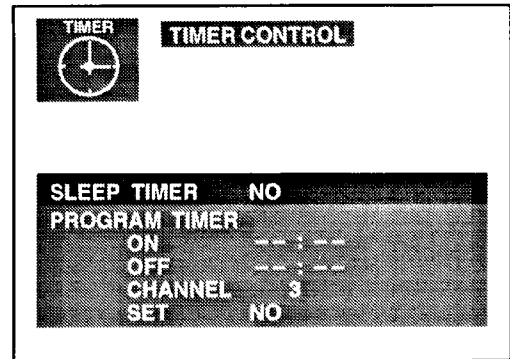

4. Press the VOL RIGHT button to select 30, 60 or 90 minutes (Sleep Timer will be activated).
5. Press the ACTION button twice to exit the Timer Control Menu.

**NOTE:** To deactivate Sleep Timer repeat steps 1 through 4. In step 4 select "NO" instead of minutes.

## Helpful Hints:

Press the RECALL button to display the remaining minutes for Sleep Timer, the time will display in the bottom left corner.

## Timer Features (cont.)

### Special Feature:

#### Automatic turn "OFF" after 90 minutes.

The TV has a special feature that will shut itself **OFF** after 90 minutes when turned **ON** by the program timer unless a function key is pressed during the 90 minutes.

This feature is useful so that the TV will not remain **ON** unattended for an extended period of time.

Programming the **OFF** timer will also cancel the automatic **OFF** feature.

**Program Timer** — This feature is capable of turning the TV on, tuned to a desired channel and off at a predetermined time (one day or everyday).

**NOTE:** The clock must be set for this feature to operate. (Refer to the Set-Up Menu to set time.)

1. Press the ACTION button to display the Main Menu.
2. Press the CH UP/DOWN and VOL LEFT/RIGHT buttons to select the Timer Icon.
3. Press the ACTION button to display the Timer Control Menu.

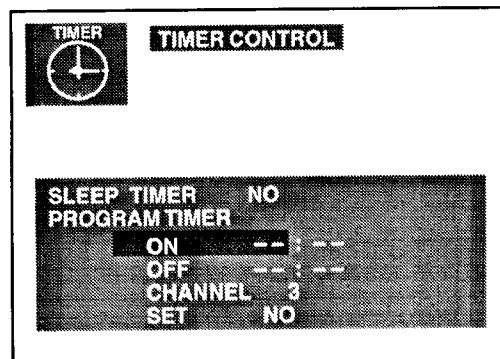

Located On Remote Control

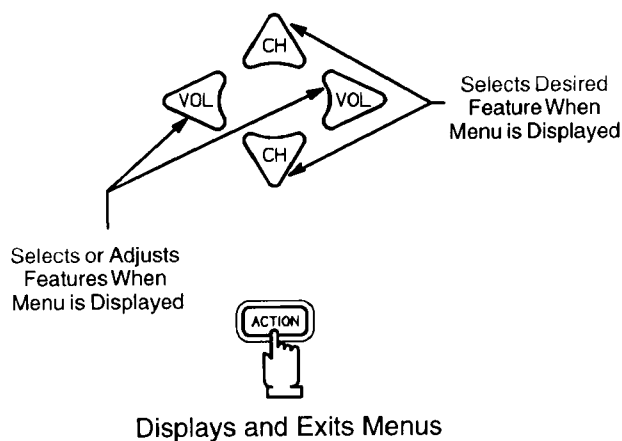

4. Press the CH DOWN button to select "ON" (time).
  5. Press the VOL LEFT or RIGHT button repeatedly to set hours (set AM/PM accordingly).
  6. Press the CH DOWN button to select the minutes position.
  7. Press the VOL LEFT or RIGHT button repeatedly to set minutes.
  8. Press the CH DOWN button to select "OFF" (time).
  9. Repeat steps 5 through 7 for setting "OFF" (time).
  10. Press the CH DOWN button to select "CHANNEL".
  11. Press the VOL LEFT or RIGHT button or use the Remote Control Keyboard to enter the channel number desired when the set turns "ON".
  12. Press the CH DOWN button to select "SET".
  13. Press the VOL RIGHT button to select:
    - NO – not activated.
    - ONE DAY – activated.
    - DAILY – activated.
- NOTE:** To deactivate Program Timer select "NO" in step 13.
14. Press the ACTION button twice to exit the Timer Control Menu.

### Helpful Hints:

- If you see "GAME GUARD" in the upper right hand corner, the channel or Video Input you have selected has been locked out.
- If the Program Timer "ON" functions while the set is operating, the set will automatically tune to the channel designated in the Timer Program.

# Set-Up Features

- Set Time
- Antenna (TV or Cable)
- Auto Program
- Manual Program
- CC (Closed Caption) on Mute
- CC (Closed Caption) Mode
- English, Espanol (Spanish) or Francais (French)

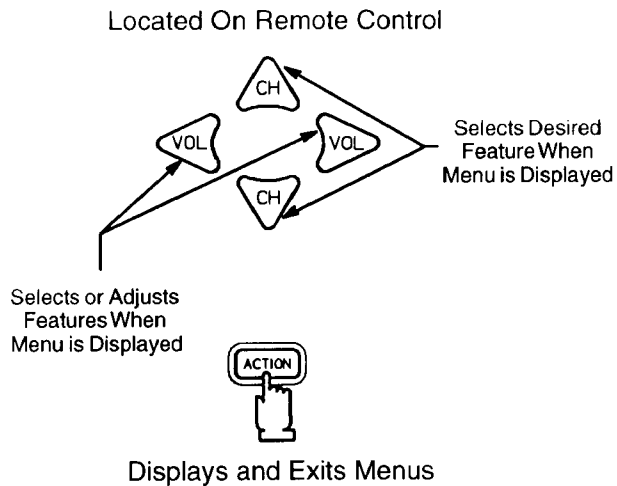

**Set Time** – Clock (when set) will display on screen at initial “Turn On”, after a channel change and when pressing the RECALL button. The time must be set first in order to operate the Program ON/OFF Timer.

1. Press the ACTION button to display the Main Menu.
2. Press the CH UP/DOWN and VOL LEFT/RIGHT buttons to highlight the Set-Up Icon.
3. Press the ACTION button to display the Set-Up Menu, “SET TIME” will be highlighted.

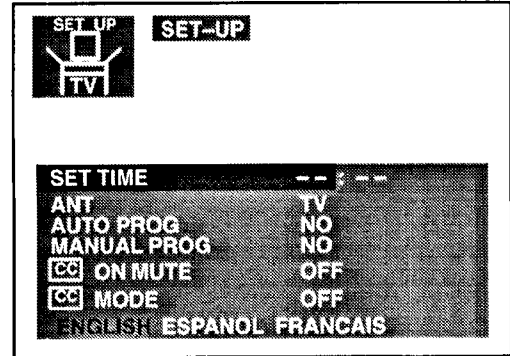

4. Press the VOL LEFT or RIGHT button to set hours (set AM/PM accordingly).
5. Press the CH DOWN button to select minutes position.
6. Press the VOL LEFT or RIGHT button repeatedly to set minutes.
7. Press the ACTION button twice to exit the Set-Up Menu.

## Set-Up Features (cont.)

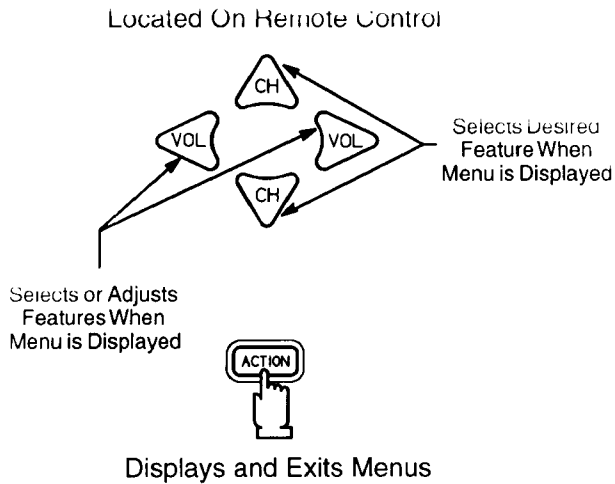

**Ant (Antenna)** – The proper Input mode must be selected for the type of signal at the antenna input.

- TV mode is used when the Receiver is not connected to a cable TV system, for example when using a VHF/UHF antenna (channels 02 – 69).
- Cable mode is used when the Receiver is connected to a Cable TV system and you are not using a cable company converter box (channels 01 – 125).

1. Press the ACTION button to display the Main Menu.
2. Press the CH UP/DOWN and VOL LEFT/RIGHT buttons to highlight the Set-Up Icon.
3. Press the ACTION button to display the Set-Up Menu.

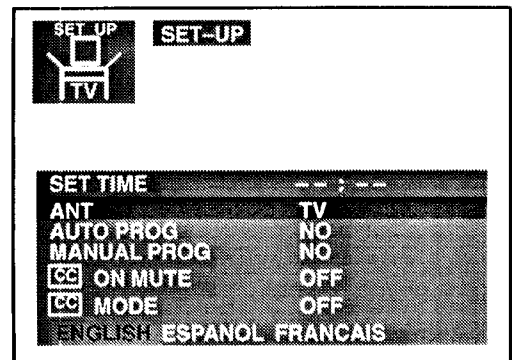

4. Press the CH DOWN button to highlight "ANT".
5. Press the VOL LEFT or RIGHT button to select TV or CABLE.
6. Press the ACTION button twice to exit the Set-Up Menu.

## Set-Up Features (cont.)

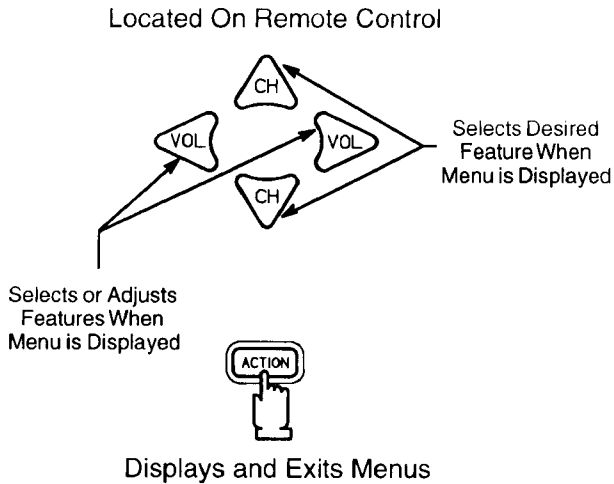

**Auto Prog (Program)** – This feature allows you to place all channels with a video signal into Channel Scan Memory.

1. Press the ACTION button to display the Main Menu.
2. Press the CH UP/DOWN and VOL LEFT/RIGHT buttons to highlight the Set-Up Icon.
3. Press the ACTION button to display the Set-Up Menu.

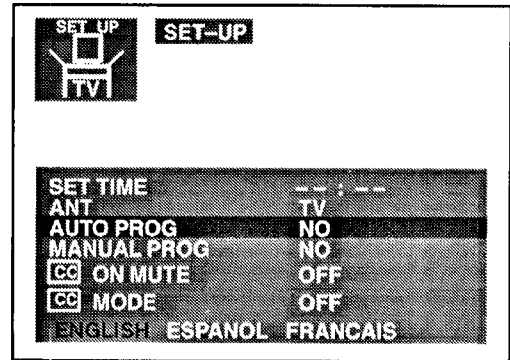

4. Press the CH DOWN button to highlight "AUTO PROG".
5. Press the VOL LEFT or RIGHT button to start Auto Programming. Channels will automatically advance until all channels have been scanned.
6. Press the ACTION button twice after completion of Auto Programming to exit the Set-Up Menu.

**NOTE:** Channel numbers with signal present will turn blue which indicates stored in Channel Scan Memory.

## Set-Up Features (cont.)

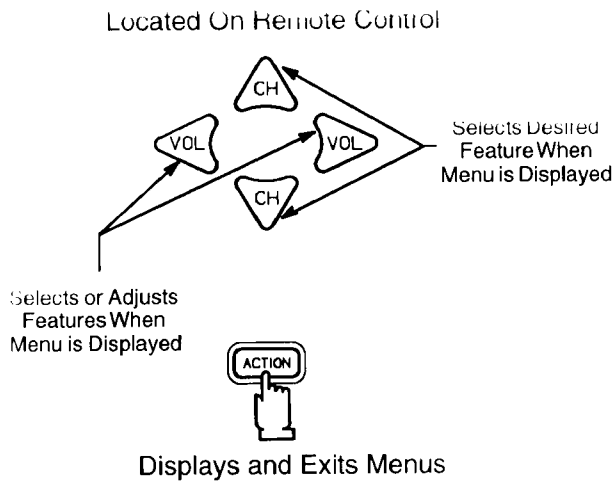

**Manual Prog (Program)** This feature allows you to select which channels are placed into Channel Scan Memory.

1. Press the ACTION button to display the Main Menu.
2. Press the CH UP/DOWN and VOL LEFT/RIGHT buttons to highlight the Set-Up Icon.
3. Press the ACTION button to display the Set-Up Menu.

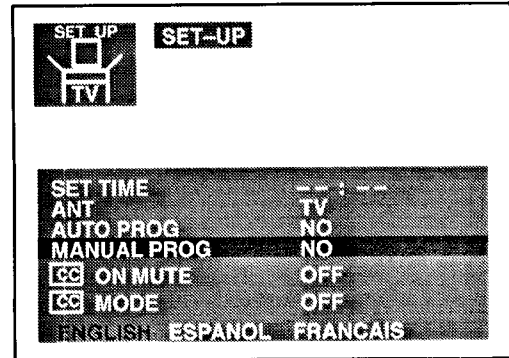

4. Press the CH DOWN button to highlight "MANUAL PROG".
5. Press the VOL LEFT or RIGHT button to display the Manual Programming Menu.

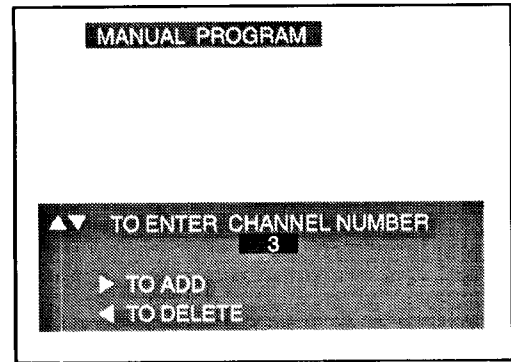

6. Use the CH UP or DOWN button or the Remote Keyboard "0 through 9" buttons to select channels.
7. Press the VOL RIGHT button to **add** channel(s) to memory (Blue). Press the VOL LEFT button to **delete** channels from memory (Yellow).
8. Repeat steps 6 and 7 to continue adding or deleting channels.
9. Press the ACTION button twice to exit the Manual Programming Menu.

## Set-Up Features (cont.)

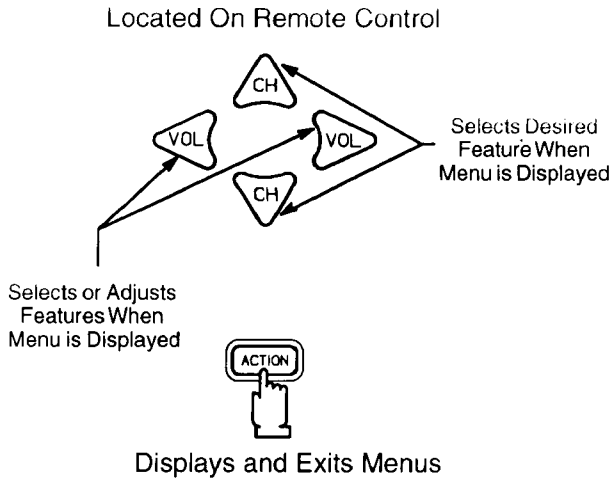

## CC (Closed Caption) On Mute

Activates the On Screen Closed Captioning when the MUTE button on the Remote Control is pressed. To deactivate press the MUTE button again.

**NOTE:** This feature only functions when the Close Caption Mode is in the "OFF" position. The program being viewed must be broadcast with Closed Caption. (Refer to your local TV guide.)

1. Press the ACTION button to display the Main Menu.
2. Press the CH DOWN and VOL RIGHT buttons to select the Set-Up Icon.
3. Press the ACTION button to display the Set-Up Menu.

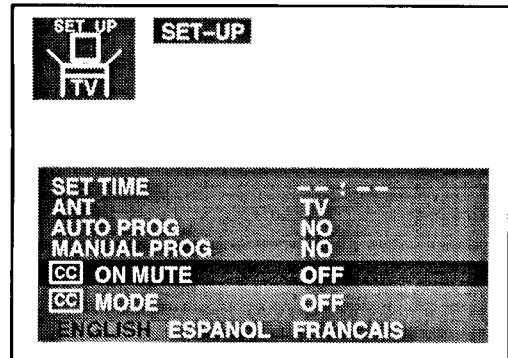

4. Press the CH DOWN button to highlight "CC ON MUTE".
5. Press the VOL RIGHT button to select OFF, C1 or C2 Mode.

### Recommended Set-Up:

- Place CC ON MUTE into the C1 Mode.
- Press the CH DOWN button to select "CC MODE".
- Press the VOL RIGHT button to select "OFF".

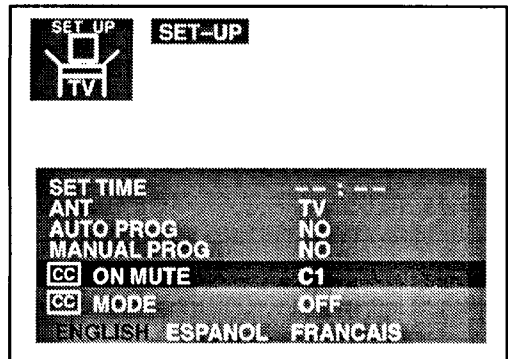

6. Press the ACTION button twice to exit the Set-Up Menu.
7. Press the MUTE button when the program being viewed is broadcast with Closed Caption to activate. Press again to deactivate.

## Set-Up Features (cont.)

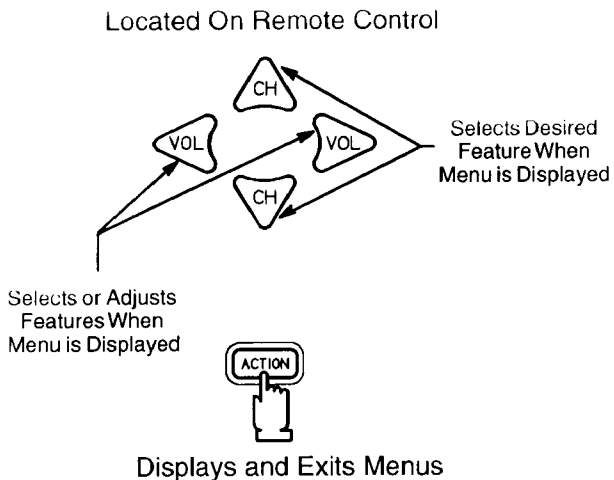

## CC (Closed Caption) Mode

This Receiver has a built in decoder that provides a visual depiction of the audio portion of a television program in the form of written words across the screen (White or Colored letters on a black background). It allows the viewer to read the dialogue of a television program or other information.

1. Press the ACTION button to display the Main Menu.
2. Press the CH UP/DOWN and VOL LEFT/RIGHT buttons to select the Set-Up Icon.
3. Press the ACTION button to display the Set-Up Menu.

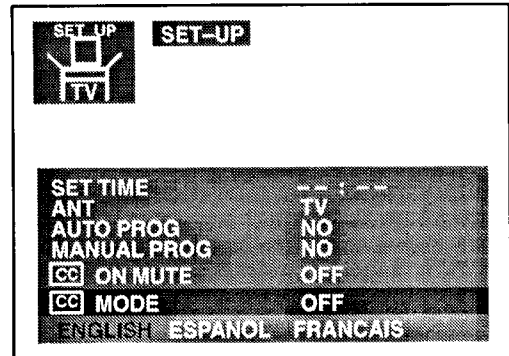

4. Press the CH DOWN button to highlight "CC MODE".
5. Press the VOL RIGHT button to select OFF, C1, or C2 .
  - OFF – Recommended mode when you do not wish to view Closed Caption.
  - C1 – For video related information that can be displayed (up to 4 lines of script strategically placed on the television screen so that it does not obstruct relevant parts of the picture). Script can be in any language.
  - C2 – Another mode used for video related information that can be displayed (up to 4 lines of script strategically placed on the television screen so that it does not obstruct relevant parts of the picture).
6. Press the ACTION button twice to exit the Set-Up Menu.

### Helpful Hints:

- Closed Caption information may be transmitted on either or both Caption Modes.



## Set-up Features (cont.)

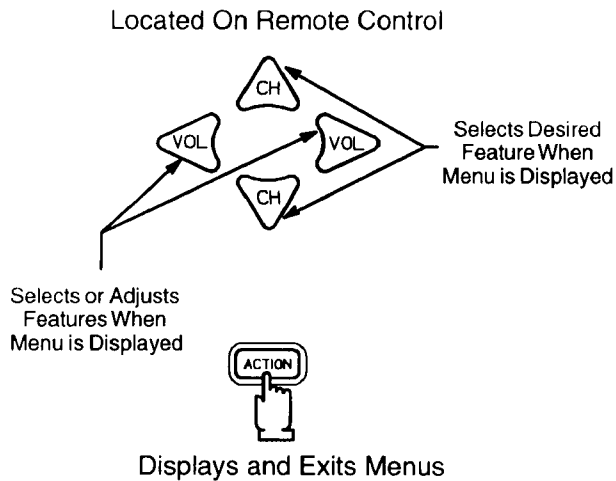

## Trilingual Menu Selection

The Language Menu is factory set to ENGLISH. Follow these instructions to change the Language Menu to Spanish or French and back to English.

1. Press the ACTION button to display the Main Menu.
2. Press the CH UP/DOWN and VOL LEFT/RIGHT buttons to highlight the SET-UP Icon.
3. Press the ACTION button to display the Set-Up Menu.

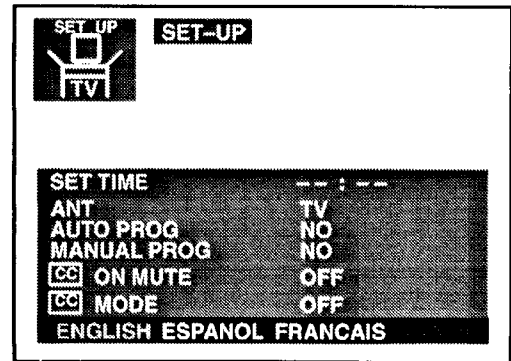

4. Press the CH UP or DOWN button to highlight "ENGLISH ESPANOL FRANCAIS."
5. Press the VOL LEFT or RIGHT button to select "ENGLISH", "ESPANOL" or "FRANCAIS".
6. Press the ACTION button twice to exit the Set-Up Menu.

### **Helpful Hints:**

Language Menu does not affect Close Caption transmitted information.

# Programming The Remote Control Using Access Codes

The remote control can be preset for other manufacturers, by utilizing the **MODE SELECTION BUTTONS** for **CABLE**, **DSS**, **VCR**, **RCVR** (a Receiver or Amplifier), **CD**, **LD**, and **AUX** (for **Cassette Players** or a **DVD**.)

## Procedure – Code Known

Procedure for setting up the remote using the numerical buttons.

- Determine brand of device.
- Identify code(s) associated with the brand in the infrared code index (located in this manual on pages 35 thru 38). Record all possible codes.
- Confirm the device is plugged in and operating properly.

**1** Press and hold the **(ACTION)** button, then the **(POWER)** button so that both are pressed at the same time for at least 5 seconds.

**2** Press the desired Mode button.

**3** Enter the three digit code, by using the Remote Control Keyboard "0 through 9" buttons.

Now your remote is set for this code.

**4** Press **(POWER)** to test your device.

**NOTE:** Some brands have multiple codes. Repeat the procedure using each listed code until the device responds correctly.

- If you enter an unlisted code, or if you do not complete your entry within 30 seconds, the settings will not change.

Code From Index Sheet

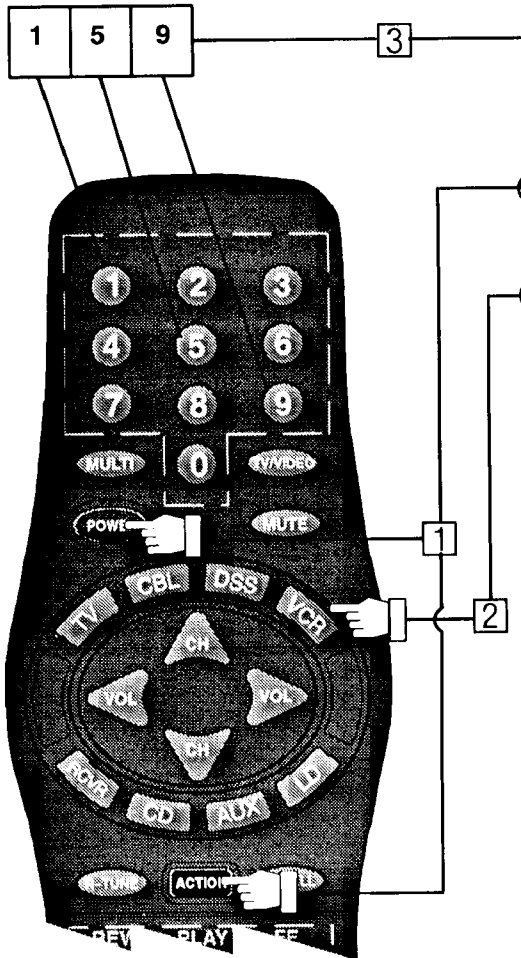

## Infrared Remote Codes for Specific Components

**Helpful Hint:** Write down the code numbers for your components in the space provided below. This will serve as a handy reference whenever you need to reprogram your remote control.

<b>CABLE</b> Cable TV Converter Box	<input type="text"/> <input type="text"/> <input type="text"/>	<b>VCR</b> Video Cassette Recorder	<input type="text"/> <input type="text"/> <input type="text"/>	<b>CD</b> Compact Disc Player	<input type="text"/> <input type="text"/> <input type="text"/>
<b>DSS</b> Digital Satellite System	<input type="text"/> <input type="text"/> <input type="text"/>	<b>RCVR</b> Receiver or Amplifier	<input type="text"/> <input type="text"/> <input type="text"/>	<b>LD</b> Laser Disc Player	<input type="text"/> <input type="text"/> <input type="text"/>
Other Component	<input type="text"/> <input type="text"/> <input type="text"/>	Other Component	<input type="text"/> <input type="text"/> <input type="text"/>	Other Component	<input type="text"/> <input type="text"/> <input type="text"/>
Other Component	<input type="text"/> <input type="text"/> <input type="text"/>	Other Component	<input type="text"/> <input type="text"/> <input type="text"/>	Other Component	<input type="text"/> <input type="text"/> <input type="text"/>

# VCR Infrared Codes Index

The Universal Infrared Remote Control is capable of operating many brands of VCRs. Refer to page 34 for programming procedures.

**NOTE:** The Universal Remote Control memory is limited. Some models of VCRs may not operate. The Universal Remote Control is not designed to control all features that are available in all models.

**NOTE:** After entering the proper infrared code, press the Remote **VCR** Selection Mode button (\*). To operate the Remote VCR function buttons, refer to pages 12 and 13 for Remote Control Key Functions.

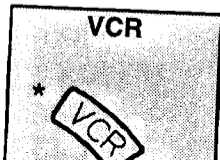

## Code Index For VCRs

VCR Brand	Code(s)	VCR Brand	Code(s)
Adventura	000	MTC	000, 240
Aiko	278	Multitech	000, 072
Aiwa	000	NEC	038, 041, 067
Akai	041, 061	Nikko	037
American High	035	Noblex	240
Asha	240	Olympus	035
Audiovox	037		

# CABLE CONVERTER BOX AND CD PLAYERS

## Infrared Codes Index

The Universal Infrared Remote Control is capable of operating many brands of Cable Converter Boxes, and CD Players. Refer to page 34 for programming procedures.

**NOTE:** The Universal Remote Control memory is limited. Some models of Cable Converter Boxes and CD Players may not operate. The Universal Remote Control is not designed to control all features that are available in all models.

**NOTE:** After entering the proper infrared code, press the Remote **CBL** Selection Mode button (☆). To operate the Remote Cable function buttons, refer to pages 12 and 13 for Remote Control Key Functions.

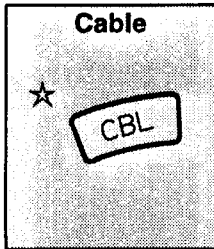

Codes For Cable Converter Box			
Brand of Cable-TV Box	Code(s)	Brand of Cable-TV Box	Code(s)
ABC	003, 007, 008, 011, 013, 014, 017	Pioneer	144, 533
Archer	153	Pulsar	000
Century	153	RCA	021
Citizen	153	Regal	020, 259
Contec	019	Rembrandt	011
Dae Ryung	008	Runco	000
Garrard	153	Samsung	144
Gemini	015	Scientific Atlanta	008, 017, 477
General Instrument	011, 476	Signal	015
Goldstar	144	Signature	011
Hamlin	009, 020, 259	Sprucer	021
Hitachi	011	Starcom	003, 015
Hytex	007	Stargate	015
Jasco	153	Starquest	015
Jerrold	003, 011, 012, 014, 015, 476	Tocom	012, 013
Memorex	000	Toshiba	000
Oak	007, 019	Tusa	015
Panasonic	000, 021, 107	Unika	153
Paragon	000	United Artists	007
Philips	153	United Cable	003
		Universal	153
		Zenith	000, 525

**NOTE:** After entering the proper infrared code press the Remote **CD** Selection Mode button (☆☆). To operate the Remote CD Player function buttons, refer to pages 12 and 13 for Remote Control Key Functions.

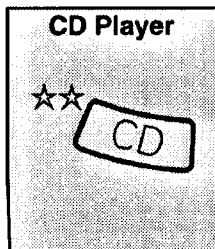

Codes For CD Players			
Brand of CD Players	Code(s)	Brand of CD Players	Code(s)
Aiwa	124, 157	Onkyo	101
CA Audio Lab	029	Optimus	000, 032, 037, 305, 426, 468
Carver	157	Panasonic	029, 367
Denon	003	Philips	157
DKK	000	Pioneer	032, 468
Emerson	305	Proton	157
Fisher	048	QED	157
Genexxa	032, 305	Quasar	029
Harman-Kardon	426	RCA	305
Hitachi	032	Rotel	157
JVC	072	SAE	157
Kenwood	028, 037, 048, 190	Sansui	157, 305
Krell	157	Scott	305
LXI	305	Sears	305
Magnavox	157	Sharp	037
Marantz	029, 157	Sherwood	426
MCS	029	Sony	000
Mission	157	Technics	029, 303
Nakamichi	147	Victor	072
NSM	157		

# CASSETTE PLAYERS, RECEIVERS, and AMPLIFIERS

## Infrared Codes Index

The Universal Infrared Remote Control is capable of operating many brands of Cassette Players, Receivers, or Amplifiers. Refer to page 34 for programming procedures:

**NOTE:** The Universal Remote Control memory is limited. Some models of Cassette Players, Receivers, and Amplifiers may not operate. The Universal Remote Control is not designed to control all features that are available in all models.

**NOTE:** After entering the proper infrared code, press the Remote **AUX** Selection Mode button (\*). To operate the Remote Cassette Player function buttons, refer to pages 12 and 13 for Remote Control Key Functions.

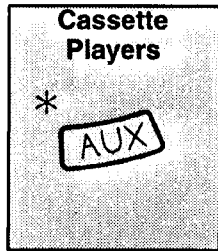

Code Index For Cassette Players			
Brand of Cassette Players	Code(s)	Brand of Cassette Players	Code(s)
Aiwa	029	Panasonic	272
Carver	029	Philips	029
Denon	076	Pioneer	027, 220
Kenwood	070	Sansui	029
Magnavox	029	Sherwood	337, 338
Marantz	029	Sony	170, 243
Nakamichi	147	Technics	229
Optimus	027, 220, 337, 338	Wards	027
		Yamaha	094, 097

**NOTE:** After entering the proper infrared code, press the Remote **RCVR** Selection Mode button (\*\*). To operate the Remote Receiver or Amplifier function buttons, refer to pages 12 and 13 for Remote Control Key Functions.

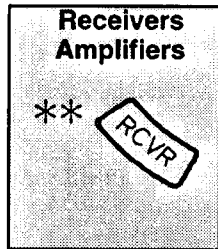

Code Index For Receivers And Amplifiers			
Brand of Receiver / Amplifier	Code(s)	Brand of Receiver / Amplifier	Code(s)
ADC	531	Panasonic	039
Aiwa	121, 158, 189	Penney	195
Carver	008, 042, 189, 269	Philips	189, 269
Casio	195	Pioneer	013, 014, 080, 300, 531
Clarinetto	195	Quasar	039
Denon	004	RCA	531
Fisher	042, 219	Realistic	195
JVC	074	Sansui	189, 321
Kenwood	027, 186	Sanyo	219
Lloyd's	195	Sharp	186
Magnavox	189, 195, 269, 531	Sherwood	502
Marantz	039, 189, 269, 321	Sony	158
MCS	039	Technics	039, 208, 308, 309, 518
Modulaire	195	Victor	074
NAD	320	Wards	013, 014, 042, 080, 158, 189
Nakamichi	321, 347	Yamaha	176, 186, 354
Onkyo	135	Yorx	195
Optimus	013, 080, 186, 219, 300, 531		

# LASER DISC, DSS (Digital Satellite System), and DVD (Digital Videodisc) Infrared Codes Index

The Universal Infrared Remote Control is capable of operating selected brands of Laser Disc, DSS Digital Satellite System, and DVD (Digital Videodisc). Refer to page 34 for programming procedures.

**NOTE:** The Universal Remote Control memory is limited. Some models of Laser Disc, DSS Digital Satellite System, and DVD (Digital Videodisc) may not operate. The Universal Remote Control is not designed to control all features that are available in all models.

**NOTE:** After entering the proper infrared code, press the Remote **LD Selection Mode** button (◊). To operate the Remote Laser Disc function buttons, refer to pages 12 and 13 for Remote Control Key Functions.



<b>Codes For Laser Disc</b>	
Brand of Laser Disc	Code(s)
Mitsubishi	059
NAD	059
Panasonic	204
Pioneer	059
Quasar	204
Sony	201

**NOTE:** After entering the proper infrared code, press the Remote **DSS Selection Mode** button (◊◊). To operate the Remote Satellite function buttons, refer to pages 12 and 13 for Remote Control Key Functions.

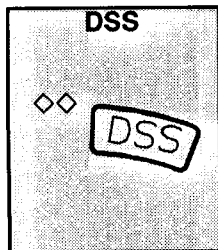

<b>Codes For DSS (Digital Satellite System)</b>	
Brand of Satellite	Code(s)
Panasonic	701
RCA	566
Sony	639



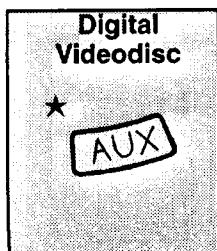















**NOTE:** After entering the proper infrared code, press the Remote **AUX Selection Mode** button (★). To operate the Remote DVD (Digital Videodisc) function buttons, refer to pages 12 and 13 for Remote Control Key Functions.

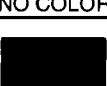

<b>Codes For DVD (Digital Videodisc)</b>	
Brand of DVD	Code(s)
Panasonic	490

# Troubleshooting Chart

Before you call for service, determine the symptoms and make a few simple checks shown below.

Symptoms		Check
Picture	Sound	
 SNOWY PICTURE	 NOISY SOUND	<ul style="list-style-type: none"> <li>- ANTENNA LOCATION AND/OR CONNECTION</li> </ul>
 MULTIPLE IMAGE	 NORMAL SOUND	<ul style="list-style-type: none"> <li>- ANTENNA DIRECTION AND/OR LOCATION</li> <li>- ANTENNA LEAD-IN WIRE</li> </ul>
 INTERFERENCE	 NOISY SOUND	<ul style="list-style-type: none"> <li>- ELECTRICAL APPLIANCES, LIGHTS, CARS AND TRUCKS</li> <li>- DIATHERMY AND OTHER MEDICAL EQUIPMENT</li> </ul>
 NORMAL PICTURE	 NO SOUND	<ul style="list-style-type: none"> <li>- VOLUME CONTROL SETTING</li> <li>- MUTE CONTROL (IF APPLICABLE)</li> <li>- TRY ANOTHER CHANNEL</li> <li>- TV SPEAKERS (IF APPLICABLE) IN THE OFF MODE</li> </ul>
 NO VIDEO	 NOISY SOUND	<ul style="list-style-type: none"> <li>- TV OR CABLE TUNING MODE SET TO PROPER SETTING</li> <li>- ANTENNA INPUT CORRECT (IF APPLICABLE)</li> </ul>
 NO PICTURE	 NO SOUND	<ul style="list-style-type: none"> <li>- CHECK THAT AC POWER LINE IS PLUGGED INTO AC OUTLET</li> <li>- BRIGHTNESS &amp; AUDIO CONTROLS SET PROPERLY</li> <li>- TRY ANOTHER CHANNEL</li> </ul>
 NO COLOR	 NORMAL SOUND	<ul style="list-style-type: none"> <li>- COLOR CONTROL SETTINGS</li> <li>- TRY ANOTHER CHANNEL</li> </ul>
 BLUE PICTURE	 NO SOUND	<ul style="list-style-type: none"> <li>- RECEIVER IN VIDEO MODE WITH NO SIGNAL</li> </ul>
 BLACK BOX IN PICTURE	 SOUND	<ul style="list-style-type: none"> <li>- CC (CLOSED CAPTION) IN TEXT MODE (IF APPLICABLE)</li> <li>- SELECT CAPTION OFF MODE TO ELIMINATE BLACK BOX</li> </ul>

Should this unit turn ON momentarily and then turn OFF, or fail to operate, unplug the AC cord and contact your Authorized Servicer for repairs.

## Power Loss

Prolonged power interruption causes the following features to reset to their factory preset state.

FEATURE	FACTORY PRESET STATE	FEATURE	FACTORY PRESET STATE
POWER	OFF	CLOCK	NOT SET
VOLUME	APPROX.-1/3	SLEEP TIMER	NO/OFF
CHANNEL	CH 03	TIMER	NO/OFF
PROGRAM MEMORY	UNPROGRAMMED	ANTENNA MODE	CABLE
VIDEO MENUS	NORMALIZED	TV/VIDEO	TV
STEREO/SAP/MONO	STEREO	TRILINGUAL MENU	ENGLISH

**Matsushita Consumer Electronics  
Company, Division of Matsushita  
Electric Corporation of America**  
One Panasonic Way  
Secaucus, New Jersey 07094

**Matsushita Electric of Canada Limited**  
5770 Ambler Drive  
Mississauga, Ontario L4W 2T3  
Canada

**Panasonic Sales Company,  
Division of Matsushita Electric  
of Puerto Rico Inc. ("PSC")**  
Ave. 65 de Infanteria, Km 9.5  
San Gabriel Industrial Park  
Carolina, Puerto Rico 00985  
Tel. (809) 705-4300  
FAX. (809) 768-2910