



VG2040/VG4040

VCR User's Guide



IMPORTANT INFORMATION

WARNING

RISK OF ELECTRIC SHOCK
DO NOT OPEN

To reduce the risk of electric shock, do not remove cover (or back). No user serviceable parts inside. Refer servicing to qualified service personnel.



This symbol indicates "dangerous voltage" inside the product that presents a risk of electric shock or personal injury.



This symbol indicates important instructions accompanying the product.

WARNING

To reduce the risk of fire or shock hazard, do not expose this product to rain or moisture.

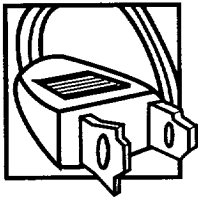

Caution: To reduce the risk of electric shock, match wide blade of plug to wide slot, fully insert.

Attention: Pour éviter les chocs électriques, introduire la lame la plus large de la fiche dans la borne correspondante de la prise et pousser jusqu'au fond.

Refer to the identification/rating label located on the back panel of your product for its proper operating voltage.

FCC Regulations state that unauthorized changes or modifications to this equipment may void the user's authority to operate it.

Cable TV Installer: This reminder is provided to call your attention to Article 820-40 of the National Electrical Code (Section 54 of the Canadian Electrical Code, Part 1) which provides guidelines for proper grounding and, in particular, specifies that the cable ground shall be connected to the grounding system of the building as close to the point of cable entry as practical.

Product Registration

Please fill out the product registration card and return it immediately. Returning this card allows us to contact you if needed.

Keep your sales receipt to obtain warranty parts and service and for proof of purchase. Attach it here and record the serial and model numbers in case you need them. The numbers are located on the back of the product.

Model No. VG4061

Serial No. _____

Purchase Date: _____

Dealer/Address/Phone: _____

TABLE OF CONTENTS

First Things First	3
Setting up the VCR	7
Using the Menu to Set Up Features	8
Language	8
VCR Channels List	8
To Auto Channel Search	9
To Change the Signal Type	10
To Add or Remove Channels	10
Time and Date	10
Set Daylight-Saving Time	11
Set the Time and Date	11
VCR Plus+ Channels	12
Additional Set-up Features in the PREFERENCES Menu ...	14
Remote VCR1/VCR2 Option	15
Auto Play	16
Auto TV/VCR	16
VCR Basics	17
Remote Buttons	18
Component Buttons	18
VCR Function Buttons	18
TV Function Buttons	19
Playing a Tape	20
Tape Eject	20
Recording	21
Check the Safety Tab	21
Automatic Rewind	21
Recording	23
Recording Features	24
Express Recording	24
Timer Recording	25
VCR Plus+ Recording	26
Stopping a Timer Recording	28
Reviewing and Clearing Programs	28
Using Two VCRs for Copying and Editing Tapes	29
Programming the Remote	31
To Control a TV	32

TABLE OF CONTENTS

Other Features	35
Picture Search Options	36
Forward and Rewind Search	36
Slow Motion	36
Commercial Scan (SEARCH Button)	36
Frame Advance	37
Index Search	37
Zero Search	38
Time Counter	38
On-Screen Displays	39
Tracking	39
Connections	41
Things to Know Before Connecting Components	41
Connecting Your VCR	42
Jacks and Cables	42
Choosing a VCR Connection	43
Advantages of Audio/Video Cable Connections	43
Don't Forget About the Auto TV/VCR Feature	43
TV With RF Jack Only	44
TV With Audio/Video Jacks	45
TV With Audio/Video Jacks and Cable Box to Unscramble Pay Channels Only	46
Appendix A: Reference	47
Front Panel	48
Display Panel	49
Back Panel	50
Troubleshooting Tips	51
Specifications	54
Cleaning the VCR	54
Limited Warranty	55
Index	56

FIRST THINGS FIRST

Hi, my name is SUSAN...

and I wrote this User's Guide. It's my job to see that you have a rewarding user manual experience. Also, I think you'll be pleased with the features that can be accessed through the on-screen menus.

Read the First Three Sections

The first three sections of the manual introduce you to your VCR, and show you how to set the VCR up and use the on-screen menus. Reading these sections gives you the basic information you need to use your VCR.

What's Left?

The rest of the book highlights playback and recording information, contains a detailed connections section, and a reference section that includes troubleshooting tips, limited warranty, and index.

1 FIRST THINGS FIRST



2 SETTING UP THE VCR



3 VCR BASICS



4 RECORDING



5 PROGRAMMING THE REMOTE



6 OTHER FEATURES



7 CONNECTIONS

READ ME!

These note boxes give you tips for your new video cassette recorder.

FIRST THINGS FIRST

Step 1: Unpack What's in the Box

The following items come packed in the box:

- VCR
- Remote control
- RF coaxial cable

Step 2: Install Batteries in the Remote Control

Follow these steps whenever you need to install or change the batteries in your VCR remote.

1. Remove the cover of the battery compartment.
2. Place batteries in remote, matching the + and – ends of each battery to the diagram inside the compartment.
3. Replace the cover.

Step 3: Connect Your VCR

If you connect your VCR to your home antenna or cable system and then to your TV, use the VCR's ANT.IN and RF OUT jacks for a good signal as shown.

If you have a TV with AUDIO/VIDEO jacks, use the audio/video jacks on the TV and VCR for a better connection. Refer to the *Connections* section, toward the back of the manual.

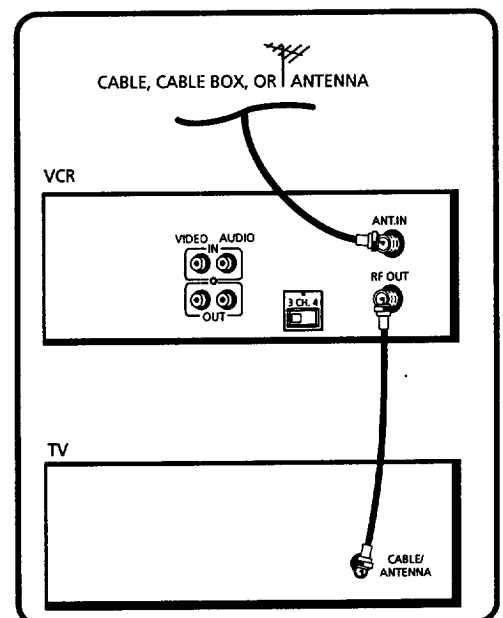

FIRST THINGS FIRST

Step 4: Plug in the VCR

Match the wide blade of the plug with the wide slot in the outlet. Be sure to insert the plug completely.

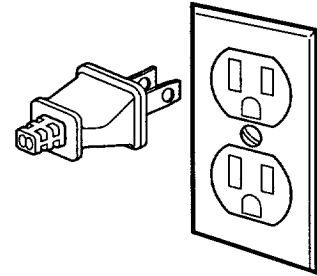

Step 5: Tune the TV

Tune the TV to the VCR viewing channel. The VCR viewing channel is channel 3 or 4 or the TV's video input.

- If you connect your VCR using the ANT.IN and RF OUT jacks with RF coaxial cable, set the 3 CH. 4 switch to channel 3 or channel 4--the channel you want to use on your TV.
- If you connect your VCR using the AUDIO/VIDEO jacks with audio/video cables, select the TV's video input to see the signal. See the *TV Owner's Manual*.

Step 6: Turn On the VCR

Press VCR on the remote to turn on the VCR.

Step 7: Access the Menus

The MENU and number buttons let you access, select, and change menu items. For example, to change the Auto Play setting, you would do the following:

1. Press MENU to bring up the VCR MAIN MENU.

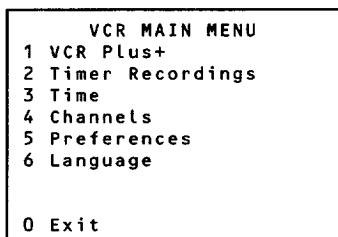

VCR Viewing Channel

When using the ANT. IN and RF OUT jacks to connect your VCR, tune your TV to channel 3 or 4.

When using the AUDIO/VIDEO jacks to connect your VCR, tune your TV to the TV's video input channel.

FIRST THINGS FIRST

2. Press 5 to display the PREFERENCES menu.

```

      PREFERENCES
1 Remote Control: VCR1
2 Auto Play:      ON
3 Auto TV/VCR:   ON

0 Exit

```

3. Press 2 to switch Auto Play ON or OFF.

```

      PREFERENCES
1 Remote Control: VCR1
2 Auto Play:      OFF
3 Auto TV/VCR:   ON

0 Exit

```

See *Setting Up the VCR* for detailed information about the Auto Play feature.

Step 8: Set Up the VCR

Once you understand how to move around and/or through the menus, go to the next section to set up your VCR.

SETTING UP THE VCR

Set-Up Features

Below is a list of set-up features that you may want to set up before you begin using your VCR for the first time:

- Select a Language
- Set up VCR Channel List (Auto Channel Search)
- Set Automatic Daylight-Saving Time
- Set the Time and Date
- Set up VCR Plus+ Channels
- Set the Remote VCR1/VCR2 feature
- Set the Auto Play feature
- Set the Auto TV/VCR feature

1 FIRST THINGS FIRST



2 SETTING UP THE VCR



3 VCR BASICS



4 RECORDING



5 PROGRAMMING THE REMOTE



6 OTHER FEATURES



7 CONNECTIONS

SETTING UP THE VCR

Using the Menu to Set Up Features

You can set up features by using the menu system. Each feature is explained in this section.

Language

Select your preferred language, and the on-screen displays will appear in that language.

1. Press MENU to display the VCR MAIN MENU.

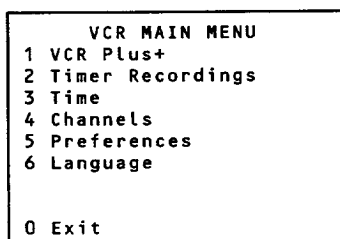

2. Press 6 to display the LANGUAGE menu.

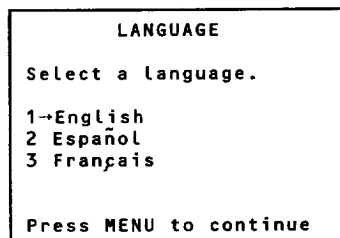

3. Press 1 for English, 2 for Español (Spanish), or 3 for Français (French).

VCR Channels List

If you use a cable box for *all channels*, this step is not necessary. Your VCR may come with a channel list preset at the factory. Even though your VCR may come with a list, it's possible that you may want to add or eliminate some channels depending on whether they are active.

On-screen Menus

Not all the VCR screens are shown in this manual when explaining the features.

All Channels

If you do not use a cable box for *ALL* channels, then you will want to use a channel list (Auto Channel Search).

SETTING UP THE VCR

To Auto Channel Search

Auto channel search memorizes the channels available through your signal type--cable or antenna.

1. Press MENU to display the VCR MAIN MENU.

```
VCR MAIN MENU
1 VCR Plus+
2 Timer Recordings
3 Time
4 Channels
5 Preferences
6 Language

0 Exit
```

2. Press 4 to display the CHANNELS menu.

```
CHANNELS
1 Auto Channel Search
2 Add/Remove Channels
3 Signal Type: CABLE
4 VCR Plus+ Channel List

0 Exit
```

3. Press 1 to display the AUTO CHANNEL SEARCH menu.

```
AUTO CHANNEL SEARCH
What type of signal
are you using?
1 Cable TV
2 Antenna
3-Detect Automatically
0 Cancel
```

4. Select one of the three AUTO CHANNEL SEARCH options. Choices one and two are self-explanatory. If you choose Detect Automatically, the VCR automatically detects which signal system you have attached to your VCR.

```
AUTO CHANNEL SEARCH

Now scanning channel 14

Press any key to cancel
```

Detect Automatically

A strong cable or antenna signal in your area may cause Auto Detect to mis-detect. If this should happen, select 1 or 2 for the system you have.

Auto Channel Search

Use the Auto Channel Search feature to place all available channels in memory.

If you ever change cable or antenna systems, you may need to Auto Channel Search again.

SETTING UP THE VCR

The VCR begins scanning for the available channels--this takes about one to two minutes. The lowest channel is tuned once the search is completed. Pressing CHANNEL up or down now selects the active channels.

To Change the Signal Type

1. Press MENU to display the VCR MAIN MENU.
2. Press 4 to display the CHANNELS menu.
3. Press 3 to change the Signal Type between CABLE and ANTENNA.

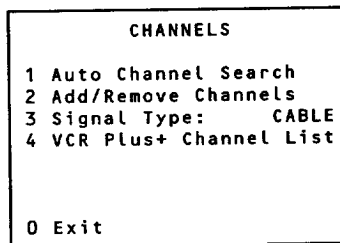

To Add or Remove Channels

You may want to add or delete channels after you Auto Channel Search, especially if some of the channels have weak signals or you don't want to watch them.

1. Press MENU to display the VCR MAIN MENU.
2. Press 4 to display CHANNELS menu.
3. Press 2 to display the ADD/REMOVE CHANNELS menu. Use the CHANNEL up or down, or number buttons, to go to the channels you want to remove or add.

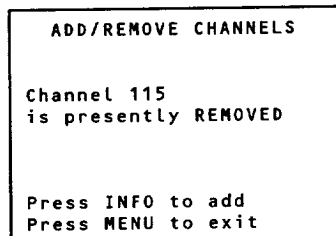
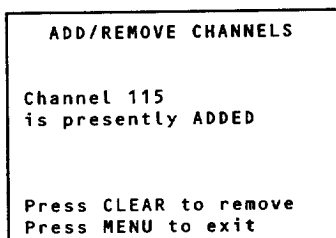

Time and Date

Before you set the time and date, set the Auto DST (Daylight-Saving Time) feature to ON or OFF for your area.

Selecting Channels

The CHANNEL up and down buttons access those channels active in your VCR channel list.

You can still access channels not in the channel list by using the number buttons on the remote control.

SETTING UP THE VCR

Set Daylight-Saving Time

1. Press MENU to display the VCR MAIN MENU.

```
VCR MAIN MENU
1 VCR Plus+
2 Timer Recordings
3 Time
4 Channels
5 Preferences
6 Language

0 Exit
```

2. Press 3 to display the TIME menu.

```
TIME
1 Set time and date
2 Auto DST: ON

0 EXIT
```

3. Press 2 to turn the Auto DST ON or OFF.
 - Select ON if you want the VCR's clock to automatically adjust for daylight-saving time.
 - Select OFF if you do not want the VCR's clock to adjust for daylight-saving time.

Set the Time and Date

1. Press MENU to display the VCR MAIN MENU.

```
VCR MAIN MENU
1 VCR Plus+
2 Timer Recordings
3 Time
4 Channels
5 Preferences
6 Language

0 Exit
```

2. Press 3 to display TIME menu.

```
TIME
1 Set time and date
2 Auto DST: ON

0 EXIT
```

Time and Date

The time and date must be set before a timer recording can be programmed.

Spring forward; Fall backward

In the Spring, daylight-saving time begins on the first Sunday in April. Because the clock automatically changes from 2:00 AM to 3:00 AM (forward one hour), remember to include the extra hour for timer recording that falls within this time frame.

In the Autumn, daylight-saving time ends on the last Sunday in October. The VCR clock automatically changes from 2:00 AM to 1:00 AM (back one hour). Therefore, it can affect your recording length.

SETTING UP THE VCR

3. Press 1 to display the SET TIME AND DATE screen.

```
SET TIME AND DATE
Time --:--
  (hh:mm)
Date --/--/--
Press MENU to cancel
```

4. Enter the data using the number buttons. Press 0 before single-digit numbers and follow the on-screen directions.

```
SET TIME AND DATE
Time 12:34 PM
Date 11/18/97 Tuesday
Press CLEAR to correct
Press MENU to set
```

VCR Plus+ Channels

Using VCR Plus+ can make programming timer recordings for cable or off-air antenna easier, but you have to put in a little time right now to set up a channel list. A worksheet and abbreviated codes for typical cable services in the U.S. and Canada are provided on the following pages.

1. Press MENU to display the VCR MAIN MENU.

```
VCR MAIN MENU
1 VCR Plus+
2 Timer Recordings
3 Time
4 Channels
5 Preferences
6 Language
0 Exit
```

Time/Date Display

Pressing INFO on the remote displays the time and date on the screen.

VCR Plus+ Channel List

Refer to your local television list for a complete VCR Plus+ channel list for your viewing area or contact your cable company. Using the list may save you some time.

SETTING UP THE VCR

2. Press 4 to display the CHANNELS menu.

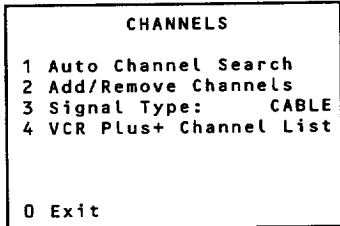

3. Press 4 to display the VCR Plus+ Channel List screen.

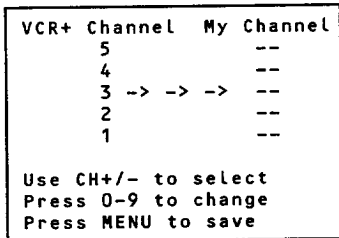

4. Enter the data following the on-screen directions using your worksheet.

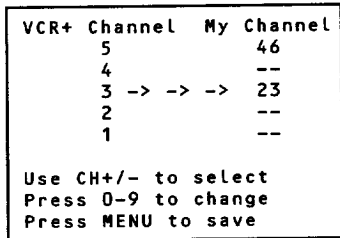

Screen is for an example only.

Additional Set-up Features in the PREFERENCES Menu

The features in this section are all accessed through the PREFERENCES menu.

- ### Two-Digit VCR Plus+ Channel Numbers for Cable TV (Canadian List)

 - 67 Allarcom Pay Television/ Superchannel
 - 44 Arts & Entertainment
 - 72 Cable News Network-Headline News
 - 61 Cable News Network
 - 70 Canadian Home Shopping Network
 - 56 Canal Famille
 - 69 Cathay International Television Inc
 - 68 Chinavision Canada Corp
 - 60 Country Music Television
 - 63 Family Channel
 - 62 First Choice
 - 96 First Choice Two
 - 97 First Choice Three
 - 99 First Choice Four
 - 90 House of Commons
 - 91 La Chaine Francaise
 - 51 The Learning Channel
 - 65 MeteoMedia/The Weather Network
 - 48 MuchMusic Network
 - 55 MusiquePlus
 - 52 Nashville Network
 - 73 Newsworld/CBC
 - 53 Le Reseau des Sports
 - 43 The Sports Network
 - 64 Super Ecran
 - 37 Super Ecran B
 - 98 Super Ecran C
 - 66 Telatino Network
 - 46 TV5 Montreal
 - 92 Viewer's Choice 1
 - 93 Viewer's Choice 2
 - 94 Viewer's Choice 3
 - 95 Viewer's Choice 4
 - 71 Vision TV: Canada's Faith Network
 - 38 Youth TV, Canada Inc.

SETTING UP THE VCR

1. Press MENU to display the VCR MAIN MENU.

```
VCR MAIN MENU
1 VCR Plus+
2 Timer Recordings
3 Time
4 Channels
5 Preferences
6 Language

0 Exit
```

2. Press 5 to display the PREFERENCES menu.

```
PREFERENCES
1 Remote Control: VCR1
2 Auto Play:      ON
3 Auto TV/VCR:   ON

0 Exit
```

Now you are ready to select an item from the menu to set up.

Remote VCR1/VCR2 Option

If you own a compatible GE, RCA, or ProScan remote that has a VCR2, VCR2•LD, or VCR2 •DVD button, this feature allows you to set this VCR to respond to that button.

Press 1 to select the Remote Control item in the menu. Then press the VCR2, VCR2•LD, or VCR2 •DVD button to change.

```
PREFERENCES
1 Remote Control: VCR1
2 Auto Play:      ON
3 Auto TV/VCR:   ON

0 Exit
```

```
PREFERENCES
(PRESS VCR2 TO CHANGE)
2 Auto Play:      ON
3 Auto TV/VCR:   ON

0 Exit
```

The VCR will only respond to the compatible remote's VCR2, VCR2•LD, or VCR2 •DVD button. If you change the remote setting to VCR2, the remote that came with your VCR will no longer control the VCR.

Use the compatible remote to change the remote setting back to VCR1. Display the PREFERENCES menu, press 1, and then press VCR1. Then the remote that came with the VCR will be able to control it again.

Remote Control Option

Changing the Remote Control option to VCR2 disables the remote that came with your VCR.

SETTING UP THE VCR

Auto Play

This feature allows the VCR to automatically start playing when you insert a tape with the safety tab removed. Press 2 to switch between ON or OFF.

- Select ON if you want a tape with its safety tab removed to start playing automatically when the tape is inserted.
- Select OFF if you *do not* want a tape with its safety tab removed to start playing automatically.

Auto TV/VCR

This feature controls whether the TV/VCR switch changes automatically to the VCR mode when the VCR is turned on. Press 3 to switch between ON and OFF.

- Select ON if you want the VCR to switch to the VCR mode when the VCR is turned on or a cassette is inserted. *This only applies if you connect the ANT.IN and RF OUT jacks of your VCR and TV and watch your VCR on channel 3 or 4 of your TV.*
- Select OFF if you want the VCR to remain in the TV mode. This is useful if you watch your VCR on the TV's video input and you don't want your antenna/cable signal interrupted by the VCR.

Auto TV/VCR

Pressing TV•VCR on the remote will still switch between the VCR and TV mode.

VCR mode: VCR indicator in the display panel lights.

TV mode: VCR indicator turns off.

VCR BASICS

Learn the Basics to Get You Started

These VCR basics should be enough for you to begin enjoying your VCR. Learning the remote control functions, playing a recorded tape, and recording a program should do just that.

However, there are other features that enhance the enjoyment of your VCR, but they aren't necessary to get you started. If you want to learn more about your VCR, just keep reading.

1 FIRST THINGS FIRST



2 SETTING UP THE VCR



3 VCR BASICS



4 RECORDING



5 PROGRAMMING THE REMOTE



6 OTHER FEATURES



7 CONNECTIONS

VCR Basics tells you what you need to know in order to watch a movie or tape your favorite show.

VCR BASICS

Remote Buttons

The remote control is capable of controlling your VCR and many brands of televisions. If you have a GE, RCA, or ProScan TV, you may be able to control it without programming the remote.

Component Buttons

OFF Turns off VCR when remote is set to control the VCR. Also turns some compatible TVs on and off.

TV Turns on a compatible GE, RCA, or ProScan TV and sets the remote to control the TV. Also used with the OFF button to turn on a different brand of TV (if programmed) and sets the remote to control the TV.

VCR Turns on a compatible GE, RCA, or ProScan VCR and sets the remote to control the VCR.

VCR Function Buttons

CHAN Up or Down Selects next higher or lower channel in the VCR's channel memory.

CLEAR Resets time counter to 0:00:00. Allows you to change entries when setting the clock or a timer recording.

F.ADV Lets you view one frame with each press of the button when tape is in pause.

FORWARD Fast forwards the tape when the VCR is stopped. Searches forward through a tape during playback. Starts slow-motion playback when tape is paused.

GO BACK Switches between two channels. Select one channel and then select another using the number buttons. Press GO BACK to switch between the two channels. In menu mode, press to go back to previous menu.

INFO Shows the status displays on the TV screen.

INPUT Selects between the line input and the VCR's tuner. Line input refers to the signal coming from the component connected to the audio/video input jacks on the back of the VCR.

MENU Brings up VCR MAIN MENU on the TV screen.

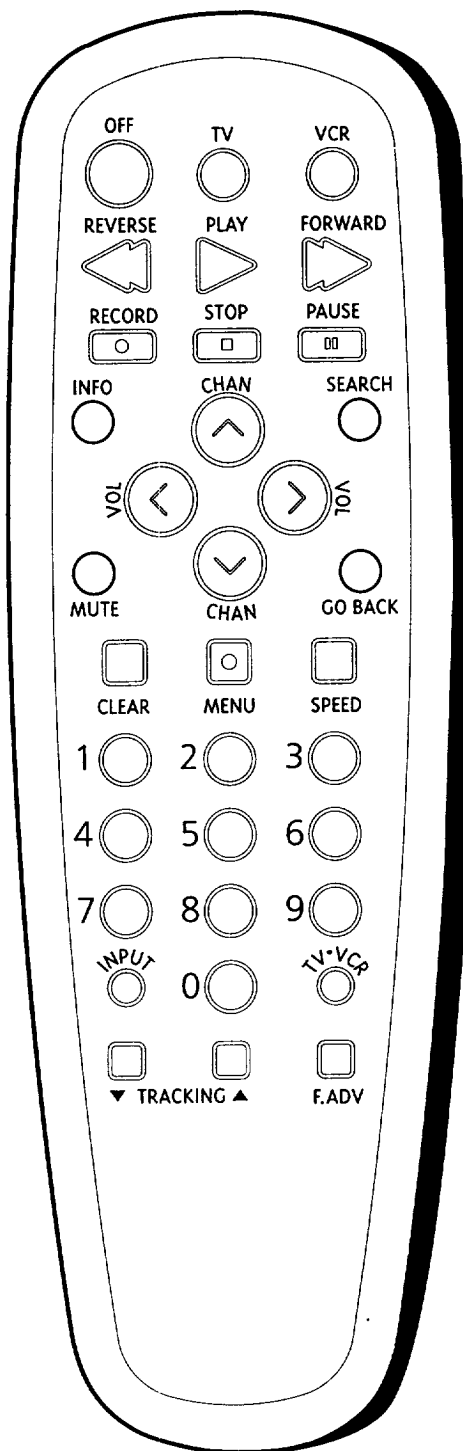

VCR BASICS

Numbers (0 through 9) Select a channel up to 99 by pressing two numbers. Select a cable channel over 99 by pressing and holding 1 until 1 -- appears on the screen. Then press the other two numbers.

OFF Turns off the VCR when the remote is set to control the VCR. Turns off other components if remote is programmed.

PAUSE Pauses playback or recording. Press PAUSE again to return to playback or recording.

PLAY Plays a tape.

RECORD Starts VCR recording. Also used for express recording.

REVERSE Rewinds the tape when the VCR is stopped. Searches backward through a tape during playback. Starts slow-motion playback when tape is paused.

SEARCH Displays Index and Zero Search menus on TV screen when VCR is stopped. Advances the tape approximately 30 seconds of recorded material during playback. Each press advances the tape an additional 30 seconds up to five minutes.

SPEED Selects a recording speed (SP or SLP).

STOP Stops the current VCR function such as record, playback, rewind, or fast forward.

TRACKING Up or Down Lets you manually reduce the streaks that may appear on the picture during play, slow motion, or pause. Reduces picture "jitter" during stop-action playback.

TV•VCR Switches the picture signal so that it either comes from the VCR or cable/antenna system.

TV Function Buttons

CHAN Up or Down Selects next higher or lower channel in the TV's channel memory.

CLEAR Removes menus or status displays from the screen.

GO BACK Switches between two channels. Select one channel and then select another using the number buttons. Press GO BACK to switch between the two channels.

INFO Shows the TV's status displays on the TV screen.

MUTE Reduces volume to minimum level.

TV Buttons

The TV buttons may not control all features of all models of GE, RCA, and ProScan TVs.

VCR BASICS

Numbers (0 through 9) Select a channel up to 99 by pressing two numbers. Select a cable channel over 99 by pressing and holding 1 until 1 -- appears on the screen. Then press the other two numbers.

OFF Turns the TV off.

VOL Up and Down Raises and lowers sound of TV.

Playing a Tape

1. Tune the TV to your VCR viewing channel (3, 4, or TV's video input).
2. Insert a tape in the VCR.

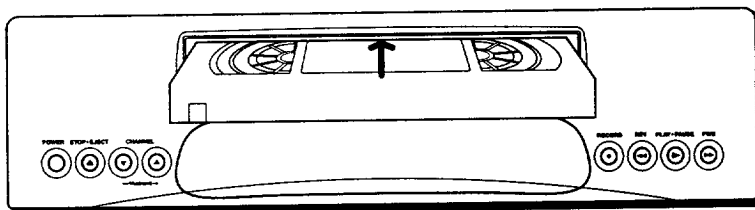

If the Auto Play feature is set to ON, the tape automatically begins playback (if the safety tab on the cassette is removed).

- Press FWD or REV (FORWARD or REVERSE on remote) to position the tape.
- Press PLAY•PAUSE (PLAY) (if necessary) to begin tape play.
- Press PLAY•PAUSE (PAUSE) for stop action.
- Press TRACKING up or down to remove any streaks from the picture, if necessary.
- Press STOP•EJECT (STOP) to stop playback.

Tape Eject

Press STOP•EJECT on the VCR when it is stopped to eject the tape.

Pause

If you pause, the VCR automatically switches from pause to stop after a few minutes to reduce tape wear.

Automatic Tracking

The VCR has automatic tracking which adjusts the picture when playing back a tape recorded on another VCR. Automatic tracking is turned on whenever a tape is inserted or the VCR's power is turned on.

VCR BASICS

Recording

If you want to record something that you're watching, you can use basic recording.

1. Set the tape speed by pressing the SPEED button on the remote (see margin note for information about tape speed settings).
2. Press the RECORD button to begin recording.
3. Press STOP (STOP•EJECT on VCR) to stop recording.

If you just want to pause the recording for a short time (like during a commercial), press PAUSE (PLAY•PAUSE on VCR) instead of STOP.

Check the Safety Tab

No matter which recording option you use, you need to make sure there is a tape in the VCR, and that the tape's safety tab is in place. You cannot record on a tape with the safety tab removed.

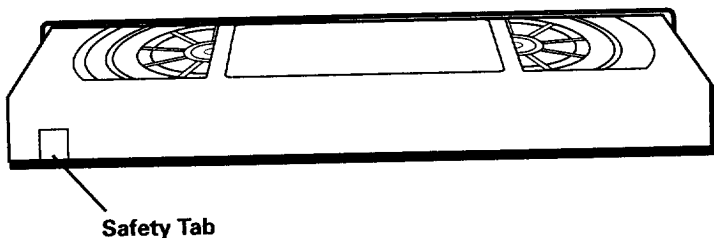

If the safety tab is removed and you want to record over it, simply cover the hole with vinyl tape.

Automatic Rewind

During playback, the VCR automatically rewinds the tape if the tape reaches the end and stops.

During recording, the VCR automatically rewinds the tape if it reaches the end. While rewinding, you can press POWER (OFF on the remote) and the VCR will turn off after rewinding.

Tape Speeds

SP (Standard Play)

Gives the best quality recording, but fewer programs can be recorded on the tape. Special effects such as pause, slow motion, picture search, and frame advance work well when you play back tapes recorded in this speed.

LP (Long Play)

Your VCR is capable of playing back tapes recorded in LP. You cannot record in the LP speed.

SLP (Super Long Play)

Gives three times the recording time of tapes recorded in SP. Special effects such as pause, slow motion, picture search, and frame advance work well when you play back tapes recorded in this speed.

Cassette	Recording Time	
	SP	SLP
T-120	2Hr	6Hr
T-160	2Hr 40Min	8Hr

RECORDING

Several Recording Options

Now that you've gone through the necessary steps to operate your VCR, I'll explain the different recording features that are available to suit your needs.

Recording features:

- Recording (explained in *VCR Basics* section)
- Express Recording
- Timer Recording
- Copying and Editing Tapes

1 FIRST THINGS FIRST



2 SETTING UP THE VCR



3 VCR BASICS



4 RECORDING



5 PROGRAMMING THE REMOTE



6 OTHER FEATURES



7 CONNECTIONS

RECORDING

Recording Features

There are four ways to record programs:

- **Recording** lets you press one button to start recording a program. (See *VCR Basics* section.)
- **Express Recording** lets you start recording a program you are watching, and then set the VCR to automatically stop recording after a designated period of time.
- **Timer Recording** lets you program the VCR to automatically start and stop recording at a predetermined time.
- **Timer Recording with VCR Plus+** lets you program the VCR just by entering a PlusCode number found in some TV guides.

Express Recording

Use express recording when you want to quickly record the remaining portion of the program you are watching.

1. Set the tape speed by pressing the SPEED button on the remote.
2. Press the RECORD button to begin recording.
3. Repeatedly press the RECORD button to set up the recording duration.

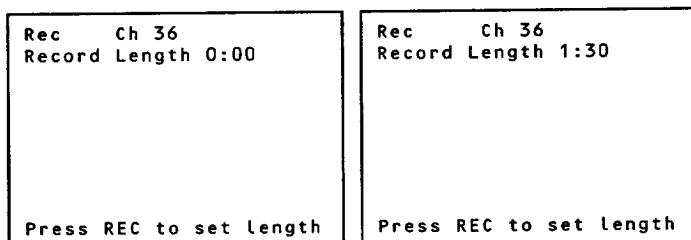

Each press of the RECORD button increases the recording time (up to 4 hours).

The VCR continues to record for the amount of time you indicate, and then automatically turns off.

Express Recording

Express recording is a great way to tape the last quarter of the game, or the last part of a movie when you have to leave.

To stop an express recording, press and hold STOP on the remote for a few seconds (STOP-EJECT on the VCR).

RECORDING

Timer Recording

You can set up as many as eight timer recording programs.

1. Press MENU to display the VCR MAIN MENU.

```
VCR MAIN MENU
1 VCR Plus+
2 Timer Recordings
3 Time
4 Channels
5 Preferences
6 Language

0 Exit
```

2. Press 2 to display the TIMER RECORDINGS menu.

```
TIMER RECORDINGS

1 Create a New Program
2 Review Existing Progs.
3 Use VCR Plus+ Code

0 Exit
```

3. Select 1 to Create a New Program.

```
How often should this
program record?

1 One time
2 Daily (every day)
3 Weekdays (M-F)
4 Weekly (once per week)

0 Cancel
```

4. Select how often you want the program to record.

```
Program 1 (One time)

Channel  --
Start Time  --:--
End Time  --:--
Start Date  --/--/--
Tape Speed SLP

Press MENU to cancel
```

5. Enter the data for the program with the number buttons.

The data includes the channel number (press INPUT to select the line input), start time including AM or PM, end time. The start date is automatically entered based on the VCR clock. Both the date and speed can be changed when flashing.

Timer Recording Information

Clock must be set correctly.

Insert a tape with the safety tab in place and enough tape to record the program.

PROGRAMS OVERLAP appears if you have entered two programs where the times overlap.

For cable box, turn on the cable box and tune it to the channel you want to record before the recording is to begin.

RECORDING

- Review the information to make sure it is correct, and then press MENU to save.

```
Program 1 (One time)
Channel    03 Cable
Start Time 08:00 PM
End Time   09:30 PM
Start Date 10/24/97 Fri
Tape Speed SLP
           1=SP 2=SLP
Press CLEAR to correct
Press MENU to save
```

```
Program 1 has been saved
Remember to insert a
recordable tape and
turn the VCR off before
the program start time.
Press MENU to continue
```

Timer Recording with VCR Plus+

You can use VCR Plus+ to simplify timer programming if you have cable TV and don't receive all channels through a cable box or if you get your TV signal off-air.

Setting Up the Channel List

If you did not set up the VCR Plus+ channel list, you can do it now.

- Display the CHANNELS menu from the VCR MAIN MENU.
- Display the VCR Plus+ Channel List screen.
- Go to *Setting Up Your VCR* if you need more information on setting up your VCR Plus+ Channel List.

```
VCR MAIN MENU
1 VCR Plus+
2 Timer Recordings
3 Time
4 Channels

CHANNELS
1 Auto Channel Search
2 Add/Remove Channels
3 Signal Type: CABLE
4 VCR Plus+ Channel List

VCR+ Channel My Channel
5          46
4          --
3 -> -> -> 23
2          --
1          --

Use CH+/- to select
Press 0-9 to change
Press MENU to save
```

Using VCR Plus+

- Press MENU to bring up the VCR MAIN MENU.

```
VCR MAIN MENU
1 VCR Plus+
2 Timer Recordings
3 Time
4 Channels
5 Preferences
6 Language

0 Exit
```

- Press 1 to display the VCR PLUS+ menu.

```
VCR PLUS+
Enter pluscode number
(from TV listing)
_

Press MENU to cancel
```

VCR Plus+ and PlusCode are registered trademarks of Gemstar Development Corporation.

RECORDING

3. Enter the VCR PlusCode shown in your local television programming guide.

```
VCR PLUS+
Enter pluscode number
  (from TV listing)
  12876

Press CLEAR to correct
Press MENU when done
```

4. Press MENU to enter the VCR PlusCode number.

```
How often should this
program record?

1 One time
2 Daily (every day)
3 Weekdays (M-F)
4 Weekly (once per week)

0 Cancel
```

5. Indicate how often you want the program to be recorded.

```
Program 1 (One time)

Channel    03 Cable
Start Time 08:00 PM
End Time   09:30 PM
Start Date 11/18/97 Tue
Tape Speed SLP

Press CLEAR to adjust
Press MENU to save
```

6. Change the speed with the SPEED button on the remote or the program end time with the CLEAR button on the remote (if necessary).

Changing the end time comes in handy when you are recording a program such as a sporting event that may exceed the scheduled broadcast time.

7. Press MENU to save the program.

```
Program 1 has been saved

Remember to insert a
recordable tape and
turn the VCR off before
the program start time.

Press MENU to continue
```

VCR Plus+ Recording

Clock must be set correctly.

Insert a tape with the safety tab in place and enough tape to record the program.

PROGRAMS OVERLAP appears if you have entered two programs where the times overlap.

UNRECOGNIZED NUMBER... PLEASE RE-ENTER appears when the VCR does not recognize the PlusCode number.

Turn on the cable box and tune it to the channel you want to record before the recording is to begin.

RECORDING

Stopping a Timer Recording

To stop or cancel a timer recording in progress (even an express recording):

- Press and hold the STOP button on the remote (STOP•EJECT on the VCR) for a few seconds.

Reviewing and Clearing Programs

To review programs that you have already set up:

1. Press MENU to display the VCR MAIN MENU.
2. Press 2 to display the TIMER RECORDINGS menu.

```
TIMER RECORDINGS
1 Create a New Program
2 Review Existing Progs.
3 Use VCR Plus+ Code

0 Exit
```

3. Press 2 to display the Review Existing Progs. screen.

```
Program 1 (One time)
Channel 104 Cable
Start Time 12:00 AM
End Time 01:30 AM
Start Date 10/24/97 Fri
Tape Speed SLP

Press CLEAR to erase
Press MENU for next prog.
```

4. Press CLEAR to erase or MENU to see the next program.

RECORDING

Using Two VCRs for Copying and Editing Tapes

Use one VCR as the *playback VCR* and the other as the *recording VCR*.

1. Turn on the TV and VCRs.
2. Tune the TV to the VCR viewing channel (either 3, 4, or TV's video input).
3. If you connected your VCR using the ANT.IN and RF OUT jacks, tune *recording VCR* to channel 3 or 4—the one selected on the back of the *playback VCR*.
If you connected your VCR using the AUDIO/VIDEO jacks, make sure you select the line input on the *recording VCR*.
4. Insert the tape you want to copy into the *playback VCR*. Insert a blank tape with safety tab in place into the *recording VCR*.
5. When you reach the point on the tape or program where you want to begin copying, press PLAY•PAUSE and then PLAY•PAUSE again on the *playback VCR*. You may need to adjust the tracking.
6. Press the RECORD button, then press PLAY•PAUSE, on the *recording VCR*.
7. Press the PLAY•PAUSE buttons on *both VCRs* at the same time to begin copying the tape.
8. To edit segments that you do not want to copy:
 - Press PLAY•PAUSE on *recording VCR* to pause copying.
 - Locate the next segment you want to copy on *playback VCR* by using FWD, REV, and PLAY•PAUSE, and then press PLAY•PAUSE.
 - Press PLAY•PAUSE on *both VCRs* at the same time to resume copying.
9. Press STOP•EJECT on *both VCRs* when you are finished.

Caution:

The unauthorized recording of television programs or other copyrighted materials may infringe on the rights of others.

Two VCR Connection

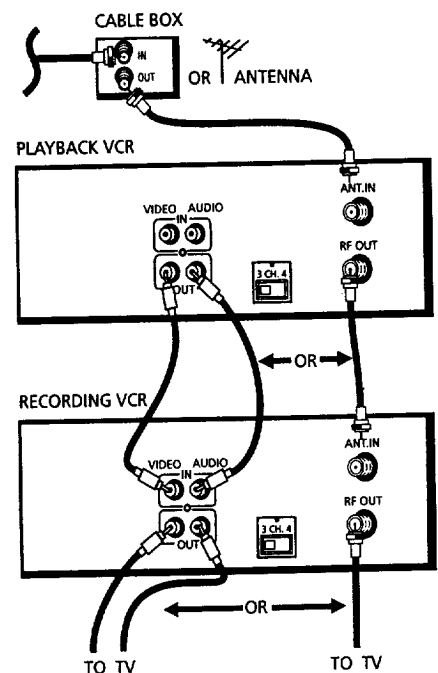

PROGRAMMING THE REMOTE

Control Your Other Components...

The remote can be programmed to control a television.

It is programmed to control a GE, RCA, or ProScan TV. Other manufacturer's brands need to be programmed.

1 FIRST THINGS FIRST



2 SETTING UP THE VCR



3 VCR BASICS



4 RECORDING



5 PROGRAMMING THE REMOTE



6 OTHER FEATURES



7 CONNECTIONS

PROGRAMMING THE REMOTE

About Programming the Remote

The remote can be programmed to control other brands of remote controllable TVs. It is already programmed to operate most GE, RCA, and ProScan TVs.

Programming the Remote to Control a TV

If the TV does not turn on when you press the TV button, the remote needs to be programmed.

Follow these steps to program the remote to control your particular TV:

1. Turn on the TV.
2. Find your TV brand and code number(s) on the code list on the next page.
3. Press and hold the TV button on the remote.
4. Enter the two-digit code from the code list.
5. Release TV, and then press CHAN up or down. If the TV responds to the remote commands, the remote is programmed.
6. If the TV does not respond, repeat these steps using the next code in the list.

Operate the TV

After you set up the remote, see which buttons operate your TV.

1. Point the remote at the TV, and press the TV button.
If the TV does not turn on, press the TV button and then press the OFF button.
2. You may want to experiment to see which buttons operate your TV. Try pressing buttons, such as VOL and MUTE. See "TV Function Buttons" in the *VCR Basic* section for details.

This remote may not operate all models of the brands that are shown. Note the difference between the TV and VCR on-screen displays to see which one the remote is operating.

PROGRAMMING THE REMOTE

TV Codes

Akai	03	NAD	07
AOC	06,12	NEC	06
Candle	06	Panasonic	04,08,11
Citizen	06	Philco	04,06,12
Colortyme	06	Philips	03,04,06,12
Concerto	06	Pioneer	06
Curtis Mathes	01,06	Portland	06,12
Daewoo	06,12	ProScan	01
Daytron	06	Proton	06
Electrohome	06,12	Quasar	11
Emerson	06	Radio Shack	01,05,13
Envision	05,06	RCA	01,06,12
Fisher	05,08	Realistic	05
GE	00,01,06,11	Sampo	06
Goldstar	06,12	Samsung	06,09,12
Hallmark	06	Sanyo	05,08
Hitachi	06,14	Sears	01,05,06,07, 08,10,12
Infinity	04	Sharp	06,13
J C Penney	00,01,06,09,12	Sony	03
JBL	04	Soundesign	06
Jensen	06	Sylvania	04,06,12
JVC	10,11	Technics	11
Kawasho	03,06	Techwood	06
Kenwood	06,12	Teknika	06
Loewe	04	TMK	06
Luxman	06	Toshiba	05,07,08,09
LXI	04,05,07	Universal	00
Magnavox	04,06,12	Victor	10
Marantz	04,06	Wards	00,01,04,06,12,13
MGA	06,12	Yamaha	12
Mitsubishi	06,12	Zenith	02
MTC	06		

OTHER FEATURES

Features to Enhance VCR Operation

- Picture Search Options
- Time Counter
- On-Screen Displays
- Tracking

1 FIRST THINGS FIRST



2 SETTING UP THE VCR



3 VCR BASICS



4 RECORDING



5 PROGRAMMING THE REMOTE



6 OTHER FEATURES



7 CONNECTIONS

OTHER FEATURES

Picture Search Options

The most basic way to search during playback is using the forward and reverse functions. This section contains several other options available for searching a tape.

Search features work well for tapes recorded at the SP or SLP speed.

Forward and Reverse Search

You can search a tape during play. Sound is turned off during picture search. Search works best for tapes recorded at the SP or SLP speed.

1. During playback, press FORWARD (FWD) to search forward or REVERSE (REV) to search in reverse.
2. Press FORWARD (FWD) or REVERSE (REV) again or press PLAY (PLAY•PAUSE) to return to normal playback.

Slow Motion

You can view a tape during play pause using slow motion.

1. Press FORWARD or REVERSE (FWD or REV) to begin slow-motion playback.
2. Use TRACKING up or down to remove any streaks from the picture.
3. Press PLAY (PLAY•PAUSE) to return to normal playback.

The VCR switches automatically from slow-motion playback to stop after a few minutes.

Commercial Scan (Search Button)

This is useful for skipping commercials or short program segments.

- Press SEARCH on the remote once during playback to advance the tape approximately 30 seconds of recorded material.
- Each press of the SEARCH button adds an additional 30 seconds up to five minutes.

Insert Tape

Remember to insert a recorded tape when using the search features.

OTHER FEATURES

Frame Advance

Frame advance lets you view one stop-action frame after another.

1. Press PAUSE (PLAY•PAUSE) to freeze the action.
2. Press F.ADV each time you want to view the next frame of the scene.
3. Press PAUSE or PLAY (PLAY•PAUSE) to return to normal playback.

Index Search

The VCR has a "VHS Index Search System" that automatically records an index mark on the tape every time you start recording. During playback you can locate the program you want to play by the number of index marks or by scanning. The VCR will search forward or reverse from the location you are on the tape.

To Search:

1. Stop the tape and press SEARCH on the remote to display the INDEX SEARCH menu on the TV screen.
2. If you want to search through a certain number of index marks, press two number buttons to enter the number of marks you want to search. Press CLEAR on the remote to correct an entry.
3. Press FORWARD (FWD) to search forward or REVERSE (REV) to search in reverse. The VCR will locate your index mark and begin playback. If you did not enter a specific index number, the VCR will locate the next index mark and begin playback.
4. Press STOP to stop index searching.

Some index marks may be missed by the VCR:

- A mark too close to your location on the tape.
- The mark at the beginning of a recorded segment of five minutes or less.
- The first index mark on the tape when you start at the beginning of the tape.

```
INDEX SEARCH
Press REV or FWD
to begin scanning
or
enter a specific
index number
  - -
Press SEARCH to exit
```

```
INDEX SEARCH
Press REV or FWD
to begin search
Index number
  12
Press SEARCH to exit
```

```
INDEX SEARCH
Searching for
index number 12...
Press STOP to cancel
```

OTHER FEATURES

Zero Search

The zero search feature enables the VCR to quickly return to a counter reading of 0:00:00 anywhere on the tape. This is especially convenient when you want to repeat a segment of the tape several times.

1. Go to the beginning of the program you wish to return to.
2. Press INFO **twice** to display the time counter on the TV screen.
3. Press CLEAR to reset the counter to 0:00:00.
4. Continue playing the tape.
5. Press STOP when you are ready to return to 0:00:00.
6. Press SEARCH on the remote **twice** to display the ZERO SEARCH menu.
7. Press REVERSE (REV) to return to 0:00:00 on the tape.

```
ZERO SEARCH
Current tape counter is
  2:17:25
Press REV to go to
  0:00:00
Press SEARCH to exit
```

```
ZERO SEARCH
Searching for
0:00:00
Press STOP to cancel
```

Time Counter

The time counter shows the actual time it takes to record a program or play back a segment of a recorded tape. It helps locate the beginning or end of programs you taped. The time counter resets to 0:00:00 whenever the tape is ejected from the VCR.

For example, if you record a 30-minute program at the beginning of the tape and you want to go to the end of that program to begin another recording, you would:

1. Press INFO **twice** to display the time counter.
2. Press CLEAR to reset the time counter to 0:00:00.
3. Press FORWARD (FWD) to forward the tape until the time counter reads 0:30:00.
4. Press STOP. This is the approximate end of the program. (You may want to press PLAY to verify.) Now, you can begin recording at this spot.
5. Press INFO to remove the time counter from the screen and return to the normal display mode.

```
0:30:00
Hours
Minutes
Seconds
```

OTHER FEATURES

On-Screen Displays

The INFO button shows the status of the VCR (STOP, PLAY, RECORD, etc.), channel number, time counter, date, time, and tape speed on the TV screen. The date and time must be set before they can be displayed.

1. Press INFO to see the on-screen displays.
2. Press INFO again to have only the time counter remain on the screen.
3. Press INFO again to return to the normal display. No displays appear on the screen.

Turning off the VCR also resets the displays.

Tracking

Your VCR has automatic tracking which removes the streaks or snow from the picture. Automatic tracking is activated when you insert a tape or turn on the VCR. Occasionally you may need to manually adjust tracking, especially if the tape was recorded on a different VCR. Just use the TRACKING buttons to remove the streaks or snow. You can also use tracking when you pause a tape to reduce jittering of the picture.

When you manually adjust the picture, automatic tracking is turned off. To turn automatic tracking back on, press both TRACKING buttons on the front of the VCR at the same time, or eject the tape and re-insert it.

Tracking has no effect during recording--only playback.

1

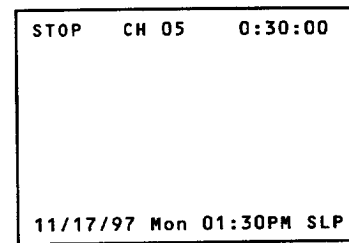

On-screen display (times out)

2

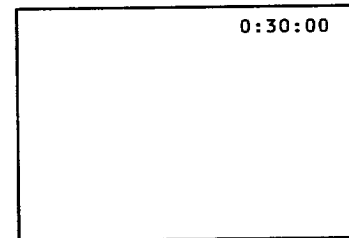

*Timer counter only
(does not time out)*

3

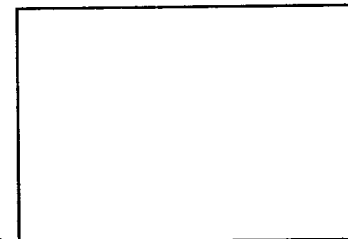

Normal display

CONNECTIONS

Things to Know Before Connecting Components

Protect Your Components from Power Surges

- Connect all components before plugging any power cords into the wall outlet.
- Always turn off the TV and other components before you connect or disconnect any cables.

Position Cables Correctly to Avoid Audio Hum or Interference

- Insert all cable plugs firmly into their jacks.
- Place the audio/video cables to the sides of the TV's back panel instead of straight down the middle after you connect your components.
- Try not to coil any twin-lead cables and keep them away from the audio/video cables as much as possible.
- Make sure all antennas and cables are properly grounded. Refer to the Safety Tips sheet packed with your unit.

Protect Your Components from Overheating

- Do not block ventilation holes in any of the components. Arrange the components so that air can circulate freely.
- Do not stack components.
- Allow adequate ventilation when placing your components in a stand.
- Place an amplifier or satellite receiver on the top shelf of the stand so heated air rising from it will not flow around other components.

1 FIRST THINGS FIRST



2 SETTING UP THE VCR



3 VCR BASICS



4 RECORDING



5 PROGRAMMING THE REMOTE



6 OTHER FEATURES



7 CONNECTIONS

CONNECTIONS

Connecting Your VCR

Refer to these pages to help you connect your VCR.

Jacks and Cables

RF Jacks and Coaxial Cables (F-type)

The RF jacks provide good picture and mono sound, and must be used if audio/video connections are not available for your TV.

These jacks are required for antenna or cable-TV connections. The RF jacks on the VCR are labeled ANT.IN and RF OUT. The coaxial cable supplied with your VCR is used to connect the VCR's RF OUT jack and your TV's antenna input.



RF Jack

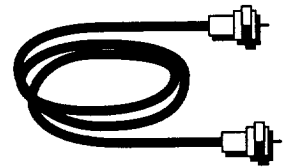

Audio/Video Jacks and Cables (RCA-type)

The AUDIO/VIDEO jacks provide very good picture and sound and can be used if your TV has audio/video input jacks.

These jacks are used for most audio/video connections. The VCR AUDIO/VIDEO jacks are color coded (yellow for video and white for audio). If your TV has two inputs for audio (stereo), connect the one labeled mono. If one is not labeled mono, you may need a Y-adapter.



Audio/Video Jack

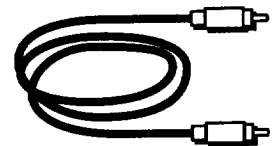

CONNECTIONS

Choosing a VCR Connection

There are several different ways to hook up your VCR, depending on whether or not you have cable, and if you have cable, whether you have a cable box, and if some of the channels are scrambled and...well, you get the picture.

Three connections are described in this section and one of them should provide you with a VCR hookup that works.

- TV with RF jack only
- TV with audio/video jacks
- TV with audio/video jacks and cable box to unscramble pay channels only

If you need to hook up additional components not shown in the diagrams here (and are unsure of how to connect them), refer to the instruction manual that came with that particular component.

Advantages of Audio/Video Cable Connections

Using a simple coaxial cable connection gives you good picture quality. If your television has audio/video jacks, I highly recommend using them to get better picture and sound quality when recording and playing back videotapes. These connections give you more convenient operation by not having to share the TV's antenna signal.

Don't Forget About the Auto TV/VCR Feature

The TV/VCR switch controls whether the picture signal is coming from the VCR or the TV.

Set the Auto TV/VCR feature to ON when using only ANT.IN and RF OUT jacks and OFF when using the AUDIO and VIDEO OUT jacks--so your TV signal is not interrupted when the VCR is turned on.

CONNECTIONS

TV With RF Jack Only

This connection assumes:

- You are connecting antenna, cable, or cable box system.
- Your television has only an RF input jack.

This connection provides:

- Mono sound playback from VCR.
- Record one channel while watching another (except when using a cable box for all channels).

To use this connection, you must have:

- (1) coaxial cable for cable or antenna connection; (2) for cable box

To connect:

1. Connect cables as shown.
2. Return to *First Things First*, then follow the steps.

Using This Connection

Tune your TV to channel 3 or 4 whichever one you selected with the 3 CH. 4 switch on the back of the VCR. Use the TV•VCR button to watch the VCR.

Auto TV/VCR setting:

- Set the Auto TV/VCR feature to ON.

To play a tape:

1. Insert a tape.
2. If necessary, press PLAY.

To record one program and watch another:

1. Begin recording a program using one of the recording options.
2. Press the TV•VCR button and select a different channel on the TV.

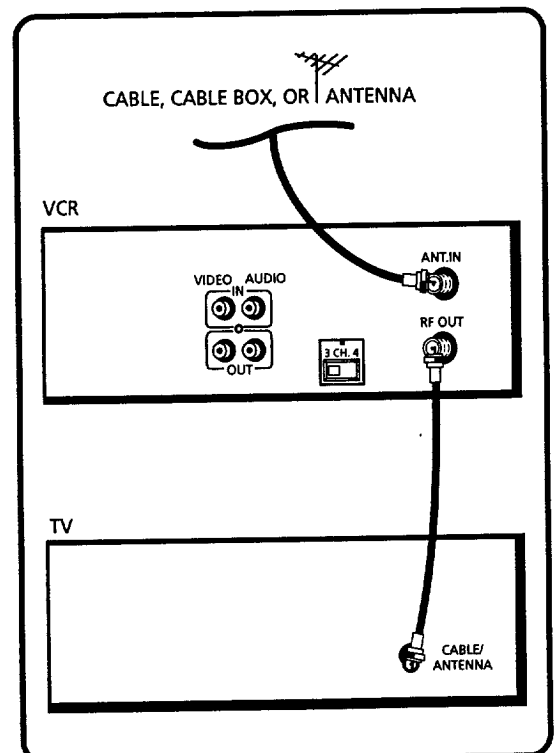

CONNECTIONS

TV With Audio/Video Jacks

This connection assumes:

- You are connecting an antenna, cable, or cable box system.
- Your television has audio/video jacks.

This connection provides:

- Mono sound playback from VCR.
- Record one channel while watching another (except when using a cable box for all channels).

To use this connection, you must have:

- (1) coaxial cable for cable/antenna connection; (2) for cable box
- (2) audio/video cables

To connect:

1. Connect cables as shown.
2. Return to *First Things First*, then follow the steps.

Using This Connection

Tune your TV to its video input channel.

Auto TV/VCR setting:

- Set the Auto TV/VCR feature to OFF. Use of TV•VCR button is not required.

To play a tape:

1. Insert a tape.
2. If necessary, press PLAY.

To record one program and watch another:

1. Begin recording a program using one of the recording options.
2. Select a different channel on the TV.

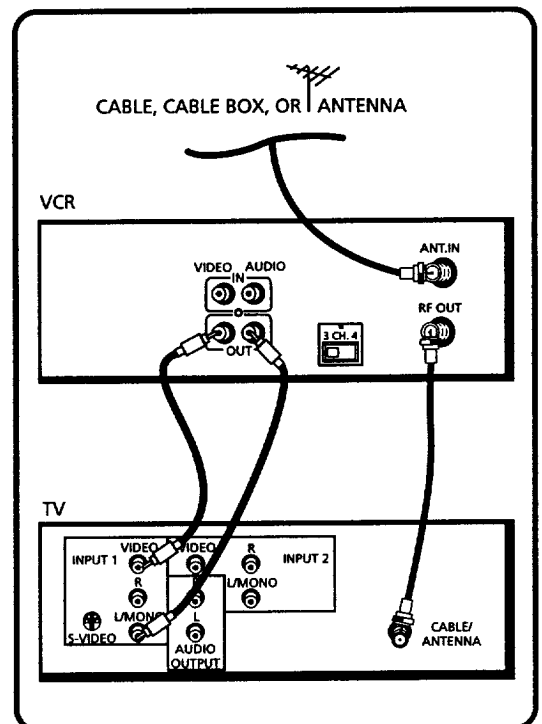

CONNECTIONS

TV With Audio/Video Jacks and Cable Box to Unscramble Pay Channels Only

This connection assumes:

- You are using a cable box only to unscramble pay channels.
- Your TV has audio/video input jacks.

This connection provides:

- Mono sound playback from VCR.
- Recording a scrambled or unscrambled channel through the cable box while watching an unscrambled channel.

To use this connection, you must have:

- (3) coaxial cables
- (2) audio/video cables
- (1) splitter

To connect:

1. Connect cables as shown.
2. Return to *First Things First*, then follow the steps.

Using This Connection

Tune your TV to its video input channel.

Auto TV/VCR setting:

- Set the Auto TV/VCR feature to OFF. Use of the TV•VCR button is not required.

To play a tape:

1. Insert a tape.
2. If necessary, press PLAY.

To record a scrambled or unscrambled program and watch another unscrambled program:

1. Begin recording a scrambled program through the cable box using one of the recording options.
2. Select an unscrambled channel on the TV.

All scrambled channels must be viewed through the VCR.

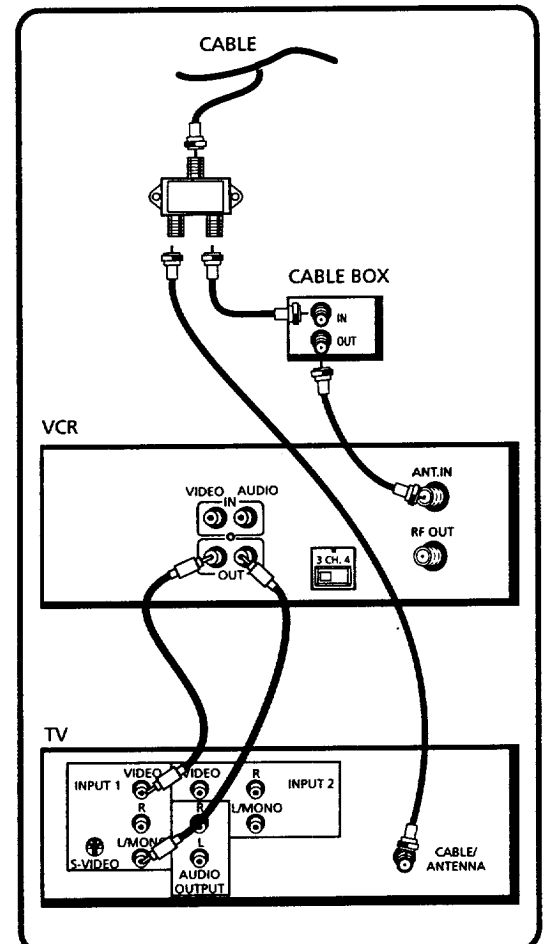

APPENDIX A: REFERENCE

This section gives you some additional information about the VCR, including a description of the unit's controls and display.

You also will find a Troubleshooting Tips section in this Appendix, which might help to resolve some of those simple problems.

Finally, this section contains your warranty information.

APPENDIX A: REFERENCE

Front Panel

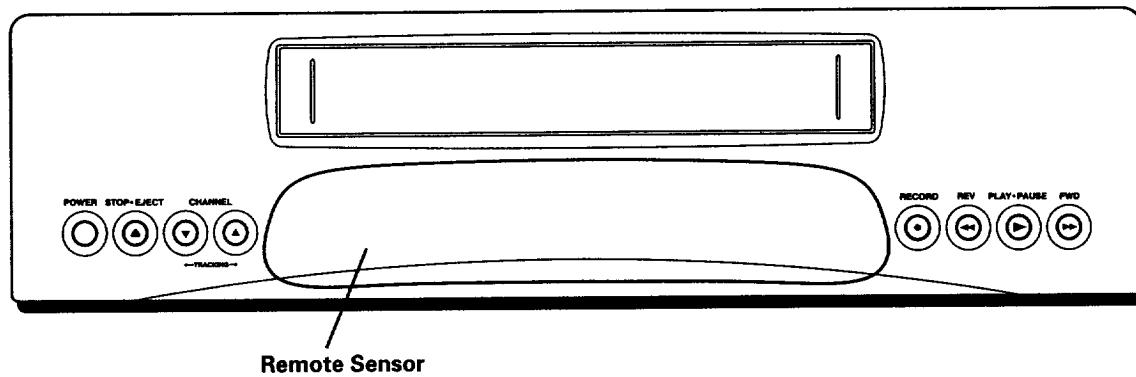

CHANNEL•TRACKING Up or Down Selects next higher or lower channel in the VCR's channel memory. Adjusts tracking when a tape is playing.

FWD Forwards the tape when the VCR is stopped. Searches the picture forward during playback. Starts slow-motion playback during play-pause.

PLAY•PAUSE Plays a tape. Pauses action for viewing during playback. Pauses recording to prevent recording of unwanted scenes.

POWER Turns the VCR on or off.

RECORD Starts VCR recording. Used for express recording.

Remote Sensor Receives signals from the remote control. Aim the remote at this sensor.

REV Rewinds the tape when the VCR is stopped. Searches the picture in reverse during playback. Starts slow-motion playback during play-pause.

STOP•EJECT Stops the normal functions such as record, playback, rewind, fast-forward, or pause. Ejects the tape when the VCR is stopped.

APPENDIX A: REFERENCE

Display Panel

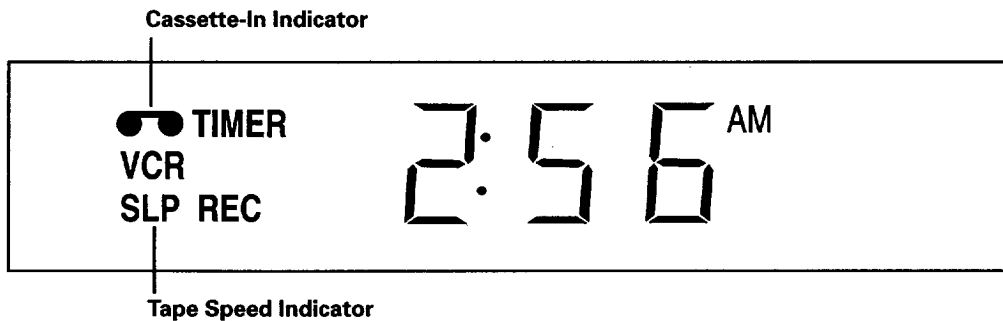

Cassette-In Indicator () Lights when a tape is in the VCR. Flashes when VCR is ejecting tape.

Channel Number, Line Indicator (VID1), Time, Time Counter, or Status Indicator

The current time, time counter, channel number, or line input (VID1) is displayed. Press the INFO button to switch between the current time and elapsed-time counter. The status indicators show what the VCR is doing.

- **BYE** Turned off
- **F.FWD** Fast forward
- **HI** Turned on
- **PLAY** Playback
- **PAUS** Play pause
- **REC** Record
- **REC.P** Record pause
- **REW** Rewind
- **SLOW** Slow motion
- **SRCH +** Forward search
- **SRCH -** Reverse search
- **STOP** VCR stopped
- **T.REC** Timer recording

REC Indicator Lights when the VCR is recording.

Tape Speed Indicator (SP or SLP) Displays recording speed selected with SPEED button.

TIMER Indicator Lights when VCR is turned off and set for timer recording. Flashes when timer recording is set and there is no cassette in the VCR.

VCR Indicator (Applies Only if your VCR Viewing Channel is 3 or 4) Press the TV•VCR button to turn on or off.

- VCR indicator on: Picture from VCR.
- VCR indicator off: Picture from TV channel.

APPENDIX A: REFERENCE

Back Panel

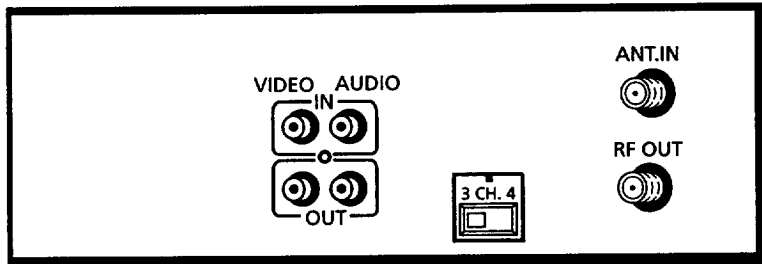

3 CH. 4 Switch Selects the channel to which you will tune the TV to see the VCR picture if you connect the VCR using the ANT.IN and RF OUT jacks.

AUDIO and VIDEO IN Jacks Receives signals from another component, like a VCR or camcorder, when it is connected to these jacks. Use INPUT on the remote to select.

AUDIO and VIDEO OUT Jacks Sends signals from VCR to another component, like a TV or VCR, when it is connected to these jacks.

ANT.IN Jack Receives a signal from an antenna or cable system when attached.

RF OUT Jack Passes signal to TV using the cable supplied.

APPENDIX A: REFERENCE

Troubleshooting Tips

No power

- Check to make sure it is plugged into an operating outlet.
- Check to make sure your connections are correct.

VCR does not respond to remote

- Press VCR to set remote to control the VCR.
- Check to make sure there are no objects between the VCR and remote.
- The batteries may need changing.
- Make sure the Remote VCR1/VCR2 setting is set to VCR1 so the remote that came packed with your VCR can operate it.
- Remove batteries and hold number button 1 for at least 60 seconds to drain the microprocessor inside the remote. Release number 1 and replace the batteries.
- Remove all batteries for approximately 12 hours. Then replace batteries.

Remote no longer controls a GE, RCA, or ProScan TV

- Press TV to set remote to control a compatible TV.
- Check to make sure the remote is programmed to control a GE, RCA, or ProScan TV.

Remote no longer controls a compatible TV

- Press TV to set remote to control the compatible TV.
- Check to make sure there are no objects between the TV and remote.
- The batteries may need changing.
- Reprogram remote after batteries have been changed.
- Remove batteries and hold number button 1 for at least 60 seconds to drain the microprocessor inside the remote. Release number 1, replace the batteries, and (if necessary) reprogram the remote.
- Remove all batteries for approximately 12 hours. Then replace batteries and (if necessary) reprogram the remote.

Poor or no picture for normal TV viewing

- Check to make sure the VCR indicator is off.
- Check to make sure the TV is switched to an active channel.
- Check to make sure the antenna connections are secure and correct.

Snowy or no picture during playback

- Press TV•VCR to turn VCR indicator on.
- Check TV channel selected (3 or 4) to make sure it matches the channel selected with 3 CH. 4 switch on back of VCR.
- Check to make sure the TV's fine tuning is correct for the channel you have selected.
- Check video cable connections between VCR and TV monitor.
- Check to make sure the TV monitor is set to video input channel.

APPENDIX A: REFERENCE

- Try another tape.
- Some snow/streaks are normal during search, stop action, frame advance, and slow-motion playback.

Streaks in picture during normal playback

- Press one of the TRACKING buttons to move streaks up or down for the best picture.
- Check to make sure the tape is of good quality and not worn out.

Time counter not working or time counter not working in search modes

- The time counter does not advance during unrecorded portions of tape. When an unrecorded segment of tape is encountered, the time counter will hold its count until recorded material is detected again.
- A minus (-) will appear in front of the time if you rewind the tape farther back than a counter reading of 0:00:00.
- The time counter disappears during search; this is normal.

Will not record or play

- Check to make sure there is a tape in the VCR.
- Try ejecting and reinserting the cassette.
- Check to make sure the tape is not broken.
- Check to make sure the VCR is not in pause mode. Press PAUSE or PLAY on the remote (PLAY•PAUSE on the VCR) to return to normal playback.

Will not record

- Check to make sure the safety tab is intact.
- Check to make sure the VCR is not in the line mode. Press INPUT on the remote.

Rewind does not operate

- Check to make sure the tape is not already rewound.

Timer recording not made or wrong program recorded

- Make sure the correct VCR PlusCode is entered.
- Check to make sure the cable box was turned on when recording was to begin.
- Check to make sure the program was entered correctly (wrong channel or times).
- Power interruption. Reset the clock.
- Check to see if time and date are correct--including AM/PM.
- Check to make sure the program did not exceed the tape's length or the tape was not rewound beforehand.
- Check to make sure the VCR was turned off at the time recording was to start.
- Check to make sure there was a tape in the VCR and the cassette's safety tab was intact.
- VCR ejects cassette when the end of the tape is reached during a timer recording.
- Check to make sure VCR Plus+ channel setup was completed correctly.

APPENDIX A: REFERENCE

Clock shows incorrect time or date

- Power interruption.
- Check to make sure the clock is set accurately (check AM/PM and date).
- Check Auto DST setting. The clock may have adjusted for daylight-saving time.

Time did not adjust for daylight-saving time

- Check to make sure Auto DST feature is turned on.

VCR makes noise when stopped

- VCR is removing tape from heads. This is normal. The head cylinder inside the VCR will continue to rotate for a few minutes after you put the VCR in the stop mode.

Will not Auto Channel Search active channels correctly

- Check to make sure the antenna connections are secure and correct.
- Check to make sure the Signal Type: CABLE/ANTENNA feature is set correctly.
- If Detect Automatically was selected for the Signal Type in the Auto Channel Search menu, try using either CABLE TV or ANTENNA instead.
- May not need to auto channel search if using a cable box. Refer to the VCR Channel List or contact your cable company for more information.

Cannot add or remove channels

- Channels must be placed in memory using the AUTO CHANNEL SEARCH feature before channels can be added or removed from channel memory.

Tape plays back in slow motion

- Press PLAY to return to normal playback.

Cannot select channels over 69

- Cable channels over 69 can only be selected if Signal Type: CABLE/ANTENNA feature is set to CABLE.

Cassette with safety tab removed does not start to play automatically

- Check to make sure the Auto Play ON/OFF feature is set to ON.

TIMER indicator flashes

- Check to make sure there is a cassette in the VCR when a timer recording is set.

On-screen menus appear in English, French, or Spanish

- Check Language feature.

APPENDIX A: REFERENCE

Specifications

Format:	VHS
Record/Playback System:	Video: 4-Head Audio: Mono record/playback
Video Signal System:	EIA standard: NTSC color
Antenna:	75-ohm external VHF/UHF combined antenna terminal
Tuner:	USA: 181 channels capability* (125 cable channels) Canada: 178 channels capability* (122 cable channels)
Type:	AutoProgramming frequency synthesis
Power Requirement:	120V AC, 60 Hz
Power Consumption:	17 watts
Dimensions:	3.54 inches high (90 mm) 14.1 inches wide (360 mm) 12.2 inches deep (312 mm)
Weight:	8.14 pounds (3.7 kg)
Storage Temperature Range:	- 22°F to +149°F (-30°C to +65°C)
Operating Temperature Range:	+41°F to +104°F (+5°C to +40°C)

*Check your cable company's compatibility requirements.

Cleaning the VCR

Use a soft cloth or dusting attachment of your vacuum cleaner to dust your VCR. Remove dust from the ventilation holes on the top, back, sides, and bottom of the cabinet.

Plastic surfaces are easily scratched and can be marred by alcohol and various solvents. Avoid excessive use of oil-based furniture polishes since the materials used in the cabinet will accumulate more dust. We recommend using a nonabrasive, antistatic cleaner and polisher.

Specifications are subject to change.

APPENDIX A: REFERENCE

Limited Warranty

What your warranty covers:

- Any defect in material or workmanship.

For how long after your purchase:

- Ninety days for labor charges.
- One year for parts.

The warranty period for rental units begins with the first rental or 45 days from date of shipment to the rental firm, whichever comes first.

What we will do:

- Pay any Authorized GE VCR Servicenter the labor charges to repair your VCR.
- Pay any Authorized GE VCR Servicenter for the new or, at our option, refurbished replacement parts required to repair your VCR.

How you get service:

- Take your VCR to any Authorized GE VCR Servicenter. To identify your nearest Authorized GE VCR Servicenter, ask your dealer, look in the Yellow Pages, or call 1-800-447-1700.
- Show the service technician your evidence of purchase date.
- Pick up your VCR when repairs are completed.

What your warranty does not cover:

- Customer instruction. (Your Owner's Manual clearly describes how to install, adjust, and operate your VCR. Any additional information should be obtained from your Dealer.)
- Installation and related adjustments.
- Signal reception problems not caused by your VCR.
- Damage from misuse or neglect.
- Cleaning of video/audio heads.
- Remote control batteries.
- A VCR that has been modified or incorporated into other products or is used for institutional or other commercial purposes.
- A VCR purchased or serviced outside the USA.
- Acts of God, such as but not limited to lightning damage.

Product Registration:

- Please complete and mail the Product Registration Card packed with your VCR. It will make it easier to contact you should it ever be necessary. The return of the card is not required for warranty coverage.

How state law relates to this warranty:

- This warranty gives you specific legal rights, and you also may have other rights that vary from state to state.

If you purchased your VCR outside the United States:

- This warranty does not apply. Contact your dealer for warranty information.

INDEX

- 3 CH. 4 switch 5, 50
- Accessing menus 5
- Accessories, included 4
- Add or remove channels 10
- ADD/REMOVE CHANNELS menu 10
- ANT.IN jack 4, 5, 16, 29, 42, 43, 50
- Audio/video jacks 4, 5, 29, 42, 43, 50
- Auto channel search 9
- AUTO CHANNEL SEARCH menu 9
- Auto DST ON/OFF feature 11
- Auto play feature 16
- Auto TV/VCR feature 16, 43, 44, 45, 46
- Automatic rewind 21
- Automatic tracking 20
- Back panel controls 50
- Basic recording 21
- Batteries, installing in the remote 4
- Cables
 - positioning 41
 - types of 42
- Cassette-in indicator 49
- CHAN buttons 10, 18, 19, 32
- CHANNEL buttons 10, 48
- Channel number display 49
- Channel, viewing 5
- Channels, add or remove 10
- CHANNELS menu 9, 10, 14, 26
- Choosing a VCR connection 43, 46
- Cleaning the VCR 54
- CLEAR button 18, 19, 27, 37, 38
- Clearing programs 28
- Commercial scan feature 36
- Connecting components 41
- Connections
 - audio/video cable 43
 - choosing 43
 - TV with audio/video jacks 45
 - TV with audio/video jacks and cable box to unscramble pay channels only 46
 - TV with RF jack only 44
- Contents 1
- Controls
 - back panel 50
 - front panel 48
- Copying and editing tapes 29
- Display panel 49
- Editing and copying tapes 29
- Eject, tape 20
- Express recording 24
- F.ADV button 18, 37
- FORWARD button 18, 20
- Frame advance 37
- Front panel controls 48
- FWD button 20, 36, 37, 38, 48
- GO BACK button 18, 19
- Included accessories 4
- Index search feature 37
- INDEX SEARCH menu 37
- INFO button 12, 18, 19, 38, 39, 49
- INPUT button 18, 25, 29
- Jacks, types of 42
- Language feature 8
- LANGUAGE menu 8
- Limited warranty 55
- Line indicator (VID1) 49
- MENU button 5, 8, 9, 10, 11, 12, 18, 26, 27
- Menus, accessing 5
- MUTE button 19
- Number buttons 5, 10, 12, 19, 20
- OFF button 18, 19, 20, 32
- On-screen displays 39
- Overheating 41
- PAUSE button 19, 20, 21, 37, 39
- Picture search options 36
- PLAY button 19, 20, 36, 37, 38, 44, 45, 46
- PLAY•PAUSE button 20, 21, 29, 36, 37, 48
- Playing a tape 20
- POWER button 21, 48
- Power surges 41
- PREFERENCES menu 14, 15
- Problem solving 51
- Programming the remote 31
 - to operate TVs 32
- PROGRAMS OVERLAP message 25, 27
- REC indicator 49
- RECORD button 19, 21, 24, 29, 48
- Recording
 - basic 21
 - express 24
 - speeds 21
 - timer 25
 - using two VCRs 29
 - VCR Plus+ 26
- Remote
 - buttons 18
 - component buttons 18

INDEX

- sensor 48
- TV function buttons 19
- VCR function buttons 18
- Remote VCR1/VCR2 option 15
- Remove or add channels 10
- REV button 20, 36, 37, 38, 48
- REVERSE button 19, 20
- Review programs screen 28
- Reviewing programs 28
- Rewind, automatic 21
- RF OUT jack 4, 5, 16, 29, 42, 43, 50
- Safety tab 16, 21
- SEARCH button 19, 36, 37, 38
- Search features
 - commercial scan 36
 - forward 36
 - frame advance 37
 - index 37
 - reverse 36
 - slow motion 36
 - time counter 38
 - zero search 38
- Sensor, remote 48
- SET TIME AND DATE screen 12
- Set up
 - first 3
 - language 8
 - using the menu 8
 - Using the PREFERENCES menu 14
 - VCR channels list 8
- Signal type, cable or antenna 10
- Solving problems 51
- Specifications 54
- Speed
 - LP 21
 - SLP 21
 - SP 21
- SPEED button 19, 21, 24, 27, 49
- Speeds, recording 21
- Status indicators 49
- STOP button 19, 20, 21, 28, 37, 38
- STOP•EJECT button 20, 21, 29, 48
- Stopping a timer recording 28
- Tab, safety 21
- Table of contents 1
- Tape eject 20
- Tape, playing a 20
- Tape speed indicator 49
- Tape speeds 21
- Time and date 10
 - daylight-saving time 11
 - setting 11
- Time counter 38
- Time counter display 49
- Time display 49
- TIME menu 11
- Timer recording 25
 - stopping 28
- Timer recording with VCR Plus+ 26
- TIMER RECORDINGS menu 25, 28
- Tips, troubleshooting 51
- Tracking 39
- TRACKING buttons 19, 20, 36, 39, 48
- Troubleshooting tips 51
- TV button 18, 32
- TV codes 33
- TV function buttons 19
- TV, programming the remote to control 32
- TV•VCR button 16, 19, 43, 44, 45, 46, 49
- UNRECOGNIZED NUMBER... PLEASE RE-ENTER message 27
- VCR, cleaning 54
- VCR button 18
- VCR channels list 8
- VCR indicator 16, 49
- VCR MAIN MENU 5, 8, 9, 10, 11, 12, 18, 25, 26
- VCR Plus+
 - channel list 26
 - channel list screen 14
 - menu 26
 - PlusCode number 27
 - set up channels 12
 - using 26
 - worksheet 13
- Viewing channel 5
- VOL buttons 20
- Warranty, limited 55
- ZERO search feature 38
- ZERO SEARCH menu 38

If your VCR needs service, please contact your dealer or the nearest Servicenter from the yellow pages. Please do not send any products to the Indianapolis address listed in this manual or on the carton. This will only add delays in service for your product.

 **THOMSON CONSUMER ELECTRONICS**
10330 North Meridian Street
Indianapolis, IN 46290

©1997 Thomson Consumer Electronics, Inc.
Trademark(s)® Registered
Marca(s) Registrada(s)
Printed in Mexico
TOCOM 15226000