

# **RCA**

## video cassette recorder user's guide

VR342

**RECEIVED** OCT 01 1997  
-----

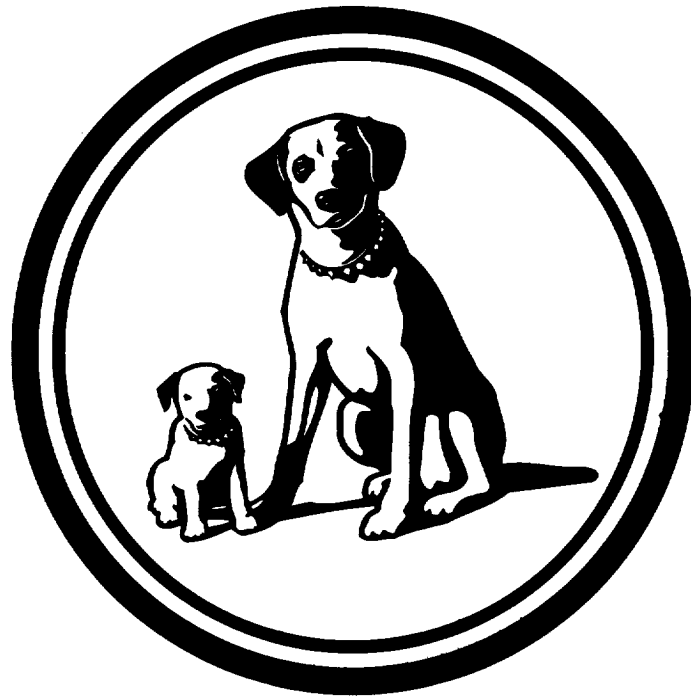

# IMPORTANT INFORMATION

## WARNING

RISK OF ELECTRIC SHOCK DO NOT OPEN

To reduce the risk of electric shock, do not remove cover (or back). No user serviceable parts inside. Refer servicing to qualified service personnel.



This symbol indicates "dangerous voltage" inside the product that presents a risk of electric shock or personal injury.



This symbol indicates important instructions accompanying the product.

## WARNING

To reduce the risk of fire or shock hazard, do not expose this product to rain or moisture.

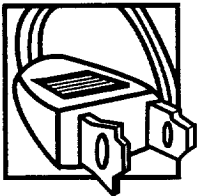

**Caution:** To reduce the risk of electric shock, match wide blade of plug to wide slot, fully insert.

**Attention:** Pour éviter les chocs électriques, introduire la lame la plus large de la fiche dans la borne correspondante de la prise et pousser jusqu'au fond.

Refer to the identification/rating label located on the back panel of your product for its proper operating voltage.

FCC Regulations state that unauthorized changes or modifications to this equipment may void the user's authority to operate it.

**Cable TV Installer:** This reminder is provided to call your attention to Article 820-40 of the National Electrical Code (Section 54 of the Canadian Electrical Code, Part 1) which provides guidelines for proper grounding and, in particular, specifies that the cable ground shall be connected to the grounding system of the building as close to the point of cable entry as practical.

## PRODUCT REGISTRATION

Please fill out the product registration card and return it immediately. Returning this card allows us to contact you if needed.

Keep your sales receipt to obtain warranty parts and service and for proof of purchase. Attach it here and record the serial and model numbers in case you need them. The numbers are located on the back of the player.

Model No. **VR342** \_\_\_\_\_

Serial No. \_\_\_\_\_

Purchase Date: \_\_\_\_\_

Dealer/Address/Phone: \_\_\_\_\_

\_\_\_\_\_

# TABLE OF CONTENTS

<b>First Things First</b> .....	<b>3</b>
<b>Setting up the VCR</b> .....	<b>7</b>
Using the Menu to Set Up Features .....	8
Language .....	8
VCR Channels List.....	8
To Auto Channel Search .....	9
To Change the Signal Type.....	10
To Add or Remove Channels .....	10
Time and Date.....	10
Set Daylight-Saving Time .....	11
Set the Time and Date .....	11
Additional Set-Up Features in the PREFERENCES Menu.....	12
Remote VCR1/VCR2 Option .....	13
Auto Play.....	13
Auto TV/VCR.....	14
<b>VCR Basics</b> .....	<b>15</b>
Remote Buttons .....	16
Playing a Tape .....	17
Tape Eject .....	17
Recording .....	18
Check the Safety Tab .....	18
Automatic Rewind.....	18
<b>Recording</b> .....	<b>19</b>
Recording Features .....	20
Express Recording .....	20
Timer Recording .....	21
Stopping a Timer Recording .....	22
Reviewing and Clearing Programs .....	22
Using Two VCRs for Copying and Editing Tapes .....	23
<b>Other Features</b> .....	<b>25</b>
Picture Search Options .....	26
Forward and Reverse Search .....	26
Slow Motion .....	26
Commercial Scan (SEARCH Button) .....	26

# TABLE OF CONTENTS

Frame Advance .....	27
Index Search .....	27
Zero Search .....	28
Time Counter .....	28
On-Screen Displays .....	29
Tracking .....	29
<b>Connections .....</b>	<b>31</b>
Things to Know Before Connecting Components .....	31
Connecting Your VCR .....	32
Jacks and Cables .....	32
Choosing a VCR Connection .....	33
Advantages of Audio/Video Cable Connections .....	33
Don't Forget About the Auto TV/VCR Feature .....	33
TV with RF Jack Only .....	34
TV with Audio/Video Jacks .....	35
TV with Audio/Video Jacks and Cable Box to Unscramble Pay Channels Only .....	36
<b>Appendix A: Reference .....</b>	<b>37</b>
Front Panel .....	38
Back Panel .....	39
Indicator Panel .....	39
Troubleshooting Tips .....	40
Specifications .....	43
Cleaning the VCR .....	43
Limited Warranty .....	44
<b>Index .....</b>	<b>45</b>

# FIRST THINGS FIRST

## HI, MY NAME IS SUSAN...

and I wrote this User's Guide. It's my job to see that you have a rewarding user manual experience. Also, I think you'll be pleased with the features that can be accessed through the on-screen menus.

## READ THE FIRST THREE SECTIONS

The first three sections of the manual introduce you to your VCR, and show you how to set the VCR up and use the on-screen menus. Reading these sections gives you the basic information you need to use your VCR.

## WHAT'S LEFT?

The rest of the book highlights playback and recording information, contains a detailed connections section, and a reference section that includes troubleshooting tips, limited warranty, and index.

**1** FIRST THINGS FIRST



**2** SETTING UP THE VCR



**3** VCR BASICS



**4** RECORDING



**5** OTHER FEATURES



**6** CONNECTIONS

### READ ME!

These note boxes give you tips for your new video cassette recorder.

# FIRST THINGS FIRST

## STEP 1: UNPACK WHAT'S IN THE BOX

The following items come packed in the box:

- VCR
- Remote control
- RF coaxial cable

## STEP 2: INSTALL BATTERIES IN THE REMOTE CONTROL

Follow these steps whenever you need to install or change the batteries in your VCR remote.

1. Remove the cover of the battery compartment.
2. Place batteries in remote, matching the + and – ends of each battery to the diagram inside the compartment.
3. Replace the cover.

## STEP 3: CONNECT YOUR VCR

If you connect your VCR to your home antenna or cable system and then to your TV, use the VCR's ANT.IN and RF OUT jacks for a good signal as shown.

If you have a TV with AUDIO/VIDEO jacks, use these audio/video jacks on the TV and VCR for a better connection. Refer to the *Connections* section, toward the back of the manual.

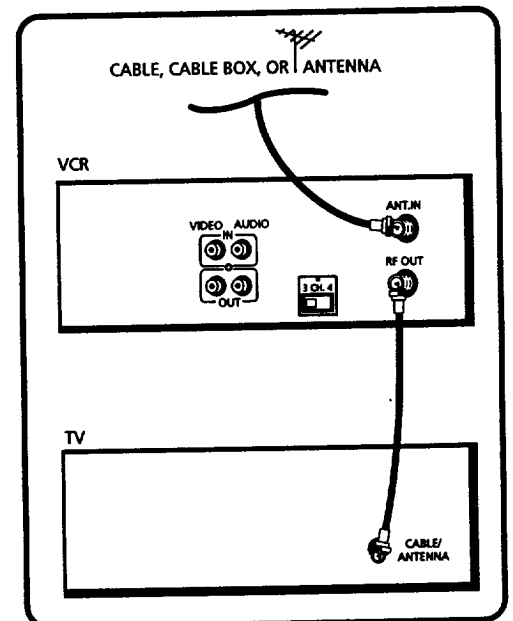

# FIRST THINGS FIRST

## STEP 4: PLUG IN THE VCR

Match the wide blade of the plug with the wide slot in the outlet. Be sure to insert the plug completely.

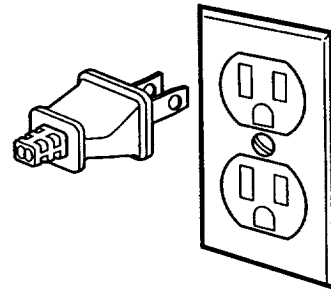

## STEP 5: TUNE THE TV

Tune the TV to the VCR viewing channel. The VCR viewing channel is channel 3 or 4 or the TV's video input.

- If you connect your VCR using the ANTENNA connectors with RF coaxial cable, set the 3CH.4 switch to channel 3 or channel 4--the channel you want to use on your TV.
- If you connect your VCR using the AUDIO/VIDEO jacks with audio/video cables, select the TV's video input to see the signal. See the *TV Owner's Manual*.

## STEP 6: TURN ON THE VCR

Press POWER to turn on the VCR.

## STEP 7: ACCESS THE MENUS

The MENU and number buttons let you access, select and change menu items. For example, to change the Auto Play setting, you would do the following:

1. Press MENU to bring up the VCR MAIN MENU.

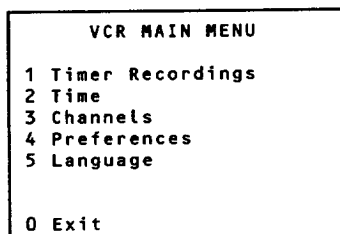

### VCR Viewing Channel

When using the ANTENNA jacks to connect your VCR, tune your TV to channel 3 or 4.

When using the audio/video jacks to connect your VCR, tune your TV to the TV's video input.

# FIRST THINGS FIRST

2. Press 4 to display the PREFERENCES menu.

```

  PREFERENCES
  1 Remote Control: VCR1
  2 Auto Play:      ON
  3 Auto TV/VCR:   ON

  0 Exit

```

3. Press 2 to switch Auto Play to ON or OFF.

```

  PREFERENCES
  1 Remote Control: VCR2
  2 Auto Play:      OFF
  3 Auto TV/VCR:   ON

  0 Exit

```

See *Setting Up the VCR* for detailed information about the Auto Play feature.

## STEP 8: SET UP THE VCR

Once you understand how to move around and/or through the menus, go to the next section to set up your VCR.



# SETTING UP THE VCR

## SET-UP FEATURES

Below is a list of set-up features that you may want to set up before you begin using your VCR for the first time:

- Select a language
- Set up VCR channel list (Auto Channel Search)
- Set automatic daylight-saving time
- Set the time and date
- Set the Remote VCR1/VCR2 feature
- Set the Auto Play feature
- Set the Auto TV/VCR feature

**1** FIRST THINGS FIRST



**2** SETTING UP THE VCR



**3** VCR BASICS



**4** RECORDING



**5** OTHER FEATURES



**6** CONNECTIONS

# SETTING UP THE VCR

## USING THE MENU TO SET UP FEATURES

You can set up features by using the menu system. Each feature is explained in this section.

### LANGUAGE

Select your preferred language, and the on-screen displays will appear in that language.

1. Press MENU to display the VCR MAIN MENU.

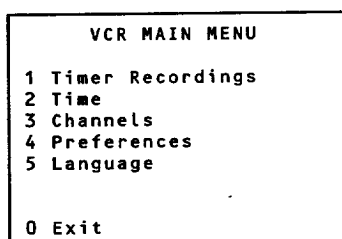

2. Press 5 to select and display the LANGUAGE menu.

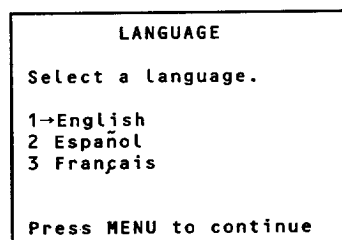

3. Press 1 for English, 2 for Español (Spanish), or 3 for Français (French).

### VCR CHANNELS LIST

If you use a cable box for *all channels*, this step is not necessary. Your VCR may come with a channel list preset at the factory. Even though your VCR may come with a list, it's possible that you may want to add or eliminate some channels depending on whether they are active.

#### On-screen Menus

Not all the VCR screens are shown in this manual when explaining the features.

#### All Channels

If you do not use a cable box for *ALL* channels, then you will want to use a channel list (Auto Channel Search).

# SETTING UP THE VCR

## To Auto Channel Search

Auto channel search memorizes the channels available through your signal type—cable or antenna.

1. Press MENU to display the VCR MAIN MENU.

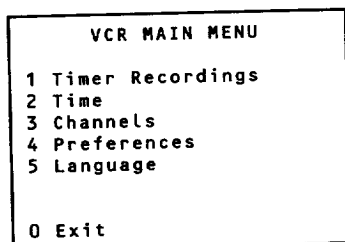

2. Press 3 to display the CHANNELS menu.

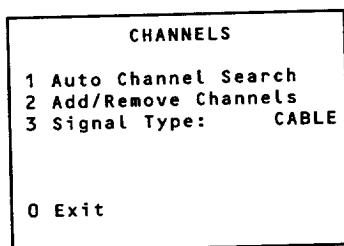

3. Press 1 to display the AUTO CHANNEL SEARCH menu.

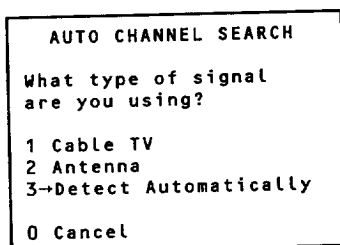

4. Select one of the three AUTO CHANNEL SEARCH options.  
Choices one and two are self-explanatory. If you choose Detect Automatically, the VCR automatically detects which signal system you have attached to your VCR.

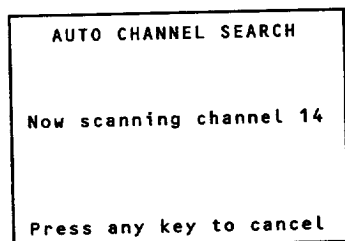

### Detect Automatically

A strong cable or antenna signal in your area may cause Auto Detect to mis-detect. If this should happen, select 1 or 2 for the system you have.

### Auto Channel Search

Use the Auto Channel Search feature to place all available channels in memory.

If you ever change cable or antenna signals, you may need to Auto Channel Search again.

# SETTING UP THE VCR

The VCR begins scanning for the available channels--this takes about one to two minutes. The lowest channel is tuned once the search is complete. Pressing CHANNEL up or down should only select the active channels.

## To Change the Signal Type

1. Press MENU to display the VCR MAIN MENU.
2. Press 3 to display the CHANNELS menu.
3. Press 3 to change the Signal Type between CABLE and ANTENNA.

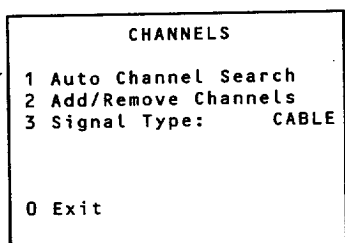

## To Add or Remove Channels

You may want to add or remove channels after you Auto Channel Search, especially if some of the channels have weak signals or you don't want to watch them.

1. Press MENU to display the VCR MAIN MENU.
2. Press 3 to display the CHANNELS menu.
3. Press 2 to display the ADD/REMOVE CHANNELS screen. Use CHANNEL up or down, or number buttons, to go to the channels you want to remove or add.

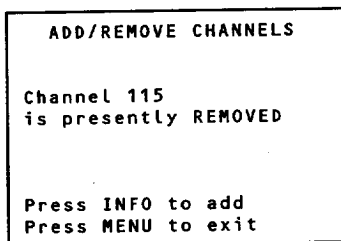
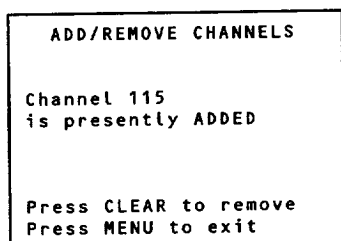

## TIME AND DATE

Before you set the time and date, set the Auto DST (Daylight-Saving Time) feature to ON or OFF for your area.

### Selecting Channels

The CHANNEL up and down buttons access those channels active in your VCR channel list.

You can still access channels not in the channel list by using the number buttons on the remote control.

# SETTING UP THE VCR

## Set Daylight-Saving Time

1. Press MENU to display the VCR MAIN MENU.

```
VCR MAIN MENU
1 Timer Recordings
2 Time
3 Channels
4 Preferences
5 Language

0 Exit
```

2. Press 2 to display the TIME menu.

```
TIME
1 Set time and date
2 Auto DST: ON

0 Exit
```

3. Press 2 to turn Auto DST: ON or OFF.
  - Select ON if you want the VCR's clock to automatically adjust for daylight-saving time.
  - Select OFF if you do not want the VCR's clock to adjust for daylight-saving time.

## Set the Time and Date

1. Press MENU to display the VCR MAIN MENU.

```
VCR MAIN MENU
1 Timer Recordings
2 Time
3 Channels
4 Preferences
5 Language

0 Exit
```

2. Press 2 to display the TIME menu.

```
TIME
1 Set time and date
2 Auto DST: ON

0 Exit
```

### Time and Date

The time and date must be set before a timer recording can be programmed.

### Spring forward; Fall backward

In the Spring, daylight-saving time begins on the first Sunday in April. Because the clock automatically changes from 2:00 AM to 3:00 AM (forward one hour), remember to include the extra hour for timer recording that falls within this time frame.

In the Autumn, daylight-saving time ends on the last Sunday in October. The VCR clock automatically changes from 2:00 AM to 1:00 AM (back one hour). Therefore, it can affect your recording length.

# SETTING UP THE VCR

3. Press 1 to display the SET TIME AND DATE screen.

```
SET TIME AND DATE
Time ---:--
      (hh:mm)
Date --/--/--
Press MENU to cancel
```

4. Enter the data using the number buttons. Press 0 before single-digit numbers and follow the on-screen directions.

```
SET TIME AND DATE
Time 12:34 PM
Date 10/24/97 Friday
Press CLEAR to correct
Press MENU to set
```

## ADDITIONAL SET-UP FEATURES IN THE PREFERENCES MENU

The features in this section are all accessed through the PREFERENCES menu.

1. Press MENU to display the VCR MAIN MENU.

```
VCR MAIN MENU
1 Timer Recordings
2 Time
3 Channels
4 Preferences
5 Language
0 Exit
```

2. Press 4 to display the PREFERENCES menu.

```
PREFERENCES
1 Remote Control: VCR1
2 Auto Play:      ON
3 Auto TV/VCR:   ON
0 Exit
```

### Time/Date Display

Pressing INFO on the remote displays the time and date on the screen.

Now you are ready to select an item from the menu to set up.

# SETTING UP THE VCR

## REMOTE VCR1/VCR2 OPTION

If you own a compatible RCA, GE, or ProScan remote that has a VCR2, VCR2•LD, or DVD•VCR2 button, this feature allows you to set this VCR to respond to that button.

Press 1 to select the Remote Control item in the menu. Then press the VCR2, VCR2•LD, or DVD•VCR2 button to change.

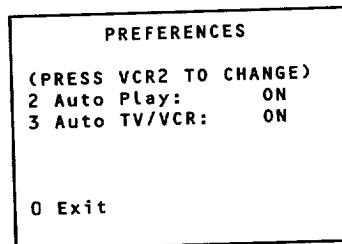
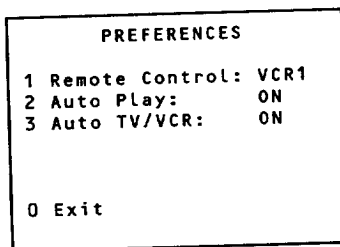

The VCR will only respond to the compatible remote's VCR2, VCR2•LD, or DVD•VCR2 button. If you change the remote setting to VCR2, the remote that came with your VCR will no longer control it.

Use the compatible remote to change the remote setting back to VCR1. Display the PREFERENCES menu, press 1, and then press VCR1. Then the remote that came with the VCR will be able to control it again.

## AUTO PLAY

This feature allows the VCR to automatically start playing when you insert a tape with the safety tab removed. Press 2 to switch between ON or OFF.

- Select ON if you want a tape with its safety tab removed to start playing automatically when the tape is inserted.
- Select OFF if you *do not* want a tape with its safety tab removed to start playing automatically.

### Remote Control Option

Changing the Remote Control option to VCR2 disables the remote that came with your VCR.

# SETTING UP THE VCR

## AUTO TV/VCR

This feature controls whether the TV/VCR switch changes automatically to the VCR mode when the VCR is turned on. Press 3 to switch between ON and OFF.

- Select ON if you want the VCR to switch to the VCR mode when the VCR is turned on or a cassette is inserted. *This only applies if you connect the ANT.IN and RF OUT jacks of your VCR and TV and watch your VCR on channel 3 or 4 of your TV.*
- Select OFF if you want the VCR to remain in the TV mode. This is useful if you watch your VCR on the TV's video input and you don't want your antenna/cable signal interrupted by the VCR.

### Auto TV/VCR

Pressing TV•VCR on the remote will still switch between the VCR and TV mode.

VCR mode: VCR indicator in the display panel lights.

TV mode: VCR indicator turns off.



# VCR BASICS

## LEARN THE BASICS TO GET YOU STARTED

These VCR basics should be enough for you to begin enjoying your VCR. Learning the remote control functions, playing a recorded tape, and recording a program should do just that.

However, there are other features that enhance the enjoyment of your VCR, but they aren't necessary to get you started. If you want to learn more about your VCR, just keep reading.

**1** FIRST THINGS FIRST



**2** SETTING UP THE VCR



**3** VCR BASICS



**4** RECORDING



**5** OTHER FEATURES



**6** CONNECTIONS

VCR Basics tells you what you need to know in order to watch a movie or tape your favorite show.

# VCR BASICS

## REMOTE BUTTONS

**CHAN Up or Down** Selects next higher or lower channel in the VCR's channel memory.

**CLEAR** Resets time counter to 0:00:00. Allows you to change entries when setting the clock or a timer recording.

**F.ADV** Lets you view one frame with each press of the button when tape is in pause.

**FWD** Fast forwards the tape when the VCR is stopped. Searches forward through a tape during playback. Starts slow motion when tape is paused.

**GO BACK** Switches between two channels. Select one channel and then select another using the number buttons. Press GO BACK to switch between the two channels. In menu mode, press to go back to previous menu.

**INFO** Shows the status displays on the TV screen.

**INPUT** Selects between the line input and VCR's tuner. Line input refers to the signal coming from the component connected to the audio/video input jacks on the back of the VCR.

**MENU** Brings up VCR MAIN MENU on the TV screen. Used to select a menu item or exit a menu.

**Numbers (0 through 9)** Select a channel up to 99 by pressing two numbers. Select a cable channel over 99 by pressing and holding 1 until 1 -- appears on the screen. Then press the other two numbers.

**PAUSE** Pauses playback or recording. Press PAUSE again to return to playback or recording.

**PLAY** Plays a tape.

**POWER** Turns the VCR on and off.

**REC (RECORD)** Starts VCR recording. Also used for express recording.

**REV** Rewinds the tape when the VCR is stopped. Searches backward through a tape during playback. Starts slow motion when tape is paused.

**SEARCH** Displays INDEX and ZERO SEARCH menus on TV screen in stop mode. Advances the tape 30 seconds of recorded material during playback.

**SLOW** Used for slow-motion playback.

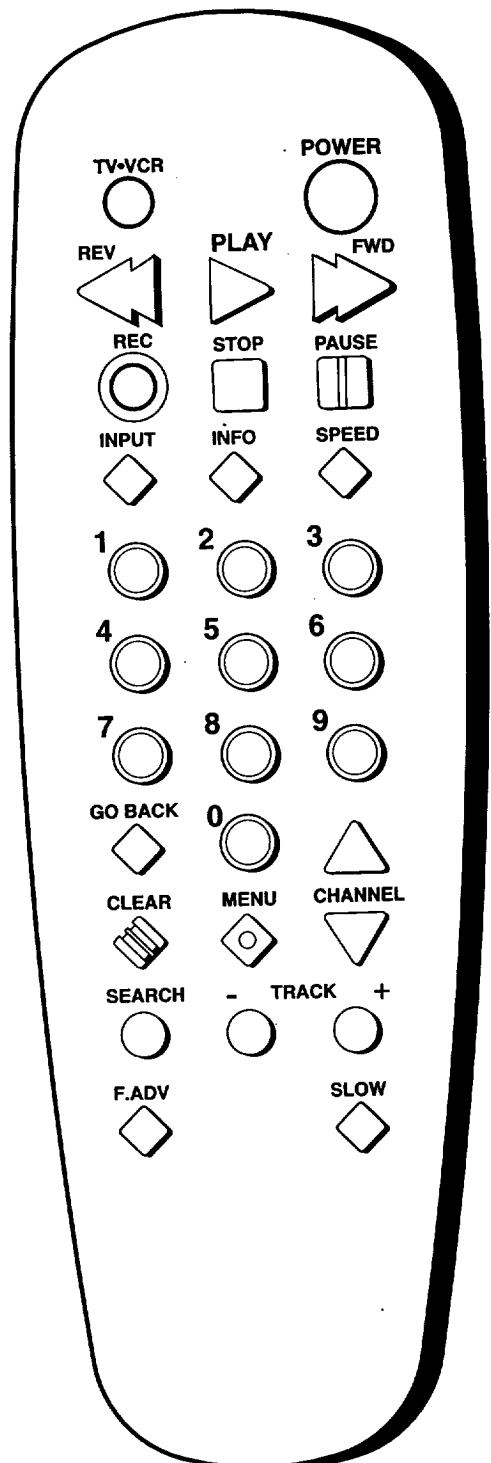

# VCR BASICS

**SPEED** Selects a recording speed (SP or SLP).

**STOP** Stops the current VCR function such as record, playback, rewind, or fast forward.

**TRACK + or -** Lets you manually reduce the streaks that may appear on the picture during play or slow. Reduces picture "jitter" during stop-action playback.

**TV•VCR** Switches the picture signal so that it either comes from the VCR or cable/antenna system.

## PLAYING A TAPE

1. Tune the TV to your VCR viewing channel (3, 4, or TV's video input).
2. Insert a tape in the VCR.

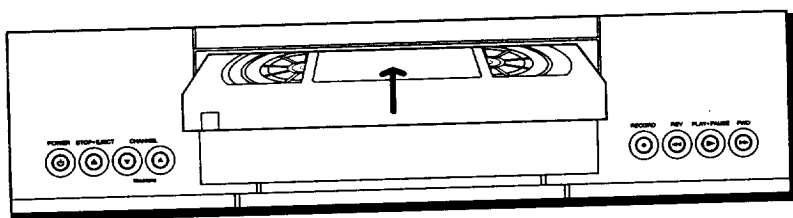

If the Auto Play feature is set to ON, the tape automatically begins playback (if the safety tab on the cassette is removed).

- Press FWD or REV to position the tape.
- Press PLAY (if necessary) on the remote (PLAY•PAUSE on VCR) to begin tape play.
- Press PAUSE (PLAY•PAUSE on VCR) for stop action.
- Press TRACKING up or down to remove any streaks from the picture, if necessary.
- Press STOP on the remote (STOP•EJECT on VCR) to stop playback.

## TAPE EJECT

Press STOP•EJECT on the VCR when it is stopped to eject the tape.

### Pause

If you pause, the VCR automatically switches from pause to stop after a few minutes to reduce tape wear.

### Automatic Tracking

The VCR has automatic tracking which adjusts the picture when playing back a tape recorded on another VCR. Automatic tracking is turned on whenever a tape is inserted or the VCR's power is turned on.

# VCR BASICS

## RECORDING

If you want to record something that you're watching, you can use basic recording.

1. Set the tape speed by pressing the **SPEED** button on the remote (see margin note for information about tape speed settings).
2. Press the **RECORD** button to begin recording.
3. Press **STOP** on the remote (**STOP•EJECT** on the VCR) to stop recording.

If you just want to pause the recording for a short time (like during a commercial), press the **PAUSE** button on the remote (**PLAY•PAUSE** on VCR) instead of **STOP**.

## CHECK THE SAFETY TAB

No matter which recording option you use, you need to make sure there is a tape in the VCR, and that the tape's safety tab is in place. You cannot record on a tape with the safety tab removed.

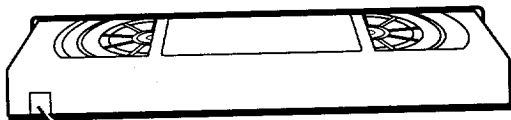

Safety Tab

If the safety tab is removed and you want to record over it, simply cover the hole with vinyl tape.

## AUTOMATIC REWIND

During playback, the VCR automatically rewinds the tape if the tape reaches the end and stops.

During recording, the VCR automatically rewinds the tape if it reaches the end. While rewinding, you can press **POWER** and the VCR turns off after rewinding.

### Tape Speeds

#### SP (Standard Play)

Gives the best quality recording, but fewer programs can be recorded on the tape. Special effects such as pause, slow motion, picture search, and frame advance work well when you play back tapes recorded in this speed.

#### LP (Long Play)

Your VCR is capable of playing back tapes recorded in LP. You cannot record in the LP speed.

#### SLP (Super Long Play)

Gives three times the recording time of tapes recorded in SP. Special effects such as pause, slow motion, picture search, and frame advance work well when you play back tapes recorded in this speed.

Cassette	Recording Time	
	SP	SLP
T-120	2Hr	6Hr
T-160	2Hr 40Min	8Hr

# RECORDING

## SEVERAL RECORDING OPTIONS

Now that you've gone through the necessary steps to operate your VCR, I'll explain the different recording features that are available to suit your needs.

### Recording Features:

- Recording (explained in *VCR Basics* section)
- Express Recording
- Timer Recording
- Copying and Editing Tapes

**1** FIRST THINGS FIRST



**2** SETTING UP THE VCR



**3** VCR BASICS



**4** RECORDING



**5** OTHER FEATURES



**6** CONNECTIONS

# RECORDING

## RECORDING FEATURES

There are three ways to record programs:

- **Recording** lets you press one button to start recording a program. (See *VCR Basics* section.)
- **Express Recording** lets you start recording a program you are watching, and then set the VCR to automatically stop recording after a designated period of time.
- **Timer Recording** lets you program the VCR to automatically start and stop recording at a predetermined time.

## EXPRESS RECORDING

Use express recording when you want to quickly record the remaining portion of the program you are watching.

1. Set the tape speed by pressing the SPEED button on the remote.
2. Press the RECORD button to begin recording.
3. Repeatedly press the RECORD button to set up the recording duration.

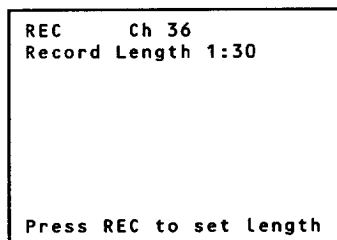
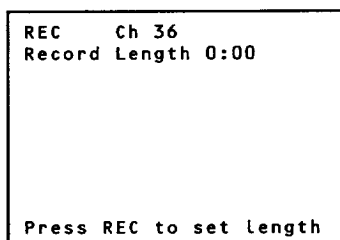

Each press of the RECORD button increases the recording time (up to 4 hours).

The VCR continues to record for the amount of time you indicate, and then automatically turns off.

## Tape Speeds

### SP (Standard Play)

Gives the best quality recording, but fewer programs can be recorded on the tape. Special effects such as pause, slow motion, picture search, and frame advance work well when you play back tapes recorded in this speed.

### LP (Long Play)

Your VCR is capable of playing back tapes recorded in LP. You cannot record in the LP speed.

### SLP (Super Long Play)

Gives three times the recording time of tapes recorded in SP. Special effects such as pause, slow motion, picture search, and frame advance work well when you play back tapes recorded in this speed.

	Recording Time	
Cassette	SP	SLP
T-120	2Hr	6Hr
T-160	2Hr 40Min	8Hr

## Express Recording

Express recording is a great way to tape the last quarter of the game, or the last part of a movie when you have to leave.

To stop an express recording, press and hold STOP on the remote (STOP•EJECT on the VCR) for a few seconds.

# RECORDING

## TIMER RECORDING

You can set up as many as eight timer recording programs.

1. Press MENU to display the VCR MAIN MENU.

```
VCR MAIN MENU
1 Timer Recordings
2 Time
3 Channels
4 Preferences
5 Language

0 Exit
```

2. Press 1 to display the TIMER RECORDINGS menu.

```
TIMER RECORDINGS
1 Create a New Program
2 Review Existing Progs.

0 Exit
```

3. Select 1 to CREATE A NEW PROGRAM.

```
How often should this
program record?
1 One time
2 Daily (every day)
3 Weekdays (M-F)
4 Weekly (once per week)

0 Cancel
```

4. Select how often you want the program to record.

```
Program 1 (One time)
Channel  --
Start Time ---:--
End Time  ---:--
Start Date --/--/--
Tape Speed SLP

Press MENU to cancel
```

5. Enter the data for the program with the number buttons.

The data includes the channel number (press INPUT to select the line input), start time including AM or PM, and end time. The start date is automatically entered based on the VCR clock and the tape speed remains the same as was last selected. Both the date and speed can be changed.

### Timer Recording Information

Clock must be set correctly.

Insert a tape with the safety tab in place and enough tape to record the program.

**PROGRAMS OVERLAP** appears if you have entered two programs where the times overlap.

The output of your cable box appears in the "channel" item of the timer recording if you've set up for a cable box.

For cable box, turn on the cable box and tune it to the channel you want to record before the recording is to begin.

# RECORDING

- Review the information to make sure it is correct, and then press MENU to save.

```
Program 1 (One time)
Channel    03 Cable
Start Time 08:00 PM
End Time   09:30 PM
Start Date 10/24/97 Fri
Tape Speed SLP
           1=SP 2=SLP
Press CLEAR to correct
Press MENU to save
```

```
Program 1 has been saved
Remember to insert a
recordable tape and
turn the VCR off before
the program start time.
Press MENU to continue
```

## STOPPING A TIMER RECORDING

To stop or cancel a timer recording in progress (even an express recording):

- Press and hold the STOP button on the remote (STOP•EJECT button on the VCR) for a few seconds.

## REVIEWING AND CLEARING PROGRAMS

To review programs that you have already set up:

- Press MENU to display the VCR MAIN MENU.
- Press 1 to display the TIMER RECORDINGS menu.

```
TIMER RECORDINGS
1 Create a New Program
2 Review Existing Progs.
0 Exit
```

- Press 2 to display the REVIEW PROGRAMS screen.

```
Program 1 (One time)
Channel    104 Cable
Start Time 12:00 AM
End Time   01:30 AM
Start Date 10/24/97 Fri
Tape Speed SLP
Press CLEAR to erase
Press MENU for next prog.
```

- Press CLEAR to erase or MENU to see the next program.



# RECORDING

## USING TWO VCERS FOR COPYING AND EDITING TAPES

Use one VCR as the *playback VCR* and the other as the *recording VCR*.

1. Turn on the TV and VCRs.
2. Tune the TV to the VCR viewing channel (either 3, 4, or TV's video input).
3. If you connected your VCR using the ANTENNA jacks, tune *recording VCR* to channel 3 or 4—the one selected on the back of the *playback VCR*.

If you have connected your VCR using the audio/video jacks, press INPUT on the *recording VCR's* remote to select the line input.

4. Insert the tape you want to copy into the *playback VCR*. Insert a blank tape with safety tab in place into the *recording VCR*.
5. When you reach the point on the tape or program where you want to begin copying, press PLAY•PAUSE and then PLAY•PAUSE again on the *playback VCR*. You may need to adjust the tracking.
6. Press the RECORD button, then press PLAY•PAUSE, on the *recording VCR*.
7. Press the PLAY•PAUSE buttons on *both VCRs* at the same time to begin copying the tape.
8. To edit segments that you do not want to copy:
  - Press PLAY•PAUSE on *recording VCR* to pause copying.
  - Locate the next segment you want to copy on *playback VCR* by using FWD, REV, and PLAY•PAUSE, and then press PLAY•PAUSE.
  - Press PLAY•PAUSE on *both VCRs* at the same time to resume copying.
9. Press STOP•EJECT on *both VCRs* when you are finished.

### Caution:

The unauthorized recording of television programs or other materials may infringe the rights of others.

### Two VCR Connection

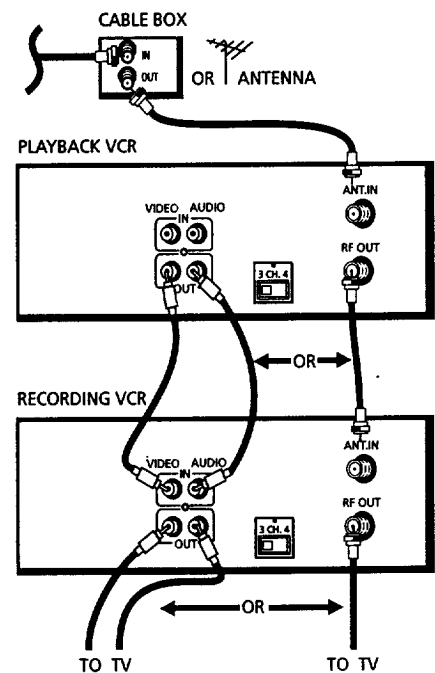



# OTHER FEATURES

## FEATURES TO ENHANCE VCR OPERATION

- Picture Search Options
- Time Counter
- On-Screen Displays
- Tracking

**1** FIRST THINGS FIRST



**2** SETTING UP THE VCR



**3** VCR BASICS



**4** RECORDING



**5** OTHER FEATURES



**6** CONNECTIONS

# OTHER FEATURES

## PICTURE SEARCH OPTIONS

The most basic way to search during playback is using the forward and reverse functions. This section contains several other options available for searching a tape.

### FORWARD AND REVERSE SEARCH

You can view a tape during play or play-pause. Sound is turned off during picture search. Search works best for tapes recorded at the SP or SLP speed.

1. Press FWD to search forward or REV to search in reverse.
2. Press FWD or REV again or press PLAY on the remote (PLAY•PAUSE on the VCR) to return to normal playback.

### SLOW MOTION

You can view a tape during play or play-pause using slow motion. Slow motion works best for tapes recorded at the SP or SLP speed.

1. Press SLOW on the remote to begin slow motion playback.
2. Use TRACKING up or down to remove any streaks from the picture.
3. Press PLAY on the remote (PLAY•PAUSE on the VCR) to return to normal playback.

The VCR switches automatically from slow-motion playback to stop after a few minutes.

### COMMERCIAL SCAN (SEARCH BUTTON)

This is useful for skipping commercials or short program segments.

- Press SEARCH once during playback to advance the tape approximately 30 seconds of recorded material.
- Each press of the SEARCH button adds an additional 30 seconds up to 5 minutes.

#### Insert Tape

Remember to insert a recorded tape when using the search features.

# OTHER FEATURES

## FRAME ADVANCE

Frame advance lets you view one-stop action frame after another. Frame advance works best for tapes recorded at the SP or SLP speed.

1. Press PAUSE on the remote (PLAY•PAUSE on the VCR) to "freeze" the action.
2. Press F.ADV each time you want to view the next frame of the scene.
3. Press PAUSE or PLAY on the remote (PLAY•PAUSE on the VCR) to return to normal playback.

## INDEX SEARCH

The VCR has a "VHS Index Search System" that automatically records an index mark on the tape every time you start a recording. During playback you can locate the program you want to play by the number of index marks or by scanning. The VCR will search forward or reverse from the location you are on the tape.

### To Search:

1. Stop the tape and press SEARCH on the remote to display the INDEX SEARCH menu on the TV screen.
2. If you want to search through a certain number of index marks, press two number buttons to enter the number of marks you want to search. Press CLEAR on the remote to correct an entry.
3. Press FWD to search forward or REV to search in reverse. The VCR will locate your index mark and begin playback. If you did not enter a specific index number, the VCR will locate the next index mark and begin playback.
4. Press STOP to stop index searching.

Some index marks may be missed by the VCR:

- A mark too close to your location on the tape.
- The mark at the beginning of a recorded segment of five minutes or less.
- The first index mark on the tape when you start at the beginning of the tape.

```
INDEX SEARCH
Press REV or FWD
to begin scanning
or
enter a specific
index number
  --
Press SEARCH to exit
```

```
INDEX SEARCH
Press REV or FWD
to begin search
Index number
  12
Press SEARCH to exit
```

```
INDEX SEARCH
Searching for
index number 12...
Press STOP to cancel
```

# OTHER FEATURES

## ZERO SEARCH

The zero search feature enables the VCR to quickly return to a counter reading of 0:00:00 anywhere on the tape. This is especially convenient when you want to repeat a segment of the tape several times.

1. Go to the beginning of the program you wish to return to.
2. Press INFO **twice** to display the timer counter on the TV screen.
3. Press CLEAR to reset the counter to 0:00:00.
4. Continue playing the tape.
5. Press STOP.
6. Press SEARCH on the remote **twice** to display the ZERO SEARCH menu.
7. Press REV to return to 0:00:00 on the tape.

```
ZERO SEARCH
Current tape counter is
  2:17:25
Press REV to go to
  0:00:00
Press SEARCH to exit
```

```
ZERO SEARCH
Searching for
0:00:00...
Press STOP to cancel
```

## TIME COUNTER

The time counter shows the actual time it takes to record a program or play back a segment of a recorded tape. It helps locate the beginning or end of programs you taped. The time counter resets to 0:00:00 whenever the tape is ejected from the VCR.

For example, if you record a 30-minute program at the beginning of the tape and you want to go to the end of that program to begin another recording, you would:

1. Press INFO **twice** to display the time counter.
2. Press CLEAR to reset the time counter to 0:00:00.
3. Press FWD to forward the tape until the time counter reads 0:30:00.
4. Press STOP. This is the approximate end of the program. (You may want to press PLAY to verify.) Now, you can begin recording at this spot.
5. Press INFO to remove the time counter from the screen and return to the normal display mode.

```
0:30:00
Hours
Minutes
Seconds
```

# OTHER FEATURES

## ON-SCREEN DISPLAYS

The INFO button shows the status of the VCR (STOP, PLAY, RECORD, etc.), channel number, time counter, date, time, and tape speed on the TV screen. The date and time must be set before they can be displayed.

1. Press INFO to see the on-screen displays.
2. Press INFO again to have only the time counter remain on the screen.
3. Press INFO again to return to the normal display.  
No displays appear on the screen.

Turning off the VCR also resets the displays.

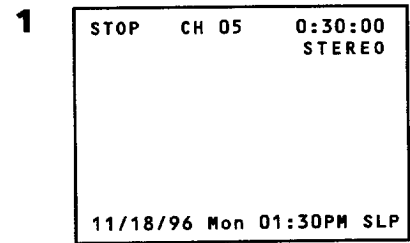

*On-screen display (times out)*

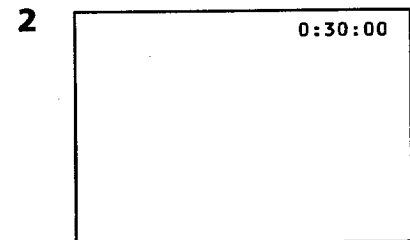

*Timer counter only  
(does not time out)*

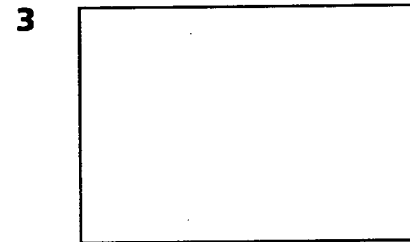

*Normal display*

## TRACKING

Your VCR has automatic tracking which removes the streaks or snow from the picture. Automatic tracking is activated when you insert a tape or turn on the VCR. Occasionally you may need to manually adjust tracking, especially if the tape was recorded on a different VCR. Just use the TRACKING buttons to remove the streaks or snow. You can also use tracking when you PAUSE a tape to reduce jittering of the picture.

When you manually adjust the picture, automatic tracking is turned off. To turn automatic tracking back on, press both TRACKING buttons on the front of the VCR at the same time, or eject the tape and re-insert it.

Tracking has no effect during recording--only playback.





# CONNECTIONS

## THINGS TO KNOW BEFORE CONNECTING COMPONENTS

### PROTECT YOUR COMPONENTS FROM POWER SURGES

- Connect all components before plugging any power cords into the wall outlet.
- Always turn off the TV and other components before you connect or disconnect any cables.

### POSITION CABLES CORRECTLY TO AVOID AUDIO HUM OR INTERFERENCE

- Insert all cable plugs firmly into their jacks.
- Place the audio/video cables to the sides of the TV's back panel instead of straight down the middle after you connect your components.
- Try not to coil any twin-lead cables and keep them away from the audio/video cables as much as possible.
- Make sure all antennas and cables are properly grounded. Refer to the Safety Tips sheet packed with your unit.

### PROTECT YOUR COMPONENTS FROM OVERHEATING

- Do not block ventilation holes in any of the components. Arrange the components so that air can circulate freely.
- Do not stack components.
- Allow adequate ventilation when placing your components in a stand.
- Place an amplifier or satellite receiver on the top shelf of the stand so heated air rising from it will not flow around other components.

## 1 FIRST THINGS FIRST



## 2 SETTING UP THE VCR



## 3 VCR BASICS



## 4 RECORDING



## 5 OTHER FEATURES



## 6 CONNECTIONS

# CONNECTIONS

## CONNECTING YOUR VCR

Refer to these pages to help you connect your VCR.

### JACKS AND CABLES

#### RF Jacks and Coaxial Cables (F-type)

The RF jacks provide good picture and mono sound, and must be used if audio/video connections are not available for your TV.

These jacks are required for antenna or cable-TV connections. The RF jacks on the VCR are labeled ANT.IN and RF OUT. The coaxial cable supplied with your VCR is used to connect the VCR's RF OUT jack and your TV's antenna input.



RF Jack

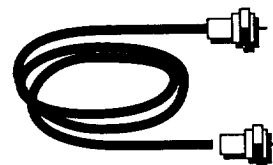

#### Audio/Video Jacks and Cables (RCA-type)

The audio/video jacks provide very good picture and sound and can be used if your TV has audio/video input jacks.

These jacks must be used for most audio/video connections. The VCR audio/video jacks are color coded (yellow for video and white for left audio). If your TV has only two inputs for audio (stereo), connect the one labeled mono. If one is not labeled mono, you may need a Y-adaptor.



Audio/Video Jack

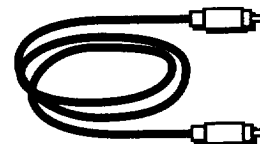

# CONNECTIONS

## CHOOSING A VCR CONNECTION

There are several different ways to hook up your VCR, depending on whether or not you have cable, and if you have cable, whether you have a cable box, and if some of the channels are scrambled and...well, you get the picture.

Three connections are described in this section and one of them should provide you with a VCR hookup that works.

- TV with RF Jack only
- TV with audio/video jacks
- TV with audio/video jacks and cable box to unscramble pay channels only

If you need to hook up additional components not shown in the diagrams here (and are unsure of how to connect them), refer to the instruction manual that came with that particular component.

## ADVANTAGES OF AUDIO/VIDEO CABLE CONNECTIONS

Using a simple coaxial cable connection gives you good picture quality. If your television has A/V jacks, I highly recommend using them to get even better picture when recording and playing back videotapes. These connections give you more convenient operation by not having to share the TV's RF signal.

## DON'T FORGET ABOUT THE AUTO TV/VCR FEATURE

The TV/VCR switch controls whether the picture signal is coming from the VCR or the TV. You can change the setting manually by using the TV•VCR button on the remote, or you can set the Auto TV/VCR feature to automatically switch to VCR mode when the VCR is turned on. Set the Auto TV/VCR feature to ON when using only RF ANTENNA connections and OFF when using the A/V output jacks—so your TV signal is not interrupted when the VCR is turned on.

# CONNECTIONS

## TV WITH RF JACK ONLY

This connection assumes:

- You are connecting antenna, cable, or cable box system.
- Your television has only an RF input jack.

This connection provides:

- Mono sound playback from VCR.
- Record one channel while watching another (except when using a cable box for all channels).

To use this connection, you must have:

- (1) coaxial cable for cable or antenna connection; (2) for cable box

To connect:

1. Connect cables as shown.
2. Return to *First Things First*, then follow the steps.

## Using This Connection

Tune your TV to channel 3 or 4 whichever one you selected with the switch on the back of the VCR. Use the TV•VCR button to watch the VCR.

Auto TV/VCR Setting:

- Set the Auto TV/VCR feature to ON.

To play a tape:

1. Insert a tape.
2. If necessary, press PLAY.

To record one program and watch another:

1. Begin recording a program using one of the recording options.
2. Press the TV•VCR button and select a different channel on the TV.

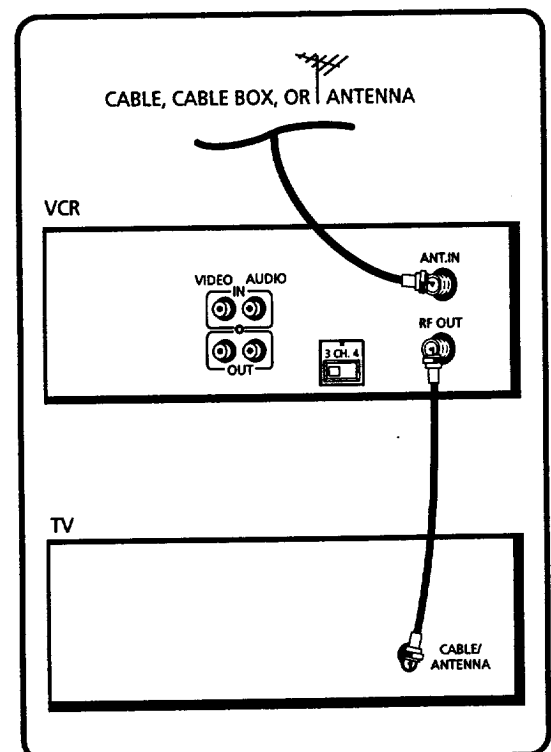

# CONNECTIONS

## TV WITH AUDIO/VIDEO JACKS

This connection assumes:

- You are connecting an antenna, cable, or cable box system.
- Your television has audio/video jacks.

This connection provides:

- Mono sound playback from VCR.
- Record one channel while watching another (except when using a cable box for all channels).

To use this connection, you must have:

- (1) coaxial cable for cable/antenna connection; (2) for cable box
- (2) audio/video cables

To connect:

1. Connect cables as shown.
2. Return to *First Things First*, then follow the steps.

### Using This Connection

Tune your TV to its video input channel. Use of the TV•VCR button is not required.

Auto TV/VCR Setting:

- Set the Auto TV/VCR feature to OFF.

To play a tape:

1. Insert a tape
2. If necessary, press PLAY.

To record one program and watch another:

1. Begin recording a program using one of the recording options.
2. Select a different channel on the TV.

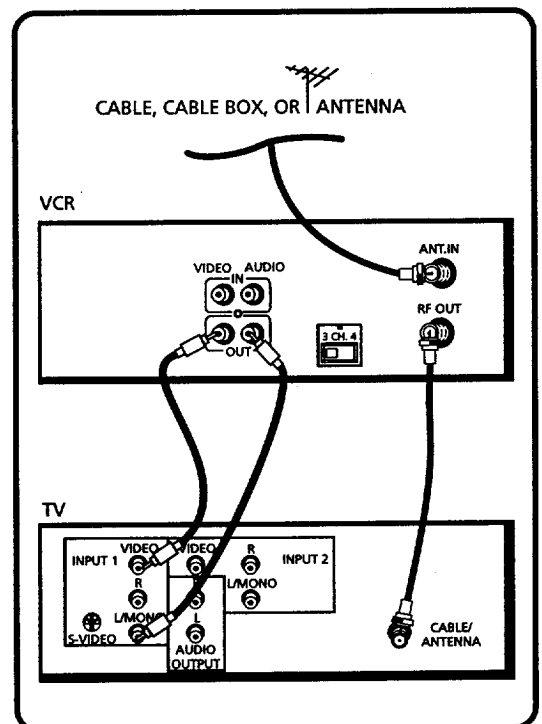

# CONNECTIONS

## TV WITH AUDIO/VIDEO JACKS AND CABLE BOX TO UNSCRAMBLE PAY CHANNELS ONLY

### This connection assumes:

- You are using a cable box only to unscramble premium channels.
- Your TV has audio/video input jacks.

### This connection provides:

- Mono sound playback from VCR.
- Recording a scrambled or unscrambled channel through the cable box while watching an unscrambled channel.

### To use this connection, you must have:

- (3) coaxial cables
- (2) audio/video cables
- (1) splitter

### To connect:

1. Connect cables as shown.
2. Return to *First Things First*, then follow the steps.

### Using This Connection

Tune your TV to its video input channel. Use of the TV•VCR button is not required.

### Auto TV/VCR Setting:

- Set the Auto TV/VCR feature to OFF.

### To play a tape:

1. Insert a tape.
2. If necessary, press PLAY.

### To record a scrambled or unscrambled program and watch another unscrambled:

1. Begin recording a scrambled program through the cable box using one of the recording options.
2. Select an unscrambled channel on the TV.

All scrambled channels must be viewed through the VCR.

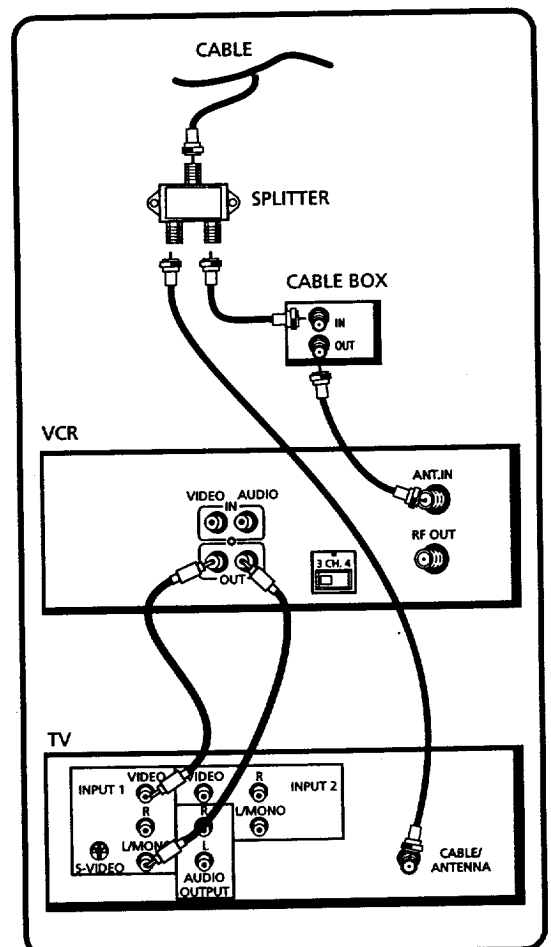

## **APPENDIX A: REFERENCE**

**This section gives you some additional information about the VCR, including a description of the unit's controls and display.**

**You also will find a Troubleshooting Tips section in this Appendix, which might help to resolve some of those simple problems.**

**Finally, this section contains your warranty information.**

# APPENDIX A: REFERENCE

## FRONT PANEL

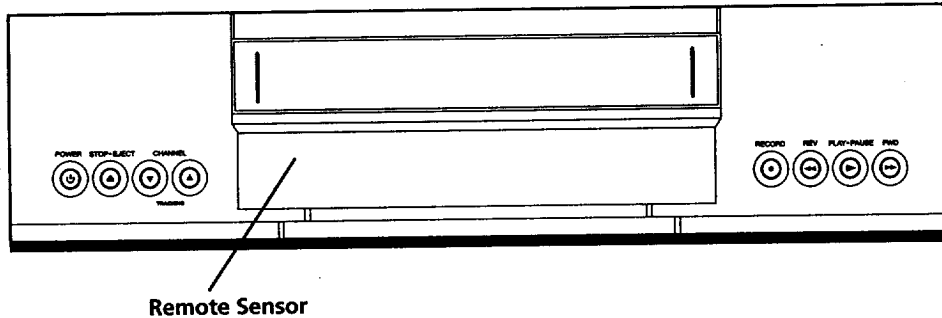

**CHANNEL•TRACKING Up or Down** Selects next higher or lower channel in the VCR's channel memory. Adjusts tracking when a tape is playing.

**FWD** Forwards the tape when the VCR is stopped. Searches the picture forward during playback. Starts slow motion when tape is paused.

**PLAY•PAUSE** Plays a tape. Pauses action for viewing during playback. Pauses recording to prevent recording of unwanted scenes.

**POWER** Turns the VCR on or off.

**RECORD** Starts VCR recording. Used for express recording.

**Remote Sensor** Receives signals from the remote control. Aim the remote at this sensor.

**REV** Rewinds the tape when the VCR is stopped. Searches the picture in reverse during playback. Starts slow motion when tape is paused.

**STOP•EJECT** Stops the normal functions such as record, playback, rewind, fast-forward, or pause. Ejects the tape when the VCR is stopped.



# APPENDIX A: REFERENCE

## BACK PANEL

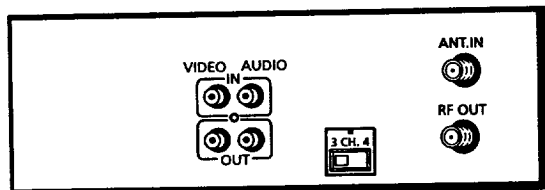

**3 CH. 4 Switch** Selects the channel to which you will tune the TV to see the VCR picture if you connect the VCR using the ANT.IN and RF OUT jacks.

**AUDIO and VIDEO IN Jacks** Receives signals from another component, like a VCR or camcorder, when it is connected to these jacks. Use INPUT on the remote to select.

**AUDIO and VIDEO OUT Jacks** Sends signals from VCR to another component, like a TV or VCR, when it is connected to these jacks.

**ANT. IN Jack** Receives a signal from an antenna or cable system when attached.

**RF OUT Jack** Passes signal to TV using the cable supplied.

## INDICATOR PANEL

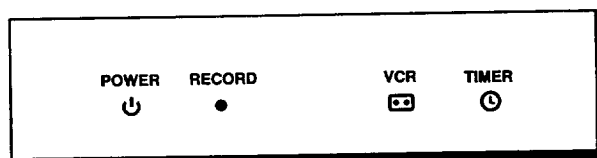

**POWER indicator** Lights when the VCR is turned on.

**RECORD Indicator** Lights when the VCR is recording.

**TIMER Indicator** Lights during an express or timer recording, or when the VCR is set for a timer recording and the VCR is turned off. Flashes when a timer recording is set, and there is no cassette in the VCR.

**VCR Indicator** (Applies Only if the VCR Viewing Channel is 3 or 4). Press the TV•VCR button to turn on or off.

- VCR indicator on: Picture from VCR.
- VCR indicator off: Picture from TV channel.

# APPENDIX A: REFERENCE

## TROUBLESHOOTING TIPS

### No power

- Check to make sure it is plugged into an operating outlet.
- Check to make sure your connections are correct.

### VCR does not respond to remote

- Check to make sure there are no objects between the VCR and remote.
- The batteries may need changing.
- Make sure the Remote VCR1/VCR2 setting is set to VCR1 so the remote that came packed with your VCR can operate it.
- Remove batteries and hold number button 1 for at least 60 seconds to drain the microprocessor inside the remote. Release number 1 and replace the batteries.
- Remove all batteries for approximately 12 hours. Then replace batteries.

### Poor or no picture for normal TV viewing

- Check to make sure the VCR indicator is off.
- Check to make sure the TV is switched to an active channel.
- Check to make sure the antenna connections are secure and correct.

### Snowy or no picture during playback

- Press TV•VCR to turn VCR indicator on.
- Check TV channel selected (3 or 4) to make sure it matches the channel selected with 3 CH. 4 switch on back of VCR.
- Check to make sure the TV's fine tuning is correct for the channel you have selected.
- Check video cable connections between VCR and TV monitor.
- Check to make sure the TV monitor is set to video input channel.
- Try another tape.
- Some snow/streaks are normal during search, stop action, frame advance, and slow-motion playback.

### Streaks in picture during normal playback

- Press one of the TRACK buttons to move streaks up or down for the best picture.
- Check to make sure the tape is of good quality and not worn out.

### Time counter not working or time counter not working in search modes

- The time counter does not advance during unrecorded portions of tape. When an unrecorded segment of tape is encountered, the time counter will hold its count until recorded material is detected again.
- A minus (-) will appear in front of the time if you rewind the tape farther back than a counter reading of 0:00:00.
- The time counter disappears during search; this is normal.

# APPENDIX A: REFERENCE

## Will not record or play

- Check to make sure there is a tape in the VCR.
- Try ejecting and reinserting the cassette.
- Check to make sure the tape is not broken.
- Check to make sure the VCR is not in pause mode. Press PAUSE or PLAY on the remote (PLAY•PAUSE on the VCR) to return to normal playback.

## Will not record

- Check to make sure the safety tab is intact.
- Check to make sure the VCR is not in the line mode. Press INPUT on the remote.

## Rewind does not operate

- Check to make sure the tape is not already rewound.

## Timer recording not made or wrong program recorded

- Check to make sure the cable box was turned on when recording was to begin.
- Check to make sure the program was entered correctly (wrong channel or times).
- Power interruption. Reset the clock.
- Check to see if time and date are correct – including AM/PM.
- Check to make sure the program did not exceed the tape's length or the tape was not rewound beforehand.
- Check to make sure the VCR was turned off at the time recording was to start.
- Check to make sure there was a tape in the VCR and the cassette's safety tab was intact.
- VCR ejects cassette when the end of the tape is reached during a timer recording.

## Internal clock shows incorrect time or date

- Power interruption.
- Check to make sure the clock is set accurately (check AM/PM and date).
- Check Auto DST setting. The clock may have adjusted for daylight-saving time.

## Time did not adjust for daylight-saving time

- Check to make sure Auto DST feature is turned on.

## VCR makes noise when stopped

- VCR is removing tape from heads. This is normal. The head cylinder inside the VCR will continue to rotate for a few minutes after you put the VCR in the stop mode.

# APPENDIX A: REFERENCE

## **Will not Auto Channel Search active channels correctly**

- Check to make sure the antenna connections are secure and correct.
- Check to make sure the Signal Type: CABLE/ANTENNA feature is set correctly.
- If Detect Automatically was selected for the Signal Type in the AUTO CHANNEL SEARCH menu, try using either CABLE TV or ANTENNA instead.
- May not need to auto channel search if using a cable box. Refer to the VCR Channel List or contact your cable company for more information.

## **Tape plays back in slow motion**

- Press PLAY to return to normal playback.

## **Cannot select channels over 69**

- Cable channels over 69 can only be selected if Signal Type: CABLE/ANTENNA feature is set to CABLE.

## **Cassette with safety tab removed does not start to play automatically**

- Check to make sure the Auto Play ON/OFF feature is set to ON.

## **TIMER indicator flashes**

- Check to make sure there is a cassette in the VCR when a timer recording is set.

## **On-screen menus appear in English, French, or Spanish**

- Check Language feature.

# APPENDIX A: REFERENCE

## SPECIFICATIONS

<b>Format:</b>	VHS
<b>Record/Playback System:</b>	Video: 2-Head Audio: Mono record/playback system
<b>Video Signal System:</b>	EIA standard: NTSC color
<b>Antenna:</b>	75-ohm external VHF/UHF combined antenna terminal
<b>Tuner:</b>	USA: 181 channels capability* (125 cable channels)  Canada: 178 channels capability* (122 cable channels)
<b>Type:</b>	AutoProgramming frequency synthesis
<b>Power Requirement:</b>	120V AC, 60 Hz
<b>Power Consumption:</b>	17 watts
<b>Dimensions:</b>	3.54 inches high (90 mm) 14.1 inches wide (360 mm) 10.9 inches deep (278 mm)
<b>Weight:</b>	7.92 pounds (3.6 kg)
<b>Storage Temperature Range:</b>	- 22°F to +149°F (-30°C to +65°C)
<b>Operating Temperature Range:</b>	+41°F to +104°F (+5°C to +40°C)

\*Check your cable company's compatibility requirements.

## CLEANING THE VCR

Use a soft cloth or dusting attachment of your vacuum cleaner to dust your VCR. Remove dust from the ventilation holes on the top, back, sides, and bottom of the cabinet.

Plastic surfaces are easily scratched and can be marred by alcohol and various solvents. Avoid excessive use of oil-based furniture polishes since the materials used in the cabinet will accumulate more dust. We recommend using a nonabrasive, antistatic cleaner and polisher.

Specifications are subject to change.

# APPENDIX A: REFERENCE

## LIMITED WARRANTY

### What your warranty covers:

- Any defect in material or workmanship.

### For how long after your purchase:

- Ninety days for labor charges.
- One year for parts.

The warranty period for rental units begins with the first rental or 45 days from date of shipment to the rental firm, whichever comes first.

### What we will do:

- Pay any Authorized RCA VCR Servicenter the labor charges to repair your VCR.
- Pay any Authorized RCA VCR Servicenter for the new or, at our option, refurbished replacement parts required to repair your VCR.

### How you get service:

- Take your VCR to any Authorized RCA VCR Servicenter. To identify your nearest Authorized RCA VCR Servicenter, ask your dealer, look in the Yellow Pages, or call 1-800-336-1900.
- Show the service technician your evidence of purchase date.
- Pick up your VCR when repairs are completed.

### What your warranty does not cover:

- Customer instruction. (Your Owner's Manual clearly describes how to install, adjust, and operate your VCR. Any additional information should be obtained from your Dealer.)
- Installation and related adjustments.
- Signal reception problems not caused by your VCR.
- Damage from misuse or neglect.
- Cleaning of video/audio heads.
- Remote control batteries.
- A VCR that has been modified or incorporated into other products or is used for institutional or other commercial purposes.
- A VCR purchased or serviced outside the USA.
- Acts of God, such as but not limited to lightning damage.

### Product Registration:

- Please complete and mail the Product Registration Card packed with your VCR. It will make it easier to contact you should it ever be necessary. The return of the card is not required for warranty coverage.

### How state law relates to this warranty:

- This warranty gives you specific legal rights, and you also may have other rights that vary from state to state.

### If you purchased your VCR outside the United States:

- This warranty does not apply. Contact your dealer for warranty information.

# INDEX

3 CH. 4 switch 5

## A

Access menus 5  
Add or remove channels 10  
ANT. IN Jack 32, 37  
AUDIO/VIDEO jacks 4, 5, 39  
AUTO CHANNEL SEARCH menu 9  
Auto DST: ON or OFF feature 11  
Auto Play feature 14, 17  
Auto TV/VCR feature 14, 33  
Automatic rewind 18  
Automatic tracking 29

## B

Back panel 39  
Basic recording 18  
Batteries installing in the remote 4  
Buttons, remote 16, 17

## C

Cable TV installer information 2  
Cables 32  
Cables, positioning 31  
Cables, types of 32  
CHAN buttons 14  
CHANNEL buttons 38  
Channel, viewing 5  
Channels, add or remove 10  
Channels list, VCR 8  
Choosing a VCR connection 33  
Cleaning the VCR 43  
CLEAR button 16, 27, 28, 29  
Clearing programs 22  
Commercial scan feature 26  
Connections 31  
    audio/video cable 33  
    choosing 33  
    TV with audio/video jacks 35  
    TV with audio/video jacks and cable box to unscramble pay channels 36  
    TV with RF jack only 34  
Controls  
    back panel 39  
    front panel 38  
Copying and editing tapes 23

## D

Daylight-saving time 11  
Displays  
    on-screen 29

## E

Editing tapes 23  
Eject, tape 17  
English language 8  
Express recording 20

## F

F.ADV button 16, 27  
Frame advance 27  
French language 8  
Front panel controls 38  
FWD button 16, 17, 23, 26, 27, 38

## G

GO BACK button 16

## I

Index search feature 27  
Indicator panel 39  
NFO button 16, 29  
INPUT button 16, 21, 23, 39

## J

Jacks, types of 32

## L

Language feature 8  
LP Speed 18, 20  
Limited warranty 44

## M

MENU button 16  
Menus, access 5

## N

Number buttons 10, 16

## O

On-screen displays 29  
Overheating 31

## P

Panel, indicator 39  
PAUSE button 16, 17  
Picture search options 26  
PLAY button 16, 17, 23  
PLAY•PAUSE button 17, 23, 38  
Playing a tape 17  
POWER button 7, 16, 18, 38  
POWER indicator 39  
Power surges 31  
PREFERENCES menu 12  
PROGRAMS OVERLAP message 21

## R

RECORD button 16, 18, 20, 23, 38  
RECORD indicator 39  
Recording  
    basic 18  
    express 20  
    speeds 18, 20  
    timer 21  
Remote buttons 16, 17  
Remote control installing batteries 4  
Remote Control VCR1/VCR2 feature 13  
Remote sensor 38  
Remove or add channels 10  
REV button 16, 17, 24, 26, 27, 38  
Reviewing programs 22  
Rewind, automatic 18  
RF OUT jack 32, 39

## S

Safety tab 18  
Search  
    commercial scan 26  
    forward 26  
    index 27  
    reverse 26  
    slow motion 26  
    zero 28  
SEARCH button 16, 26, 27, 28  
Sensor, remote 38

SET TIME AND DATE menu 11

Set up

    auto play feature 14  
    auto TV/VCR feature 14  
    language 8  
    remote VCR1/VCR2 feature 13  
    time and date 11

Setting the language 8

Setting up

    channel list 8, 9

Signal type

    selecting 9, 10

Signal type, changing 9, 10

SLOW button 16, 26

Slow motion playback 26

Solving problems 40

SLP Speed 18, 20

SP Speed 18, 20

Spanish language 8

Specifications 43

Speed

    LP 18, 20

    SLP 18, 20

    SP 18, 20

SPEED button 17, 18, 19, 23

Speeds, recording 18, 20

STOP button 17, 18, 20, 21, 22, 23

STOP•EJECT button 17, 20, 22, 23, 38

Stopping a timer recording 22

## T

Tab, safety 18

Tape eject 17

Tape, playing a 17

Tape speeds 18, 20

Time and date

    set 12

    set daylight-saving 11

Time counter 28

TIMER indicator 39

Timer recording 21

    stopping 22

TIMER RECORDINGS menu 21

Tracking 29

TRACKING buttons 17, 29, 38

Troubleshooting tips 40

TV/VCR auto 14, 33

TV•VCR button 17, 33

## V

VCR

    cleaning 43

VCR channels list 8

VCR indicator 39

VCR1/VCR2 remote feature 13

Viewing channel 5

## W

Warranty, limited 44

## Z

Zero search feature 28

If your VCR needs service, please contact your dealer or the nearest Servicenter from the yellow pages. Please do not send any products to the Indianapolis address listed in this manual or on the carton. This will only add delays in service for your product.

 **THOMSON CONSUMER ELECTRONICS**  
10330 North Meridian Street  
Indianapolis, IN 46290

©1997 Thomson Consumer Electronics, Inc.  
Trademark(s)® Registered  
Marca(s) Registrada(s)  
Printed in Mexico  
**TOCOM 15226060**