

# OPERATING GUIDE & WARRANTY

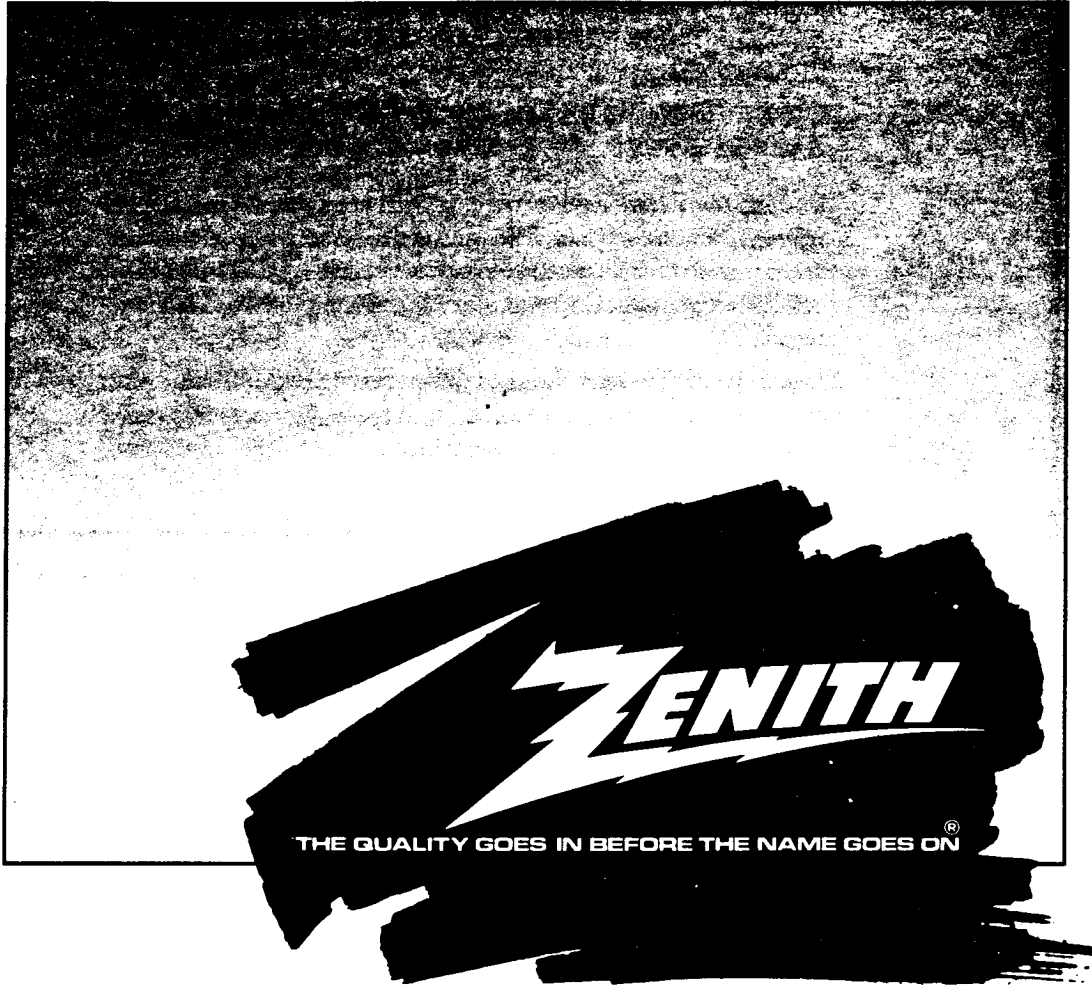

## **SENTRY 2** MTS Stereo Color TV with Remote Control and Closed Captions



Return the Product Registration  
Card, and your TV could be free!



## WARNING

**RISK OF ELECTRIC SHOCK  
DO NOT OPEN**



**WARNING:** TO REDUCE THE RISK OF ELECTRIC SHOCK DO NOT REMOVE COVER (OR BACK). NO USER SERVICEABLE PARTS INSIDE. REFER TO QUALIFIED SERVICE PERSONNEL.

TO PREVENT FIRE OR SHOCK HAZARDS, DO NOT EXPOSE THIS PRODUCT TO RAIN OR MOISTURE.



The lightning flash with arrowhead symbol, within an equilateral triangle, is intended to alert the user to the presence of uninsulated "dangerous voltage" within the product's enclosure that may be of sufficient magnitude to constitute a risk of electric shock to persons.



The exclamation point within an equilateral triangle is intended to alert the user to the presence of important operating and maintenance (servicing) instructions in the literature accompanying the appliance.

### Safety Tips

Refer to the "Safety Tips" booklet that came with your product for important safety considerations.

### Note to Cable TV System Installer

This reminder is provided to call the cable TV system installer's attention to Article 820-40 of the NEC that provides guidelines for proper grounding and, in particular, specifies that the cable ground shall be connected to the grounding system of the building, as close to the point of the cable entry as practical.

### Power-Cord Polarization

This product is equipped with a polarized alternating-current line plug (a plug having one blade wider than the other.) This plug will fit into the power outlet only one way. This is a safety feature. If you are unable to insert the plug fully into the outlet, try reversing the plug. If the plug should still fail to fit, contact your electrician to replace your obsolete outlet. Do not defeat the safety purpose of the polarized plug.

### CAUTION

To prevent electric shock, match wide blade of plug to wide slot, fully insert.

### ATTENTION

Pour éviter les chocs électriques, introduire la lame la plus large de la fiche dans la borne correspondante de la prise et pousser jusqu'au fond.

# CONTENTS

<b>INTRODUCTION</b>	
Welcome .....	ii
Installation Considerations .....	ii
<b>CONNECTIONS FOR YOUR TV</b>	
Connection Center on Back of TV .....	1-1
Input Sources for Your TV .....	1-1
Stereo Audio Output .....	1-1
Step 1. Make Basic Connection to TV .....	1-2
Step 2. Make VCR Connections to TV .....	1-4
Step 3. Make Stereo Audio Connection to Audio Amplifier .....	1-5
<b>THE FIRST TIME YOU OPERATE YOUR TV</b>	
Step 1. Connect the Power .....	2-1
Step 2. Turn TV On .....	2-1
Step 3. Use Auto Ch. (Channel) Search .....	2-1
Step 4. Use Other Options .....	2-1
<b>GETTING TO KNOW YOUR TV</b>	
Horizontal Control Panels .....	3-1
Vertical Control Panel .....	3-2
<b>REMOTE CONTROL MODEL SC3390</b>	
Operation .....	4-1
Preparation for Use .....	4-2
Installing Batteries .....	4-2
<b>REMOTE CONTROL MODEL SC3820</b>	
TV Operations .....	5-1
VCR Operations .....	5-2
TV and VCR Operational Notes .....	5-3
Preparation for Use .....	5-3
Installing Batteries .....	5-3
<b>OPERATING YOUR TV</b>	
Basic TV Operations .....	6-1
Sleep Timer .....	6-1
<b>ON-SCREEN MENUS</b>	
Available Menus .....	7-1
Summary of Menu Items .....	7-1
Basic Menu Operations .....	7-2
<b>SETUP MENU</b>	
Auto Ch. (Channel) Search .....	8-1
Ch. (Channel) Add/Del .....	8-2
Ch. (Channel) Labels (Some Models) .....	8-2
Tuning Band .....	8-3
Auto Fine Tune .....	8-3
Clock Set .....	8-4
Captions .....	8-4
Ch. (Channel) Background .....	8-5
<b>AUDIO MENU</b>	
General Information .....	9-1
Bass .....	9-1
Treble .....	9-1
Balance .....	9-1
Audio .....	9-1
Audio Selection Considerations .....	9-2
<b>VIDEO MENU</b>	
Contrast .....	10-1
Brightness .....	10-1
Color .....	10-1
Tint .....	10-1
Sharpness .....	10-1
Picture Pref. (Preference) .....	10-1
<b>MAINTENANCE AND TROUBLESHOOTING</b>	
Caring for Your TV .....	11-1
Extended Absence .....	11-1
TV Picture Interference .....	11-1
Before Calling for Service .....	11-2
VCR Operational Mode Charts .....	11-3
<b>Product Registration Card</b>	
<b>Recommended Accessories for Your Television</b>	
<b>Your Zenith Warranty</b>	

## USING YOUR OPERATING GUIDE

This operating guide describes a family of TV models. Some models have features that are not provided on other models. Different control panels and remote controls may be used from model-to-model. Refer to the applicable sections of this operating guide for the features and items provided with your TV.

---

# INTRODUCTION

---

## WELCOME

Welcome into the family of Zenith Color Television owners. This guide provides instructions on how to operate your new TV. It is supplemented by a booklet containing Safety Tips. We urge you to read these publications carefully so that you will receive full enjoyment from your new Zenith TV for many years to come.

Your new Zenith TV has been designed and built to give you the very best in quality, features and performance. There are many regional Zenith distributors and thousands of distributor-approved Zenith service centers throughout the U.S. and Canada who can attend promptly and effectively to ordinary service needs.

If you should have an unusual performance or service problem that cannot be satisfactorily resolved by your distributor-approved Zenith service center, contact the regional Zenith distributor in your area, or write:

**Zenith Electronics Corporation**  
Customer Service Department  
1900 N. Austin Avenue  
Chicago, Illinois 60639-5079  
Telephone: (312) 745-5152  
Mon-Fri, 8:00 a.m. - 4:30 p.m. Central Time

Send the model number, serial number, and date of purchase or original installation, with a full explanation of the problem and the service history. We will welcome the opportunity to look into your specific question or problem and to be of assistance in resolving it promptly.

The model and serial numbers of your new TV are located on the back of the TV cabinet. For your future convenience and protection, we suggest that you record these numbers here:

Model No. \_\_\_\_\_

Serial No. \_\_\_\_\_

---

## INSTALLATION CONSIDERATIONS

Before you install your TV...



**Ventilation** — Proper ventilation keeps your TV running cool. Air circulates through perforations in the back and bottom of the cabinet. Do not block these vents or you will shorten the life of your TV.



**Power Source** — Your TV is designed to operate on normal household current, 120 volt 60 Hertz AC. Do not attempt to operate it on DC current.



**Power Cord** — Your power cord has a polarized plug as required by Underwriters' Laboratories. It has one regular blade and one wide blade and fits only one way into a standard electrical outlet. If the blades will not enter either way, your outlet is very old and non-standard. A new outlet should be installed by a qualified electrician.



**Safe Operation** — Your TV is manufactured and tested with your safety in mind. However, unusual stress caused by dropping or mishandling, exposure to flood, fire, rain or moisture, or accidental spilling of liquids into the TV, can result in potential electrical shock or fire hazards. If this happens, have your TV checked by a service technician before using it again.

Please read and observe each safety point in the "Safety Tips" folder when installing and using your TV.

**FIXED PATTERN DISPLAY CAUTION** — If you use your TV for video games, teletext or other fixed displays, avoid setting the BRIGHTNESS control for an excessively bright picture. A bright, fixed pattern, if used for long periods of time, can result in a permanent imprint on the TV picture tube. You can reduce this possibility by alternating the use of the fixed pattern display with normal TV picture viewing, by turning down the CONTRAST control for sustained fixed pattern use, and by turning off the fixed pattern display when not in use.

**PLUGGING IN YOUR TV** — Be sure to plug your TV into an "unswitched" AC power source. The "switched" AC outlets found on some video equipment will not continue supplying power to the TV once the equipment is turned off. If the power to the TV is interrupted, you will have to reset the clock in the TV to the current time.

# CONNECTIONS FOR YOUR TV

## CONNECTION CENTER ON BACK OF TV

The connection center on the rear of your TV allows you to connect two viewing sources to your TV, and an external stereo sound amplifier, if desired. You can choose from a variety of audio/video components for your viewing pleasure. The diagram below lists the use of each jack on the connection center.

### 1. VHF-UHF/CABLE

Use this jack for 75-ohm, antenna-type signal connection to your TV. Attach your antenna, cable-TV line, or other video component to this jack. The input cable may come from an outdoor or master antenna, cable-TV line, cable-TV decoder box, or the RF output from a VCR.

### 2. AUX (Auxiliary) INPUT VIDEO

Video (Base Band) input from VCR or other video equipment (Disc Player). Gives improved picture quality performance over that obtained through the VHF-UHF/CABLE jack.

### 3. AUX (Auxiliary) INPUT AUDIO RIGHT and LEFT

Stereo audio input from VCR or other video equipment (Disc Player).

### 4. SPEAKER EXT/INT Switch

EXT position: TV's speakers are off.

INT position: TV's speakers are on.

### 5. VARIABLE AUDIO OUTPUT RIGHT and LEFT

Stereo audio output for customer's audio amplifier. This output is always present regardless of the position of the SPEAKER switch.

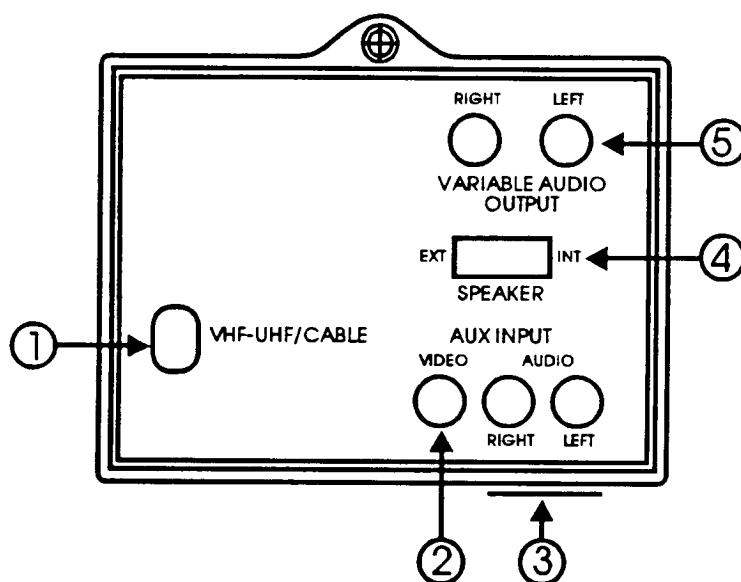

## INPUT SOURCES FOR YOUR TV

Your TV has two input connection areas: one is marked VHF-UHF/CABLE and the other AUX INPUT VIDEO – AUX INPUT AUDIO RIGHT and LEFT. These two inputs allow you to connect two different “signal sources” to your TV at the same time. The “Signal Source” refers to the item supplying the picture and sound to your TV.

The most common “signal source” is your outdoor antenna (or master antenna) or a cable-TV system. This type of signal is called a radio frequency (RF) source, and is connected to the VHF-UHF/CABLE input connector.

Another common “signal source” is the audio and video (A/V) from a VCR or video disc player. This type of signal is called base band (basic video and audio), and is connected to the AUX INPUT VIDEO – AUX INPUT AUDIO RIGHT and LEFT connectors. To use these VCR connections, you must watch the AUX channel on the TV. To select the AUX channel, press CHANNEL (CH) Up/Down until you select the next channel after the highest/lowest channel, or enter the number 999 from the remote control, or press SOURCE on the remote control if available.

## STEREO AUDIO OUTPUT

Your TV provides stereo audio output suitable for connection to your stereo sound system. Connect the VARIABLE AUDIO OUTPUT RIGHT and LEFT jacks to an unused

input on your stereo amplifier. You may continue to listen to the sound coming from the TV's speakers, or switch off the TV's speakers as desired.

# CONNECTIONS FOR YOUR TV

## STEP 1. MAKE BASIC CONNECTION TO TV

There are four basic hook ups to your TV; outdoor antenna (or master antenna) with or without VCR, and cable-TV system with or without VCR. Select the hook up that best fits your needs. See the following diagrams.

Your connection is made to the VHF-UHF/CABLE jack on the back of the TV. This jack accepts 75-ohm cable terminated in an F-type male connector. You may want to do the hook-up yourself, or call a TV service technician, or a cable company.

### A. Antenna Connection to TV

#### If You Have a Round Antenna Wire:

Connect the 75-ohm round antenna wire into the VHF-UHF/CABLE jack on the TV.

#### If You Have a Flat, Twin-Lead Antenna Wire:

Use the 300/75-ohm adaptor included with the TV. Hook up the ends of the wire to the adaptor and plug it into the VHF-UHF/CABLE jack.

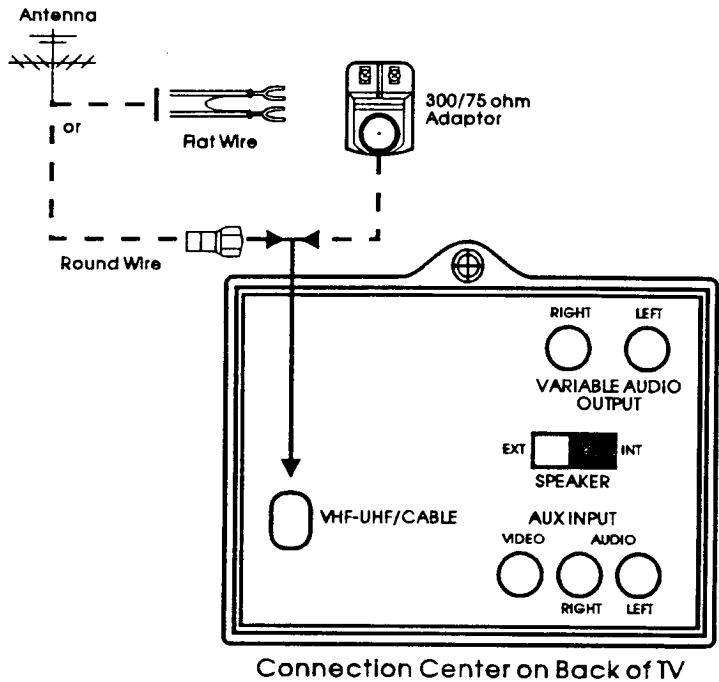

### B. Antenna Connection to VCR and TV

#### 1. Antenna Hook Up

Connect 75-ohm round antenna wire into ANTENNA IN jack on VCR.

#### 2. VCR Hook Up

Connect ANTENNA OUT wire from VCR into the VHF-UHF/CABLE jack on TV.

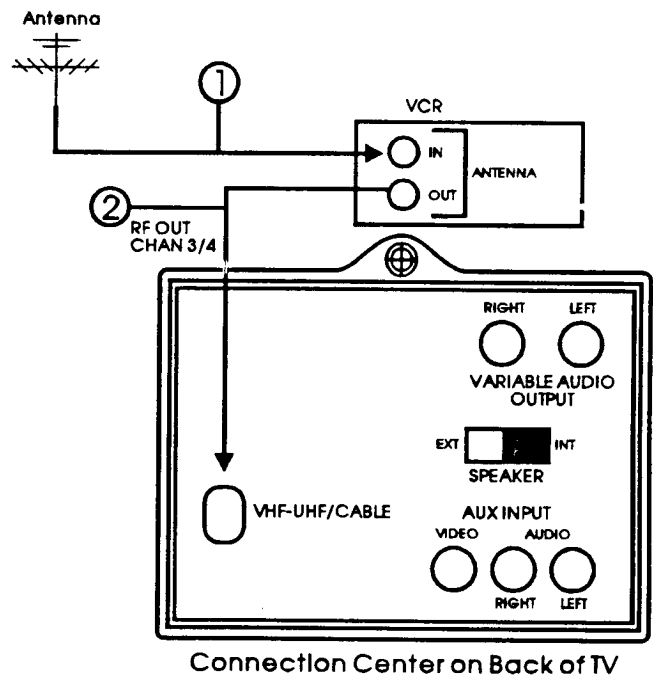

# CONNECTIONS FOR YOUR TV

## STEP 1. MAKE BASIC CONNECTION TO TV (CONTINUED)

### C. Cable-TV Connection to TV

#### If You Have a Converter/Decoder Box:

Connect the 75-ohm output from the converter/decoder box into the VHF-UHF/CABLE jack on the TV.

#### If You Do Not Have a Converter/Decoder Box:

Connect the 75-ohm round cable-TV line directly to the VHF-UHF/CABLE jack on the TV.

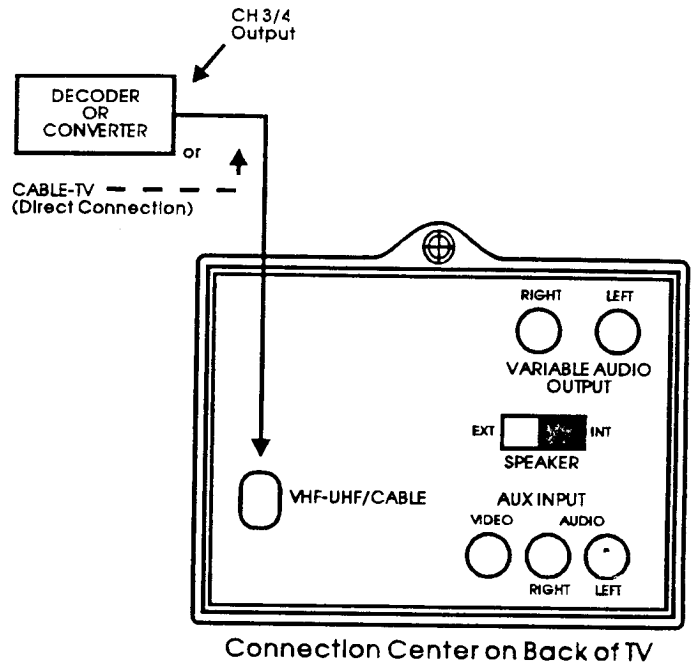

### D. Cable-TV Connection to VCR and TV

#### 1. Cable-TV Hook Up

Connect 75-ohm round cable-TV wire into ANTENNA IN jack on VCR.

#### 2. VCR Hook Up

Connect ANTENNA OUT wire from VCR into VHF-UHF/CABLE jack on TV.

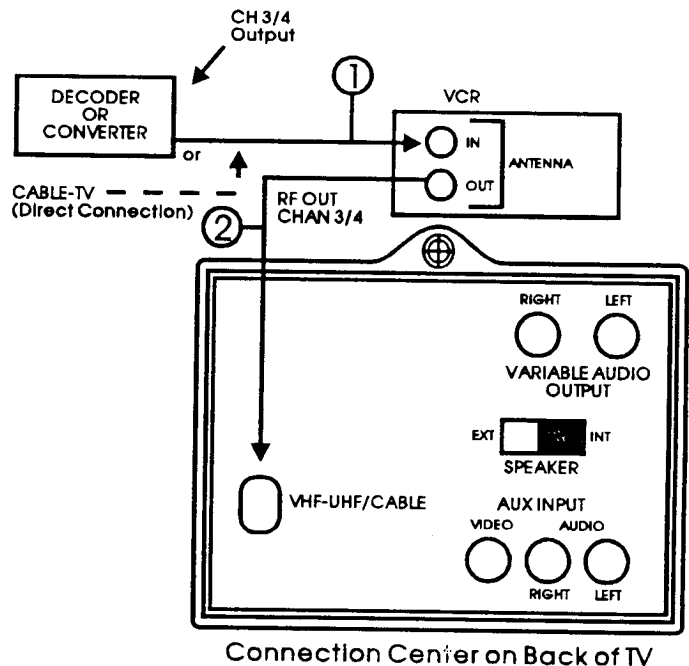

# CONNECTIONS FOR YOUR TV

## STEP 2. MAKE VCR CONNECTIONS TO TV

### STEREO VCR

**Connections:** You must make the following connections to obtain stereo audio sound from your TV while playing a stereo video tape.

1. Connect VCR RIGHT/LEFT AUDIO OUTPUT into AUX INPUT AUDIO RIGHT and LEFT jacks on TV.
2. Connect VCR VIDEO OUTPUT into AUX INPUT VIDEO jack on TV.

**Operation:** To use these VCR connections, you must watch the AUX channel on the TV. To select the AUX channel, press CHANNEL (CH) Up/Down until you select the next channel after the highest/lowest channel, or enter the number 999 from the remote control, or press SOURCE on the remote control if available. For improved picture quality, place VCR/TV switch on your VCR in the VCR position.

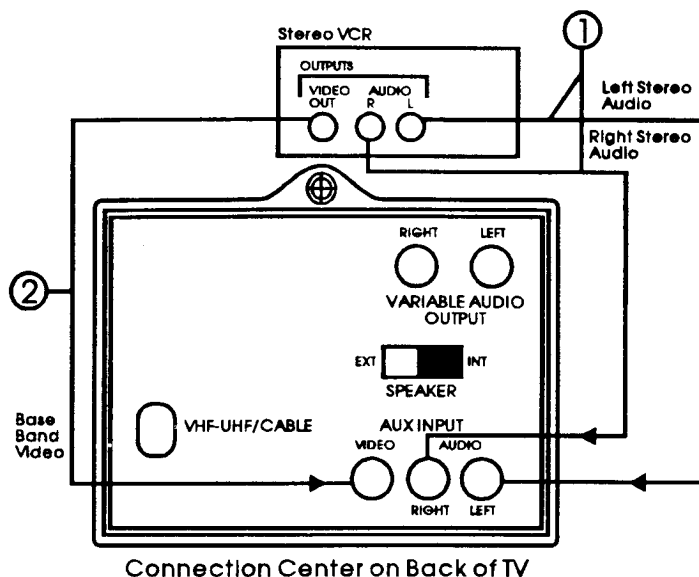

### MONAURAL VCR

**Connections:**

1. To get monaural sound from both TV speakers, use a Y-adaptor audio cable (customer supplied) to route VCR AUDIO OUT to the AUX INPUT AUDIO RIGHT and LEFT jacks on TV.
2. Connect VCR VIDEO OUTPUT into AUX INPUT VIDEO jack on TV.

**Operation:** To use these VCR connections, you must watch the AUX channel on the TV. To select the AUX channel, press CHANNEL (CH) Up/Down until you select the next channel after the highest/lowest channel, or enter the number 999 from the remote control, or press SOURCE on the remote control if available. For improved picture quality, place VCR/TV switch on your VCR in the VCR position.

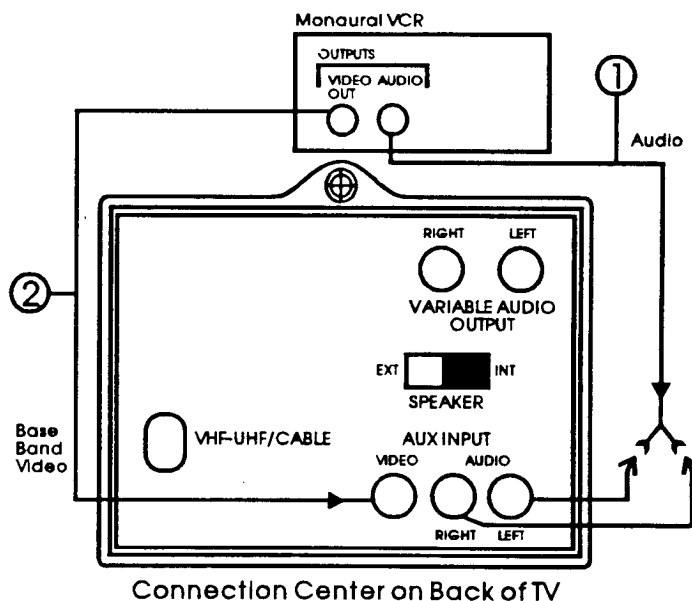



# CONNECTIONS FOR YOUR TV

## STEP 3. MAKE STEREO AUDIO CONNECTION TO AUDIO AMPLIFIER

Using an External Amplifier with Speakers While the TV's Speakers are OFF.

1. Make the connections to the external amplifier as shown in the diagram below.
2. Place the SPEAKER EXT/INT switch on the TV in the INT position (TV's speakers are ON).
3. Turn the TV ON. Increase the volume level of the TV until the sound just starts to distort (sound bad).
4. Place the SPEAKER EXT/INT switch on the TV in the EXT position (TV's speakers are OFF).
5. Turn the external audio amplifier ON. Adjust the volume level of the audio amplifier for the highest level you will need for your listening pleasure.
6. Adjust the volume level of the TV for the normal listening level as heard through the speakers of your audio amplifier.
7. You can now use the VOLUME (VOL) control on the TV or on the remote control to adjust the volume of the speakers of your audio amplifier.

Using an External Amplifier with Speakers While the TV's Speakers are ON.

1. Make the connections to the external amplifier as shown in the diagram below.
2. Place the SPEAKER EXT/INT switch on the TV in the INT position (TV's speakers are ON).
3. Turn the TV ON. Increase the volume level of the TV until the sound just starts to distort (sound bad).
4. Turn the external audio amplifier ON. Adjust the volume level of the audio amplifier for the highest level you will need for your listening pleasure.
5. Adjust the volume level of the TV for the normal listening level as heard through the speakers of the TV.
6. You can now use the VOLUME (VOL) control on the TV or on the remote control to adjust the volume of both the TV's speakers and the audio amplifier's speakers.

**NOTE:** If the volume of the internal TV speakers is set too low, you may hear undesirable noises through the speakers connected to your audio amplifier.

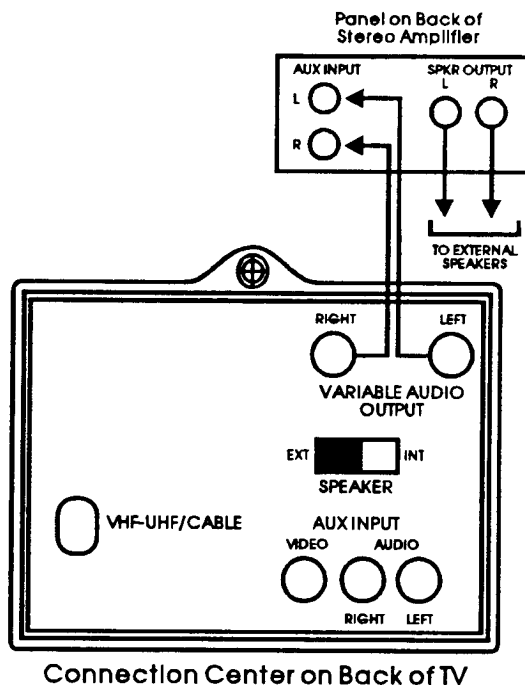

# THE FIRST TIME YOU OPERATE YOUR TV

## STEP 1. CONNECT THE POWER

Plug your TV into an unswitched AC power source.

The switched AC outlets found on some video equipment will not continue supplying power to the TV once the equipment is turned off. If the power to the TV is interrupted, you will have to set the clock in the TV to the current time.

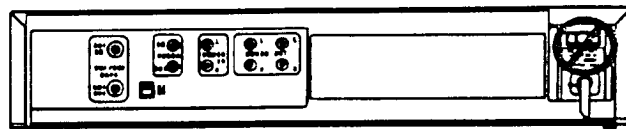

Do not plug TV into switched outlet on cable-TV decoder

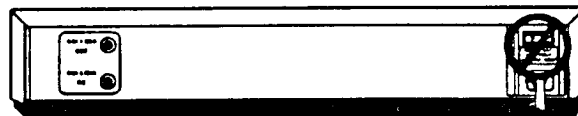

Do not plug TV into switched outlet on a VCR

## STEP 2. TURN TV ON

Turn the TV on by pressing OFF-ON.

## STEP 3. USE AUTO CH. (Channel) SEARCH

When your TV is first powered up you will see the AUTO CH. SEARCH reminder display. AUTO CH. SEARCH finds all available channels and stores them in memory for access by CHANNEL (CH) Up/Down. To activate AUTO CH. SEARCH, press ADJUST (ADJ) Left/Right. When the search is complete, you can watch the TV program of your choice.

### NOTES:

1. The AUTO CH. SEARCH reminder display appears each time you turn on your TV until it has been used at least once.
2. Antenna or cable must be connected to TV **before** you use AUTO CH. SEARCH.

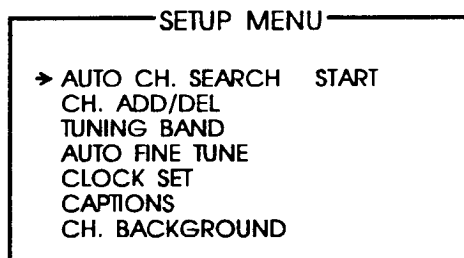

Auto Ch. Search Reminder Display

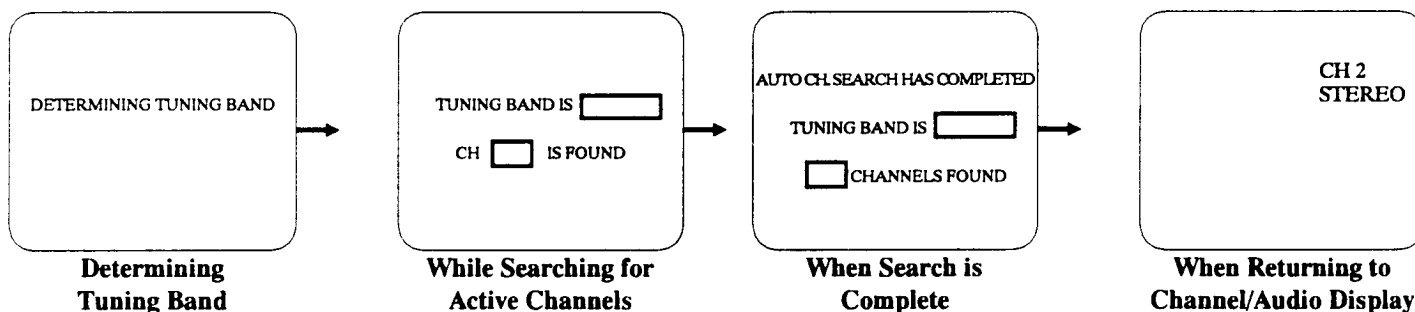

## STEP 4. USE OTHER OPTIONS

You may want to consider using the following options:

- Program the channels accessed by using CHANNEL (CH) Up/Down. Refer to CH. ADD/DEL option of the "Setup Menu" section of this operating guide for details.
- Set the clock in the TV. Refer to the CLOCK SET option of the "Setup Menu" section of this operating guide for details.

# GETTING TO KNOW YOUR TV

## HORIZONTAL CONTROL PANELS

The following description applies to models having a horizontal control panel.

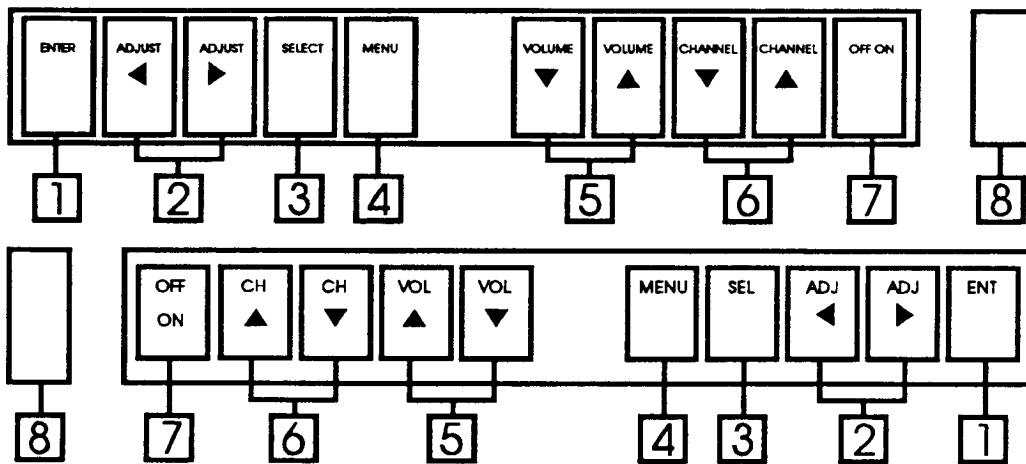
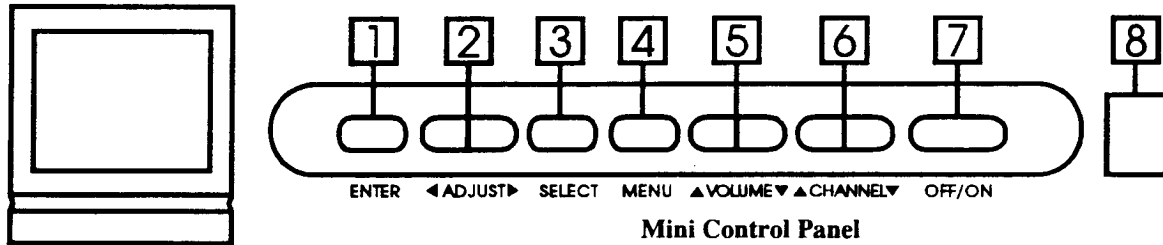

Full Size Control Panels

### Front Panel Controls

#### 1. ENTER (ENT)

Press to see the Channel/Time display, or to remove any on-screen display or menu.

#### 2. ADJUST (ADJ) Left/Right or ◀/▶

Press during on-screen menu operation to see information/status display for selected option. Press again to adjust the selected menu option.

#### 3. SELECT (SEL)

Press during on-screen menu operations to select a menu option.

#### 4. MENU

Press once to see a menu. Press repeatedly to sequence through the available menus.

#### 5. VOLUME (VOL) Up/Down

Press to increase or decrease the sound level.

#### 6. CHANNEL (CH) Up/Down

Press to select channels higher or lower than the channels being viewed. You can add channels to or delete channels from the scanning sequence stored in memory. See CH. ADD/DEL option of the "Setup Menu" section of this operating guide for channel programming information.

#### 7. OFF-ON

Press to turn TV power ON or OFF.

#### 8. Remote Control Detector Window

Point the remote control towards this window to operate the TV.

# GETTING TO KNOW YOUR TV

## VERTICAL CONTROL PANEL

The following description applies to models having a vertical control panel.

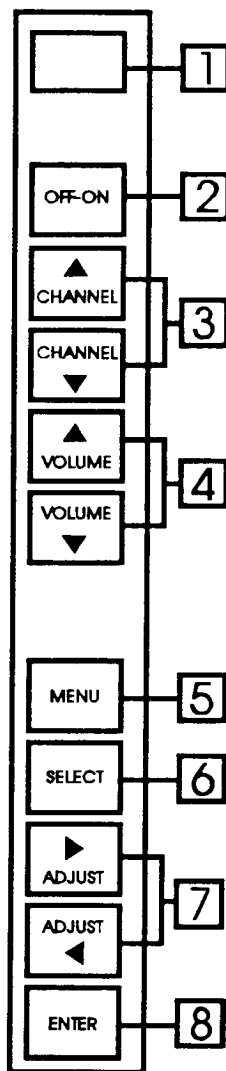
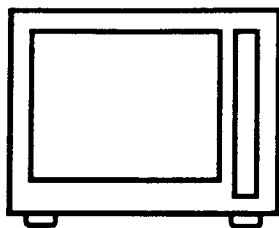

Full Size Control Panel

### Front Panel Controls

#### 1. Remote Control Detector Window

Point the remote control towards this window to operate the TV.

#### 2. OFF-ON

Press to turn TV power ON or OFF.

#### 3. CHANNEL Up/Down

Press to select channels higher or lower than the channels being viewed. You can add channels to or delete channels from the scanning sequence stored in memory. See CH. ADD/DEL option of the "Setup Menu" section of this operating guide for channel programming information.

#### 4. VOLUME Up/Down

Press to increase or decrease the sound level.

#### 5. MENU

Press once again to see a menu. Press repeatedly to sequence through the available menus.

#### 6. SELECT

Press during on-screen menu operations to select a menu option.

#### 7. ADJUST Left/Right

Press during on-screen menu operations to see information/status display for selected option. Press again to adjust the selected menu option.

#### 8. ENTER

Press to see the Channel/Time display, or to remove any on-screen display.

# REMOTE CONTROL MODEL SC3390

## OPERATION

This remote control provides access to all on-screen menus, as well as, access to special features that can not be accessed by using the control panel on the TV.



For optimum performance, point the remote control toward your Zenith TV.

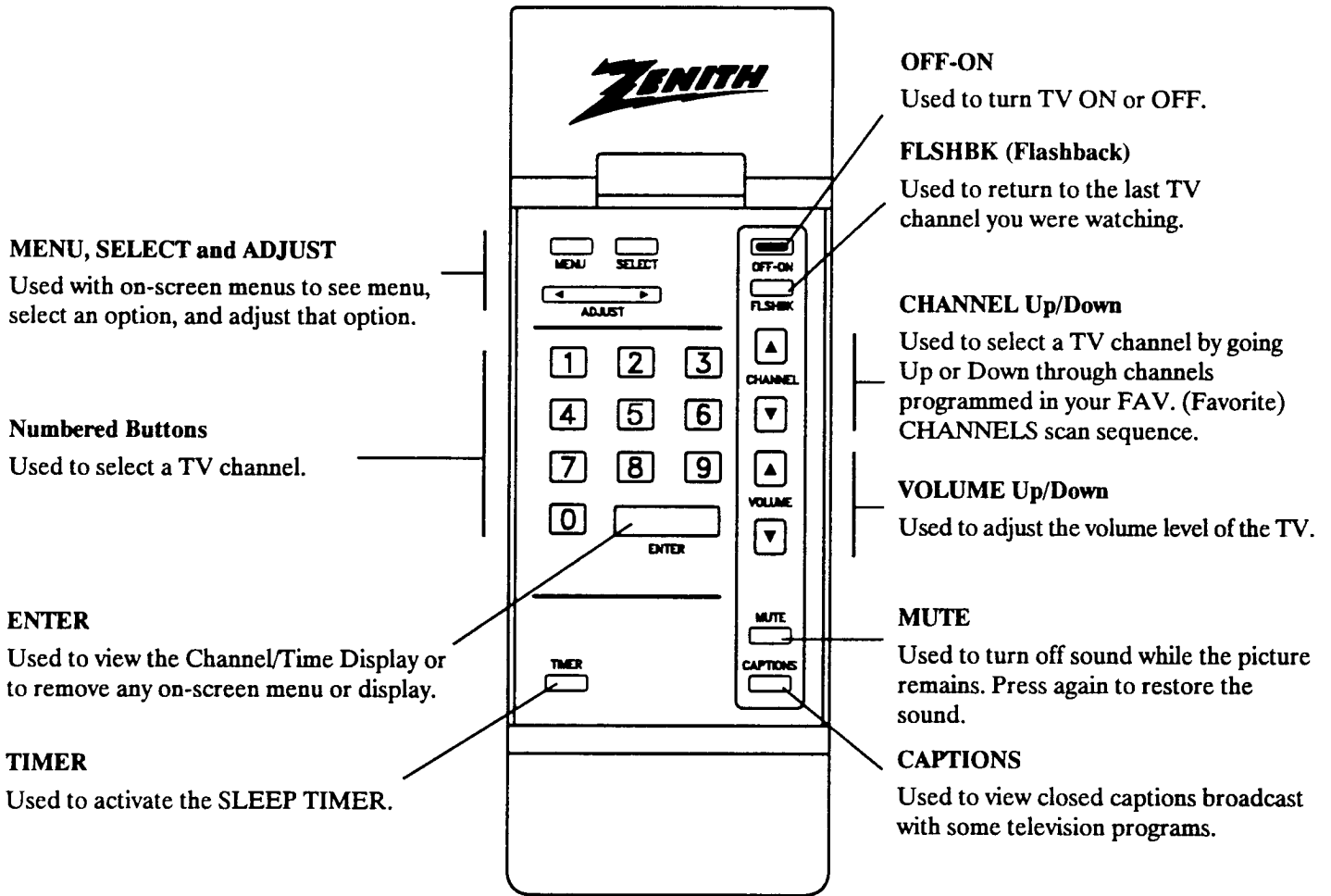

SC3390

---

# REMOTE CONTROL MODEL SC3390

---

## PREPARATION FOR USE

Batteries are provided with this remote, but you must install them before using the remote.

---

## INSTALLING BATTERIES

When the effective operating range of your remote becomes noticeably shorter, replace the batteries with two (2) high quality, alkaline, size AAA batteries.

1. Remove the battery compartment cover, PUSH DOWN tab and PULL OUT from top.
2. Insert new batteries as indicated in the diagram inside the compartment.
3. Replace the cover by inserting the tab on the bottom of the cover into its housing. Snap the cover into position.

### NOTES:

- Be careful not to place heavy objects on top of the remote control buttons. Prolonged accidental operation of the remote control will shorten battery life.
- If you do not use the remote control for a month or more, remove the batteries. Battery leakage can cause damage to the remote control.
- Zenith is not responsible for damage caused by such battery leakage.

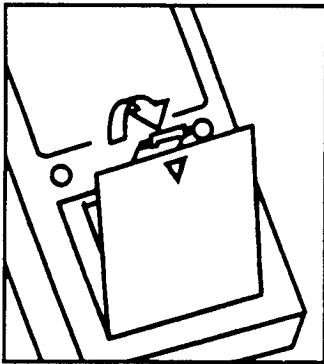

1.

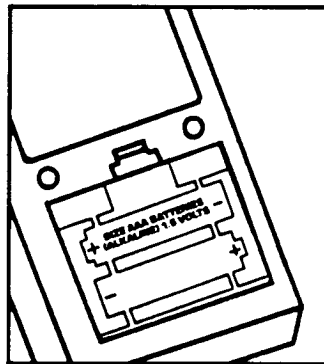

2.

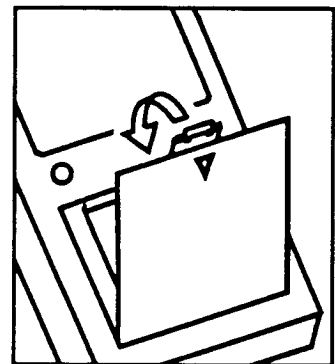

3.

# REMOTE CONTROL MODEL SC3820

## TV OPERATIONS

The following functions and operations apply to Zenith TV models built after 1981.

The remote control must be in the TV mode to operate your TV. Press MODE to select the TV mode. The TV indicator lights when you are in the TV mode.



For optimum performance, point the remote control toward your TV.

### TV Mode Indicator Light

Lights when remote is in TV mode of operation.

### MENU, SELECT and ADJUST

Used with the on-screen menus of the TV.

### CC (Closed Captions)

Used to access closed captions via on-screen information displays.

### Numbered Buttons

Used to select a TV channel.

### ENTER

Used to view the Channel/Time Display or to remove any on-screen menu or display.

### MODE

Press to select TV mode of operation.

### OFF-ON

Used to turn TV ON or OFF.

### SOURCE

Press to display the menu of TV sources for TVs having a SOURCE Menu. Press SOURCE again to step through the source selections. On some TVs, press SOURCE to select the AUX (Auxiliary) channel.

### FLASHBK (Flashback)

Used to return to the last TV channel you were watching.

### CHANNEL Up/Down

Used to select a TV channel by going Up or Down through channels programmed in your Fav. (Favorite) Channels scan sequence.

### VOLUME Up/Down

Used to adjust the volume level of the TV.

### MUTE

Used to turn off sound while the picture remains. Press again to restore the sound.

### TIMER

Used to activate the SLEEP TIMER.

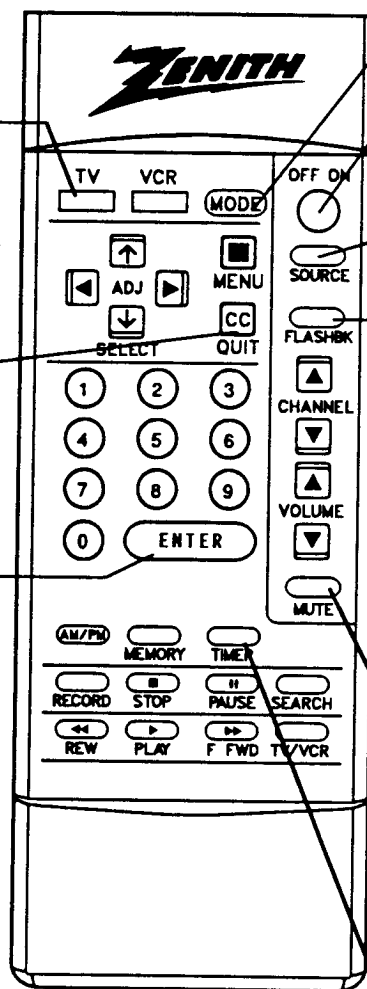

SC3820

# REMOTE CONTROL MODEL SC3820

## VCR OPERATIONS

The following functions and operations apply to Zenith VCR models built after 1991.

For complete details on how to operate your Zenith VCR, refer to the operating guide supplied with it.

The remote control must be in the VCR mode to operate your VCR. Press MODE to select the VCR mode. The VCR indicator lights when you are in the VCR mode.



For optimum performance, point the remote control toward your VCR.

### VCR Mode Indicator Light

Lights when remote is in VCR mode of operation.

### MENU, SELECT, ADJUST and QUIT

Used with the on-screen menus and programming options of the VCR.

### Numbered Buttons

Used to select a TV channel through the VCR. Also, used to set the timer in the VCR, and to enter programming information.

### ENTER

Used with the numbered buttons to select a TV channel through the VCR.

### AM/PM

Used to set timer during programming.

### MEMORY

Used to activate the COUNTER MEMORY feature.

### RECORD, STOP, PAUSE, REW, PLAY and F FWD

Used for tape recording and playback functions.

### MODE

Press to select VCR mode of operation.

### OFF-ON

Used to turn VCR ON or OFF.

### FLASHBK (Flashback)

Press during VCR playback to view the channel tuned by the VCR.

### CHANNEL Up/Down

Used to select a TV channel by going Up or Down through channels from your VCR.

### SEARCH

Press to operate the VCR SEARCH feature which allows you to rewind or fast forward to an indexed segment of tape.

### TV/VCR

Used to select the source of the programs seen on the TV. Switches the VCR between TV mode and VCR mode. TV Mode: channels are selected through the TV. VCR Mode: channels or tape operations are selected through the VCR.

### TIMER

Used to activate the SLEEP TIMER.

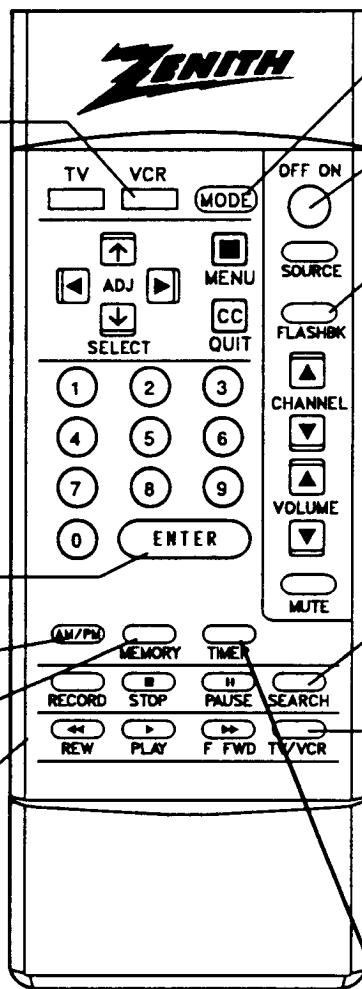

SC3820



# REMOTE CONTROL MODEL SC3820

## TV AND VCR OPERATIONAL NOTES

Some controls on the remote, like PLAY and VOLUME will always operate the VCR or the TV. Whether other keys operate the TV or the VCR depends on the mode of the remote control. For example, OFF-ON will turn the VCR ON and OFF while the remote control is in the VCR mode. It will turn the TV ON or OFF while the remote control is in the TV mode.

Some of the functions provided by this remote control may not be part of your TV and/or VCR. You will not be able to activate those functions even though there is a control button on the remote. For example, pressing TIMER provides direct access to the Sleep Timer on many TVs. If your TV does not have a Sleep Timer, pressing TIMER has no effect.

## PREPARATION FOR USE

Batteries are provided with this remote, but you must install them before using the remote.

## INSTALLING BATTERIES

When the effective operating range of your remote becomes noticeably shorter, replace the batteries with two (2) high quality, alkaline, size AAA batteries.

1. Remove the battery compartment cover, PUSH DOWN tab and PULL OUT from top.
2. Insert new batteries as indicated in the diagram inside the compartment.
3. Replace the cover by inserting the tab on the bottom of the cover into its housing. Snap the cover into position.

### NOTES:

- Be careful not to place heavy objects on top of the remote control buttons. Prolonged accidental operation of the remote control will shorten battery life.
- If you do not use the remote control for a month or more, remove the batteries. Battery leakage can cause damage to the remote control.
- Zenith is not responsible for damage caused by such battery leakage.

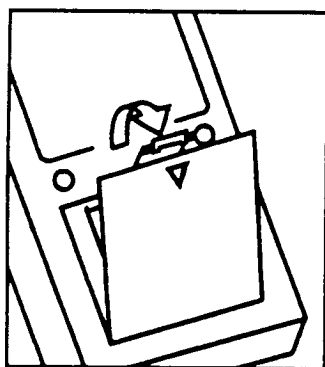

1.

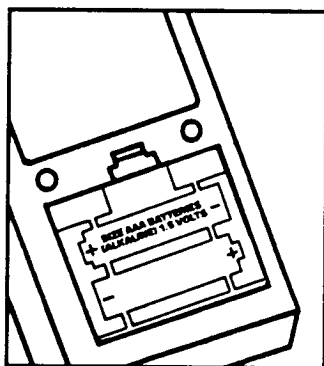

2.

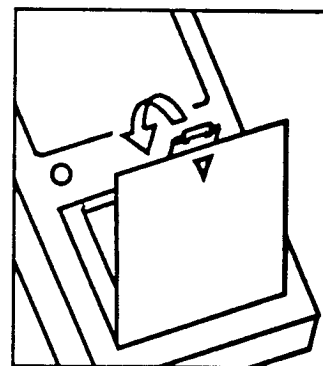

3.

# OPERATING YOUR TV

## BASIC TV OPERATIONS

**Selecting Channels by Using CHANNEL (CH) Up/Down:** You may select a channel through channel scanning by using CHANNEL (CH) Up/Down. Only channels stored in the channel scan sequence can be selected.

**Selecting Channels by Using Numbers on Remote:** Press the numbers corresponding to the channel desired, then press ENTER (ENT). Any channel in the band chosen can be selected through direct number entry.

**FLSHBK or FLASHBK (Flashback) on Remote:** Press FLSHBK or FLASHBK to return to the last TV channel you were watching.

**Adjusting Volume:** You can adjust the volume of your TV by using VOLUME (VOL) Up/Down.

**Muting Volume:** To mute the sound coming from your TV, press MUTE on the remote control. To restore sound, press MUTE again.

**Selecting AUX Channel on TV:** Press CHANNEL (CH) Up/Down until you select the next channel after the highest/lowest channel programmed in your TV, or enter the number 999 from the remote control, or press SOURCE on the remote control if available. You will see program material provided by your VCR, camcorder, or other video equipment connected to the AUX INPUT VIDEO and AUX INPUT AUDIO RIGHT and LEFT jacks on the TV. For best picture performance using the AUX channel the TV/Video (VCR) switch on your VCR should be set to the Video (VCR) position. Use the AUX channel for viewing video tapes.

**After an Extended Power Outage:** If you previously used AUTO CH. SEARCH, you do not have to use it again unless you permanently changed the connections to the TV. All of the channels previously found are stored in protected memory, and are not affected by a power outage. However, the clock must be reset to the current time.

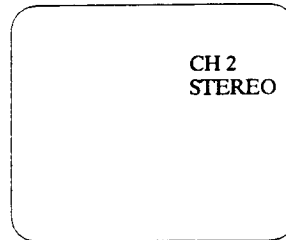

Channel/Audio Display  
(Before Clock is Set)

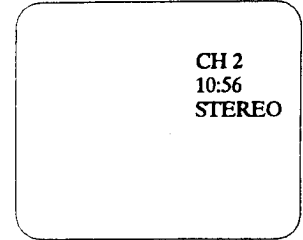

Channel/Time/  
Audio Display  
(After Clock is Set)

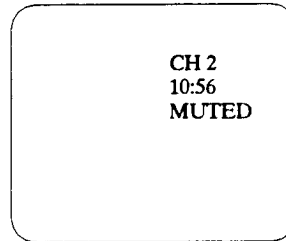

Channel/Time Display  
While TV is Muted

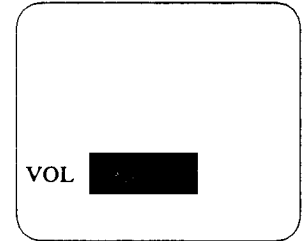

Volume Display \*

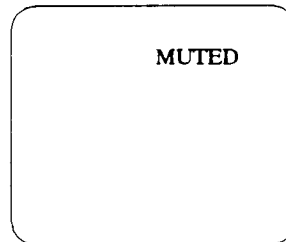

Mute Display \*

\* VOL or MUTED display is shown only when captions are not being displayed.

## SLEEP TIMER

Some remote controls are equipped with a TIMER button that provides access to the SLEEP TIMER available with some TV models. By using the SLEEP TIMER, you can program the TV to automatically shut off after a 15 minute period up to 4 hours.

### To Set SLEEP TIMER

1. Press TIMER to see status display.
2. Press TIMER repeatedly until you reach desired shut-off time.

One minute before the TV shuts off, the GOOD NIGHT display appears on the screen. At this time you have a choice of the following three actions.

1. Do nothing. The TV will shut off in one minute. The display will count off the remaining seconds.
2. Remove the GOOD NIGHT display by pressing ENTER (ENT). The TV will still shut off in one minute.

3. Delay the shut off by using TIMER to select a new shut off time.

### To Cancel the SLEEP TIMER

You can cancel the SLEEP TIMER by setting the SLEEP TIMER status to OFF. Press TIMER repeatedly until the status shows OFF.

**NOTE:** The SLEEP TIMER resets to OFF when you turn off the TV.

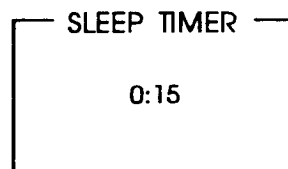

Sleep Timer Display

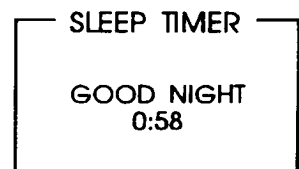

"Good Night" Display

# ON-SCREEN MENUS

## AVAILABLE MENUS

Your TV is menu operated, that is, adjustments that can be made to the TV appear on the screen in a list of choices you can make by using the controls on the front panel of the TV or on the remote control.

There are three menus: SETUP, AUDIO and VIDEO. These menus list everything you can adjust to your personal preference or needs.

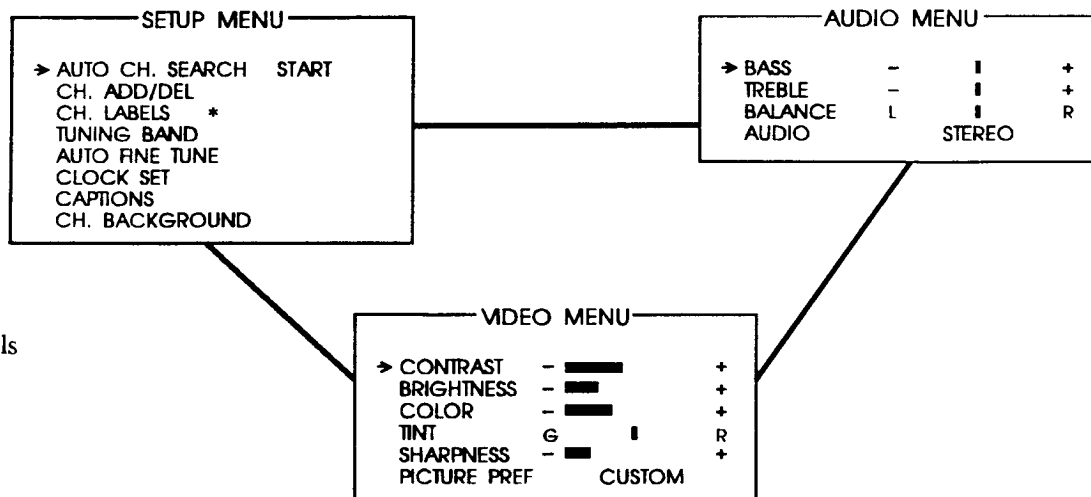

\* Some models

## SUMMARY OF MENU ITEMS

### SETUP Menu

**AUTO CH. SEARCH:** Finds all available channels and stores them in memory for access by using CHANNEL (CH) Up/Down.

**CH. ADD/DEL:** Changes the list of active channels selected by using CHANNEL (CH) Up/Down.

**CH. LABELS (Some models):** Adds a channel name "LABEL" to the Channel/Time display. For example, ABC may appear when this network channel is tuned.

**TUNING BAND:** Determines the operation of the channel tuner inside the TV.

**AUTO FINE TUNE:** Lets your TV compensate for variations in broadcast and cable TV frequencies.

**CLOCK SET:** Sets the clock in your TV to the correct time.

**CAPTIONS:** Displays closed captions (CC) or informational text when available.

**CH. BACKGROUND:** Changes the background of the Channel/Time display.

### AUDIO Menu

**BASS:** Adjusts the BASS (low frequency) level.

**TREBLE:** Adjusts the TREBLE (high frequency) level.

**BALANCE:** Adjusts the balance of sound between the left and right speakers for stereo programs.

**AUDIO:** Allows you to select STEREO, MONO or 2ND AUDIO/SAP speaker operation. 2ND AUDIO/SAP allows for receiving programs which are broadcast with two audio portions (such as two languages).

### VIDEO Menu

**CONTRAST:** Adjusts the overall contrast and color level of the picture.

**BRIGHTNESS:** Adjusts the brightness level of black areas in the picture.

**COLOR:** Adjusts the intensity of the colors in the picture.

**TINT:** Adjusts the color of the flesh tones.

**SHARPNESS:** Adjusts the clarity for the clearest picture.

**PICTURE PREF:** Lets you decide if you want to use your own CUSTOM video settings, or the factory PRESET video settings.

# ON-SCREEN MENUS

## BASIC MENU OPERATIONS

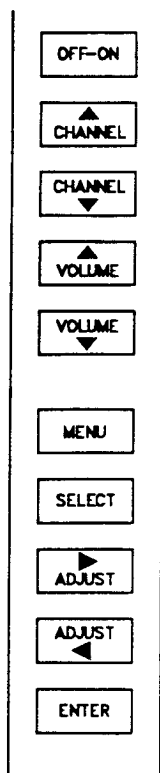

Vertical Control Panel Shown  
(Menu buttons are provided  
on some remote controls.)

### 1. To See a Menu or Change Menus

Press MENU repeatedly until the desired menu is shown. Example shows choosing the SETUP Menu.

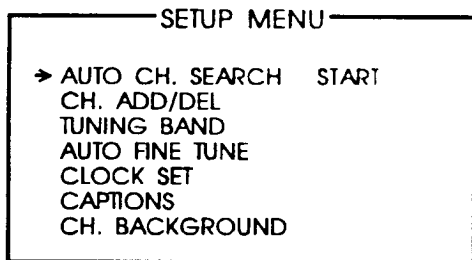

Choosing Setup Menu

### 2. To Select an Option/Feature on a Menu

Press SELECT (SEL) repeatedly until the desired option/feature is highlighted. The following example shows selecting TUNING BAND.

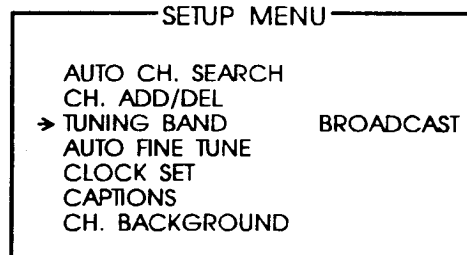

Selecting Tuning Band

### 3. To Adjust an Option/Feature

Press ADJUST (ADJ) Left/Right to see and choose the available selections.

**NOTE:** Do not change channels during menu operations unless instructed to do so in the procedures given in this operating guide.

### 4. To Access a Different Main Menu

Press MENU repeatedly until the desired menu is shown.

### 5. To Return to Normal Viewing

Press ENTER (ENT) or wait a few seconds and the TV will return automatically to normal operation.

**Service Menus:** In addition to the menus shown above, there are menus for factory and field servicing. Service menus are not intended for use by the owner.

If you inadvertently access a service menu, press ENTER (ENT) to return immediately to normal TV viewing.

# SETUP MENU

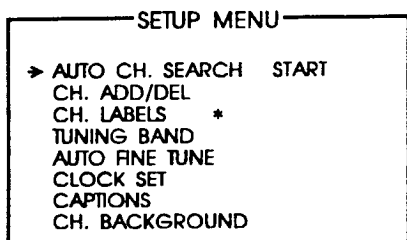

SETUP Menu

\* Some models

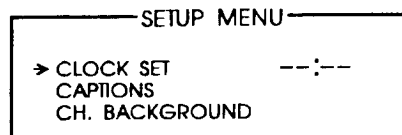

SETUP Menu While AUX Channel is Being Used  
(To get SETUP Menu on left, select a regular channel)

## AUTO CH. (Channel) SEARCH

### Purpose

Finds all available channels and stores them in memory for access by CHANNEL (CH) Up/Down.

Use AUTO CH. SEARCH only when you first install your TV, or when you permanently change the connections to the TV. For example, when you replace the antenna with a cable-TV system.

Programmed channels are stored in protected memory, and are not affected by a power outage.

### Before Using AUTO CH. SEARCH

Connect and turn ON all external equipment, such as cable TV decoder, VCR, etc.

**NOTE:** AUTO CH. SEARCH is not displayed while AUX channel is being used.

### To Use AUTO SEARCH

1. AUTO CH. SEARCH should be selected if you followed the "Basic Menu Operation" given in the "On-Screen Menus" section.
2. Press ADJUST (ADJ) Left/Right to start the AUTO CH. SEARCH, the status of the search is shown in the display. When the search is complete, you can watch the TV program of your choice.

### When Some Channels Are Not Found

AUTO CH. SEARCH finds only active channels and stores them in the favorite channel memory. You can add channels to those stored in memory by using the CH. ADD/DEL option.

If you have difficulty tuning some channels, you may have to manually change the TUNING BAND and AUTO FINE TUNE. Refer to respective option for details.

### When Only AUX Channel Is Found

You may have used AUTO CH. SEARCH without having a signal source (antenna, cable-TV, etc...) connected to the TV. In which case, no channels are stored in the favorite channel memory, and the TV operates only on the AUX channel.

To resolve this condition, connect a signal source, turn signal source ON, if needed, and use AUTO CH. SEARCH again.

**NOTE:** AUX (Auxiliary) channel is operational only on TVs having separate video and audio inputs for VCR operations.

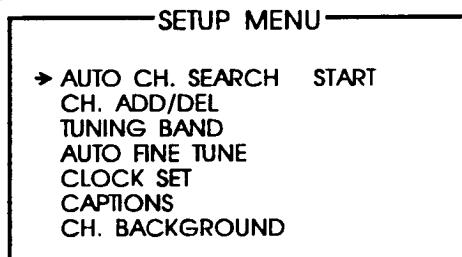

Selecting Auto Ch. Search

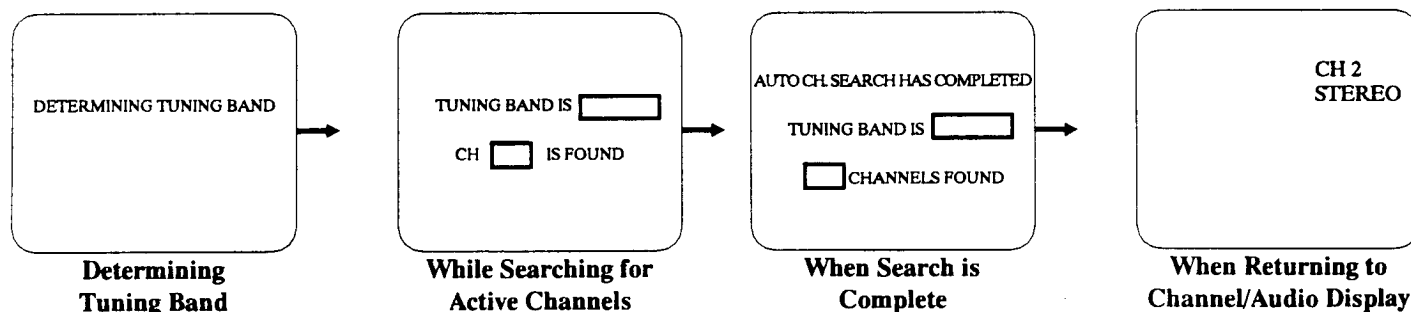

# SETUP MENU

## CH. (Channel) ADD/DEL

### Purpose

Lets you add channels to and remove channels from the active channels found when using the AUTO CH. SEARCH option. In this way you can customize the channels that are accessed through CHANNEL (CH) Up/Down.

CH. ADD/DEL is an optional feature. You do not have to activate this feature in order to use your TV.

### Before Using CH. ADD/DEL

Use the AUTO CH. SEARCH feature, if not previously used when you first installed the TV. **NOTE:** CH. ADD/DEL is not displayed while AUX channel is being used.

### To Add a Channel to Scan Sequence

1. CH. ADD/DEL should be selected if you followed the "Basic Menu Operation" given in the "On-Screen Menus" section.

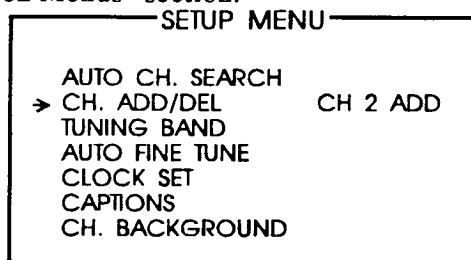

Selecting Ch. Add/Del

2. Using CHANNEL (CH) Up/Down go to the channel you wish to add. **NOTE:** AUX channel will not appear while using CH. ADD/DEL.
3. Use numbered buttons to access channels not presently stored in the favorite channel scan sequence.
4. Add channel by pressing ADJUST (ADJ) Left/Right until the display shows ADD.
5. Press ENTER (ENT) to return to normal TV viewing.

### To Delete a Channel from Scan Sequence

1. CH. ADD/DEL display should be shown on the TV if you followed the "Basic Menu Operation" given in the "On-Screen Menus" section.
2. Using CHANNEL (CH) Up/Down go to the channel you wish to remove. **NOTE:** AUX channel cannot be removed.
3. Remove channel by pressing ADJUST (ADJ) Left/Right until the display shows DEL.
4. Press ENTER (ENT) to return to normal TV viewing.

### When Some Channels Can Not Be Tuned

If you have some difficulty tuning some channels, you may have to manually set the TUNING BAND option. If you have the correct band, but are still having difficulty finding a channel you know to be active, set the AUTO FINE TUNE to SEARCH.

## CH. (Channel) LABELS (Some Models)

### Purpose

This option allows you to show a channel "name" each time the channel display appears on the TV. In other words, if you choose the label "ABC" for channel 13, "ABC" appears in the Channel/Time display. Therefore, you always know what channel you are watching.

The labels shown in the following table may be "assigned" to channels.

### NOTES:

- CH. LABELS is not displayed while AUX channel is being used.
- These labels are in the memory of the TV. You can not make your own labels.
- To remove an assigned channel label, select the one that is "blank".

A&E	ABC	ACTS	ADC	AMC	BET
BRAV	CA	CBC	CBN	CBS	CMTV
CNBC	CNN	COM	CSPN	CTN	CTV
DIS	DISC	E!	ENC	ESPN	ET
EWTN	FAM	FNN	FOX	GALA	HBO
HN	HSE	HSN	IC	INSP	LIFE
MAX	MEU	MMT	MTV	NBC	NICK
NOS	PBS	PLAY	PTL	QVC	REQ
SC	SHOW	SIN	TBS	TBN	TLC
TMC	TNN	TNT	TRAV	TSN	TWN
USA	VC	VCR	VH1	VISN	VJN
WGN	WTBS	WWOR	YTV		

### To Use CH. LABELS

1. CH. LABELS should be selected if you followed the "Basic Menu Operation" given in the "On-Screen Menu" section.
2. Using the number buttons or CHANNEL Up/Down, select a channel.
3. Press ADJUST (ADJ) Left/Right to sequence through the available choices until the desired label appears.
4. Press ENTER to return to normal TV viewing.

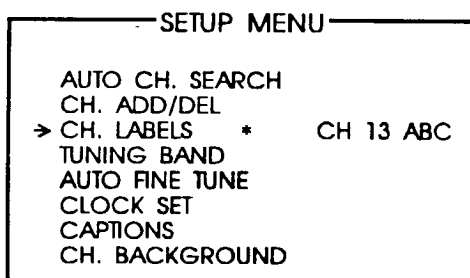

Selecting Ch. Labels

\* Some models

# SETUP MENU

## TUNING BAND

### Purpose

Allows for setting the TV tuner to match your antenna or cable-TV system.

If you are having difficulty tuning channels, the TUNING BAND may have to be set manually to match your viewing needs.

### Before Using TUNING BAND

Connect and turn ON all external equipment, such as cable-TV decoder, VCR, etc. Use AUTO CH. SEARCH if not previously used.

**NOTE:** TUNING BAND is not displayed while AUX channel is being used.

### To Use TUNING BAND

1. TUNING BAND should be selected if you followed the "Basic Menu Operation" given in the "On-Screen Menus" section.

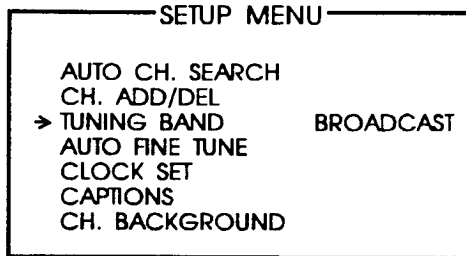

Selecting Tuning Band

2. Press ADJUST (ADJ) Left/Right to select the desired tuning band, as follows:

- BROADCAST is used for standard "over-the-air" broadcasts.
- Cable – CATV is used for most standard cable-TV (CATV) systems.
- Cable – HRC is used for cable-TV systems that use HRC (Harmonically Related Carrier).
- Cable – ICC is used for cable-TV systems using ICC (Incremental Coherent Carrier).

### Available Channels per Band

The channels that are available in the broadcast and cable tuning bands are shown below:

#### BROADCAST Band

VHF 2 to 13                      UHF 14 to 69\*

\* Channels above 69 are not selectable.

#### CATV, HRC and ICC Bands

1 to 125\*\*

\*\* Channels above 125 may not be selectable.

### When Some Channels Are Not Clear

If some channels are not clear, change the AUTO FINE TUNE. You may have to try different TUNING BAND and AUTO FINE TUNE settings until you get a clear picture, channel-to-channel. Refer to the AUTO FINE TUNE option for details.

## AUTO FINE TUNE

### Purpose

Lets your TV compensate for variations in broadcast and cable-TV frequencies.

If you are having difficulty tuning channels, the AUTO FINE TUNE may have to be set manually to match your viewing needs.

### Before Using AUTO FINE TUNE

Connect and turn ON all external equipment, such as cable-TV decoder, VCR, etc.

**NOTE:** AUTO FINE TUNE is not displayed while AUX channel is being used.

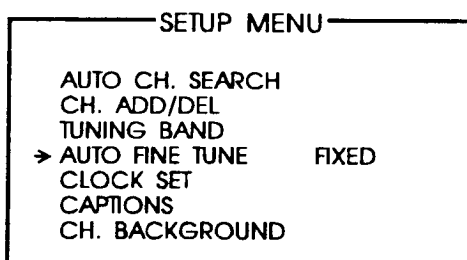

Selecting Auto Fine Tune

### To Use AUTO FINE TUNE

1. AUTO FINE TUNE should be selected if you followed the "Basic Menu Operation" given in the "On-Screen Menus" section.
2. Press ADJUST (ADJ) Left/Right to select the desired mode of operation, as follows:
  - FIXED is used to receive "over-the-air" TV stations, and with many cable TV systems.
  - SEARCH is used only when the TV must search to find the frequency being received, such as when used with certain VCRs and video game controllers.

### When Some Channels Are Not Clear

If some channels are not clear, change the TUNING BAND. You may have to try different AUTO FINE TUNE and TUNING BAND settings until you get a consistently clear picture, channel-to-channel. Refer to the TUNING BAND option for details.

---

# SETUP MENU

---

## CLOCK SET

### Purpose

Sets the clock in the TV to the correct time.

After the time has been set, the current time will appear on the Channel/Time display whenever the TV is turned on, the channel is changed, or ENTER (ENT) is pressed.

**Power Failure Note:** The time will have to be reset if power to the TV is interrupted.

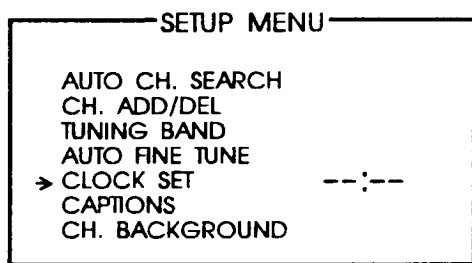

Selecting Clock Set

### To Use CLOCK SET from Remote Control

1. CLOCK SET should be selected if you followed the "Basic Menu Operation" given in the "On-Screen Menus" section.
2. Use the numbered buttons on the remote control to enter the current time. Press ENTER (ENT) to start the clock.

For example, to set the clock to 12:30, press 1, then 2, then 3, then 0; and then press ENTER (ENT). If you enter an invalid time, such as 14:35 or 2:80, the time will disappear and you can enter another time.

### To Use CLOCK SET from Control Panel

1. CLOCK SET display should be shown on the TV if you followed the "Basic Menu Operation" given in the "On-Screen Menus" section.
2. Use ADJUST (ADJ) Left/Right to set the time, and then press ENTER (ENT) to start the clock.

---

## CAPTIONS

### Purpose

Displays closed captions (CC) or informational text when available on the selected channel.

### To Access CAPTIONS Indirectly (All Models)

1. CAPTIONS should be selected if you followed the "Basic Menu Operation" given in the "On-Screen Menus" section.
2. One of five different selections is shown: OFF, CAPTION 1, CAPTION 2, TEXT 1 and TEXT 2.
3. Press ADJUST (ADJ) Left/Right to select desired mode of operation.
4. The display disappears from the screen automatically in about 10 seconds, or you may press ENTER (ENT) to remove the display immediately.

### To Access CAPTIONS Directly (Select Models)

1. Press CAPTIONS or CC/QUIT on the remote control to select CAPTIONS. One of five different selections is shown: OFF, CAPTION 1, CAPTION 2, TEXT 1 and TEXT 2.
2. Press ADJUST (ADJ) Left/Right to select desired mode of operation.
3. The display disappears from the screen automatically in about 10 seconds, or you may press ENTER (ENT) to remove the display immediately.

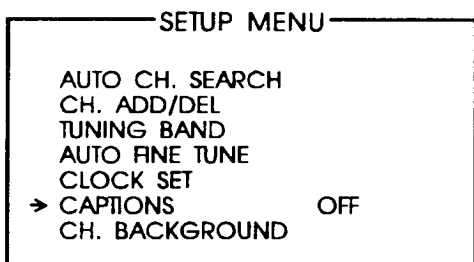

Selecting Setup Menu  
and Captions Option





---

# AUDIO MENU

---

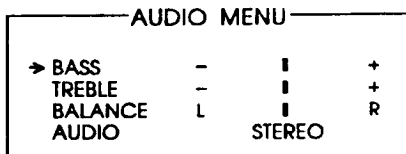

AUDIO Menu

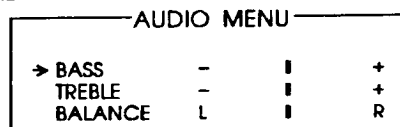

AUDIO Menu while using AUX channel. (To get the AUDIO Menu on the left select a regular channel.)

---

## GENERAL INFORMATION

Your TV is equipped to receive Multi-channel Television Sound (MTS) when available in your area. It can also receive a Second Audio Program (SAP), that is, a program broadcast with two audio portions (two languages). The following modes of operation are available. **NOTE:** All adjustments on the AUDIO Menu are optional. You do not have to use these features in order to use your TV.

### STEREO

Directs the sound to the left and right speakers as supplied by the program source (broadcast TV station, VCR, etc.)

### MONO (Monaural)

Directs the same sound to both left and right speakers even if the source being received is in stereo.

### 2ND AUDIO/SAP (Second Audio Program or SAP)

Directs the sound for the (SAP) Second Audio Program (typically a second language) to both the left and right speakers. SAP sound is always monaural.

### Automatic Mode Selection

We recommend that you use the STEREO option. The TV will switch automatically between the STEREO and MONO modes dependent on the signal being received.

If you prefer SAP, use the 2ND AUDIO/SAP option. On those stations which broadcast two audio portions, you will hear the SAP (usually a second language). When the SAP broadcast ends, the TV switches automatically between STEREO and MONO modes. The TV switches back to 2ND AUDIO/SAP when the SAP broadcast resumes.

**NOTE:** The AUDIO mode selection option is not available while the AUX channel is being used.

---

## BASS

Use ADJUST (ADJ) Left/Right to adjust the amount of BASS (low-frequency level) in the sound. To decrease (-) BASS, press ADJUST (ADJ) Left. To increase (+) BASS, press ADJUST (ADJ) Right.

## TREBLE

Use ADJUST (ADJ) Left/Right to adjust the amount of TREBLE (high-frequency level) in the sound. To decrease (-) TREBLE, press ADJUST (ADJ) Left. To increase (+) TREBLE, press ADJUST (ADJ) Right.

## BALANCE

Use ADJUST (ADJ) Left/Right to shift the BALANCE of sound between the left and right speakers as indicated by the on-screen display. To increase the relative sound level in the Left (L) speaker, press ADJUST (ADJ) Left. To increase the relative sound level in the Right (R) speaker, press ADJUST (ADJ) Right.

---

## AUDIO

Use ADJUST (ADJ) Left/Right to select the audio desired. You may choose either STEREO, MONO or 2ND AUDIO/SAP. If current mode selection is not being received, the status display shows NOT AVAILABLE. If STEREO is selected but not received, the following line appears at the bottom of the menu:

THIS PROGRAM IS NOT IN STEREO

If 2ND AUDIO/SAP is selected but not received the following line appears at the bottom of the menu:

THIS PROGRAM HAS NO 2ND AUDIO

In either of these cases, the Channel/Time display will always show what type of AUDIO signal is being heard (chosen or selected by default.)

(See next page for additional information.)

# AUDIO MENU

## AUDIO SELECTION CONSIDERATIONS

The last line of the Channel/Time display shows the current audio heard. The display is shown each time you turn the TV ON, change channels, or press ENTER. The audio heard depends on the following:

- AUDIO mode selected on AUDIO Menu: STEREO, MONO or 2ND AUDIO/SAP.
- Audio signal received.

**NOTE:** Your AUDIO mode selection can override the type of audio heard. For example, if you select MONO, you will always hear monaural sound even if the signal received is stereo.

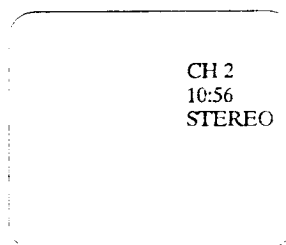

STEREO is selected using the AUDIO option on the AUDIO Menu and a stereo signal is received. You will hear stereo sound. The Channel/Time display will show STEREO.

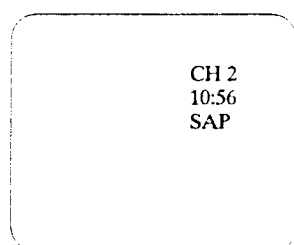

2ND AUDIO/SAP is selected using the AUDIO option on the AUDIO Menu and an SAP signal is received. You will hear the SAP audio. The Channel/Time display will show SAP.

If an SAP signal is not received, you will hear whatever type of signal is being received. The channel Time display will show the type of signal being received.

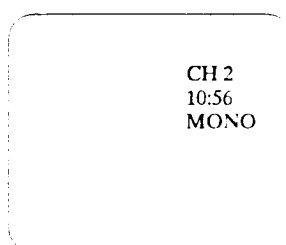

MONO is selected using the AUDIO option on the AUDIO Menu and a stereo signal is received. You will hear monaural sound. The Channel/Time display will show MONO.

**Audio Heard With Various AUDIO Modes Selected**

AUDIO Selected	Signal Received	Audio Heard
STEREO	Stereo Stereo and SAP Monaural and SAP Monaural	Stereo Stereo Monaural Monaural
MONO	Stereo Stereo and SAP Monaural and SAP Monaural	Monaural Monaural Monaural Monaural
2ND AUDIO/SAP	Stereo Stereo and SAP Monaural and SAP Monaural	Stereo 2nd Audio 2nd Audio Monaural

For AUX channel source, the signal being received is assumed to be stereo.

# VIDEO MENU

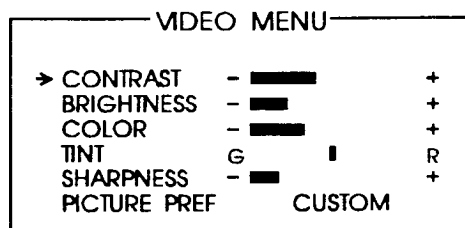

**NOTE:** All adjustments on the VIDEO Menu are optional. You do not have to use these features in order to use your TV.

## CONTRAST

Adjusts the overall contrast and color level of the picture.

If the light areas in the picture are overly bright and some of the highlight details are missing, press ADJUST (ADJ) Left until the highlights are restored.

If the picture is grayish and lacks contrast and sparkle, press ADJUST (ADJ) Right until you reach the CONTRAST level you prefer.

## BRIGHTNESS

Adjusts the brightness level of black areas in the picture.

If the black areas are too light, press ADJUST (ADJ) Left until you reach the BRIGHTNESS level you prefer.

If the black areas in the picture are too dark and show little detail, press ADJUST (ADJ) Right until you reach the BRIGHTNESS level you prefer.

## COLOR

Adjusts the intensity of the colors in the picture.

If all the colors seem too vivid or intense, press ADJUST (ADJ) Left to decrease the COLOR intensity.

If all the colors seem faded or washed out, press ADJUST (ADJ) Right to increase the COLOR intensity.

## TINT

Adjusts the color of the flesh tones.

If the flesh tones are too red or purple, press ADJUST (ADJ) Left until you reach the desired flesh tones.

If the flesh tones are green or have a greenish TINT, press ADJUST (ADJ) Right until you reach the desired flesh tones.

## SHARPNESS

Adjusts the clarity for the clearest picture.

If the picture is too "grainy" and vertical edges show multiple lines on the right side, press ADJUST (ADJ) Left to obtain the desired SHARPNESS.

If the picture is too "soft" and vertical edges are fuzzy, press ADJUST (ADJ) Right to increase the SHARPNESS.

## PICTURE PREF. (Preference)

Lets you decide if you want to use your own CUSTOM video settings, or the factory PRESET video settings.

Press ADJUST (ADJ) Left/Right to obtain the desired setting.

If the factory PRESET setting is selected, any adjustment made to the VIDEO Menu options automatically changes the PICTURE PREF. setting to CUSTOM, and saves your current video settings in the CUSTOM mode.

---

# MAINTENANCE AND TROUBLESHOOTING

---

## CARING FOR YOUR TV

Your TV will look better, have a longer life and perform better if you care for it properly.



First check to see that the TV is off. For added safety, unplug the TV from the power outlet.

### Picture Glass Cleaning

The picture tube face attracts dust particles and should be cleaned regularly. To clean the face, spray a small amount of glass cleaner on a cleaning cloth and wipe the picture tube glass face until clean. Repeat if necessary.

To delay new dust accumulation, wet a soft cloth in lukewarm water in which a little fabric softener or Ivory dishwashing detergent has been mixed. Wring the cloth almost dry. Wipe the glass face. Make sure no drops of moisture are squeezed onto the glass. Do not wipe the glass dry. Allow the glass to air-dry before you turn the TV on again.

### Cabinet Care

Non-Wood Cabinet or Cabinet Components.

Moisten a soft cloth with a mild soap solution or Ivory dishwashing detergent. Wipe the surface with a damp cloth. Then rinse the cloth in clean water and wipe the surface again. Allow the TV to air-dry before turning it on.

Wood Cabinets or Cabinet Components.

Use any good furniture cleaner and polish. Regular care will help preserve the finish.

---

## EXTENDED ABSENCE

Before an extended absence (such as a vacation) you may want to unplug the power cord from the electrical wall outlet. This will protect the TV from possible damage from lightning or power line surges. If you have an outdoor antenna, you may also want to disconnect the antenna lead-in wires on the back of the TV.

**NOTE:** If you unplug your TV, you will have to reset the clock to the current time.

---

## TV PICTURE INTERFERENCE

Your TV picture may be affected by interference caused by one or a number of factors. These include:

**Nearby Automobile Ignition, Electrical Appliances, etc.**

Which causes a speckled, streaked picture. This is most noticeable in weak signal areas.

**Snow in Picture** Caused by insufficient signal. Usually caused by the TV being located too far from the TV station or by an improper antenna installation.

**Ghosts or Reflections** Caused by signals being reflected from surrounding buildings, water tanks, or other high structures.

**Radio Signal** Police, amateur or CB radio transmitters may cause interference.

These interference problems can often be corrected through the use of a better antenna, signal amplifiers, or various filter devices. See your TV dealer for additional information, and available TV accessories.

---

# MAINTENANCE AND TROUBLESHOOTING

---

## BEFORE CALLING FOR SERVICE

Check these items and see if you can correct the trouble by changing the adjustment of a control or the setting of a switch.

By making these simple checks before calling for service, you may save time and money.

---

### Problem

### Try This

---

Picture OK. Poor sound.

Re-orient antenna. Check for local interference. Try another channel – possible station trouble. Check AUTO FINE TUNE and TUNING BAND Menu options.

Sound OK. Poor picture.

Re-orient antenna. Adjust VIDEO Menu options with PICTURE PREF. in CUSTOM mode. Try another channel – possible station trouble.

No picture or sound.

Is TV on? Is there power in wall outlet? Is TV plugged in? Is antenna hooked up? Is cable hooked up? Check with your cable company. Check auxiliary audio/video equipment. Check channel selection. Check TUNING BAND and AUTO FINE TUNE Menu options.

Picture blurred, ghost in picture, or distorted.

Check antenna or cable hook up for broken wires. Possible station trouble – try another channel. Check for local interference.

No color, or poor color.

Check antenna or cable hook up. Adjust VIDEO Menu options with PICTURE PREF. in the CUSTOM mode. Is it a color program?

No sound.

Check VOLUME (VOL) setting. Check MUTE button operation on remote control, if provided.

Cannot select certain channels.

Channels may be skipped in CH. ADD/DEL Menu option. Check TUNING BAND and AUTO FINE TUNE Menu options.

Remote control does not work.

Are batteries okay? Is TV turned ON? Is TV plugged in? Is remote in the TV mode?

No picture or sound when AUX channel is selected.

VCR hooked up properly? Are wires connected to AUX INPUT AUDIO RIGHT and LEFT jacks on the connection center?

No closed captions.

Are captions available? Is CAPTION 1 or CAPTION 2 selected using the CAPTIONS option on the SETUP Menu.

Black box covers most of screen.

Is TEXT 1 or TEXT 2 selected using the CAPTIONS option on the SETUP Menu? Text information may not be available.

---

Always request that your technician use only genuine Zenith exact replacement parts for continued Quality and Safety performance. Keep your Zenith ALL Zenith.

**NOTE:** If your TV fails to respond to the PICTURE PREF. selection, or to any other menu selection, you must reset the TV. Simply disconnect it from AC power by unplugging the AC power cord from the power outlet. Wait a few minutes, then plug the TV back into the power outlet. You will have to reset the clock to the current time.

# MAINTENANCE AND TROUBLESHOOTING

## VCR MODE CHART 1. OUTPUT TO TV FROM ANTENNA OUT JACK ON VCR

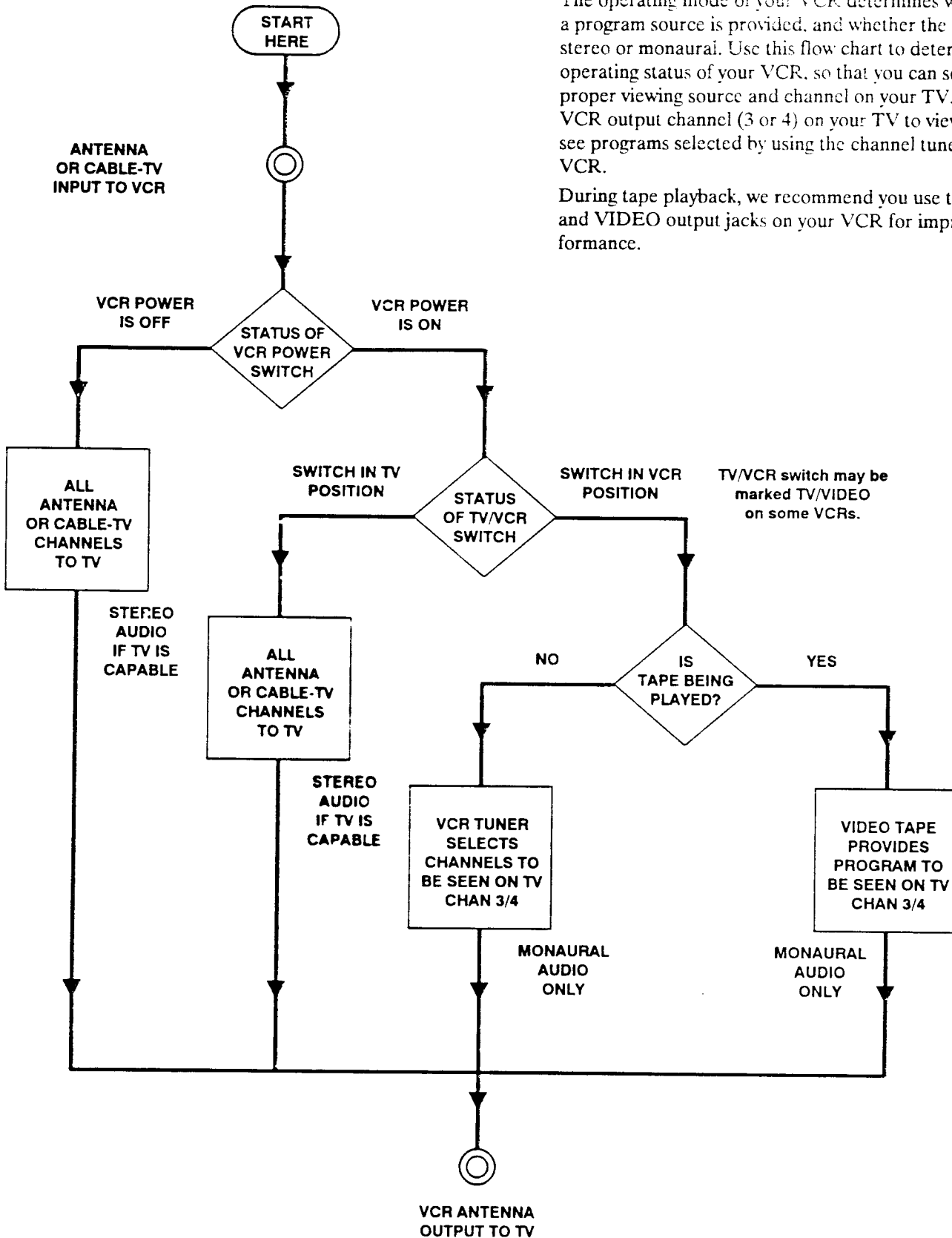

The operating mode of your VCR determines what type of a program source is provided, and whether the audio is stereo or monaural. Use this flow chart to determine the operating status of your VCR, so that you can select the proper viewing source and channel on your TV. Select the VCR output channel (3 or 4) on your TV to view tapes or to see programs selected by using the channel tuner in the VCR.

During tape playback, we recommend you use the AUDIO and VIDEO output jacks on your VCR for improved performance.

# MAINTENANCE AND TROUBLESHOOTING

## VCR MODE CHART 2. OUTPUT TO TV FROM AUDIO/VIDEO JACKS ON VCR

The operating mode of your VCR determines what type of program source is provided, and whether the audio is stereo or monaural. Use this flow chart to determine the operating status of your VCR, so that you know when to select the VCR (or auxiliary) source on your TV.

Use the LEFT and RIGHT AUDIO output jacks on the VCR to get stereo sound. Select STEREO audio mode of operation for the TV by using the options on the AUDIO Menu of the TV. You must use the VIDEO output when the LEFT and RIGHT AUDIO outputs are used.

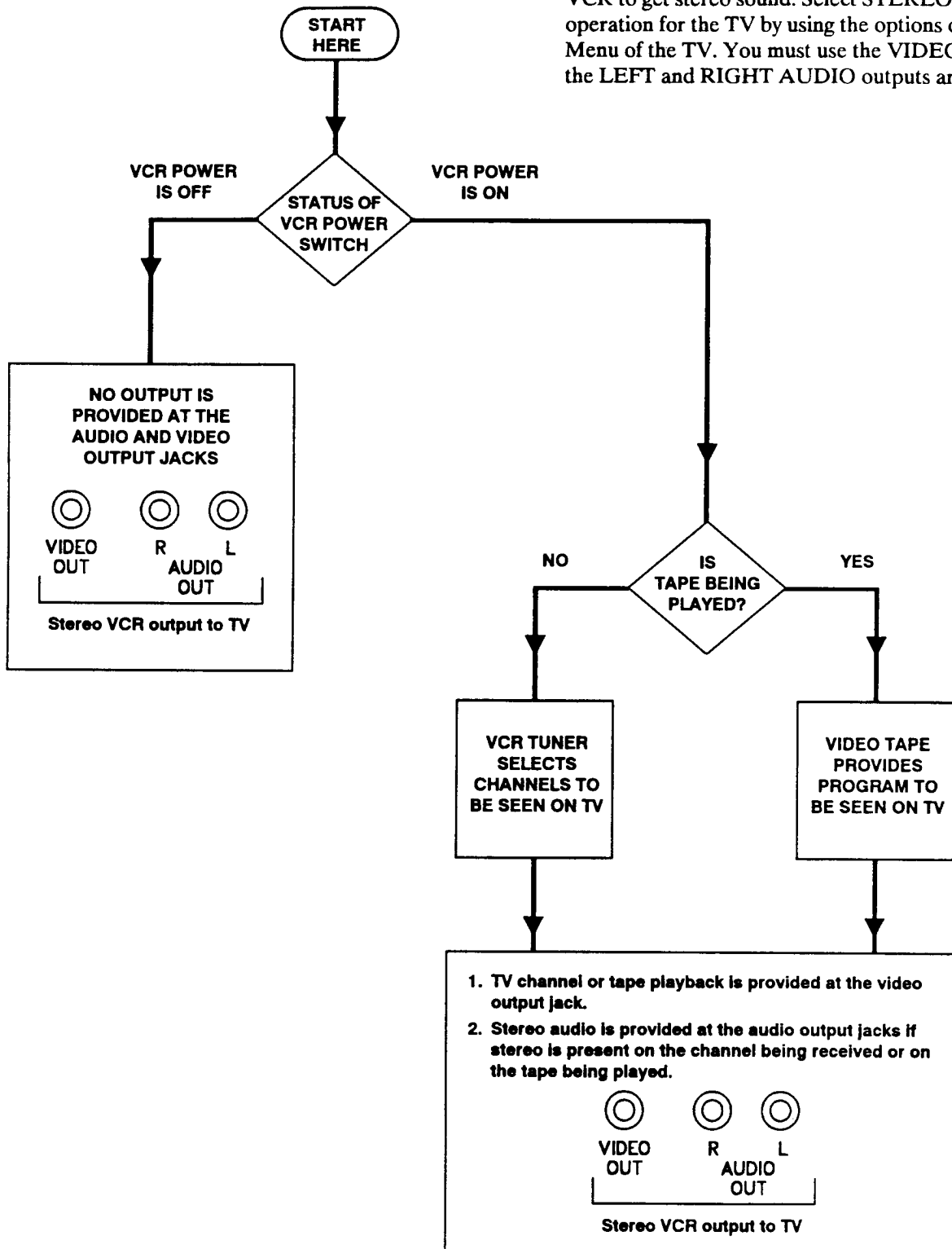



---

# YOUR ZENITH WARRANTY

---

## Consumer Protection Plan for Zenith TV

Welcome into the Zenith family! We believe that you will be pleased with your new Zenith Color TV. Please read this Consumer Protection Plan carefully. It is a "LIMITED WARRANTY" as defined under Federal Law. This warranty gives you specific legal rights, and you may also have other rights that vary from state to state within the U.S.A.

### Zenith's Responsibility

**Service Labor** — During a period of 90 days from effective warranty date, Zenith will pay for service labor by a U.S. or Canadian distributor-approved Zenith service center when needed as a result of manufacturing defects.

**Parts** — New or remanufactured replacements for factory-defective parts will be supplied by a U.S. or Canadian distributor-approved service center for one year from effective warranty date (color picture tube — two years). Such replacement parts are warranted for the remaining portion of the original warranty period.

**Home Service** — Warranty service for 19" diagonal (U.S.A.) or larger screen size models is provided in the home.

**Not Covered** — This warranty covers manufacturing defects and does not cover installation, adjustment of customer controls in the home, installation or repair of home antenna systems, cable converters or cable company-supplied equipment; it also does not cover damage due to misuse, abuse, negligence, acts of God or other causes beyond the control of Zenith. Any alteration of the product after manufacture voids this warranty in its entirety.

### Owner's Responsibility

**Effective Warranty Date** — Warranty begins on the date of original consumer installation. For your convenience, keep the dealers dated bill of sale or delivery ticket as evidence of the purchase date.

**Operating Guide** — Read your Operating Guide carefully so that you will understand the operation of your set and how to adjust the customer controls.

**Carry-In Service** — Models under 19" diagonal (U.S.A.) screen size must be taken to a distributor-approved Zenith service center for warranty service and must be picked up by the owner.

**Antenna** — Reception problems caused by inadequate home antennas or faulty antenna connections are the owner's responsibility.

**Important: Product Registration** — Please fill out and mail your Product Registration Card. It is imperative that Zenith know how to reach you promptly if we should discover a safety problem that could affect you.

**Warranty Service** — For warranty service information, contact your Zenith dealer preferably, or any distributor-approved Zenith service center. Parts and service labor that are Zenith's responsibility (see above) will be provided without charge. Other service is at the owner's expense. If you have any problem in obtaining satisfactory warranty service, write:

**Zenith Electronics Corporation**  
Customer Service Department  
1900 N. Austin Avenue  
Chicago, Illinois 60639-5079  
Telephone: (312) 745-5152  
Mon-Fri, 8:00 a.m. - 4:30 p.m. Central Time

**NOTE:** Before you ask for Warranty service, check the Operating Guide section entitled, "MAIN-TENANCE AND TROUBLESHOOTING." It may be possible to avoid a service call.

ZENITH ELECTRONICS CORPORATION  
1000 MILWAUKEE AVENUE  
GLENVIEW, ILLINOIS 60025

Part No. 206-2589  
Printed in U.S.A.  
EP-EDCB

---